

PROJ. REFERENCE NO.	SHEET NO.
R-5021	TMP-136

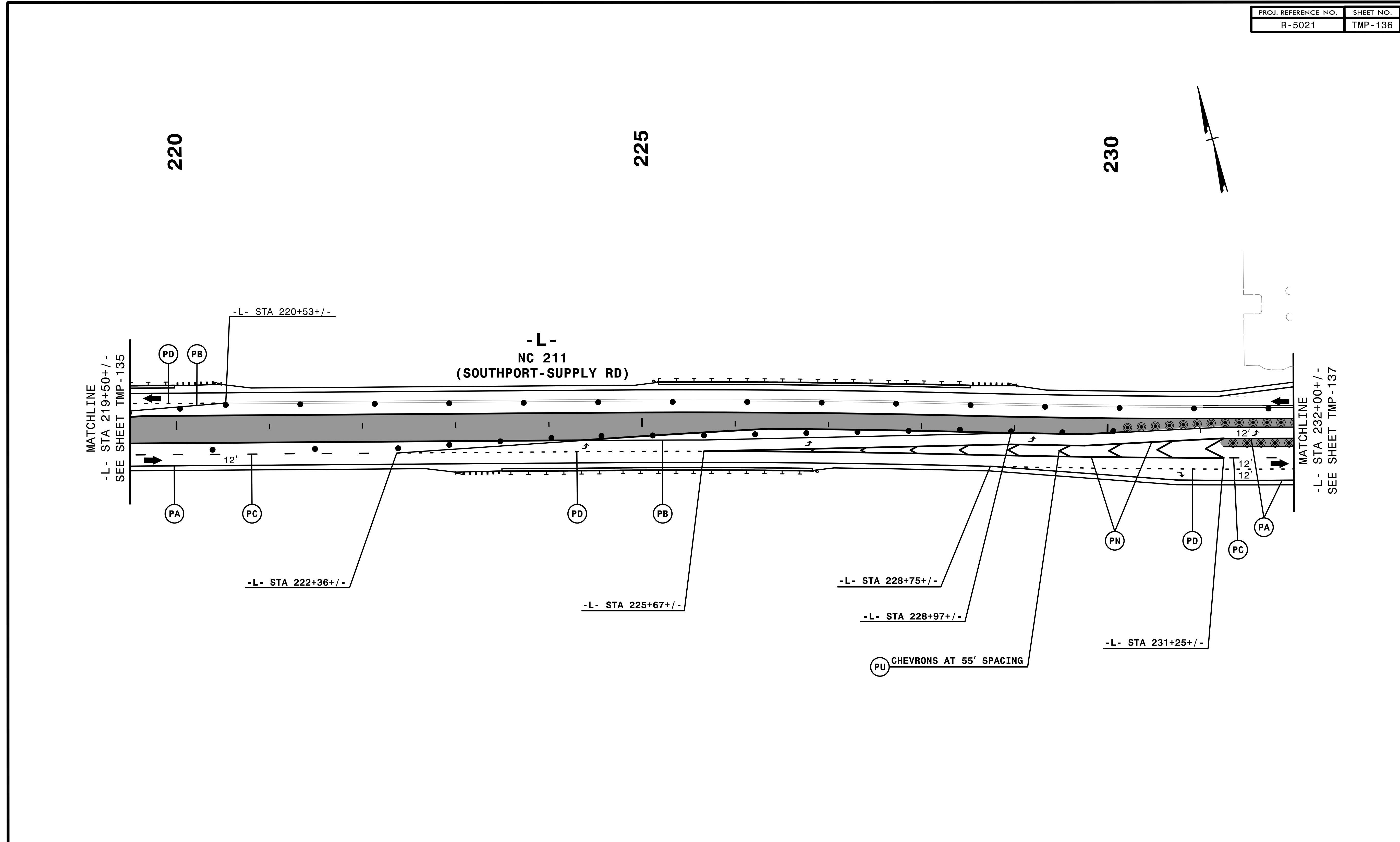

- REMOVE CONFLICTING PAVEMENT MARKING.
- INSTALL APPLICABLE PERMANENT SIGNS.

2/6/2019
 T:\CP\5021\TC-p3.dwg
 HNTB

HNTB HNTB NORTH CAROLINA, P.C.
 343 E. Six Forks Road, Suite 200
 Raleigh, North Carolina 27609
 NC License No: C-1554

APPROVED: *Helen Skyy*
 DATE: 2/6/2019
 SEAL
 PROFESSIONAL SEAL
 ENGINEER
 HELEN SKYY

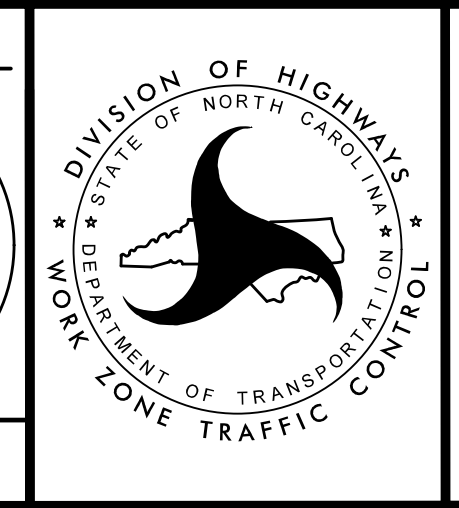

TRANSPORTATION
 MANAGEMENT PLAN
 PHASE III
 DETAIL

**DOCUMENT NOT CONSIDERED FINAL
 UNLESS ALL SIGNATURES COMPLETED**

PROJ. REFERENCE NO.	SHEET NO.
R-5021	TMP-137

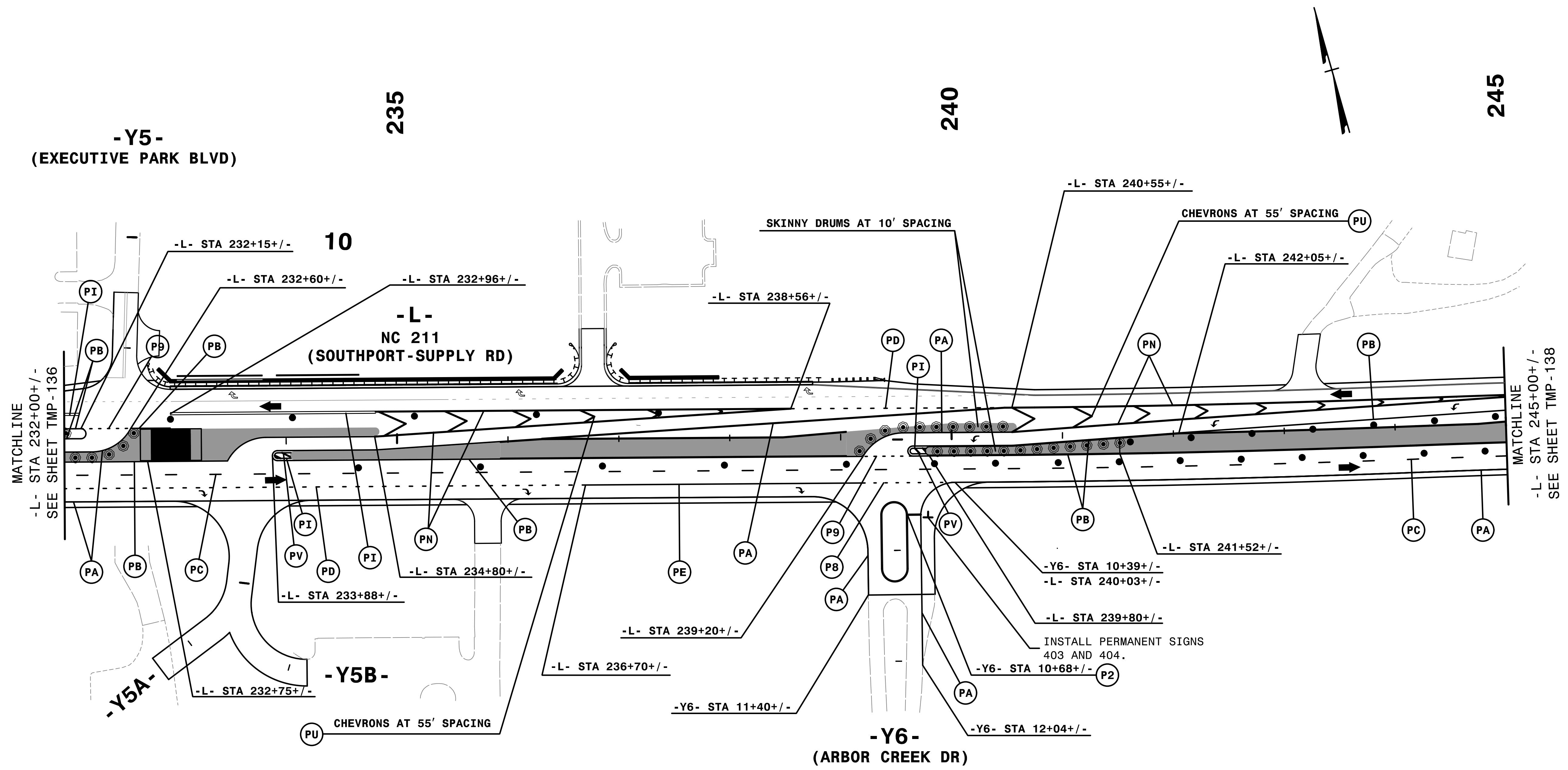

MATCHLINE
-L- STA 232+00+/-
SEE SHEET TMP-136

MATCHLINE
-L- STA 245+00+/-
SEE SHEET TMP-138

- REMOVE CONFLICTING PAVEMENT MARKING.
- INSTALL APPLICABLE PERMANENT SIGNS.

HNTB
 HNTB NORTH CAROLINA, P.C.
 343 E. Six Forks Road, Suite 200
 Raleigh, North Carolina 27609
 NC License No: C-1554

APPROVED: *Helen Shyu*
 DATE: 9/9/2021
 SEAL
 DOCUMENT NOT CONSIDERED FINAL
 UNLESS ALL SIGNATURES COMPLETED

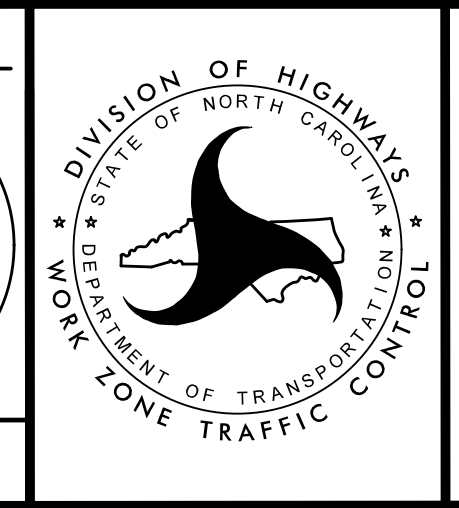

TRANSPORTATION
 MANAGEMENT PLAN
 PHASE III
 DETAIL

11:50:33 AM
 ...\\TCR...5021_to_p3cell.dgn
 \$\$\$USERNAME\$\$\$

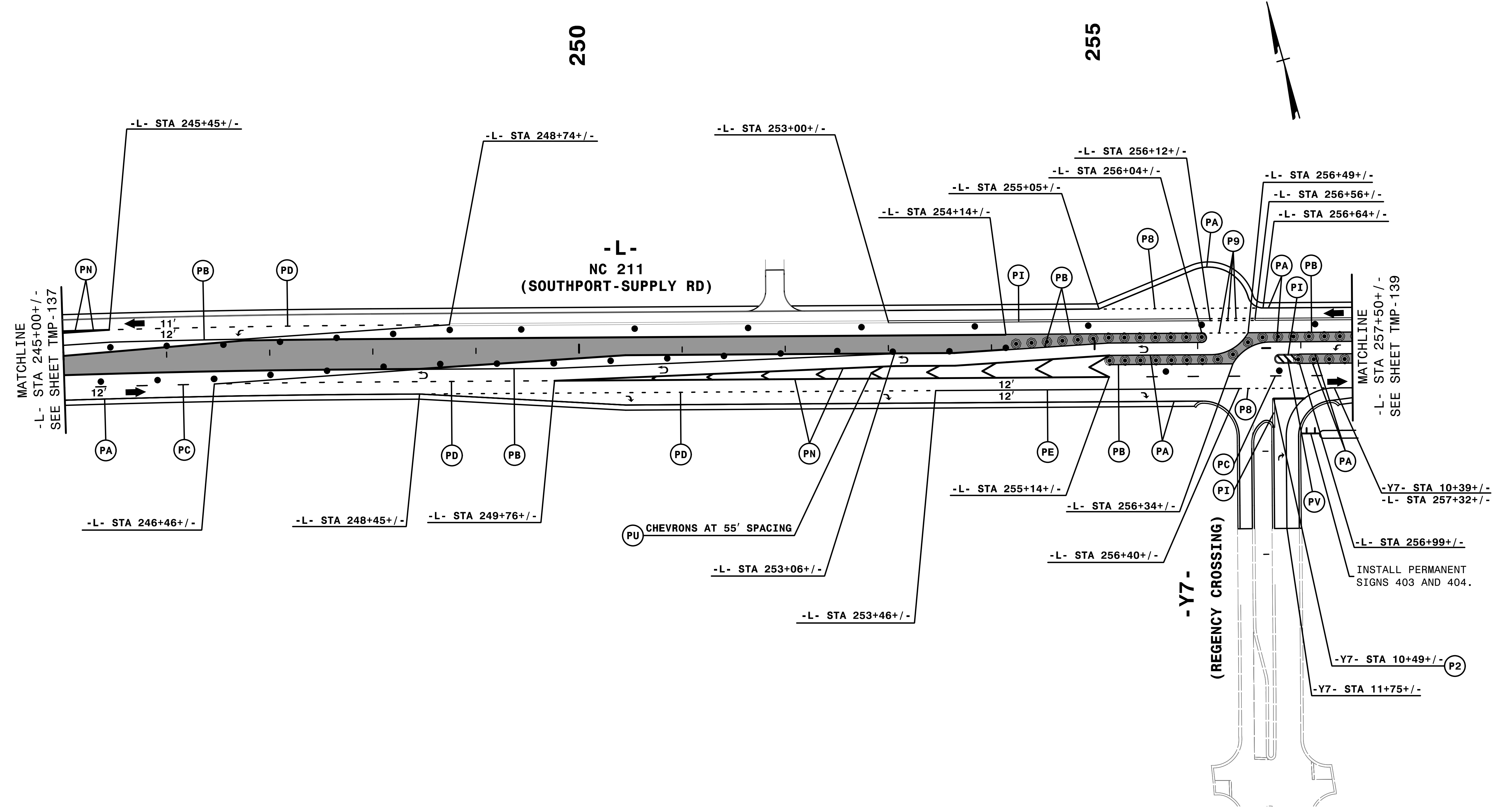

REMOVE CONFLICTING PAVEMENT MARKING.

INSTALL APPLICABLE PERMANENT SIGNS.

4:55:39 PM
 \\TCFV\F5021\TC_P3.dwg
 \$\$\$USERNAME\$\$\$

HNTB HNTB NORTH CAROLINA, P.C.
 343 E. Six Forks Road, Suite 200
 Raleigh, North Carolina 27609
 NC License No: C-1554

APPROVED: *Helen Shyu*
 DATE: 9/9/2021
 SEAL
 DOCUMENT NOT CONSIDERED FINAL
 UNLESS ALL SIGNATURES COMPLETED

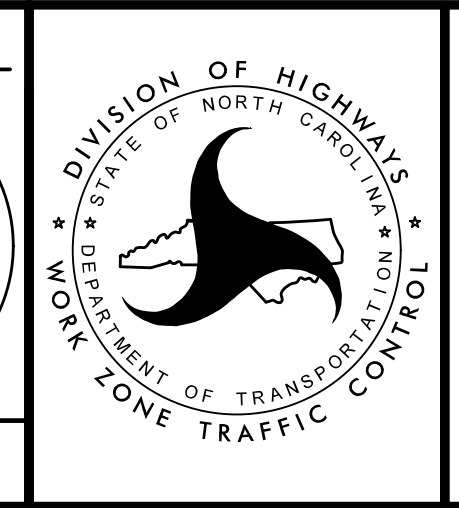

TRANSPORTATION
 MANAGEMENT PLAN
 PHASE III
 DETAIL

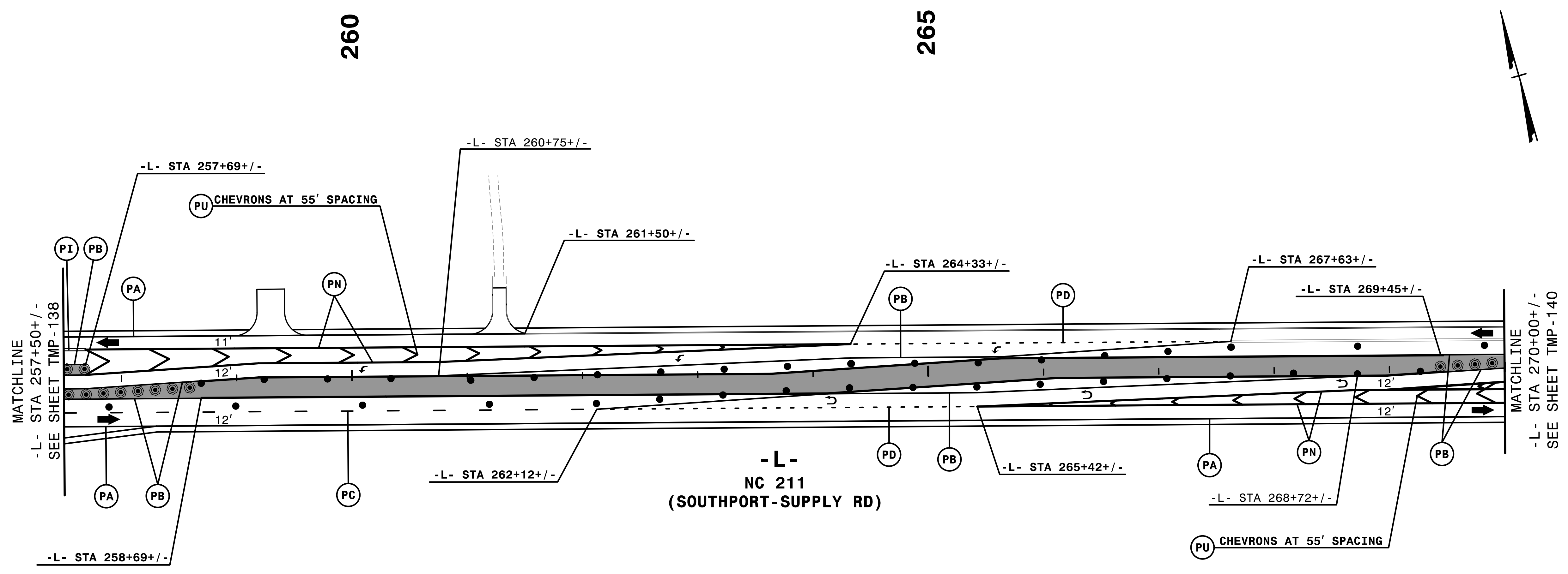

MATCHLINE
-L- STA 257+50+/-
SEE SHEET TMP-138

MATCHLINE
-L- STA 270+00+/-
SEE SHEET TMP-140

-L-
NC 211
(SOUTHPORT-SUPPLY RD)

2/6/2019
HNTB
C:\CP\5021\c-p3d13.dgn

- REMOVE CONFLICTING PAVEMENT MARKING.
- INSTALL APPLICABLE PERMANENT SIGNS.



APPROVED: *Helen Skyy*
DATE: 2/6/2019

SEAL

DOCUMENT NOT CONSIDERED FINAL
UNLESS ALL SIGNATURES COMPLETED

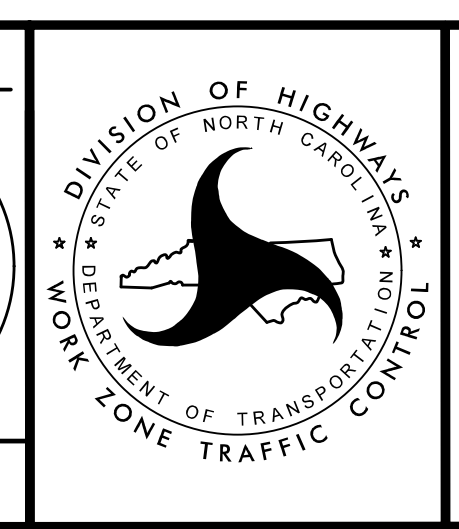

TRANSPORTATION
MANAGEMENT PLAN

PHASE III
DETAIL

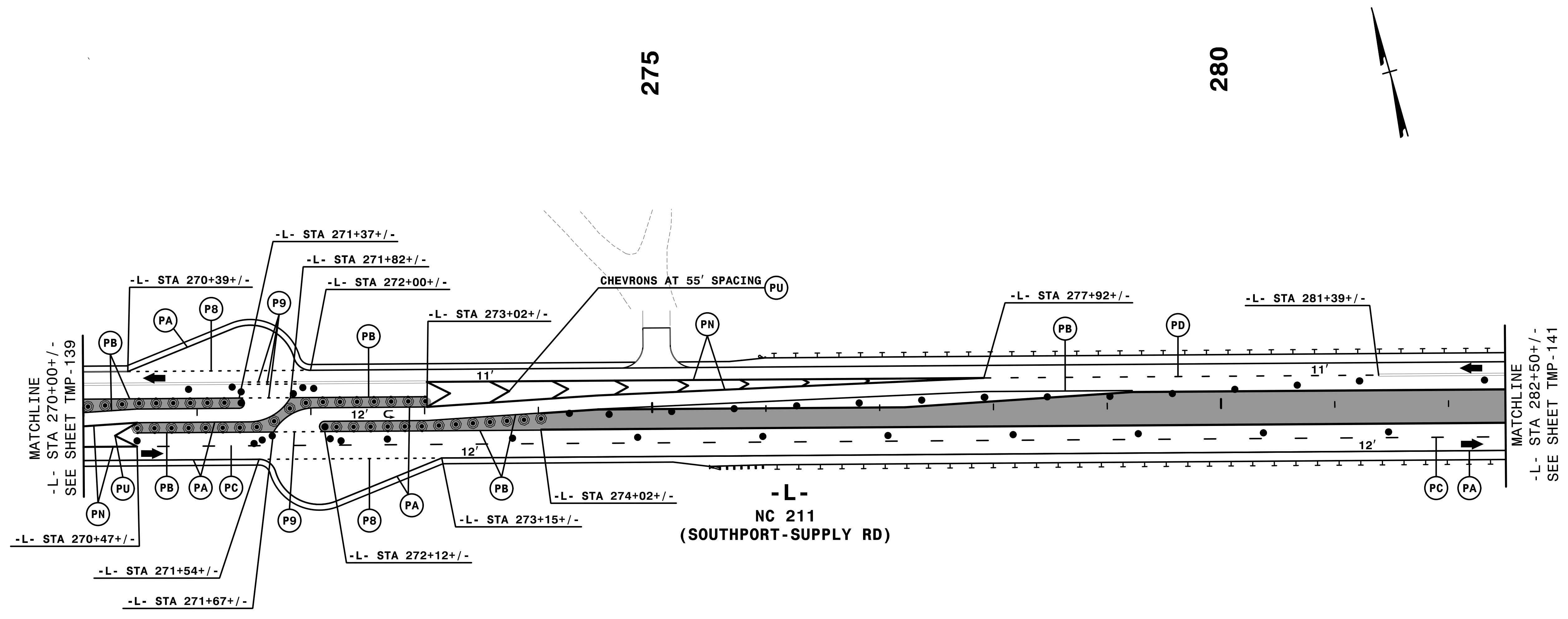

275

280

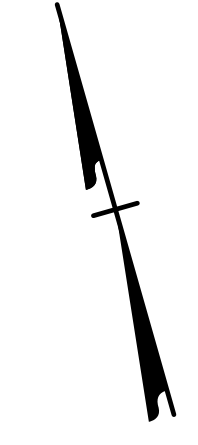

MATCHLINE
-L- STA 270+00+/-
SEE SHEET TMP-139

MATCHLINE
-L- STA 282+50+/-
SEE SHEET TMP-141

-L-
NC 211
(SOUTHPORT-SUPPLY RD)

11:50:37 AM
...\\TC\p\5021_fc_p3.dwg
\$\$\$\$\$USERNAME\$\$\$\$\$

REMOVE CONFLICTING PAVEMENT MARKING.
INSTALL APPLICABLE PERMANENT SIGNS.

HNTB
HNTB NORTH CAROLINA, P.C.
343 E. Six Forks Road, Suite 200
Raleigh, North Carolina 27609
NC License No: C-1554

APPROVED: *Helen Shyu*
DATE: 9/9/2021
SEAL
DOCUMENT NOT CONSIDERED FINAL
UNLESS ALL SIGNATURES COMPLETED

TRANSPORTATION
MANAGEMENT PLAN

PHASE III
DETAIL

PROJ. REFERENCE NO.	SHEET NO.
R-5021	TMP-141

①

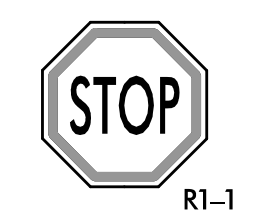

285

290

295

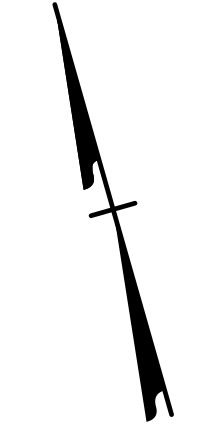

-L-
NC 211
(SOUTHPORT-SUPPLY RD)

MATCHLINE
-L- STA 282+50+/-
SEE SHEET TMP-140

MATCHLINE
-L- STA 296+00+/-
SEE SHEET TMP-142

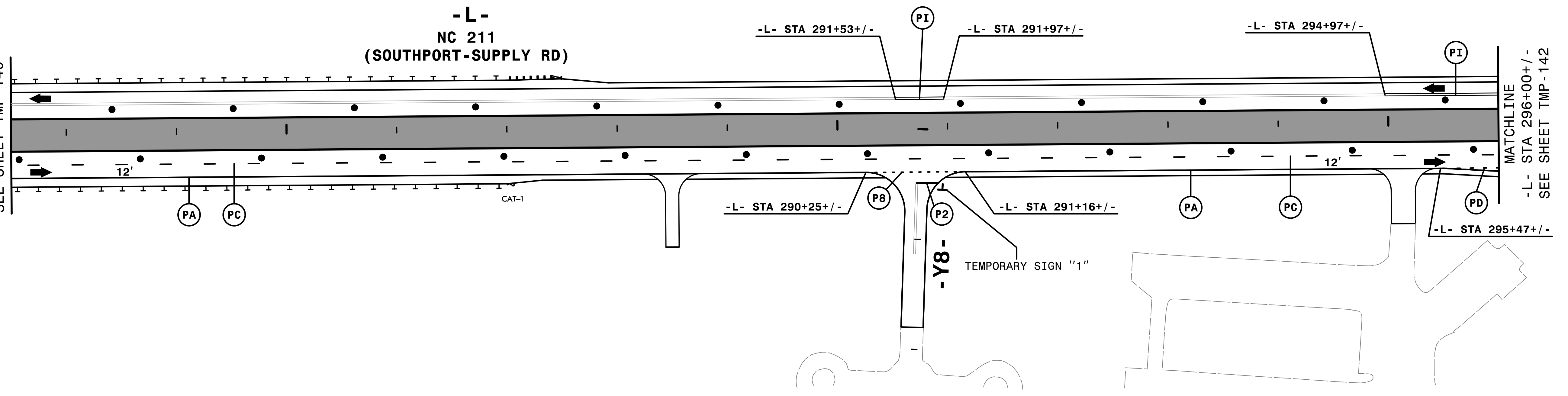

- REMOVE CONFLICTING PAVEMENT MARKING.
- INSTALL APPLICABLE PERMANENT SIGNS.

HNTB HNTB NORTH CAROLINA, P.C.
343 E. Six Forks Road, Suite 200
Raleigh, North Carolina 27609
NC License No: C-1554

APPROVED: *Helen Shyu*
DATE: 9/9/2021
SEAL
DOCUMENT NOT CONSIDERED FINAL
UNLESS ALL SIGNATURES COMPLETED

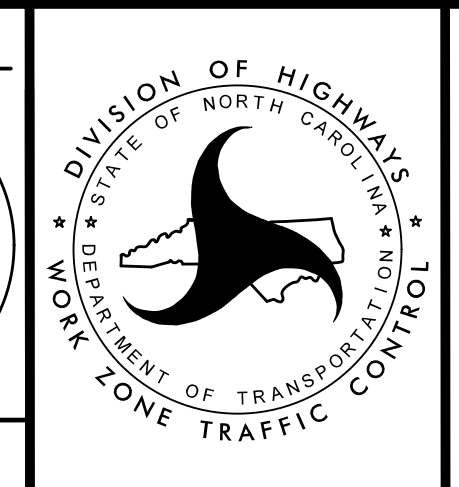

DIVISION OF HIGHWAYS
STATE OF NORTH CAROLINA
DEPARTMENT OF TRANSPORTATION
WORK ZONE TRAFFIC CONTROL

TRANSPORTATION
MANAGEMENT PLAN
PHASE III
DETAIL

4:55:43 PM
...N:\CP...5021...to_p3.dwg
\$\$\$\$\$USERNAME\$\$\$\$\$

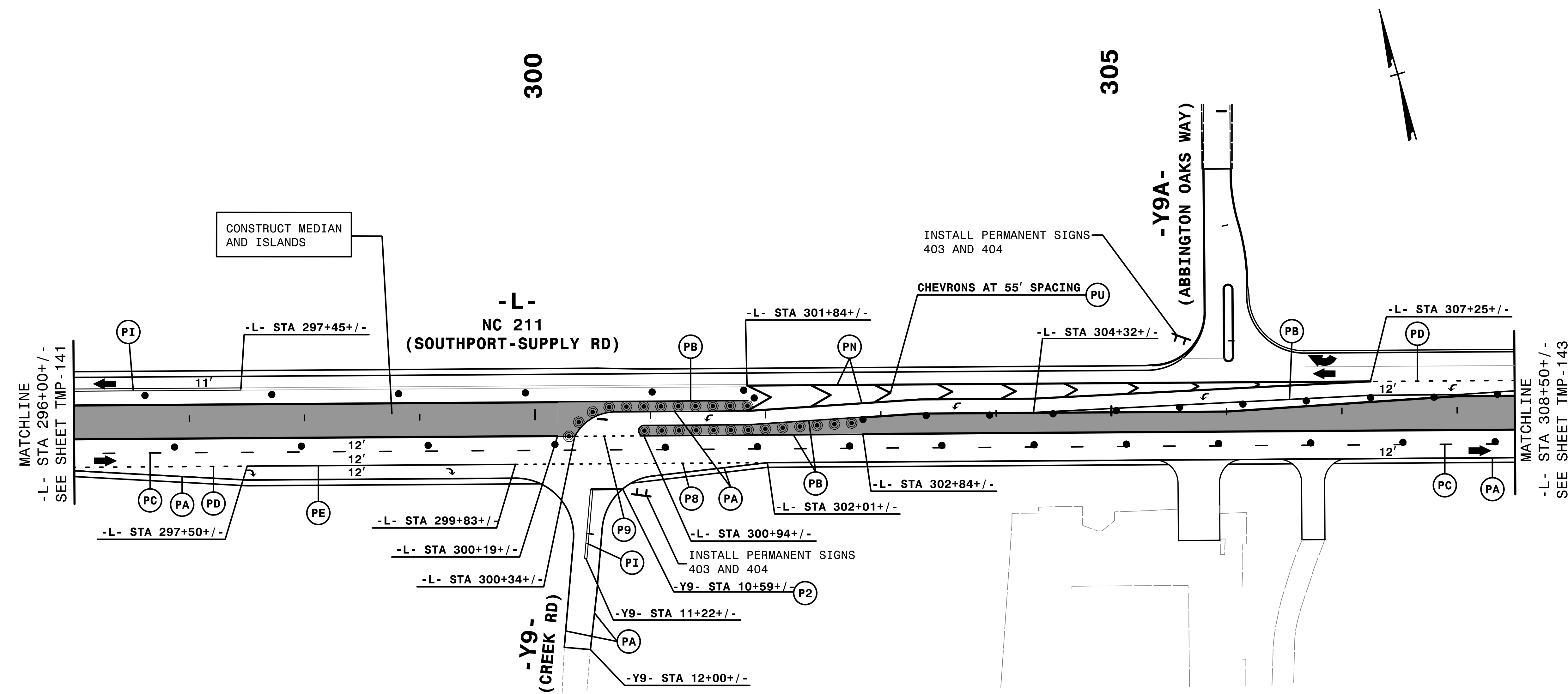

2:31:00 PM
 \\TCFV\5021\TC_P3.dwg
 \$\$\$USERNAME\$\$\$

REMOVE CONFLICTING PAVEMENT MARKING.
 INSTALL APPLICABLE PERMANENT SIGNS.

HNTB HNTB NORTH CAROLINA, P.C.
 343 E. Six Forks Road, Suite 200
 Raleigh, North Carolina 27609
 NC License No: C-1554

APPROVED: *Helen Shyu*
 DATE: 10/28/2021
 SEAL
 DOCUMENT NOT CONSIDERED FINAL
 UNLESS ALL SIGNATURES COMPLETED

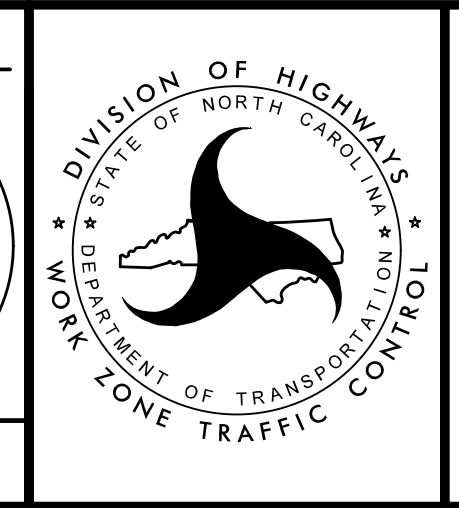

TRANSPORTATION
 MANAGEMENT PLAN
 PHASE III
 DETAIL

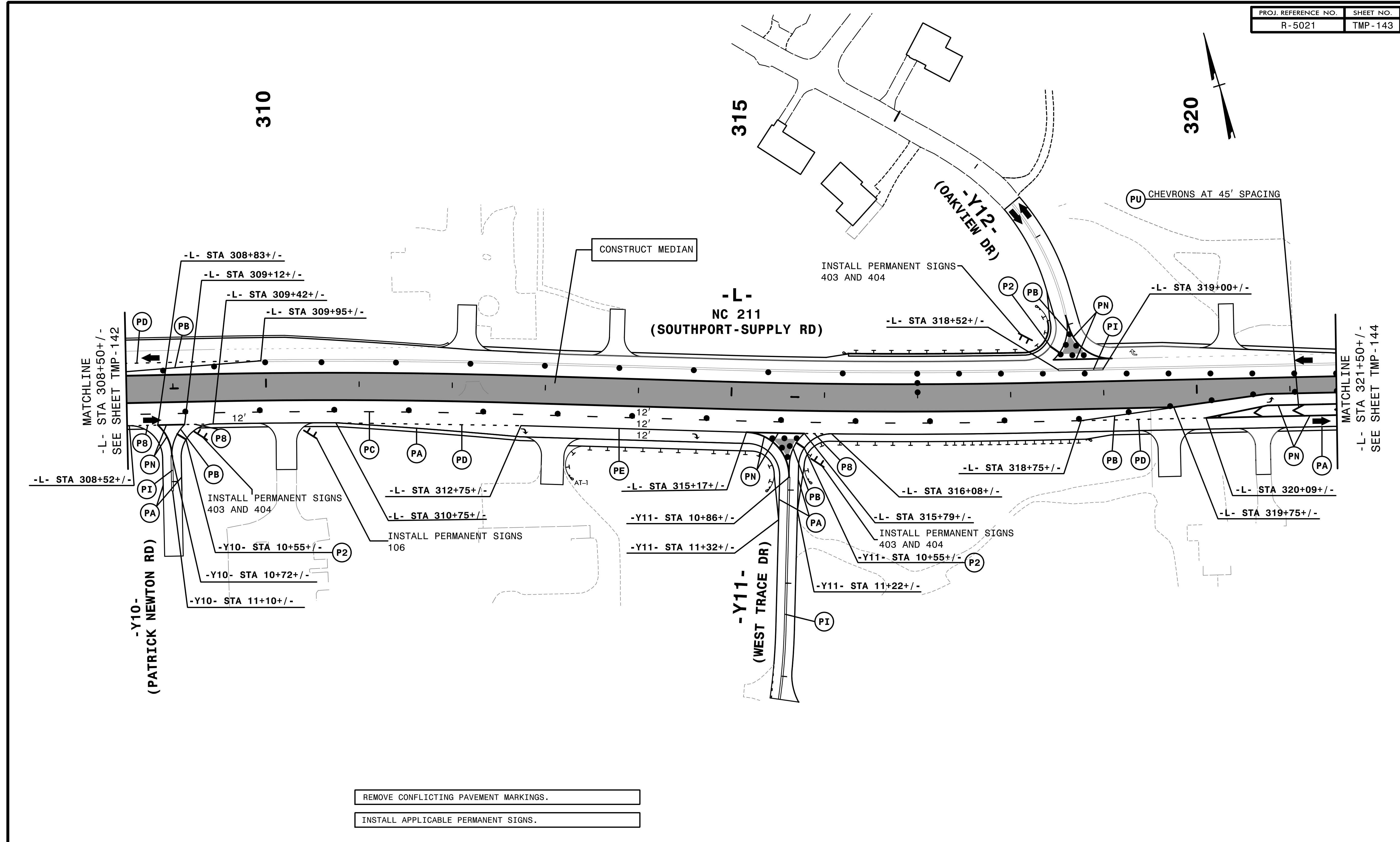

REMOVE CONFLICTING PAVEMENT MARKINGS.

INSTALL APPLICABLE PERMANENT SIGNS.

4:16:00 PM
 N:\CP\15021\10_p3.dwg
 \$\$\$USERNAME\$\$\$

HNTB HNTB NORTH CAROLINA, P.C.
 343 E. Six Forks Road, Suite 200
 Raleigh, North Carolina 27609
 NC License No: C-1554

APPROVED: *Helen Shyu*
 DATE: 10/28/2021

SEAL

PROFESSIONAL SEAL
 042517
 ENGINEER
 HELEN SHYU

DOCUMENT NOT CONSIDERED FINAL
 UNLESS ALL SIGNATURES COMPLETED

DIVISION OF HIGHWAYS
 STATE OF NORTH CAROLINA
 DEPARTMENT OF TRANSPORTATION
 WORK ZONE TRAFFIC CONTROL

TRANSPORTATION
 MANAGEMENT PLAN

PHASE III
 DETAIL

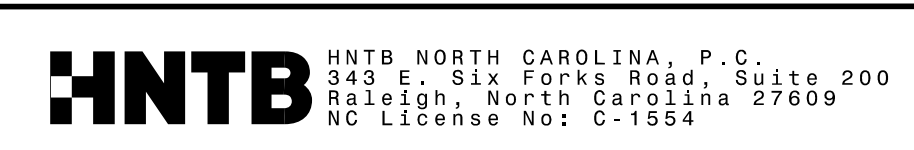
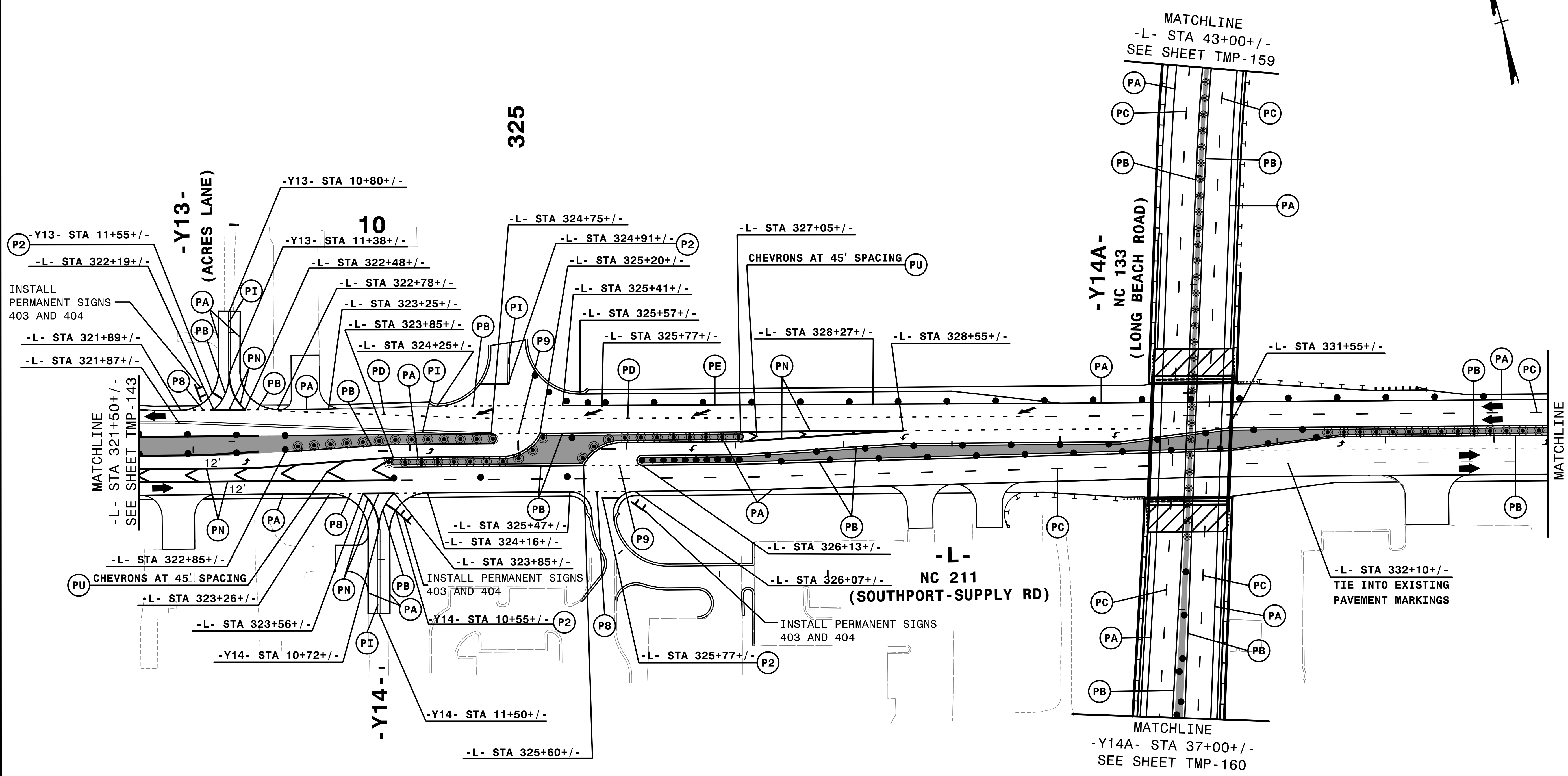
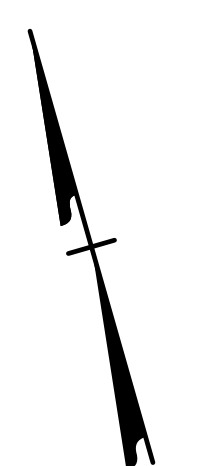

APPROVED: *Helen Shyu*
OF 19975A95E4EF

DATE: 9/9/2021

SEAL

DOCUMENT NOT CONSIDERED FINAL
UNLESS ALL SIGNATURES COMPLETED

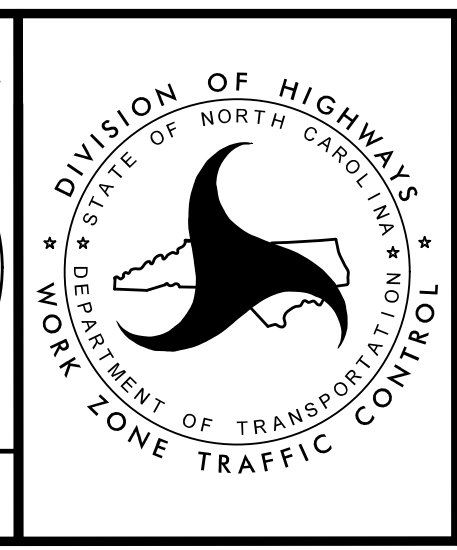

TRANSPORTATION
MANAGEMENT PLAN

PHASE III
DETAIL

4:55:50 PM
 \\TCPL\F5021\T.C.P3\d18.dgn
 \$\$\$USERNAME\$\$\$

PROJ. REFERENCE NO.	SHEET NO.
R-5021	TMP-145

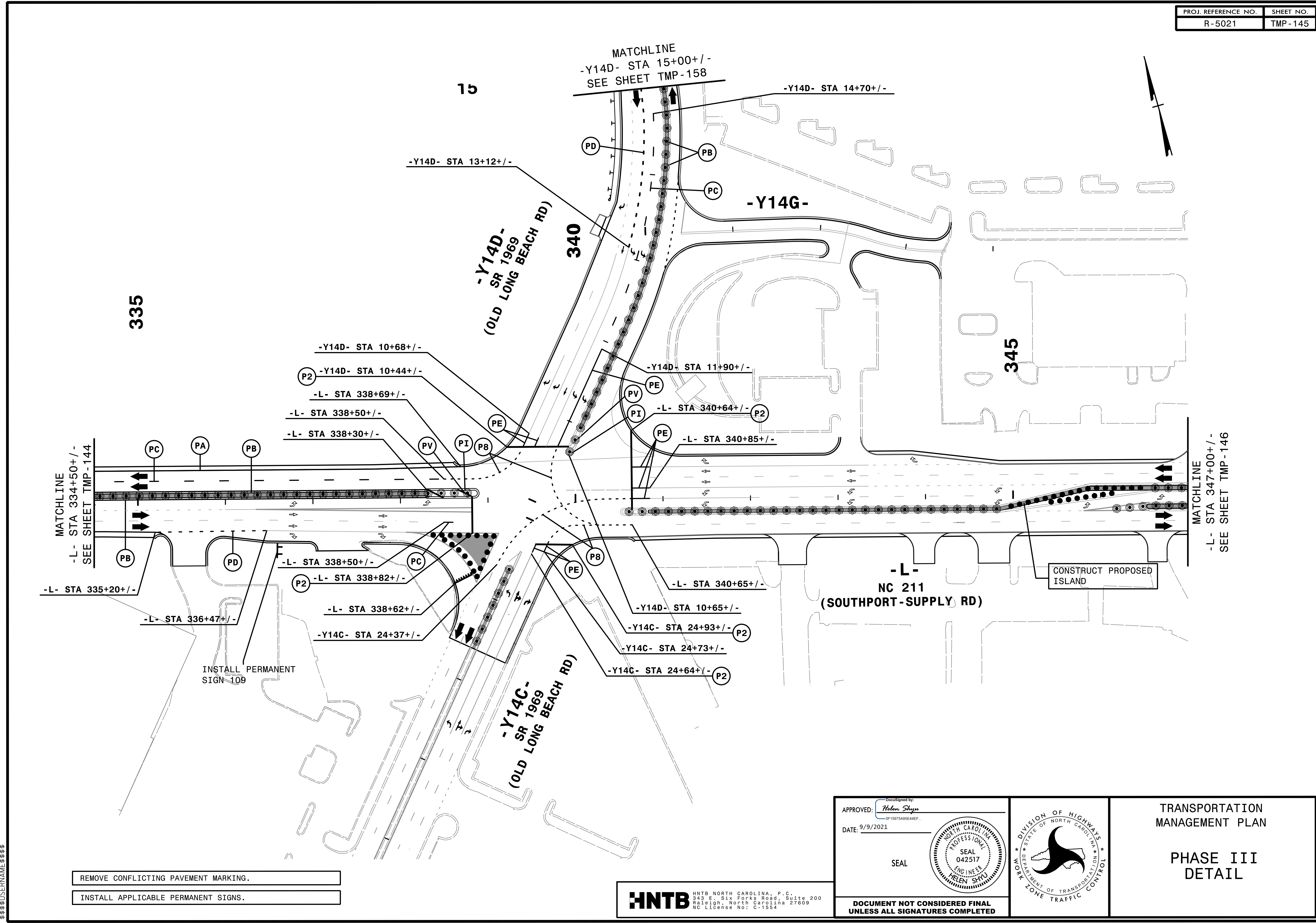

4:55:52 PM
 \\TCFV15021\c_p3d19.dgn
 \$\$\$USERNAME\$\$\$

- REMOVE CONFLICTING PAVEMENT MARKING.
- INSTALL APPLICABLE PERMANENT SIGNS.

HNTB HNTB NORTH CAROLINA, P.C.
 343 E. Six Forks Road, Suite 200
 Raleigh, North Carolina 27609
 NC License No: C-1554

APPROVED: *Helen Shyne*
 DATE: 9/9/2021
 SEAL
 DOCUMENT NOT CONSIDERED FINAL
 UNLESS ALL SIGNATURES COMPLETED

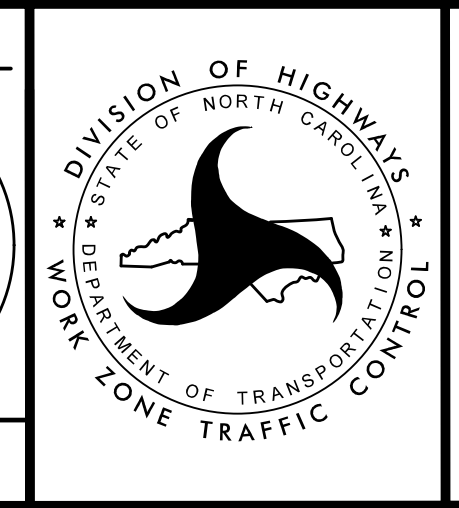

TRANSPORTATION
 MANAGEMENT PLAN
 PHASE III
 DETAIL

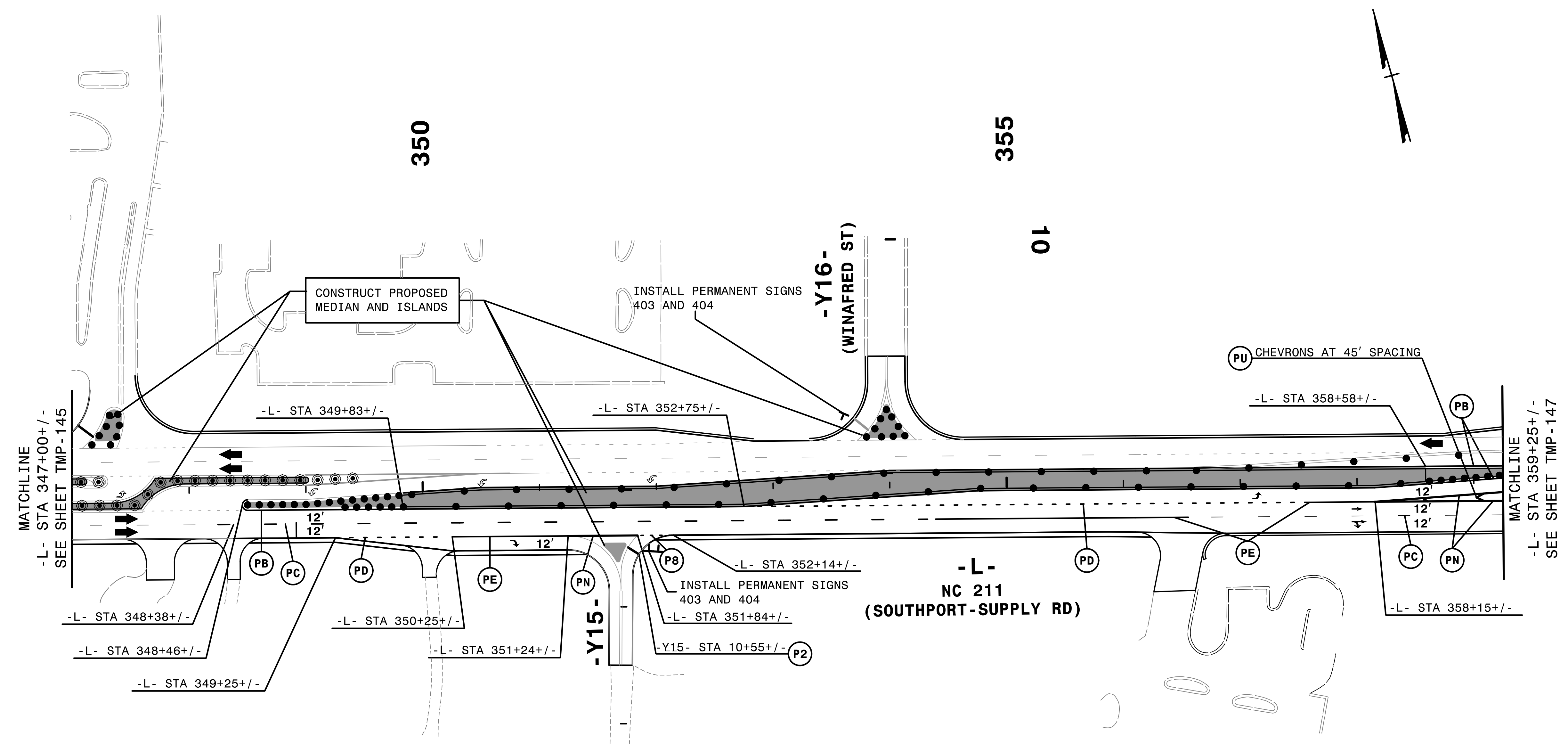

4:55:55 PM
 \\TCFV\F5021\TC_P3420.dgn
 \$\$\$USERNAME\$\$\$

- REMOVE CONFLICTING PAVEMENT MARKING.
- INSTALL APPLICABLE PERMANENT SIGNS.

HNTB HNTB NORTH CAROLINA, P.C.
 343 E. Six Forks Road, Suite 200
 Raleigh, North Carolina 27609
 NC License No: C-1554

APPROVED: *Helen Shyu*
 DATE: 9/9/2021

SEAL

DOCUMENT NOT CONSIDERED FINAL
 UNLESS ALL SIGNATURES COMPLETED

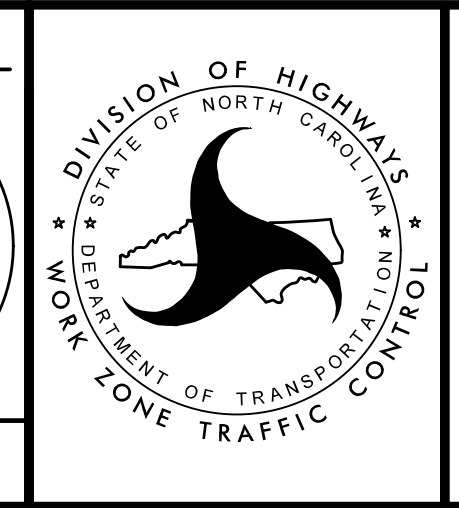

TRANSPORTATION
 MANAGEMENT PLAN

PHASE III
 DETAIL

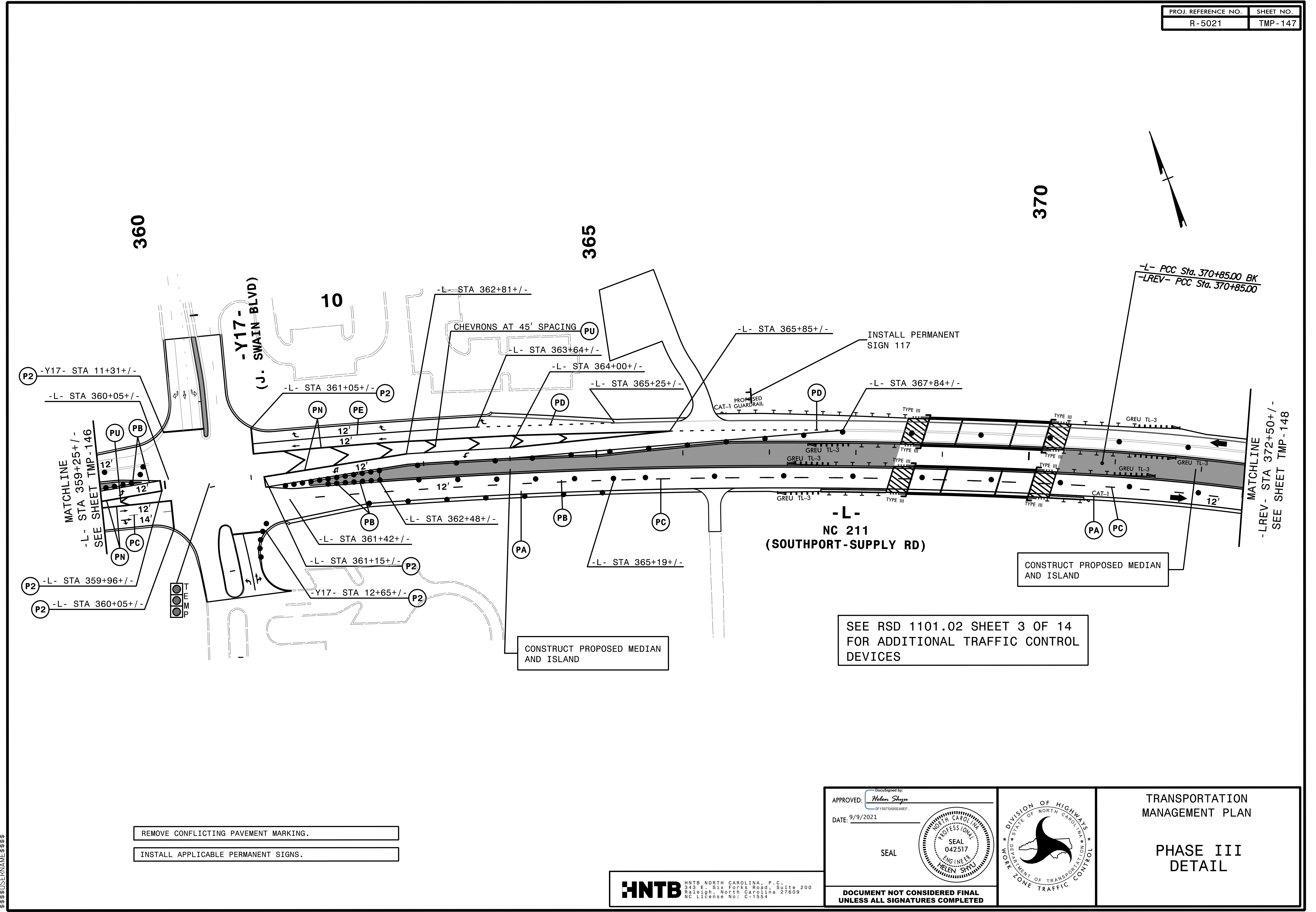

REMOVE CONFLICTING PAVEMENT MARKING.

INSTALL APPLICABLE PERMANENT SIGNS.

SEE RSD 1101.02 SHEET 3 OF 14 FOR ADDITIONAL TRAFFIC CONTROL DEVICES

4:55:57 PM
 \\TCN\F5021\TC_P3.dwg
 \$\$\$USERNAME\$\$\$

HNTB HNTB NORTH CAROLINA, P.C.
 343 E. Six Forks Road, Suite 200
 Raleigh, North Carolina 27609
 NC License No: C-1554

APPROVED: *Helen Shyu*
 DATE: 9/9/2021
 SEAL
 DOCUMENT NOT CONSIDERED FINAL UNLESS ALL SIGNATURES COMPLETED

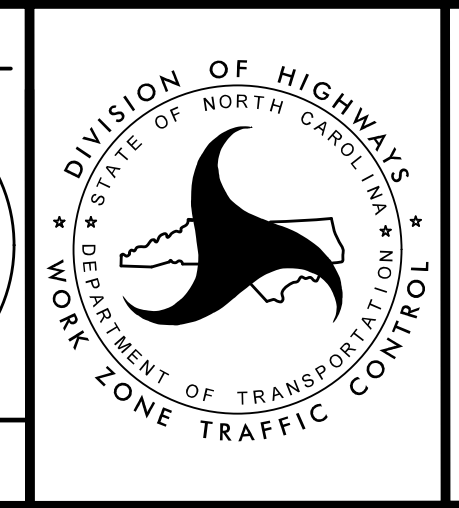

TRANSPORTATION MANAGEMENT PLAN

PHASE III DETAIL

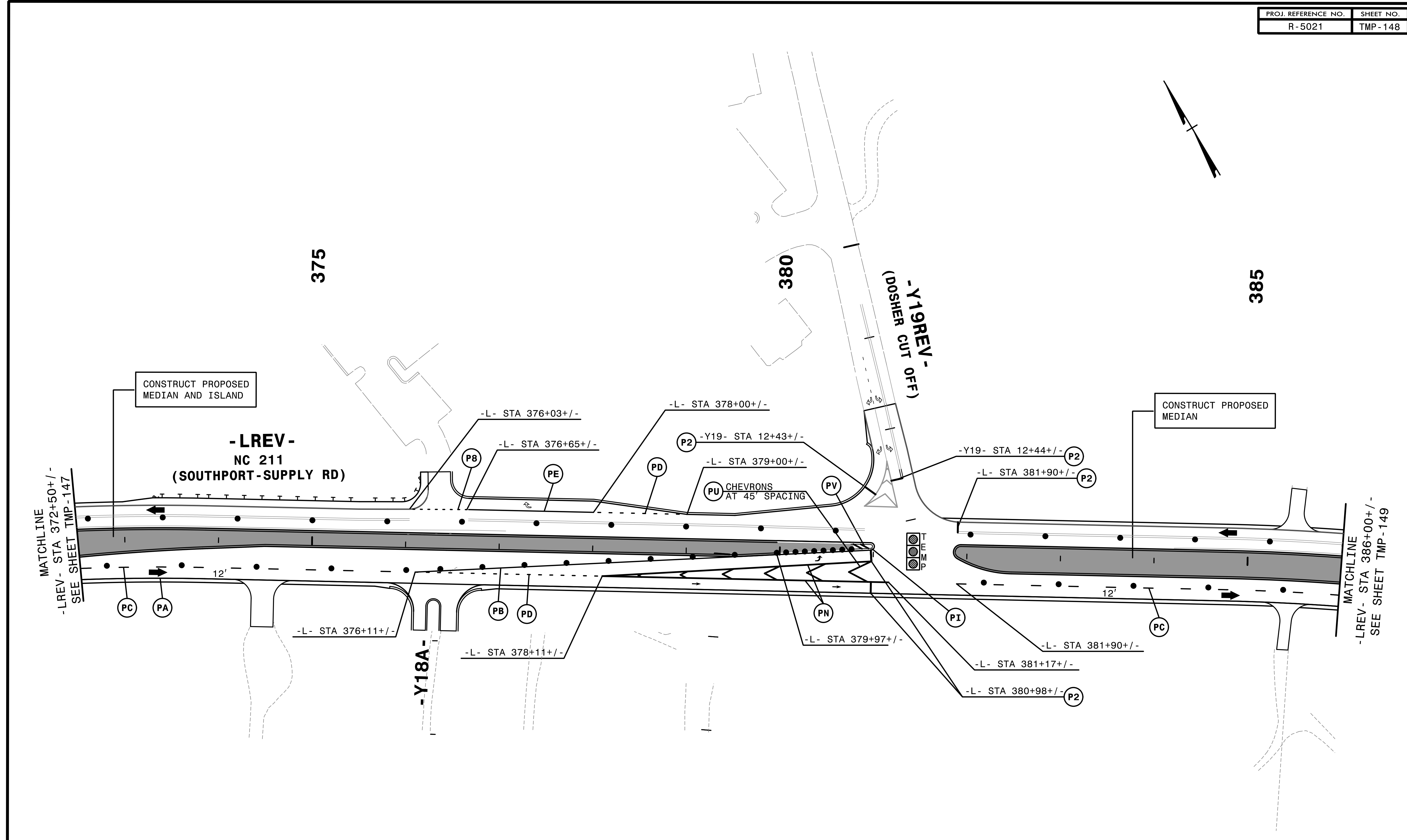

4:41:28 PM
 \\TCP\5021\c_p3422.dgn
 \$\$\$USERNAME\$\$\$

- REMOVE CONFLICTING PAVEMENT MARKING.
- INSTALL APPLICABLE PERMANENT SIGNS.

HNTB HNTB NORTH CAROLINA, P.C.
 343 E. Six Forks Road, Suite 200
 Raleigh, North Carolina 27609
 NC License No: C-1554

APPROVED: *Helen Shyu*
 DATE: 9/9/2021
 SEAL
 DOCUMENT NOT CONSIDERED FINAL
 UNLESS ALL SIGNATURES COMPLETED

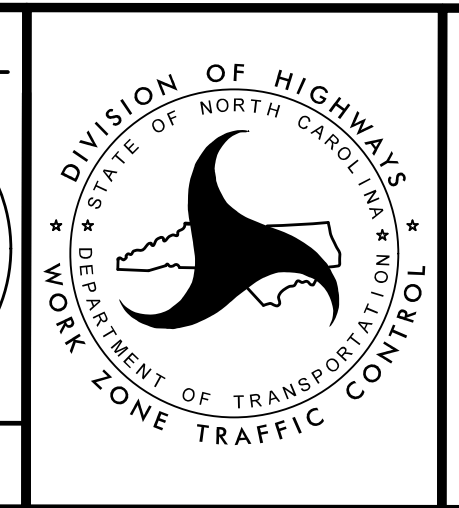

TRANSPORTATION
 MANAGEMENT PLAN
 PHASE III
 DETAIL

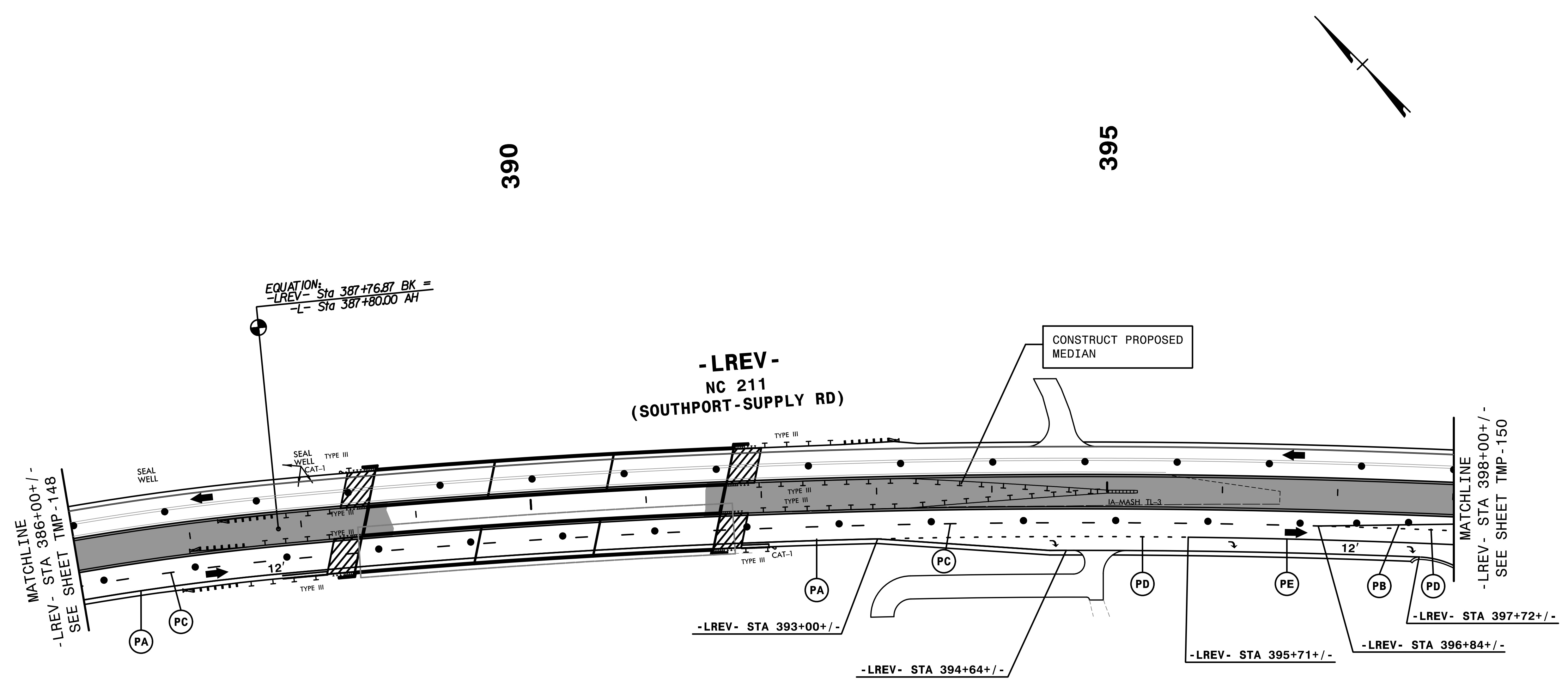

390

395

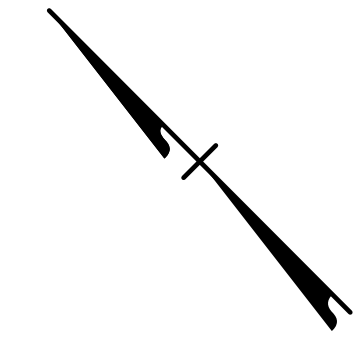

MATCHLINE
-LREV- STA 386+00+/-
SEE SHEET TMP-148

MATCHLINE
-LREV- STA 398+00+/-
SEE SHEET TMP-150

EQUATION:
-LREV- Sta 387+76.87 BK =
-L- Sta 387+80.00 AH

-LREV-
NC 211
(SOUTHPORT-SUPPLY RD)

CONSTRUCT PROPOSED
MEDIAN

-LREV- STA 393+00+/-

-LREV- STA 394+64+/-

-LREV- STA 395+71+/-

-LREV- STA 396+84+/-

-LREV- STA 397+72+/-

REMOVE CONFLICTING PAVEMENT MARKING.

INSTALL APPLICABLE PERMANENT SIGNS.

HNTB HNTB NORTH CAROLINA, P.C.
343 E. Six Forks Road, Suite 200
Raleigh, North Carolina 27609
NC License No: C-1554

APPROVED: *Helen Shyu*
DATE: 9/9/2021
SEAL
DOCUMENT NOT CONSIDERED FINAL
UNLESS ALL SIGNATURES COMPLETED

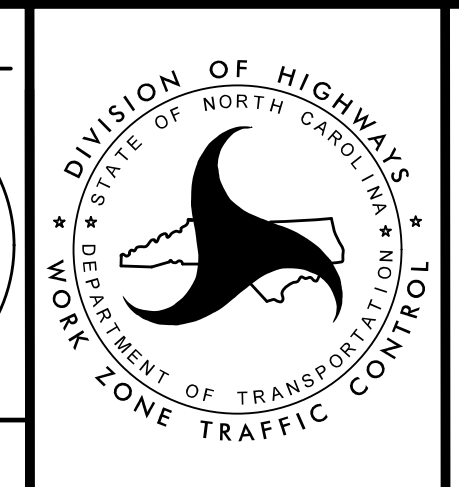

TRANSPORTATION
MANAGEMENT PLAN

PHASE III
DETAIL

4:56:01 PM
\\TCF\5021\c_p3d23.dgn
\$\$\$\$\$USERNAME\$\$\$\$\$

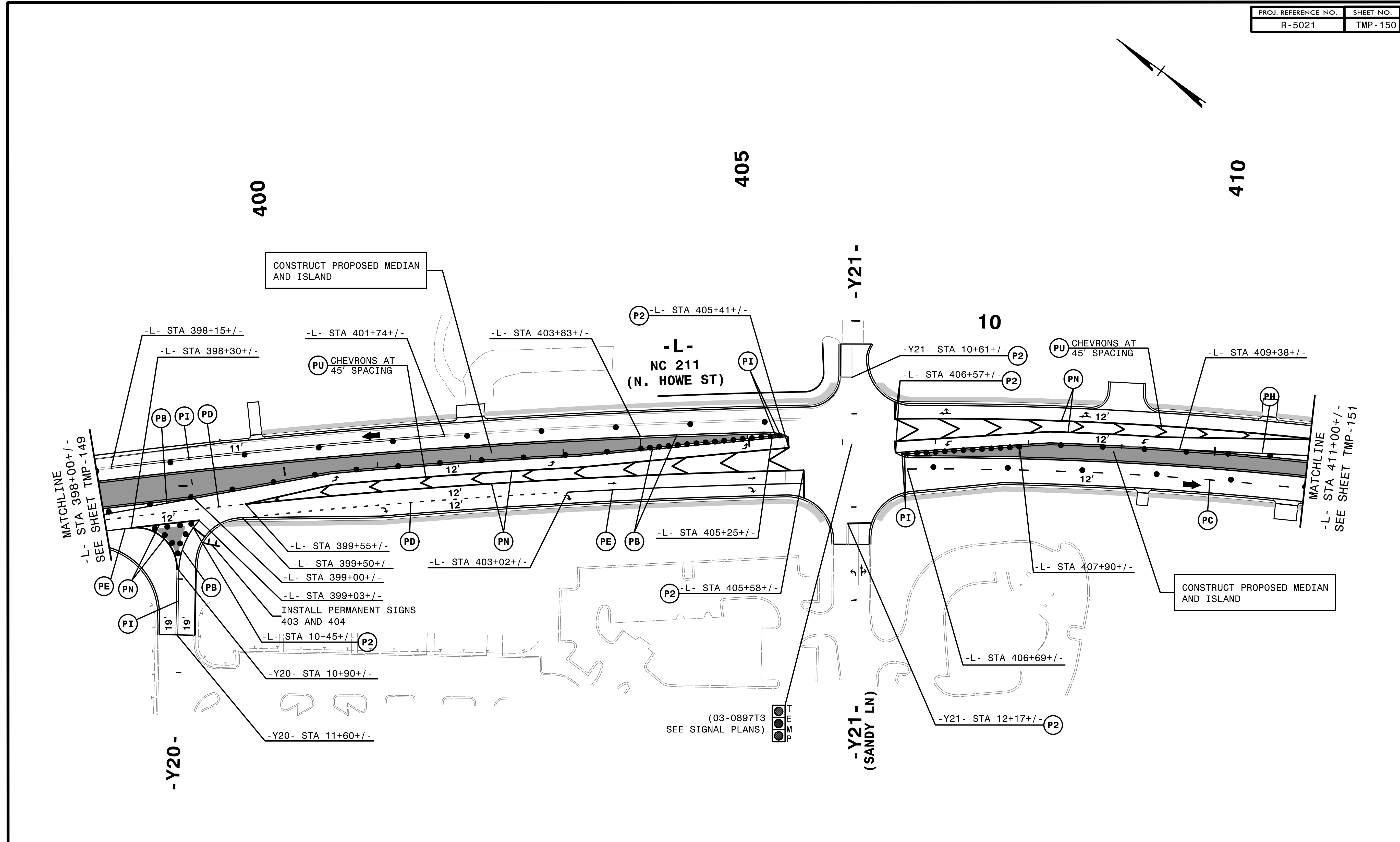

4:56:03 PM
 \\TCFV15021\c_p3d24.dgn
 \$\$\$USERNAME\$\$\$

- REMOVE CONFLICTING PAVEMENT MARKING.
- INSTALL APPLICABLE PERMANENT SIGNS.

(03-0897T3
SEE SIGNAL PLANS)

HNTB HNTB NORTH CAROLINA, P.C.
 343 E. Six Forks Road, Suite 200
 Raleigh, North Carolina 27609
 NC License No: C-1554

APPROVED: *Helen Shyu*
 DATE: 9/9/2021
 SEAL
 DOCUMENT NOT CONSIDERED FINAL
 UNLESS ALL SIGNATURES COMPLETED

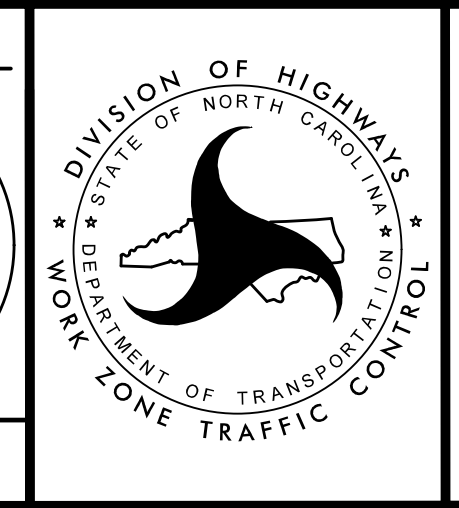

TRANSPORTATION
 MANAGEMENT PLAN
 PHASE III
 DETAIL

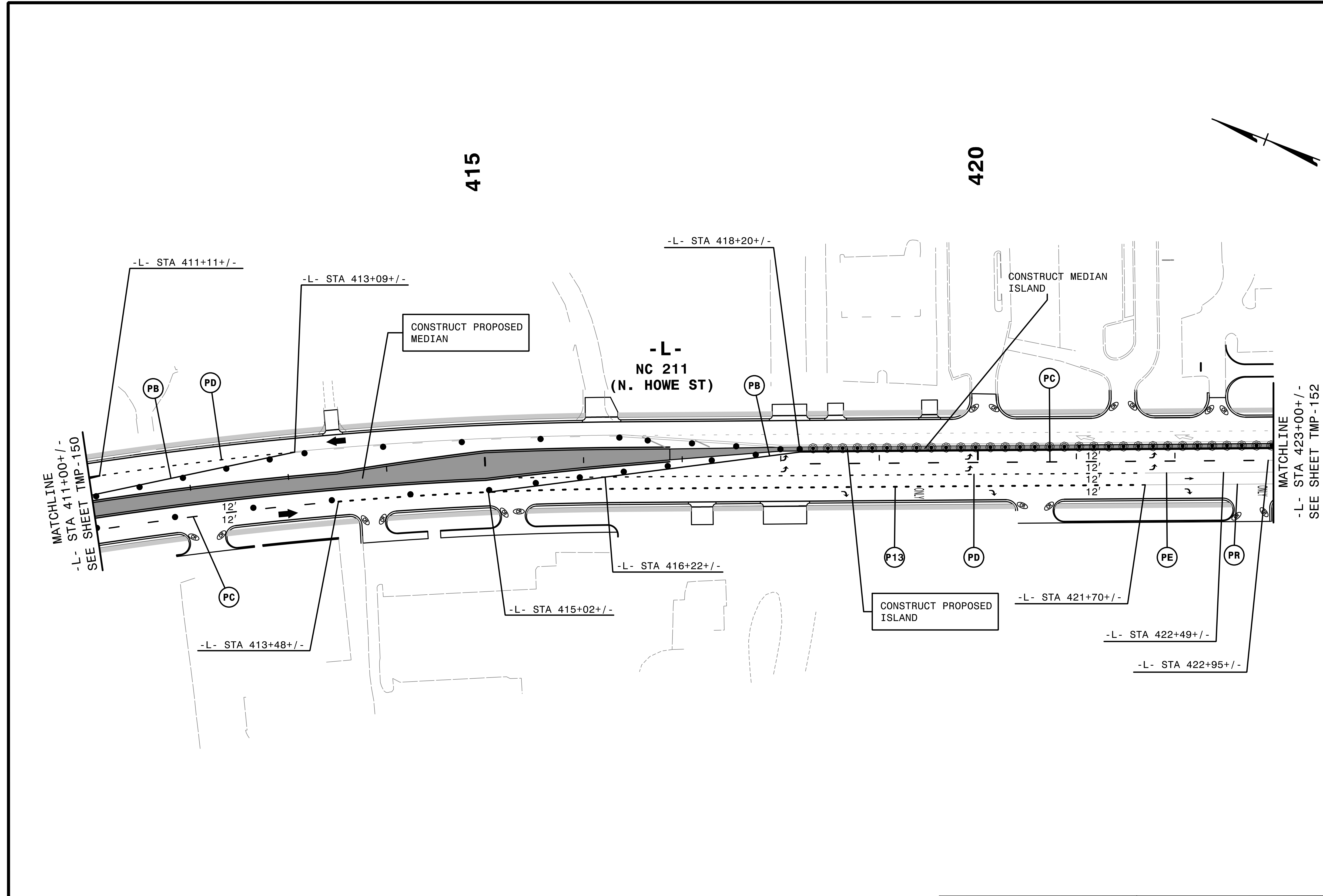

MATCHLINE
-L- STA 411+00+/-
SEE SHEET TMP-150

MATCHLINE
-L- STA 423+00+/-
SEE SHEET TMP-152

- INSTALL APPLICABLE PERMANENT SIGNS.
- REMOVE CONFLICTING PAVEMENT MARKING.

HNTB HNTB NORTH CAROLINA, P.C.
343 E. Six Forks Road, Suite 200
Raleigh, North Carolina 27609
NC License No: C-1554

APPROVED: *Helen Skyy*
DATE: 2/6/2019
SEAL
DOCUMENT NOT CONSIDERED FINAL
UNLESS ALL SIGNATURES COMPLETED

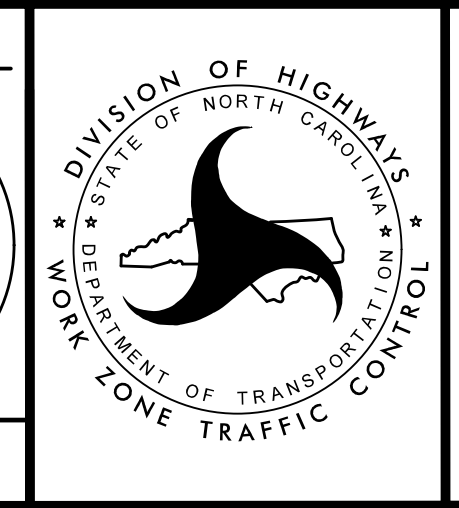

TRANSPORTATION
MANAGEMENT PLAN

PHASE III
DETAIL

2/6/2019
C:\CPV\5021\to_p3d25.dgn
HNTB

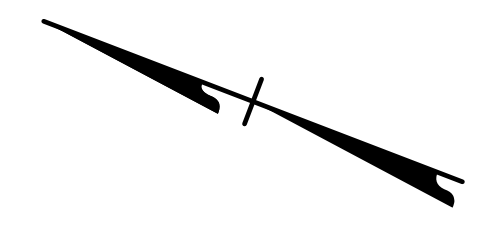
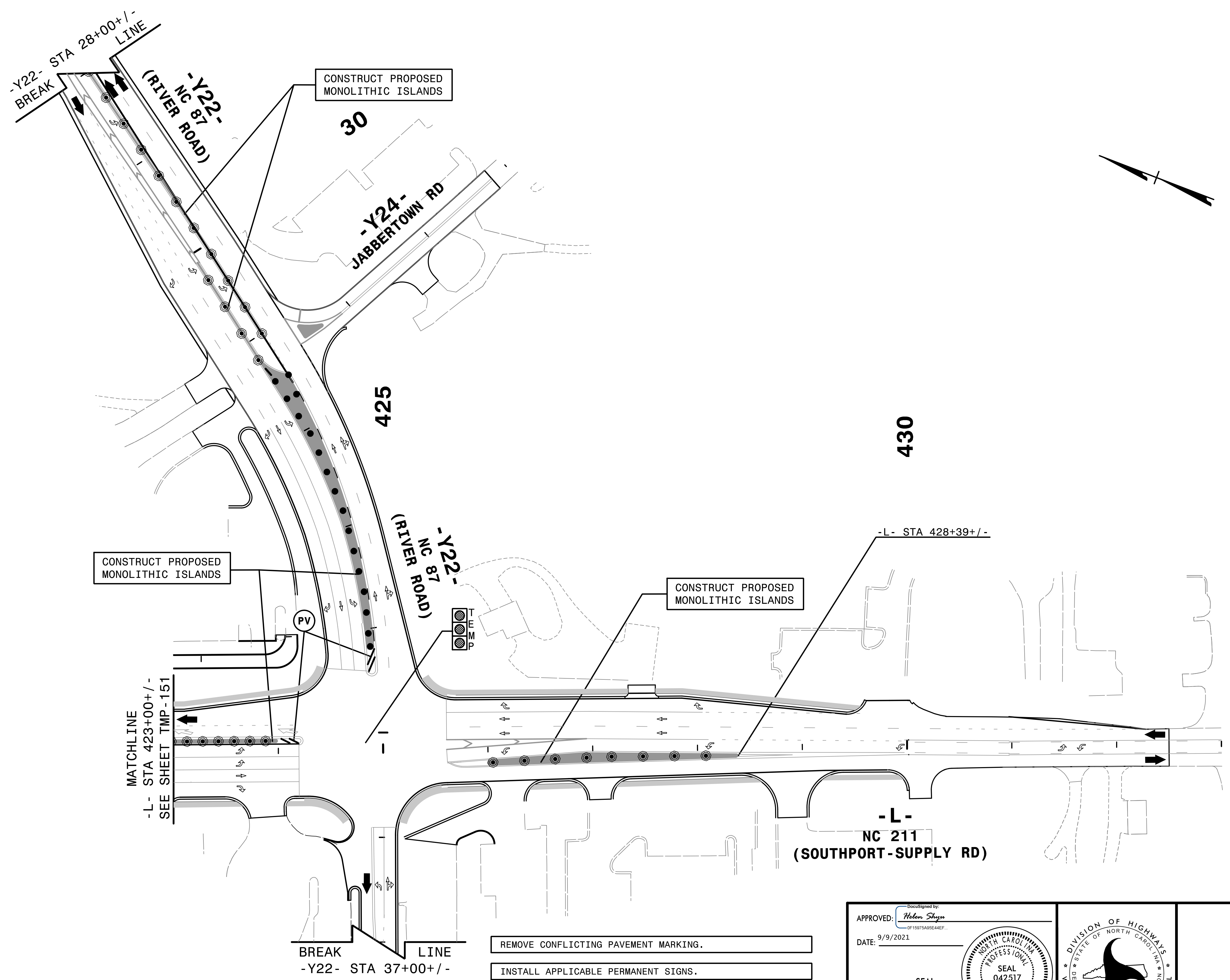

4:56:06 PM
 \\TCPL\F5021\TC_P33d26.dgn
 \$\$\$USERNAME\$\$\$



APPROVED: *Helen Shyu*
OF 15975A95E4EF

DATE: 9/9/2021

SEAL

**DOCUMENT NOT CONSIDERED FINAL
 UNLESS ALL SIGNATURES COMPLETED**



TRANSPORTATION
 MANAGEMENT PLAN

PHASE III
 DETAIL

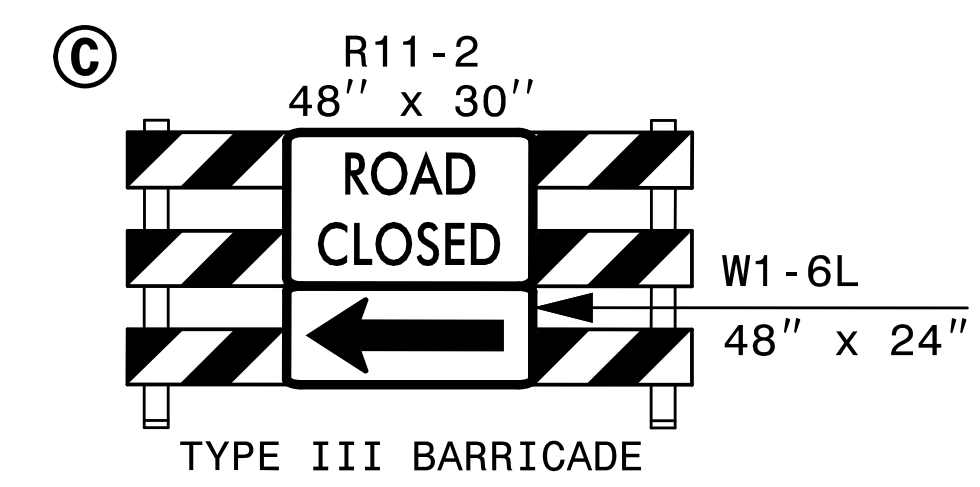
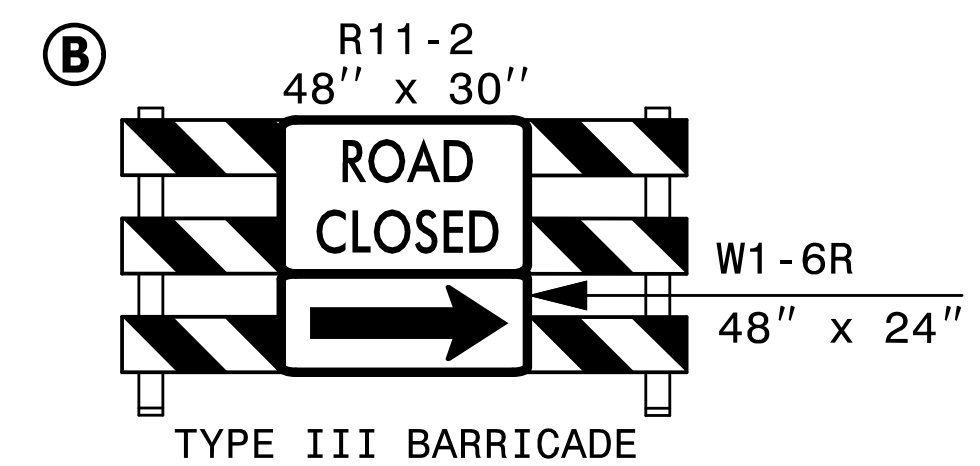
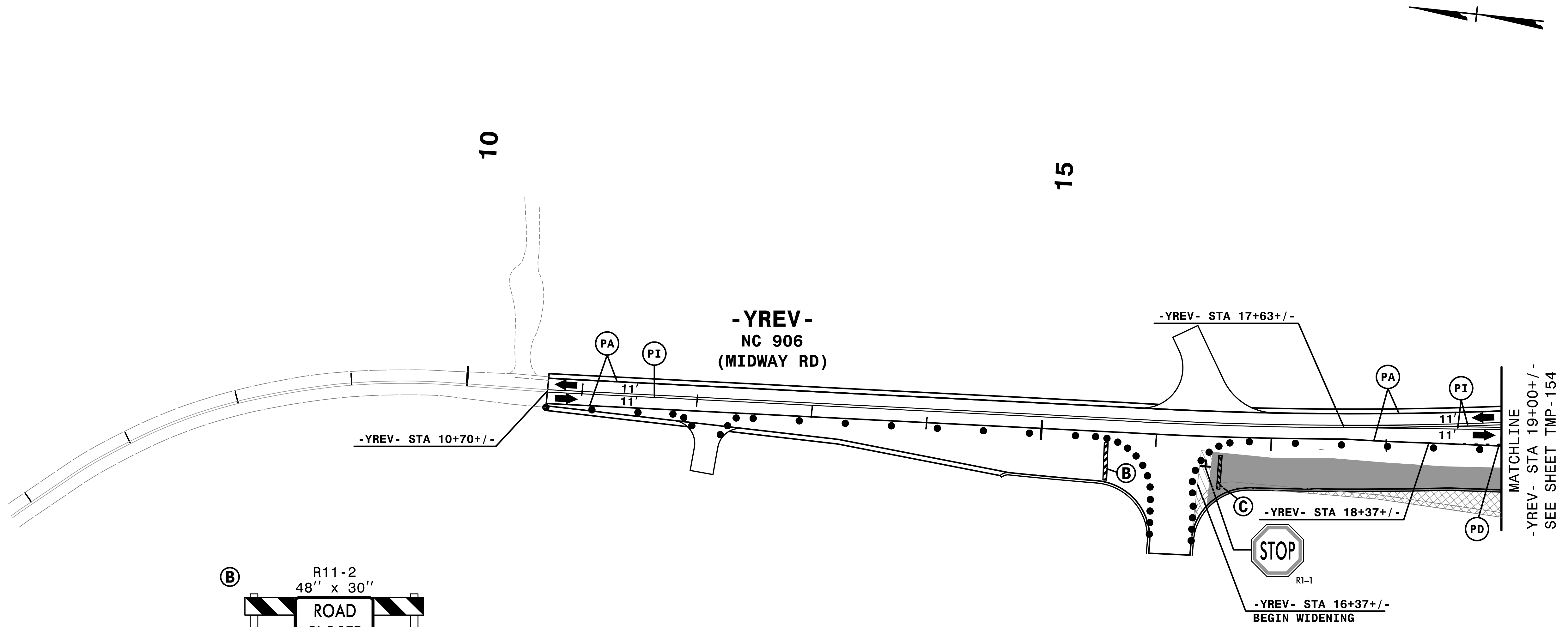

REMOVE CONFLICTING PAVEMENT MARKING.

INSTALL APPLICABLE PERMANENT SIGNS.

4:56:08 PM
 ...\\TCFV-5021\TC_P3\427.dgn
 \$\$\$USERNAME\$\$\$

HNTB HNTB NORTH CAROLINA, P.C.
 343 E. Six Forks Road, Suite 200
 Raleigh, North Carolina 27609
 NC License No: C-1554

APPROVED: *Helen Shyu*
 DATE: 9/9/2021
 SEAL
 PROFESSIONAL SEAL
 042517
 ENGINEER
 HELEN SHYU

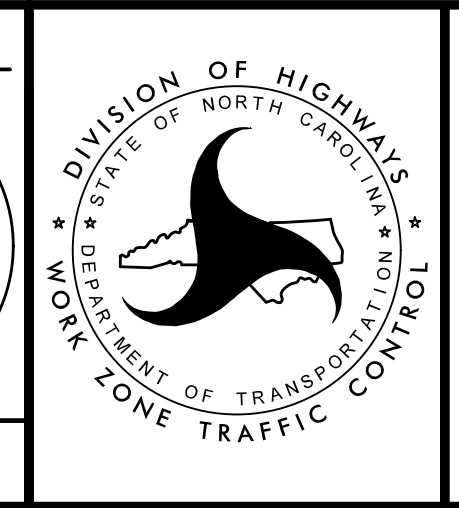

TRANSPORTATION
 MANAGEMENT PLAN

PHASE III
 DETAIL

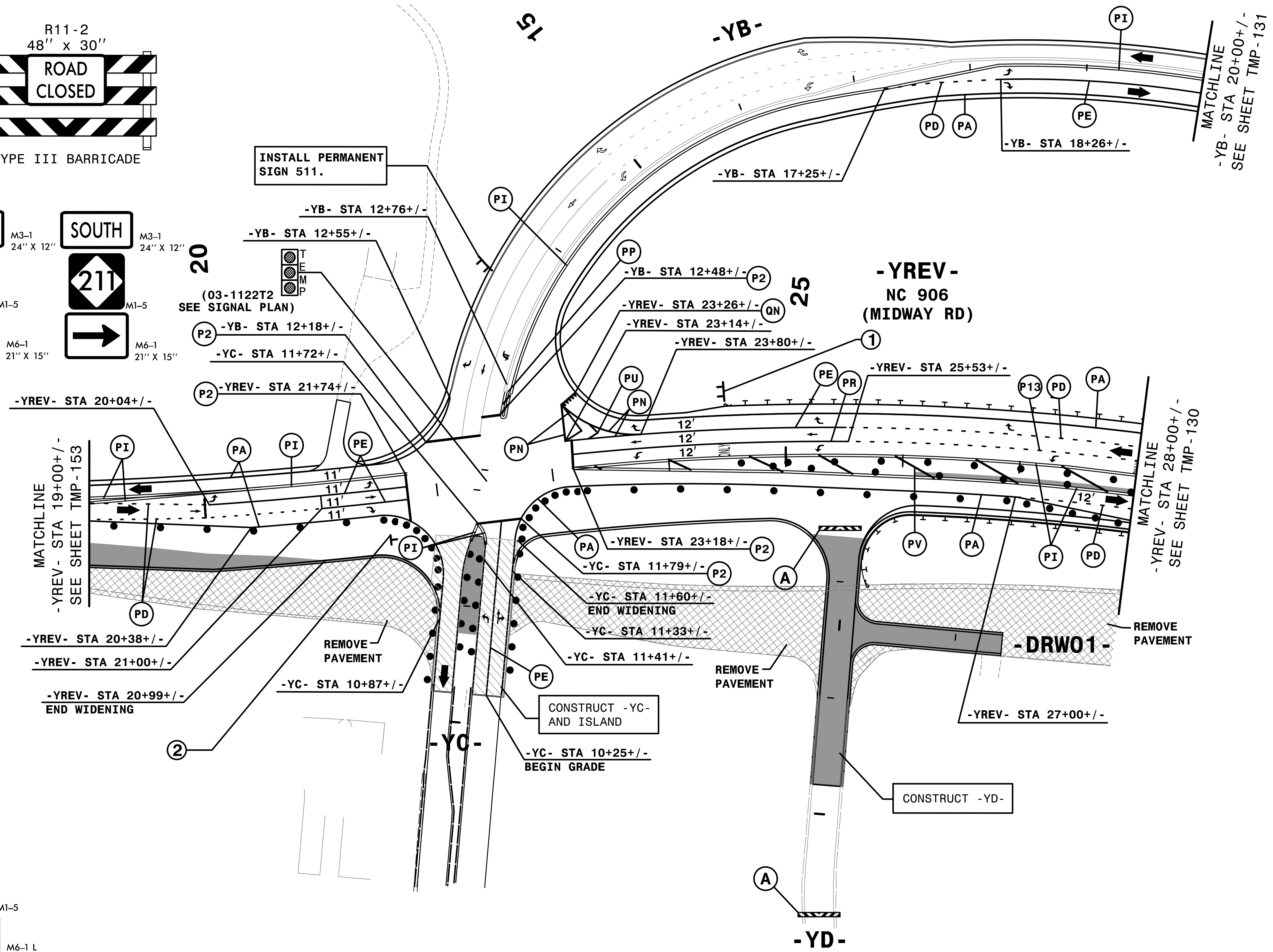
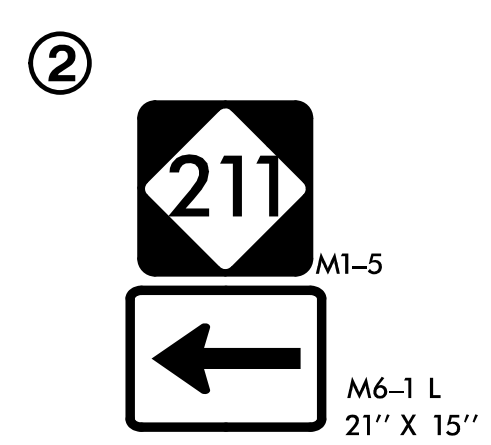
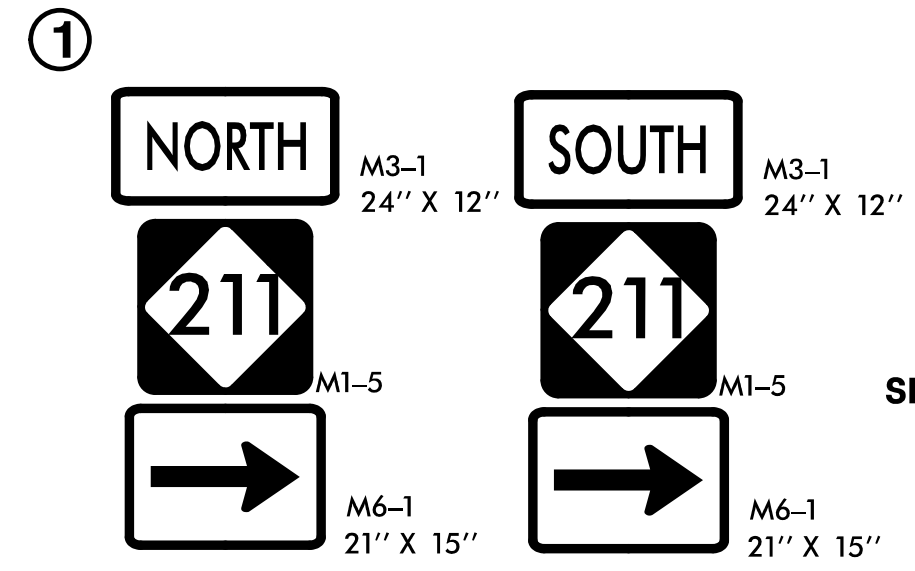
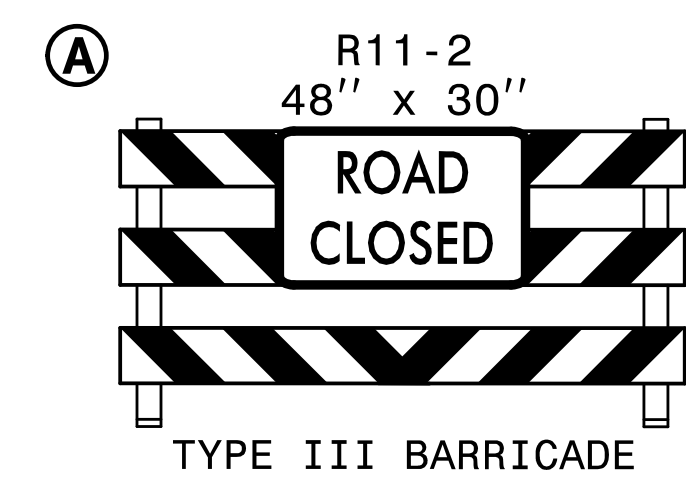

REMOVE CONFLICTING PAVEMENT MARKING.
INSTALL APPLICABLE PERMANENT SIGNS.

4:41:30 PM
\\TCFV\5021\1\c_p3\428.dgn
\$\$\$\$\$USERNAME\$\$\$\$\$

HNTB HNTB NORTH CAROLINA, P.C.
343 E. Six Forks Road, Suite 200
Raleigh, North Carolina 27609
NC License No: C-1554

APPROVED: *Helen Shyu*
DATE: 9/9/2021
SEAL
Professional Engineer
HELEN SHYU
042517

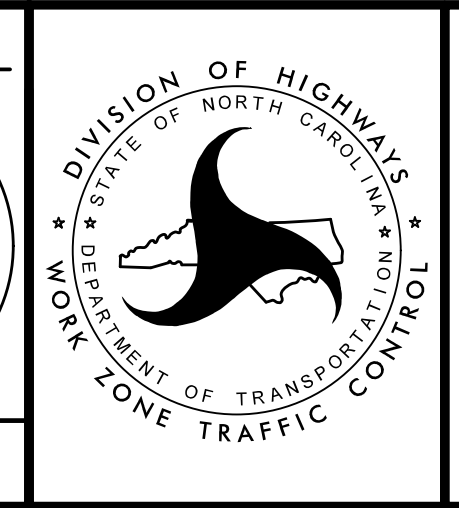

TRANSPORTATION
MANAGEMENT PLAN

PHASE III
DETAIL

DOCUMENT NOT CONSIDERED FINAL
UNLESS ALL SIGNATURES COMPLETED

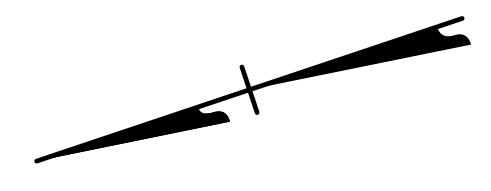
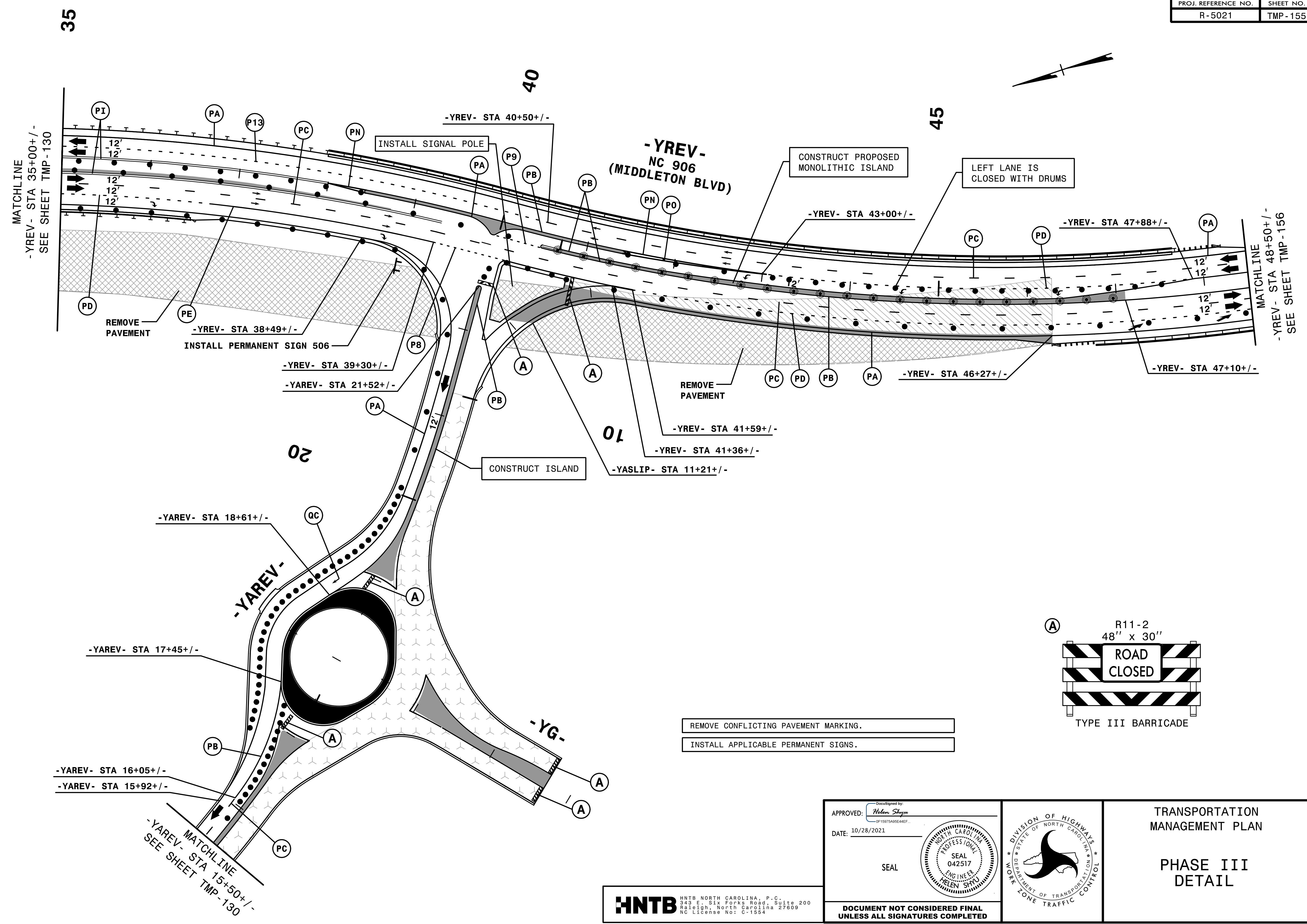

MATCHLINE
-YREV- STA 35+00+/-
SEE SHEET TMP-130

MATCHLINE
-YREV- STA 48+50+/-
SEE SHEET TMP-156

REMOVE PAVEMENT

-YREV- STA 38+49+/-
INSTALL PERMANENT SIGN 506

-YREV- STA 39+30+/-
-YREV- STA 21+52+/-

CONSTRUCT ISLAND

REMOVE PAVEMENT

-YREV- STA 41+59+/-
-YREV- STA 41+36+/-

10

-YASLIP- STA 11+21+/-

CONSTRUCT PROPOSED MONOLITHIC ISLAND

LEFT LANE IS CLOSED WITH DRUMS

-YREV- STA 43+00+/-

-YREV- STA 47+88+/-

-YREV- STA 47+10+/-

-YREV- STA 46+27+/-

-YAREV- STA 18+61+/-

-YAREV- STA 17+45+/-

-YAREV- STA 16+05+/-
-YAREV- STA 15+92+/-

MATCHLINE
-YAREV- STA 15+50+/-
SEE SHEET TMP-130

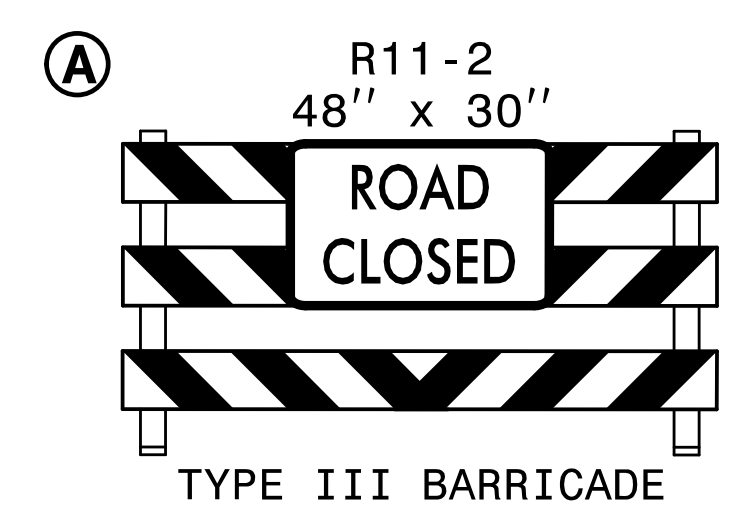

REMOVE CONFLICTING PAVEMENT MARKING.
INSTALL APPLICABLE PERMANENT SIGNS.

3:24:21PM
\\TC\p\5021\fc_d\3d29.dgn
\$\$\$\$\$USERNAME\$\$\$\$\$



APPROVED: *Helen Shyu*
DATE: 10/28/2021

SEAL

DOCUMENT NOT CONSIDERED FINAL
UNLESS ALL SIGNATURES COMPLETED



TRANSPORTATION
MANAGEMENT PLAN

PHASE III
DETAIL

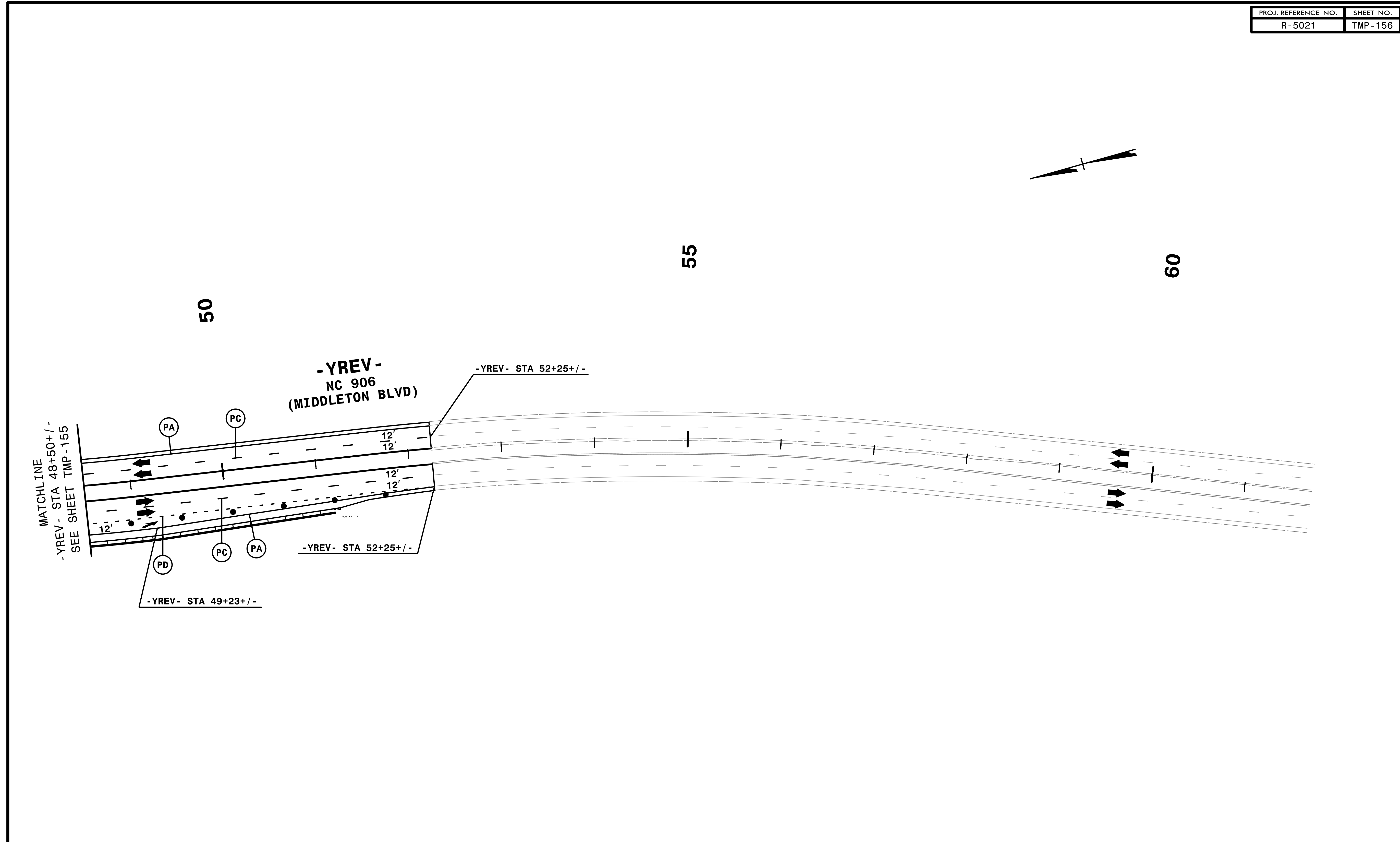

2/6/2019
 HNTB
 HNTB

- REMOVE CONFLICTING PAVEMENT MARKING.
- INSTALL APPLICABLE PERMANENT SIGNS.

HNTB HNTB NORTH CAROLINA, P.C.
 343 E. Six Forks Road, Suite 200
 Raleigh, North Carolina 27609
 NC License No: C-1554

APPROVED: *Helen Shyu*
 DATE: 2/6/2019
 SEAL
 DOCUMENT NOT CONSIDERED FINAL
 UNLESS ALL SIGNATURES COMPLETED

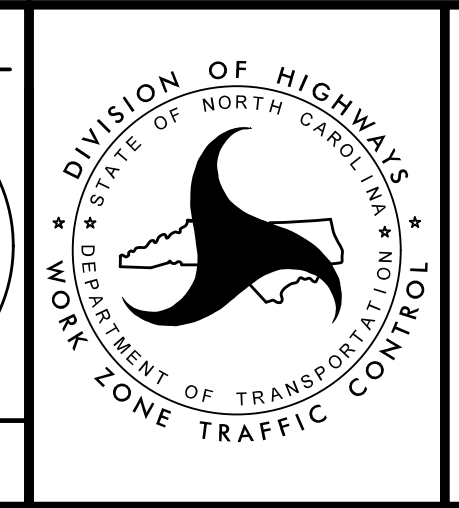

TRANSPORTATION
 MANAGEMENT PLAN
 PHASE III
 DETAIL

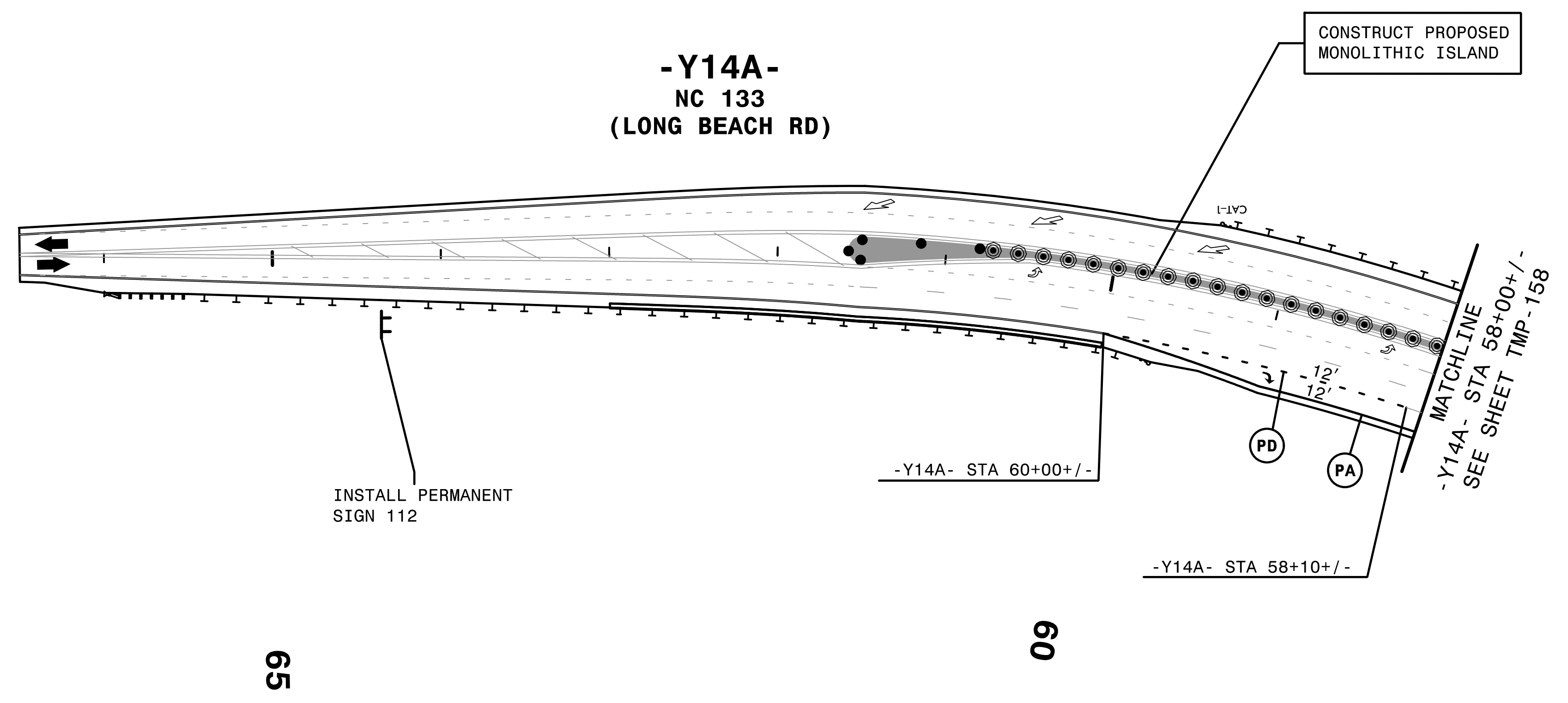
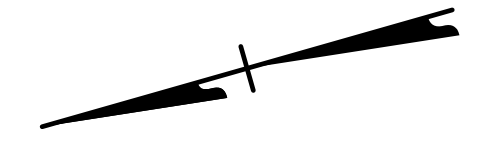

65

09

- REMOVE CONFLICTING PAVEMENT MARKING.
- INSTALL APPLICABLE PERMANENT SIGNS.

2/6/2019
 TCR-V-5021-10-p3d32.dgn
 HNTB

HNTB HNTB NORTH CAROLINA, P.C.
 343 E. Six Forks Road, Suite 200
 Raleigh, North Carolina 27609
 NC License No: C-1554

APPROVED: *Helen Shyu*
 DATE: 2/6/2019
 SEAL
 DOCUMENT NOT CONSIDERED FINAL
 UNLESS ALL SIGNATURES COMPLETED

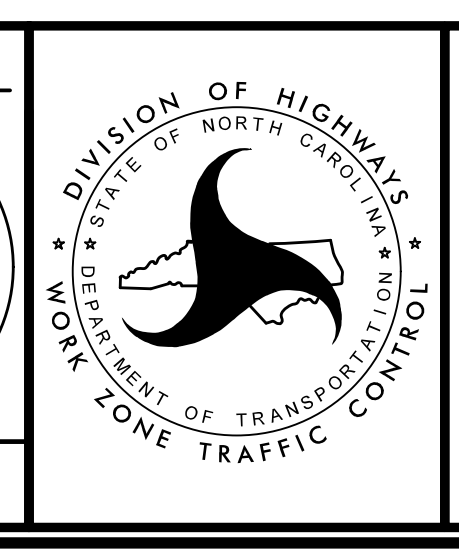

TRANSPORTATION
 MANAGEMENT PLAN
 PHASE III
 DETAIL

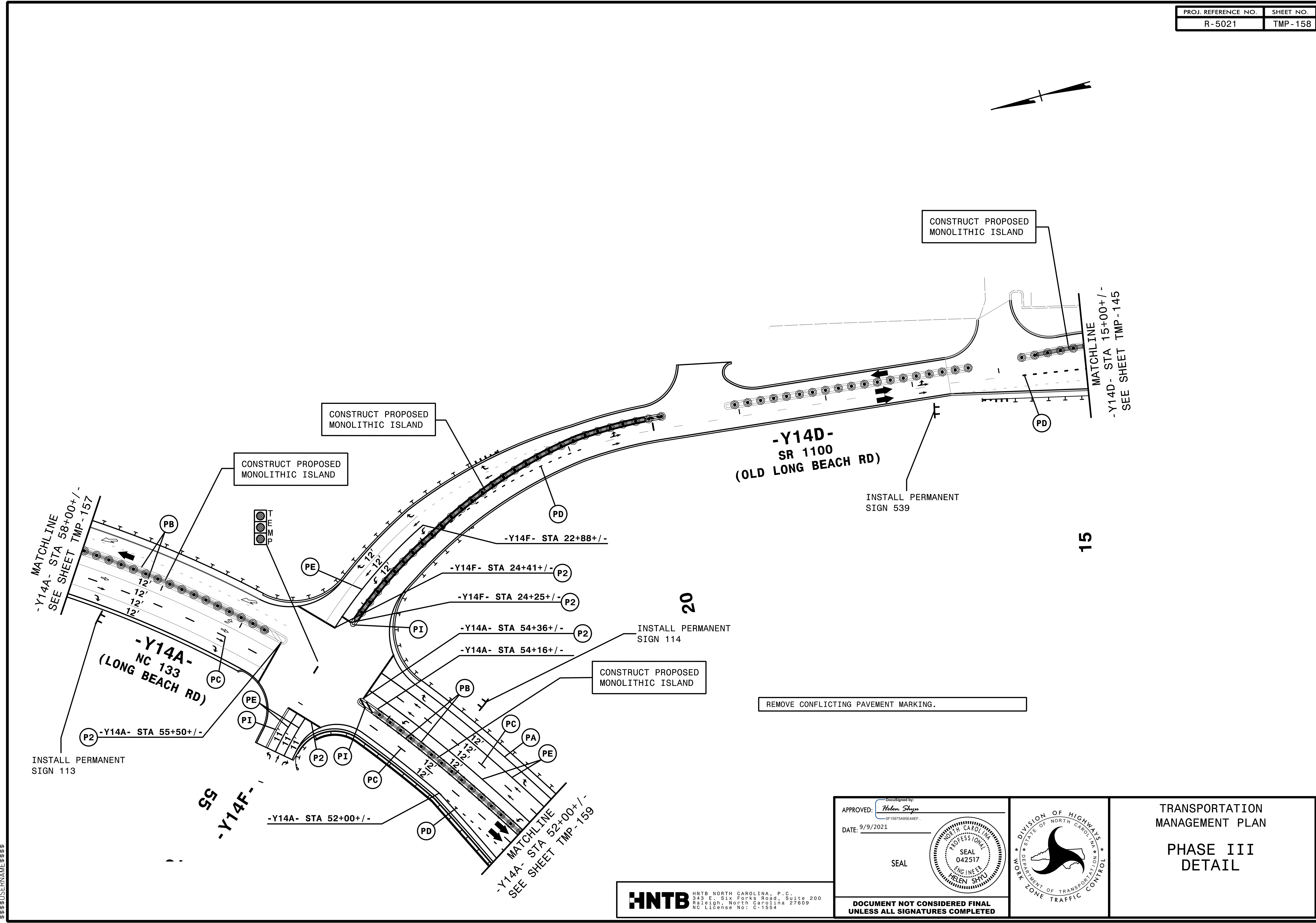

11:51:10 AM
 \\TCF\5021\10_p3d35.dgn
 \$\$\$USERNAME\$\$\$

HNTB HNTB NORTH CAROLINA, P.C.
 343 E. Six Forks Road, Suite 200
 Raleigh, North Carolina 27609
 NC License No: C-1554

APPROVED: *Helen Shyu*
 DATE: 9/9/2021
 SEAL
 DOCUMENT NOT CONSIDERED FINAL
 UNLESS ALL SIGNATURES COMPLETED

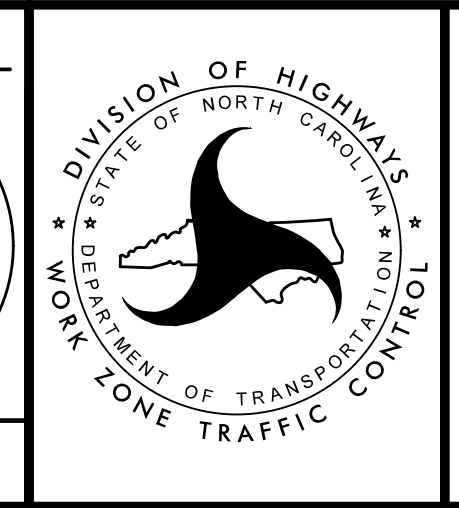

TRANSPORTATION
 MANAGEMENT PLAN
 PHASE III
 DETAIL

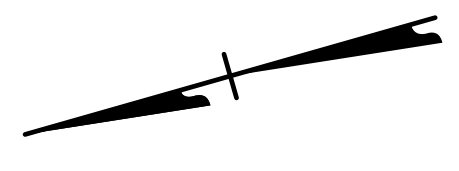
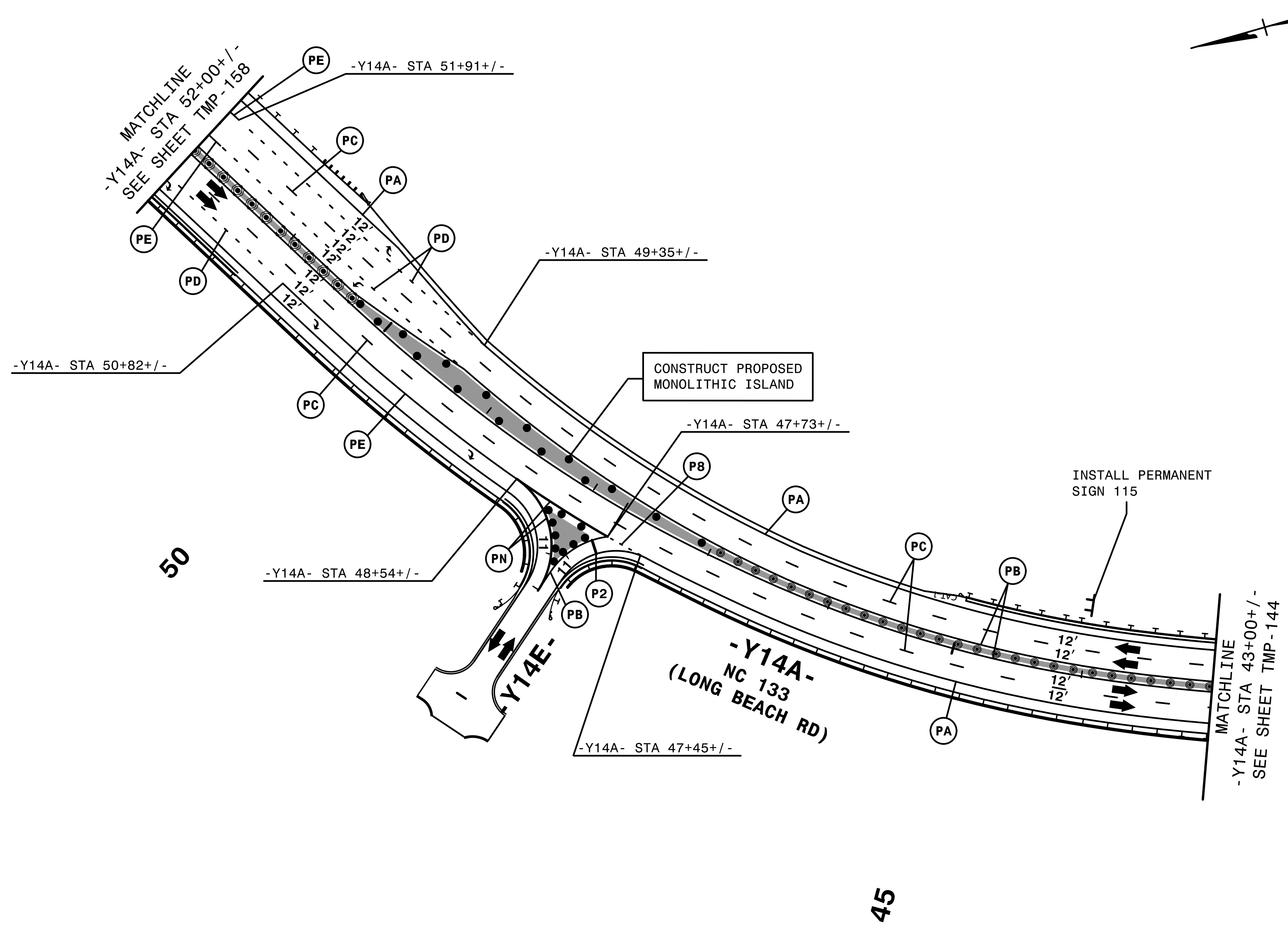

- REMOVE CONFLICTING PAVEMENT MARKING.
- INSTALL APPLICABLE PERMANENT SIGNS.

HNTB HNTB NORTH CAROLINA, P.C.
 343 E. Six Forks Road, Suite 200
 Raleigh, North Carolina 27609
 NC License No: C-1554

APPROVED: *Helen Shyu*
 DATE: 9/9/2021
 SEAL
 DOCUMENT NOT CONSIDERED FINAL
 UNLESS ALL SIGNATURES COMPLETED

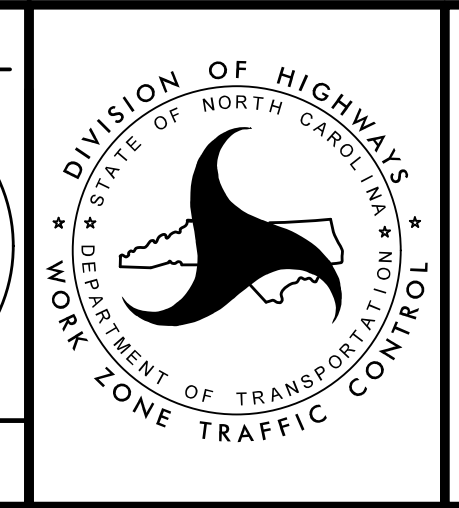
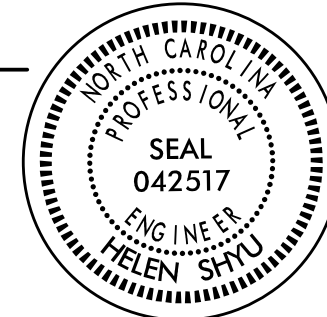

TRANSPORTATION
 MANAGEMENT PLAN
 PHASE III
 DETAIL

4:56:17 PM
 \\TCF\15021\10_p3d33.dgn
 \$\$\$USERNAME\$\$\$

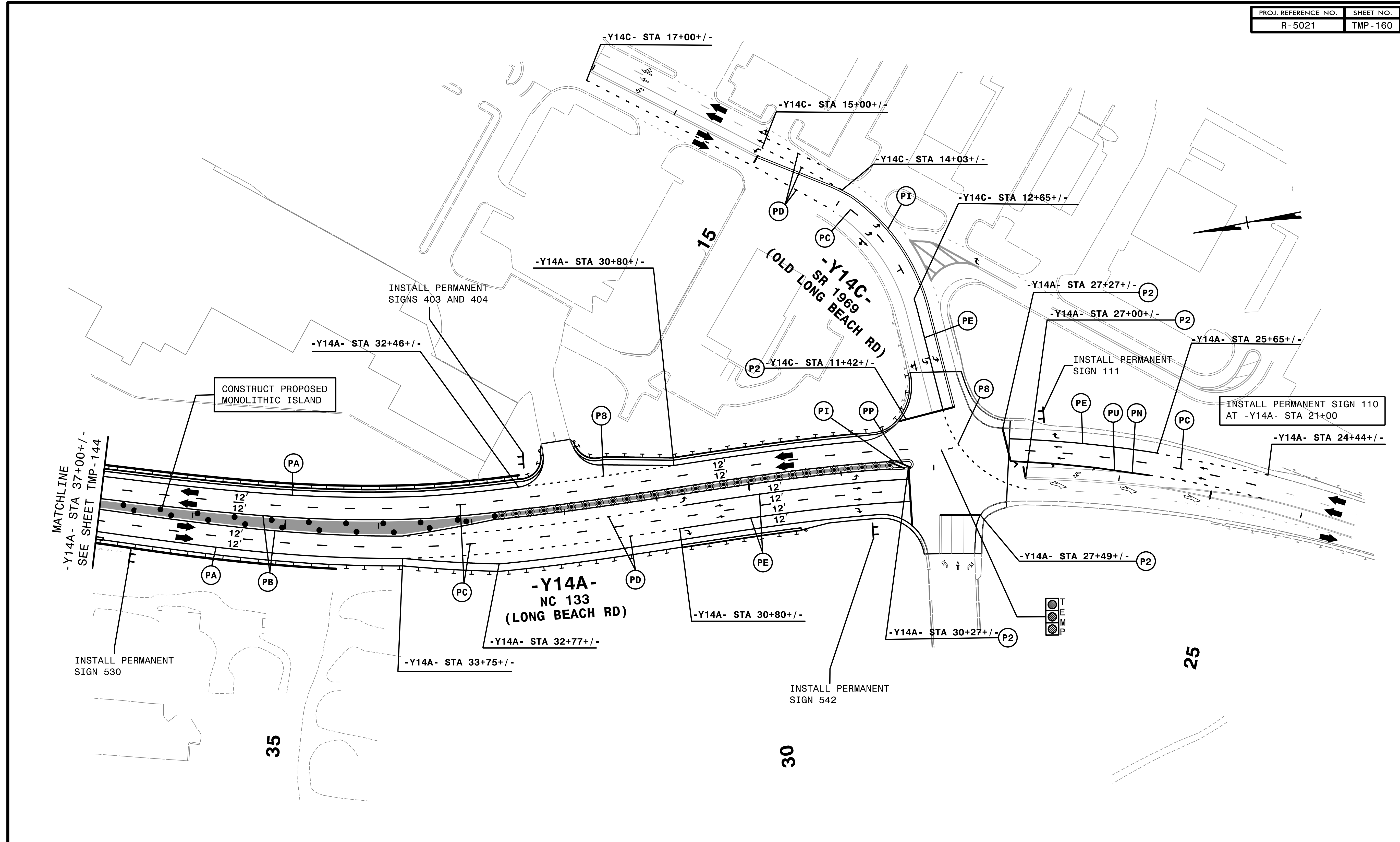

4/14/22 PM
 \\TCF\5021\10\p3\34.dgn
 \$\$\$USERNAME\$\$\$

- REMOVE CONFLICTING PAVEMENT MARKING.
- INSTALL APPLICABLE PERMANENT SIGNS.

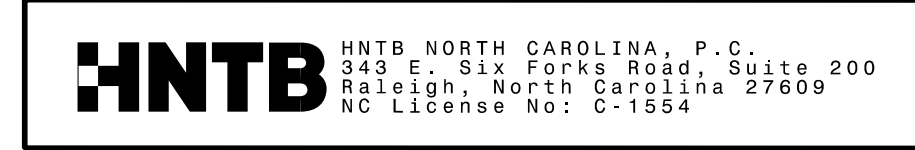

APPROVED: *Helen Shyu*
 DATE: 9/9/2021
 SEAL
 DOCUMENT NOT CONSIDERED FINAL UNLESS ALL SIGNATURES COMPLETED

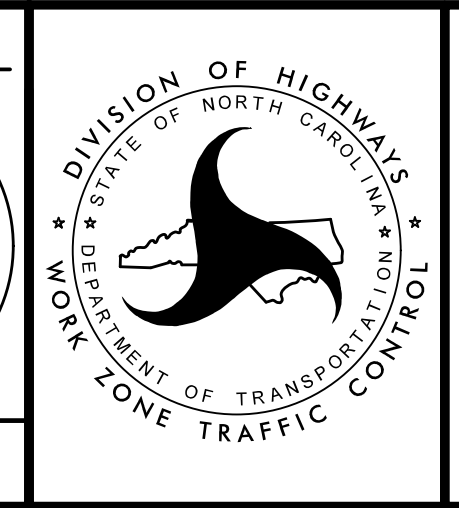

TRANSPORTATION MANAGEMENT PLAN
 PHASE III
 DETAIL

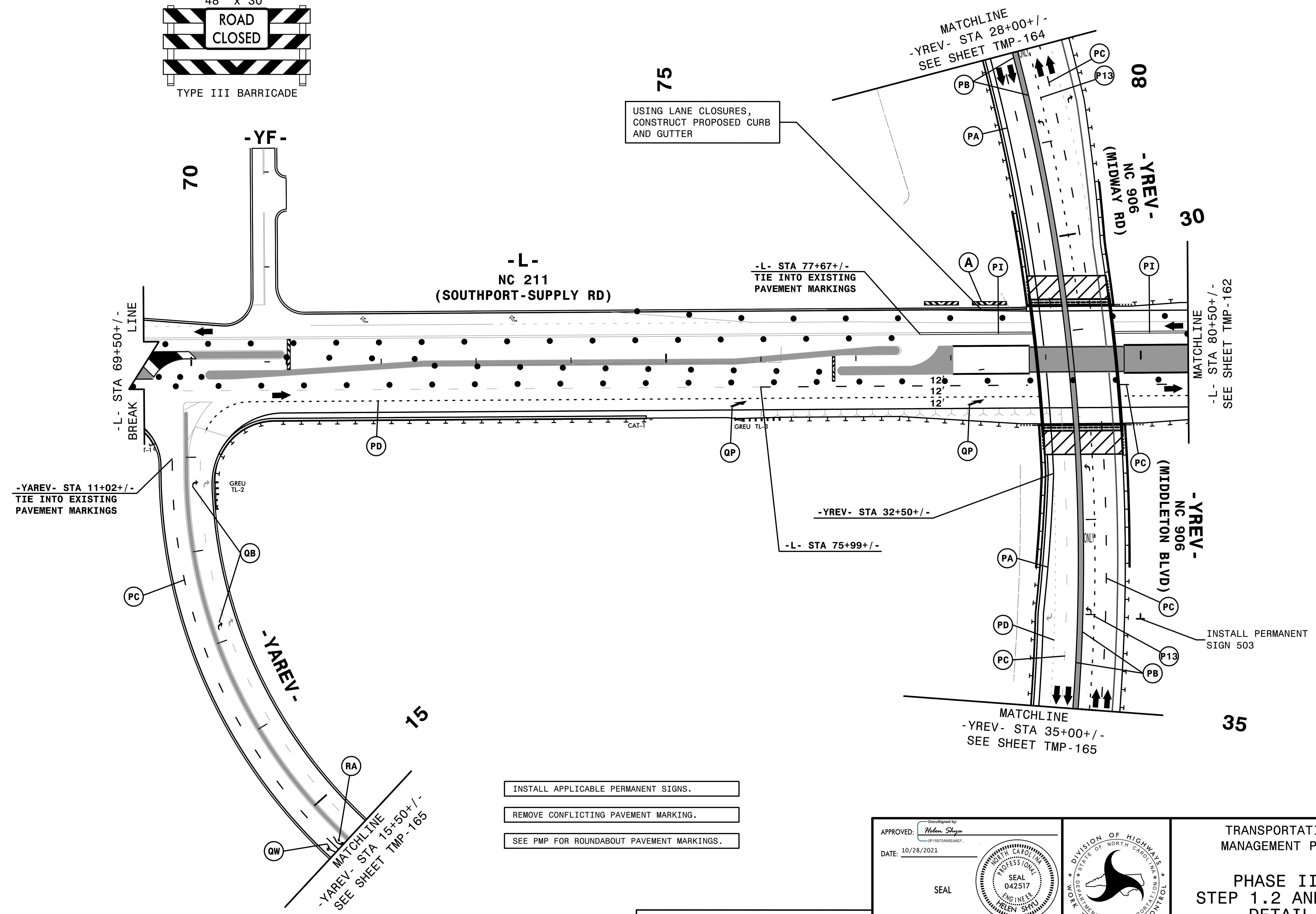
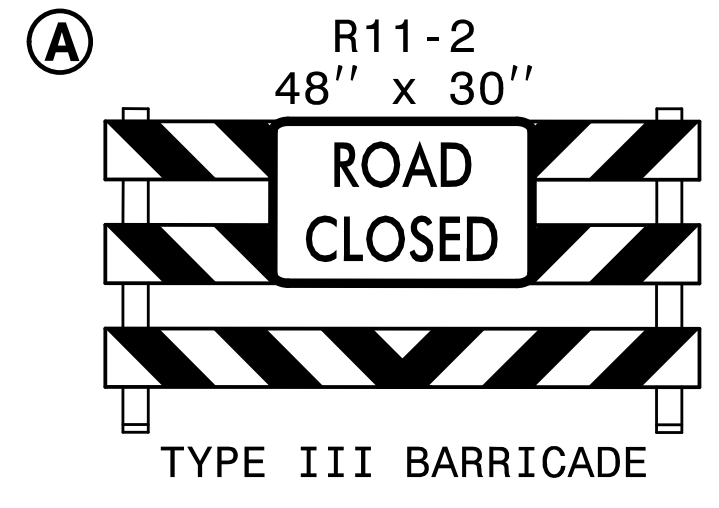

USING LANE CLOSURES,
CONSTRUCT PROPOSED CURB
AND GUTTER

-L- STA 77+67+/-
TIE INTO EXISTING
PAVEMENT MARKINGS

-YAREV- STA 11+02+/-
TIE INTO EXISTING
PAVEMENT MARKINGS

-YREV- STA 32+50+/-

-L- STA 75+99+/-

MATCHLINE
-L- STA 80+50+/-
SEE SHEET TMP-162

MATCHLINE
-YREV- STA 35+00+/-
SEE SHEET TMP-165

MATCHLINE
-YAREV- STA 15+50+/-
SEE SHEET TMP-165

- INSTALL APPLICABLE PERMANENT SIGNS.
- REMOVE CONFLICTING PAVEMENT MARKING.
- SEE PMP FOR ROUNDABOUT PAVEMENT MARKINGS.

3:24:23 PM
 \\TCPLV5021\fc_dp3d3 GreenT.dgn
 \$\$\$USERNAME\$\$\$



APPROVED: *Helen Shyu*
 DATE: 10/28/2021
 SEAL
 DOCUMENT NOT CONSIDERED FINAL
 UNLESS ALL SIGNATURES COMPLETED



TRANSPORTATION
MANAGEMENT PLAN

 PHASE III
STEP 1.2 AND 1.3
DETAIL

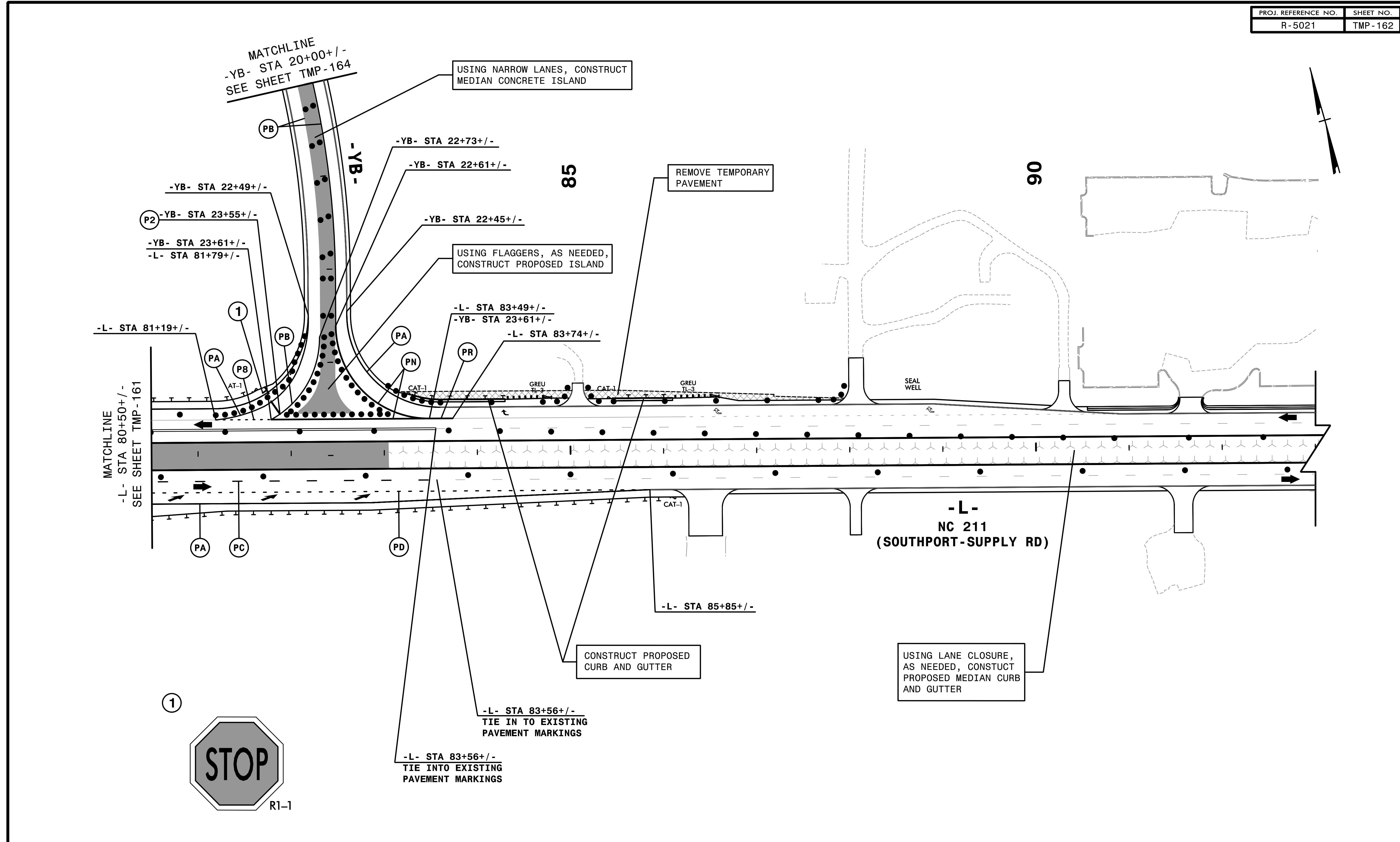

4:56:24 PM
...N:\CP\1502\1\to_p3d4 GreenT.dgn
\$\$\$\$\$USERNAME\$\$\$\$\$

HNTB HNTB NORTH CAROLINA, P.C.
343 E. Six Forks Road, Suite 200
Raleigh, North Carolina 27609
NC License No: C-1554

APPROVED: *Helen Shyu*
DATE: 9/9/2021
SEAL
DOCUMENT NOT CONSIDERED FINAL
UNLESS ALL SIGNATURES COMPLETED

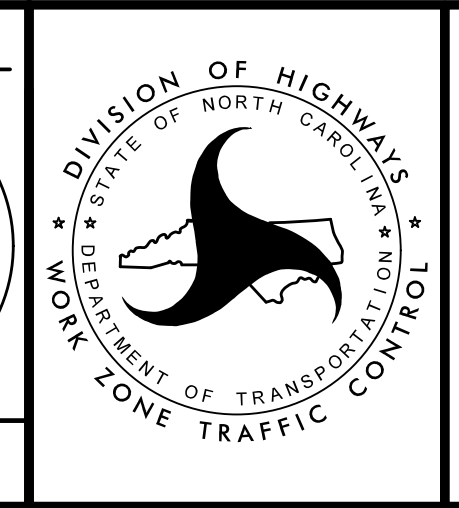

TRANSPORTATION
MANAGEMENT PLAN

PHASE III
STEP 1.2 AND 1.3
DETAIL

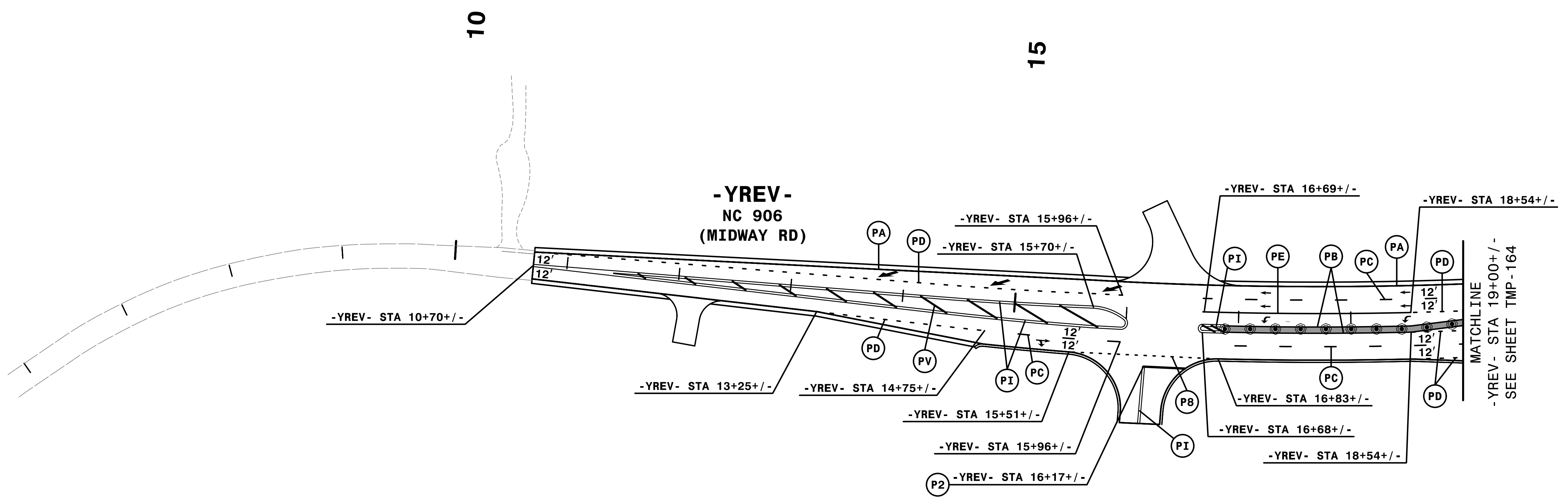

REMOVE CONFLICTING PAVEMENT MARKING.

4:56:26 PM
...\\TCF\...5021\...p3d27 GreenT.dgn
\$\$\$\$\$USERNAME\$\$\$\$\$

HNTB HNTB NORTH CAROLINA, P.C.
343 E. Six Forks Road, Suite 200
Raleigh, North Carolina 27609
NC License No: C-1554

APPROVED: *Helen Shyu*
DATE: 9/9/2021
SEAL
DOCUMENT NOT CONSIDERED FINAL
UNLESS ALL SIGNATURES COMPLETED

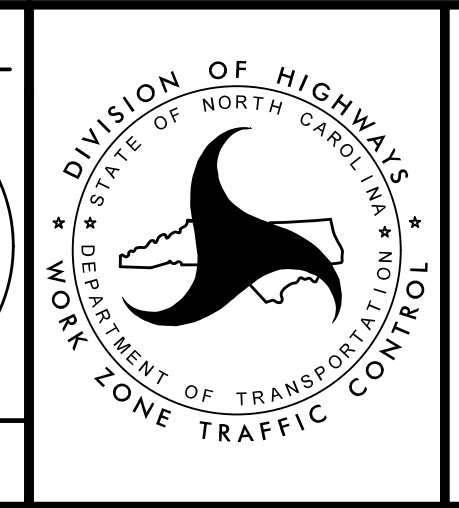
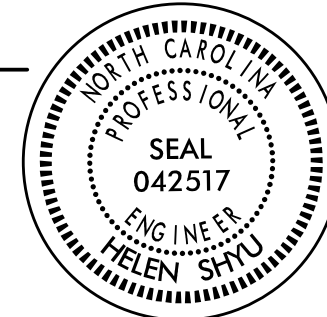

TRANSPORTATION
MANAGEMENT PLAN

PHASE III
STEPS 1.2 AND 1.3
DETAIL

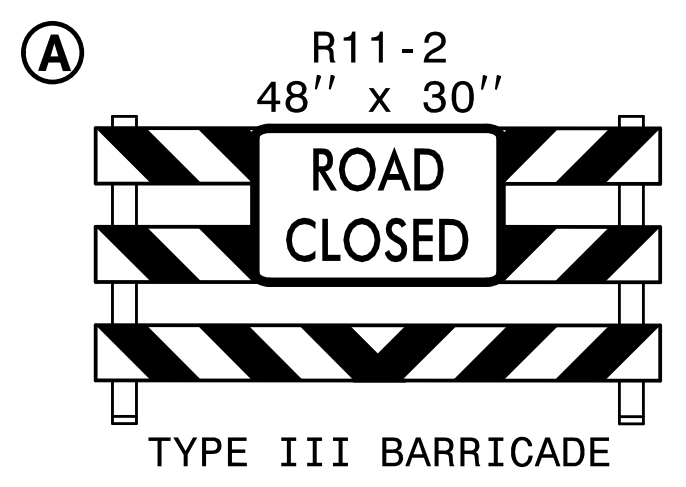
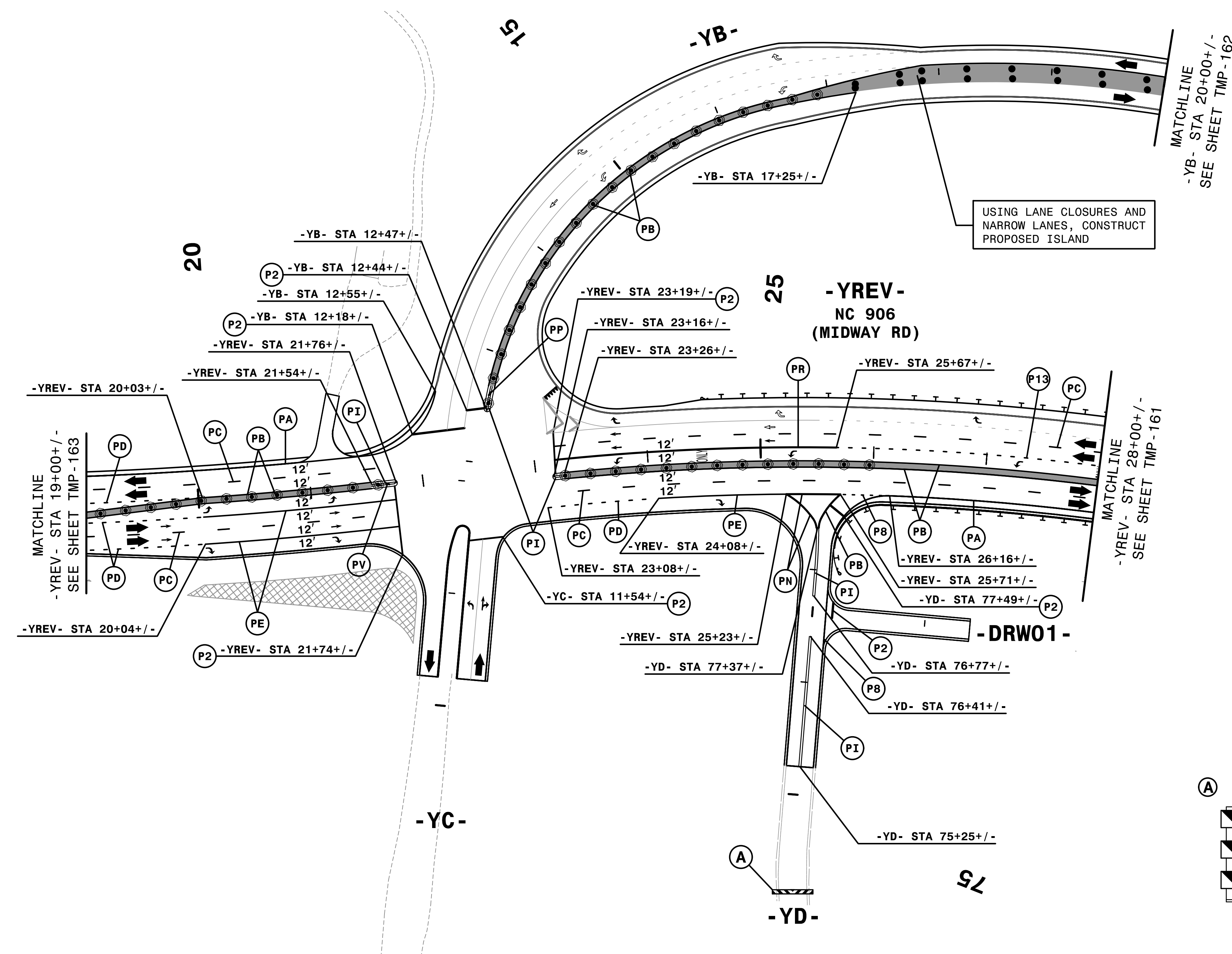

REMOVE CONFLICTING PAVEMENT MARKING.

11:51:24 AM
...TCF...5021...p3d28 GreenT.dgn
\$\$\$\$\$USERNAME\$\$\$\$\$

HNTB HNTB NORTH CAROLINA, P.C.
343 E. Six Forks Road, Suite 200
Raleigh, North Carolina 27609
NC License No: C-1554

APPROVED: *Helen Shyu*
DATE: 9/9/2021
SEAL
DOCUMENT NOT CONSIDERED FINAL
UNLESS ALL SIGNATURES COMPLETED

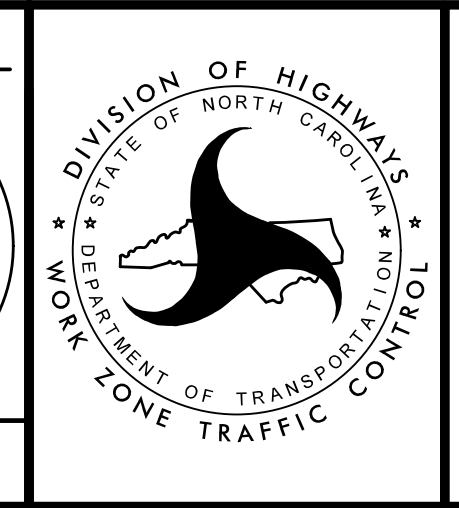

TRANSPORTATION
MANAGEMENT PLAN
PHASE III
STEPS 1.2 AND 1.3
DETAIL

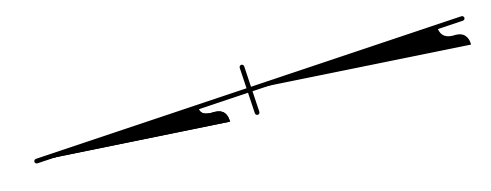
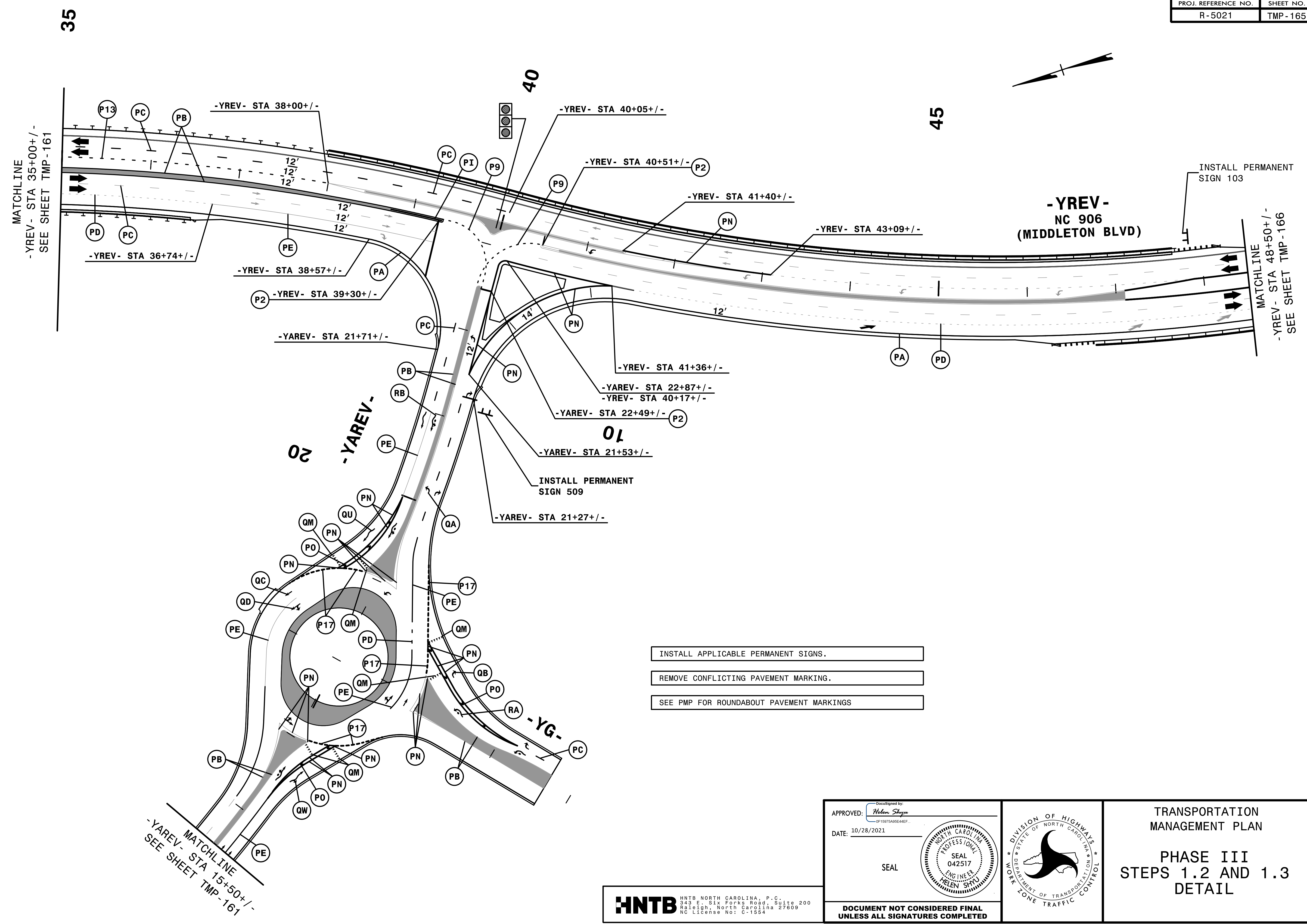

- INSTALL APPLICABLE PERMANENT SIGNS.
- REMOVE CONFLICTING PAVEMENT MARKING.
- SEE PMP FOR ROUNDABOUT PAVEMENT MARKINGS

3:24:26 PM
 \\TCPLV502L1c_dp3d29_GreenT.dgn
 \$\$\$USERNAME\$\$\$

APPROVED: *Helen Shyu*
DocuSigned by:
Helen Shyu
0F15075A9E44EF

DATE: 10/28/2021

SEAL

**DOCUMENT NOT CONSIDERED FINAL
UNLESS ALL SIGNATURES COMPLETED**



**TRANSPORTATION
MANAGEMENT PLAN**

**PHASE III
STEPS 1.2 AND 1.3
DETAIL**

HNTB

HNTB NORTH CAROLINA, P.C.
343 E. Six Forks Road, Suite 200
Raleigh, North Carolina 27609
NC License No: C-1554

PROJ. REFERENCE NO.	SHEET NO.
R-5021	TMP-166

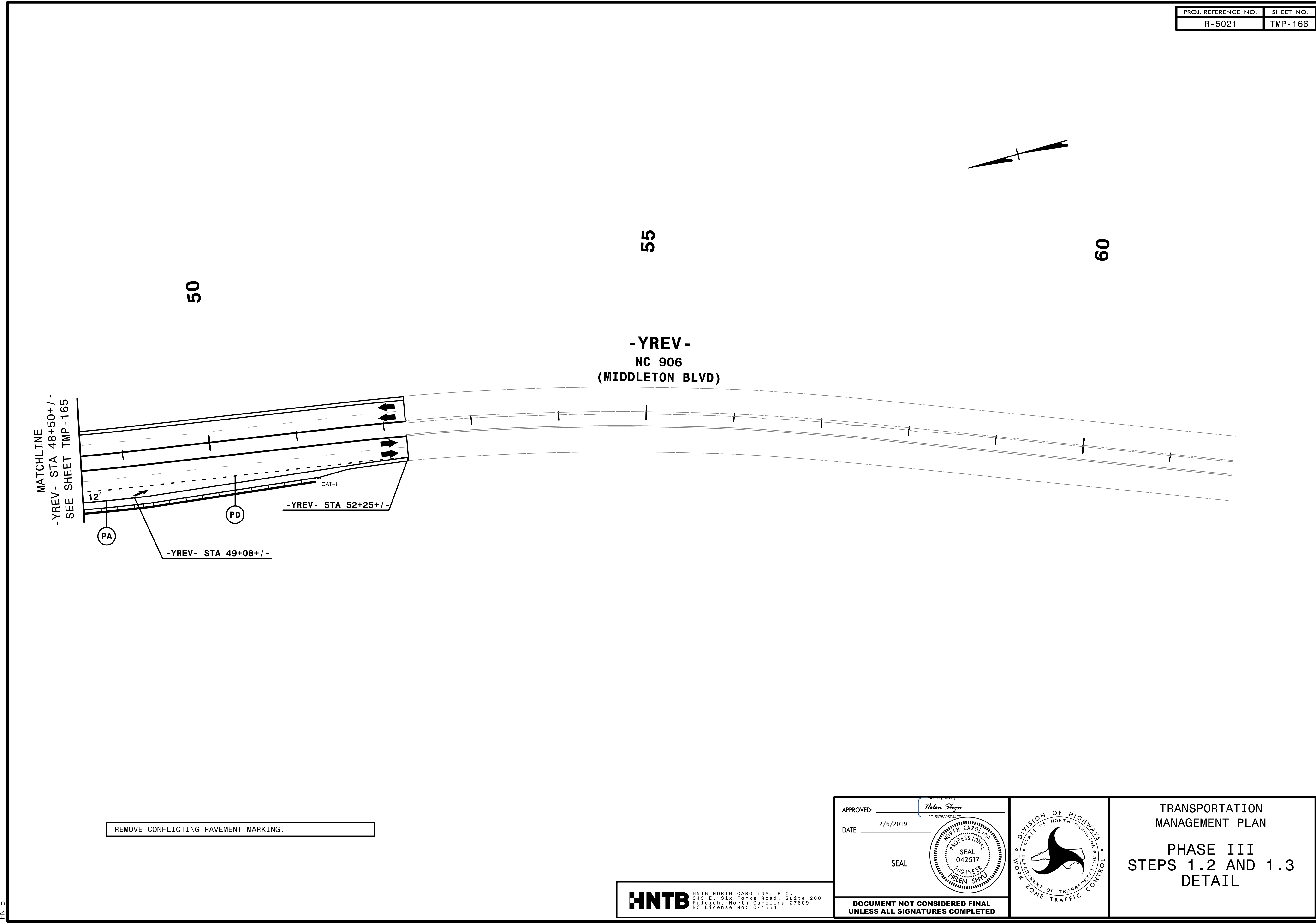

MATCHLINE
-YREV- STA 48+50+/-
SEE SHEET TMP-165

PA

-YREV- STA 49+08+/-

PD

-YREV- STA 52+25+/-

CAT-1

12'

REMOVE CONFLICTING PAVEMENT MARKING.

2/6/2019
TCR-V-5021-10-p3d30 GreenT.dgn
HNTB

HNTB HNTB NORTH CAROLINA, P.C.
343 E. Six Forks Road, Suite 200
Raleigh, North Carolina 27609
NC License No: C-1554

APPROVED: *Helen Shyu*
DATE: 2/6/2019
SEAL
DOCUMENT NOT CONSIDERED FINAL
UNLESS ALL SIGNATURES COMPLETED

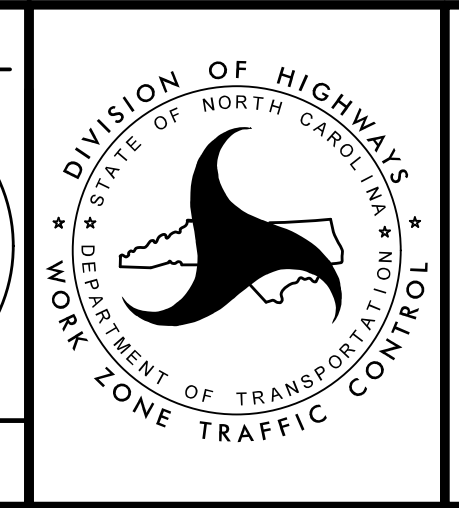
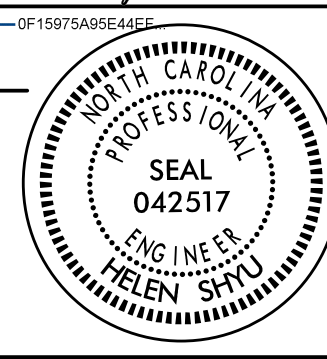

TRANSPORTATION
MANAGEMENT PLAN
PHASE III
STEPS 1.2 AND 1.3
DETAIL