

PROJ. REFERENCE NO.	SHEET NO.
R-5021	TMP-18

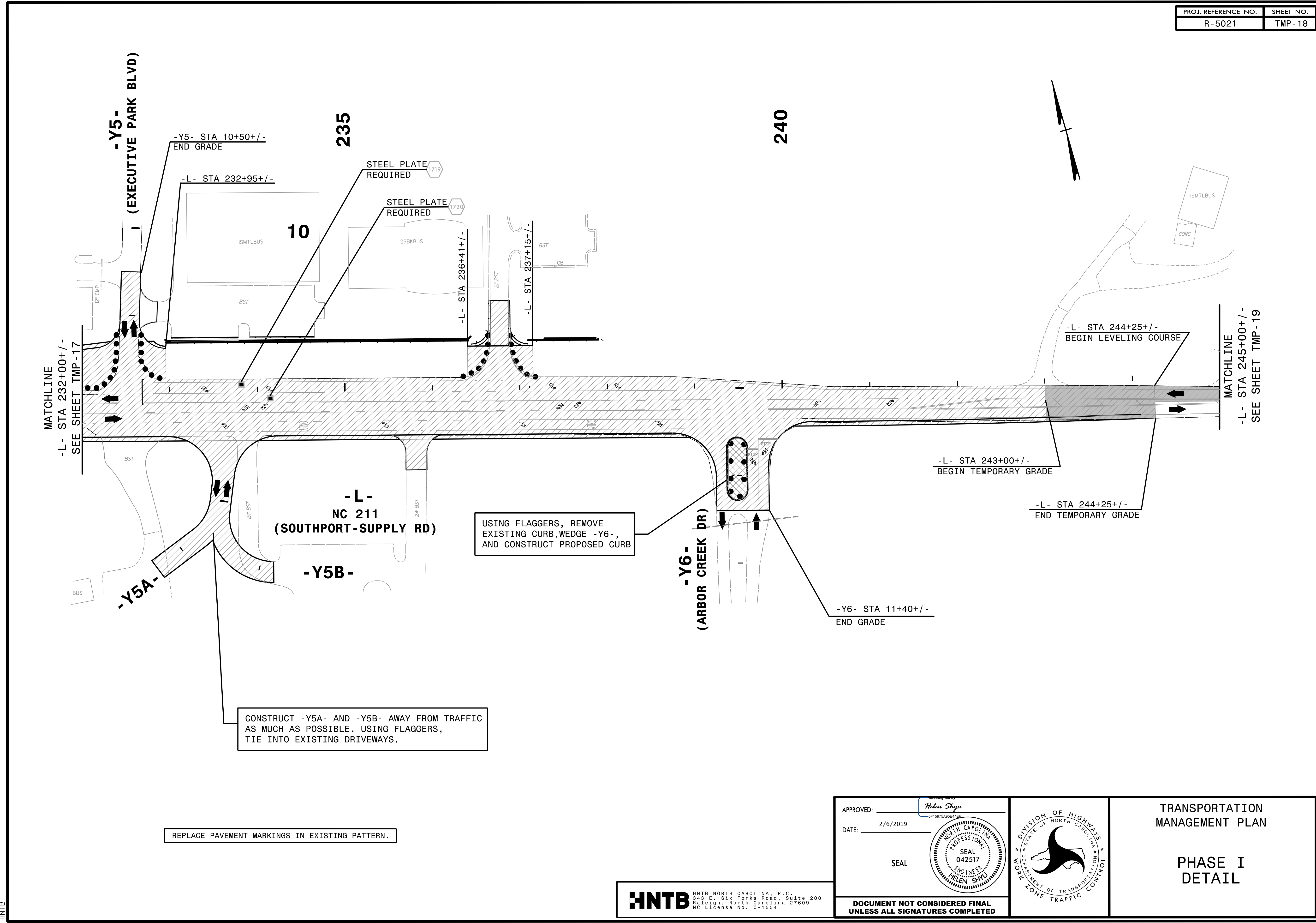

2/6/2019
TCR\5021\TC-18.dgn
HNTB

REPLACE PAVEMENT MARKINGS IN EXISTING PATTERN.

CONSTRUCT -Y5A- AND -Y5B- AWAY FROM TRAFFIC AS MUCH AS POSSIBLE. USING FLAGGERS, TIE INTO EXISTING DRIVEWAYS.

USING FLAGGERS, REMOVE EXISTING CURB, WEDGE -Y6-, AND CONSTRUCT PROPOSED CURB

HNTB HNTB NORTH CAROLINA, P.C.
343 E. Six Forks Road, Suite 200
Raleigh, North Carolina 27609
NC License No: C-1554

APPROVED: *Helen Skye*
DATE: 2/6/2019
SEAL
Professional Engineer Seal: HELEN SKYE, ENGINEER, SEAL 042517, PROFESSIONAL ENGINEER, STATE OF NORTH CAROLINA, 1987

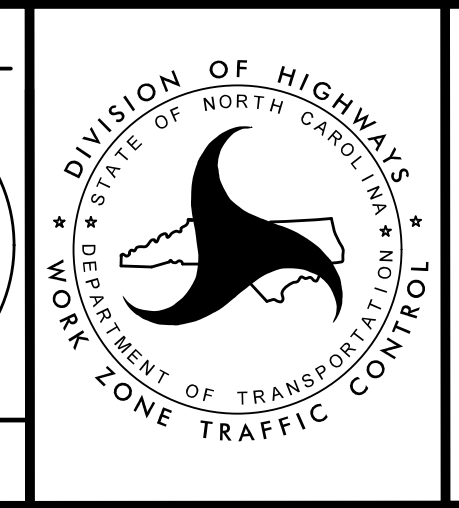

TRANSPORTATION MANAGEMENT PLAN

PHASE I DETAIL

DOCUMENT NOT CONSIDERED FINAL UNLESS ALL SIGNATURES COMPLETED

PROJ. REFERENCE NO.	SHEET NO.
R-5021	TMP - 19

245

250

255

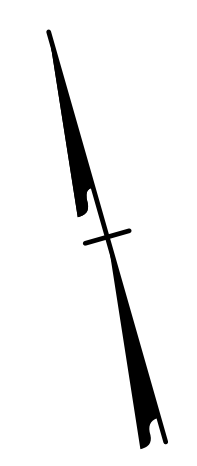

MATCHLINE
-L- STA 245+00+/-
SEE SHEET TMP-18

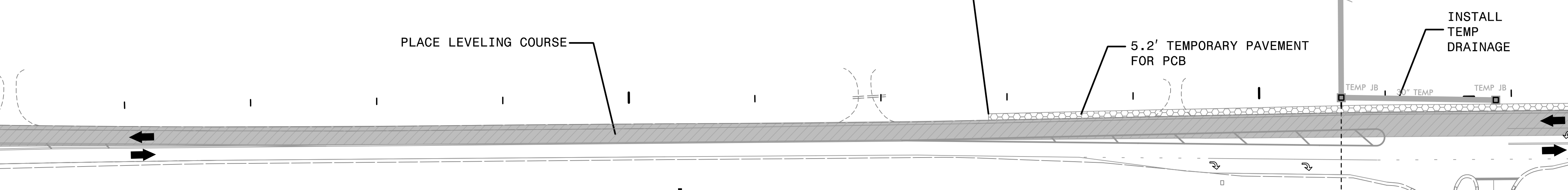

MATCHLINE
-L- STA 257+50+/-
SEE SHEET TMP-20

-L-
NC 211
(SOUTHPORT-SUPPLY RD)

-Y7-
(REGENCY CROSSING)

REPLACE PAVEMENT MARKINGS IN EXISTING PATTERN.

2/6/2019
HNTB
HNTB

HNTB HNTB NORTH CAROLINA, P.C.
343 E. Six Forks Road, Suite 200
Raleigh, North Carolina 27609
NC License No: C-1554

APPROVED: *Helen Skyy*
DATE: 2/6/2019
SEAL
Professional Engineer
HELEN SKYY
042517

DIVISION OF HIGHWAYS
STATE OF NORTH CAROLINA
DEPARTMENT OF TRANSPORTATION
WORK ZONE TRAFFIC CONTROL

TRANSPORTATION
MANAGEMENT PLAN

PHASE I
DETAIL

DOCUMENT NOT CONSIDERED FINAL
UNLESS ALL SIGNATURES COMPLETED

PROJ. REFERENCE NO.	SHEET NO.
R-5021	TMP-20

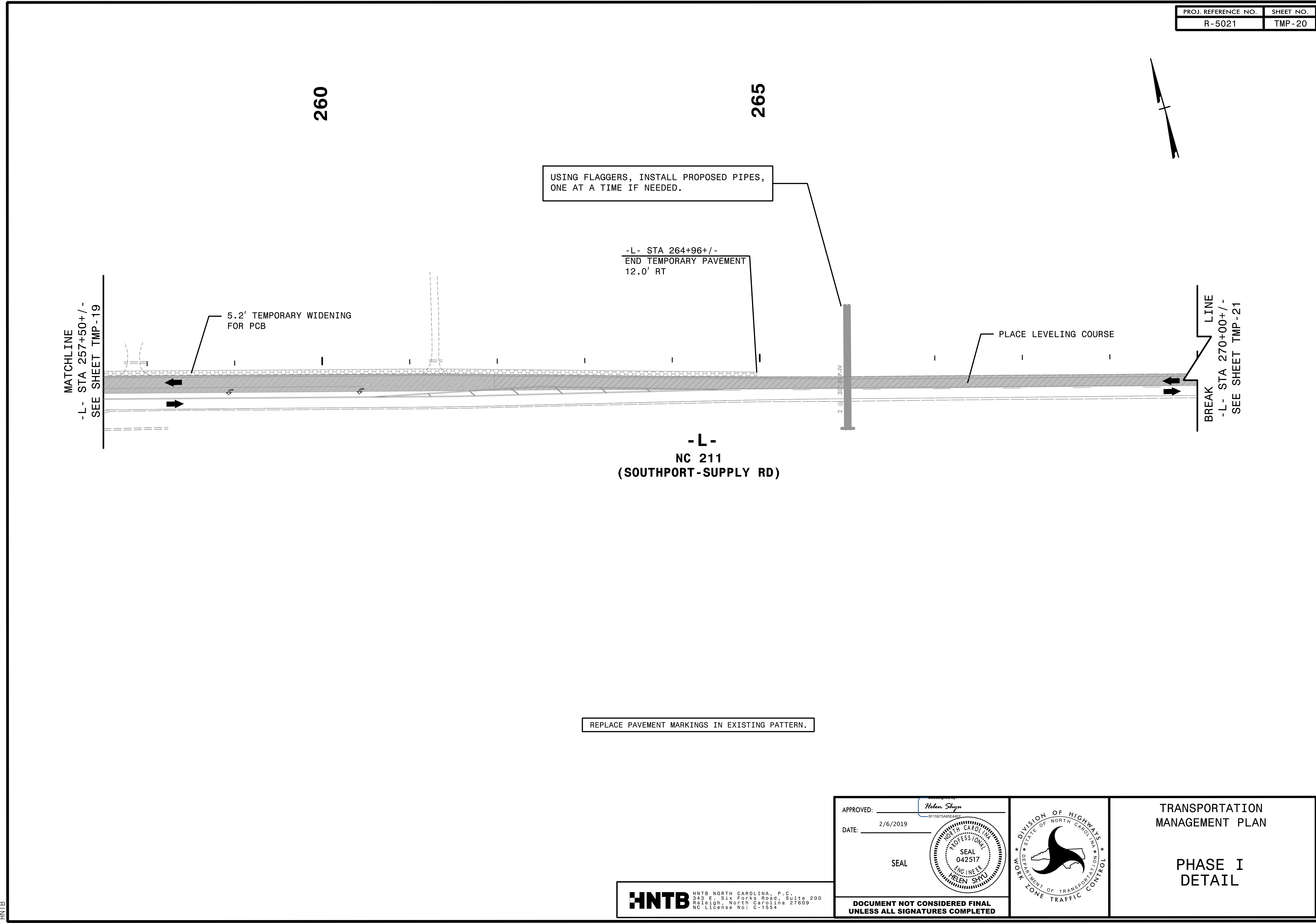

2/6/2019
 HNTB
 C:\CP\5021\TC_pid13.dgn

HNTB HNTB NORTH CAROLINA, P.C.
 343 E. Six Forks Road, Suite 200
 Raleigh, North Carolina 27609
 NC License No: C-1554

APPROVED: *Helen Skyy*
OF 1987549934632
 DATE: 2/6/2019
 SEAL
 PROFESSIONAL SEAL
 042517
 ENGINEER
 HELEN SKYY

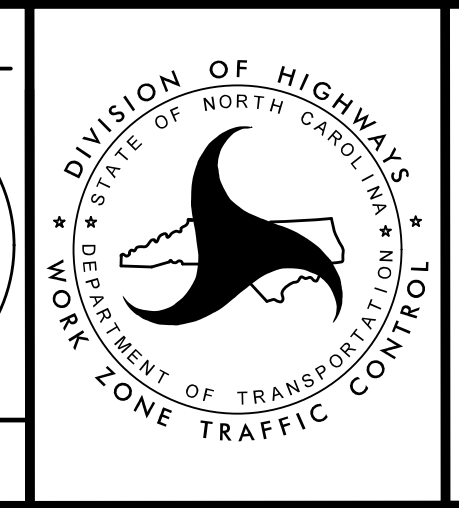

TRANSPORTATION
 MANAGEMENT PLAN
 PHASE I
 DETAIL

**DOCUMENT NOT CONSIDERED FINAL
 UNLESS ALL SIGNATURES COMPLETED**

PROJ. REFERENCE NO.	SHEET NO.
R-5021	TMP-21

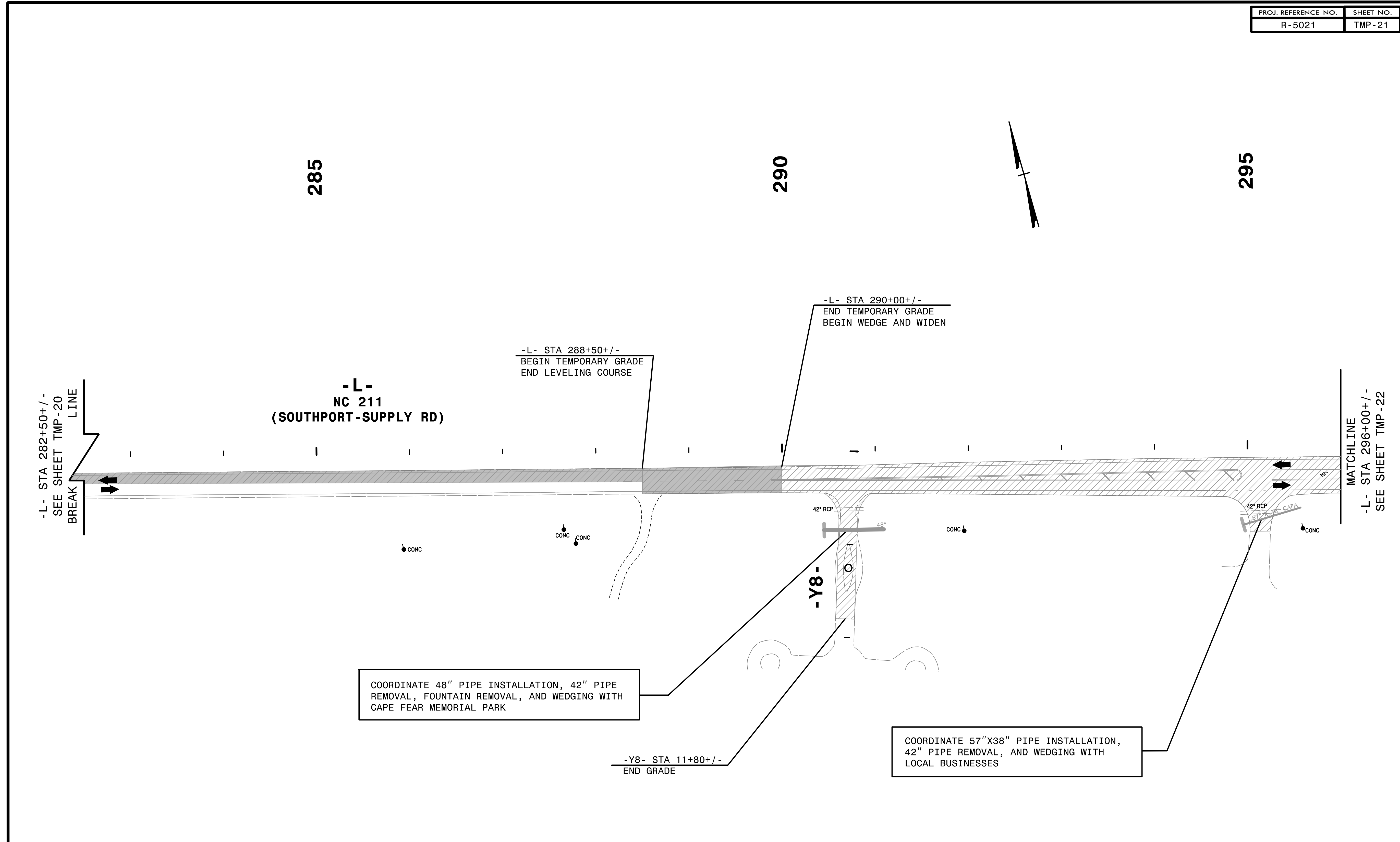

-L- STA 282+50+/-
SEE SHEET TMP-20
BREAK LINE

-L-
NC 211
(SOUTHPORT-SUPPLY RD)

-L- STA 288+50+/-
BEGIN TEMPORARY GRADE
END LEVELING COURSE

-L- STA 290+00+/-
END TEMPORARY GRADE
BEGIN WEDGE AND WIDEN

MATCHLINE
-L- STA 296+00+/-
SEE SHEET TMP-22

COORDINATE 48" PIPE INSTALLATION, 42" PIPE
REMOVAL, FOUNTAIN REMOVAL, AND WEDGING WITH
CAPE FEAR MEMORIAL PARK

-Y8- STA 11+80+/-
END GRADE

COORDINATE 57"X38" PIPE INSTALLATION,
42" PIPE REMOVAL, AND WEDGING WITH
LOCAL BUSINESSES

REPLACE PAVEMENT MARKINGS IN EXISTING PATTERN.

2/6/2019
HNTB

HNTB HNTB NORTH CAROLINA, P.C.
343 E. Six Forks Road, Suite 200
Raleigh, North Carolina 27609
NC License No: C-1554

APPROVED: *Helen Skyy*
DATE: 2/6/2019
SEAL
NORTH CAROLINA PROFESSIONAL ENGINEER SEAL 042517 HELEN SKYY

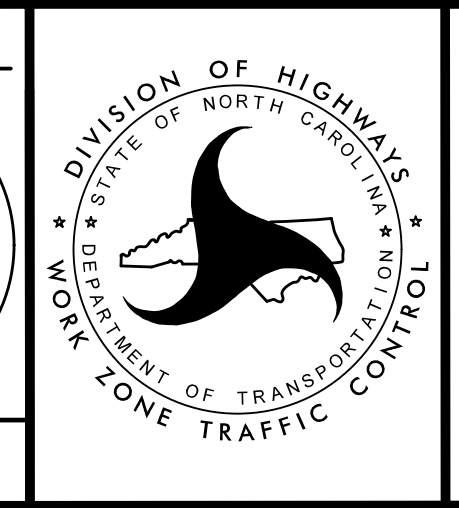

TRANSPORTATION
MANAGEMENT PLAN

PHASE I
DETAIL

DOCUMENT NOT CONSIDERED FINAL
UNLESS ALL SIGNATURES COMPLETED

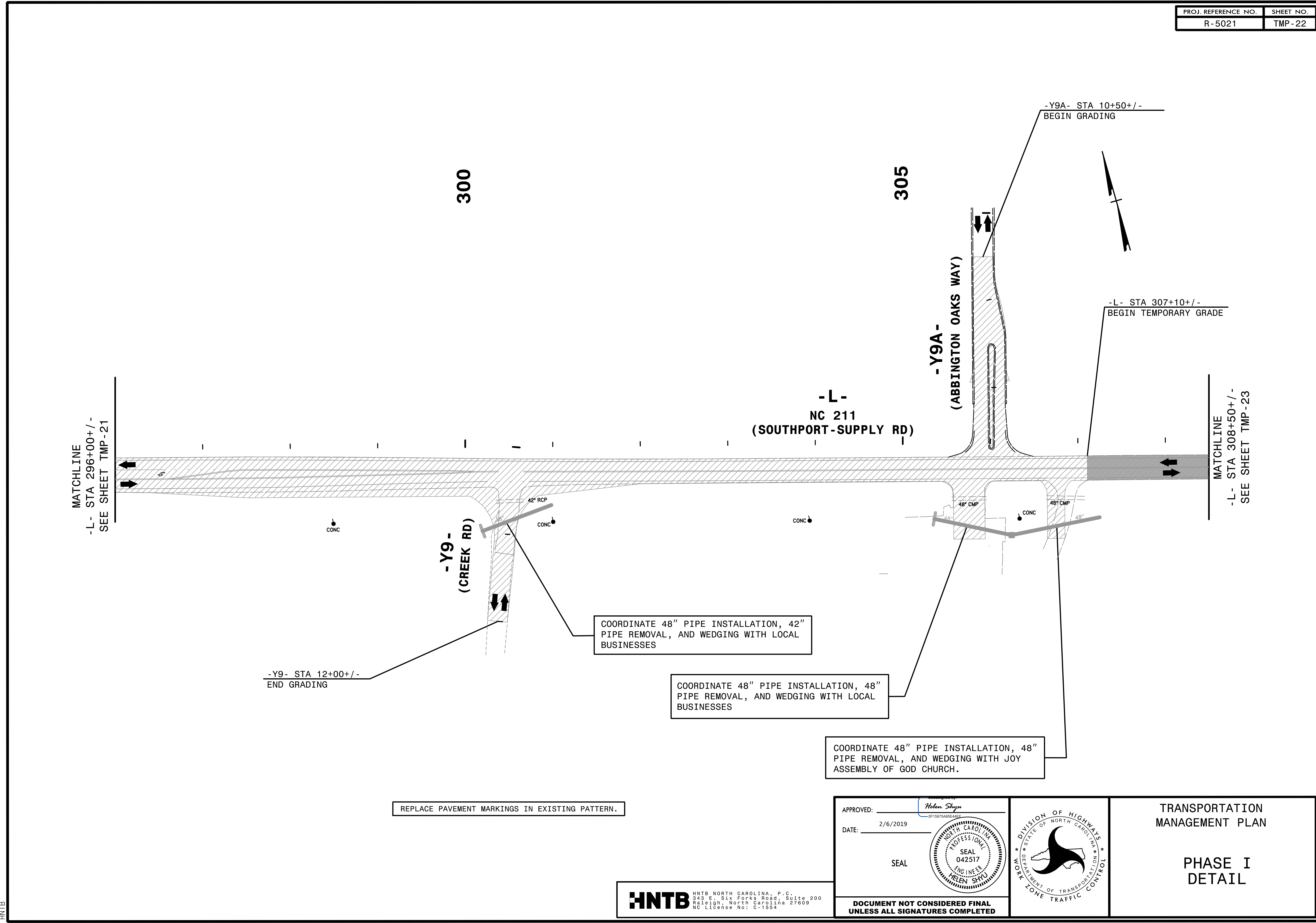

2/6/2019
HNTB

HNTB HNTB NORTH CAROLINA, P.C.
343 E. Six Forks Road, Suite 200
Raleigh, North Carolina 27609
NC License No: C-1554

APPROVED: *Helen Skyy*
DATE: 2/6/2019
SEAL
DOCUMENT NOT CONSIDERED FINAL
UNLESS ALL SIGNATURES COMPLETED

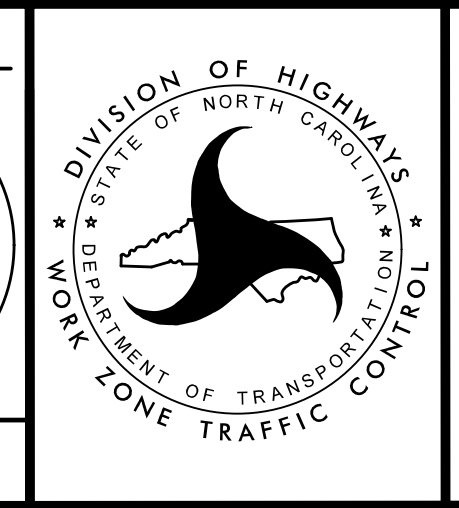

TRANSPORTATION
MANAGEMENT PLAN

PHASE I
DETAIL

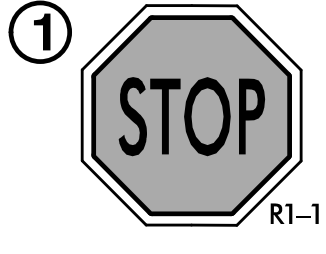

310

315

320

CONSTRUCT TEMP PAVEMENT AT EXISTING ELEVATION AND USE FLAGGERS AND TRENCHBOX TO INSTALL 48" PIPE. THEN USING FLAGGERS, WEDGE AND MILL -Y12- AND REMOVE EXCESS PAVEMENT

INSTALL TEMP GUARDRAIL. TIE INTO EXISTING GUARDRAIL AND ADJUST EXISTING GUARDRAIL AS NEEDED.

ADJUST GUARDRAIL AS NEEDED

-L- STA 315+00+/-
END LEVELING COURSE
BEGIN WIDEN AND WEDGE AT TEMP. SLOPE

-Y12- STA 12+37+/-
11.6' RT
BEGIN TEMPORARY PAVEMENT

-Y12- STA 11+55+/-
END GRADE

-Y12- STA 12+86+/-
32.0' RT

-L- STA 318+26+/-
32.7' LT

-L- STA 317+95+/-
18.32' LT
END TEMPORARY PAVEMENT

-L- STA 308+82+/-
END TEMPORARY GRADE
BEGIN LEVELING COURSE

-L- STA 310+47+/-
BEGIN TEMP. PAVEMENT

MATCHLINE
-L- STA 308+50+/-
SEE SHEET TMP-22

-L- STA 321+00+/-
END WEDGING

MATCHLINE
-L- STA 321+50+/-
SEE SHEET TMP-24

-L-
NC 211
(SOUTHPORT-SUPPLY RD)

TEMPORARY PAVEMENT
USED TO INSTALL DRAINAGE

INSTALL TEMPORARY GUARDRAIL WITH
ADDITIONAL POSTS AS REQUIRED PER
RSD 862.01 SHEET 1 OF 12"

STEEL PLATE
REQUIRED

-Y10-
(PATRICK NEWTON DR)

COORDINATE 54" PIPE INSTALLATION
WITH LOCAL BUSINESS

COORDINATE 54" PIPE INSTALLATION
WITH SAINT PETER EVANGELICAL
LUTHERAN CHURCH

CONSTRUCT TEMPORARY
PAVEMENT AT EXISTING
ELEVATION TIE INTO
TEMPORARY DITCH

-Y11- STA 314+88.5+/-
55' RT

-Y11- STA 10+95+/-
31.6' RT

-Y11- STA 12+17+/-

-Y11- STA 12+75+/-
9.3' RT END TEMP PAVEMENT

-Y11- STA 13+25+/-
END GRADE

CONSTRUCT TEMP PAVEMENT AT
EXISTING ELEVATION AND USING FLAGGERS
AND TRENCHBOX, INSTALL 54" CAAP.
WEDGE AT -Y11- TO MINIMUM FILL
HEIGHT. REMOVE EXCESS PAVEMENT

ADD TEMPORARY PIPE

-L- STA 316+40+/-
47.00' RT
BEGIN TEMPORARY PAVEMENT

-Y11- STA 10+85+/-
35.00' LT

-Y11- STA 13+10+/-
14.2' LT
END TEMPORARY PAVEMENT

SEE EC-23A/CONST.23
FOR CULVERT PHASING

ADD QUANTITIES FOR REPLACING PAVEMENT
MARKINGS IN EXISTING PATTERN

- (AA) PLACE TEMP SHOP CURVED TEMPORARY GUARDRAIL (69') AND TEMP AT-1
- (Y) PLACE PERM GUARDRAIL AT TEMP ELEV FROM STA 313+29+/- TO STA 314+89+/- AND TEMPORARY SHOP CURVED GUARDRAIL (40') WITH TEMP AT-1 AT TRAILING END.
- (Z) PLACE PERM GUARDRAIL AT TEMP ELEV FROM STA 316+41+/- TO STA 318+82+/- AND TEMP SHOP CURVED GUARDRAIL (42') WITH AT-1 AT APPROACH.

2/6/2019
HNTB
C:\CPV\5021\to_pidit.dgn

HNTB
HNTB NORTH CAROLINA, P.C.
343 E. Six Forks Road, Suite 200
Raleigh, North Carolina 27609
NC License No: C-1554

APPROVED: *Helen Skyy*
DATE: 2/6/2019
SEAL
DOCUMENT NOT CONSIDERED FINAL
UNLESS ALL SIGNATURES COMPLETED

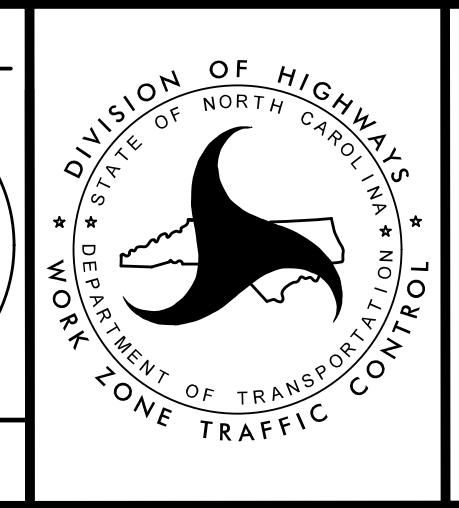

TRANSPORTATION
MANAGEMENT PLAN

PHASE I
DETAIL

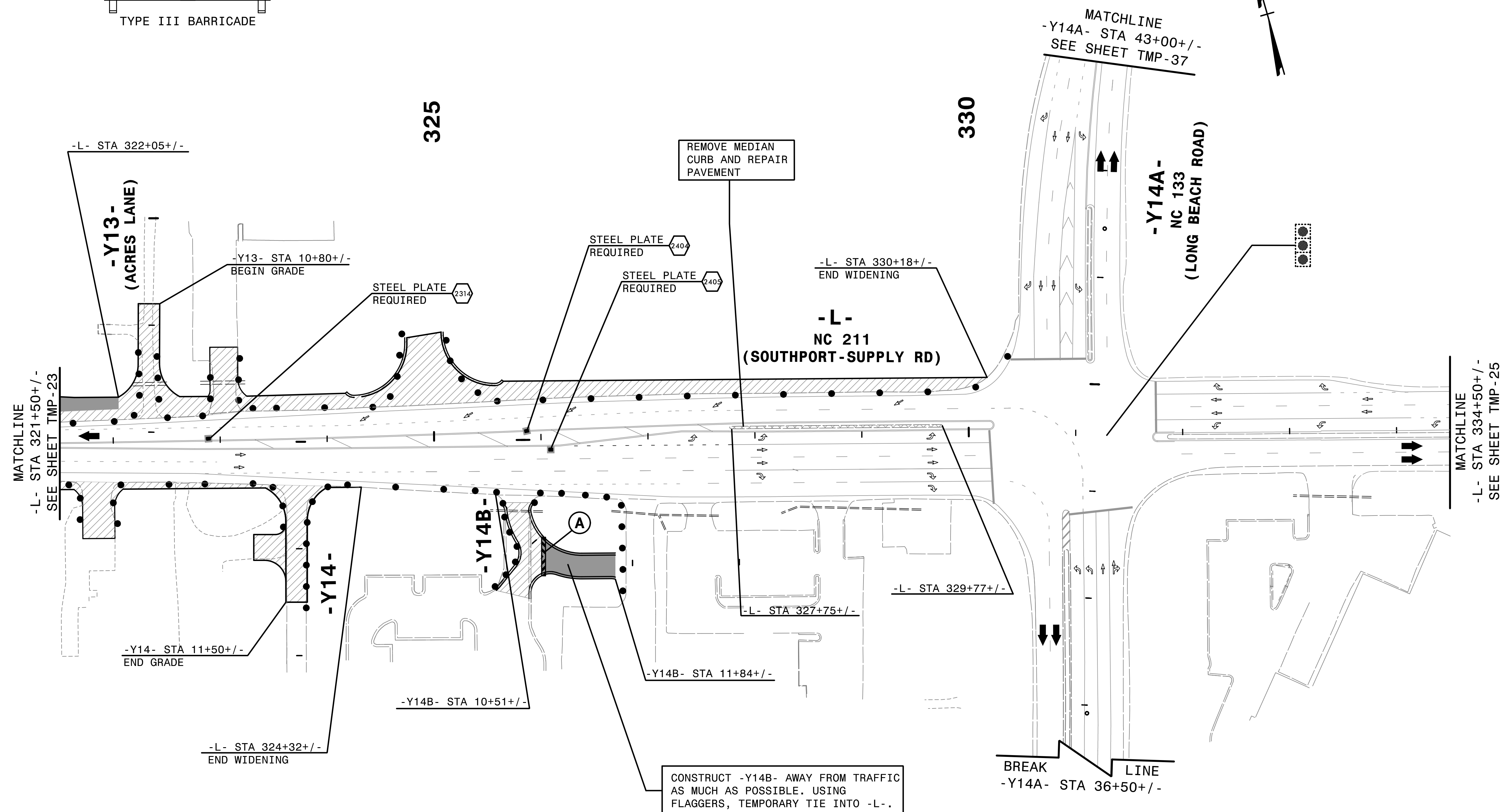
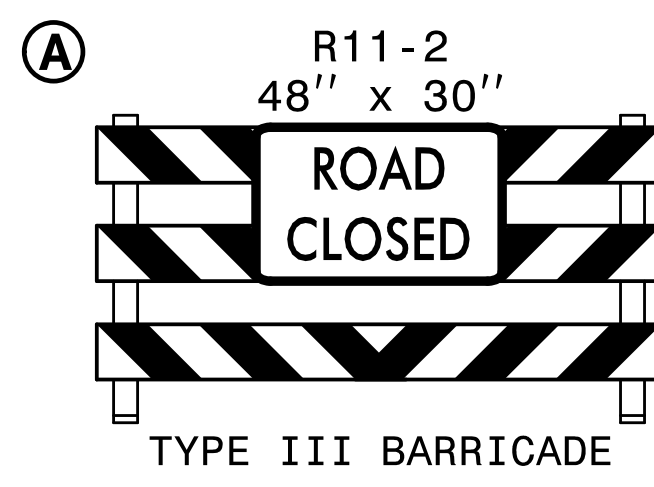

REPLACE PAVEMENT MARKING IN EXISTING PATTERN.

2/6/2019
HNTB

HNTB
HNTB NORTH CAROLINA, P.C.
343 E. Six Forks Road, Suite 200
Raleigh, North Carolina 27609
NC License No: C-1554

APPROVED: *Helen Skyy*
DATE: 2/6/2019
SEAL
DOCUMENT NOT CONSIDERED FINAL
UNLESS ALL SIGNATURES COMPLETED

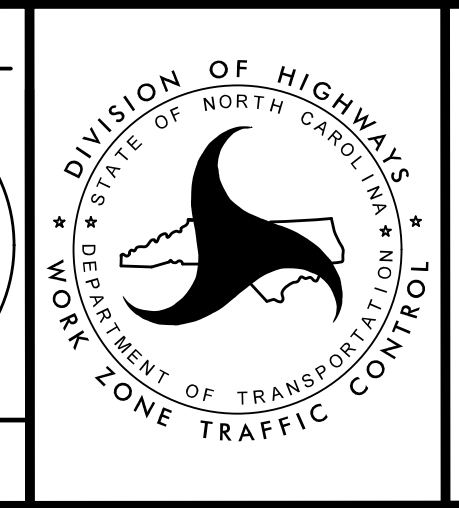

TRANSPORTATION
MANAGEMENT PLAN
PHASE I
DETAIL

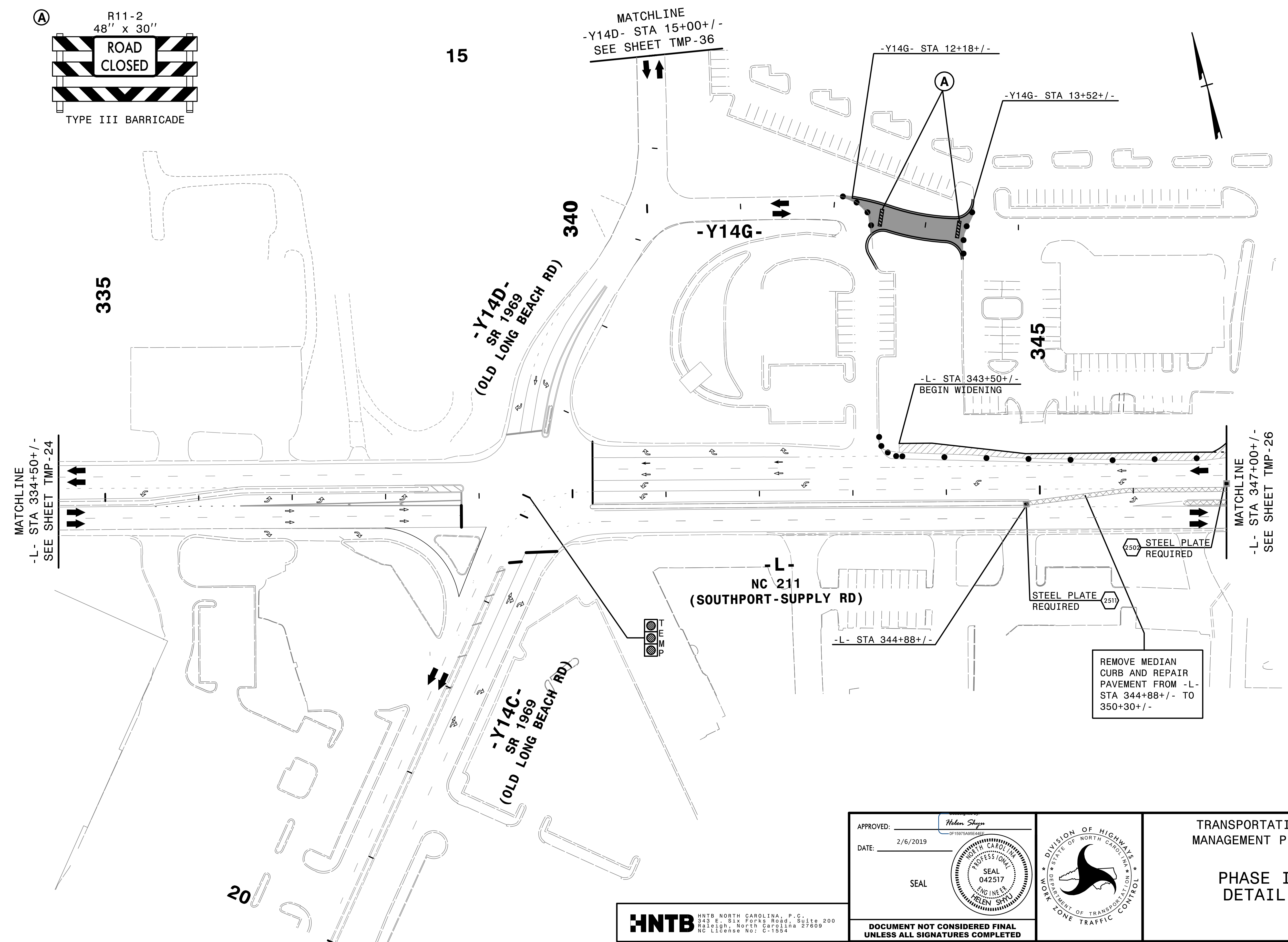
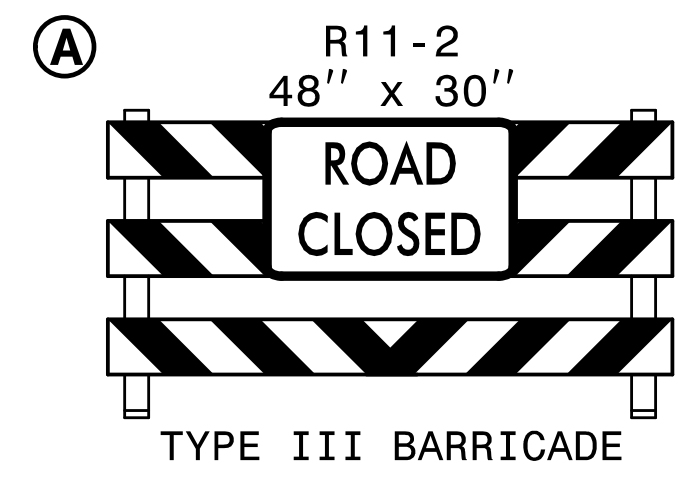

2/6/2019
TCPLV-5021.tc_pid19.dgn
HNTB

HNTB
HNTB NORTH CAROLINA, P.C.
343 E. Six Forks Road, Suite 200
Raleigh, North Carolina 27609
NC License No: C-1554

APPROVED: *Helen Skyy*
DATE: 2/6/2019
SEAL
HNTB NORTH CAROLINA
PROFESSIONAL
SEAL
042517
ENGINEER
HELEN SKYY

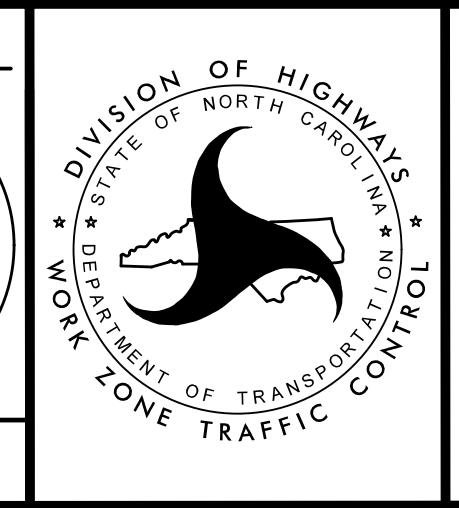

TRANSPORTATION
MANAGEMENT PLAN

PHASE I
DETAIL

DOCUMENT NOT CONSIDERED FINAL
UNLESS ALL SIGNATURES COMPLETED

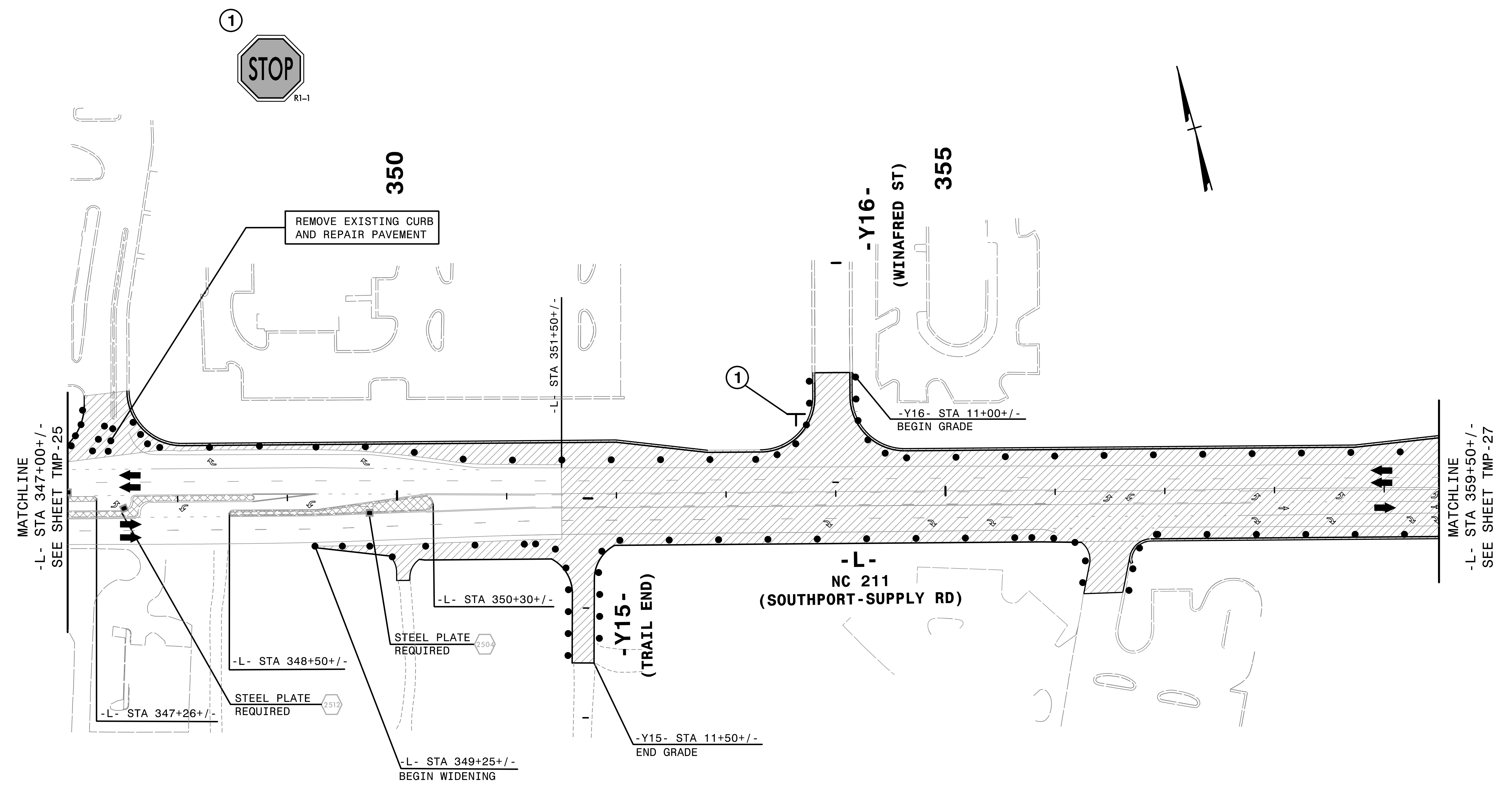

REPLACE PAVEMENT MARKINGS IN EXISTING PATTERN.

2/6/2019
HNTB

HNTB
 HNTB NORTH CAROLINA, P.C.
 343 E. Six Forks Road, Suite 200
 Raleigh, North Carolina 27609
 NC License No: C-1554

APPROVED: *Helen Skye*
OR 1987549934
 DATE: 2/6/2019
 SEAL

 DOCUMENT NOT CONSIDERED FINAL
 UNLESS ALL SIGNATURES COMPLETED

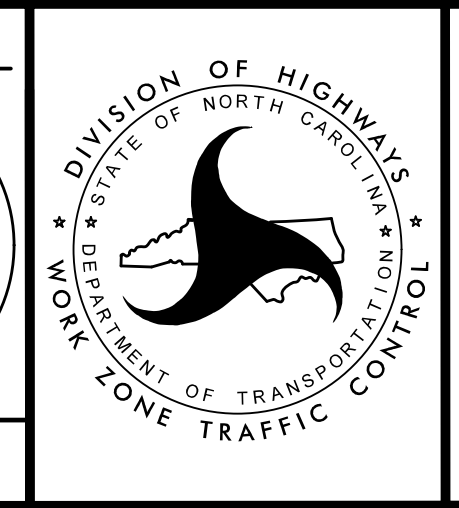

TRANSPORTATION
 MANAGEMENT PLAN

 PHASE I
 DETAIL

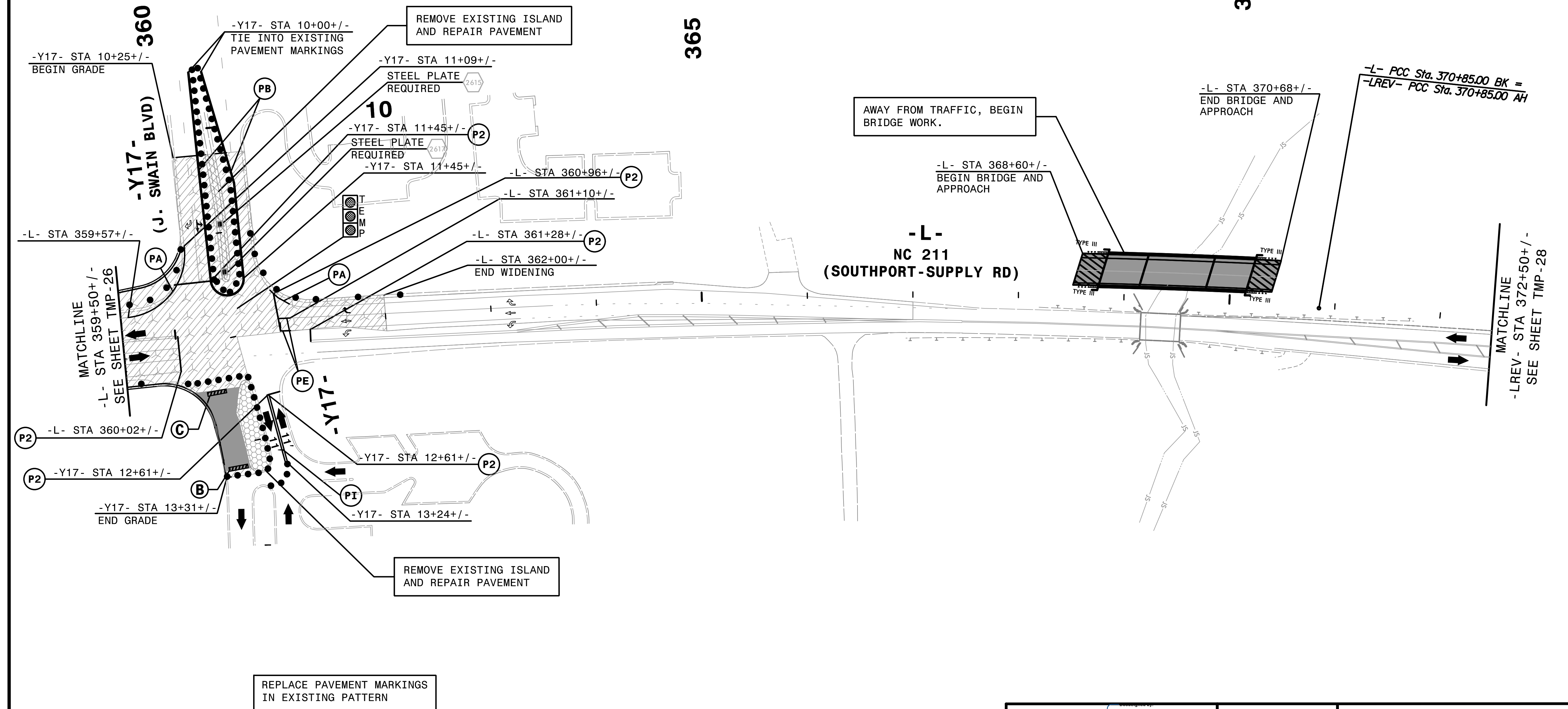
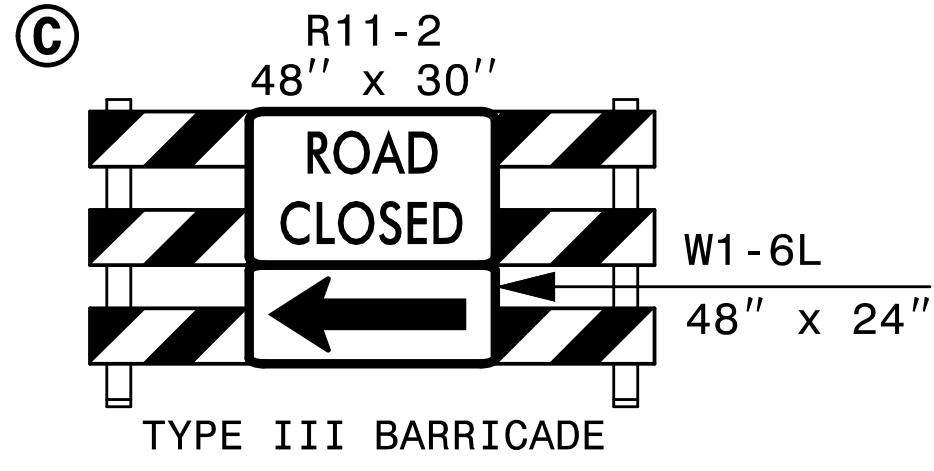
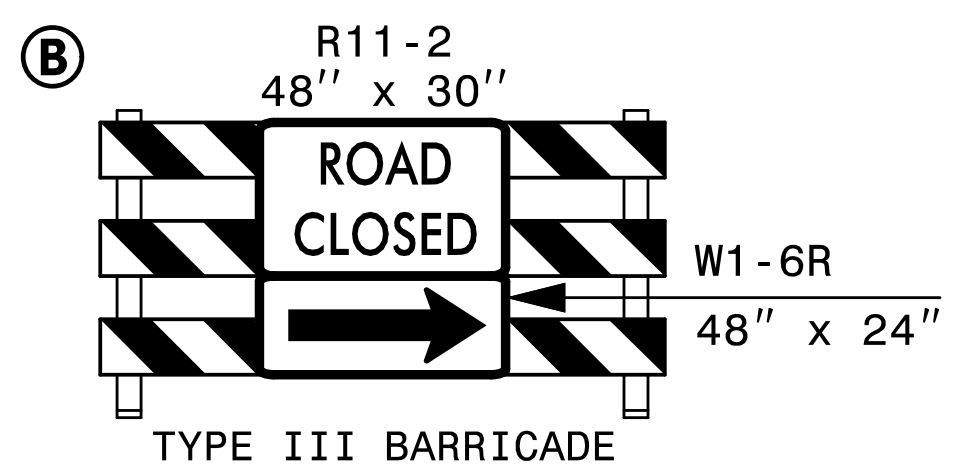

2/6/2019
HNTB

HNTB HNTB NORTH CAROLINA, P.C.
343 E. Six Forks Road, Suite 200
Raleigh, North Carolina 27609
NC License No: C-1554

APPROVED: *Helen Skyy*
DATE: 2/6/2019
SEAL
DOCUMENT NOT CONSIDERED FINAL
UNLESS ALL SIGNATURES COMPLETED

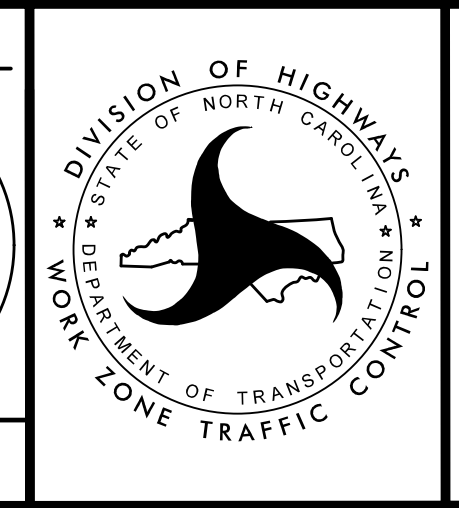

TRANSPORTATION
MANAGEMENT PLAN

PHASE I
DETAIL

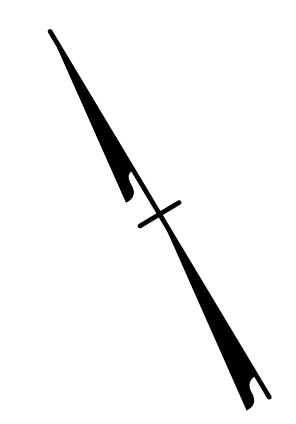
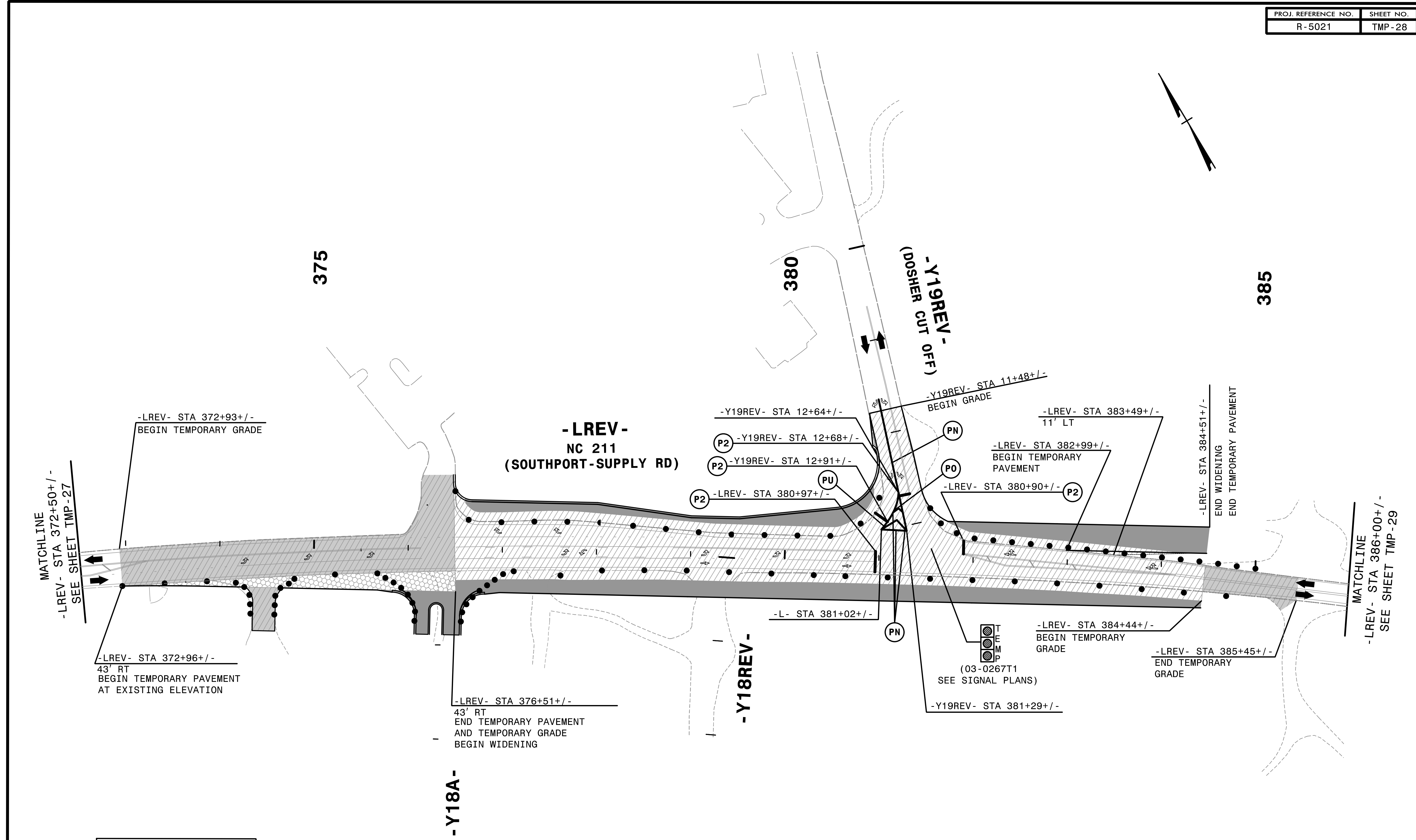

4:52:35 PM
\\TC\p\5021\c\p\d22.dgn
\$\$\$\$\$USERNAME\$\$\$\$\$

REPLACE PAVEMENT MARKINGS
IN EXISTING PATTERN

HNTB HNTB NORTH CAROLINA, P.C.
343 E. SIX FORKS ROAD, SUITE 200
RALEIGH, NORTH CAROLINA 27609
NC LICENSE NO: C-1554

APPROVED: *Helen Shyne*
DATE: 9/9/2021

SEAL

DOCUMENT NOT CONSIDERED FINAL
UNLESS ALL SIGNATURES COMPLETED

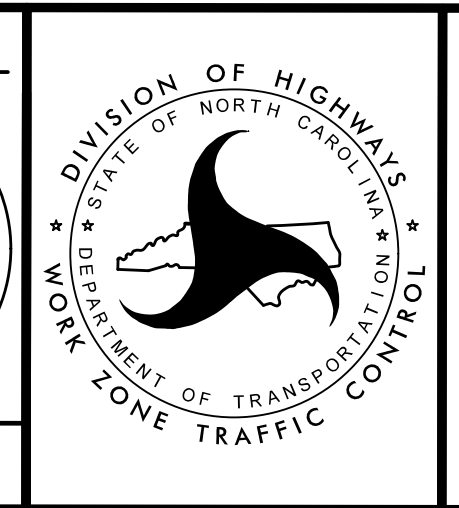

TRANSPORTATION
MANAGEMENT PLAN

PHASE I
DETAIL

DIVISION OF HIGHWAYS
STATE OF NORTH CAROLINA
DEPARTMENT OF TRANSPORTATION
ZONE TRAFFIC CONTROL

PROJ. REFERENCE NO.	SHEET NO.
R-5021	TMP-29

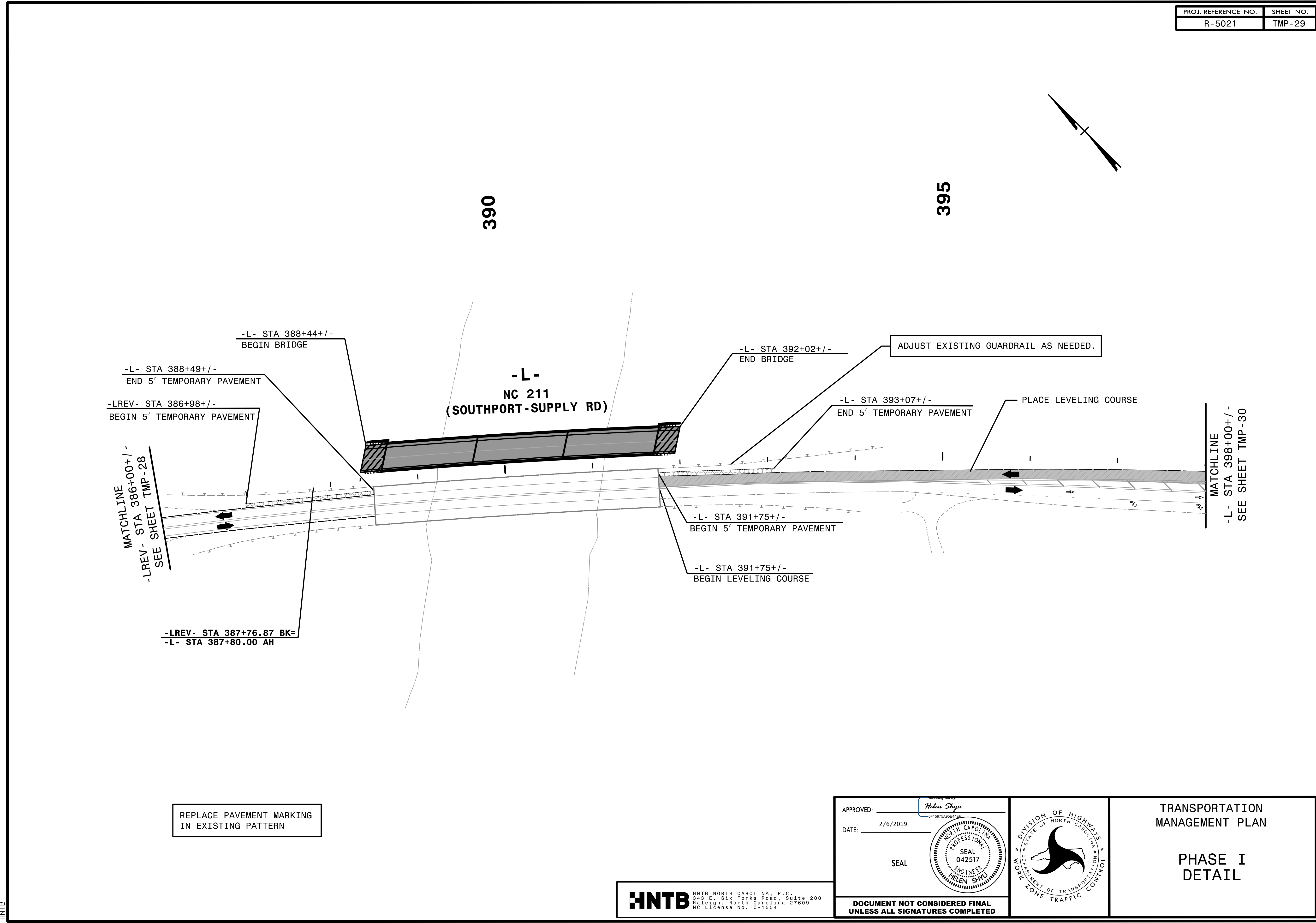

2/6/2019
 HNTB
 C:\CP\5021\10_pid23.dgn

REPLACE PAVEMENT MARKING
 IN EXISTING PATTERN

HNTB
 HNTB NORTH CAROLINA, P.C.
 343 E. Six Forks Road, Suite 200
 Raleigh, North Carolina 27609
 NC License No: C-1554

APPROVED: *Helen Skyy*
 DATE: 2/6/2019
 SEAL
 PROFESSIONAL SEAL
 ENGINEER
 HELEN SKYY
 OF 1987SAPPLICABLE

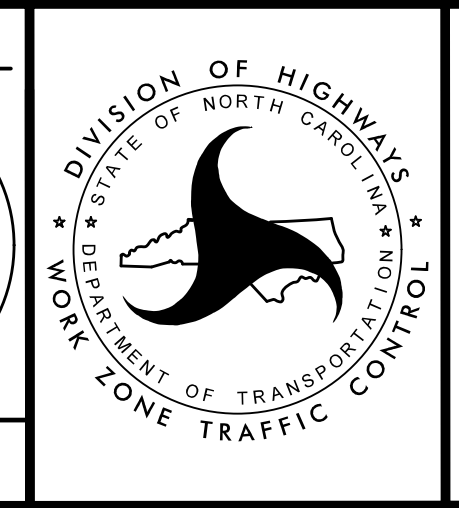

TRANSPORTATION
 MANAGEMENT PLAN

 PHASE I
 DETAIL

DOCUMENT NOT CONSIDERED FINAL
 UNLESS ALL SIGNATURES COMPLETED

PROJ. REFERENCE NO.	SHEET NO.
R-5021	TMP-30

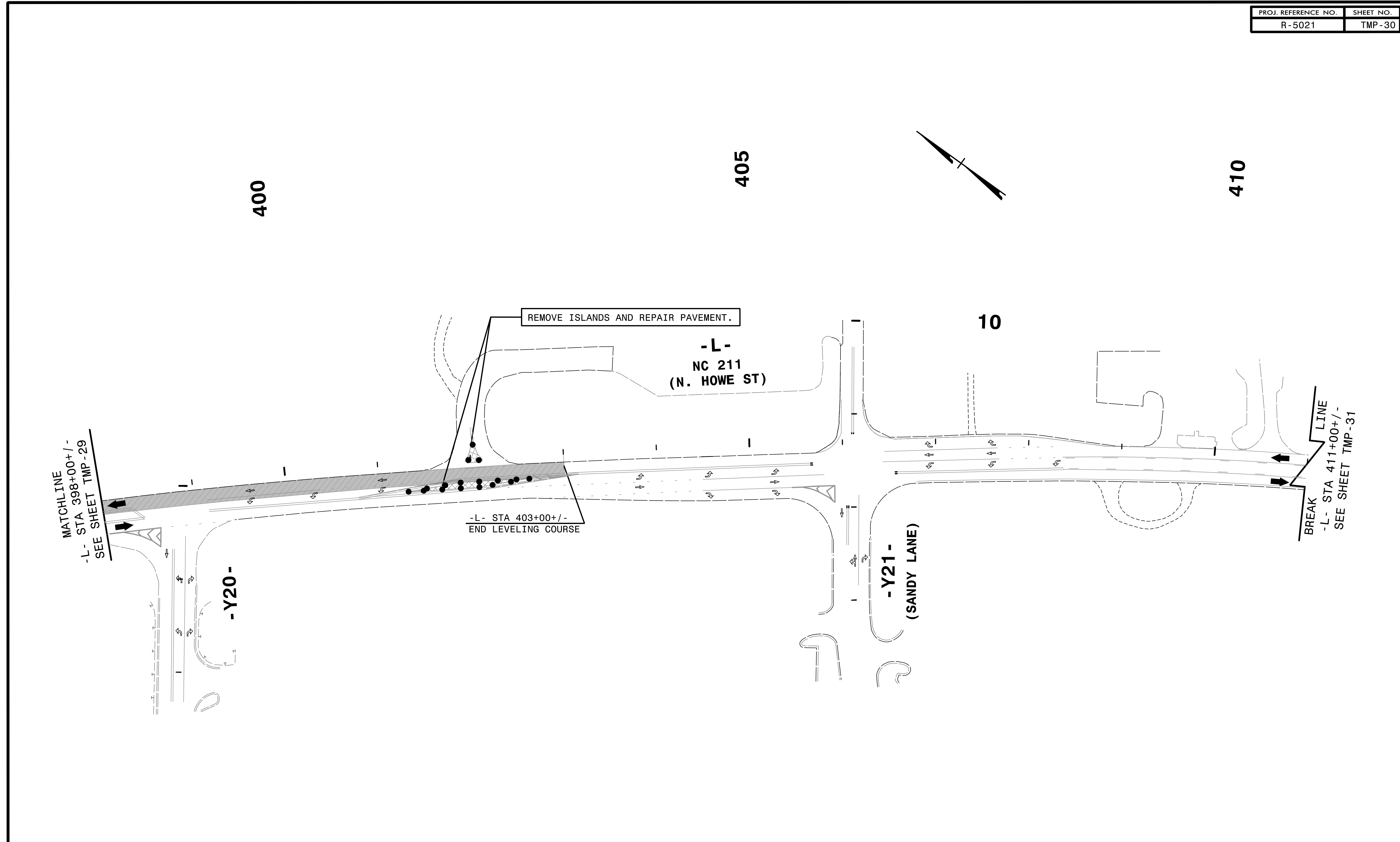

2/6/2019
 C:\CP\5021\TC_pid24.dgn
 HNTB

REPLACE PAVEMENT MARKING
 IN EXISTING PATTERN

HNTB HNTB NORTH CAROLINA, P.C.
 343 E. Six Forks Road, Suite 200
 Raleigh, North Carolina 27609
 NC License No: C-1554

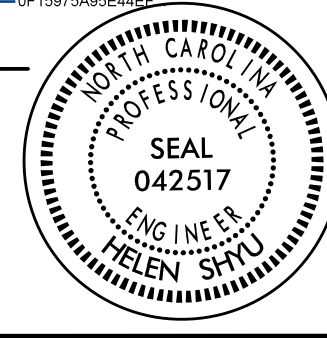
APPROVED: *Helen Skyy*
OF 1987SAPPLICABLE
 DATE: 2/6/2019
 SEAL

 DOCUMENT NOT CONSIDERED FINAL
 UNLESS ALL SIGNATURES COMPLETED

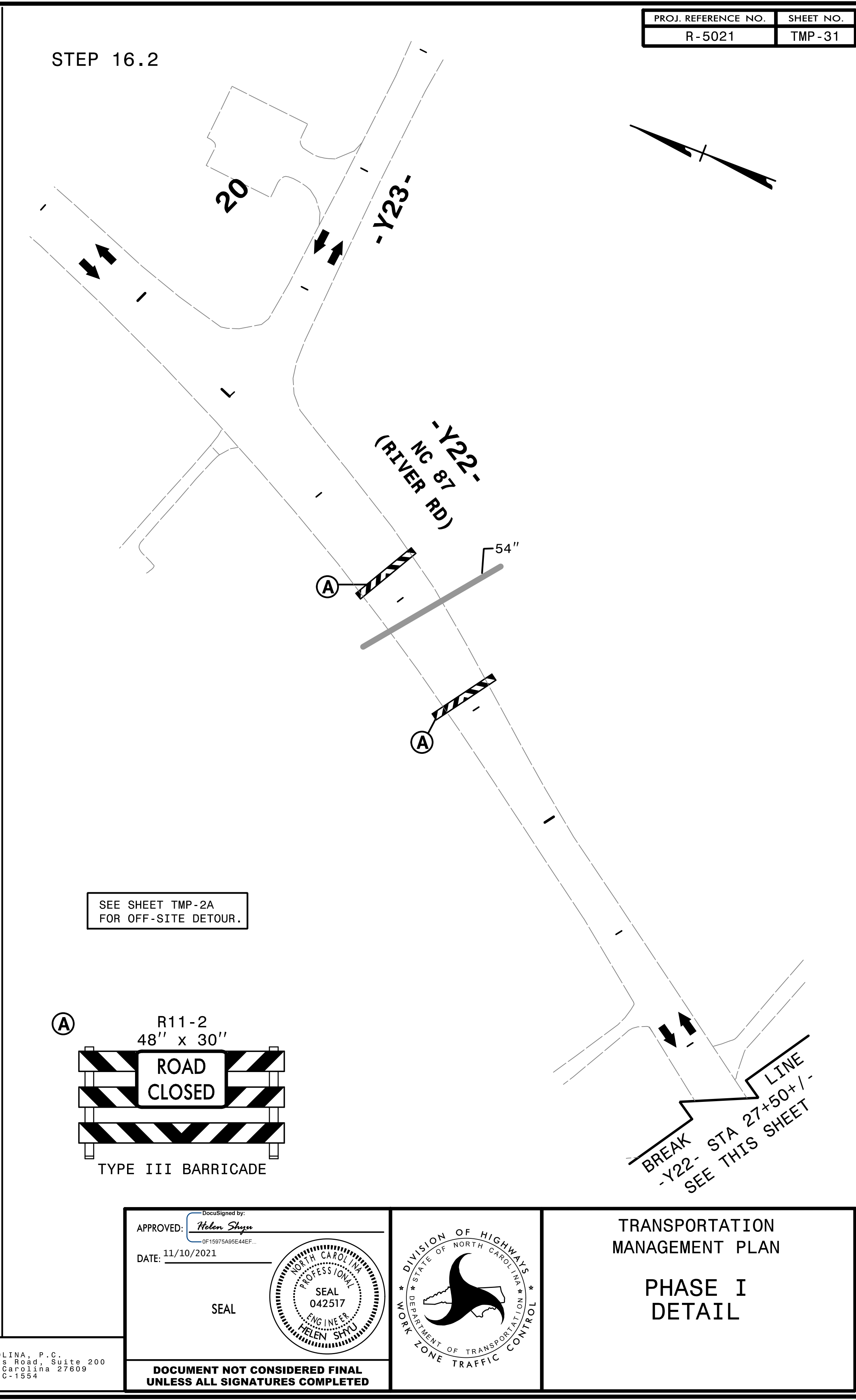
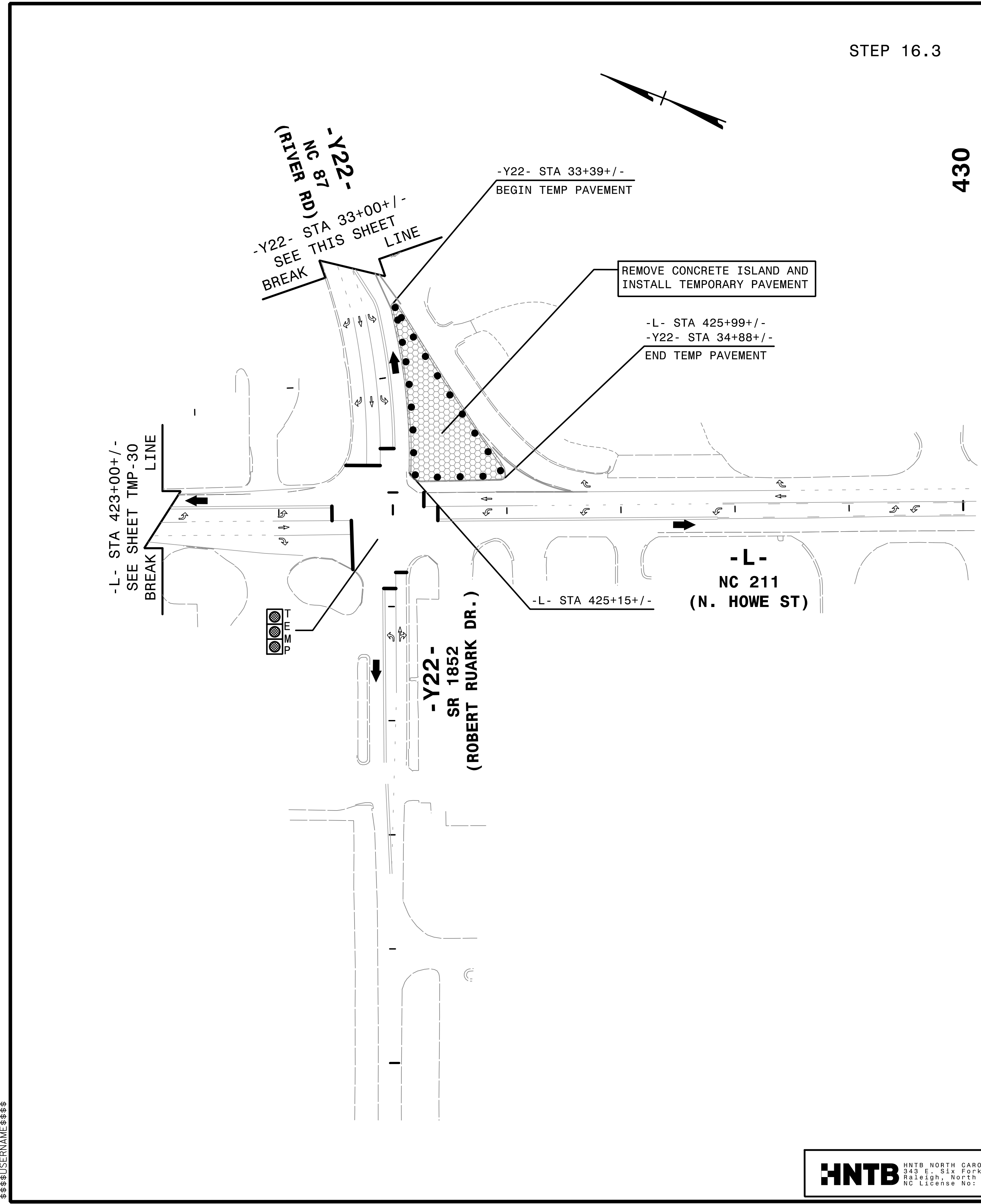

 DIVISION OF HIGHWAYS
 DEPARTMENT OF TRANSPORTATION
 STATE OF NORTH CAROLINA
 WORK ZONE TRAFFIC CONTROL

TRANSPORTATION
 MANAGEMENT PLAN
 PHASE I
 DETAIL

4:56:05 PM
\\TCPL15021\cpl\d26.dgn
\$\$\$\$\$USERNAME\$\$\$\$\$

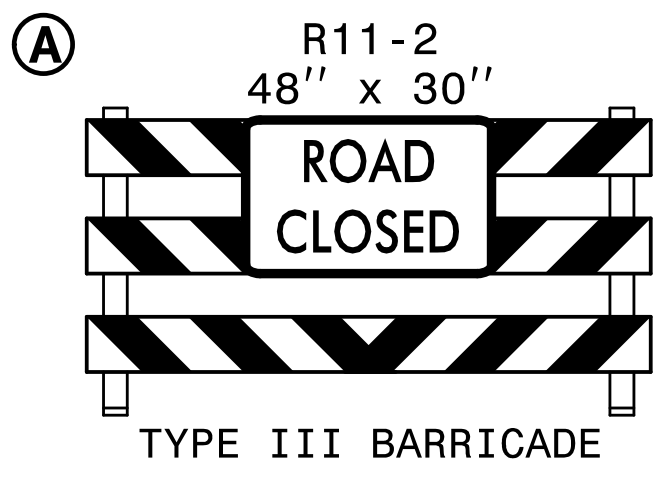

SEE SHEET TMP-2A
FOR OFF-SITE DETOUR.



HNTB HNTB NORTH CAROLINA, P.C.
343 E. Six Forks Road, Suite 200
Raleigh, North Carolina 27609
NC License No: C-1554

APPROVED: *Helen Shyu*
DATE: 11/10/2021
SEAL
DOCUMENT NOT CONSIDERED FINAL
UNLESS ALL SIGNATURES COMPLETED

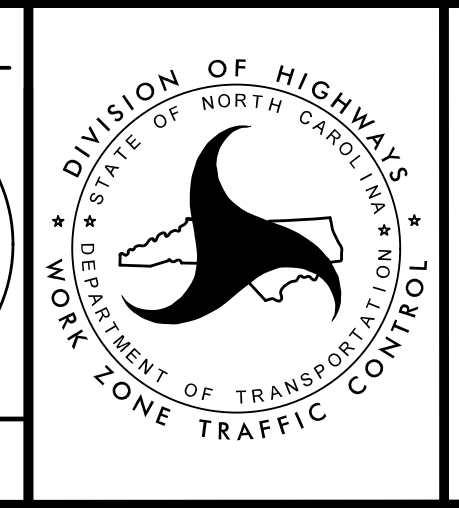

TRANSPORTATION
MANAGEMENT PLAN

PHASE I
DETAIL

PROJ. REFERENCE NO.	SHEET NO.
R-5021	TMP-32

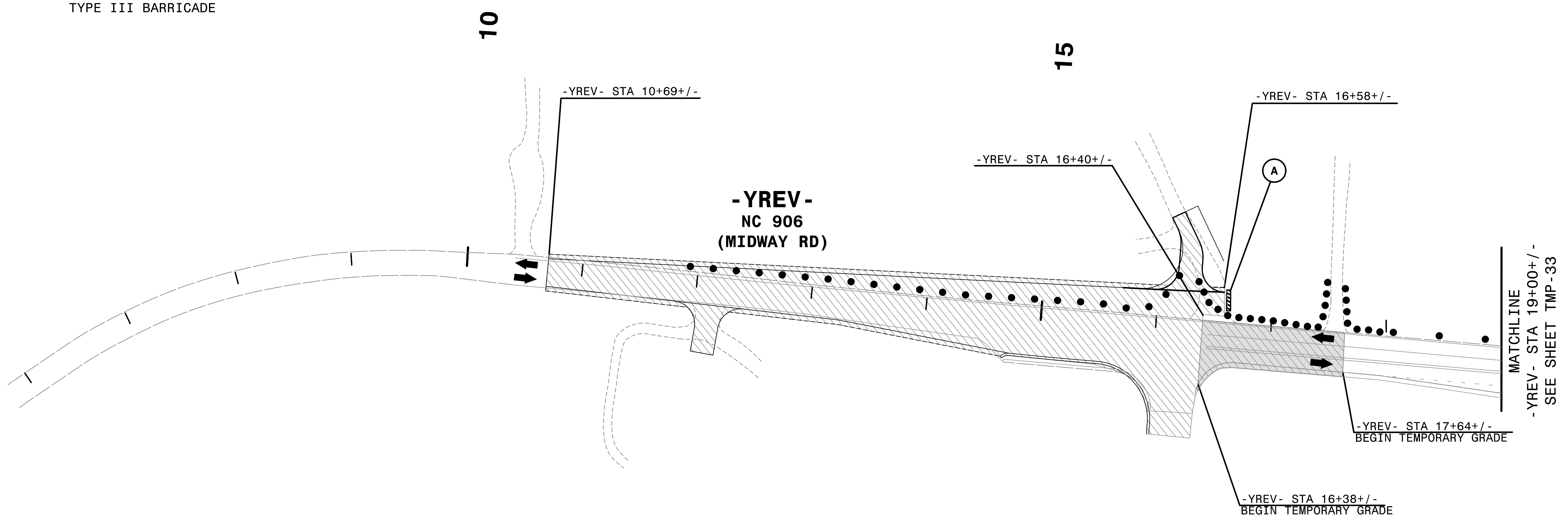
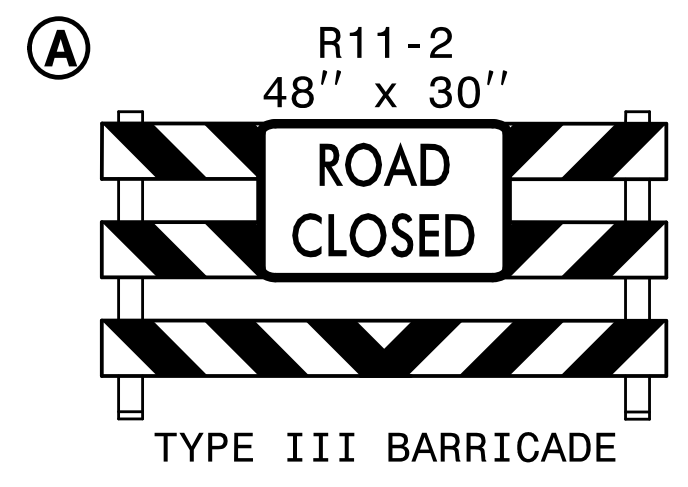

REPLACE PAVEMENT MARKINGS IN EXISTING PATTERN

4:52:38 PM
\\TCPS\F5021\TC_pid27.dgn
\$\$\$\$\$USERNAME\$\$\$\$\$

HNTB HNTB NORTH CAROLINA, P.C.
343 E. Six Forks Road, Suite 200
Raleigh, North Carolina 27609
NC License No: C-1554

APPROVED: *Helen Shyu*
DATE: 9/9/2021

SEAL

PROFESSIONAL SEAL
042517
ENGINEER
HELEN SHYU

DOCUMENT NOT CONSIDERED FINAL
UNLESS ALL SIGNATURES COMPLETED

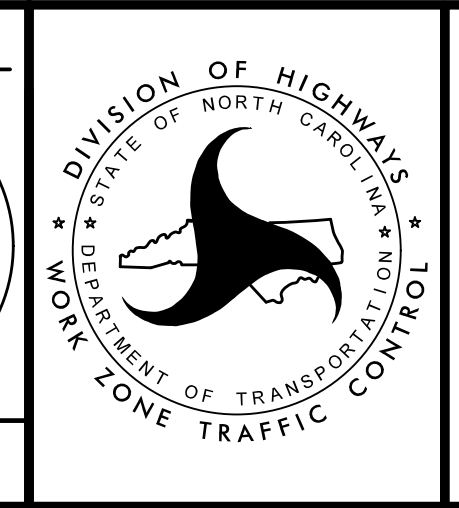

TRANSPORTATION
MANAGEMENT PLAN

PHASE I
DETAIL

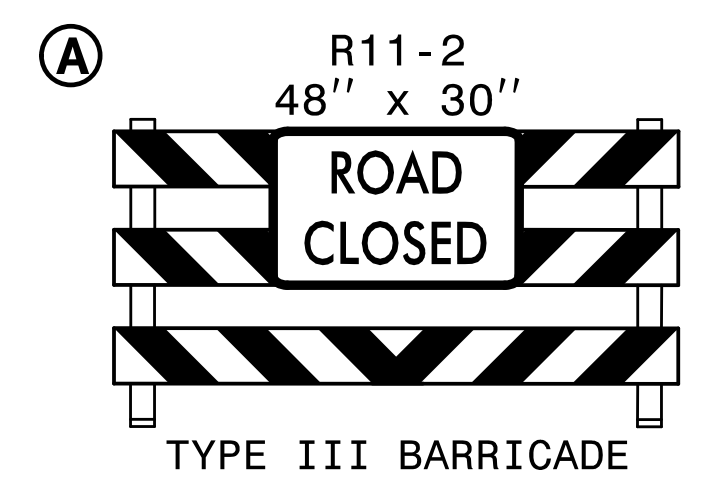
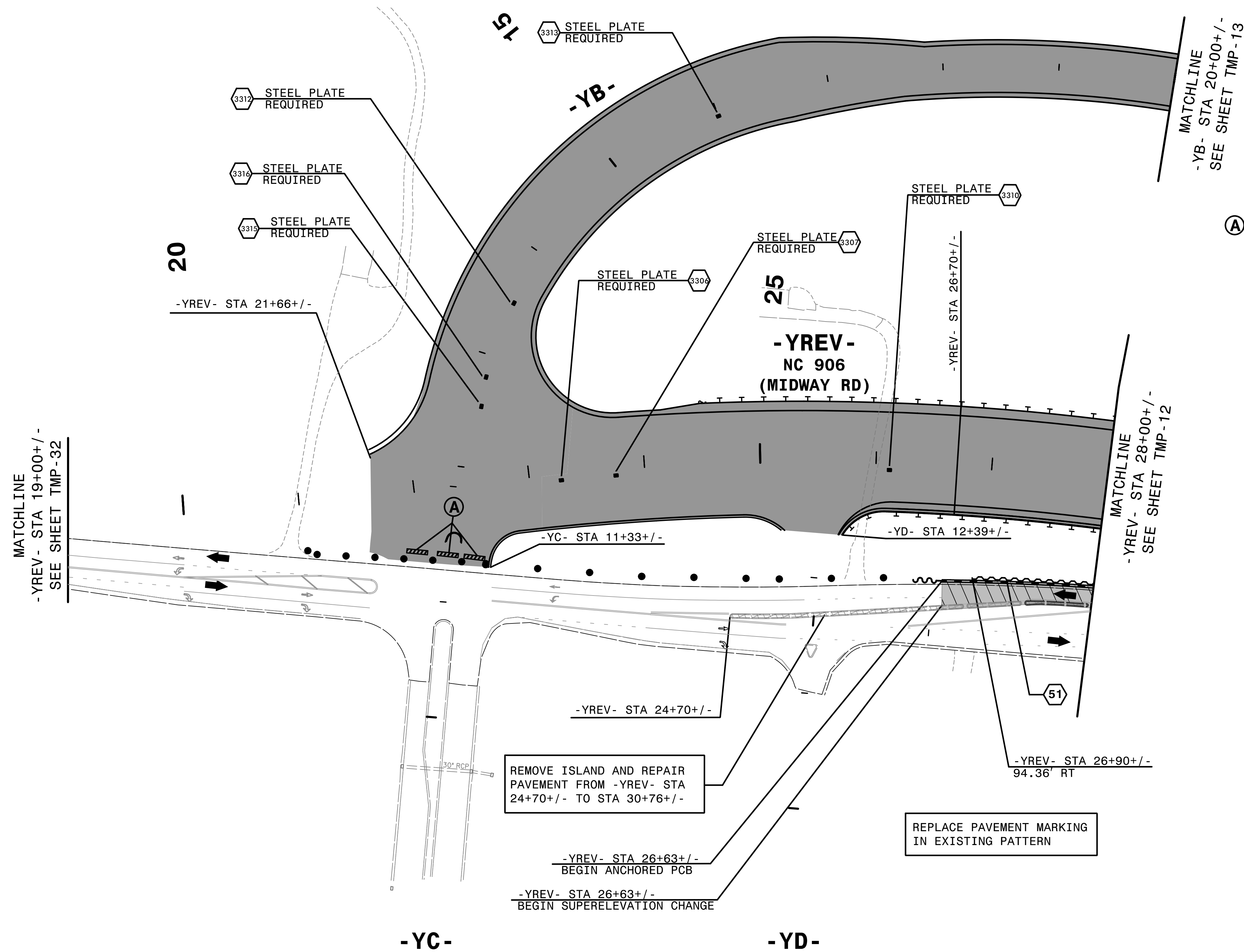

51 EST QUANTITY = 3380 SF

TEMPORARY SHORING
 FROM -YREV- STA 26+90.07+/-, 94.36' RT
 TO -YREV- STA 28+41.36, 86.36' RT
 FROM -YREV- STA 28+41.36, 86.36' RT
 TO -YREV- STA 30+37.27+/-, 65.17' RT
 (SEE SHEET TMP-2G FOR
 TEMPORARY SHORING NOTES)

4:52:42 PM
 \\TCFV1502L1\cpl\d28.dgn
 \$\$\$USERNAME\$\$\$

HNTB HNTB NORTH CAROLINA, P.C.
 343 E. Six Forks Road, Suite 200
 Raleigh, North Carolina 27609
 NC License No: C-1554

APPROVED: *Helen Shyu*
 DATE: 9/9/2021
 SEAL
 PROFESSIONAL ENGINEER
 HELEN SHYU
 042517
 0F15975A9E44EF

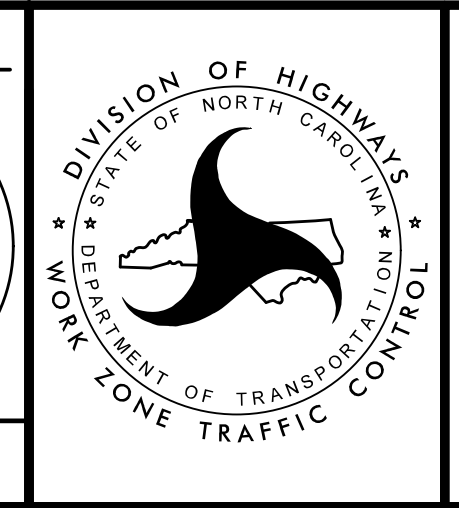

TRANSPORTATION
 MANAGEMENT PLAN

PHASE I
 DETAIL

DOCUMENT NOT CONSIDERED FINAL
 UNLESS ALL SIGNATURES COMPLETED

35

40

45

-YREV-
NC 906
(MIDDLETON BLVD)

MATCHLINE
-YREV- STA 35+00+/-
SEE SHEET TMP-12

-YAREV- STA 21+28+/-

20

-YAREV-

10

-YG-

MATCHLINE
-YAREV- STA 15+50+/-
SEE SHEET TMP-12

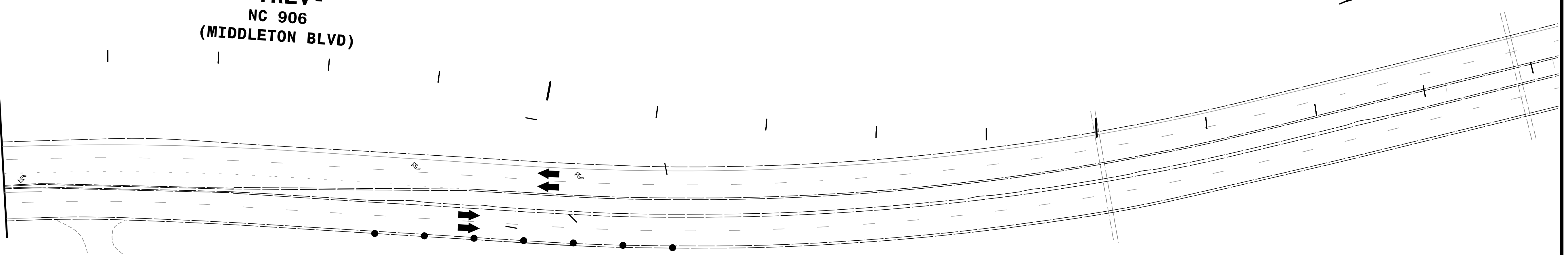
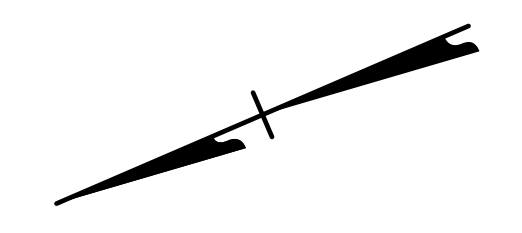

3/23/08 PM
\\TCP\...5021\...pld29.dgn
\$\$\$\$\$USERNAME\$\$\$\$\$

HNTB HNTB NORTH CAROLINA, P.C.
343 E. Six Forks Road, Suite 200
Raleigh, North Carolina 27609
NC License No: C-1554

APPROVED: *Helen Shyu*
DATE: 10/28/2021

SEAL

**DOCUMENT NOT CONSIDERED FINAL
UNLESS ALL SIGNATURES COMPLETED**

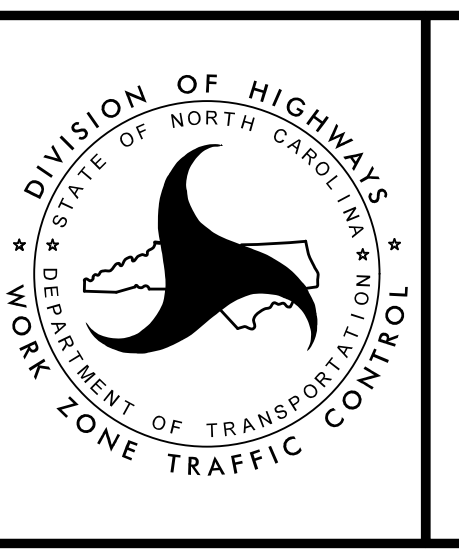

TRANSPORTATION
MANAGEMENT PLAN

PHASE I
DETAIL

PROJ. REFERENCE NO.	SHEET NO.
R-5021	TMP-35

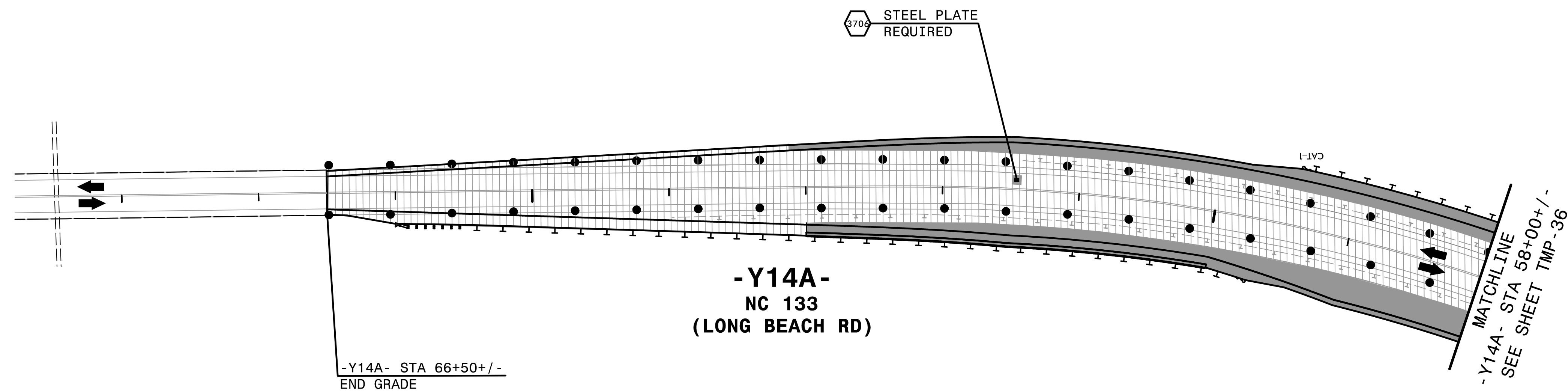

REPLACE PAVEMENT MARKING
IN EXISTING PATTERN

69

09

-Y14A-
NC 133
(LONG BEACH RD)

-Y14A- STA 66+50+/-
END GRADE

MATCHLINE
-Y14A- STA 58+00+/-
SEE SHEET TMP-36

STEEL PLATE
REQUIRED

2/6/2019
TCR-V-502L-TC-pld32.dgn
HNTB

HNTB HNTB NORTH CAROLINA, P.C.
343 E. Six Forks Road, Suite 200
Raleigh, North Carolina 27609
NC License No: C-1554

APPROVED: *Helen Shyu*
DATE: 2/6/2019

SEAL

PROFESSIONAL SEAL
042517
ENGINEER
HELEN SHYU

**DOCUMENT NOT CONSIDERED FINAL
UNLESS ALL SIGNATURES COMPLETED**

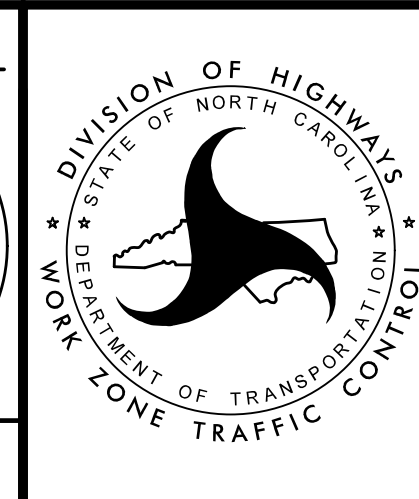

TRANSPORTATION
MANAGEMENT PLAN

PHASE I
DETAIL

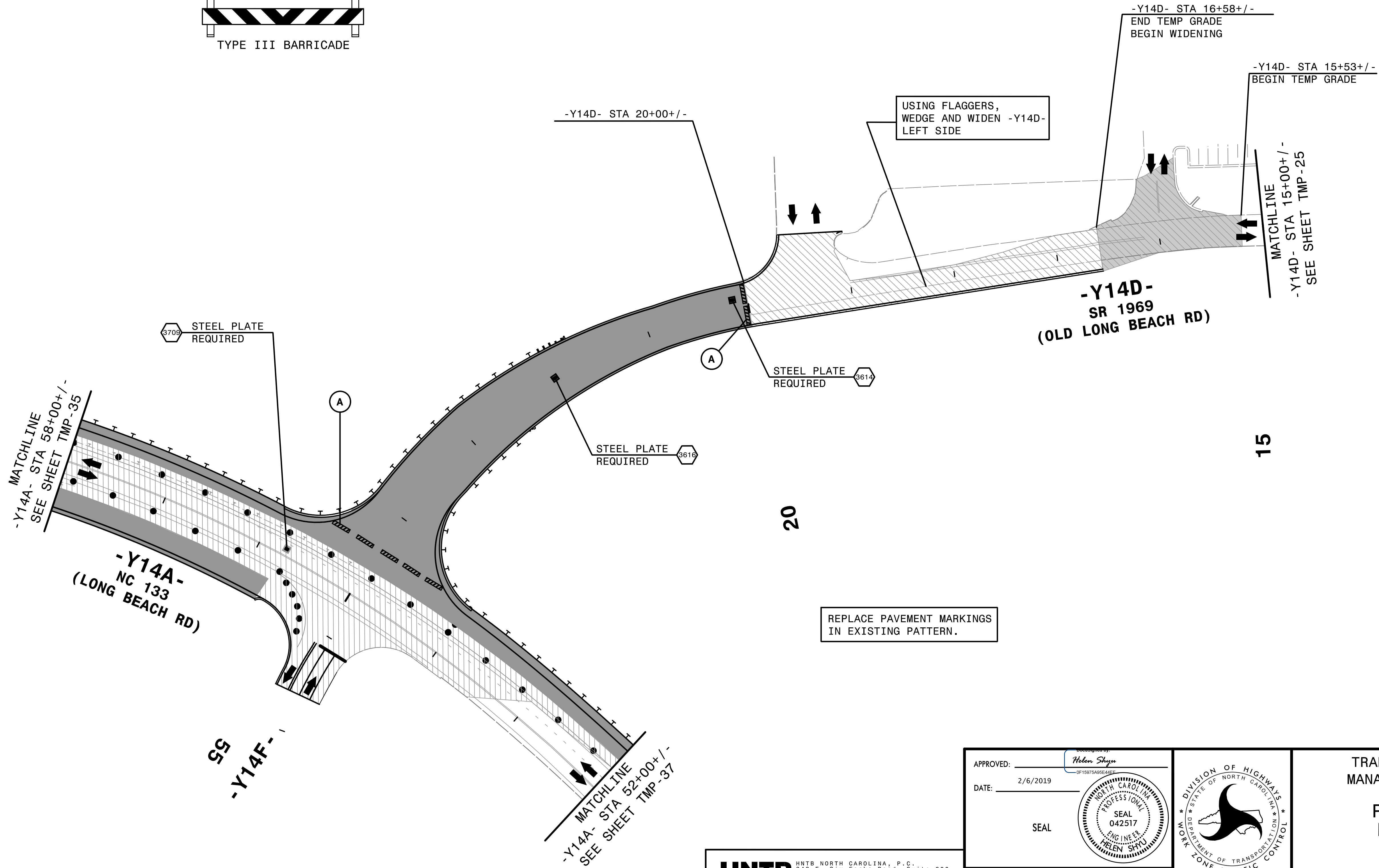
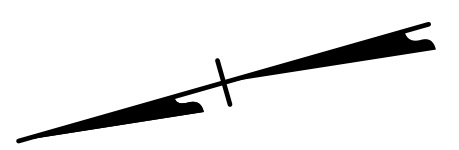
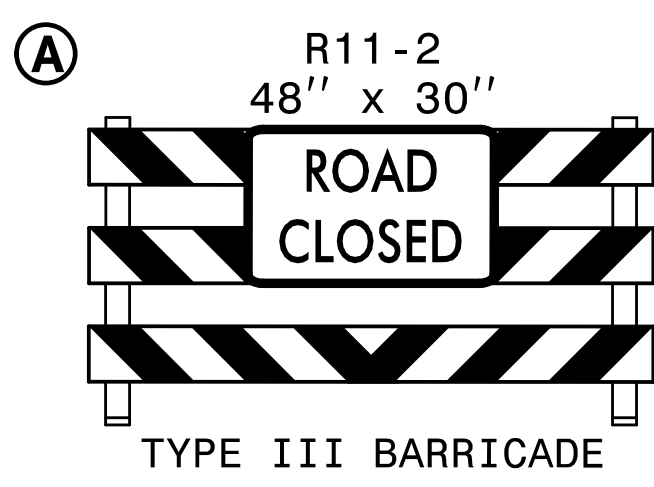

2/6/2019
HNTB
HNTB

HNTB HNTB NORTH CAROLINA, P.C.
343 E. Six Forks Road, Suite 200
Raleigh, North Carolina 27609
NC License No: C-1554

APPROVED: *Helen Shyu*
DATE: 2/6/2019
SEAL
PROFESSIONAL ENGINEER
HELEN SHYU
042517
NORTH CAROLINA

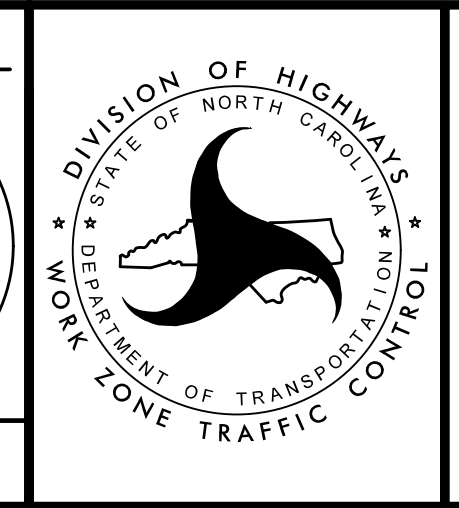

TRANSPORTATION
MANAGEMENT PLAN

PHASE I
DETAIL

DOCUMENT NOT CONSIDERED FINAL
UNLESS ALL SIGNATURES COMPLETED

PROJ. REFERENCE NO.	SHEET NO.
R-5021	TMP-37

MATCHLINE
-Y14A- STA 52+00+/-
SEE SHEET TMP-36

-Y14A- STA 49+34+/-
END TEMP GRADE
BEGIN WEDGE AND WIDEN

-Y14A- STA 48+67+/-
BEGIN TEMP GRADE

50

-Y14E-
-Y14A-
NC 133
(LONG BEACH RD)

REPLACE PAVEMENT MARKINGS
IN EXISTING PATTERN

MATCHLINE
-Y14A- STA 43+00+/-
SEE SHEET TMP-24

45

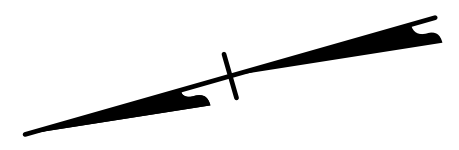

2/6/2019
TCR-V-5021-10-pld33.dgn
HNTB

HNTB HNTB NORTH CAROLINA, P.C.
343 E. Six Forks Road, Suite 200
Raleigh, North Carolina 27609
NC License No: C-1554

APPROVED: *Helen Shyu*
DATE: 2/6/2019

SEAL

PROFESSIONAL SEAL
042517
ENGINEER
HELEN SHYU

**DOCUMENT NOT CONSIDERED FINAL
UNLESS ALL SIGNATURES COMPLETED**

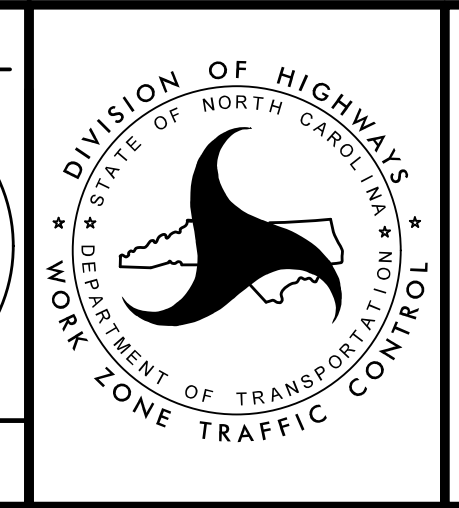

TRANSPORTATION
MANAGEMENT PLAN

PHASE I
DETAIL

PROJ. REFERENCE NO.	SHEET NO.
R-5021	TMP-38

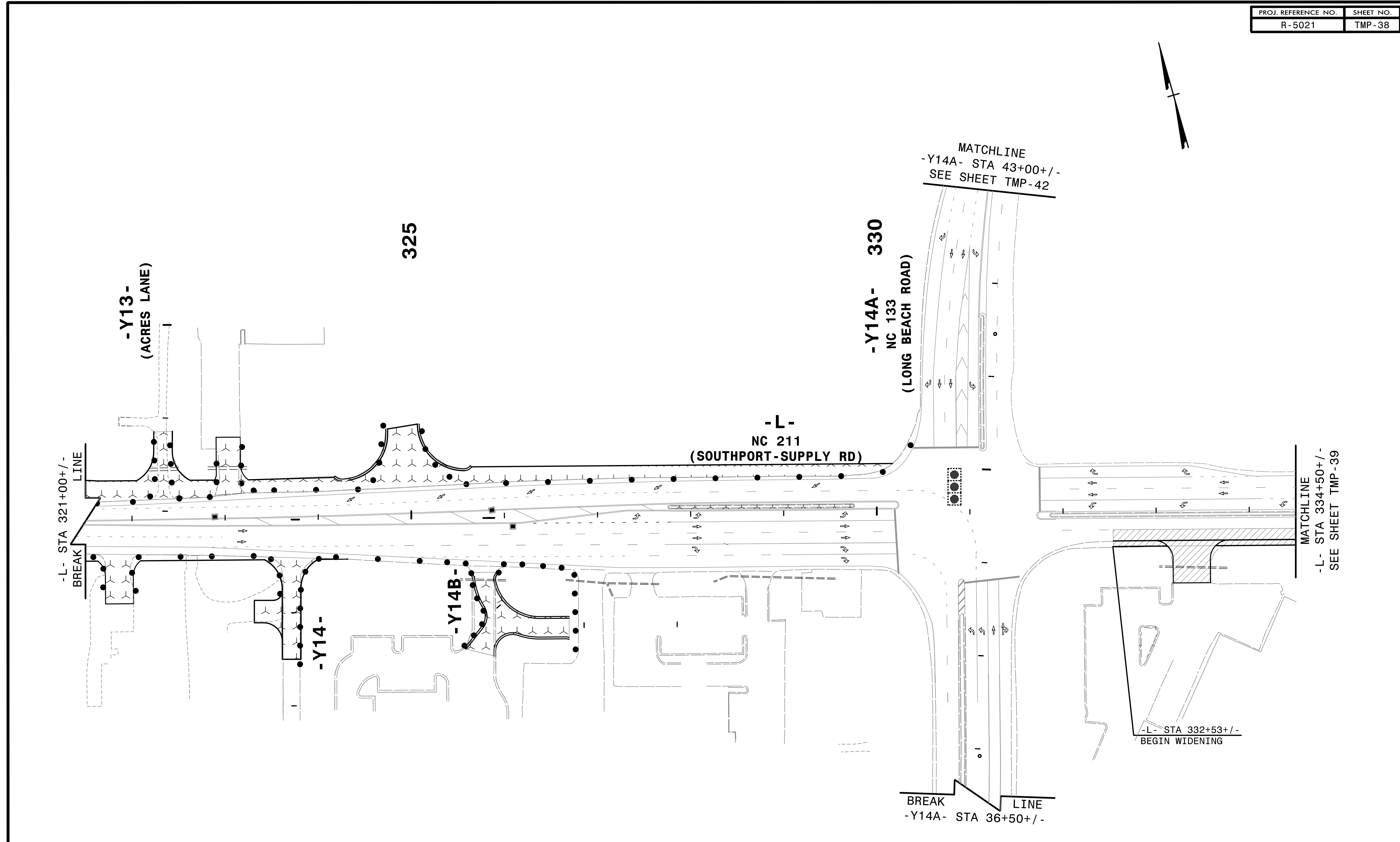
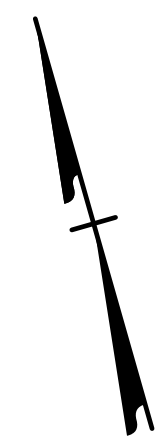

SEE TMP-24 FOR OTHER WORK BETWEEN STA 321+50+/- AND STA 330+18+/-

4:56:08 PM
 \\TCFV\5021\to_pid18 detour.dgn
 \$\$\$USERNAME\$\$\$

HNTB HNTB NORTH CAROLINA, P.C.
 343 E. Six Forks Road, Suite 200
 Raleigh, North Carolina 27609
 NC License No: C-1554

APPROVED: *Helen Shyu*
 DATE: 11/10/2021

SEAL

PROFESSIONAL SEAL
 042517
 ENGINEER
 HELEN SHYU

DOCUMENT NOT CONSIDERED FINAL
 UNLESS ALL SIGNATURES COMPLETED

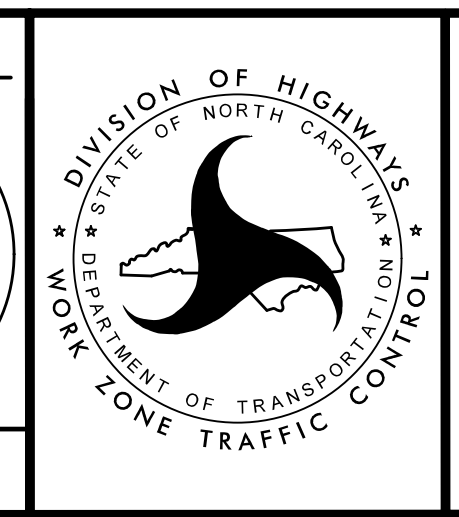

TRANSPORTATION
 MANAGEMENT PLAN

PHASE I
 STEP 12.4
 DETAIL

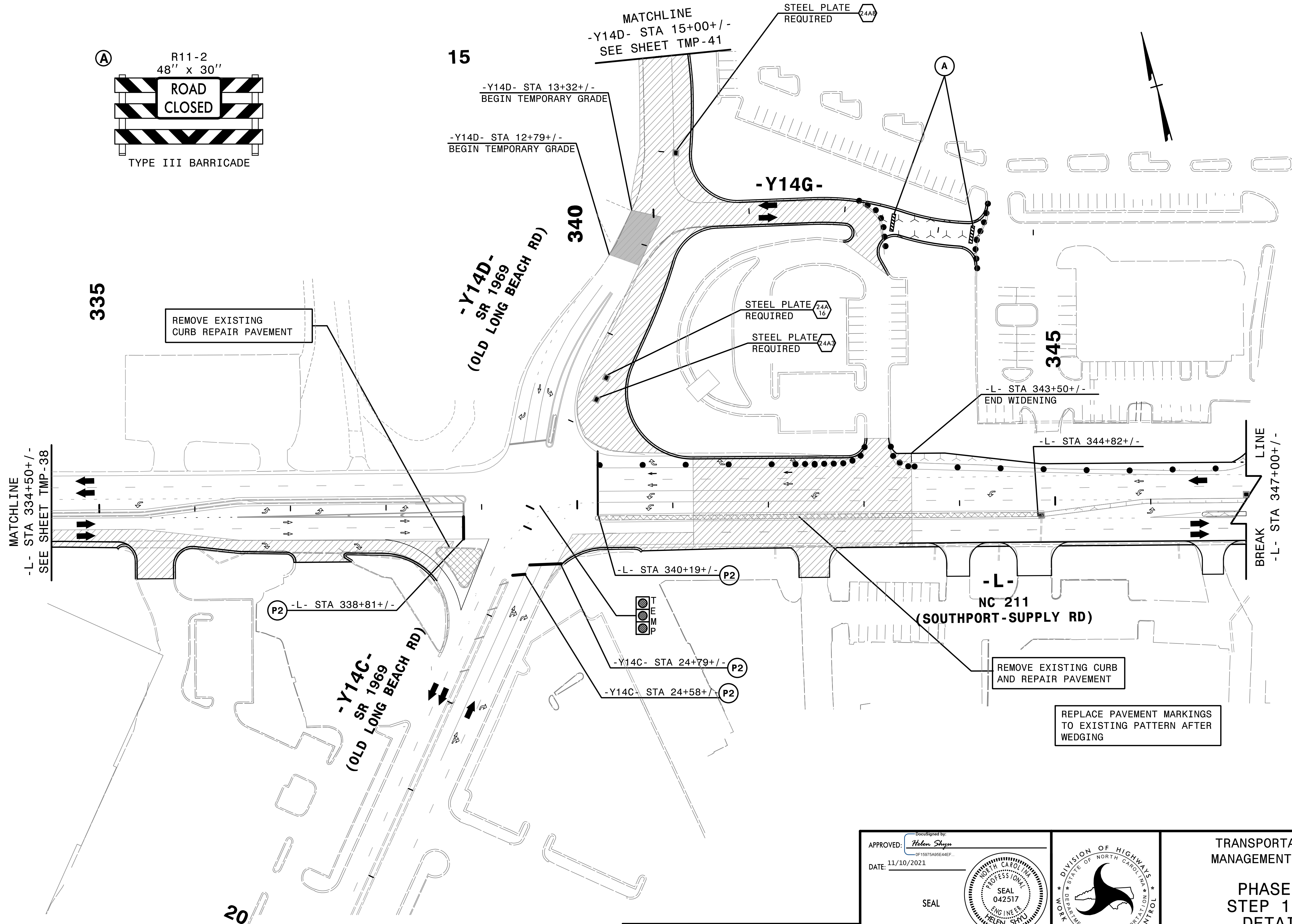
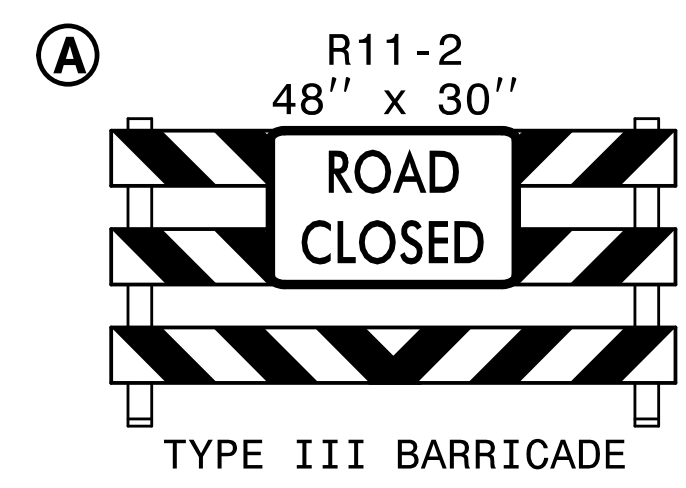

4:56:40 PM
\\TCN\F5021\TC_pid19_detour.dgn
\$\$\$\$\$USERNAME\$\$\$\$\$

HNTB HNTB NORTH CAROLINA, P.C.
343 E. Six Forks Road, Suite 200
Raleigh, North Carolina 27609
NC License No: C-1554

APPROVED: *Helen Shyu*
DATE: 11/10/2021

SEAL

DOCUMENT NOT CONSIDERED FINAL
UNLESS ALL SIGNATURES COMPLETED

TRANSPORTATION
MANAGEMENT PLAN

PHASE I
STEP 12.4
DETAIL

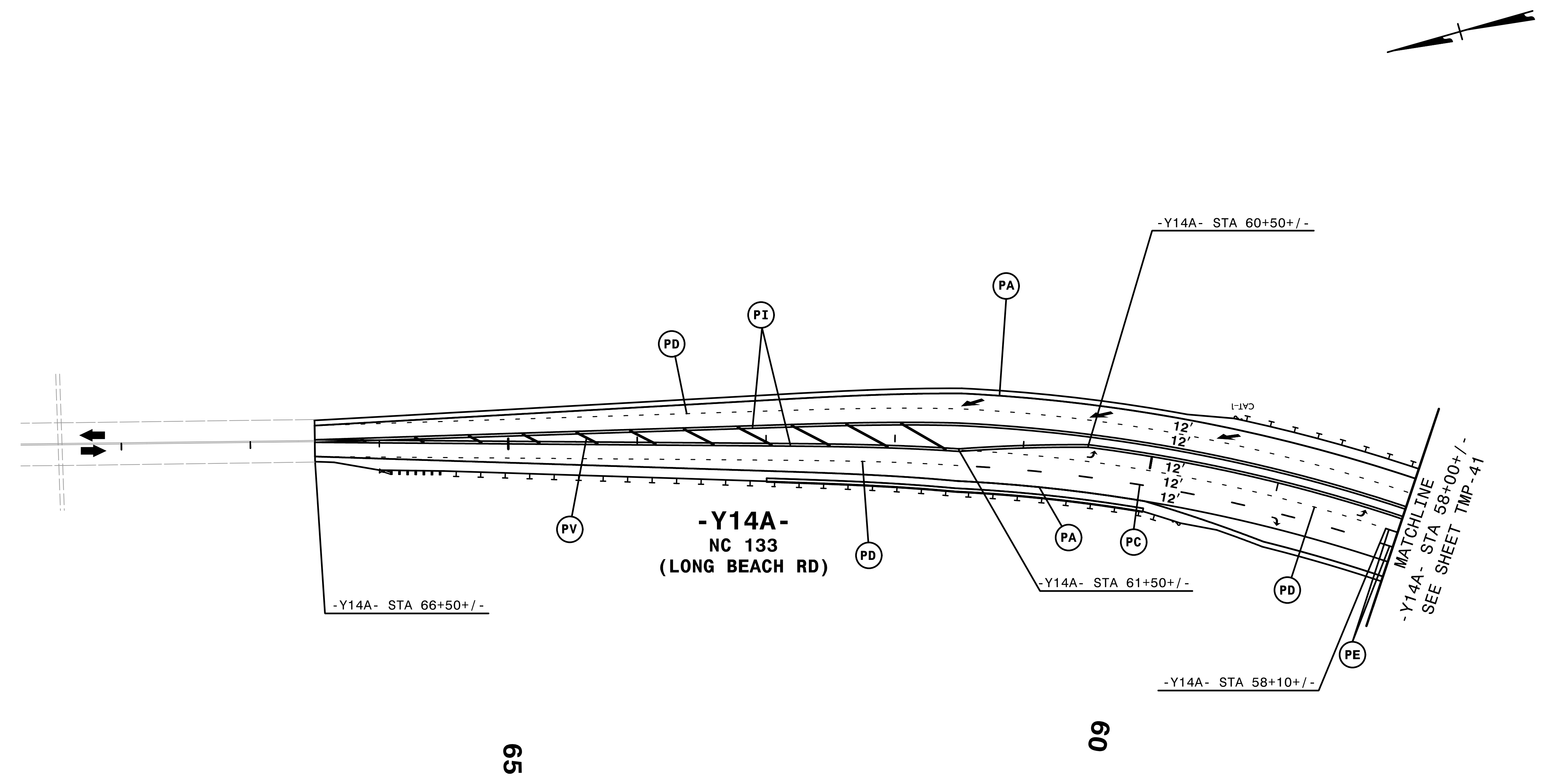

4:56:12 PM
 \\TCF\...5021\..._pld32 detour.dgn
 \$\$\$USERNAME\$\$\$

69

69

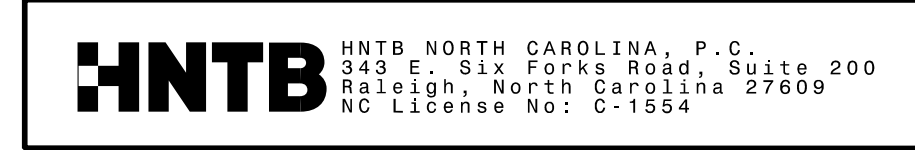

APPROVED: *Helen Shyu*
 DATE: 11/10/2021

SEAL

**DOCUMENT NOT CONSIDERED FINAL
UNLESS ALL SIGNATURES COMPLETED**

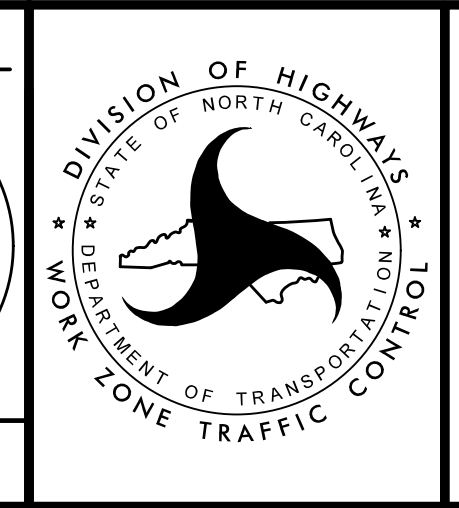

TRANSPORTATION
MANAGEMENT PLAN

**PHASE I
STEPS 12.6
DETAIL**

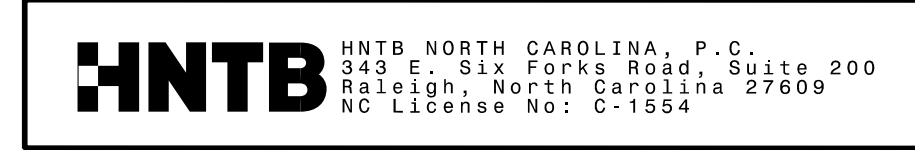
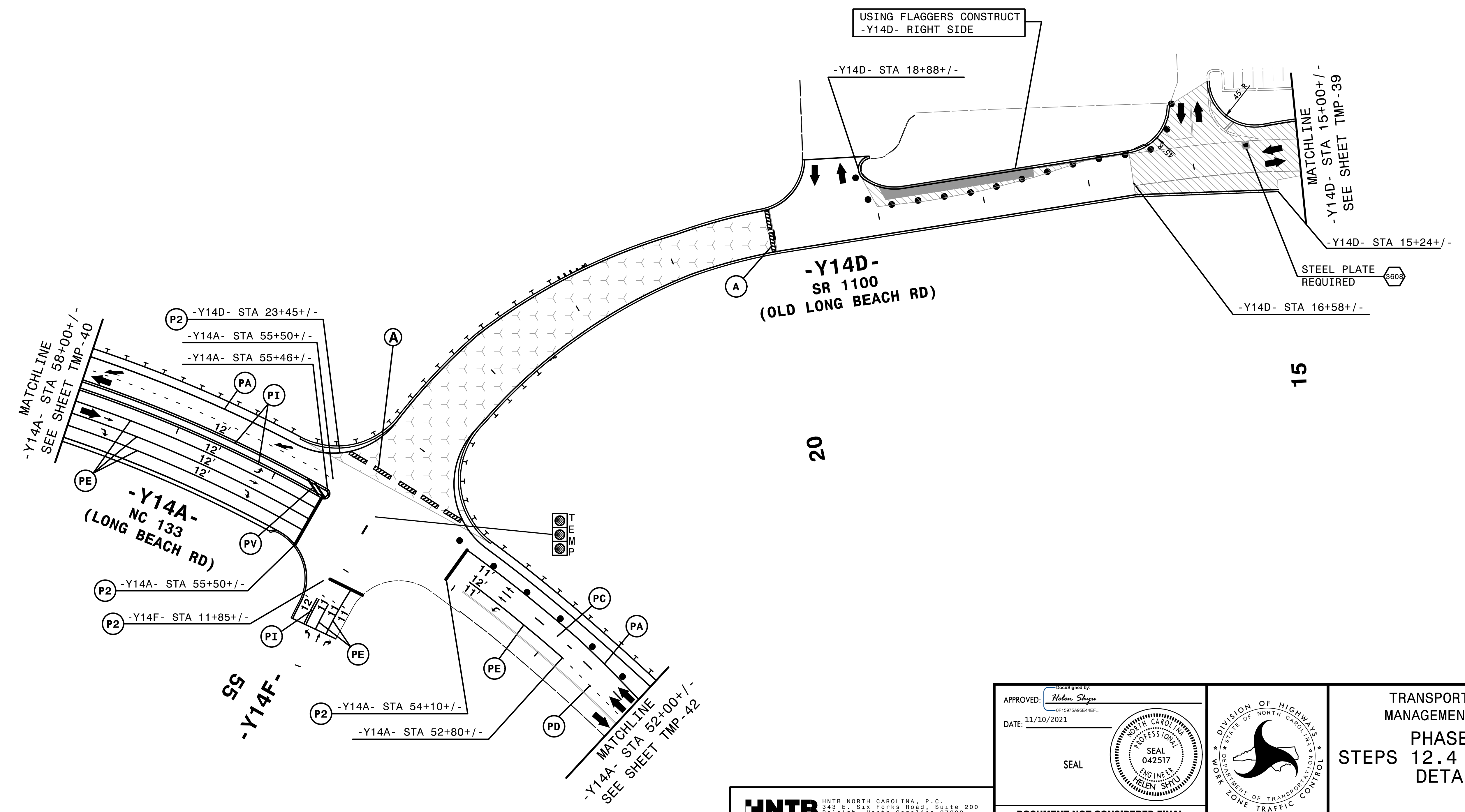
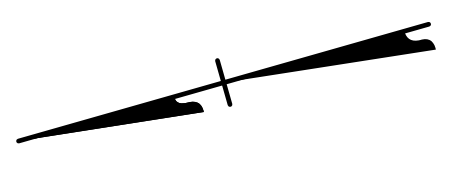
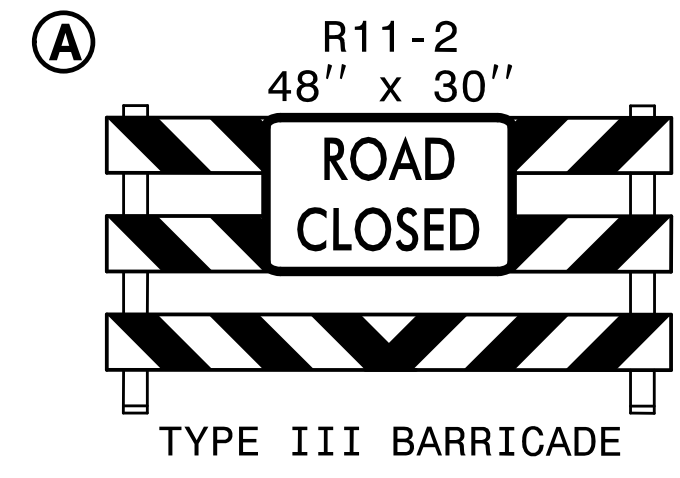

APPROVED: *Helen Shyu*
DATE: 11/10/2021
SEAL

DOCUMENT NOT CONSIDERED FINAL
UNLESS ALL SIGNATURES COMPLETED

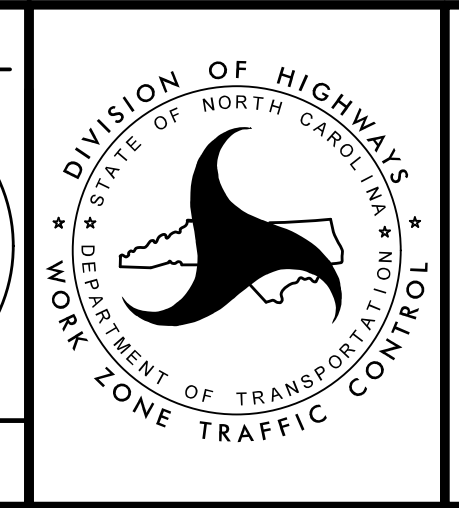

TRANSPORTATION
MANAGEMENT PLAN
PHASE I
STEPS 12.4 AND 12.6
DETAIL

4:56:45 PM
\\TCFV\5021\TC\pid35 detour.dgn
\$\$\$USERNAME\$\$\$

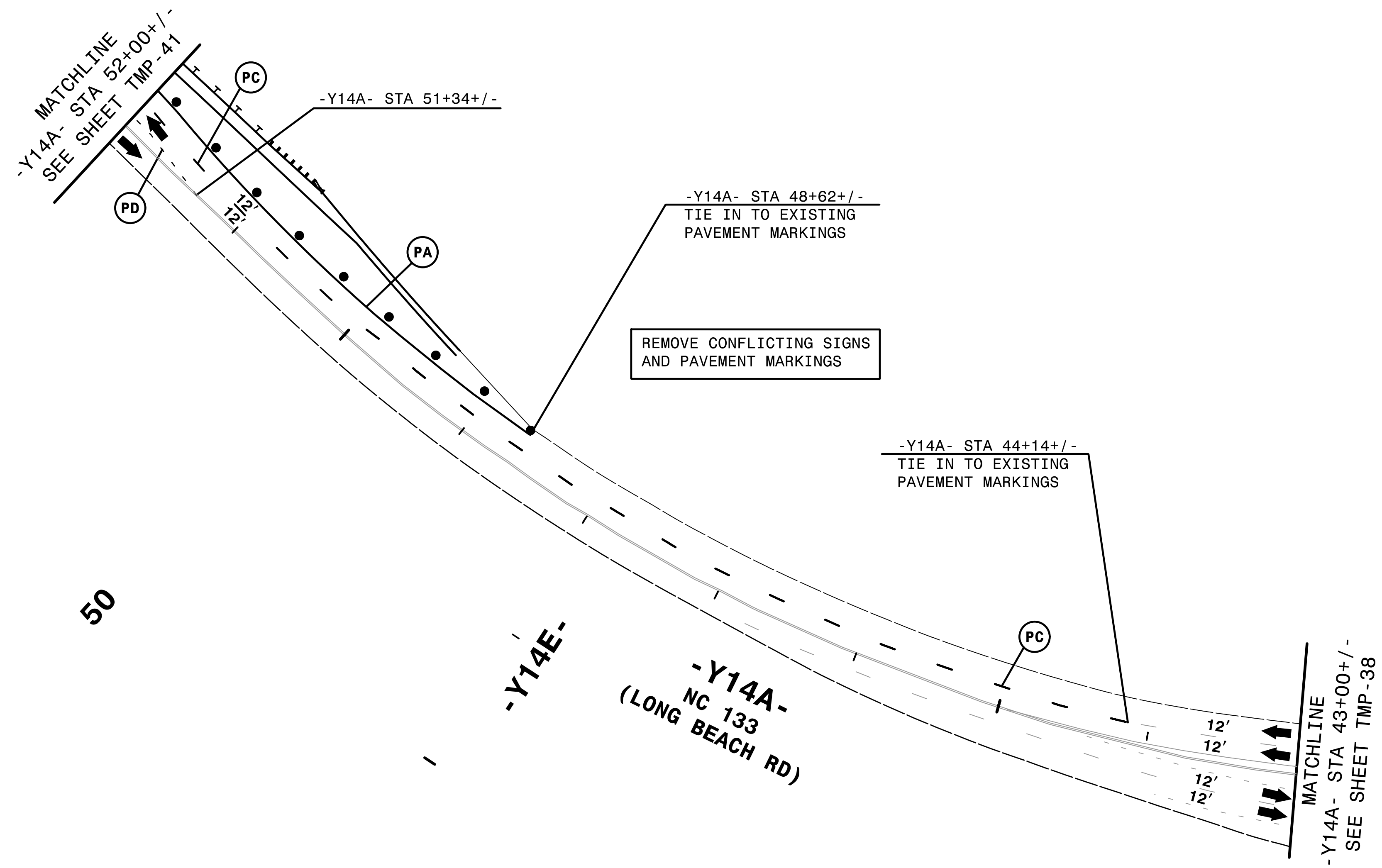
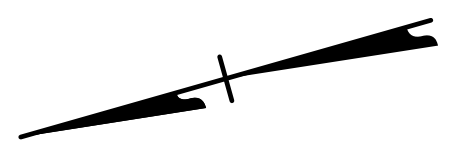

REMOVE CONFLICTING SIGNS
AND PAVEMENT MARKINGS

4:56:17 PM
 \\TCF\5021\TC_pid33_detour.dgn
 \$\$\$USERNAME\$\$\$

HNTB HNTB NORTH CAROLINA, P.C.
 343 E. Six Forks Road, Suite 200
 Raleigh, North Carolina 27609
 NC License No: C-1554

APPROVED: *Helen Shyu*
 DATE: 11/10/2021
 SEAL
 DOCUMENT NOT CONSIDERED FINAL
 UNLESS ALL SIGNATURES COMPLETED

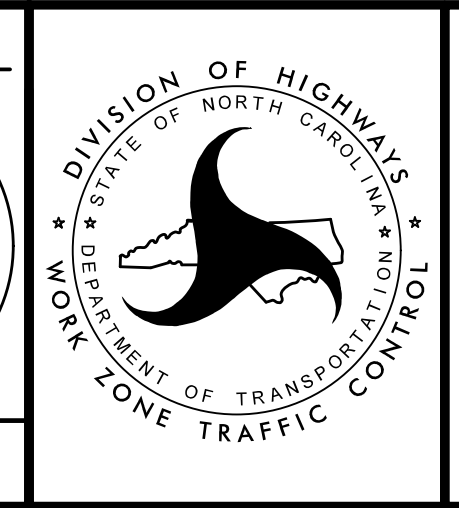
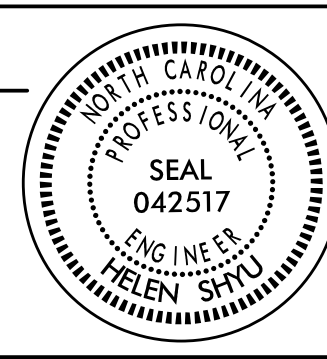

TRANSPORTATION
 MANAGEMENT PLAN
 PHASE I
 STEPS 12.6
 DETAIL

PROJ. REFERENCE NO.	SHEET NO.
R-5021	TMP-43

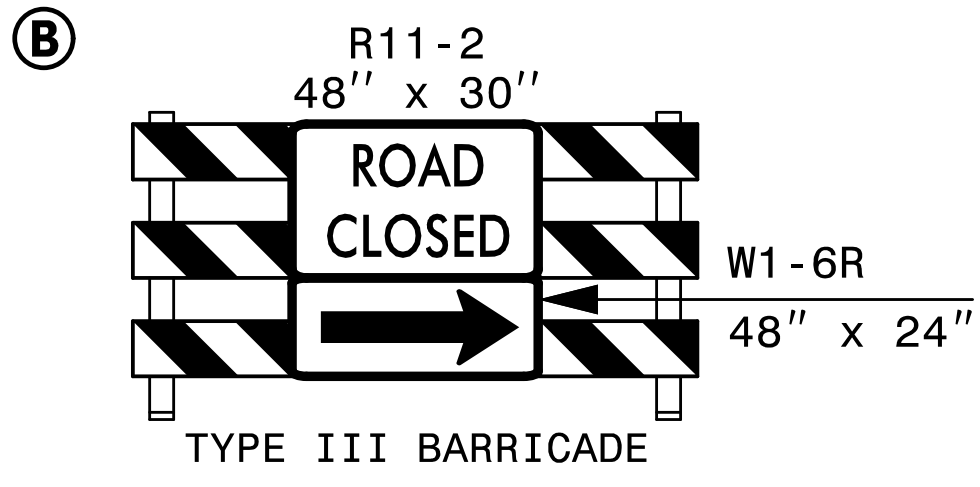
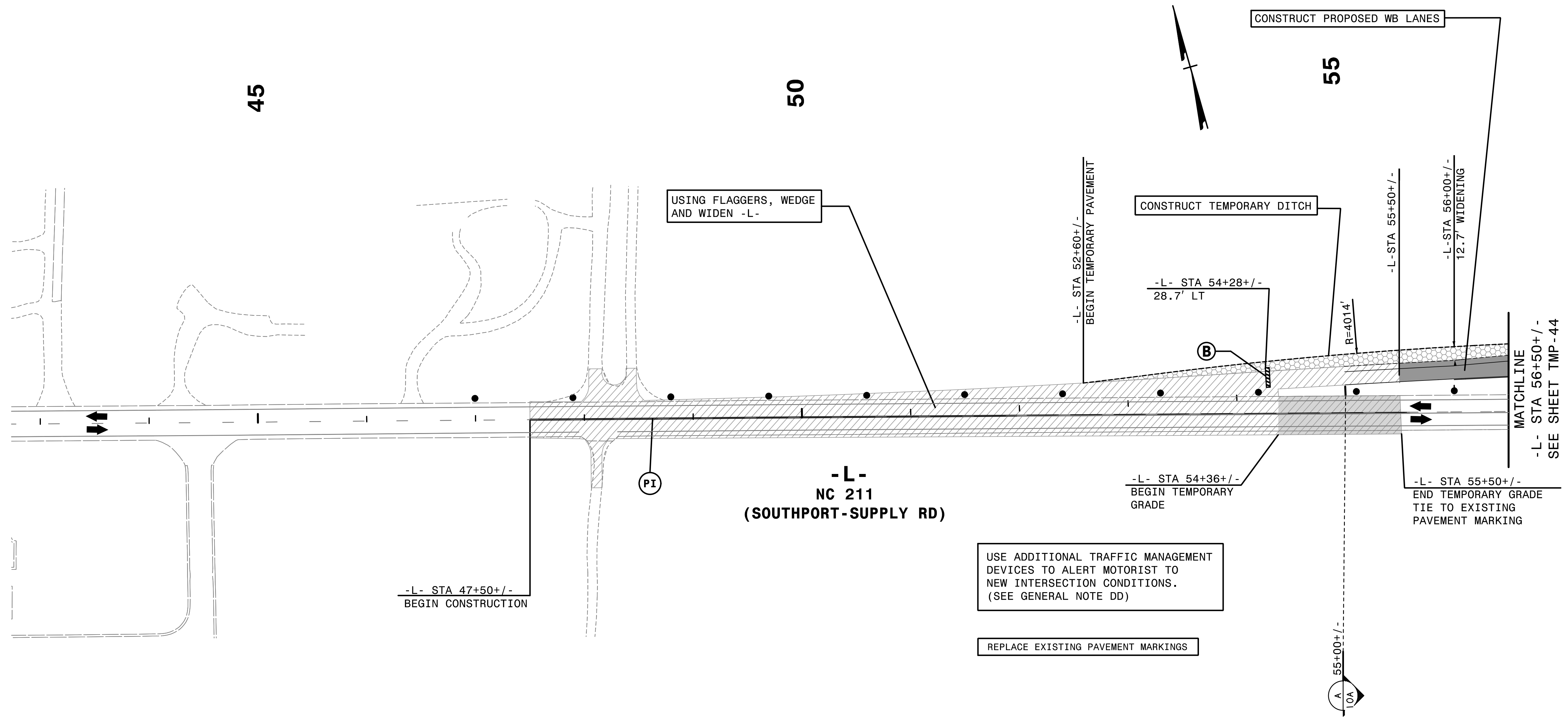

HNTB HNTB NORTH CAROLINA, P.C.
343 E. Six Forks Road, Suite 200
Raleigh, North Carolina 27609
NC License No: C-1554

APPROVED: *Helen Skyy*
DATE: 2/6/2019

SEAL

PROFESSIONAL ENGINEER
HELEN SKYY
042517

DOCUMENT NOT CONSIDERED FINAL
UNLESS ALL SIGNATURES COMPLETED

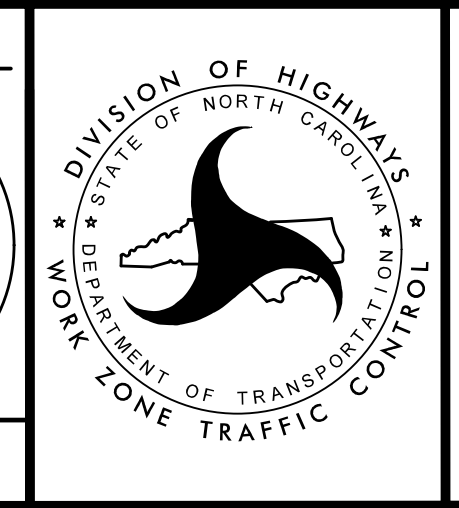

TRANSPORTATION
MANAGEMENT PLAN

PHASE IA
DETAIL

2/6/2019
TCPLV502L.tc_pidia.dgn
HNTB

- (X) 73' SHOP CURVED TEMPORARY GUARDRAIL WITH B-77 ANCHOR TO PCB AND TEMP AT-1
- (Y) 73' SHOP CURVED TEMPORARY GUARDRAIL WITH B-77 ANCHOR TO PCB AND TEMP AT-1

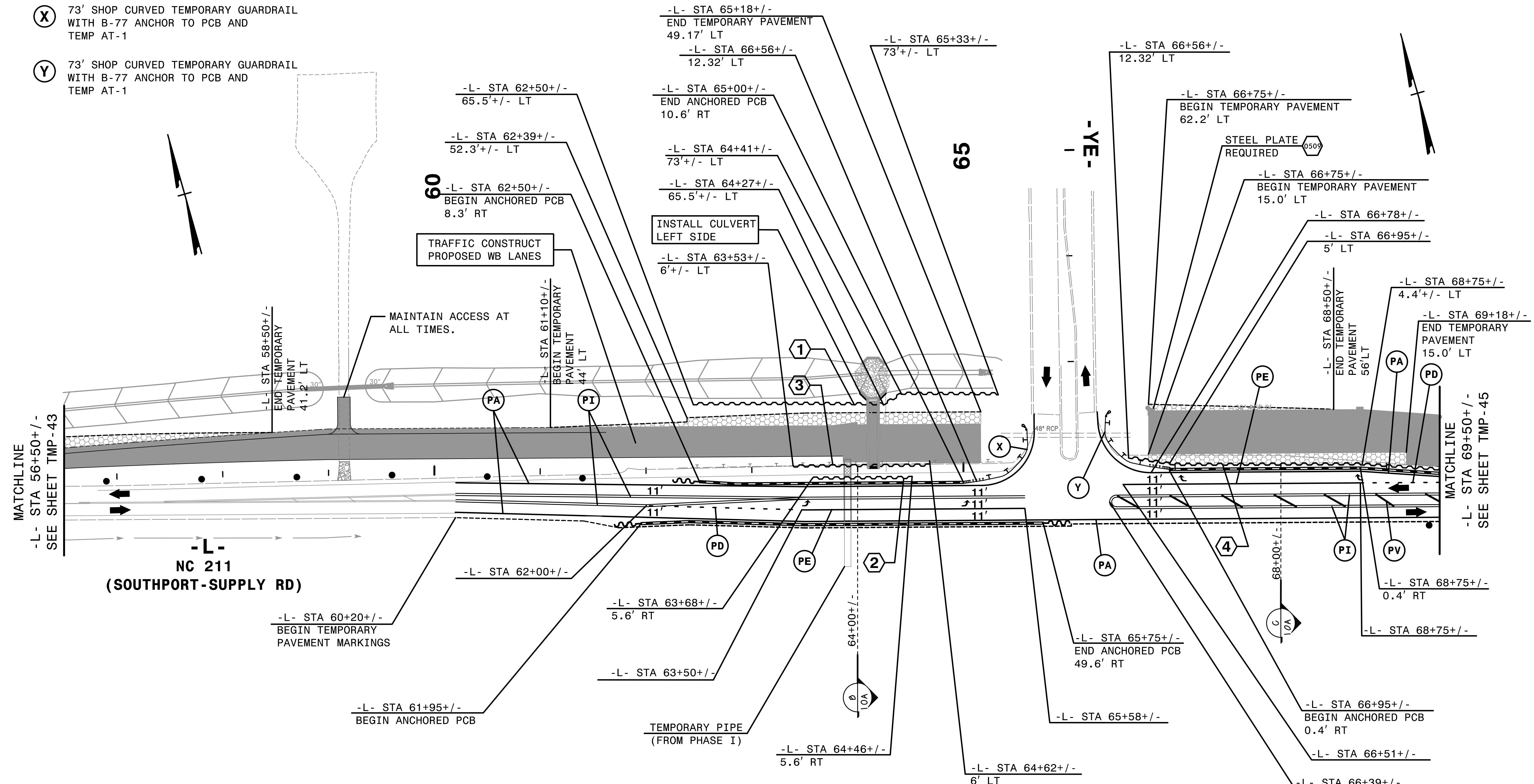

NOTE: DRAINAGE INFO SHOWN IS ONLY FOR CONTRACTOR CONSIDERATION. CONTRACTOR SHOULD VERIFY THAT PONDING OF WATER WILL NOT OCCUR IN THE TRAVEL LANES.

SEE CULVERT PHASING ON 5A/CONST.5

1 EST QUANTITY = 701.5 SF

TEMPORARY SHORING
 FROM -L- STA 62+50+/-, 65.5'+/- LT,
 TO -L- STA 64+27+/-, 65.5'+/- LT AND
 FROM -L- STA 64+27+/-, 65.5'+/- LT,
 TO -L- STA 64+41+/-, 73'+/- LT AND
 FROM -L- STA 64+41+/-, 73'+/- LT,
 TO -L- STA 65+33+/-, 73'+/- LT

(SEE SHEET TMP-2G FOR TEMPORARY SHORING NOTES)

2 EST QUANTITY = 400 SF

TEMPORARY SHORING
 FROM -L- STA 63+68+/-, 5.6'+/- RT,
 TO -L- STA 64+46+/-, 5.6'+/- RT

3 EST QUANTITY = 885 SF

TEMPORARY SHORING
 FROM -L- STA 63+53+/-, 6'+/- LT,
 TO -L- STA 64+62+/-, 6'+/- LT

4 EST QUANTITY = 2118 SF

TEMPORARY SHORING
 FROM -L- STA 66+56+/-, 12.32'+/- LT,
 TO -L- STA 67+00+/-, 5'+/- LT AND
 FROM -L- STA 67+00+/-, 5'+/- LT,
 TO -L- STA 68+75+/-, 4.4'+/- LT AND
 FROM -L- STA 68+75+/-, 4.4'+/- LT,
 TO -L- STA 70+13+/-, 5.67'+/- RT

REMOVE CONFLICTING PAVEMENT MARKING.

4:56:21PM \\TCF\5021\TC\pld2a.dgn

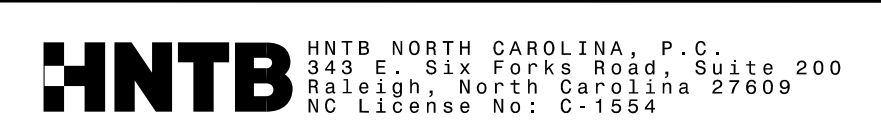

APPROVED: *Helen Shyu*
 DATE: 11/10/2021

SEAL

DOCUMENT NOT CONSIDERED FINAL UNLESS ALL SIGNATURES COMPLETED

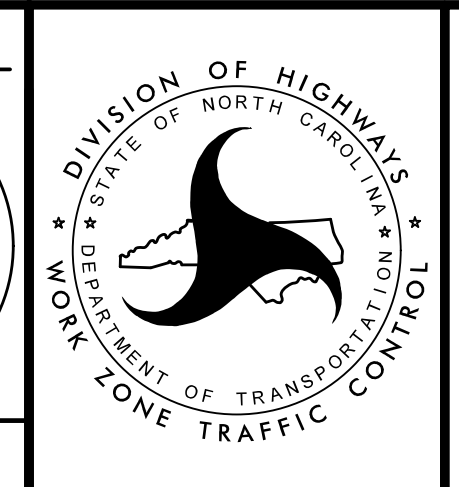

TRANSPORTATION MANAGEMENT PLAN

PHASE IA DETAIL

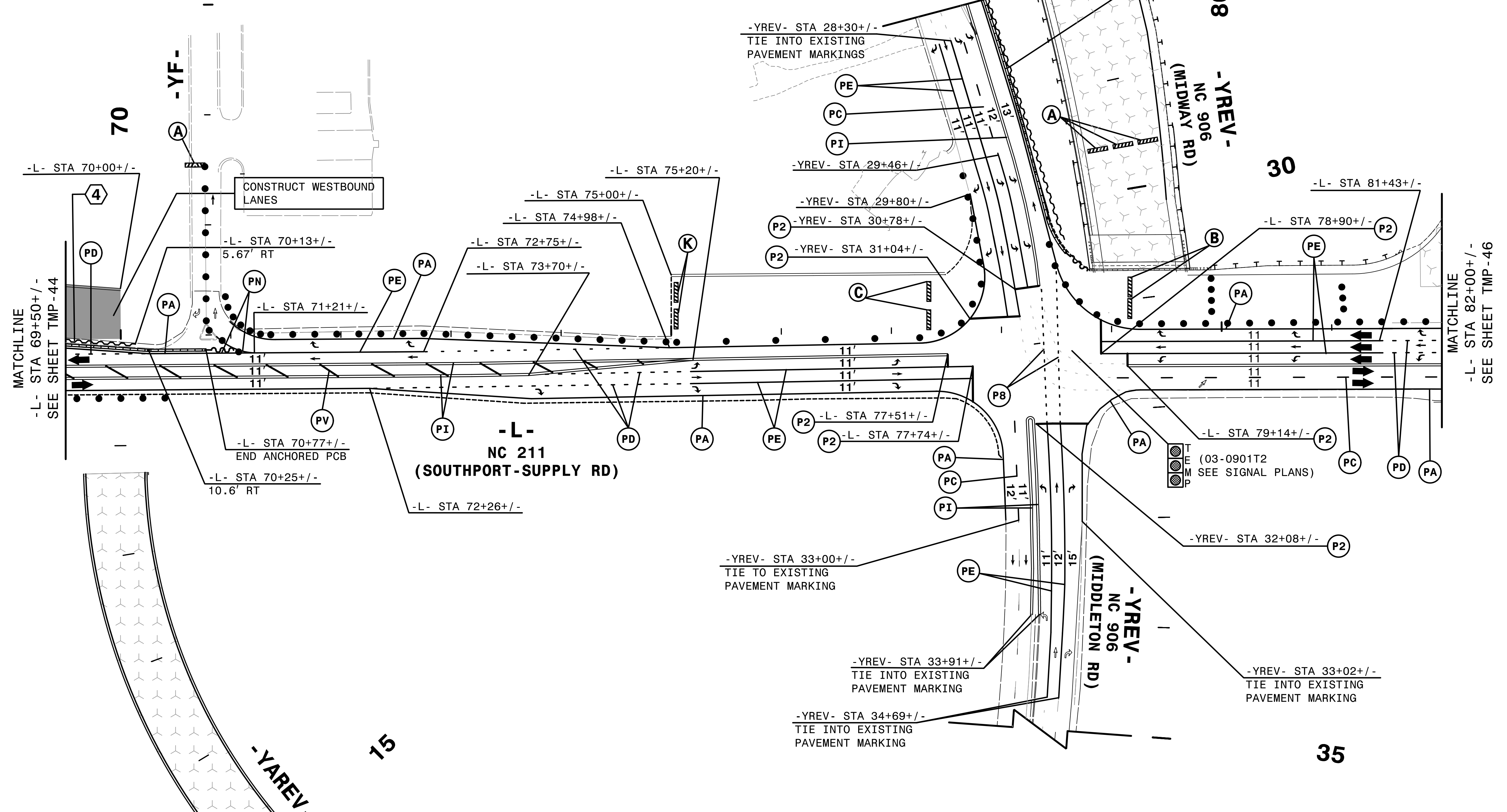
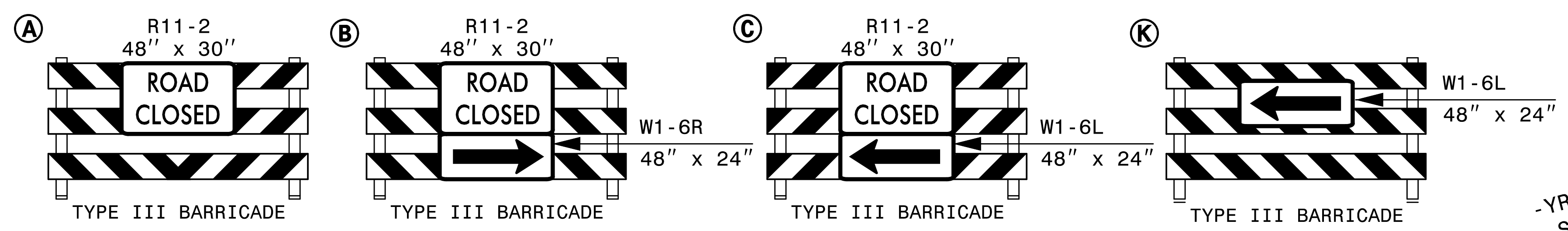

4 EST QUANTITY = 2118 SF

TEMPORARY SHORING
 FROM -L- STA 66+56+/-, 12.32'+/- LT,
 TO -L- STA 67+00+/-, 5'+/- LT AND
 FROM -L- STA 67+00+/-, 5'+/- LT,
 TO -L- STA 68+75+/-, 4.4'+/- LT AND
 FROM -L- STA 68+75+/-, 4.4'+/- LT,
 TO -L- STA 70+03+/-, 5.67'+/- RT

(SEE SHEET TMP-2G FOR
 TEMPORARY SHORING NOTES)

3:23:14 PM
 \\TC\p\5021\1\c\pld3a.dgn
 \$\$\$USERNAME\$\$\$

HNTB HNTB NORTH CAROLINA, P.C.
 343 E. Six Forks Road, Suite 200
 Raleigh, North Carolina 27609
 NC License No: C-1554

APPROVED: *Helen Shyu*
DE 15975A95E4AEF

DATE: 10/28/2021

SEAL

DOCUMENT NOT CONSIDERED FINAL
 UNLESS ALL SIGNATURES COMPLETED

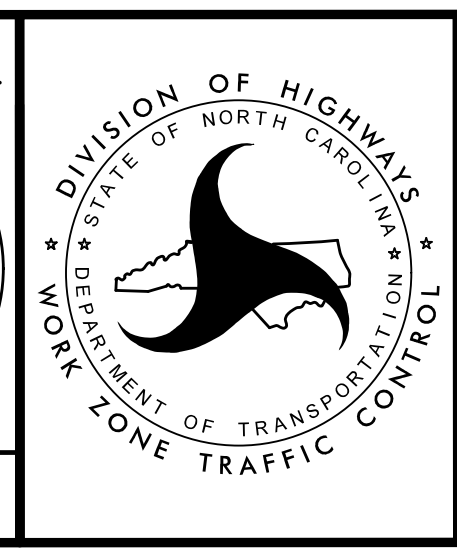

TRANSPORTATION
 MANAGEMENT PLAN

PHASE IA
 DETAIL

NOTE: DRAINAGE INFO SHOWN IS ONLY FOR CONTRACTOR CONSIDERATION. CONTRACTOR SHOULD VERIFY THAT PONDING OF WATER WILL NOT OCCUR IN THE TRAVEL LANES.

REMOVE CONFLICTING PAVEMENT MARKING.

SEE CULVERT PHASING ON EC-6A/CONST. 6

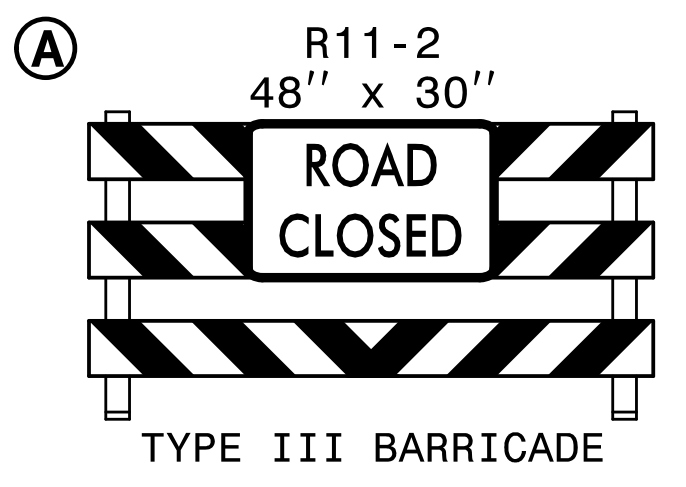
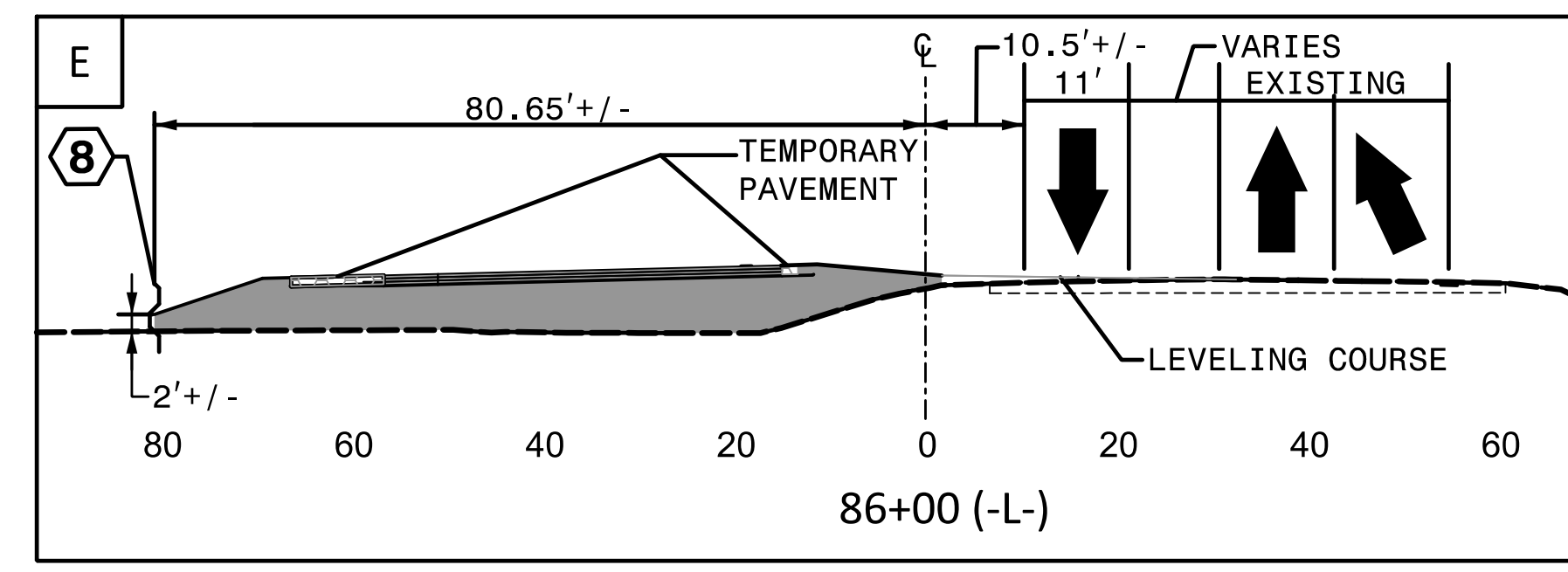
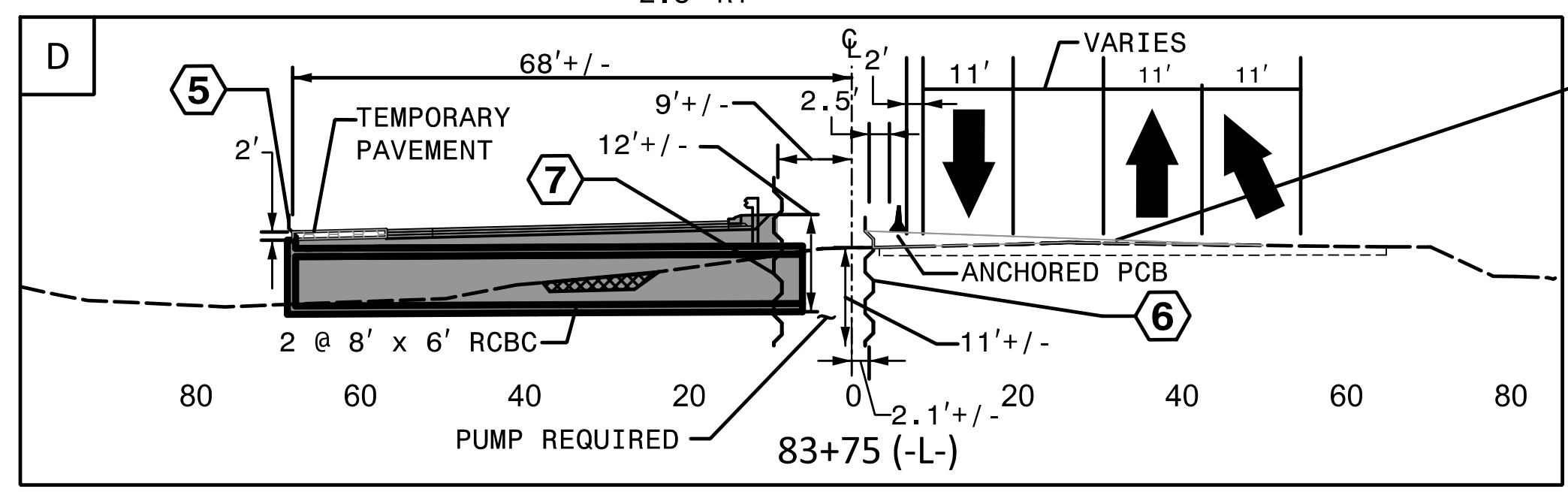
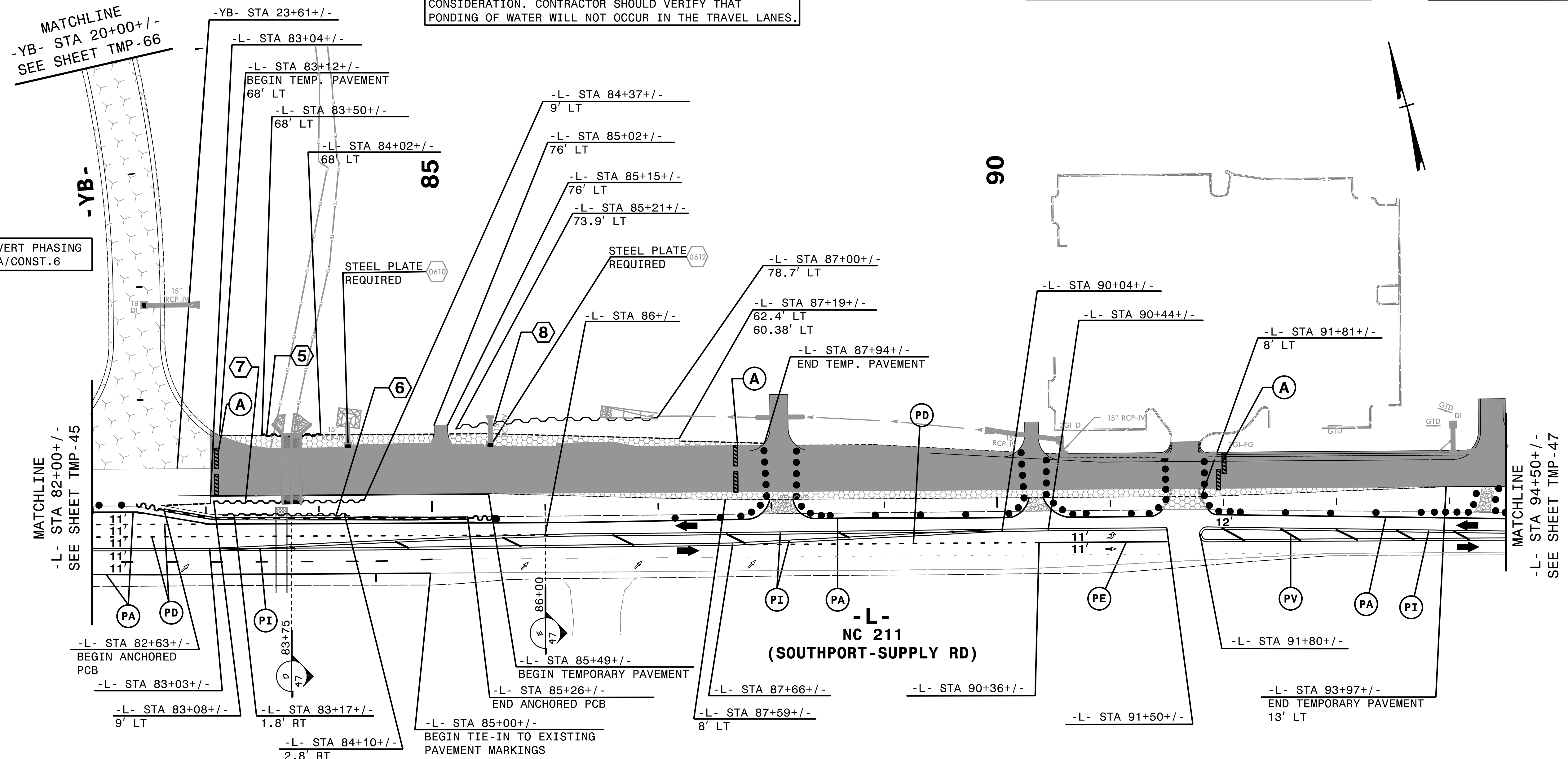

5 EST QUANTITY = 104 SF
 TEMPORARY SHORING
 FROM -L- STA 83+50+/-, 68' LT,
 TO -L- STA 84+02+/-, 68' LT.
 (SEE SHEET TMP-2G FOR
 TEMPORARY SHORING NOTES)

6 EST QUANTITY = 660 SF
 TEMPORARY SHORING
 FROM -L- STA 83+17+/-, 1.8' RT,
 TO -L- STA 84+10+/-, 2.8' RT.
7 EST QUANTITY = 1296 SF
 TEMPORARY SHORING
 FROM -L- STA 83+08+/-, 9' LT,
 TO -L- STA 84+37+/-, 9' LT.

8 EST QUANTITY = 383.06 SF
 TEMPORARY SHORING
 FROM -L- STA 85+21+/-, 73.9' LT,
 TO -L- STA 86+00+/-, 80.7' LT,
 FROM -L- STA 86+00+/-, 80.7' LT,
 TO -L- STA 87+00+/-, 78.7' LT.

HNTB HNTB NORTH CAROLINA, P.C.
 343 E. Six Forks Road, Suite 200
 Raleigh, North Carolina 27609
 NC License No: C-1554

APPROVED: *Helen Shyne*
 DATE: 9/9/2021
 SEAL
 DOCUMENT NOT CONSIDERED FINAL
 UNLESS ALL SIGNATURES COMPLETED

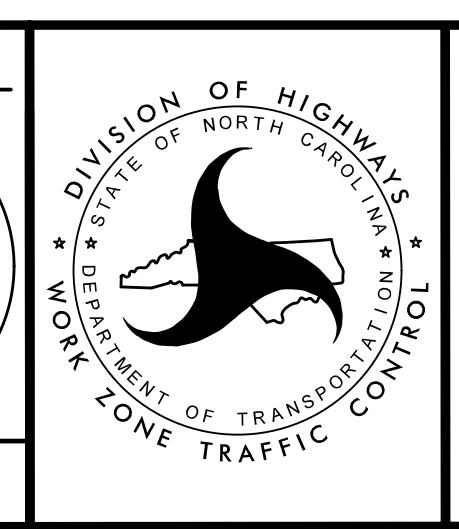

TRANSPORTATION
 MANAGEMENT PLAN
 PHASE IA
 DETAIL

4:52:50 PM
 ...\\TCPLV5021..._TC..._p1d4a.dgn
 \$\$\$USERNAME\$\$\$

REMOVE CONFLICTING PAVEMENT MARKING.

PROJ. REFERENCE NO.	SHEET NO.
R-5021	TMP-47

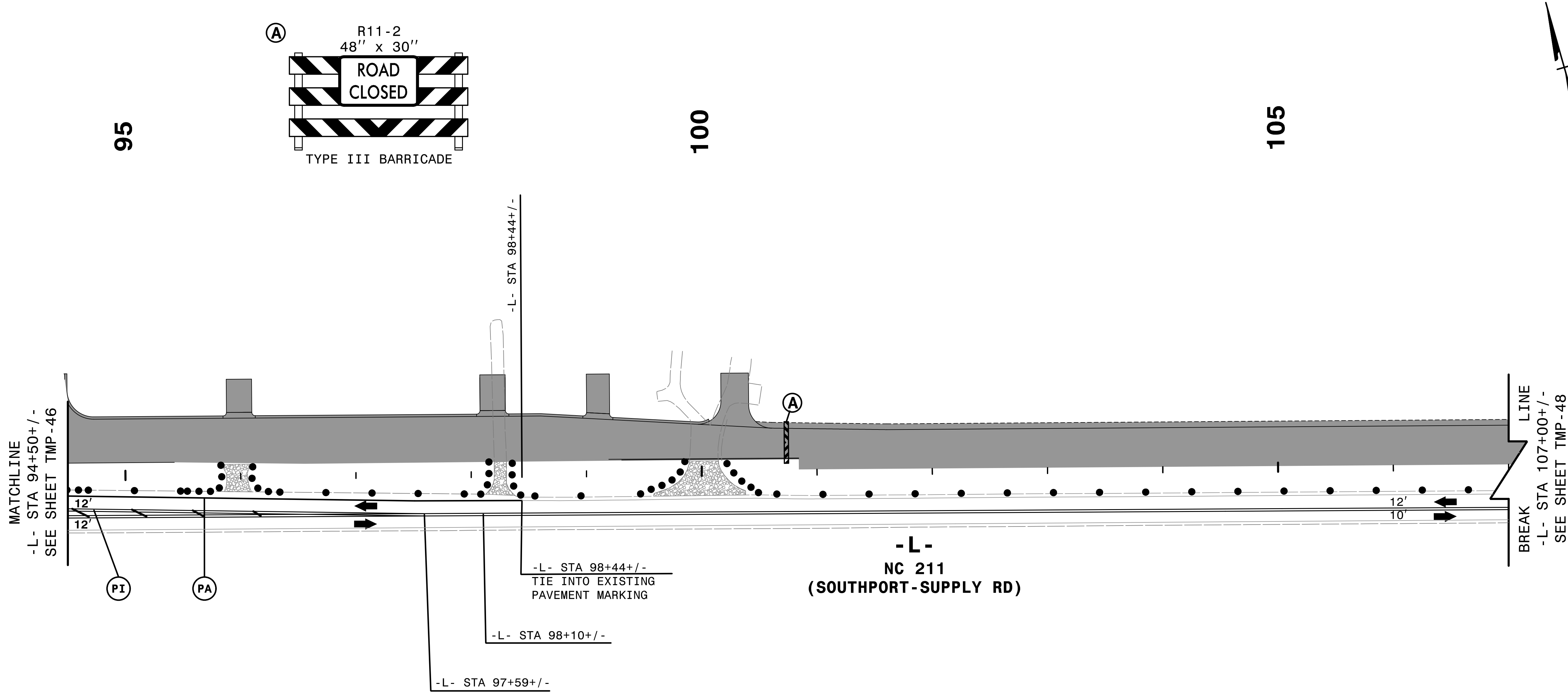

4:52:54 PM
...\\TC\...5021_Tc_p1d5a.dgn
\$\$\$\$\$USERNAME\$\$\$\$\$

HNTB HNTB NORTH CAROLINA, P.C.
343 E. Six Forks Road, Suite 200
Raleigh, North Carolina 27609
NC License No: C-1554

APPROVED: *Helen Shyu*
DATE: 9/9/2021
SEAL
DOCUMENT NOT CONSIDERED FINAL
UNLESS ALL SIGNATURES COMPLETED

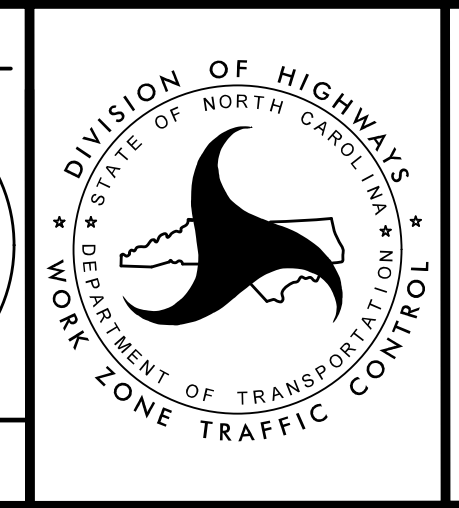
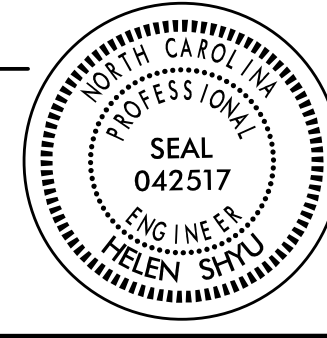

TRANSPORTATION
MANAGEMENT PLAN

PHASE IA
DETAIL

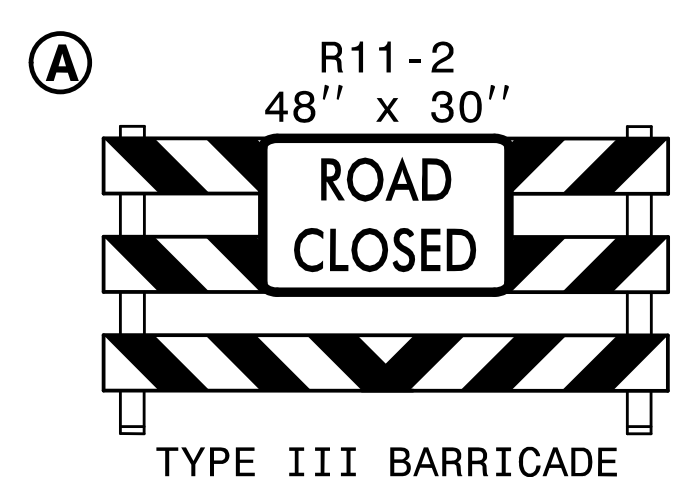

REMOVE CONFLICTING PAVEMENT MARKING.

PROJ. REFERENCE NO.	SHEET NO.
R-5021	TMP-48

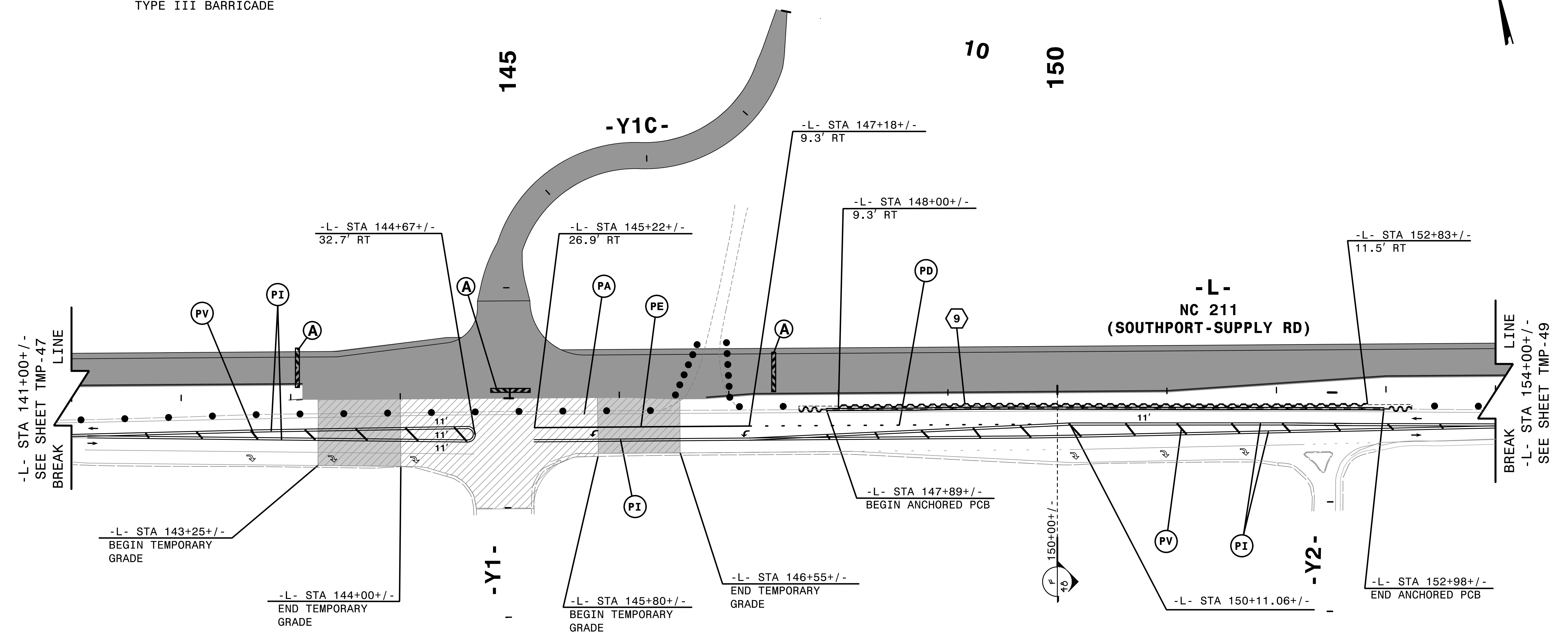

9 EST QUANTITY = 2584.05 SF
 TEMPORARY SHORING
 FROM -L- STA 148+00+/-, 9.3' LT
 TO -L- STA 152+83+/-, 11.5' LT
 (SEE SHEET TMP-2G FOR
 TEMPORARY SHORING NOTES)

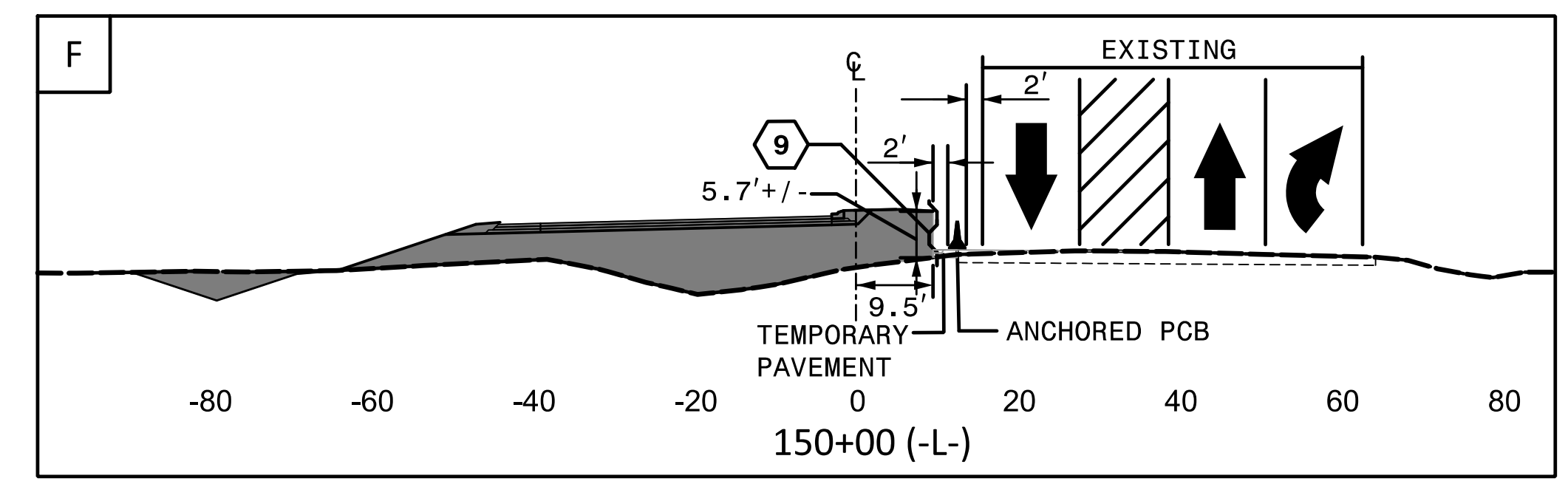

2/6/2019
TCRV-5021-TC-pld6a.dgn
HNTB

HNTB HNTB NORTH CAROLINA, P.C.
 343 E. Six Forks Road, Suite 200
 Raleigh, North Carolina 27609
 NC License No: C-1554

APPROVED: *Helen Shyu*
 DATE: 2/6/2019
 SEAL
 PROFESSIONAL ENGINEER
 SEAL 042517
 HELEN SHYU

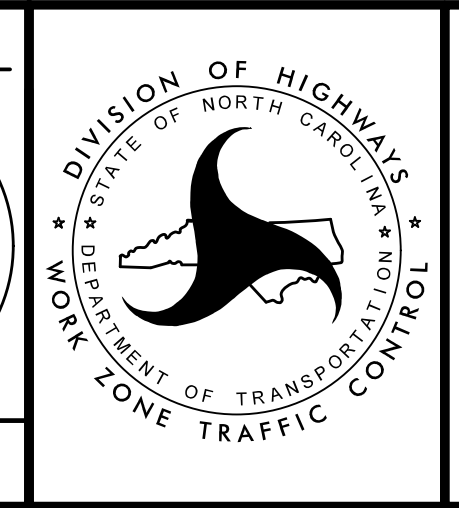

TRANSPORTATION
 MANAGEMENT PLAN
 PHASE IA
 DETAIL

DOCUMENT NOT CONSIDERED FINAL
UNLESS ALL SIGNATURES COMPLETED

NOTE: DRAINAGE INFO SHOWN IS ONLY FOR CONTRACTOR CONSIDERATION. CONTRACTOR SHOULD VERIFY THAT PONDING OF WATER WILL NOT OCCUR IN THE TRAVEL LANES.

PROJ. REFERENCE NO.	SHEET NO.
R-5021	TMP-49

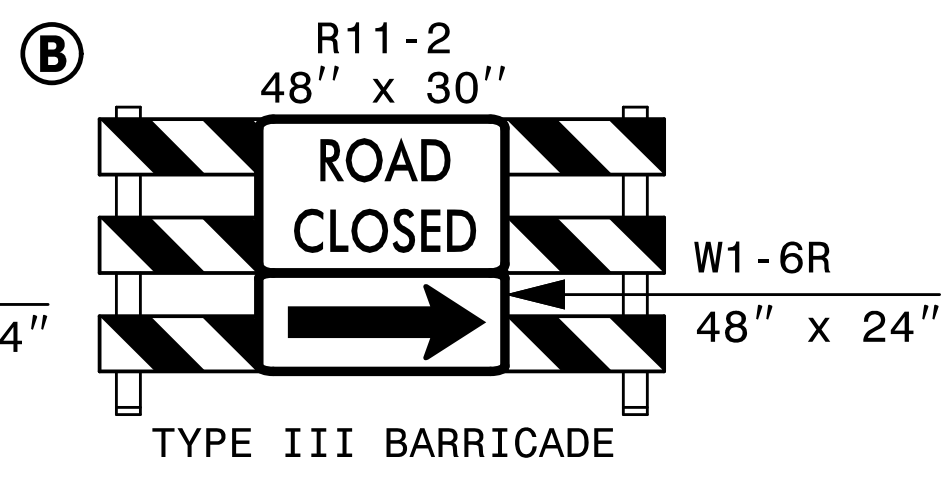
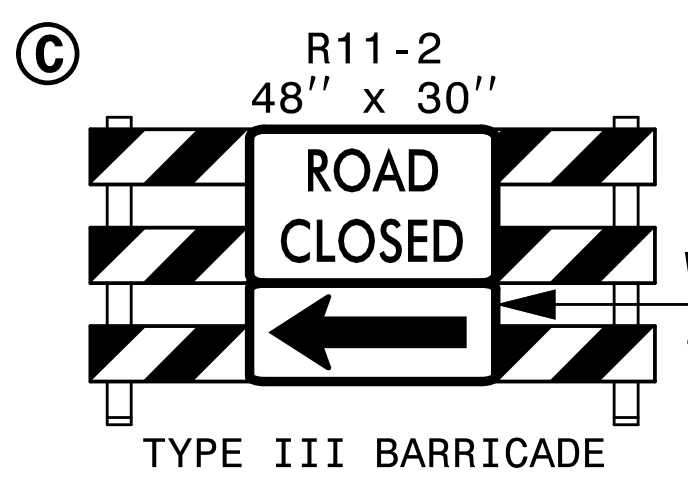
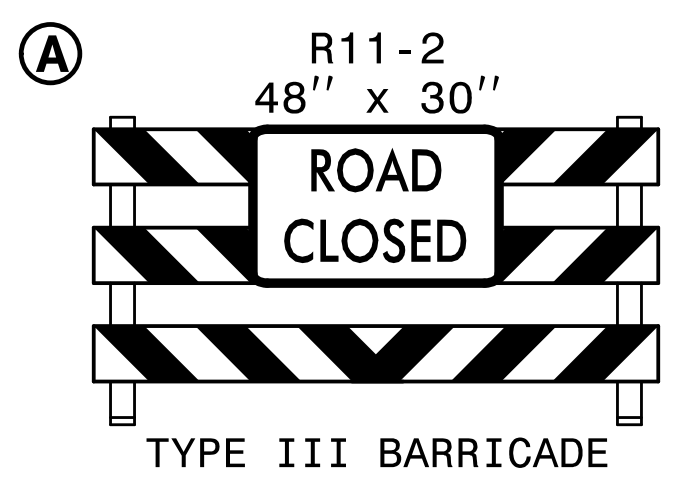
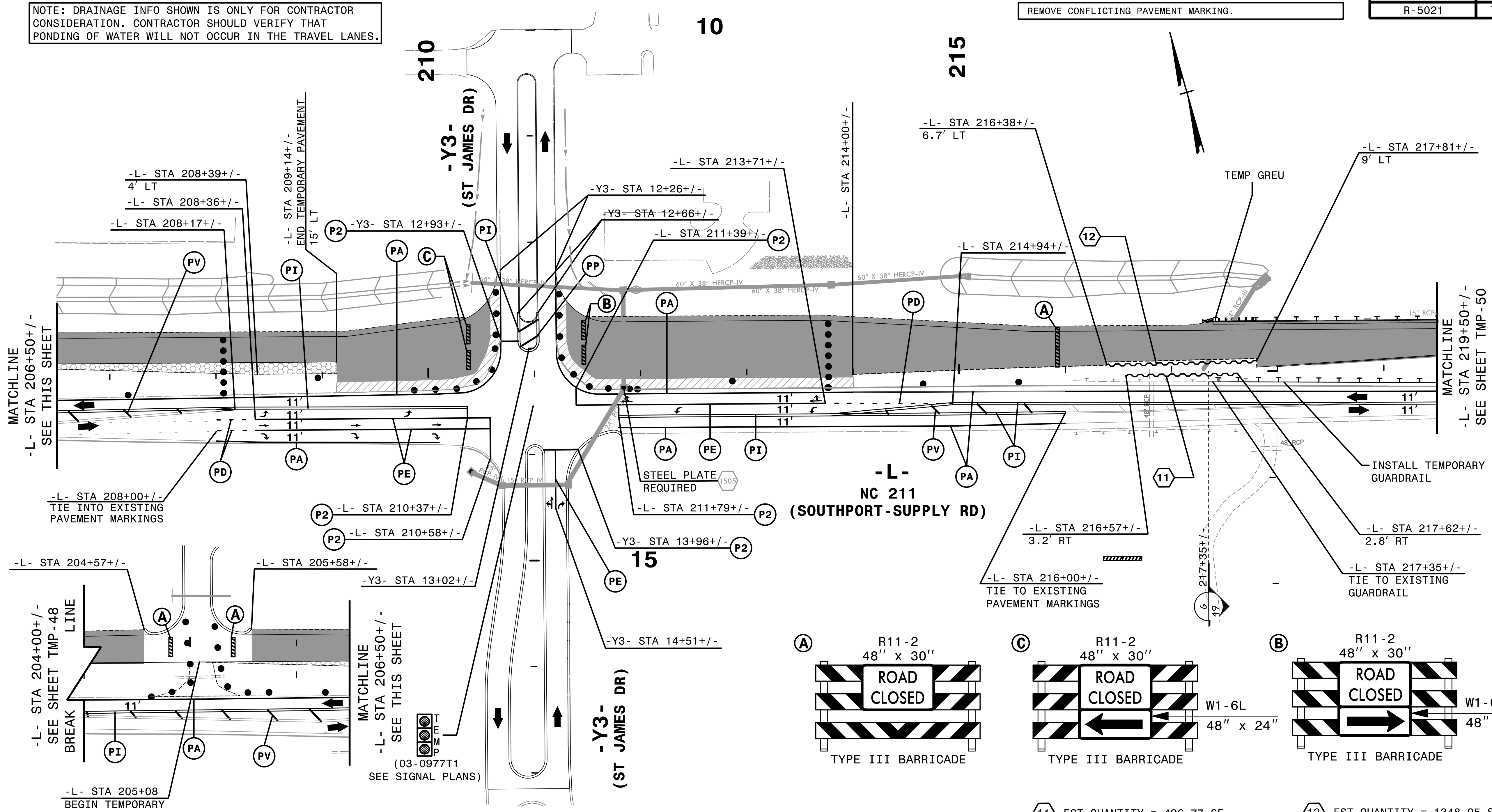

11 EST QUANTITY = 496.77 SF
 TEMPORARY SHORING
 FROM -L- STA 216+57+/-, 3.2' RT
 TO -L- STA 217+62+/-, 2.8' RT
 (SEE SHEET TMP-2G FOR TEMPORARY SHORING NOTES)

12 EST QUANTITY = 1348.05 SF
 TEMPORARY SHORING
 FROM -L- STA 216+38+/-, 6.7' LT
 TO -L- STA 217+81+/-, 9' LT
 (SEE SHEET TMP-2G FOR TEMPORARY SHORING NOTES)

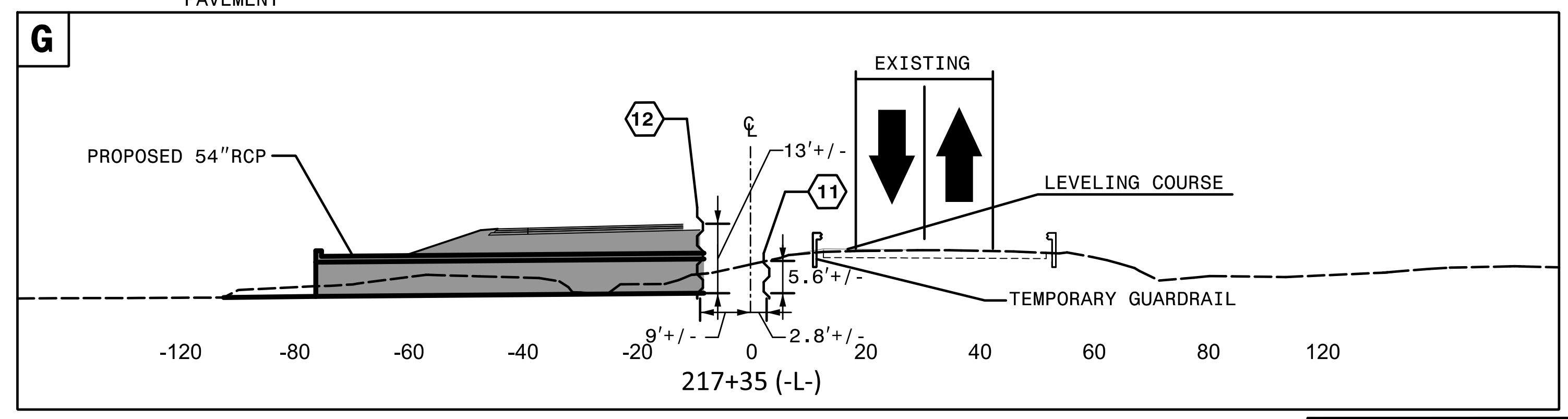

4:53:00 PM
...TCPL_5021_Tc_pld9a.dgn
\$\$\$\$\$USERNAME\$\$\$\$\$

HNTB HNTB NORTH CAROLINA, P.C.
343 E. Six Forks Road, Suite 200
Raleigh, North Carolina 27609
NC License No: C-1554

APPROVED: *Helen Shyne*
 DATE: 9/9/2021
 SEAL
 DOCUMENT NOT CONSIDERED FINAL
 UNLESS ALL SIGNATURES COMPLETED

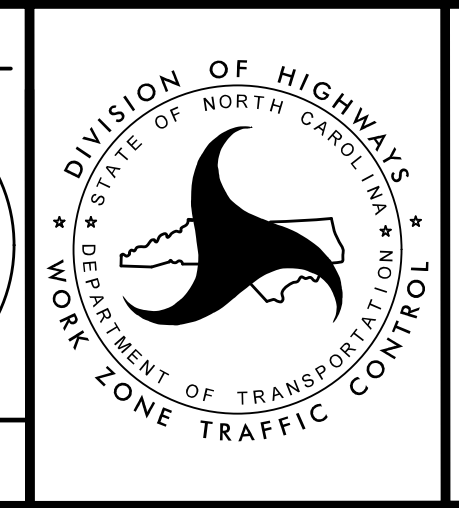

DIVISION OF HIGHWAYS
 DEPARTMENT OF TRANSPORTATION
 WORK ZONE TRAFFIC CONTROL
 TRANSPORTATION
 MANAGEMENT PLAN
 PHASE IA
 DETAIL

PROJ. REFERENCE NO.	SHEET NO.
R-5021	TMP-50

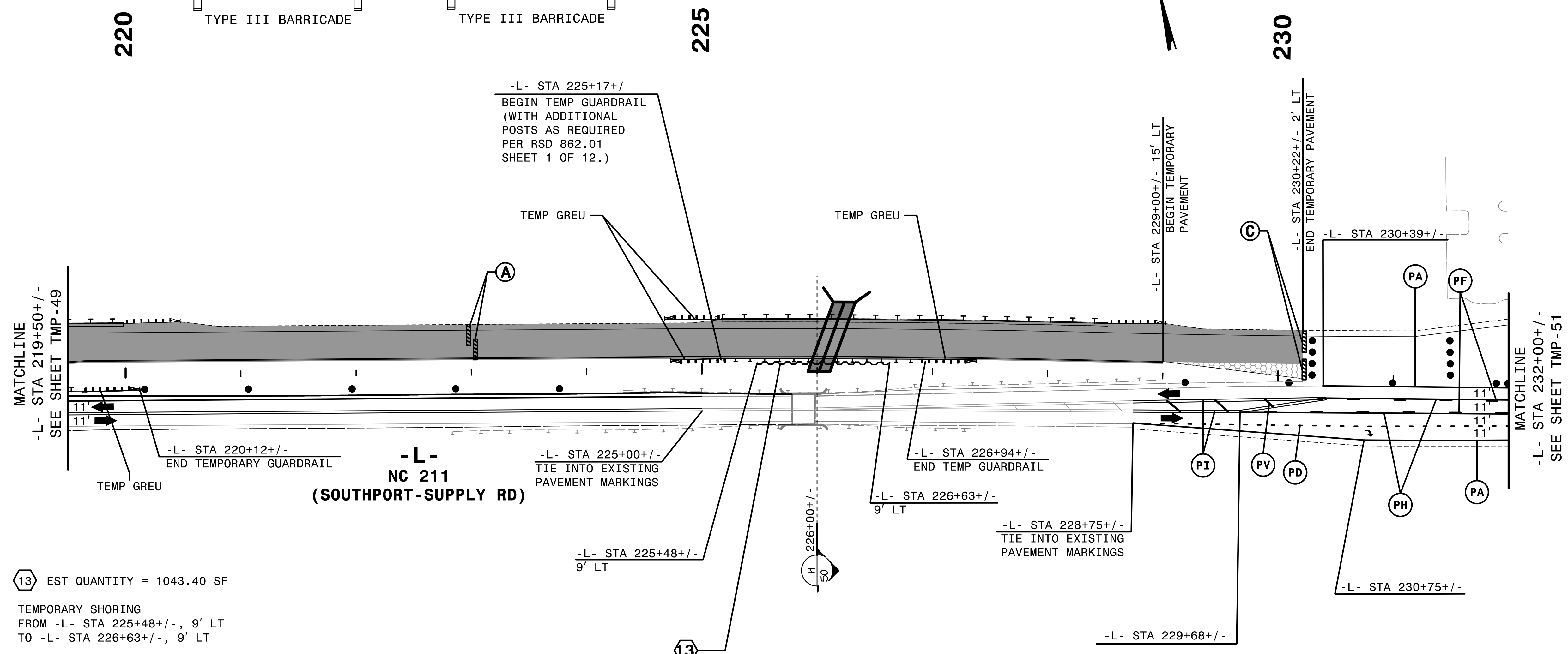
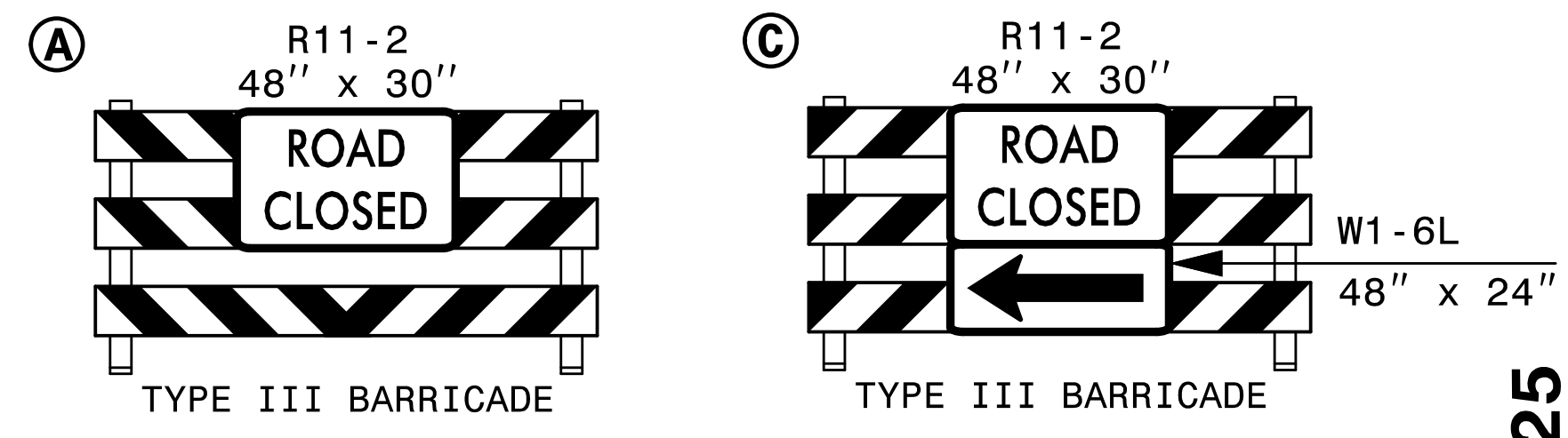

13 EST QUANTITY = 1043.40 SF
 TEMPORARY SHORING
 FROM -L- STA 225+48+/-, 9' LT
 TO -L- STA 226+63+/-, 9' LT
 (SEE SHEET TMP-2G FOR
 TEMPORARY SHORING NOTES)

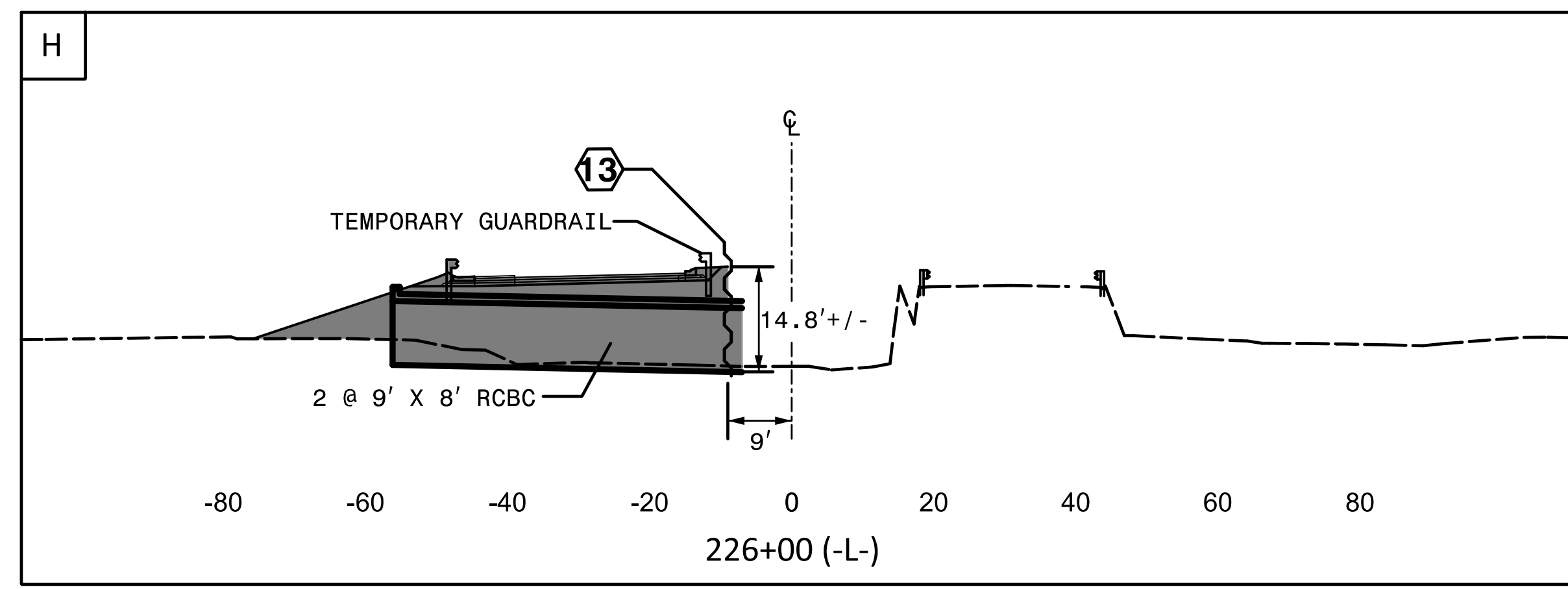

REMOVE CONFLICTING PAVEMENT MARKING.

2/6/2019
 HNTB
 \CP\5021\Tc_p1d10a.dgn

HNTB
 HNTB NORTH CAROLINA, P.C.
 343 E. Six Forks Road, Suite 200
 Raleigh, North Carolina 27609
 NC License No: C-1554

APPROVED: *Helen Skyy*
 DATE: 2/6/2019
 SEAL
 PROFESSIONAL SEAL
 ENGINEER
 HELEN SKYY

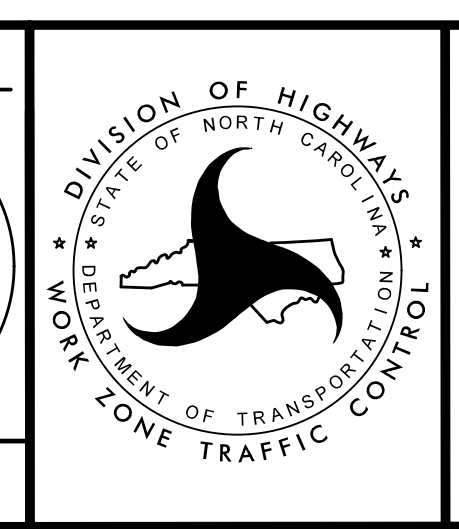

TRANSPORTATION
 MANAGEMENT PLAN
 PHASE IA
 DETAIL

DOCUMENT NOT CONSIDERED FINAL
 UNLESS ALL SIGNATURES COMPLETED

PROJ. REFERENCE NO.	SHEET NO.
R-5021	TMP-51

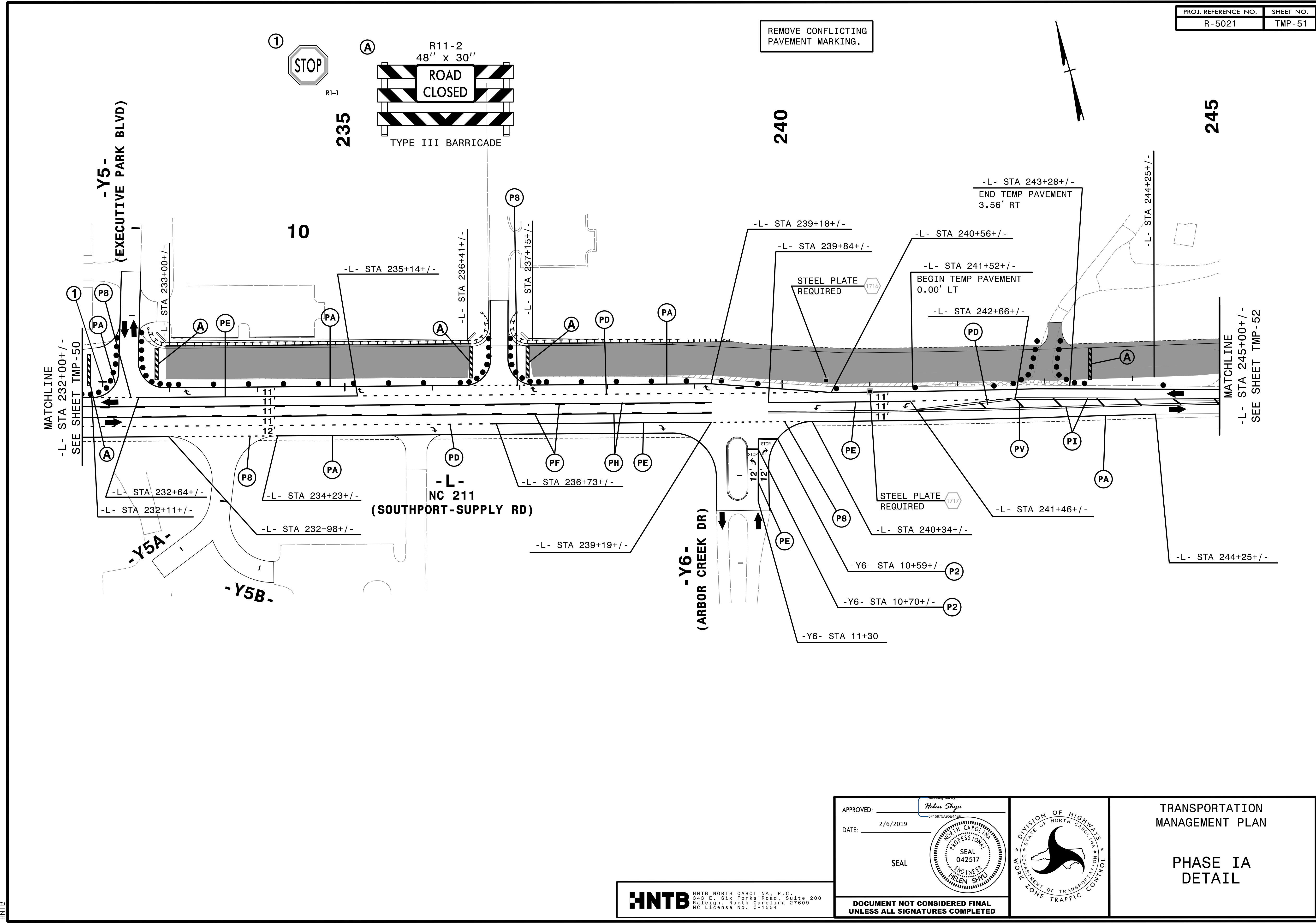

2/6/2019
 C:\CPV\5021\TC_pidla.dgn
 HNTB

HNTB HNTB NORTH CAROLINA, P.C.
 343 E. Six Forks Road, Suite 200
 Raleigh, North Carolina 27609
 NC License No: C-1554

APPROVED: *Helen Skyy*
 DATE: 2/6/2019
 SEAL
 DOCUMENT NOT CONSIDERED FINAL
 UNLESS ALL SIGNATURES COMPLETED

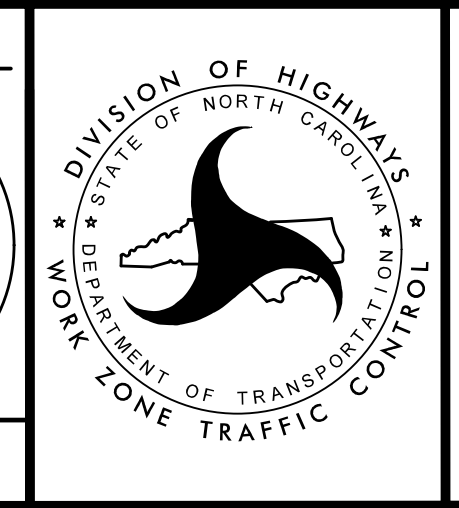

TRANSPORTATION
 MANAGEMENT PLAN
 PHASE IA
 DETAIL

REMOVE CONFLICTING PAVEMENT MARKING.

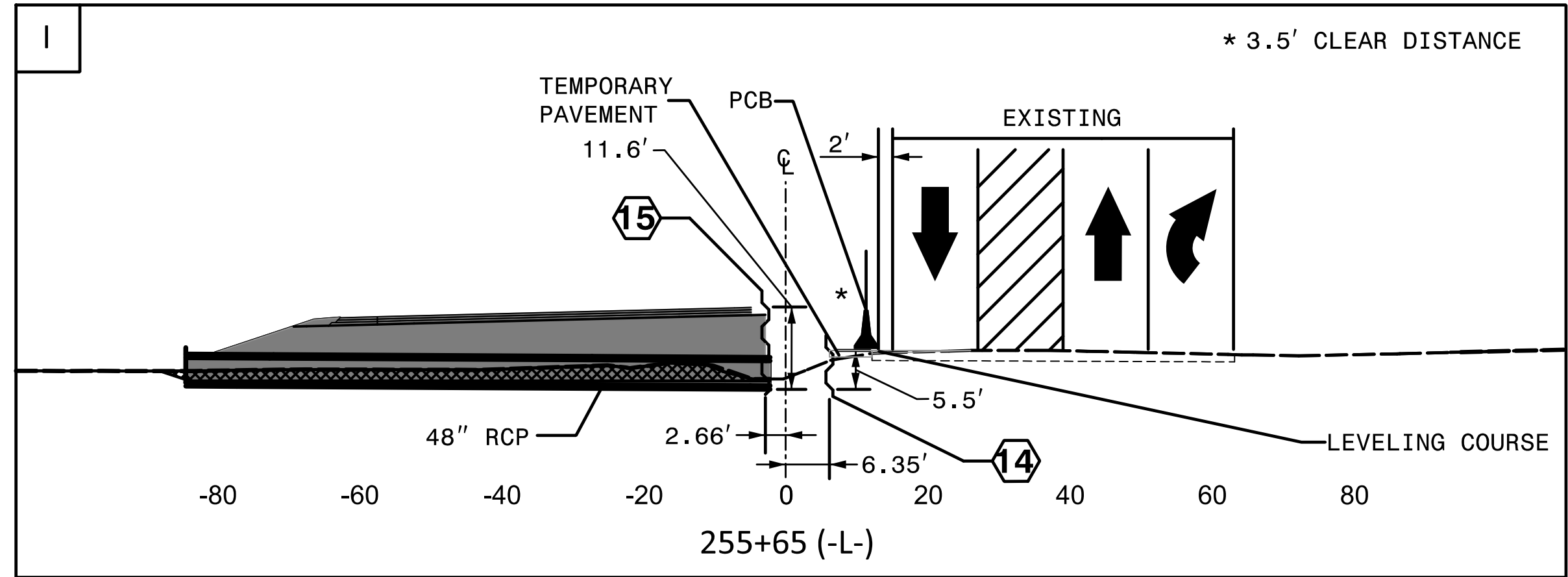
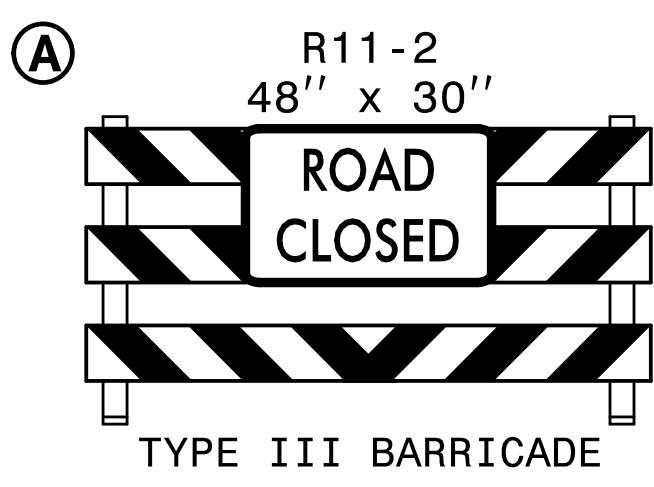
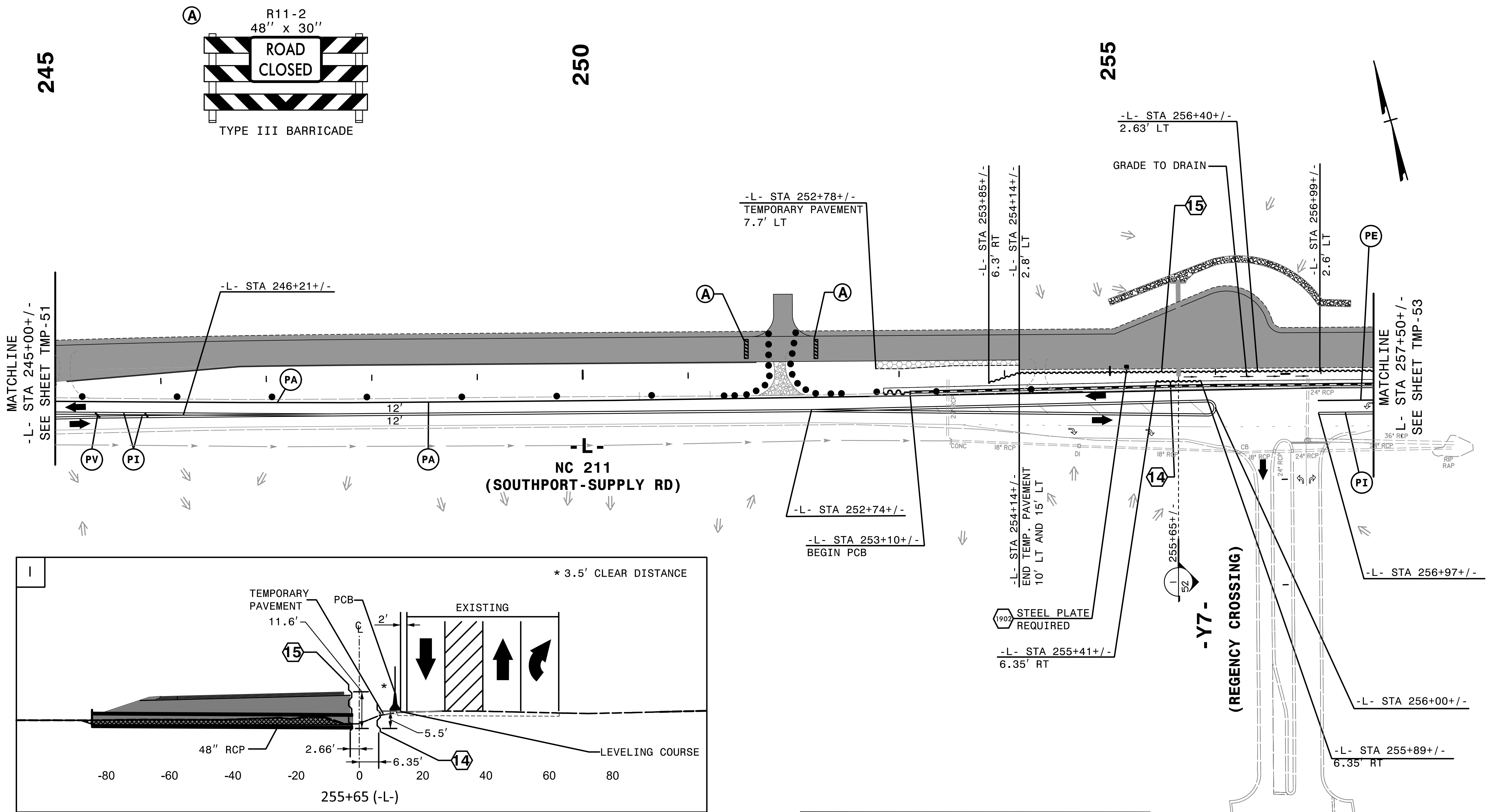

14 EST QUANTITY = 170.5 SF

TEMPORARY SHORING
 FROM -L- STA 255+41+/-, 6.4' RT
 TO -L- STA 255+89+/-, 6.4' RT

(SEE SHEET TMP-2G FOR
 TEMPORARY SHORING NOTES)

15 EST QUANTITY = 8652.67 SF

TEMPORARY SHORING
 FROM -L- STA 253+85+/-, 6.3' RT
 TO -L- STA 254+14+/-, 2.8' LT AND
 FROM -L- STA 254+14+/-, 2.8' LT
 TO -L- STA 256+40+/-, 2.63' LT AND
 FROM -L- STA 256+40+/-, 2.63' LT
 TO -L- STA 256+99+/-, 2.6' LT AND
 FROM -L- STA 256+99+/-, 2.6' LT
 TO -L- STA 258+37+/-, 2.1' LT AND
 FROM -L- STA 258+37+/-, 2.1' LT
 TO -L- STA 260+12+/-, 0.3' LT AND
 FROM -L- STA 260+12+/-, 0.3' LT
 TO -L- STA 262+79+/-, 8.9' LT.

(SEE SHEET TMP-2G FOR
 TEMPORARY SHORING NOTES)

NOTE: DRAINAGE INFO SHOWN IS ONLY FOR CONTRACTOR CONSIDERATION. CONTRACTOR SHOULD VERIFY THAT PONDING OF WATER WILL NOT OCCUR IN THE TRAVEL LANES.

4:53:05 PM
 \\TCPLV5021_fc_pld12a.dgn
 \$\$\$USERNAME\$\$\$

HNTB HNTB NORTH CAROLINA, P.C.
 343 E. Six Forks Road, Suite 200
 Raleigh, North Carolina 27609
 NC License No: C-1554

APPROVED: *Helen Shyne*
 DATE: 9/9/2021

SEAL

DOCUMENT NOT CONSIDERED FINAL
 UNLESS ALL SIGNATURES COMPLETED

DIVISION OF HIGHWAYS
 STATE OF NORTH CAROLINA
 DEPARTMENT OF TRANSPORTATION
 WORK ZONE TRAFFIC CONTROL

TRANSPORTATION
 MANAGEMENT PLAN

PHASE IA
 DETAIL

REMOVE CONFLICTING PAVEMENT MARKING.

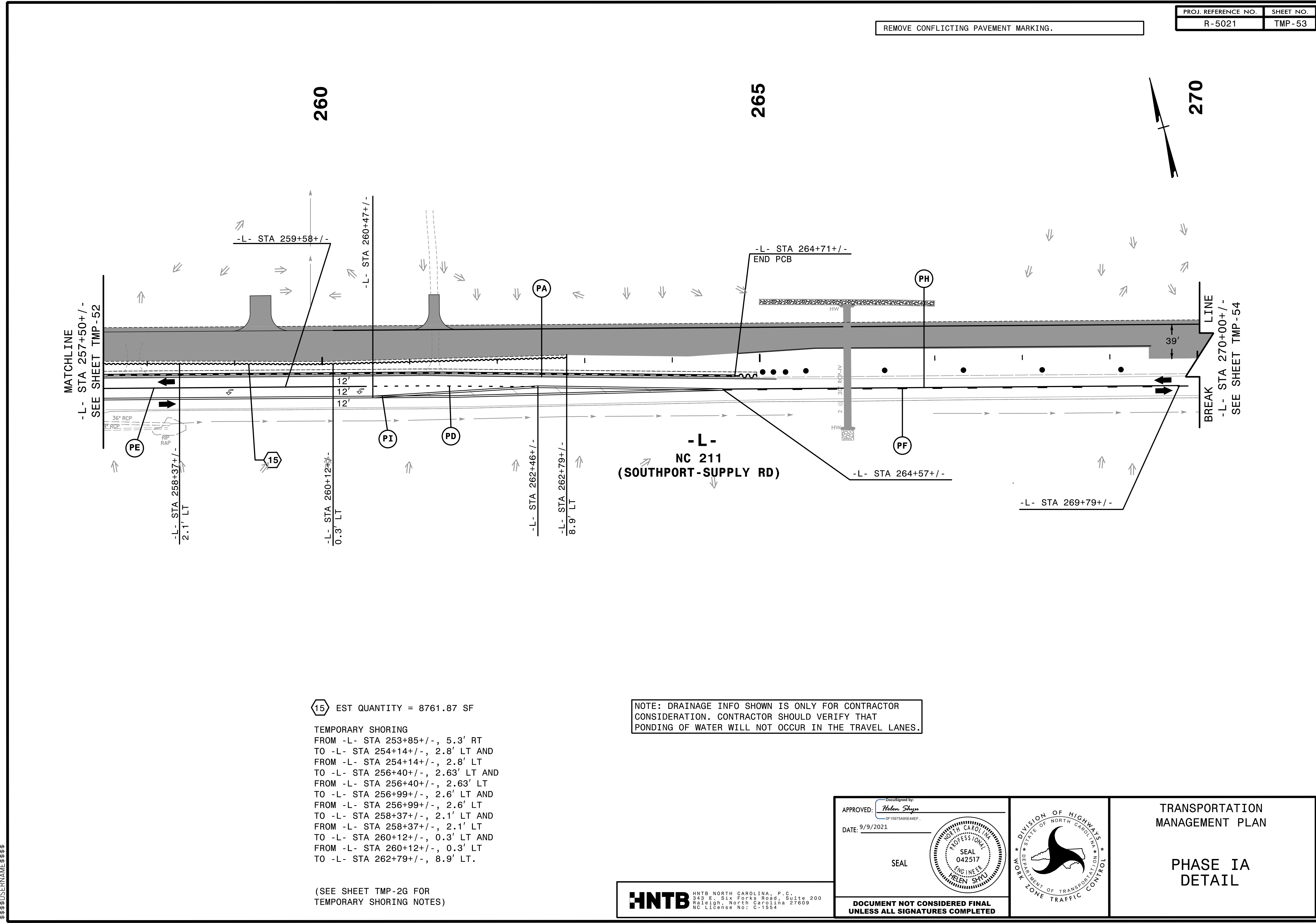

15 EST QUANTITY = 8761.87 SF

TEMPORARY SHORING
 FROM -L- STA 253+85+/-, 5.3' RT
 TO -L- STA 254+14+/-, 2.8' LT AND
 FROM -L- STA 254+14+/-, 2.8' LT
 TO -L- STA 256+40+/-, 2.63' LT AND
 FROM -L- STA 256+40+/-, 2.63' LT
 TO -L- STA 256+99+/-, 2.6' LT AND
 FROM -L- STA 256+99+/-, 2.6' LT
 TO -L- STA 258+37+/-, 2.1' LT AND
 FROM -L- STA 258+37+/-, 2.1' LT
 TO -L- STA 260+12+/-, 0.3' LT AND
 FROM -L- STA 260+12+/-, 0.3' LT
 TO -L- STA 262+79+/-, 8.9' LT.

(SEE SHEET TMP-2G FOR TEMPORARY SHORING NOTES)

NOTE: DRAINAGE INFO SHOWN IS ONLY FOR CONTRACTOR CONSIDERATION. CONTRACTOR SHOULD VERIFY THAT PONDING OF WATER WILL NOT OCCUR IN THE TRAVEL LANES.

4:53:08 PM
...\\TCPL\5021\TC_pl\dl3a.dgn
\$\$\$\$\$USERNAME\$\$\$\$\$

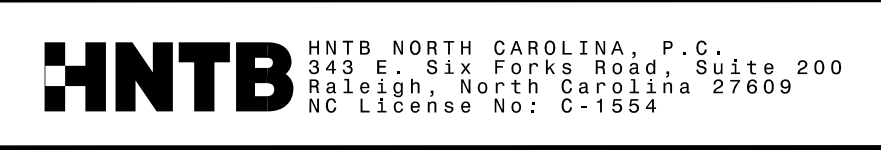

APPROVED: *Helen Shyu*
 DATE: 9/9/2021

SEAL

DOCUMENT NOT CONSIDERED FINAL UNLESS ALL SIGNATURES COMPLETED

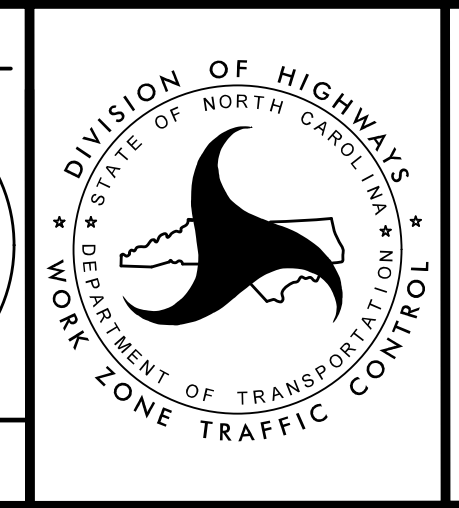

TRANSPORTATION MANAGEMENT PLAN

PHASE IA DETAIL

PROJ. REFERENCE NO.	SHEET NO.
R-5021	TMP-54

REMOVE CONFLICTING PAVEMENT MARKING.

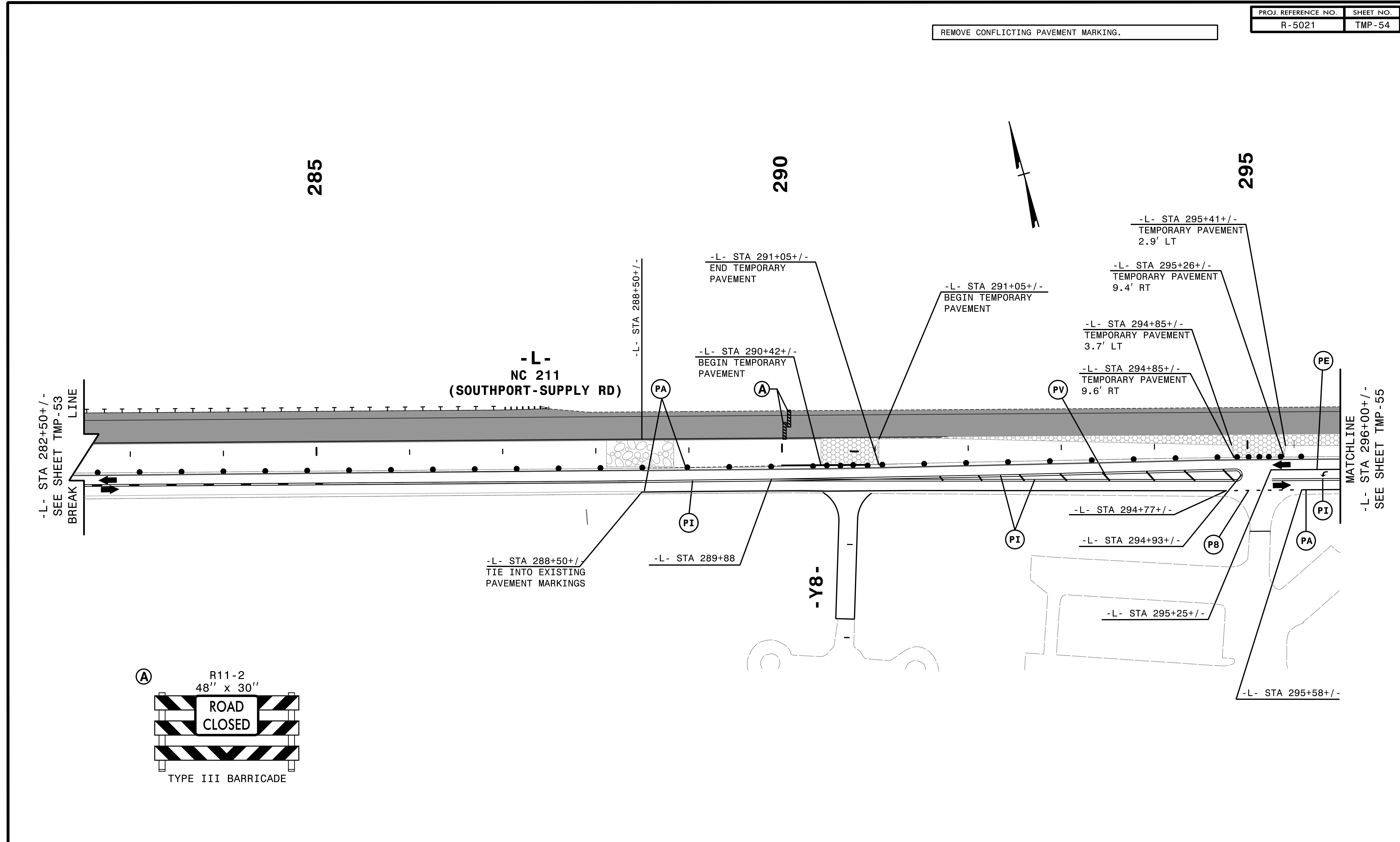

-L- STA 282+50+/-
SEE SHEET TMP-53
BREAK
LINE

-L-
NC 211
(SOUTHPORT-SUPPLY RD)

-L- STA 288+50+/-
TIE INTO EXISTING
PAVEMENT MARKINGS

-L- STA 289+88

-L- STA 291+05+/-
END TEMPORARY
PAVEMENT

-L- STA 290+42+/-
BEGIN TEMPORARY
PAVEMENT

-L- STA 291+05+/-
BEGIN TEMPORARY
PAVEMENT

-L- STA 295+26+/-
TEMPORARY PAVEMENT
9.4' RT

-L- STA 294+85+/-
TEMPORARY PAVEMENT
3.7' LT

-L- STA 294+85+/-
TEMPORARY PAVEMENT
9.6' RT

-L- STA 295+41+/-
TEMPORARY PAVEMENT
2.9' LT

-L- STA 294+77+/-

-L- STA 294+93+/-

-L- STA 295+25+/-

-L- STA 295+58+/-

MATCHLINE
-L- STA 296+00+/-
SEE SHEET TMP-55

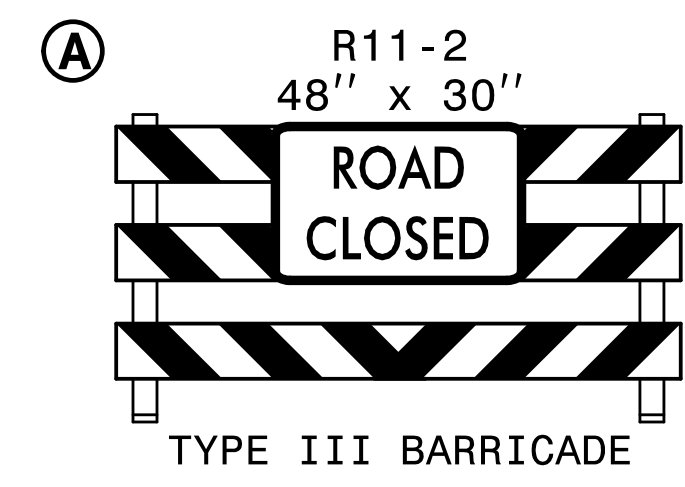

2/6/2019
HNTB

HNTB
HNTB NORTH CAROLINA, P.C.
343 E. Six Forks Road, Suite 200
Raleigh, North Carolina 27609
NC License No: C-1554

APPROVED: *Helen Skyy*
DATE: 2/6/2019
SEAL
DOCUMENT NOT CONSIDERED FINAL
UNLESS ALL SIGNATURES COMPLETED

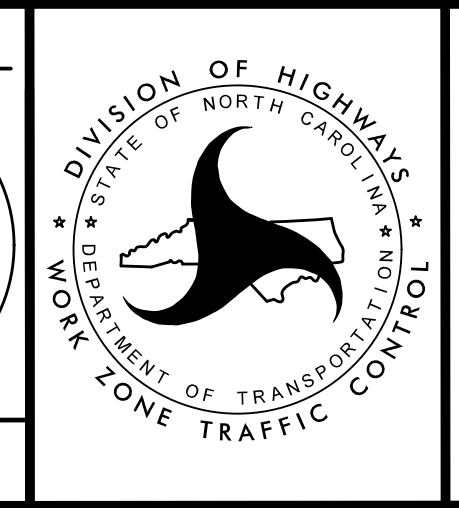

TRANSPORTATION
MANAGEMENT PLAN

PHASE IA
DETAIL

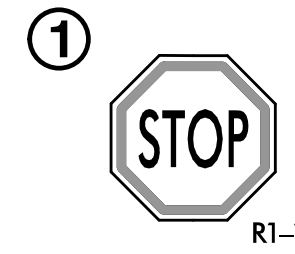

REMOVE CONFLICTING PAVEMENT MARKING.

INSTALL SIGNS AS REQUIRED PER RSD 1101.03 (SHEET 3 OF 9).

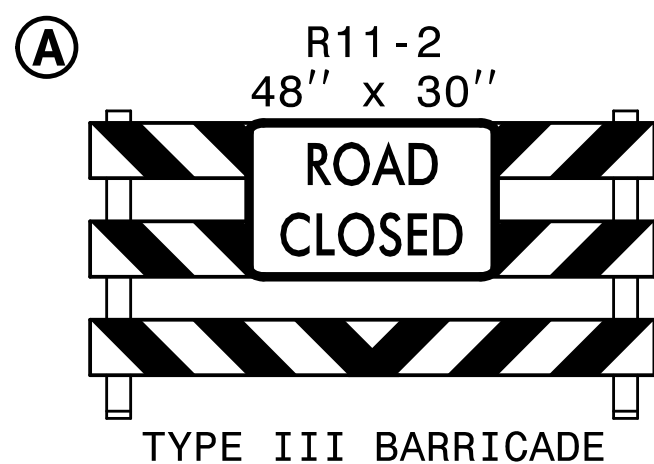
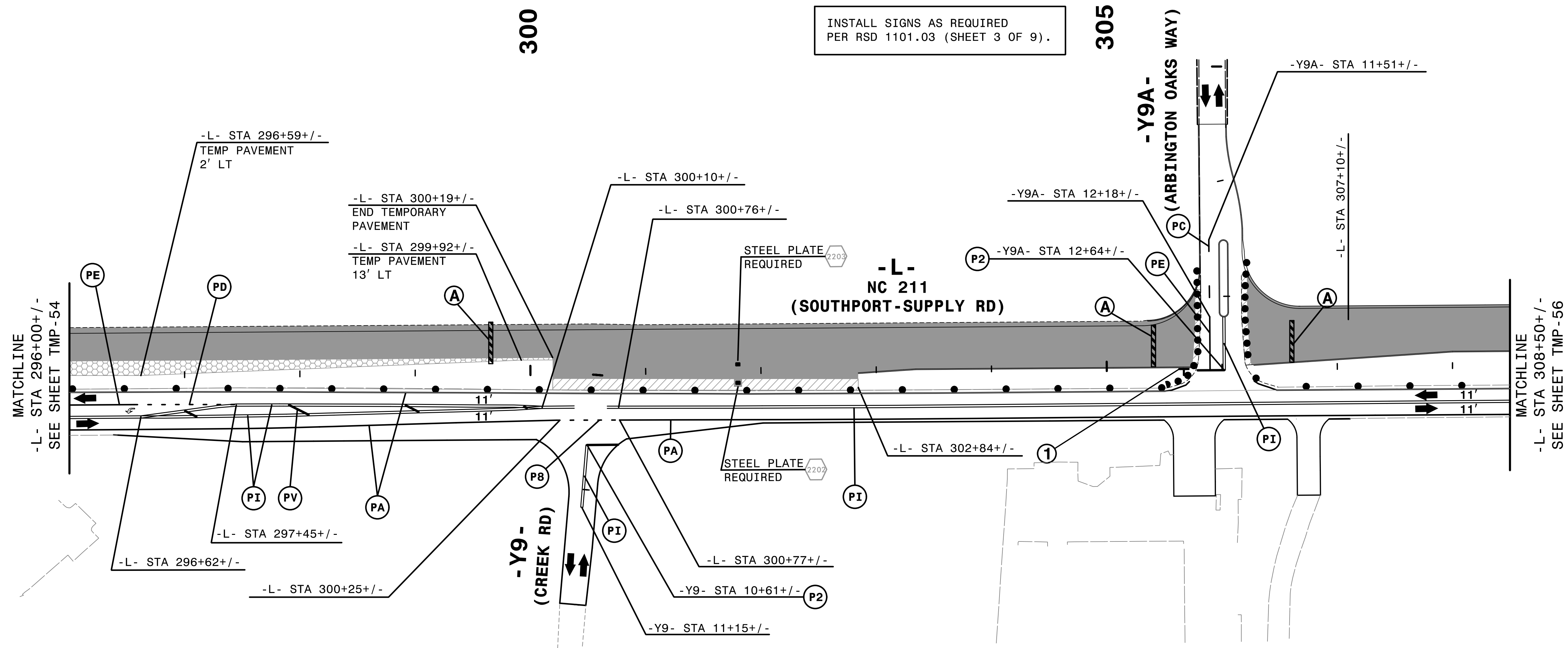

2:51:59 PM
 \\TC\p\5021\to_p\dl6ca.dgn
 \$\$\$USERNAME\$\$\$

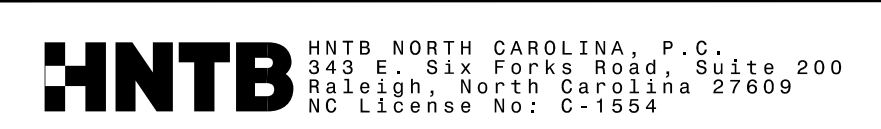

APPROVED: *Helen Shyu*
 DATE: 10/28/2021
 SEAL
 DOCUMENT NOT CONSIDERED FINAL UNLESS ALL SIGNATURES COMPLETED

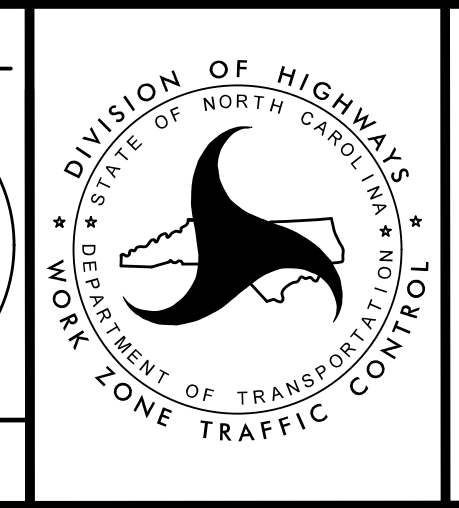

TRANSPORTATION MANAGEMENT PLAN
 PHASE IA DETAIL
 DIVISION OF HIGHWAYS
 STATE OF NORTH CAROLINA
 DEPARTMENT OF TRANSPORTATION
 WORK ZONE TRAFFIC CONTROL

REMOVE CONFLICTING PAVEMENT MARKING.

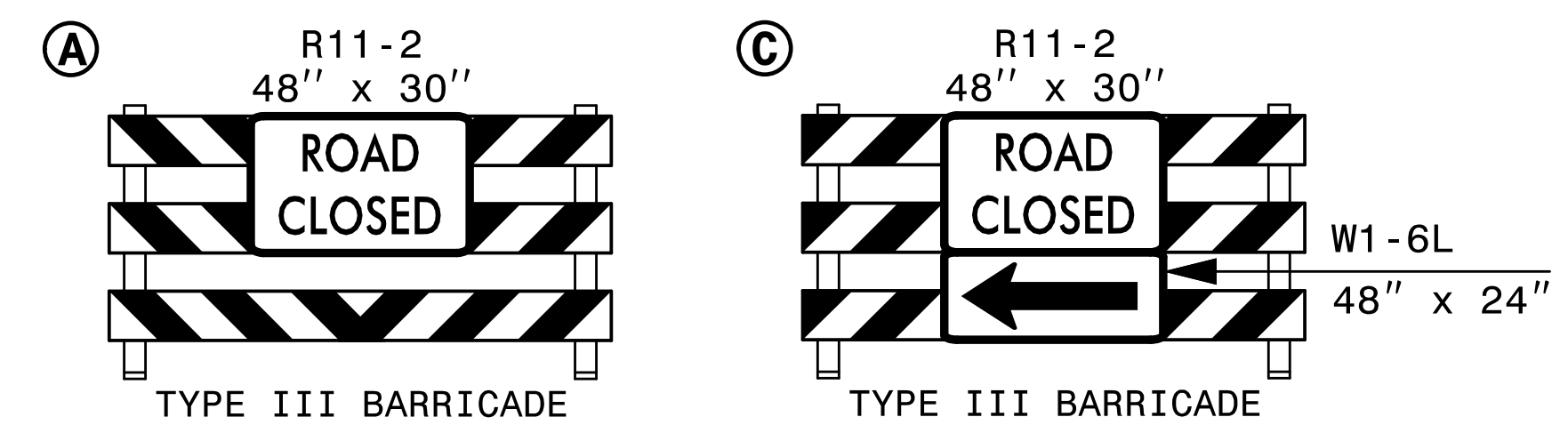

16 EST QUANTITY = 766.5 SF
 TEMPORARY SHORING
 FROM -L- STA 316+15+/-, 8' LT
 TO -L- STA 317+21+/-, 7.18' LT
 (SEE SHEET TMP-2G FOR TEMPORARY SHORING NOTES)

17 EST QUANTITY = 1106 SF
 TEMPORARY SHORING
 FROM -L- STA 316+02+/-, 9' LT
 TO -L- STA 317+23+/-, 9' LT
 (SEE SHEET TMP-2G FOR TEMPORARY SHORING NOTES)

INSTALL SIGNS AS REQUIRED PER RSD 1101.03 (SHEET 3 OF 9.)

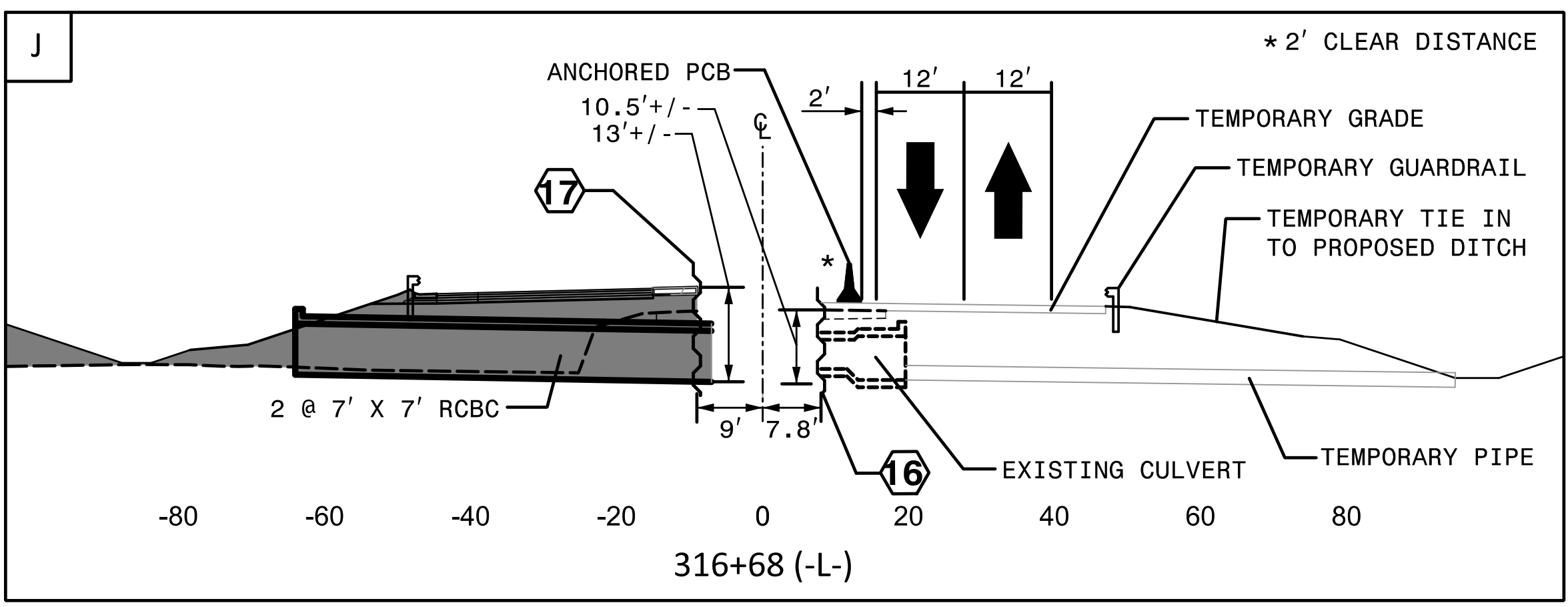
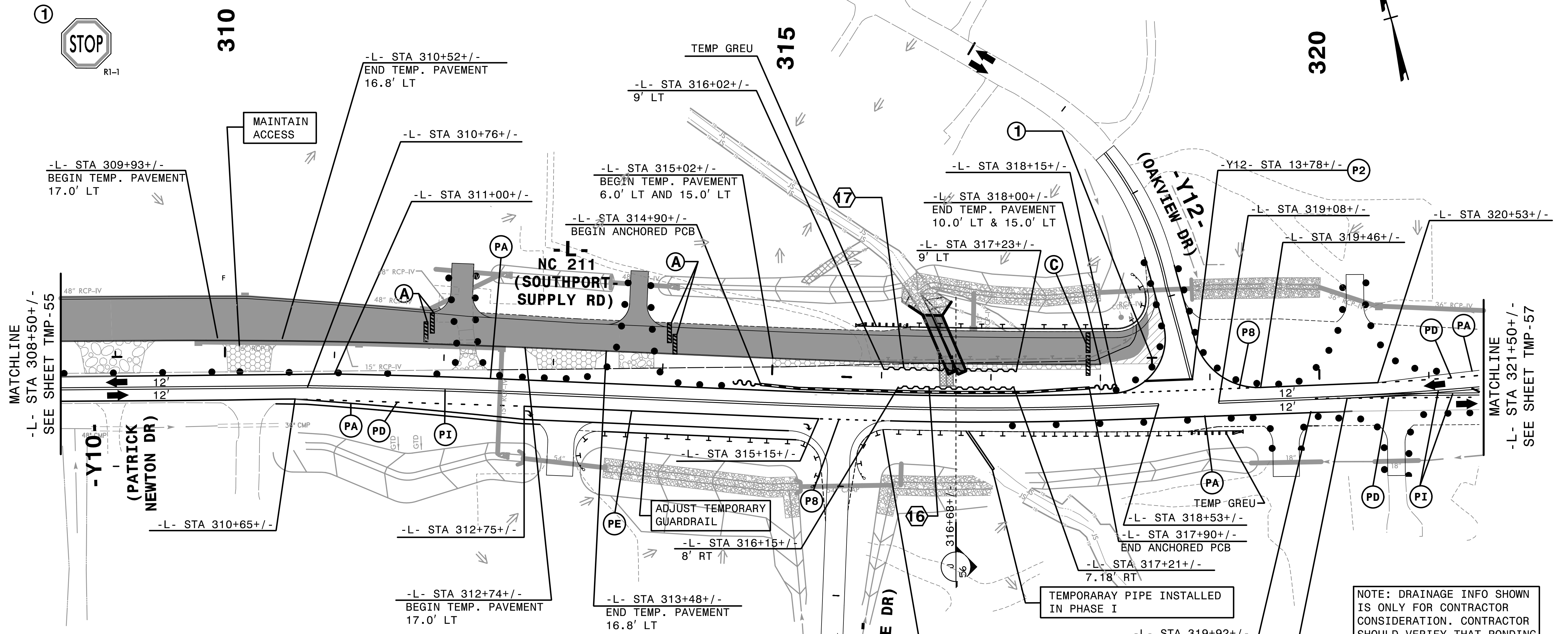

NOTE: DRAINAGE INFO SHOWN IS ONLY FOR CONTRACTOR CONSIDERATION. CONTRACTOR SHOULD VERIFY THAT PONDING OF WATER WILL NOT OCCUR IN THE TRAVEL LANES.

SEE EC-23A/CONST.23 FOR CULVERT PHASING

10/09/28 AM
\\TCF\5021\cpl\l\adgn
\$\$\$\$\$USERNAME\$\$\$\$\$

HNTB HNTB NORTH CAROLINA, P.C.
343 E. Six Forks Road, Suite 200
Raleigh, North Carolina 27609
NC License No: C-1554

APPROVED: *Helen Shyu*
 DATE: 10/28/2021
 SEAL
 DOCUMENT NOT CONSIDERED FINAL
 UNLESS ALL SIGNATURES COMPLETED

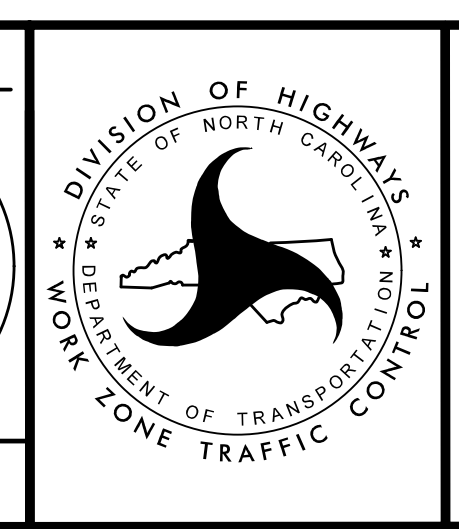

TRANSPORTATION
 MANAGEMENT PLAN
 PHASE IA
 DETAIL

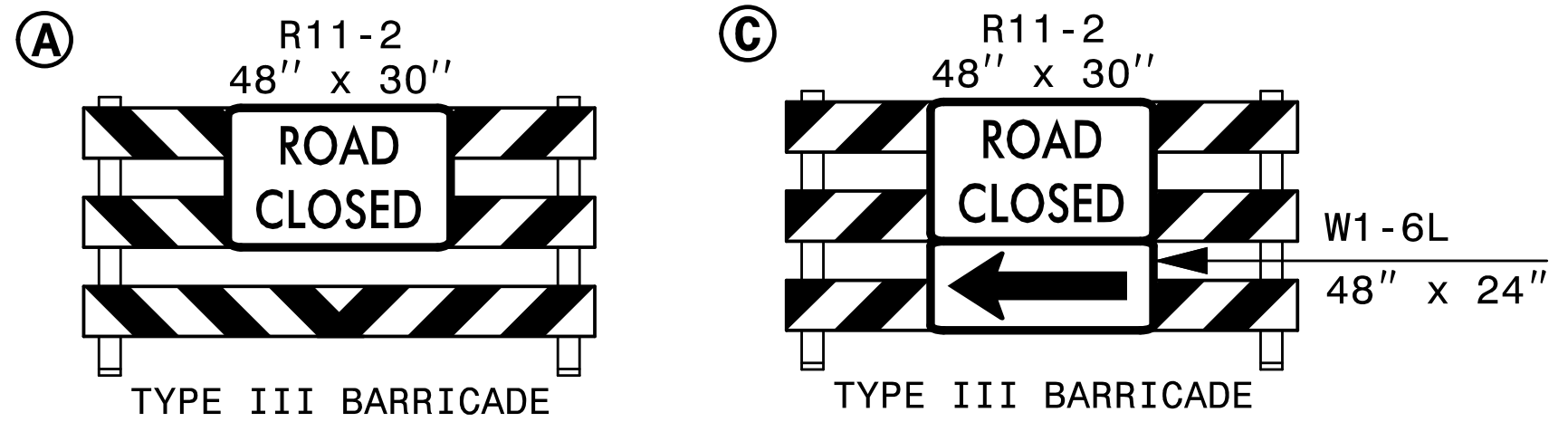

INSTALL SIGNS AS REQUIRED
PER RSD 1101.03 (SHEET 3 OF 9.)

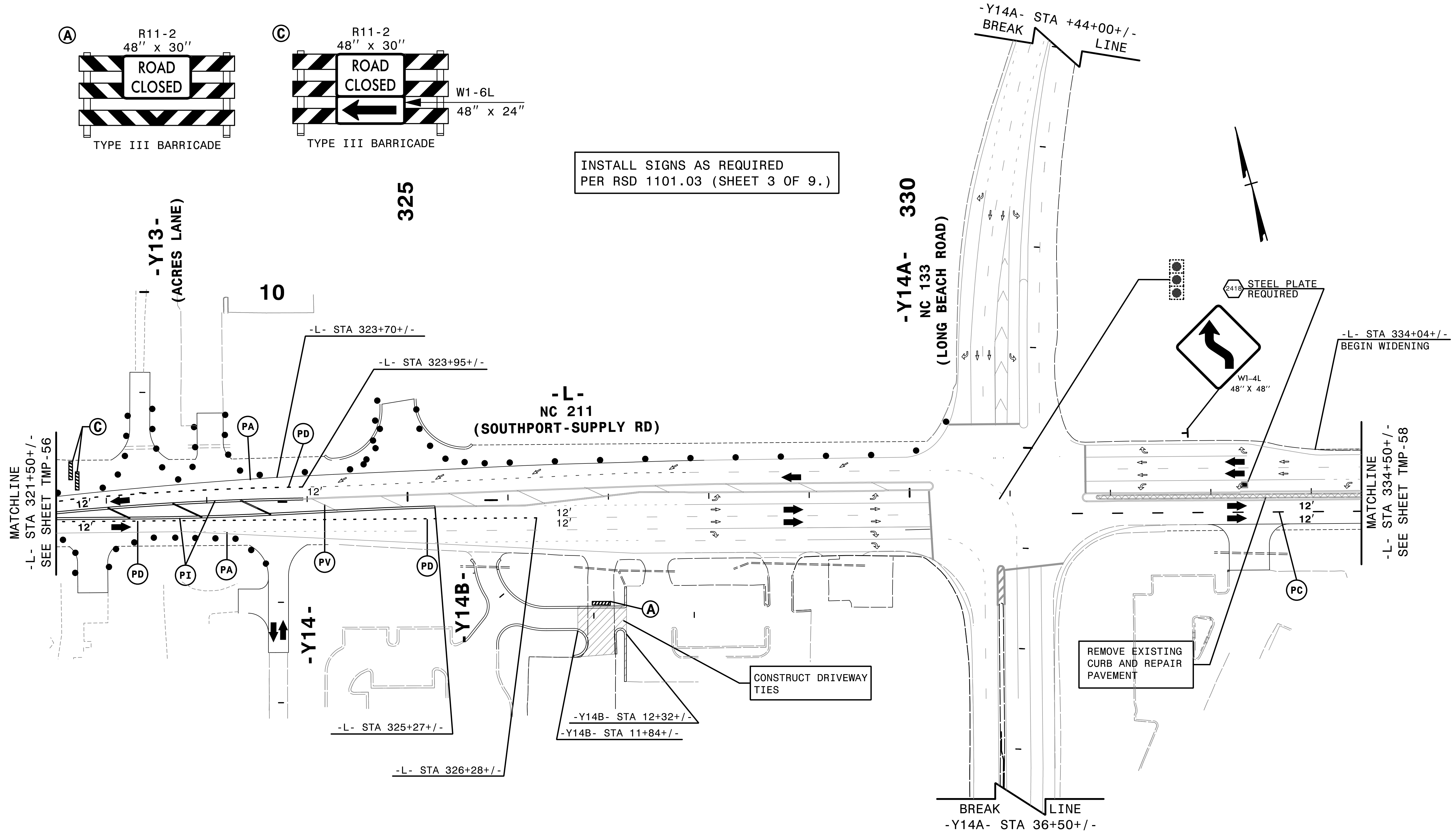

REMOVE CONFLICTING PAVEMENT MARKING.

4:53:25 PM
\\TCF\15021_Tc_pld18a.dgn
\$\$\$\$\$USERNAME\$\$\$\$\$

HNTB HNTB NORTH CAROLINA, P.C.
343 E. Six Forks Road, Suite 200
Raleigh, North Carolina 27609
NC License No: C-1554

APPROVED: *Helen Shyu*
DATE: 9/9/2021

SEAL

DOCUMENT NOT CONSIDERED FINAL
UNLESS ALL SIGNATURES COMPLETED

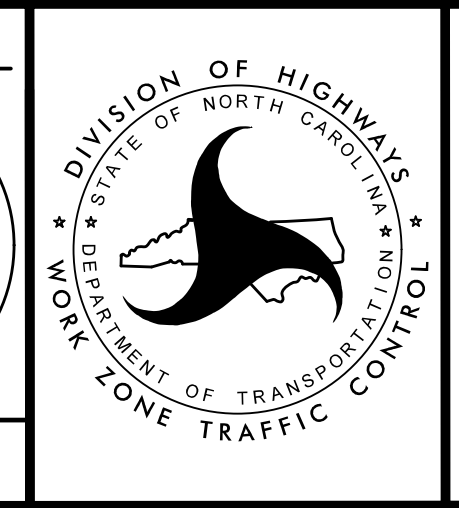

TRANSPORTATION
MANAGEMENT PLAN

PHASE IA
DETAIL

REMOVE CONFLICTING PAVEMENT MARKING.

PROJ. REFERENCE NO.	SHEET NO.
R-5021	TMP-58

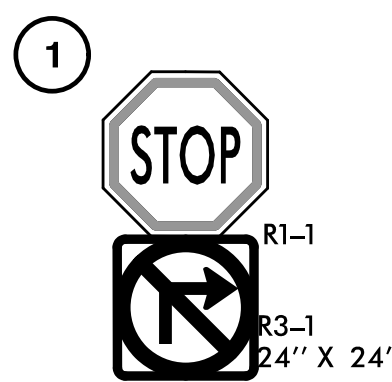
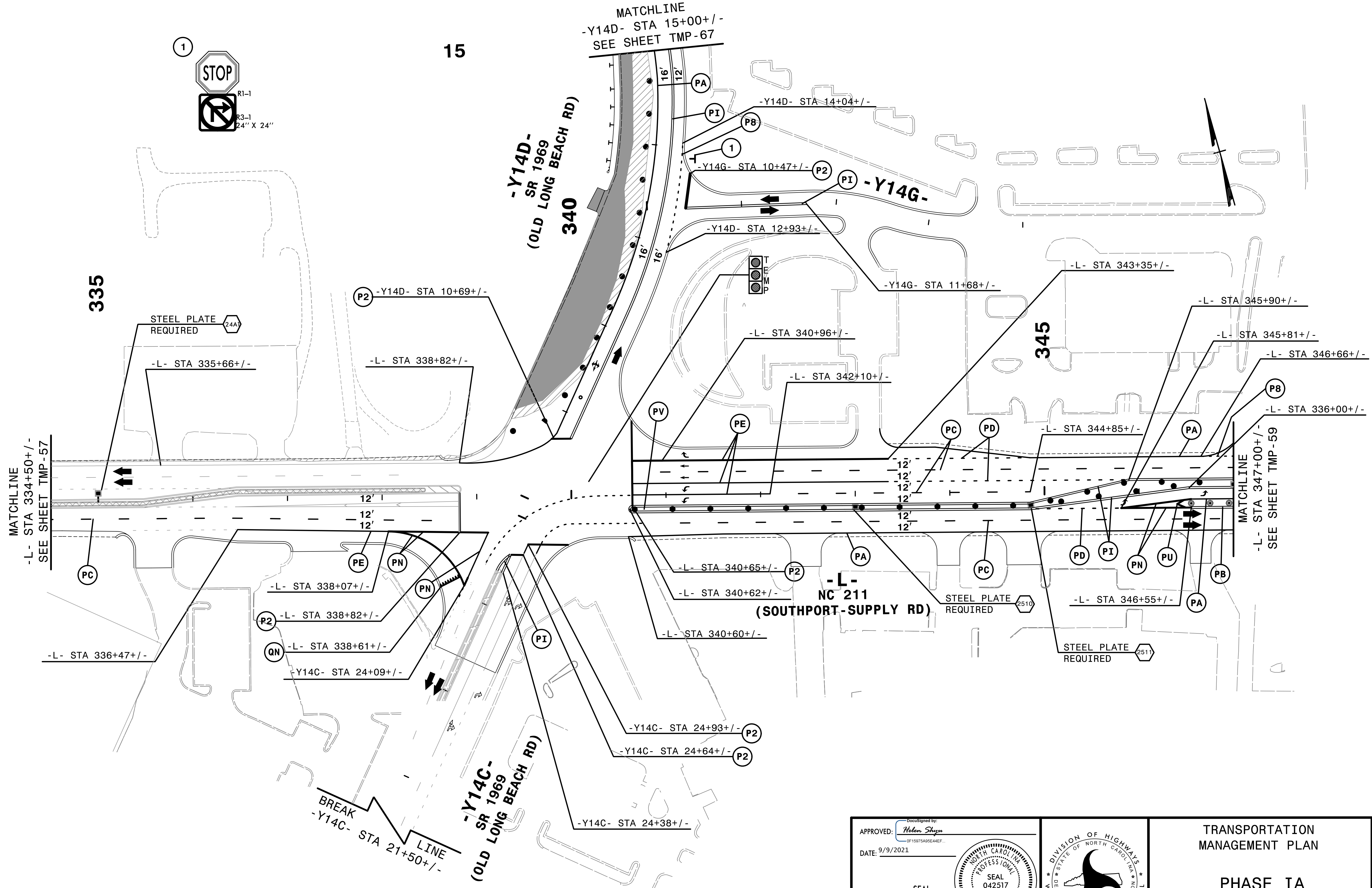

MATCHLINE
-L- STA 334+50+/-
SEE SHEET TMP-57

MATCHLINE
-L- STA 347+00+/-
SEE SHEET TMP-59

4:31:46 PM
\\TCF\15021_Tc_pid19a.dgn
\$\$\$\$\$USERNAME\$\$\$\$\$

HNTB
HNTB NORTH CAROLINA, P.C.
343 E. Six Forks Road, Suite 200
Raleigh, North Carolina 27609
NC License No: C-1554

APPROVED: *Helen Shyu*
DATE: 9/9/2021
SEAL
PROFESSIONAL ENGINEER
HELEN SHYU
042517

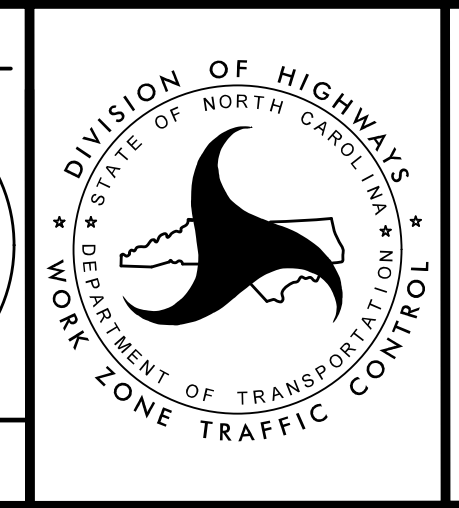

TRANSPORTATION
MANAGEMENT PLAN

PHASE IA
DETAIL

DOCUMENT NOT CONSIDERED FINAL
UNLESS ALL SIGNATURES COMPLETED

REMOVE CONFLICTING PAVEMENT MARKING.

PROJ. REFERENCE NO.	SHEET NO.
R-5021	TMP-59

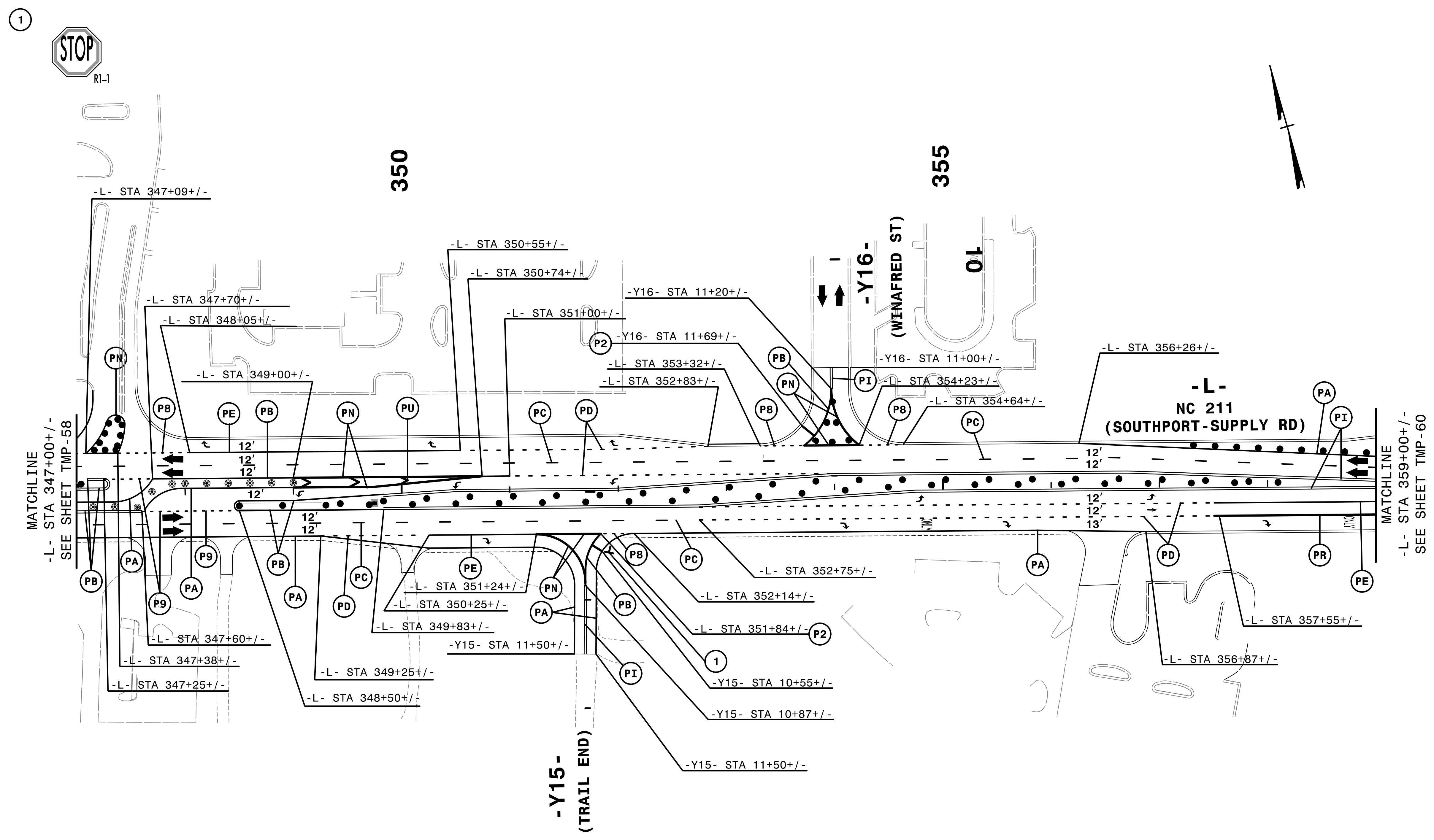

4:53:30 PM
...\\TC\...5021..._p\d20a.dgn
...\$USER\$

HNTB HNTB NORTH CAROLINA, P.C.
343 E. Six Forks Road, Suite 200
Raleigh, North Carolina 27609
NC License No: C-1554

APPROVED: *Helen Shyu*
DATE: 9/9/2021
SEAL
DOCUMENT NOT CONSIDERED FINAL
UNLESS ALL SIGNATURES COMPLETED

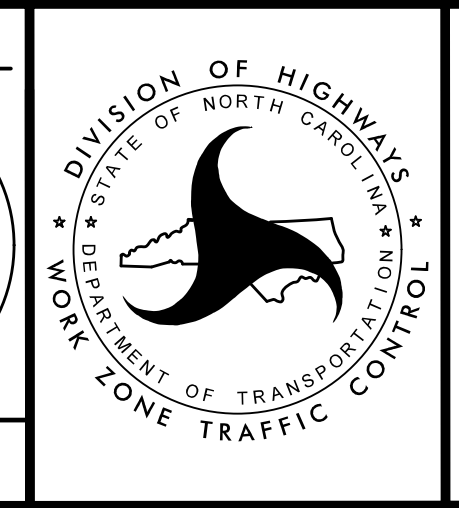
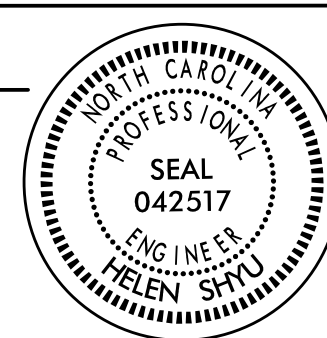

TRANSPORTATION
MANAGEMENT PLAN

PHASE IA
DETAIL

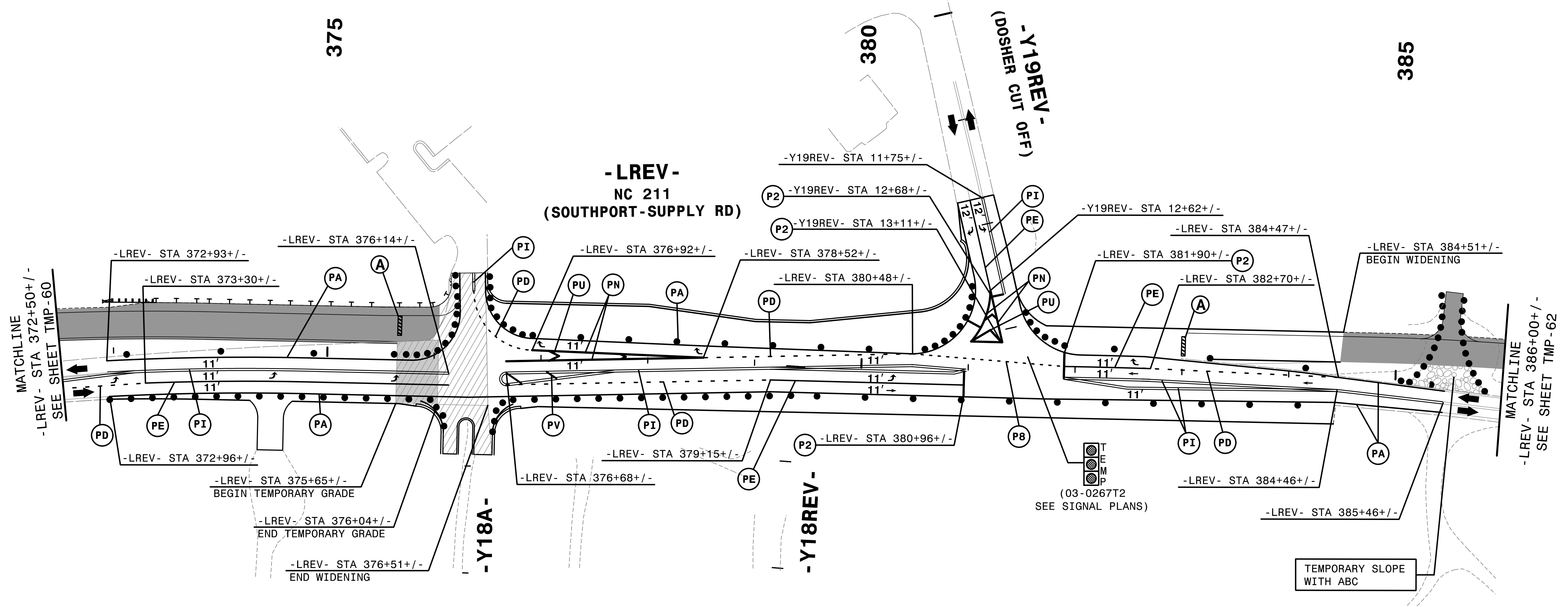
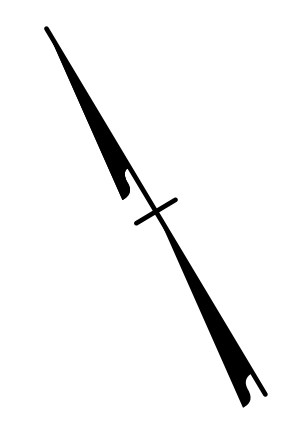
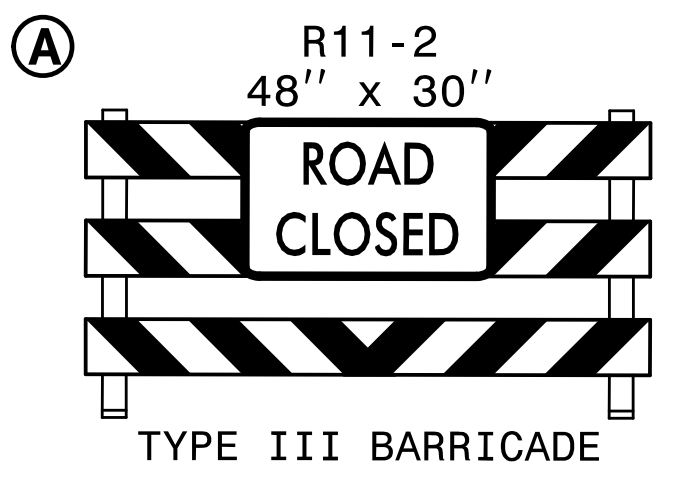

4:53:40 PM
 \\TCP\5021\T.C.\p122a.dgn
 \$\$\$USERNAME\$\$\$

REMOVE CONFLICTING PAVEMENT MARKING.

HNTB HNTB NORTH CAROLINA, P.C.
 343 E. SIX FORKS ROAD, SUITE 200
 RALEIGH, NORTH CAROLINA 27609
 NC LICENSE NO: C-1554

APPROVED: *Helen Shyne*
 DATE: 9/9/2021
 SEAL
 PROFESSIONAL ENGINEER
 HELEN SHYNE
 042517
 DOCUMENT NOT CONSIDERED FINAL
 UNLESS ALL SIGNATURES COMPLETED

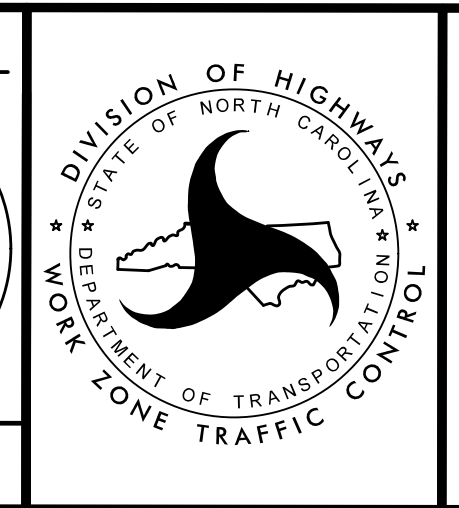

TRANSPORTATION
 MANAGEMENT PLAN
 PHASE IA
 DETAIL

PROJ. REFERENCE NO.	SHEET NO.
R-5021	TMP-62

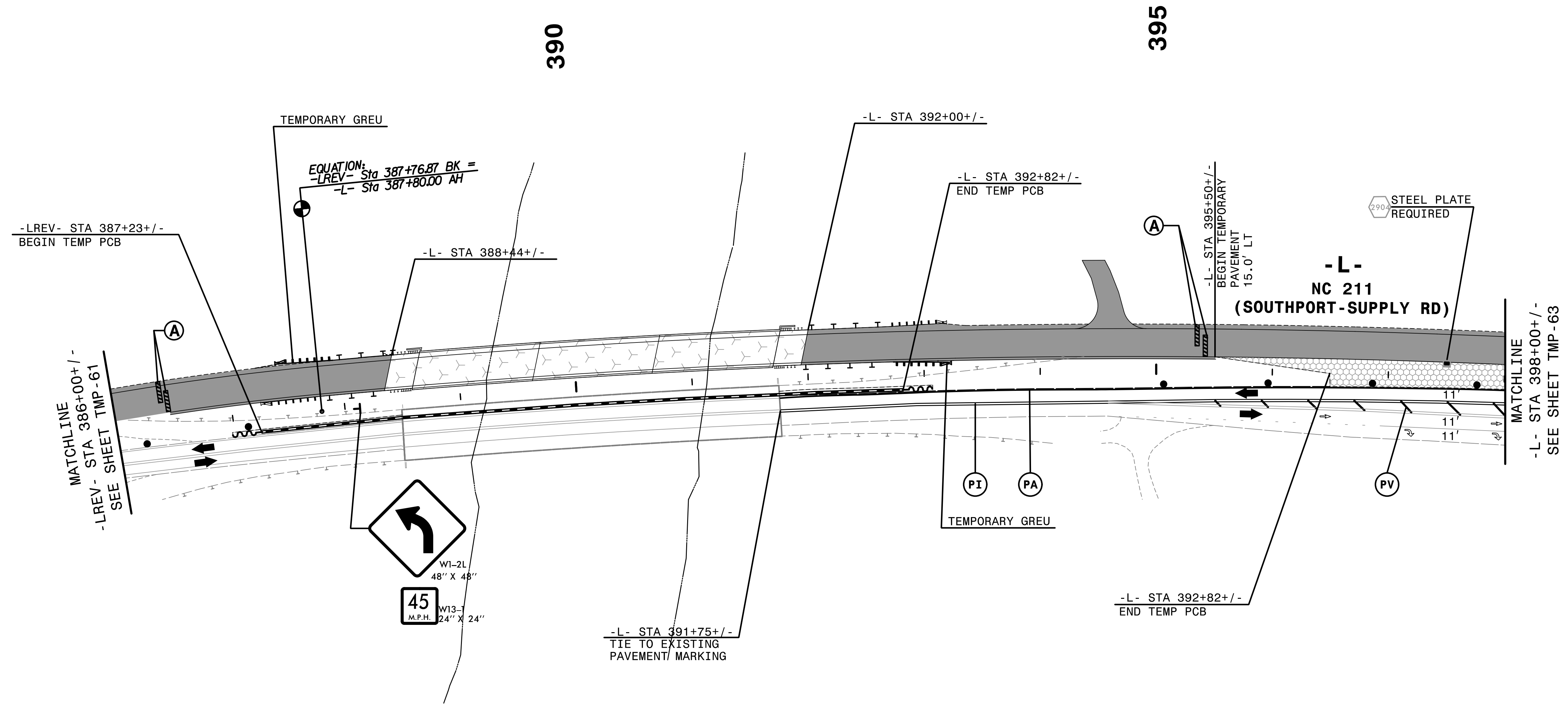
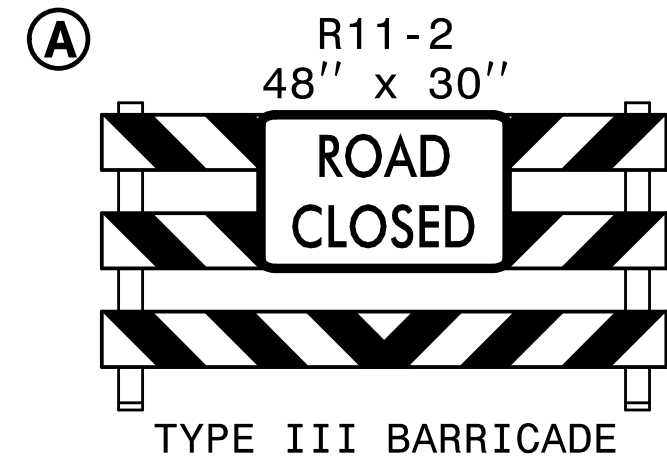

4:53:43 PM
 \\TCPL15021\cpl\d23a.dgn
 \$\$\$USERNAME\$\$\$

REMOVE CONFLICTING PAVEMENT MARKING.

HNTB HNTB NORTH CAROLINA, P.C.
 343 E. Six Forks Road, Suite 200
 Raleigh, North Carolina 27609
 NC License No: C-1554

APPROVED: *Helen Shyu*
 DATE: 9/9/2021
 SEAL
 DOCUMENT NOT CONSIDERED FINAL
 UNLESS ALL SIGNATURES COMPLETED

TRANSPORTATION
 MANAGEMENT PLAN
 PHASE IA
 DETAIL

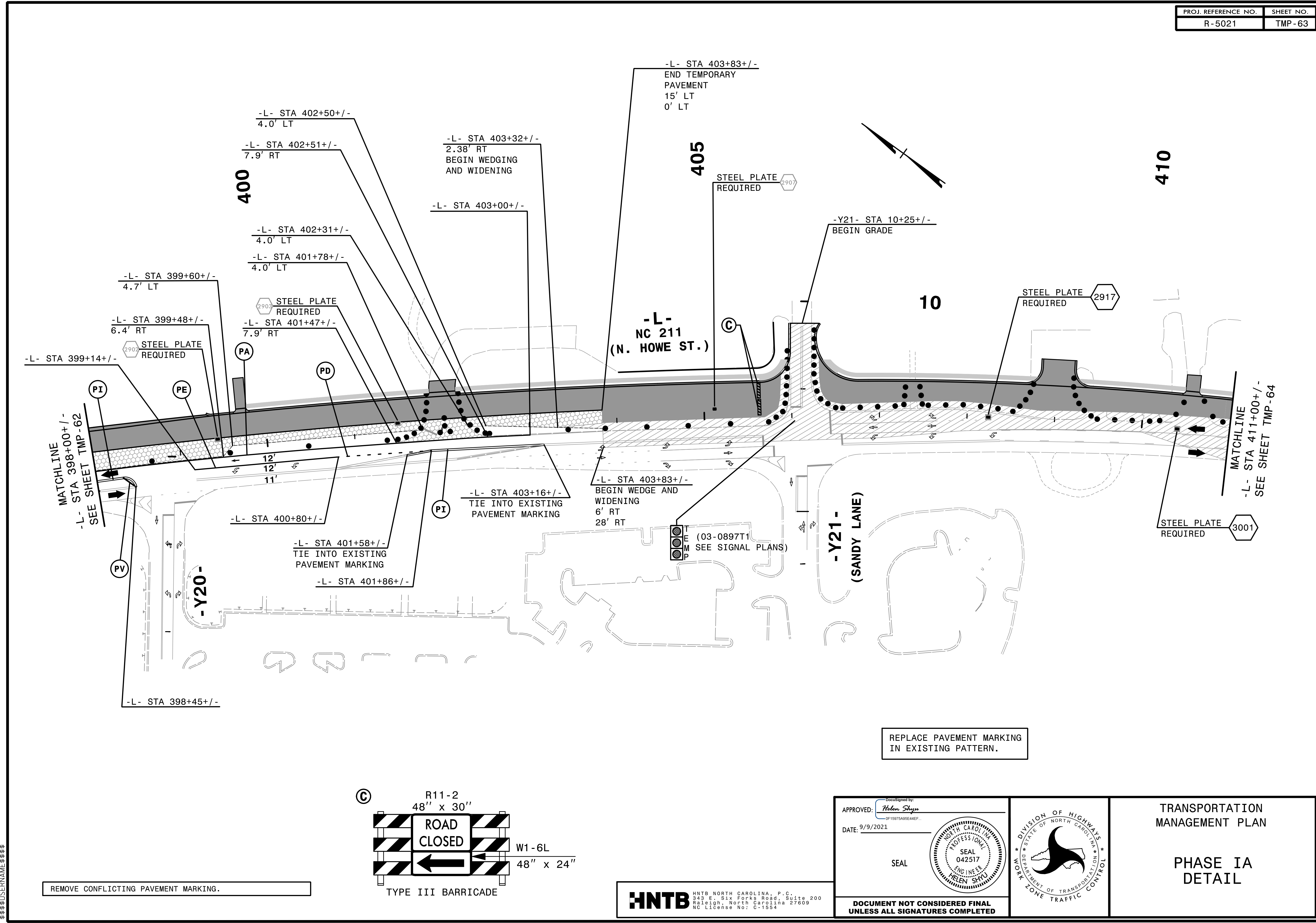

4:53:53 PM
 \\TCPL15021\TC_pid24a.dgn
 \$\$\$USERNAME\$\$\$

REMOVE CONFLICTING PAVEMENT MARKING.

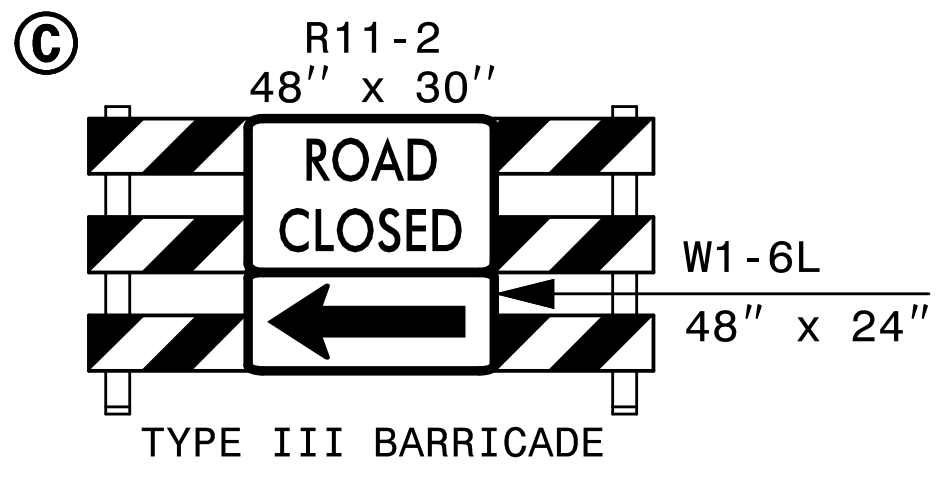

REPLACE PAVEMENT MARKING
IN EXISTING PATTERN.

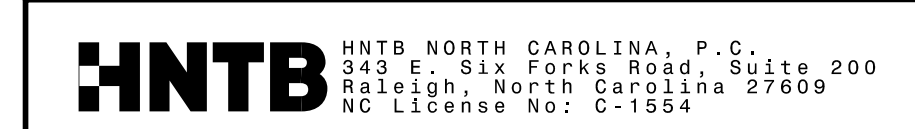

APPROVED: *Helen Shyne*
 DATE: 9/9/2021
 SEAL
 (Professional Engineer Seal: HELLEN SHYNE, ENGINEER, NO. 042517, EXPIRES 09/09/2024)

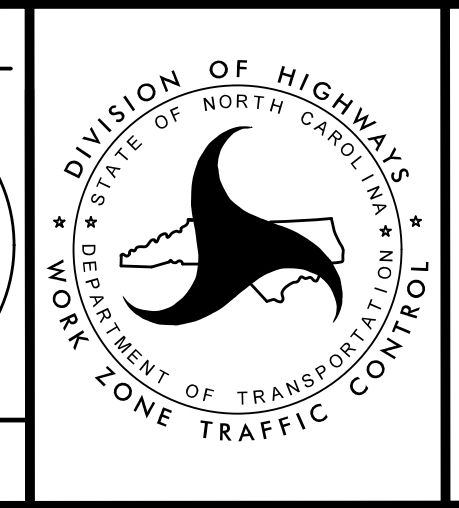

TRANSPORTATION
MANAGEMENT PLAN

PHASE IA
DETAIL

DOCUMENT NOT CONSIDERED FINAL
UNLESS ALL SIGNATURES COMPLETED

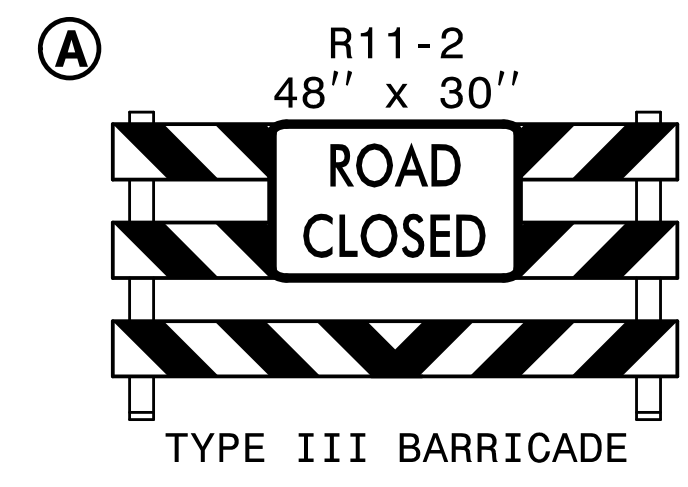

415

420

USING LANE CLOSURES, EXCAVATE SOIL AND CONSTRUCT PROPOSED PAVEMENT FROM -L- STA 411+50+/- TO 412+80+/- (LEFT).

-L-
NC 211
(N. HOWE ST)

MATCHLINE
-L- STA 411+00+/-
SEE SHEET TMP-63

MATCHLINE
-L- STA 423+00+/-
SEE SHEET TMP-65

3002 STEEL PLATE
REQUIRED

3029 STEEL PLATE
REQUIRED

3003 STEEL PLATE
REQUIRED

3035 STEEL PLATE
REQUIRED

3039 STEEL PLATE
REQUIRED

STEEL PLATE
REQUIRED 3004

WEDGE -L- CONSTRUCT TEMPORARY GRADE, TIE-IN TO EXISTING DRIVEWAYS AND TEMPORARY SLOPE TO EXISTING DITCHES.

REPLACE PAVEMENT MARKING IN EXISTING PATTERN.

2/6/2019
HNTB

HNTB
HNTB NORTH CAROLINA, P.C.
343 E. Six Forks Road, Suite 200
Raleigh, North Carolina 27609
NC License No: C-1554

APPROVED: *Helen Skyy*
DATE: 2/6/2019
SEAL
DOCUMENT NOT CONSIDERED FINAL
UNLESS ALL SIGNATURES COMPLETED

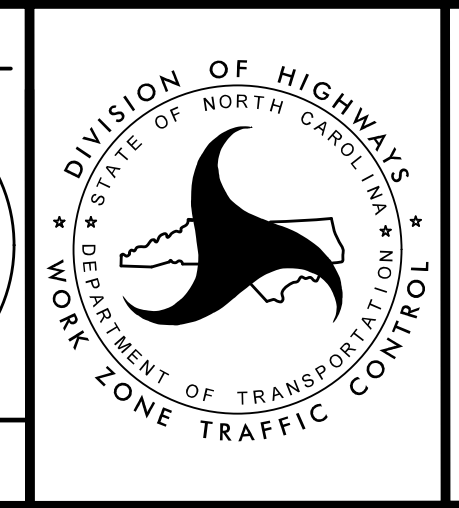

TRANSPORTATION
MANAGEMENT PLAN

PHASE IA
DETAIL

REPLACE PAVEMENT MARKING IN EXISTING PATTERN.

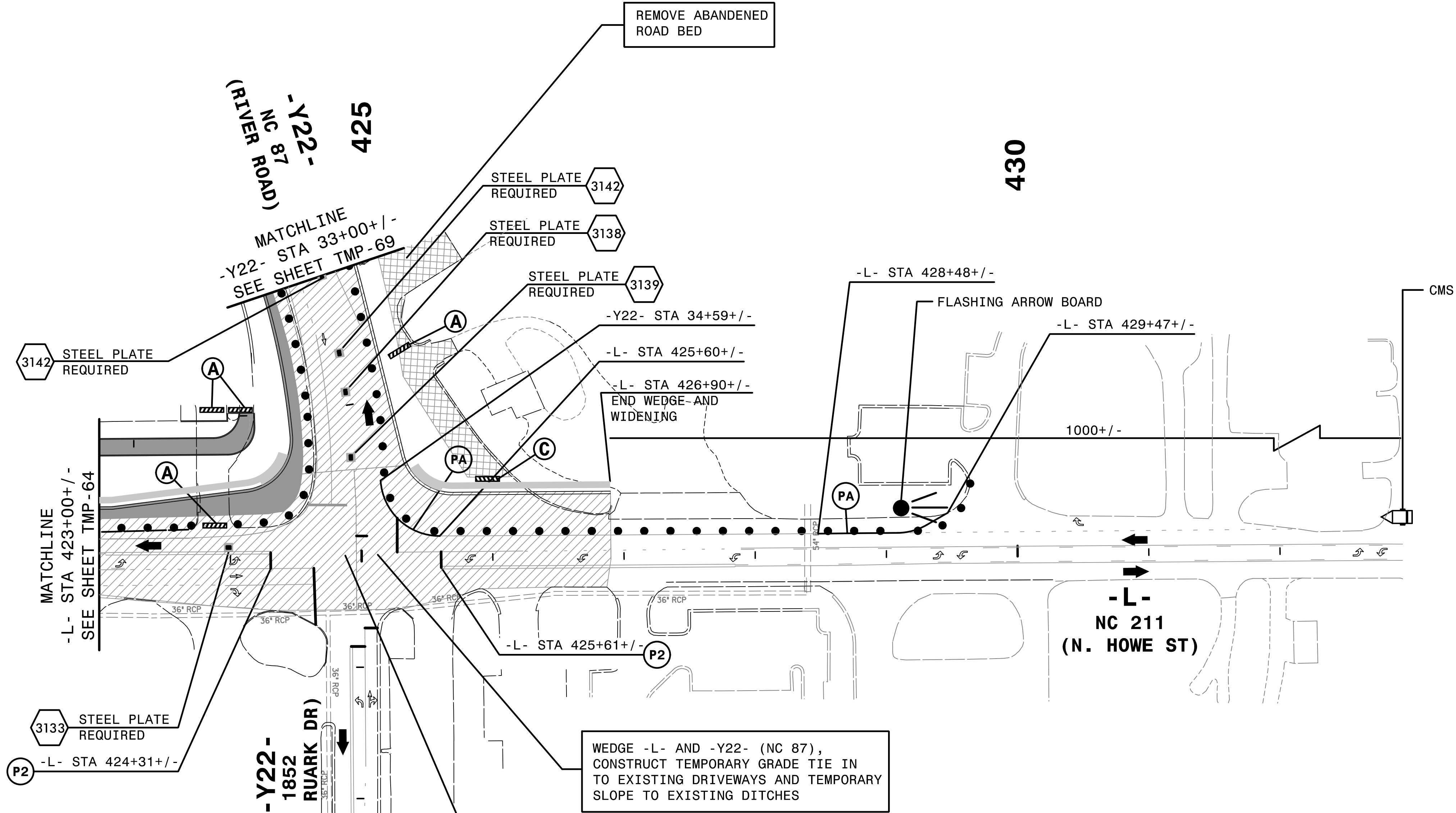

MESSAGE NO. 1	MESSAGE NO. 2
RIGHT TURN CLOSED	TURN AT SIGNAL
CHANGEABLE MESSAGE SIGN	

NOTE: USE RECOMMENDED MESSAGE OR MESSAGE DETERMINED BY THE ENGINEER

WEDGE -L- AND -Y22- (NC 87), CONSTRUCT TEMPORARY GRADE TIE IN TO EXISTING DRIVEWAYS AND TEMPORARY SLOPE TO EXISTING DITCHES

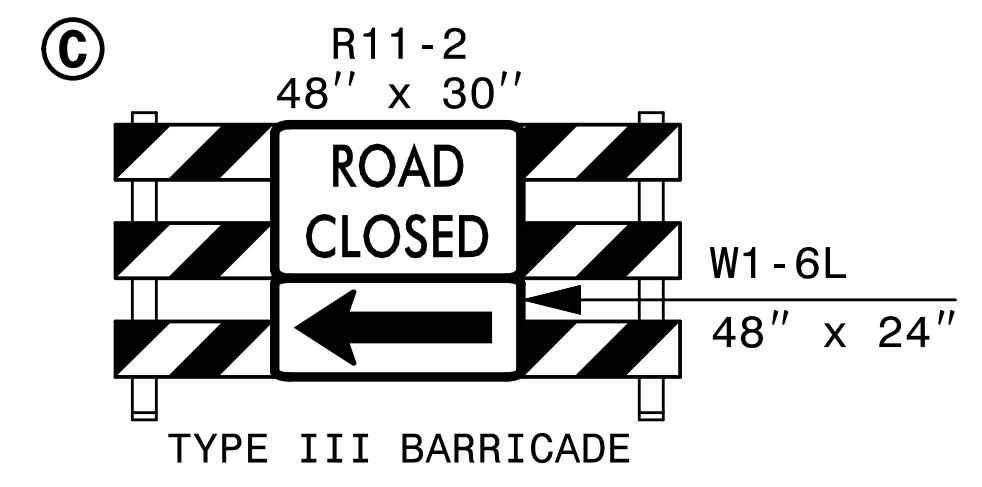
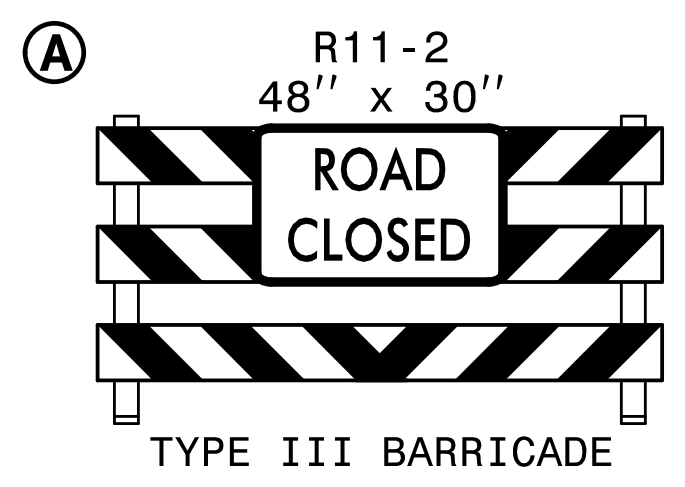

2/6/2019
HNTB

HNTB HNTB NORTH CAROLINA, P.C.
343 E. Six Forks Road, Suite 200
Raleigh, North Carolina 27609
NC License No: C-1554

APPROVED: *Helen Skyy*
DATE: 2/6/2019
SEAL
PROFESSIONAL SEAL
042517
ENGINEER
HELEN SKYY

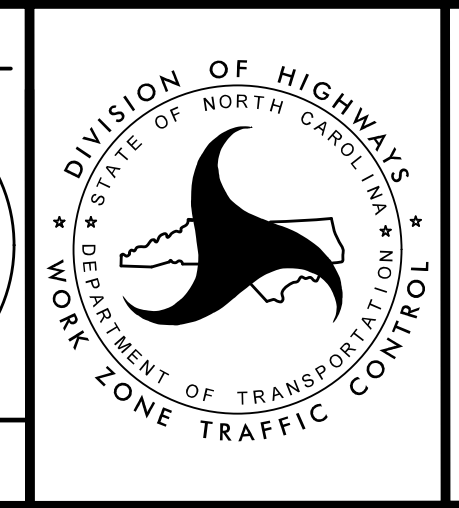

TRANSPORTATION MANAGEMENT PLAN
PHASE IA DETAIL

DOCUMENT NOT CONSIDERED FINAL UNLESS ALL SIGNATURES COMPLETED

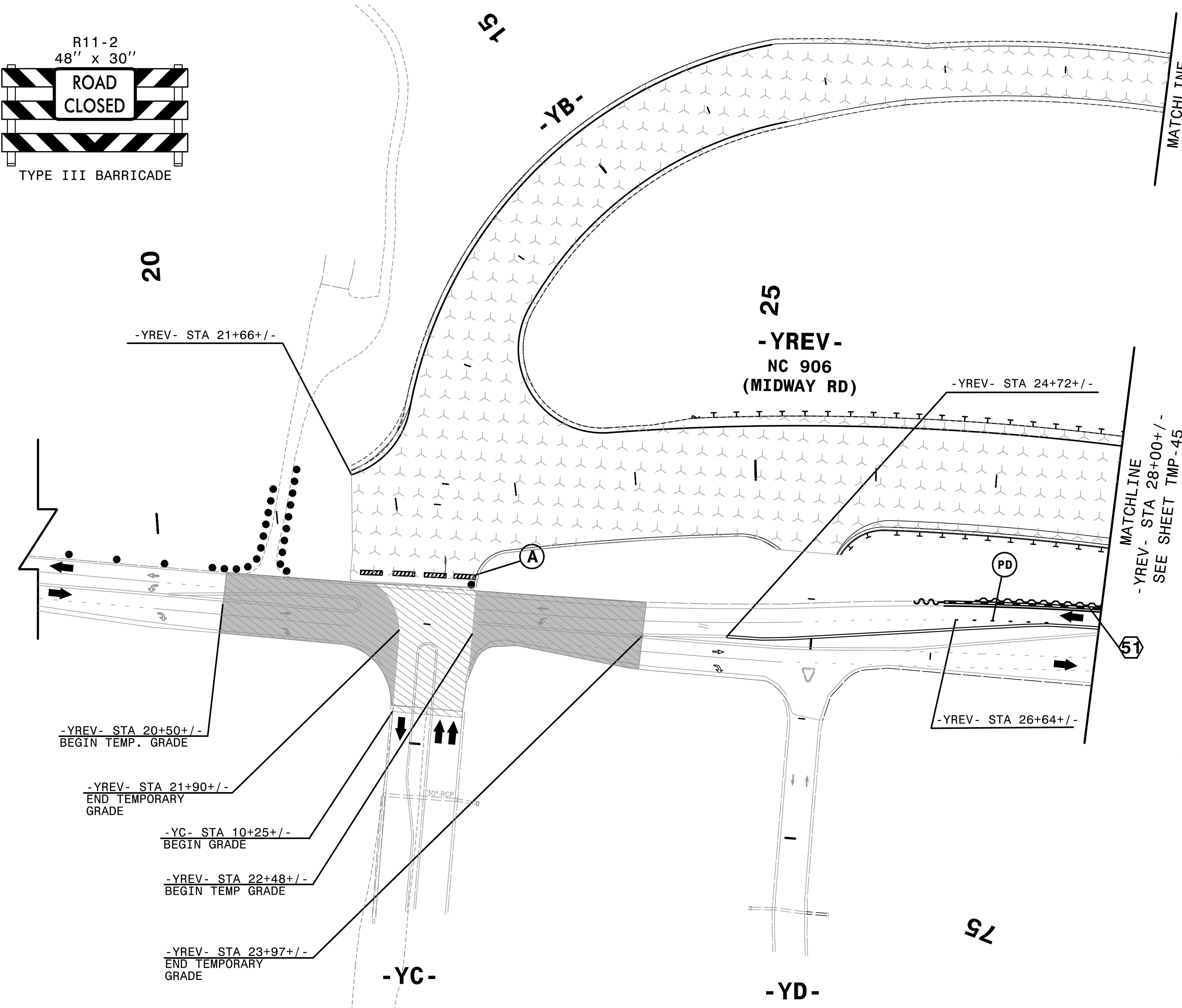
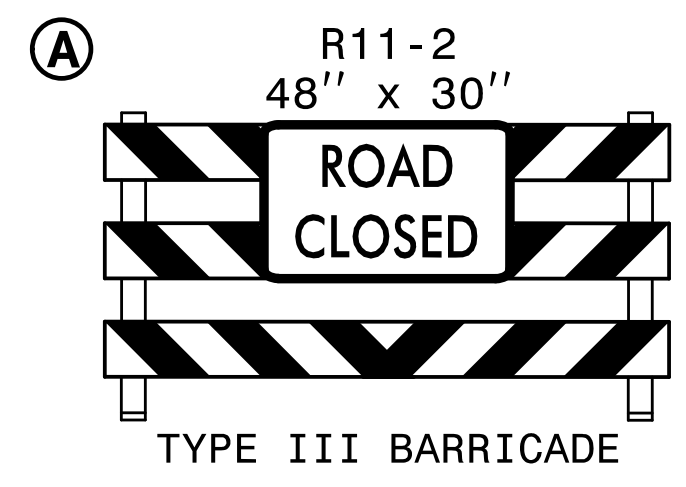

51 EST QUANTITY = 3380 SF

TEMPORARY SHORING
FROM -YREV- STA 26+90.07+/-, 94.36' RT
TO -YREV- STA 28+41.36, 86.36' RT
FROM -YREV- STA 28+41.36, 86.36' RT
TO -YREV- STA 30+37.27+/-, 65.17' RT
(SEE SHEET TMP-2G FOR
TEMPORARY SHORING NOTES)

4:53:56 PM
\\TCPL-5021\TC_pld28A.dgn
\$\$\$\$\$USERNAME\$\$\$\$\$

REPLACE PAVEMENT MARKING IN EXISTING PATTERN.

HNTB HNTB NORTH CAROLINA, P.C.
343 E. Six Forks Road, Suite 200
Raleigh, North Carolina 27609
NC License No: C-1554

APPROVED: *Helen Shyu*
DATE: 9/9/2021

SEAL

SEAL
042517
ENGINEER
HELEN SHYU

DOCUMENT NOT CONSIDERED FINAL
UNLESS ALL SIGNATURES COMPLETED

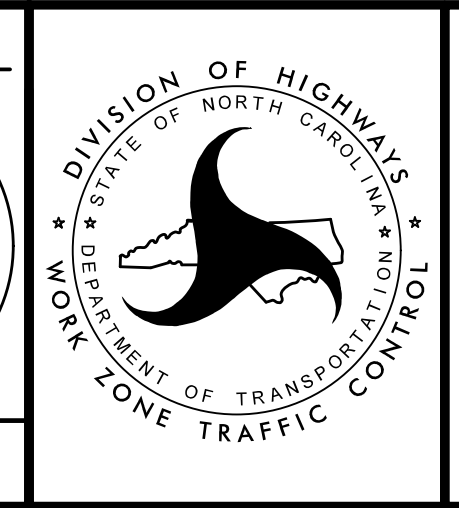

TRANSPORTATION
MANAGEMENT PLAN

PHASE IA
DETAIL

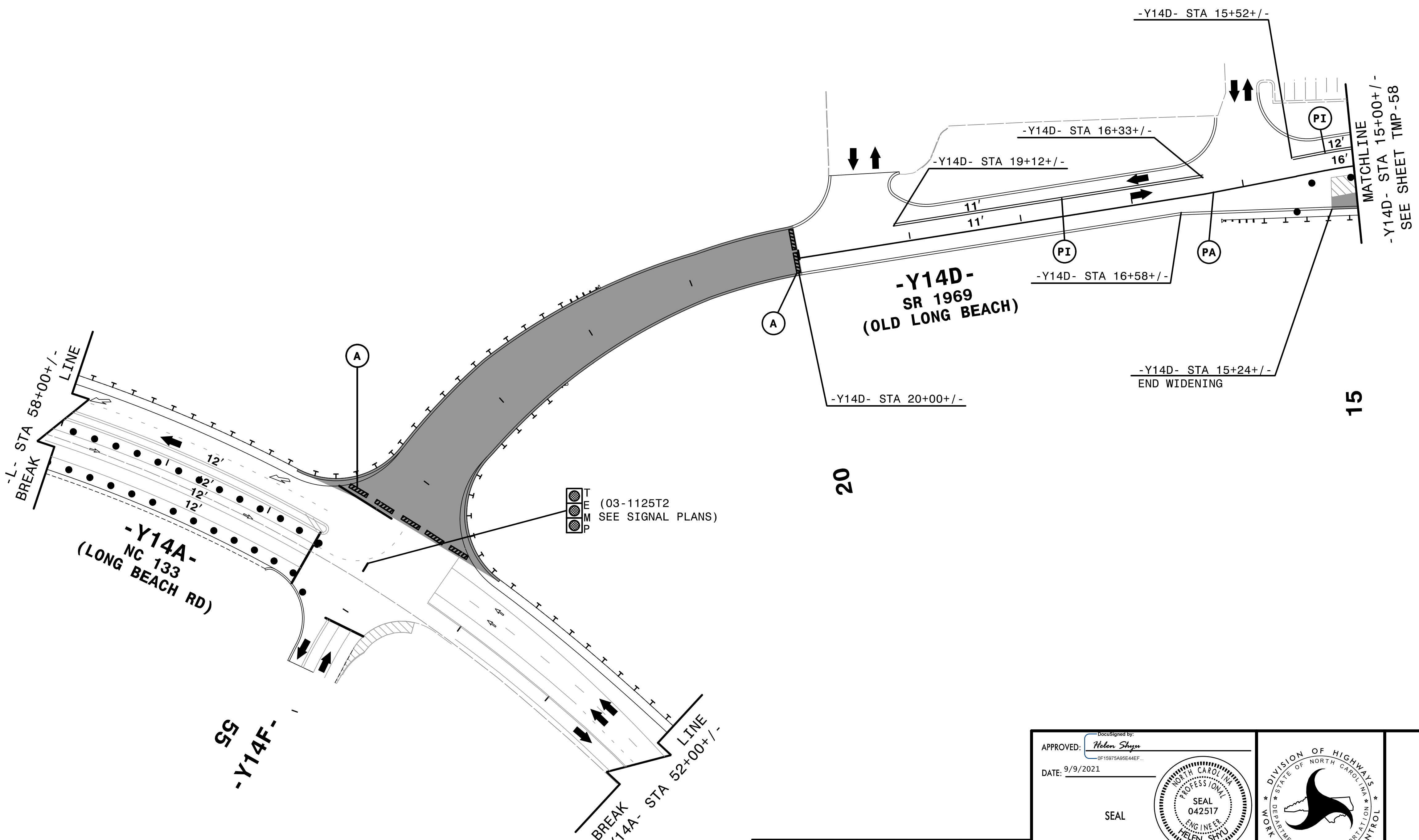
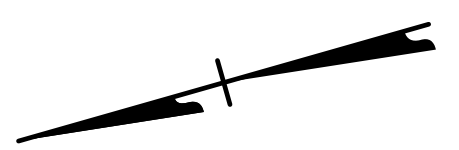
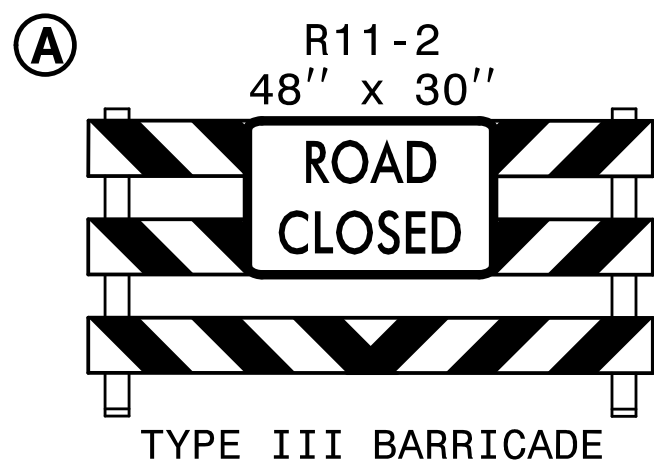

4:53:59 PM
\\TCFV\F5021\TC_pid35a.dgn
\$\$\$\$\$USERNAME\$\$\$\$\$

HNTB HNTB NORTH CAROLINA, P.C.
343 E. Six Forks Road, Suite 200
Raleigh, North Carolina 27609
NC License No: C-1554

APPROVED: *Helen Shyu*
DATE: 9/9/2021
SEAL
DOCUMENT NOT CONSIDERED FINAL
UNLESS ALL SIGNATURES COMPLETED

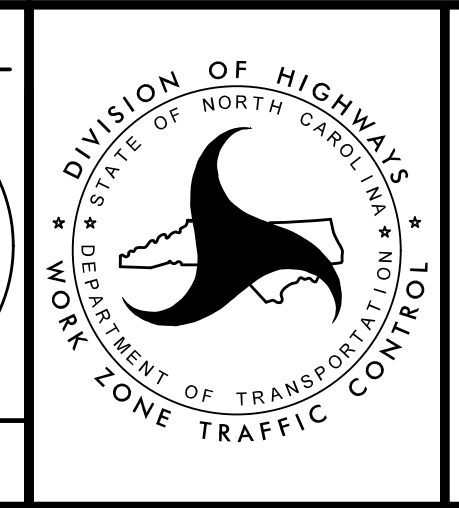

TRANSPORTATION
MANAGEMENT PLAN
PHASE 1A
DETAIL

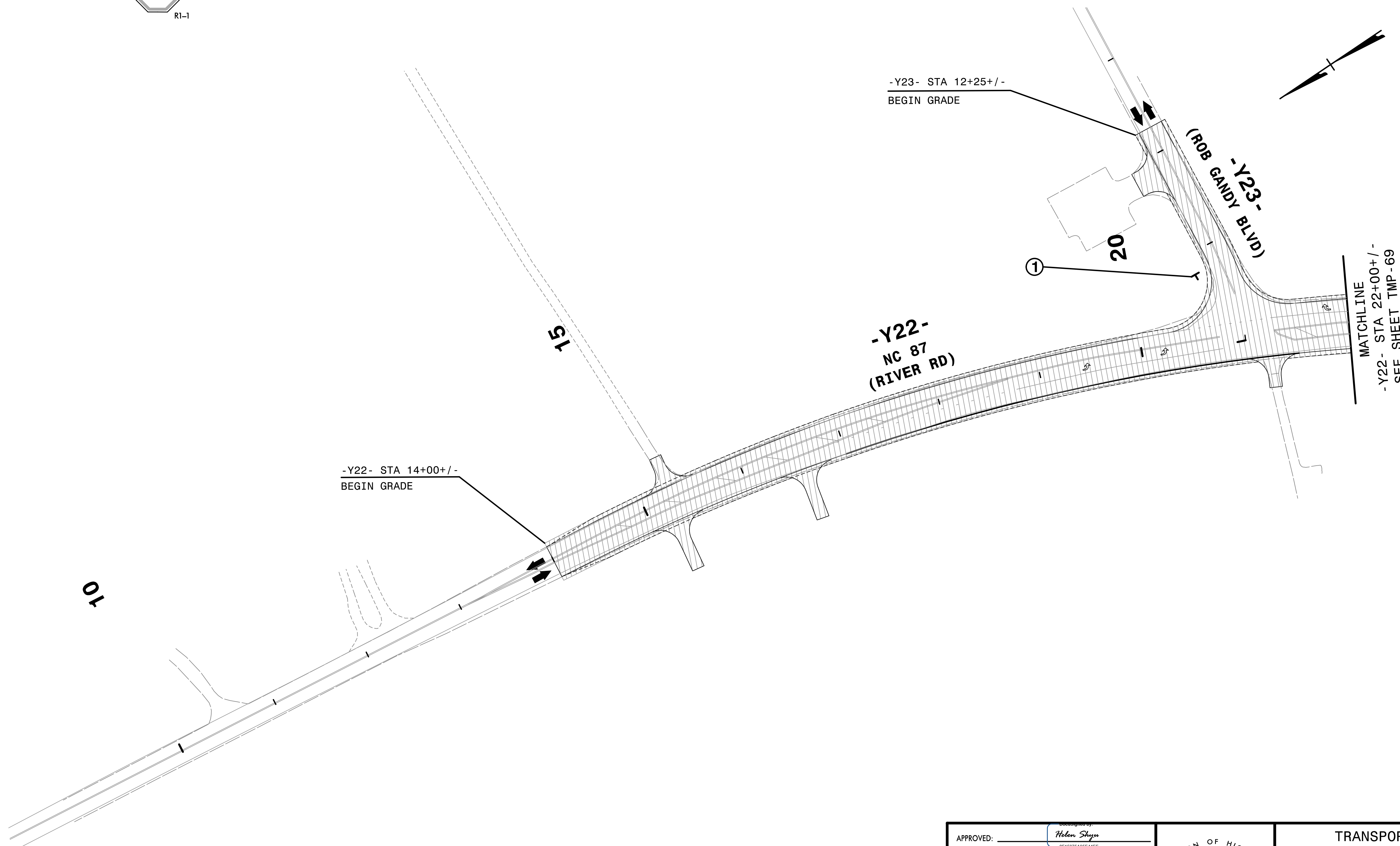
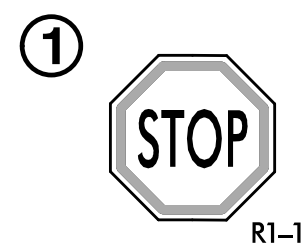

REPLACE PAVEMENT MARKING IN EXISTING PATTERN.

2/6/2019
 HNTB
 HNTB

HNTB HNTB NORTH CAROLINA, P.C.
 343 E. Six Forks Road, Suite 200
 Raleigh, North Carolina 27609
 NC License No: C-1554

APPROVED: *Helen Shyu*
 DATE: 2/6/2019
 SEAL
 DOCUMENT NOT CONSIDERED FINAL
 UNLESS ALL SIGNATURES COMPLETED

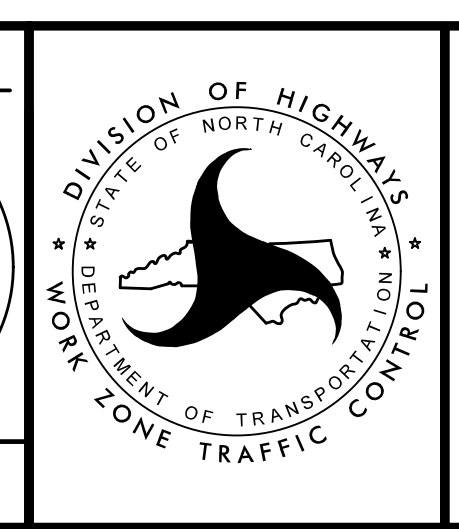

TRANSPORTATION
 MANAGEMENT PLAN
 PHASE IA
 DETAIL

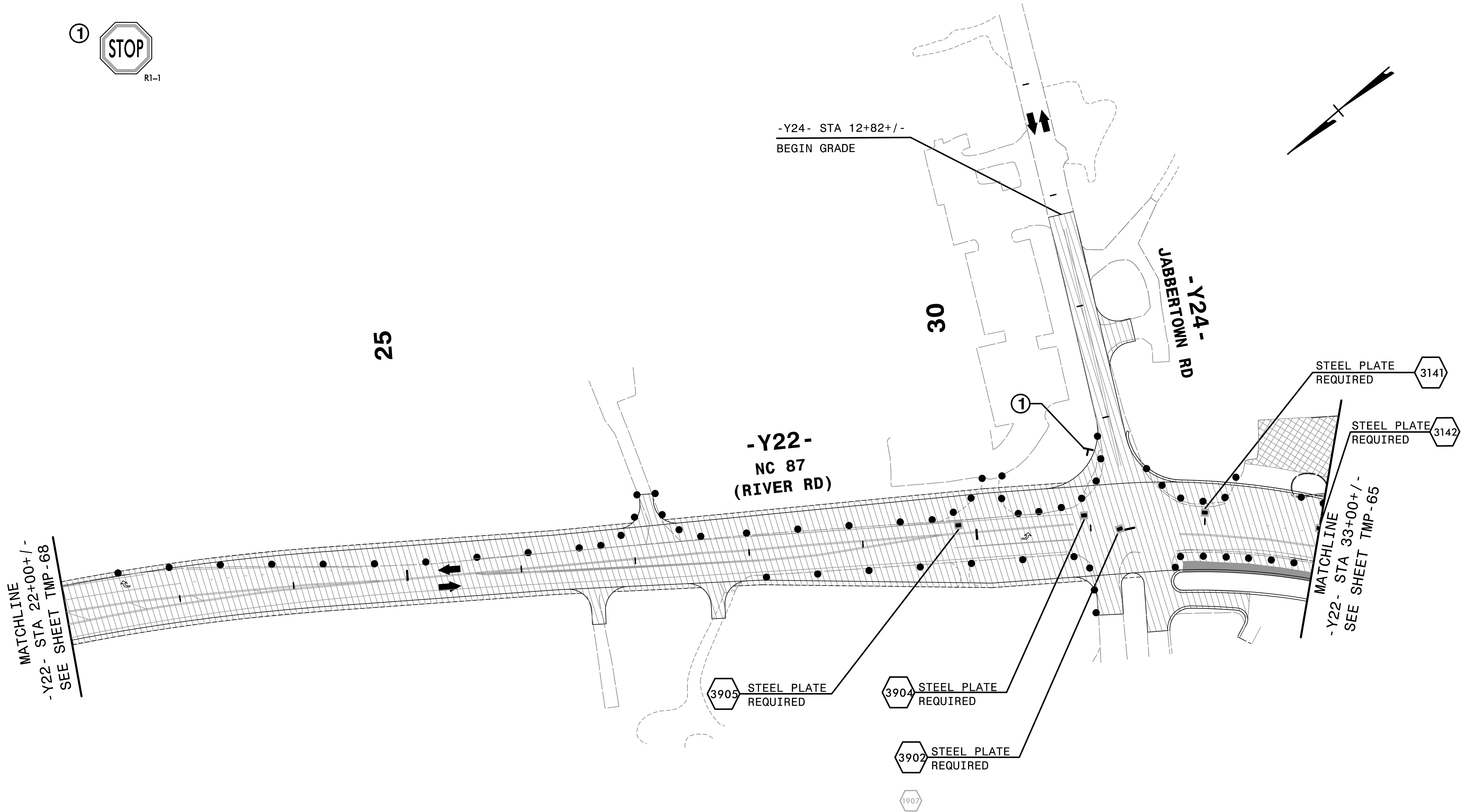

REPLACE PAVEMENT MARKING IN EXISTING PATTERN.

2/6/2019
HNTB

HNTB HNTB NORTH CAROLINA, P.C.
343 E. Six Forks Road, Suite 200
Raleigh, North Carolina 27609
NC License No: C-1554

APPROVED: *Helen Shyu*
DATE: 2/6/2019

SEAL

PROFESSIONAL SEAL
042517
ENGINEER
HELEN SHYU

DOCUMENT NOT CONSIDERED FINAL
UNLESS ALL SIGNATURES COMPLETED

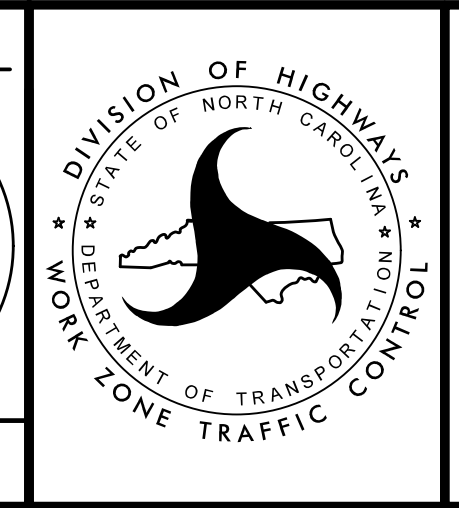

TRANSPORTATION
MANAGEMENT PLAN

PHASE IA
DETAIL

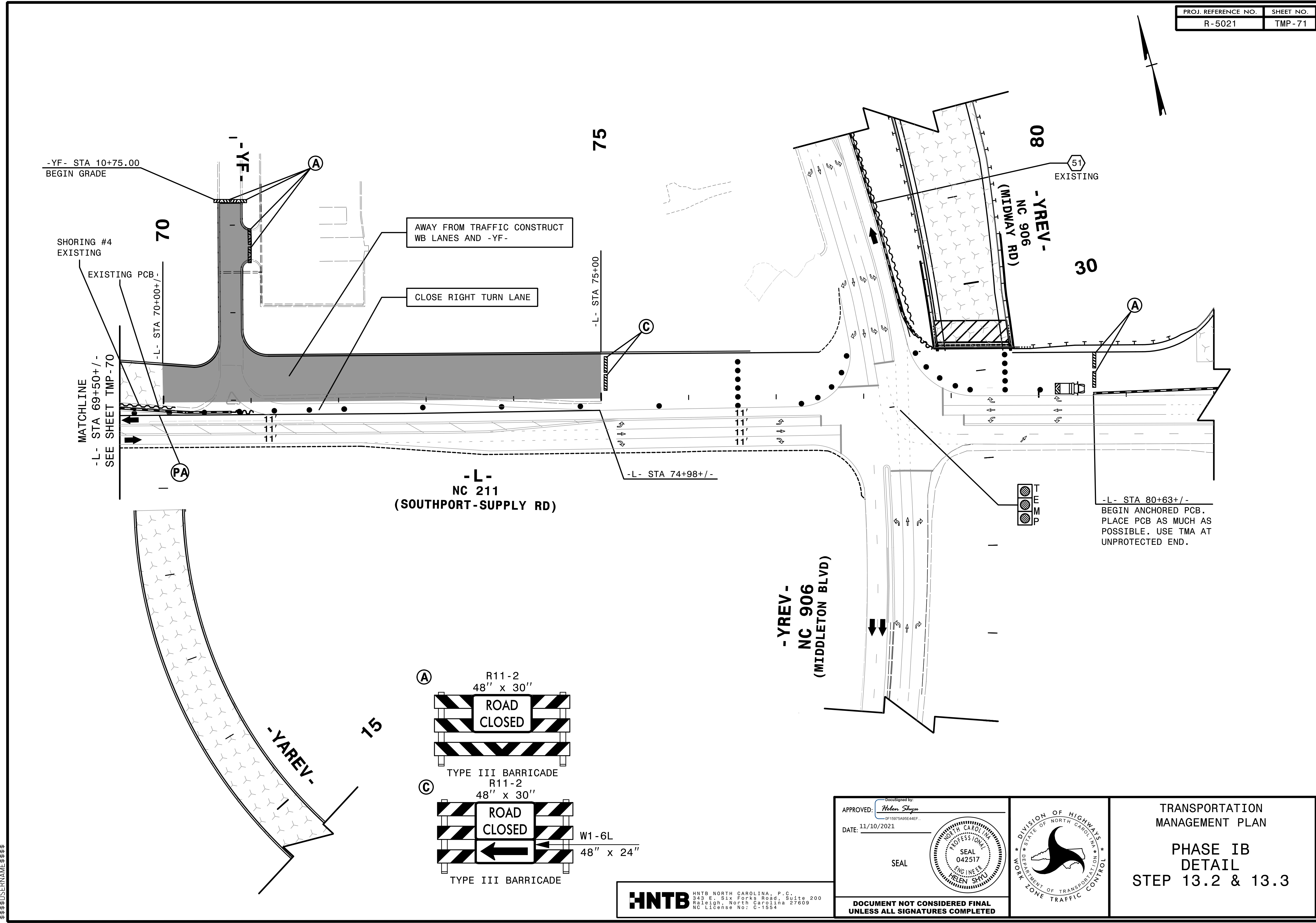

4:56:26 PM
 \\TCF\...5021_Tc_pid3b.dgn
 \$\$\$USERNAME\$\$\$

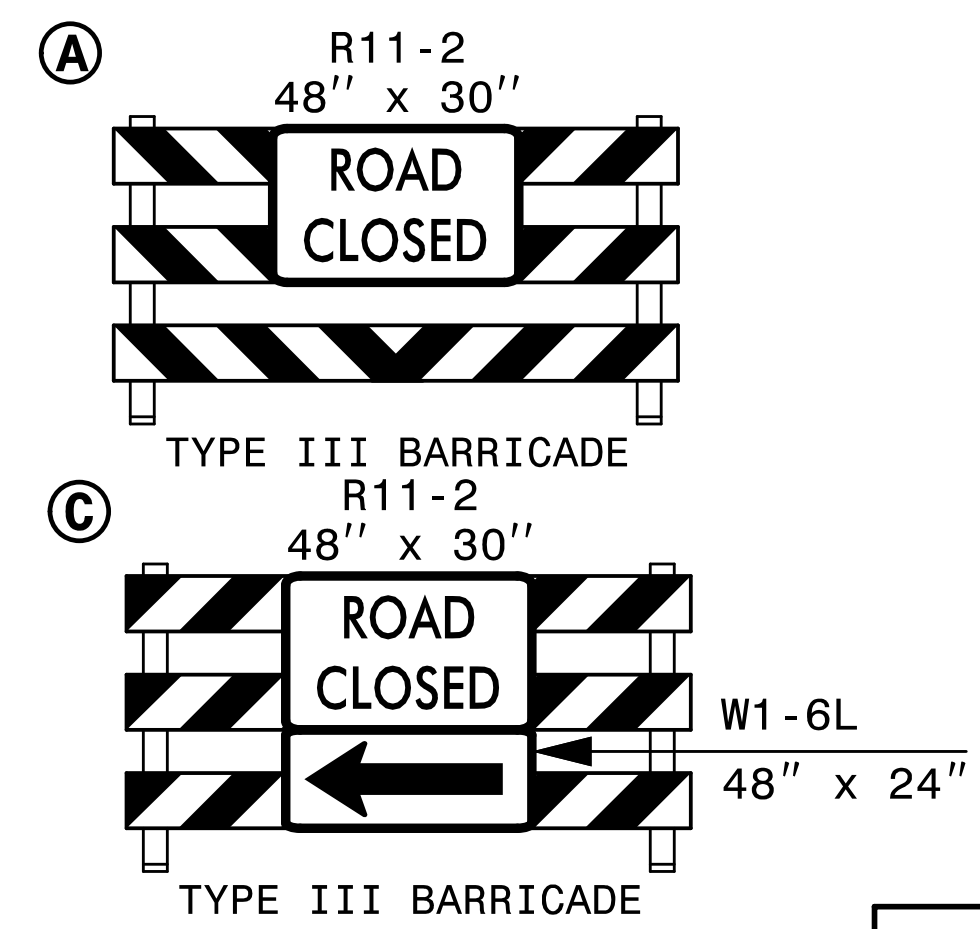

HNTB HNTB NORTH CAROLINA, P.C.
 343 E. Six Forks Road, Suite 200
 Raleigh, North Carolina 27609
 NC License No: C-1554

APPROVED: *Helen Shyn*
 DATE: 11/10/2021
 SEAL
 PROFESSIONAL ENGINEER
 HELEN SHYN
 042517
 NO. IN CAROLINA

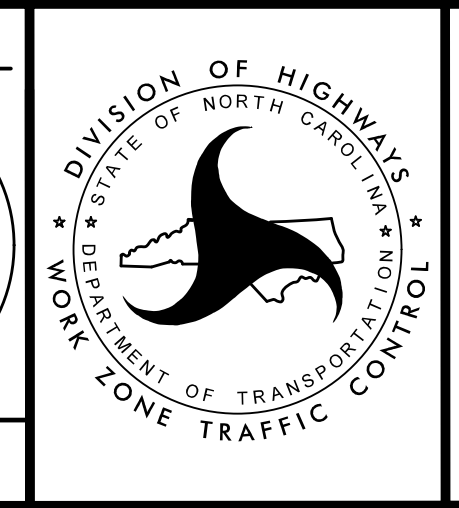

TRANSPORTATION
 MANAGEMENT PLAN
 PHASE IB
 DETAIL
 STEP 13.2 & 13.3

DOCUMENT NOT CONSIDERED FINAL
 UNLESS ALL SIGNATURES COMPLETED

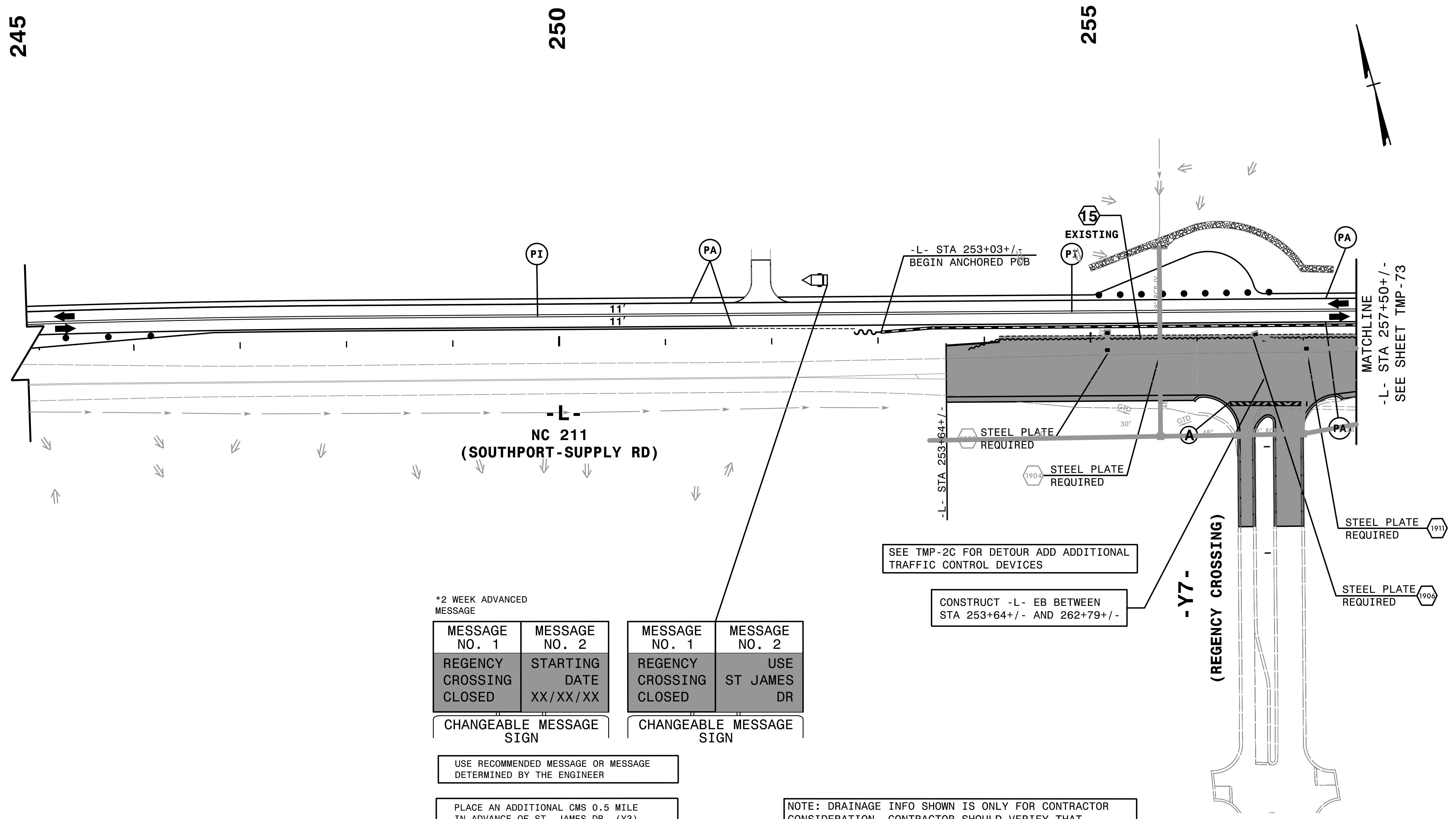

*2 WEEK ADVANCED MESSAGE

MESSAGE NO. 1	MESSAGE NO. 2	MESSAGE NO. 1	MESSAGE NO. 2
REGENCY CROSSING CLOSED	STARTING DATE XX/XX/XX	REGENCY CROSSING CLOSED	USE ST JAMES DR

CHANGEABLE MESSAGE SIGN CHANGEABLE MESSAGE SIGN

USE RECOMMENDED MESSAGE OR MESSAGE DETERMINED BY THE ENGINEER

PLACE AN ADDITIONAL CMS 0.5 MILE IN ADVANCE OF ST. JAMES DR. (Y3) SEE TMP- 2C

NOTE: DRAINAGE INFO SHOWN IS ONLY FOR CONTRACTOR CONSIDERATION. CONTRACTOR SHOULD VERIFY THAT PONDING OF WATER WILL NOT OCCUR IN THE TRAVEL LANES.

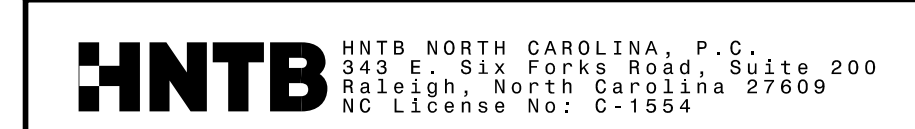
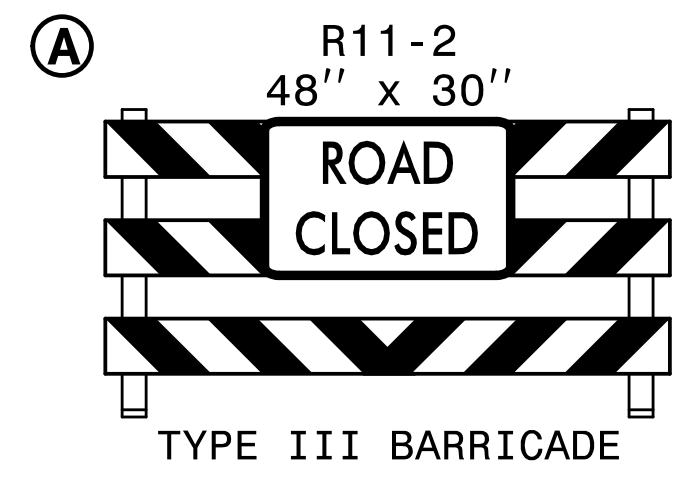

APPROVED: *Helen Shyu*
DATE: 11/10/2021

SEAL

DOCUMENT NOT CONSIDERED FINAL UNLESS ALL SIGNATURES COMPLETED

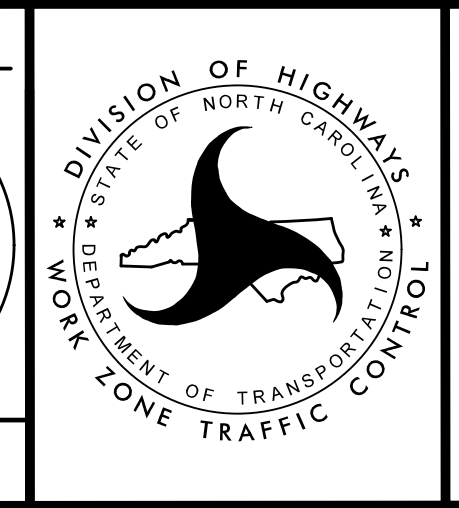

TRANSPORTATION MANAGEMENT PLAN

PHASE IB
STEP 13.6
DETAIL

4:56:29 PM
...\\TCF\T5021_Tc_p\dl2e.dgn
\$\$\$\$\$USERNAME\$\$\$\$\$

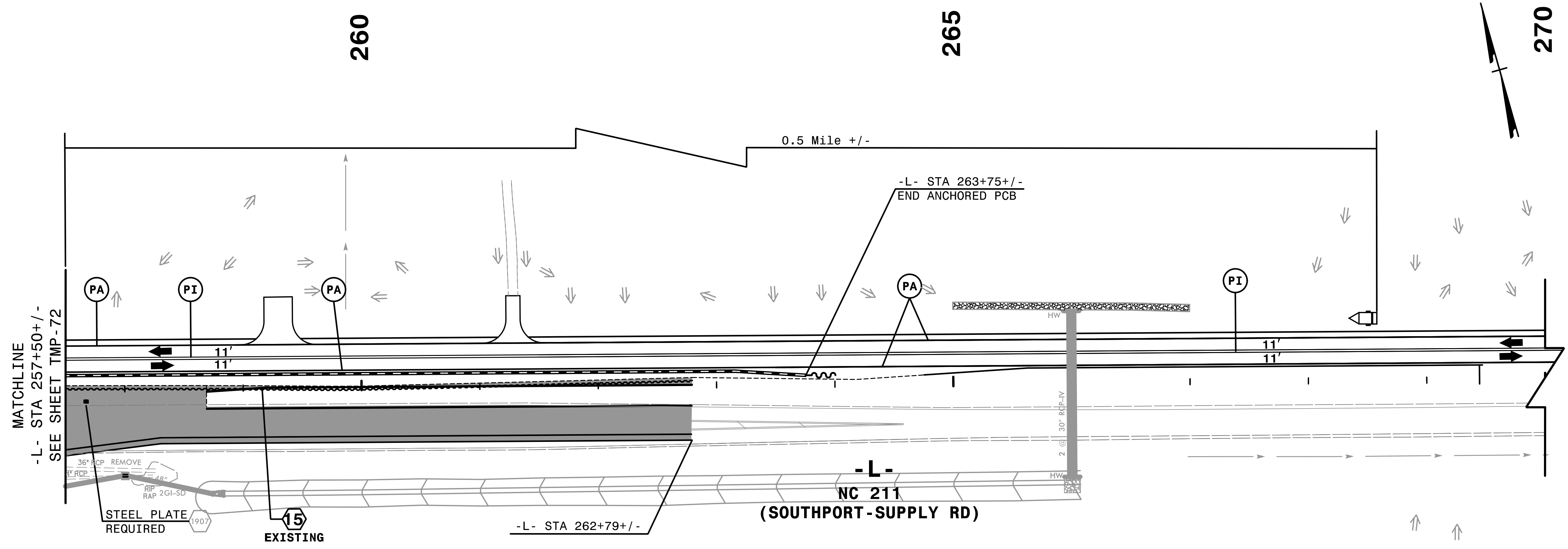

*2 WEEK ADVANCED NOTICE MESSAGE

MESSAGE NO. 1	MESSAGE NO. 2
REGENCY CROSSING CLOSED	STARTING DATE XX/XX/XX

CHANGEABLE MESSAGE SIGN

MESSAGE NO. 1	MESSAGE NO. 2
REGENCY CROSSING CLOSED	USE ST JAMES DRIVE

CHANGEABLE MESSAGE SIGN

USE RECOMMENDED MESSAGE OR MESSAGE DETERMINED BY THE ENGINEER

NOTE: DRAINAGE INFO SHOWN IS ONLY FOR CONTRACTOR CONSIDERATION. CONTRACTOR SHOULD VERIFY THAT PONDING OF WATER WILL NOT OCCUR IN THE TRAVEL LANES.

4:56:32 PM
 \\TCFV\5021\TC\pld\3e.dgn
 \$\$\$USERNAME\$\$\$

HNTB HNTB NORTH CAROLINA, P.C.
 343 E. Six Forks Road, Suite 200
 Raleigh, North Carolina 27609
 NC License No: C-1554

APPROVED: *Helen Shyu*
 DATE: 11/10/2021
 SEAL
 HNTB PROFESSIONAL SEAL
 042517
 ENGINEER
 HELEN SHYU

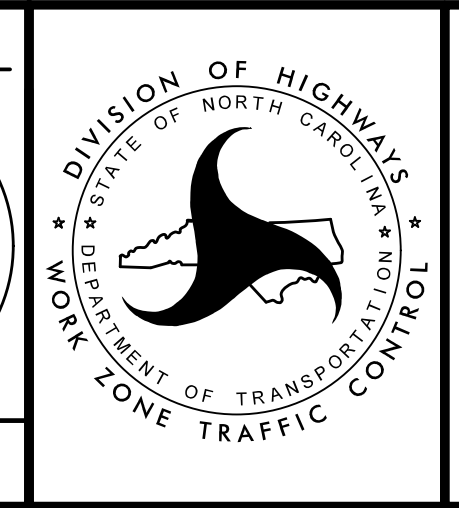

TRANSPORTATION MANAGEMENT PLAN
 PHASE IB
 STEP 13.6
 DETAIL

DOCUMENT NOT CONSIDERED FINAL UNLESS ALL SIGNATURES COMPLETED

PROJ. REFERENCE NO.	SHEET NO.
R-5021	TMP-74

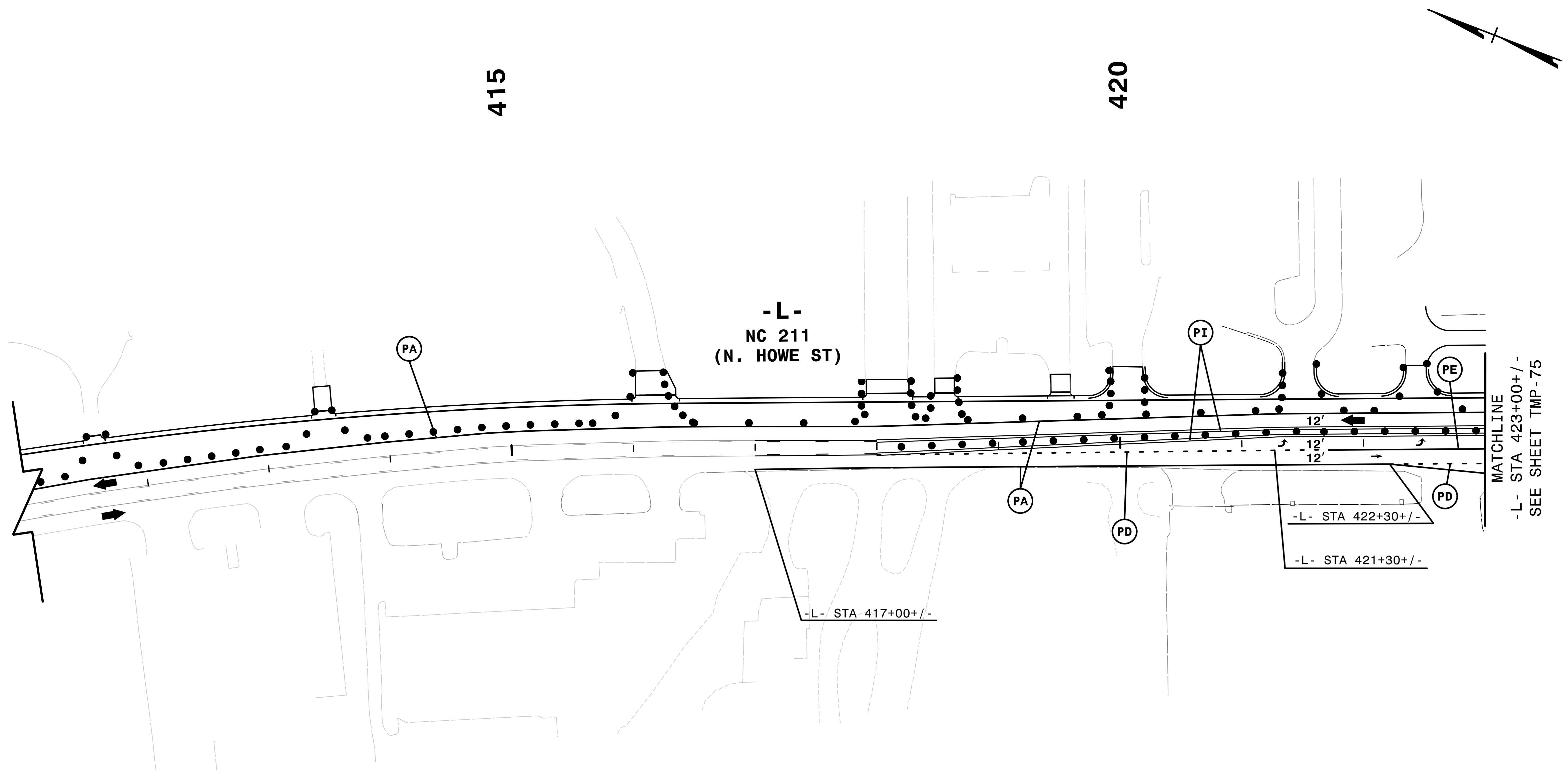

REMOVE CONFLICTING PAVEMENT MARKING.

4:56:35 PM
\\TCFV\5021\TC_pid25B.dgn
\$\$\$\$\$USERNAME\$\$\$\$\$

HNTB HNTB NORTH CAROLINA, P.C.
343 E. Six Forks Road, Suite 200
Raleigh, North Carolina 27609
NC License No: C-1554

APPROVED: *Helen Shyu*
DATE: 11/10/2021

SEAL

DOCUMENT NOT CONSIDERED FINAL
UNLESS ALL SIGNATURES COMPLETED

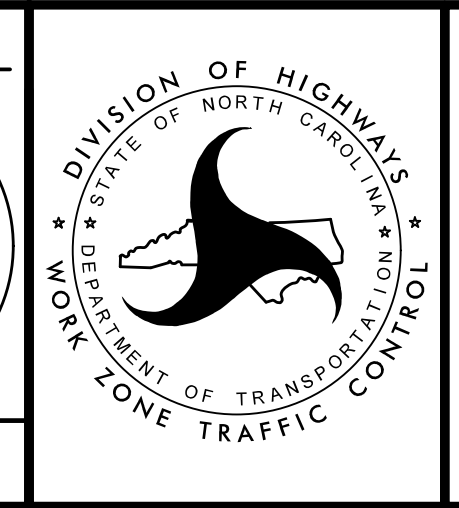

TRANSPORTATION
MANAGEMENT PLAN

PHASE IB
STEP 16.4
DETAIL

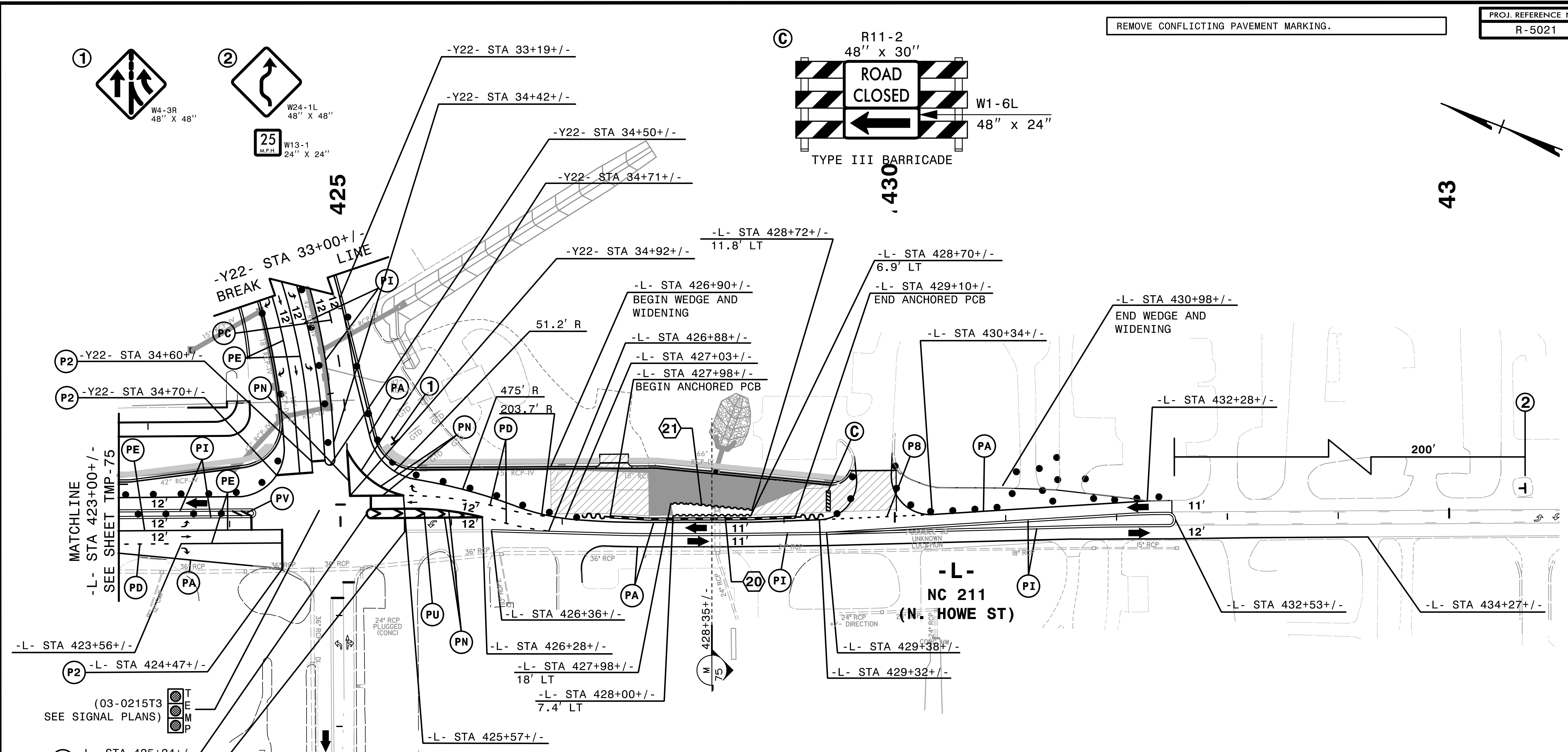

20 EST QUANTITY = 387 SF

TEMPORARY SHORING
FROM -L- STA 428+00+/-, 7.4' LT
TO -L- STA 428+70+/-, 6.9' LT

(SEE TMP-2G FOR
TEMPORARY SHORING NOTES)

21 EST QUANTITY = 423 SF

TEMPORARY SHORING
FROM -L- STA 427+98+/-, 18' LT
TO -L- STA 428+12+/-, 18' LT AND
FROM -L- STA 428+12+/-, 18' LT
TO -L- STA 428+72+/-, 11.8' LT

(SEE TMP-2G FOR
TEMPORARY SHORING NOTES)

NOTE: DRAINAGE INFO SHOWN IS ONLY FOR CONTRACTOR
CONSIDERATION. CONTRACTOR SHOULD VERIFY THAT
PONDING OF WATER WILL NOT OCCUR IN THE TRAVEL LANES.

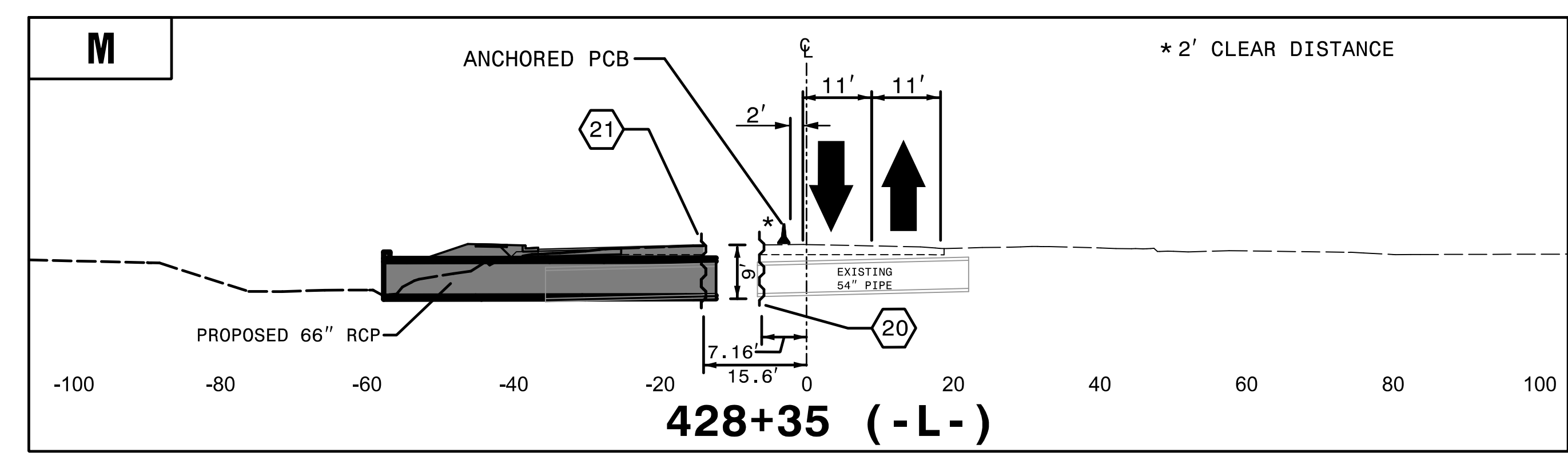

4:56:40 PM
\\TCFV\F5021_Tc_pld26b.dgn
\$\$\$\$\$USERNAME\$\$\$\$\$

HNTB HNTB NORTH CAROLINA, P.C.
343 E. Six Forks Road, Suite 200
Raleigh, North Carolina 27609
NC License No: C-1554

APPROVED: *Helen Shyu*
DATE: 11/10/2021
SEAL
DOCUMENT NOT CONSIDERED FINAL
UNLESS ALL SIGNATURES COMPLETED

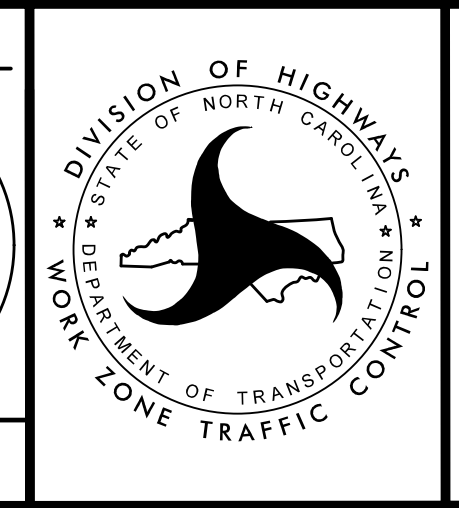

TRANSPORTATION
MANAGEMENT PLAN
PHASE IB
STEP 16.4
DETAIL

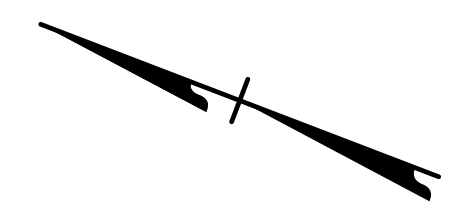
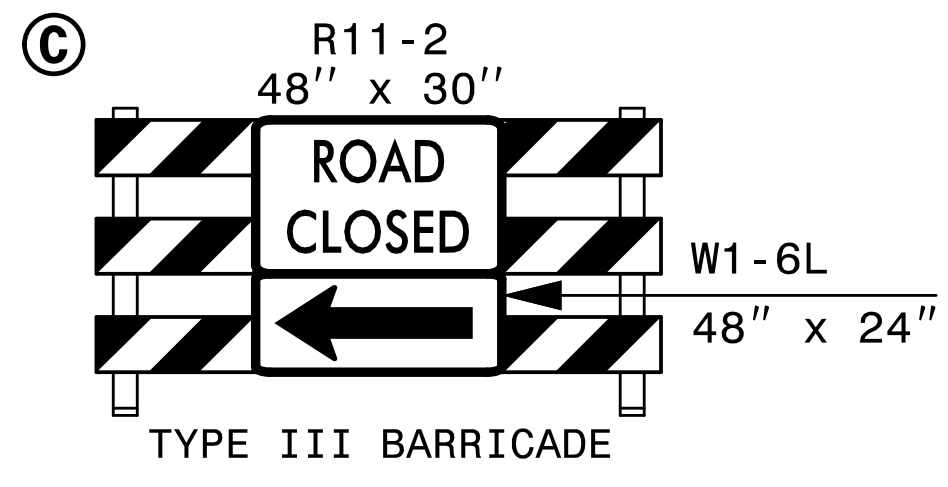
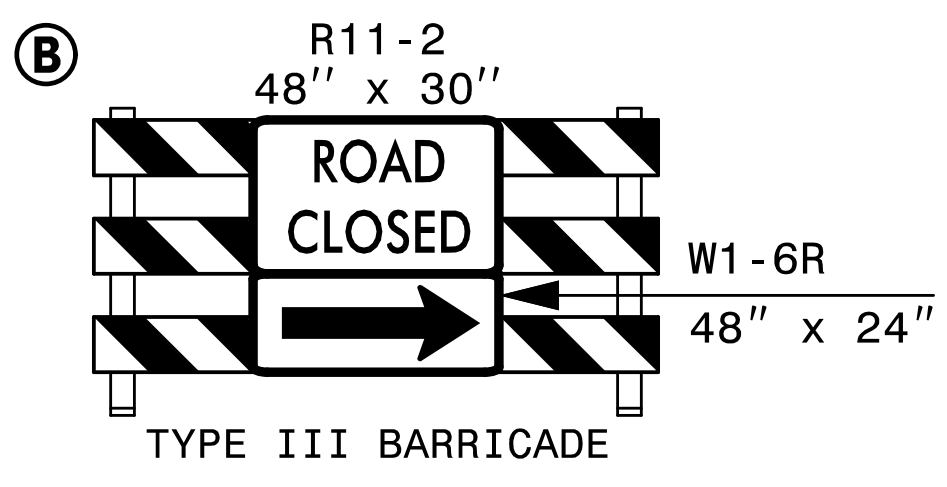
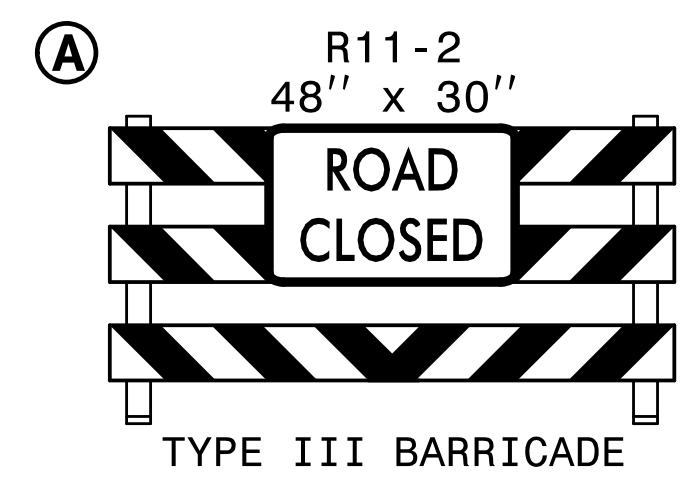
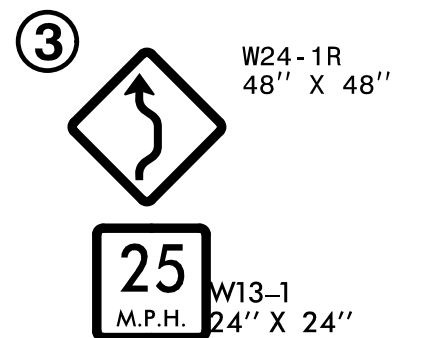
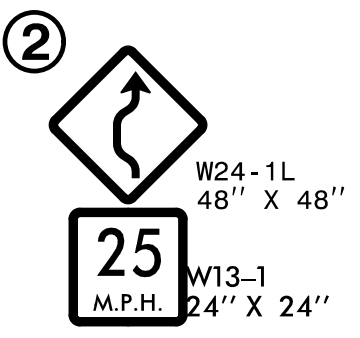

430

435

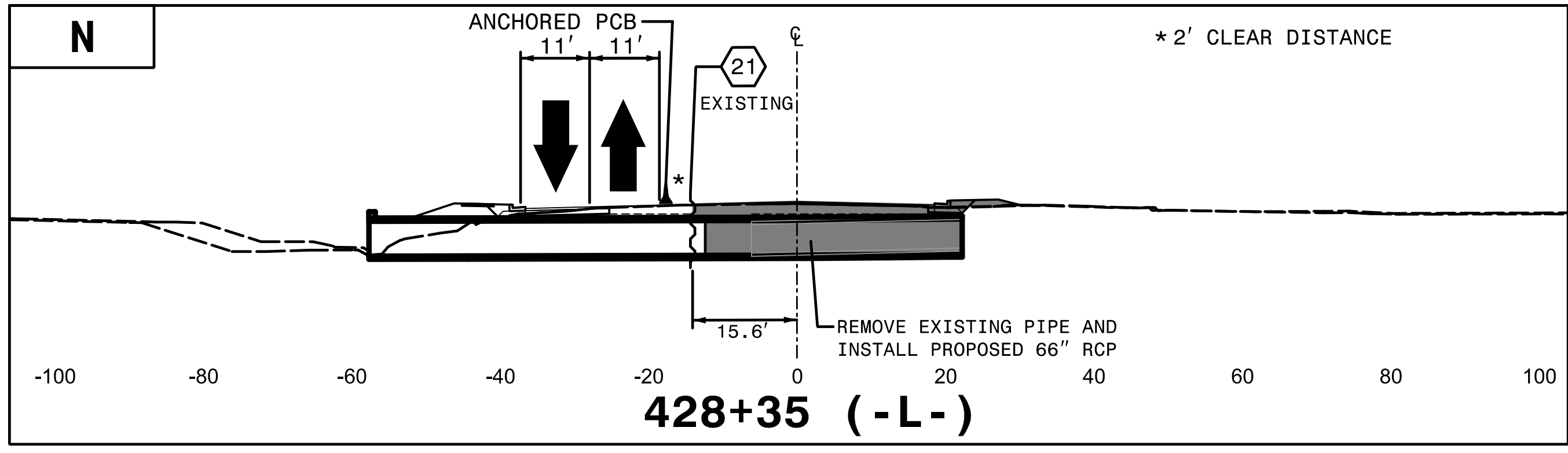
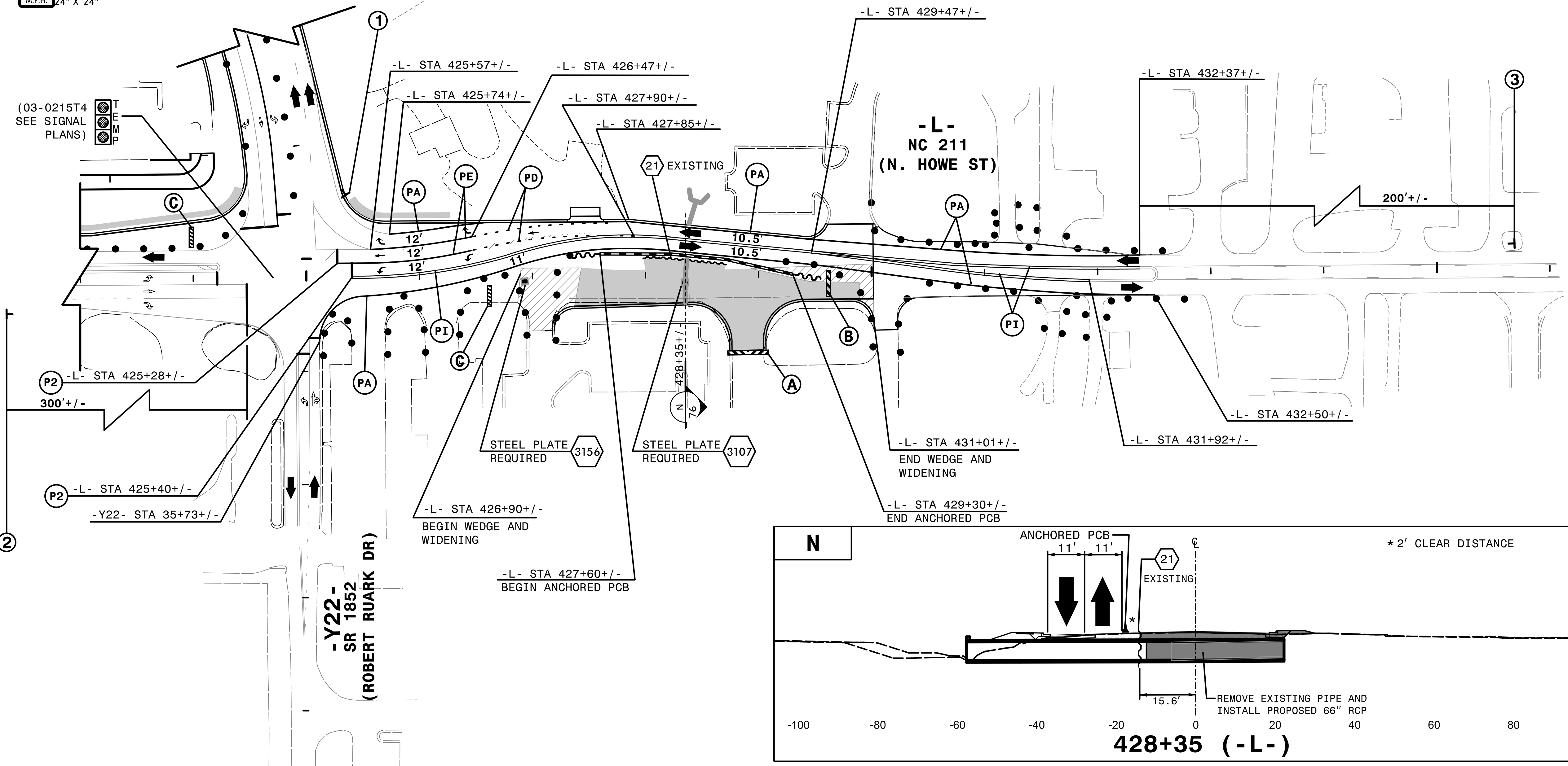

4:56:42 PM
 ...\\TCF...5021_Tc_pid26d.dgn
 \$\$\$USERNAME\$\$\$

REMOVE CONFLICTING PAVEMENT MARKING.

HNTB HNTB NORTH CAROLINA, P.C.
 343 E. Six Forks Road, Suite 200
 Raleigh, North Carolina 27609
 NC License No: C-1554

APPROVED: *Helen Shyu*
 DATE: 11/10/2021
 SEAL
 PROFESSIONAL ENGINEER
 SEAL 042517
 HELEN SHYU

DIVISION OF HIGHWAYS
 NORTH CAROLINA
 DEPARTMENT OF TRANSPORTATION
 WORK ZONE TRAFFIC CONTROL

TRANSPORTATION
 MANAGEMENT PLAN
 PHASE IB
 STEP 16.4
 DETAIL

DOCUMENT NOT CONSIDERED FINAL
 UNLESS ALL SIGNATURES COMPLETED

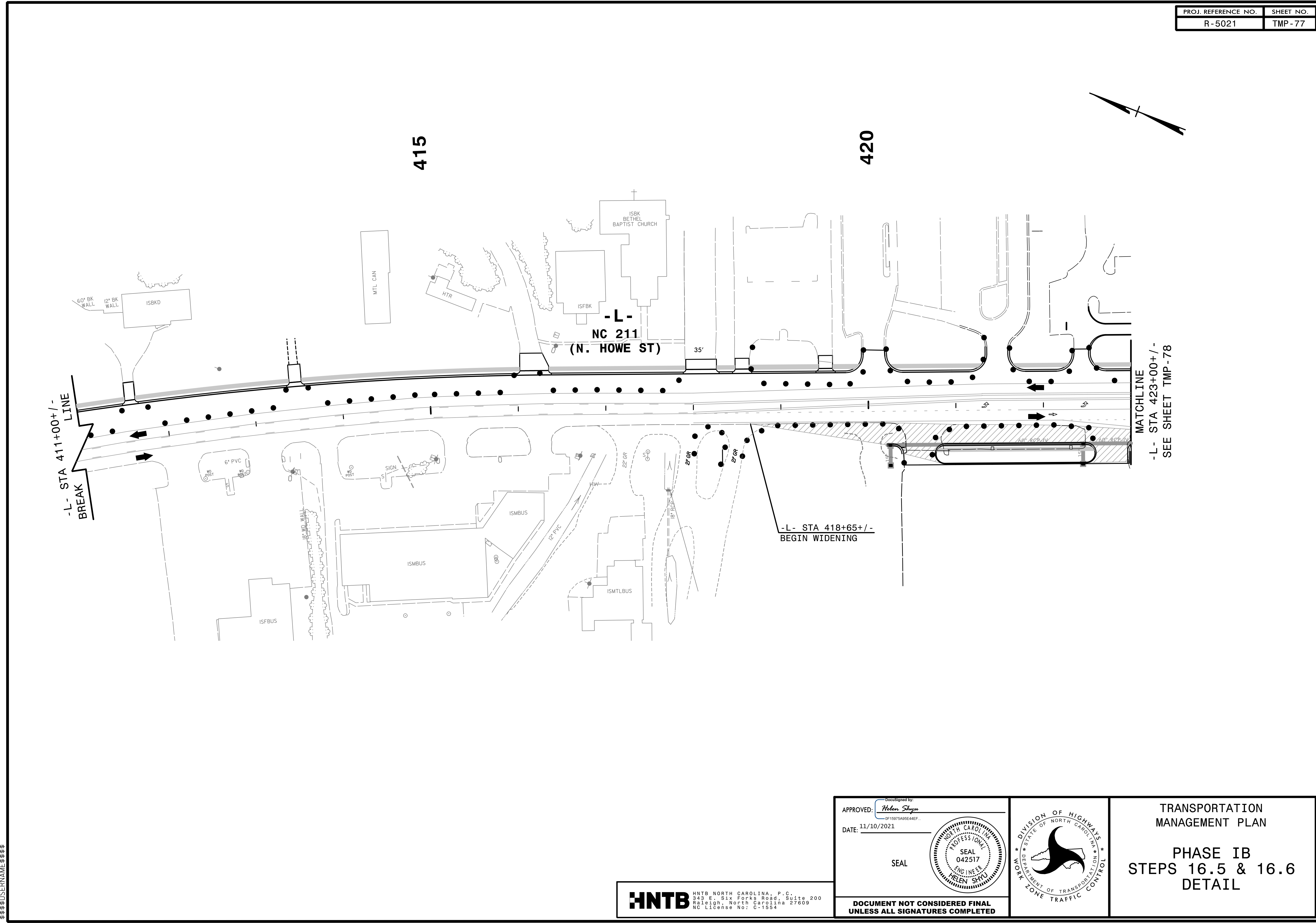

4:56:47 PM
 \\TCF\15021\1021\1021\1021.dgn
 \$\$\$USERNAME\$\$\$

HNTB HNTB NORTH CAROLINA, P.C.
 343 E. Six Forks Road, Suite 200
 Raleigh, North Carolina 27609
 NC License No: C-1554

APPROVED: *Helen Shyu*
 DATE: 11/10/2021
 SEAL
 DOCUMENT NOT CONSIDERED FINAL
 UNLESS ALL SIGNATURES COMPLETED

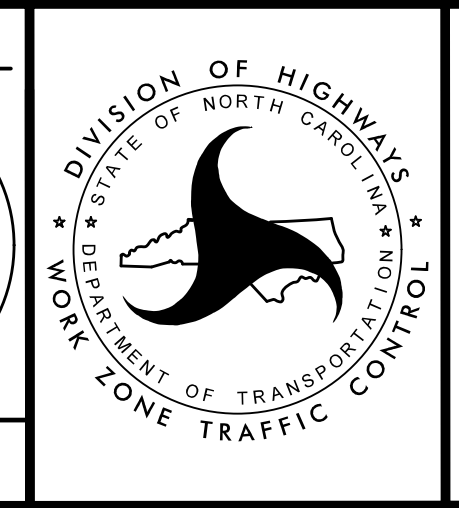
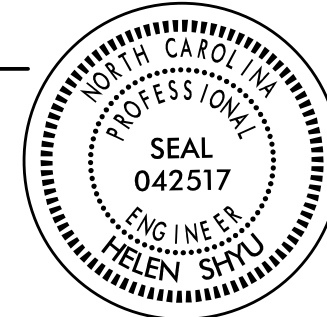

TRANSPORTATION
 MANAGEMENT PLAN
 PHASE IB
 STEPS 16.5 & 16.6
 DETAIL