

8/23/99



PROJ. REFERENCE NO.
R-5021

SHEET NO.
X-238

150 140 130 120 110 100 90 80 70 60 50 40 30 20 10 0 10 20 30 40 50 60 70 80 90 100 110 120 130 140 150

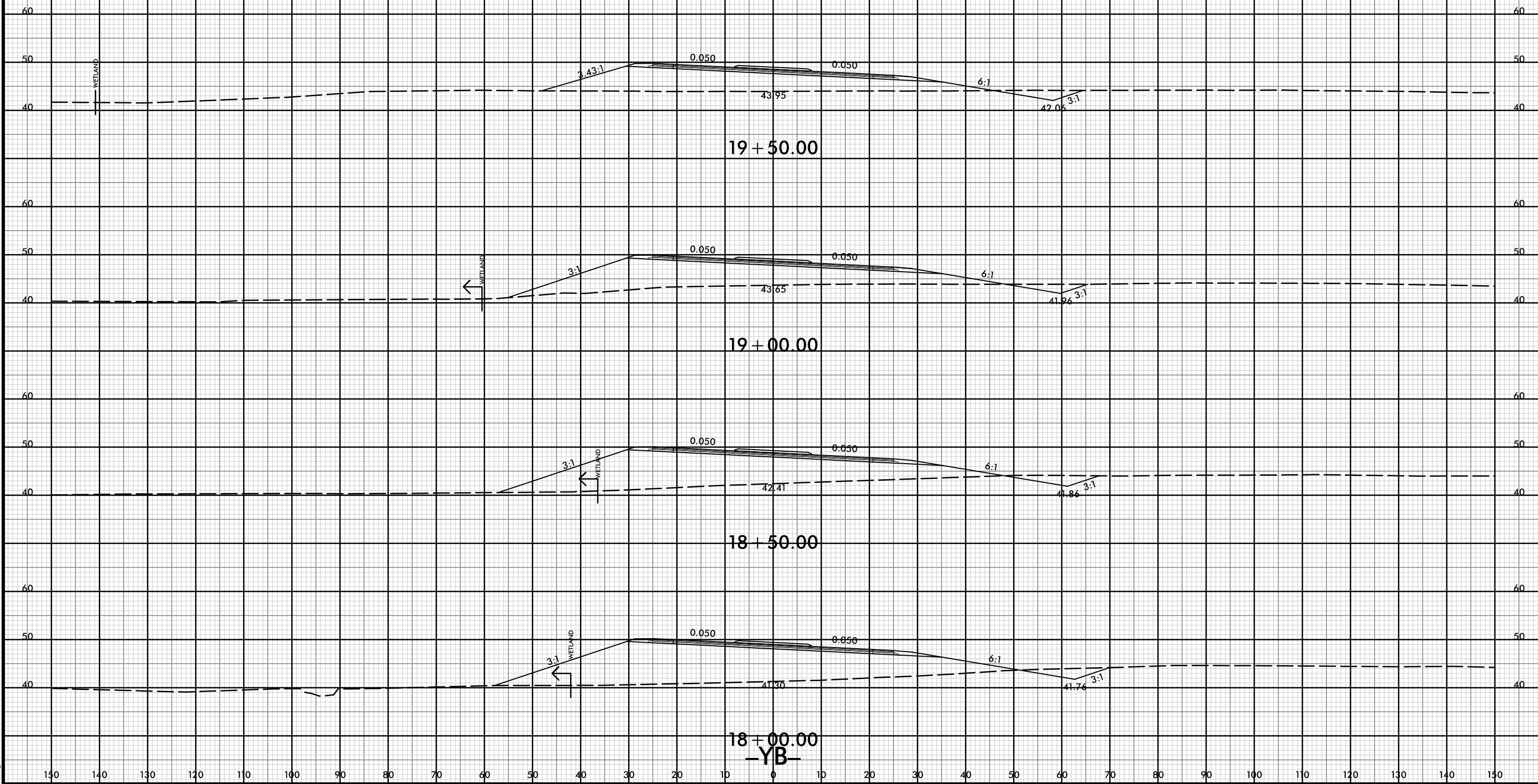

150 140 130 120 110 100 90 80 70 60 50 40 30 20 10 0 10 20 30 40 50 60 70 80 90 100 110 120 130 140 150

21-JUL-2021 10:37
 R:\p\dawej\XSC\1-5021-rdy-yp-l-yb.dgn
 HNTB

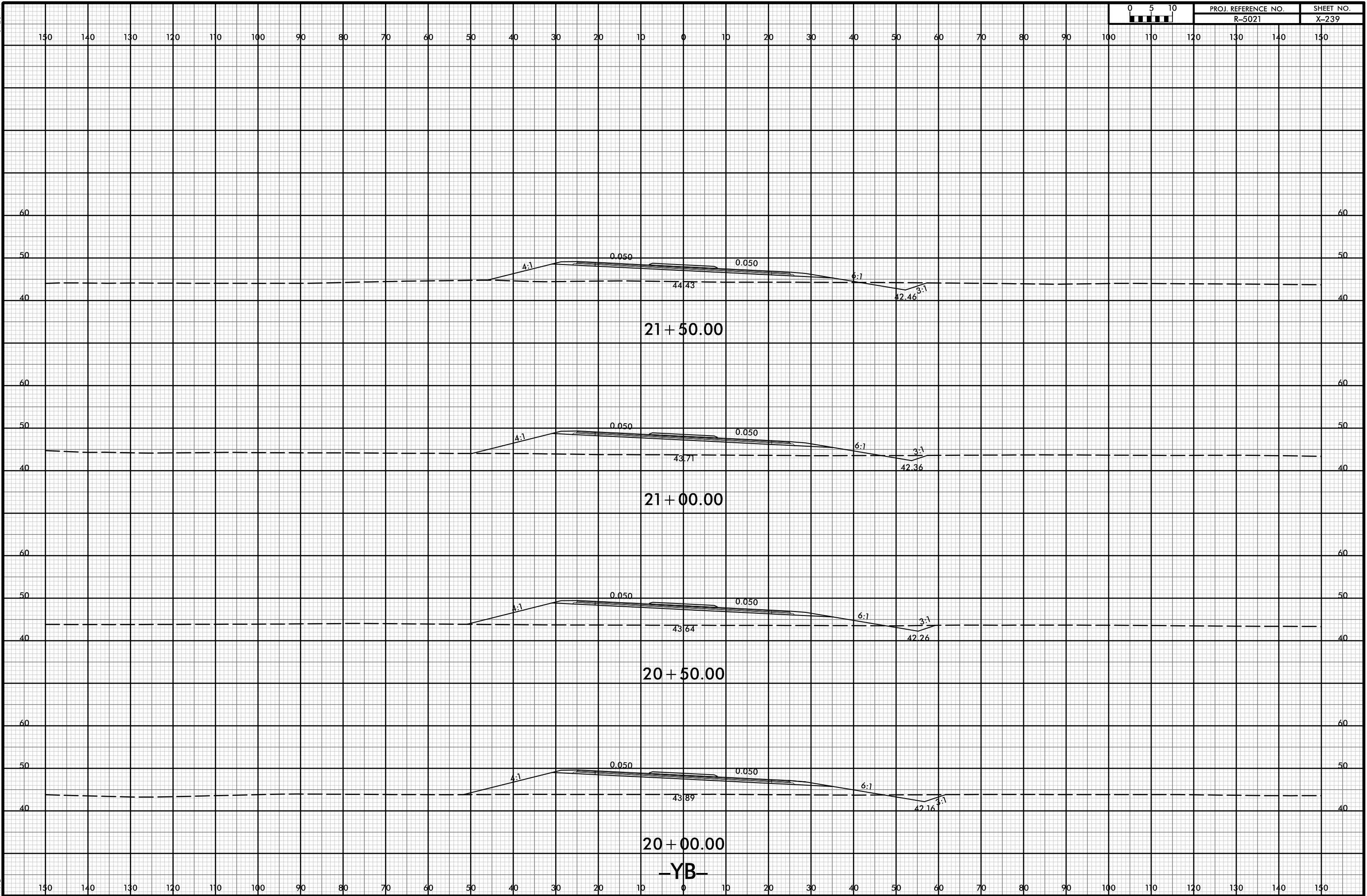



150 140 130 120 110 100 90 80 70 60 50 40 30 20 10 0 10 20 30 40 50 60 70 80 90 100 110 120 130 140 150

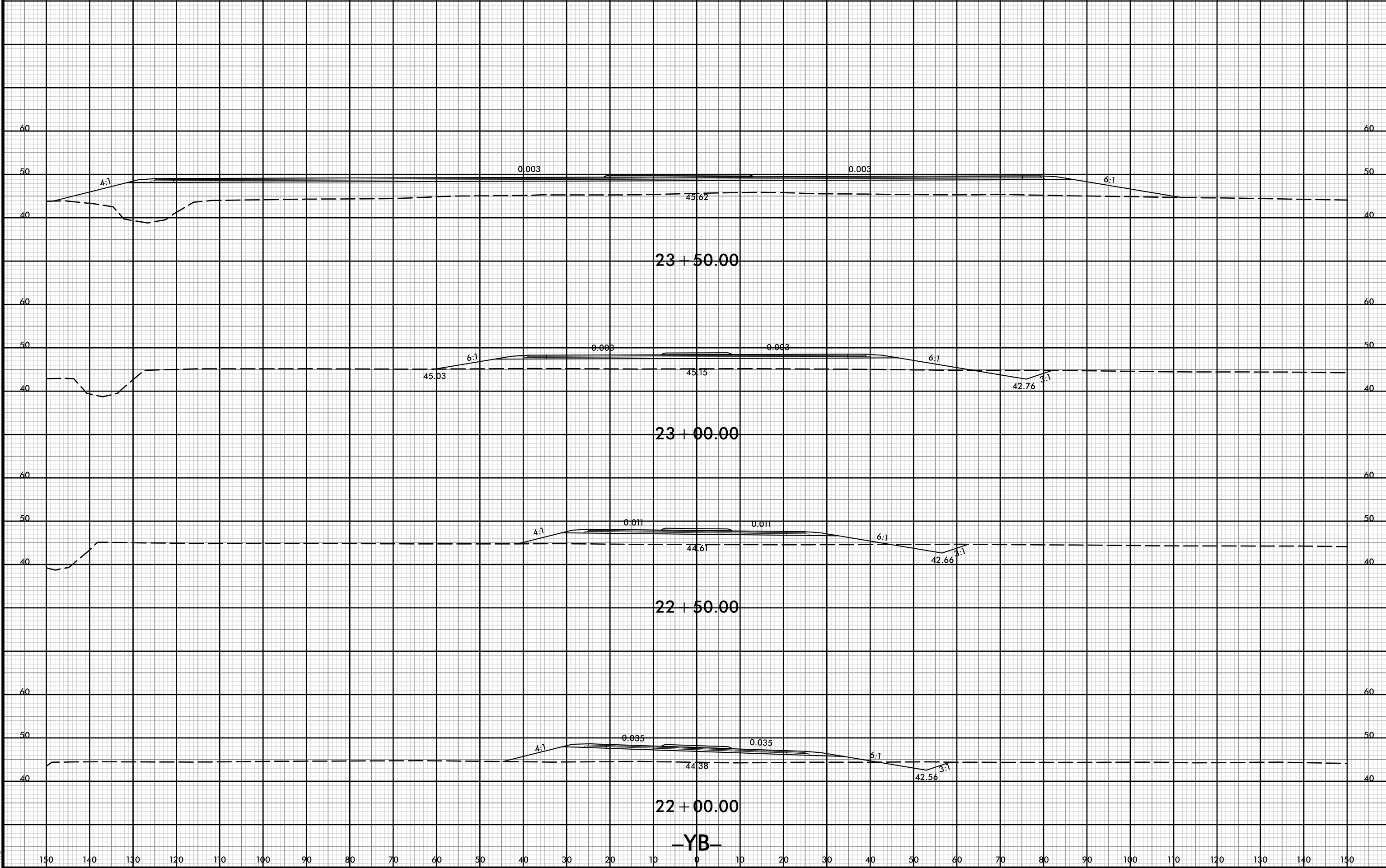

23 + 50.00

23 + 00.00

22 + 50.00

22 + 00.00

-YB-



150 140 130 120 110 100 90 80 70 60 50 40 30 20 10 0 10 20 30 40 50 60 70 80 90 100 110 120 130 140 150

60 60

50 50

40 40

24 + 00.00

-YB-

150 140 130 120 110 100 90 80 70 60 50 40 30 20 10 0 10 20 30 40 50 60 70 80 90 100 110 120 130 140 150



150 140 130 120 110 100 90 80 70 60 50 40 30 20 10 0 10 20 30 40 50 60 70 80 90 100 110 120 130 140 150

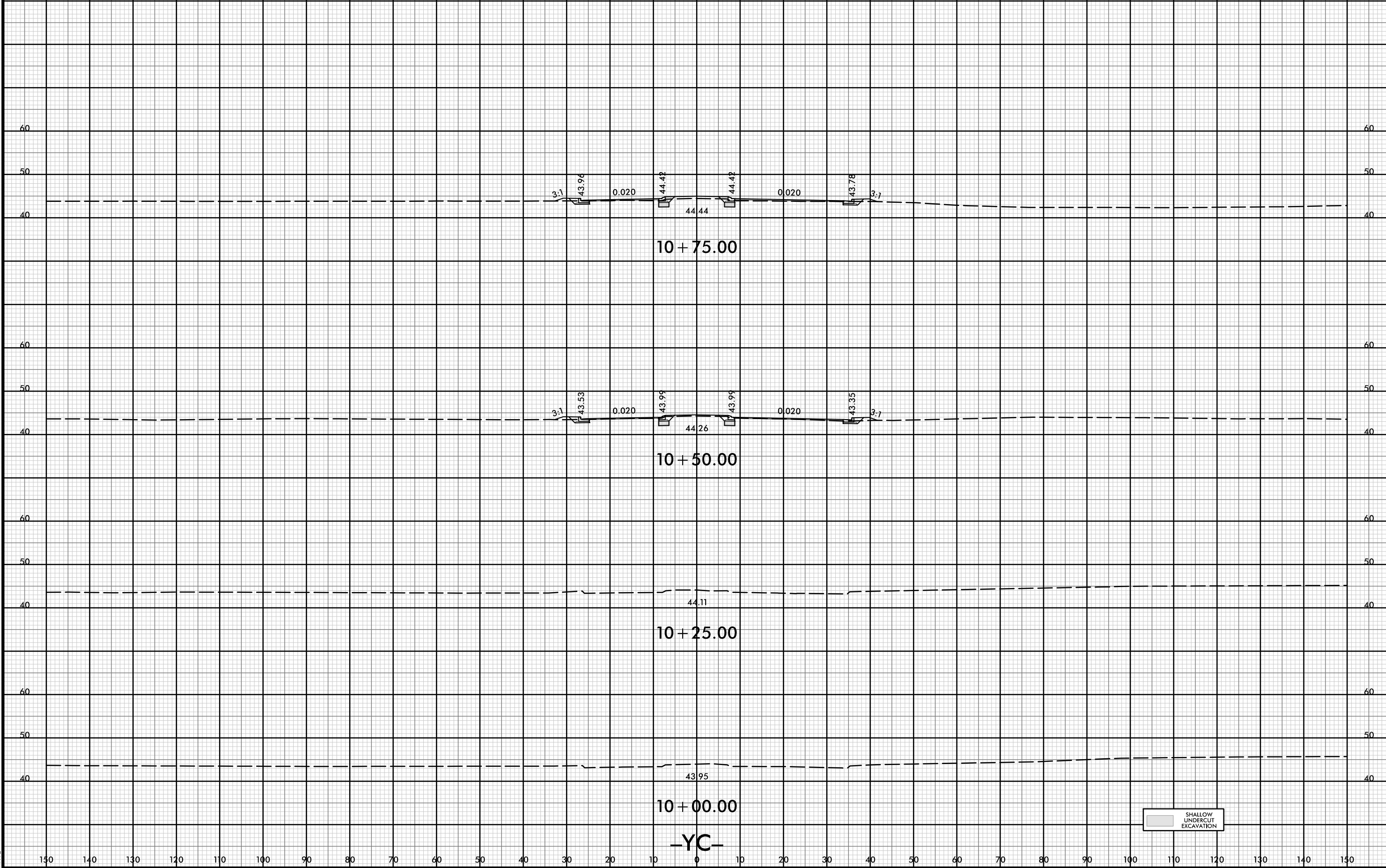

10 + 75.00

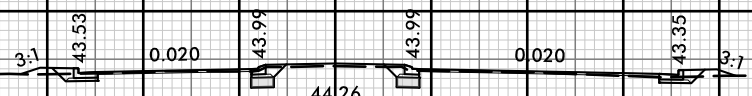

10 + 50.00

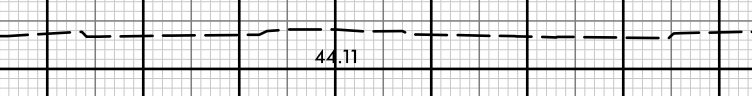

10 + 25.00

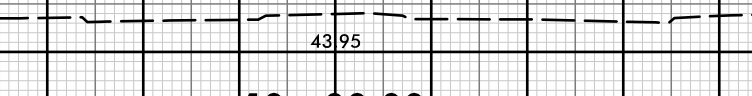

10 + 00.00

-YC-

SHALLOW UNDERCUT EXCAVATION



150 140 130 120 110 100 90 80 70 60 50 40 30 20 10 0 10 20 30 40 50 60 70 80 90 100 110 120 130 140 150

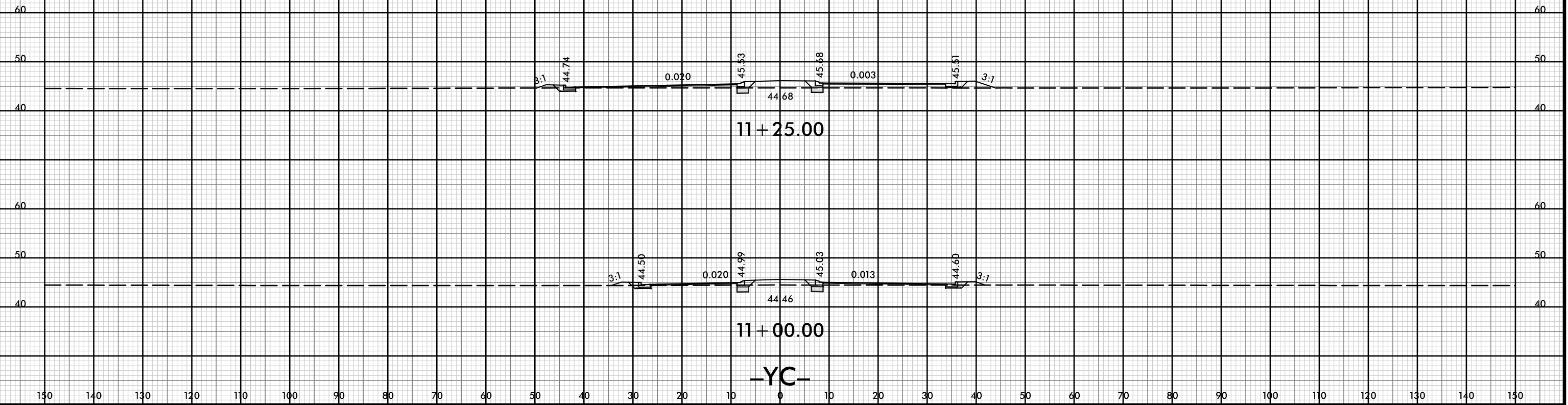

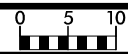

150 140 130 120 110 100 90 80 70 60 50 40 30 20 10 0 10 20 30 40 50 60 70 80 90 100 110 120 130 140 150

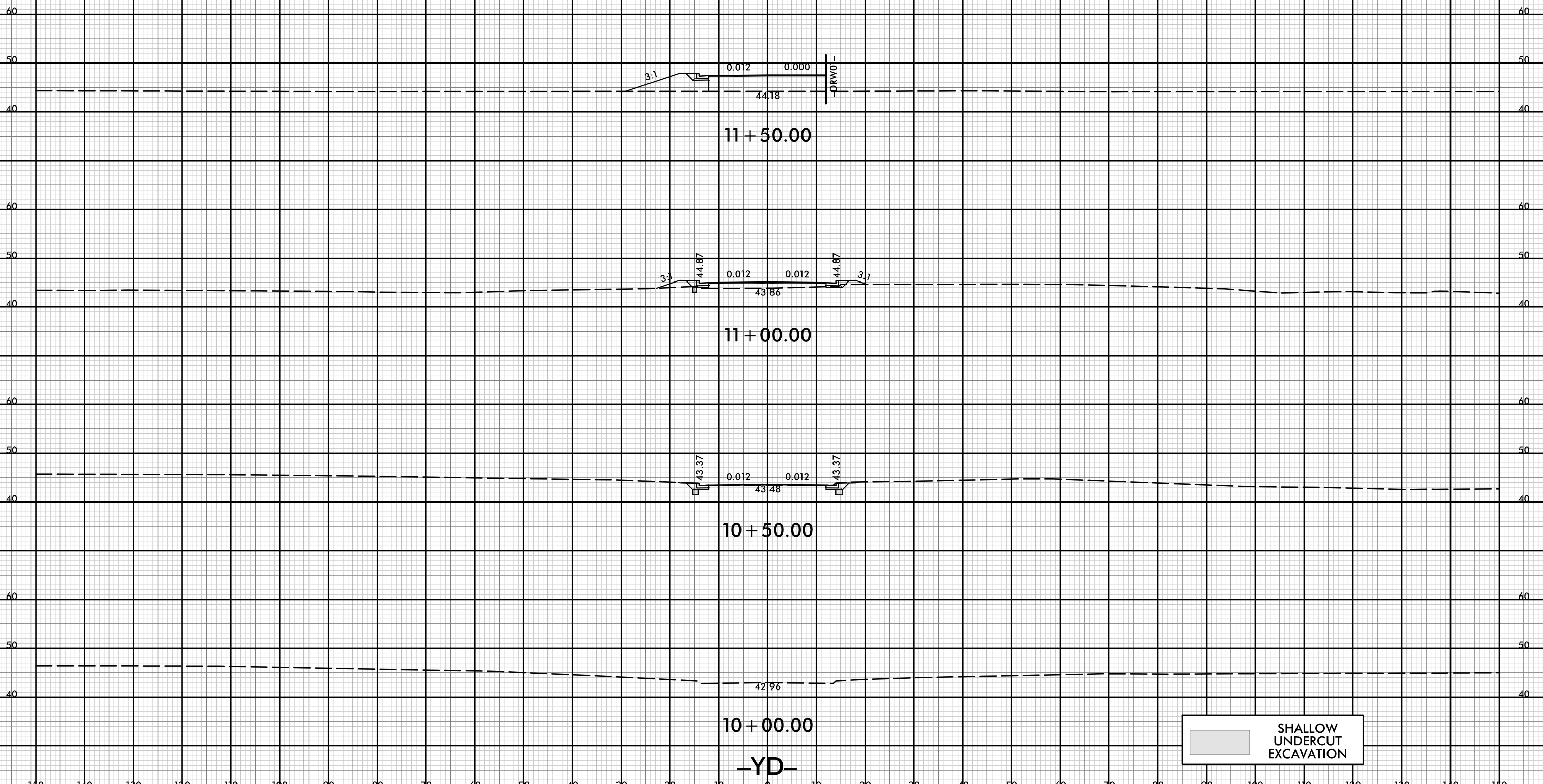

150 140 130 120 110 100 90 80 70 60 50 40 30 20 10 0 10 20 30 40 50 60 70 80 90 100 110 120 130 140 150



150 140 130 120 110 100 90 80 70 60 50 40 30 20 10 0 10 20 30 40 50 60 70 80 90 100 110 120 130 140 150

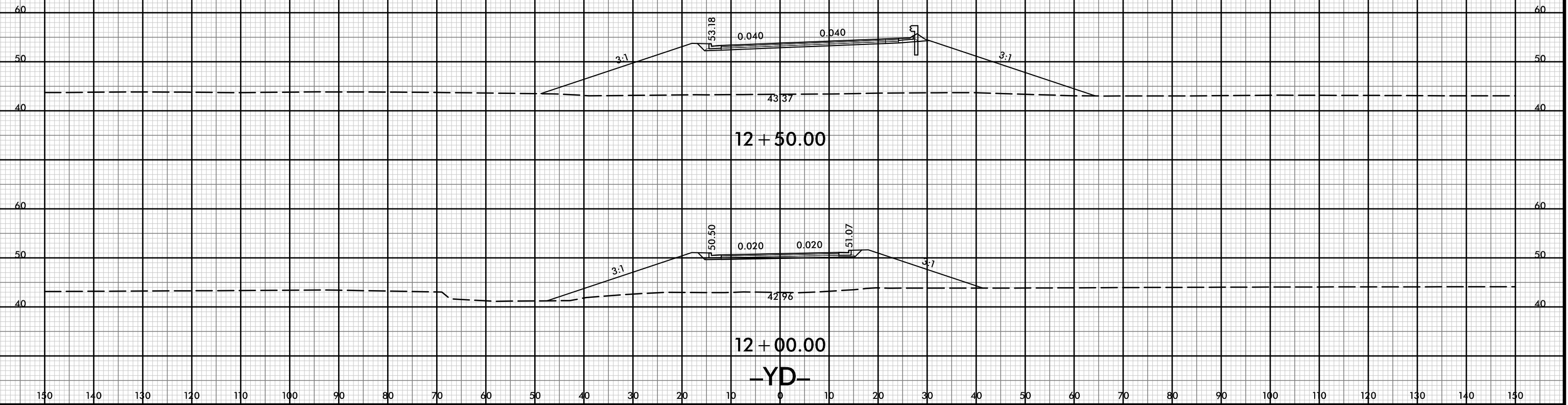

150 140 130 120 110 100 90 80 70 60 50 40 30 20 10 0 10 20 30 40 50 60 70 80 90 100 110 120 130 140 150



150 140 130 120 110 100 90 80 70 60 50 40 30 20 10 0 10 20 30 40 50 60 70 80 90 100 110 120 130 140 150

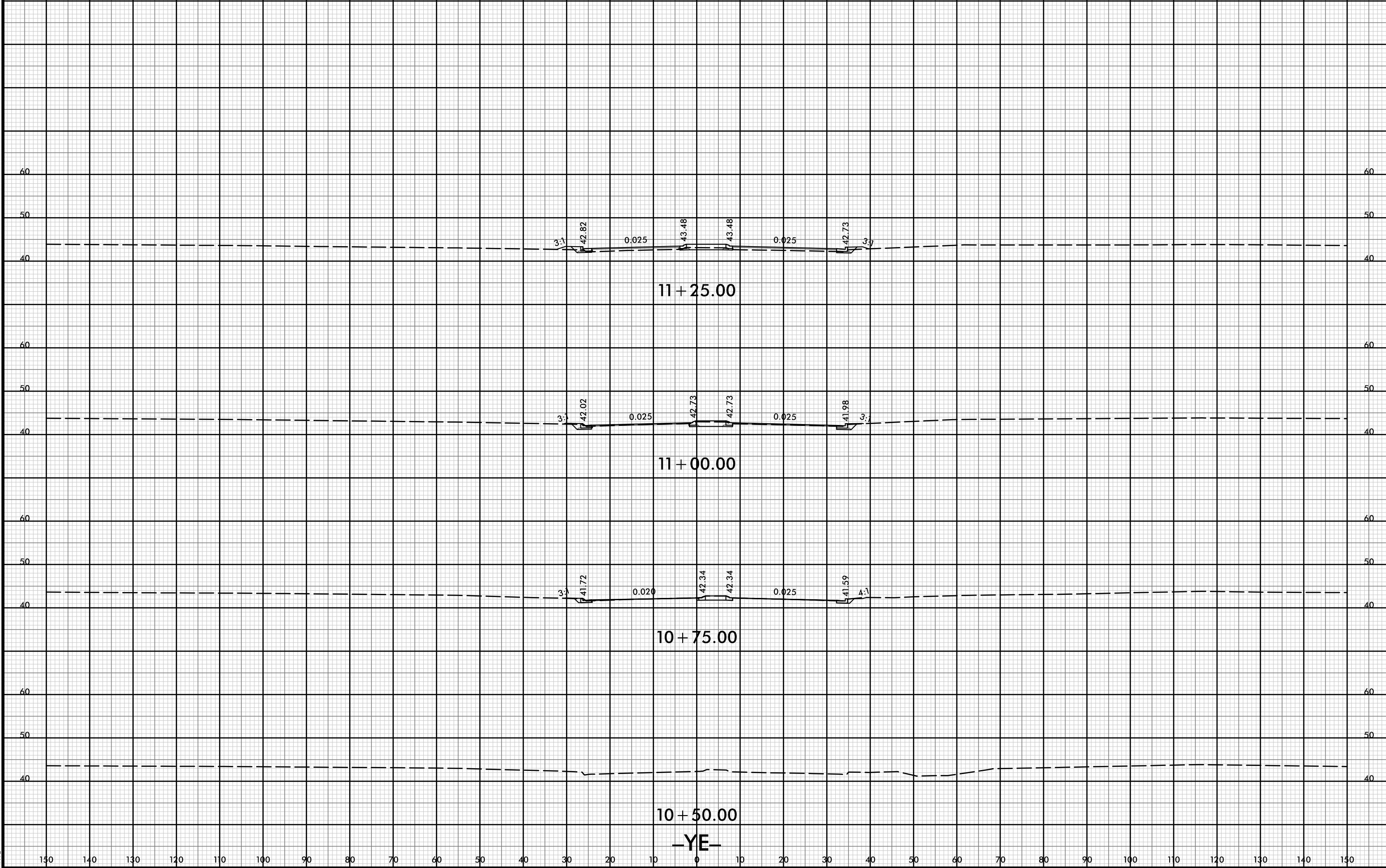

10 + 50.00

-YE-

150 140 130 120 110 100 90 80 70 60 50 40 30 20 10 0 10 20 30 40 50 60 70 80 90 100 110 120 130 140 150



150 140 130 120 110 100 90 80 70 60 50 40 30 20 10 0 10 20 30 40 50 60 70 80 90 100 110 120 130 140 150

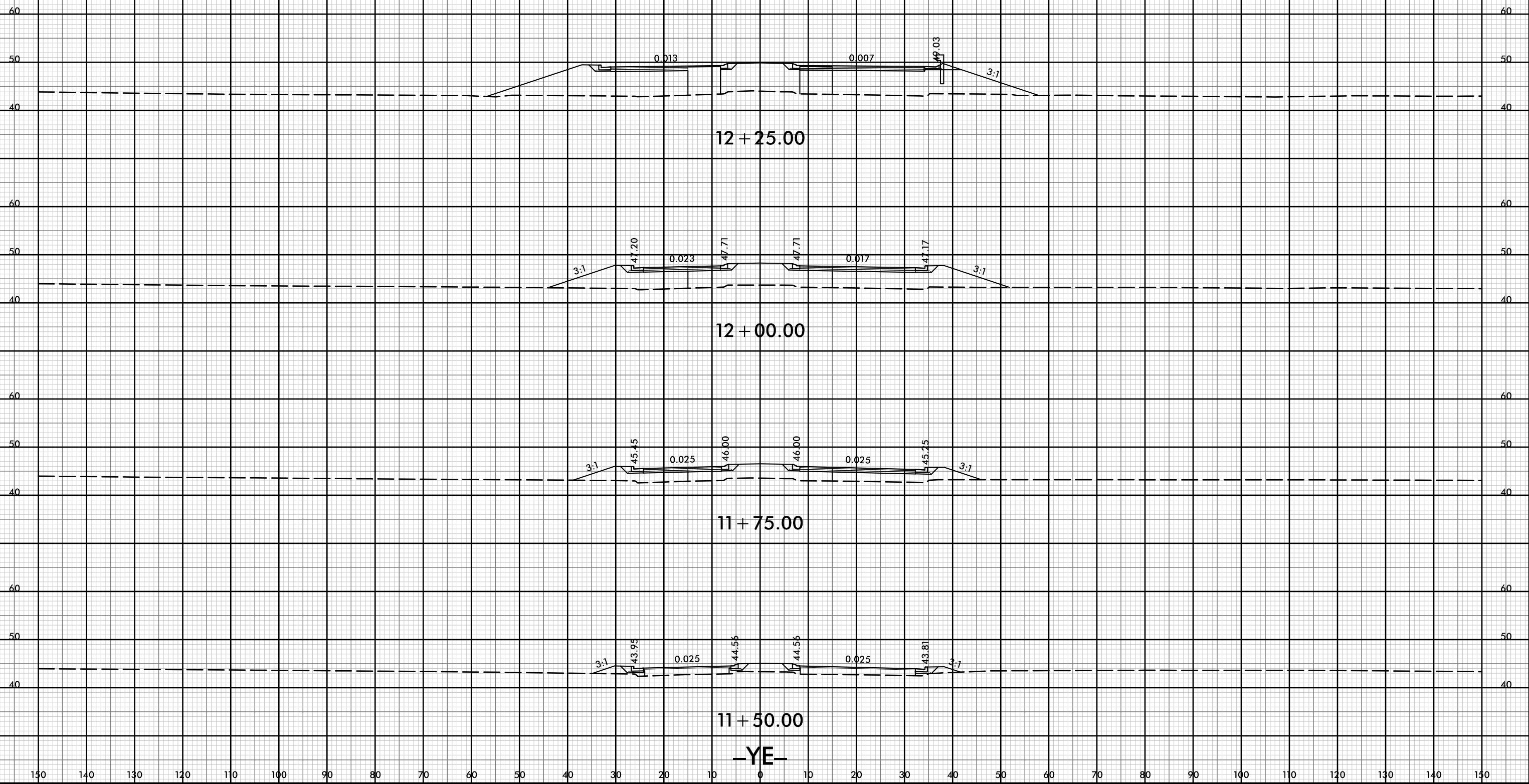

-YE-



150 140 130 120 110 100 90 80 70 60 50 40 30 20 10 0 10 20 30 40 50 60 70 80 90 100 110 120 130 140 150

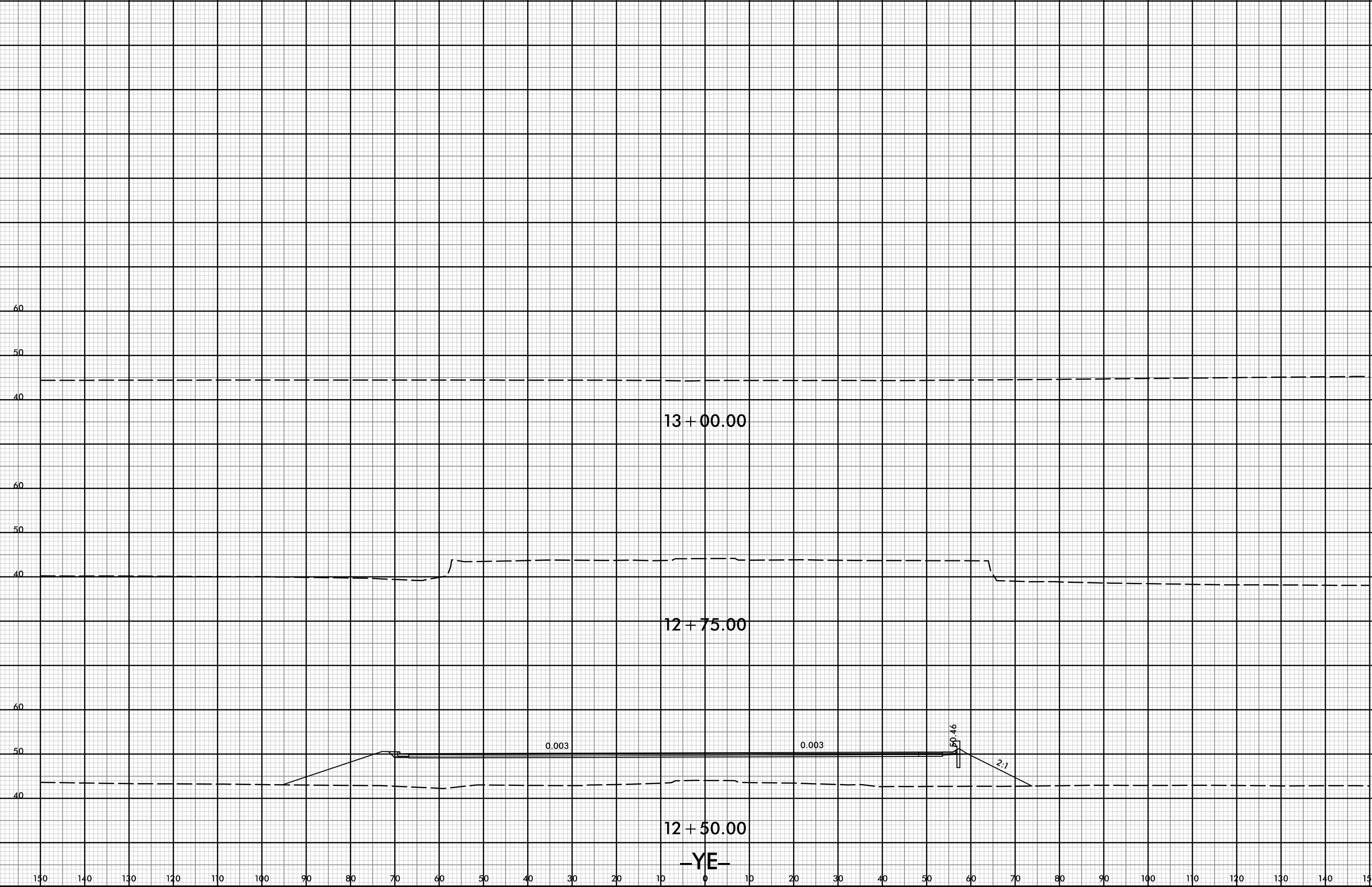

13 + 00.00

12 + 75.00

12 + 50.00

-YE-

0.003

0.003

50.46

2:1

150 140 130 120 110 100 90 80 70 60 50 40 30 20 10 0 10 20 30 40 50 60 70 80 90 100 110 120 130 140 150

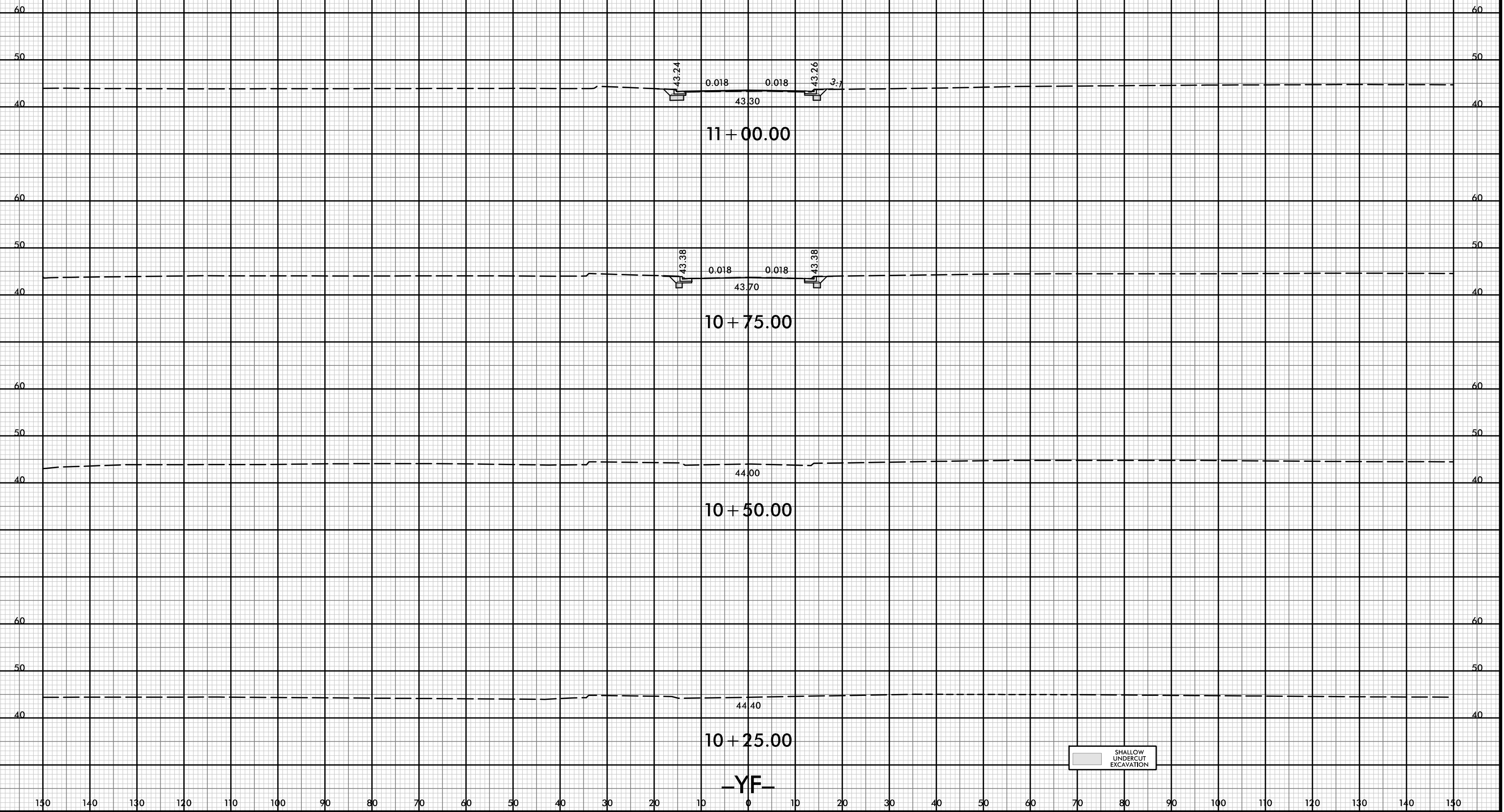

SHALLOW UNDERCUT EXCAVATION

-YF-

150 140 130 120 110 100 90 80 70 60 50 40 30 20 10 0 10 20 30 40 50 60 70 80 90 100 110 120 130 140 150

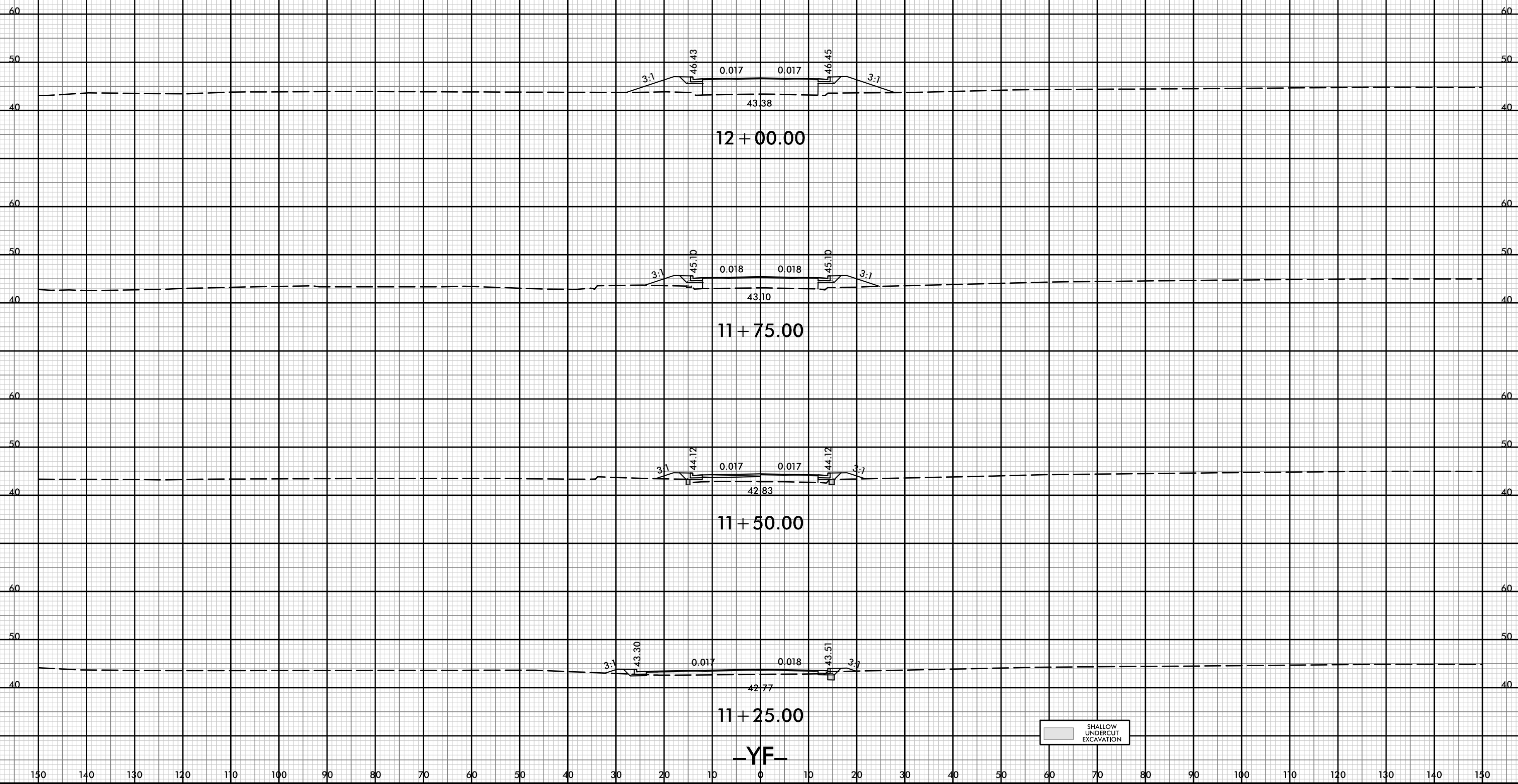

8/23/99



PROJ. REFERENCE NO.
R-5021

SHEET NO.
X-251

150 140 130 120 110 100 90 80 70 60 50 40 30 20 10 0 10 20 30 40 50 60 70 80 90 100 110 120 130 140 150

60 60

50 50

40 40

45.38
13 + 00.00

60 60

50 50

40 40

44.24
12 + 75.00

60 60

50 50

40 40

43.91
12 + 50.00

60 60

50 50

40 40

43.65
12 + 25.00

-YF-

150 140 130 120 110 100 90 80 70 60 50 40 30 20 10 0 10 20 30 40 50 60 70 80 90 100 110 120 130 140 150

21-Jul-2021 10:37
 R:\p\dawej\XSC\5021-rdy-xl-YF.dgn
 HNTB



150 140 130 120 110 100 90 80 70 60 50 40 30 20 10 0 10 20 30 40 50 60 70 80 90 100 110 120 130 140 150

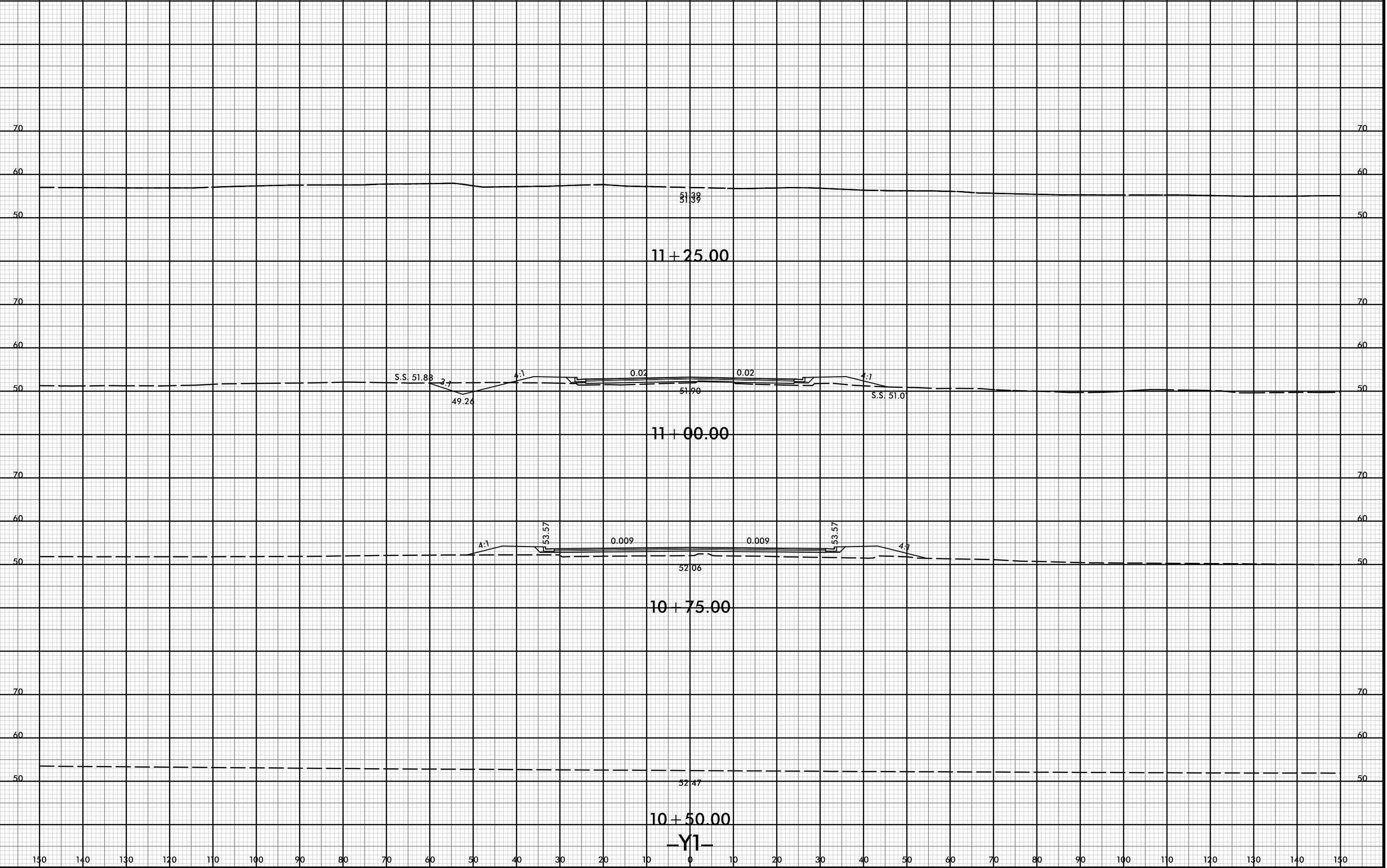

150 140 130 120 110 100 90 80 70 60 50 40 30 20 10 0 10 20 30 40 50 60 70 80 90 100 110 120 130 140 150



150 140 130 120 110 100 90 80 70 60 50 40 30 20 10 0 10 20 30 40 50 60 70 80 90 100 110 120 130 140 150

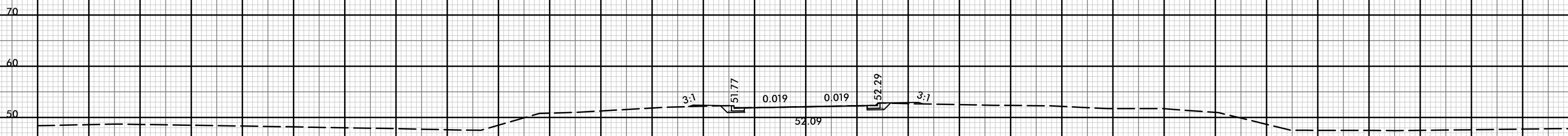

10 + 50.00

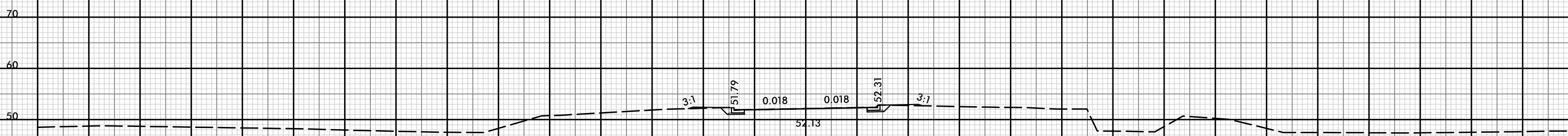

10 + 45.00

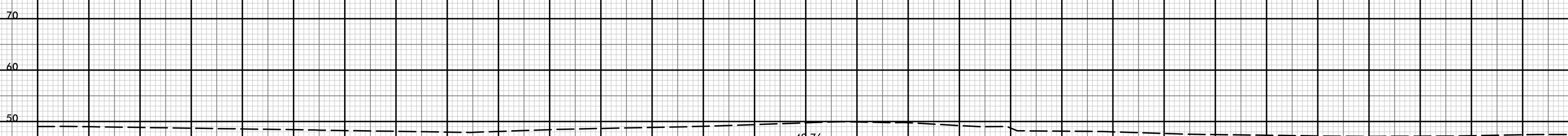

10 + 25.00

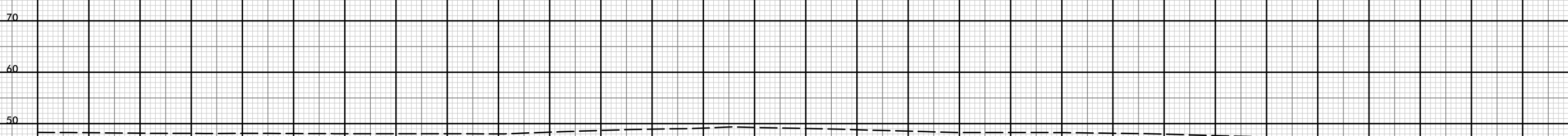

10 + 00.00

-YIA-

150 140 130 120 110 100 90 80 70 60 50 40 30 20 10 0 10 20 30 40 50 60 70 80 90 100 110 120 130 140 150

150 140 130 120 110 100 90 80 70 60 50 40 30 20 10 0 10 20 30 40 50 60 70 80 90 100 110 120 130 140 150

70 70

60 60

50 50

11 + 50.00

11 + 25.00

11 + 00.00

10 + 75.00

-Y1A-

51.24

51.48

51.75

51.93

55.86

54.30

52.80

52.00

55.93

54.65

53.36

52.56

0.002 0.002

0.012 0.012

0.020 0.020

0.020 0.020

3:1

3:1

3:1

3:1

3:1

3:1

3:1

3:1

8/23/99



PROJ. REFERENCE NO.
R-5021

SHEET NO.
X-255

150 140 130 120 110 100 90 80 70 60 50 40 30 20 10 0 10 20 30 40 50 60 70 80 90 100 110 120 130 140 150

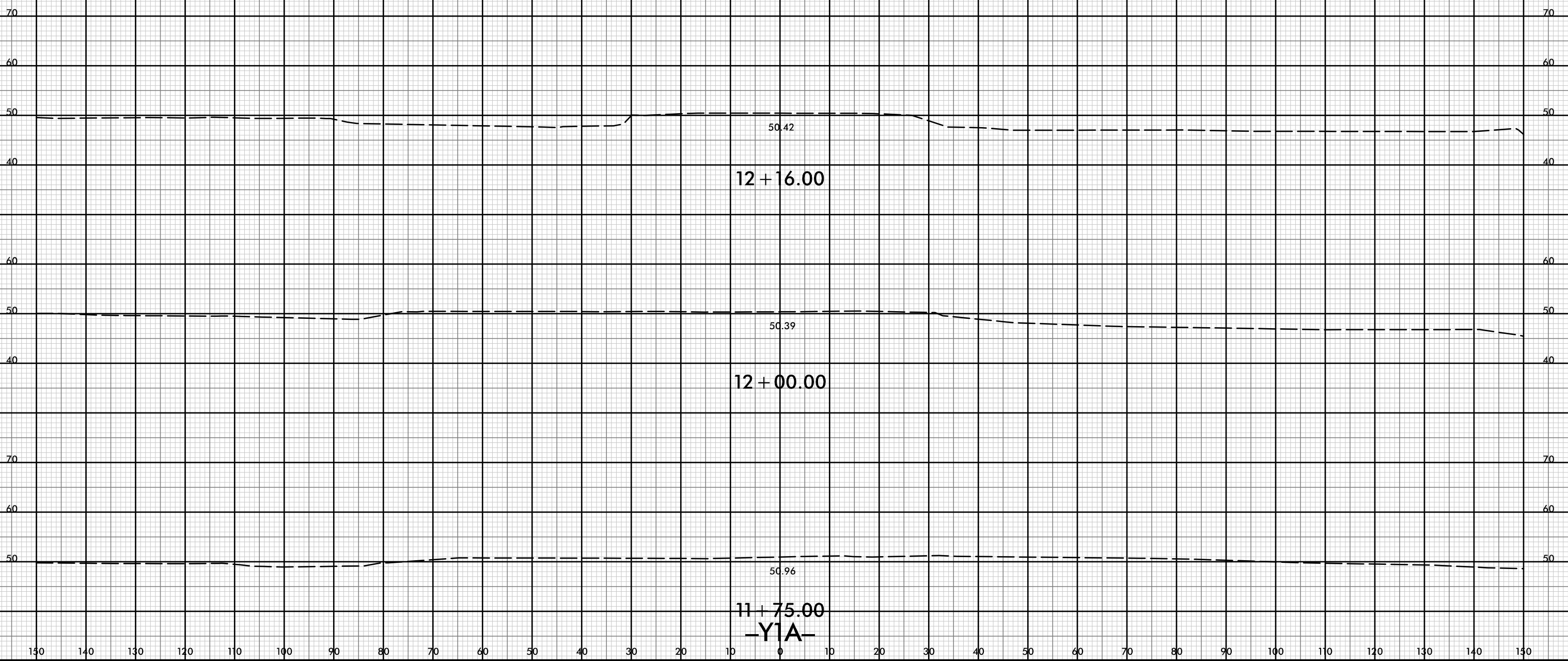

21-Jul-2021 10:47
R:\p\dawej\XSC\5021-rdy-yp-l-Y1A.dgn
HTB



150 140 130 120 110 100 90 80 70 60 50 40 30 20 10 0 10 20 30 40 50 60 70 80 90 100 110 120 130 140 150

70 70

60 60

50 50

3:1 0.025 0.025 3:1

10 + 75.00

70 70

60 60

50 50

0.025 0.025 3:1

10 + 50.00

70 70

60 60

50 50

0.025 0.025 3:1

10 + 25.00

70 70

60 60

50 50

0.025 0.025

10 + 00.00

-YIC-

150 140 130 120 110 100 90 80 70 60 50 40 30 20 10 0 10 20 30 40 50 60 70 80 90 100 110 120 130 140 150

8/23/99



PROJ. REFERENCE NO.
R-5021

SHEET NO.
X-257

150 140 130 120 110 100 90 80 70 60 50 40 30 20 10 0 10 20 30 40 50 60 70 80 90 100 110 120 130 140 150

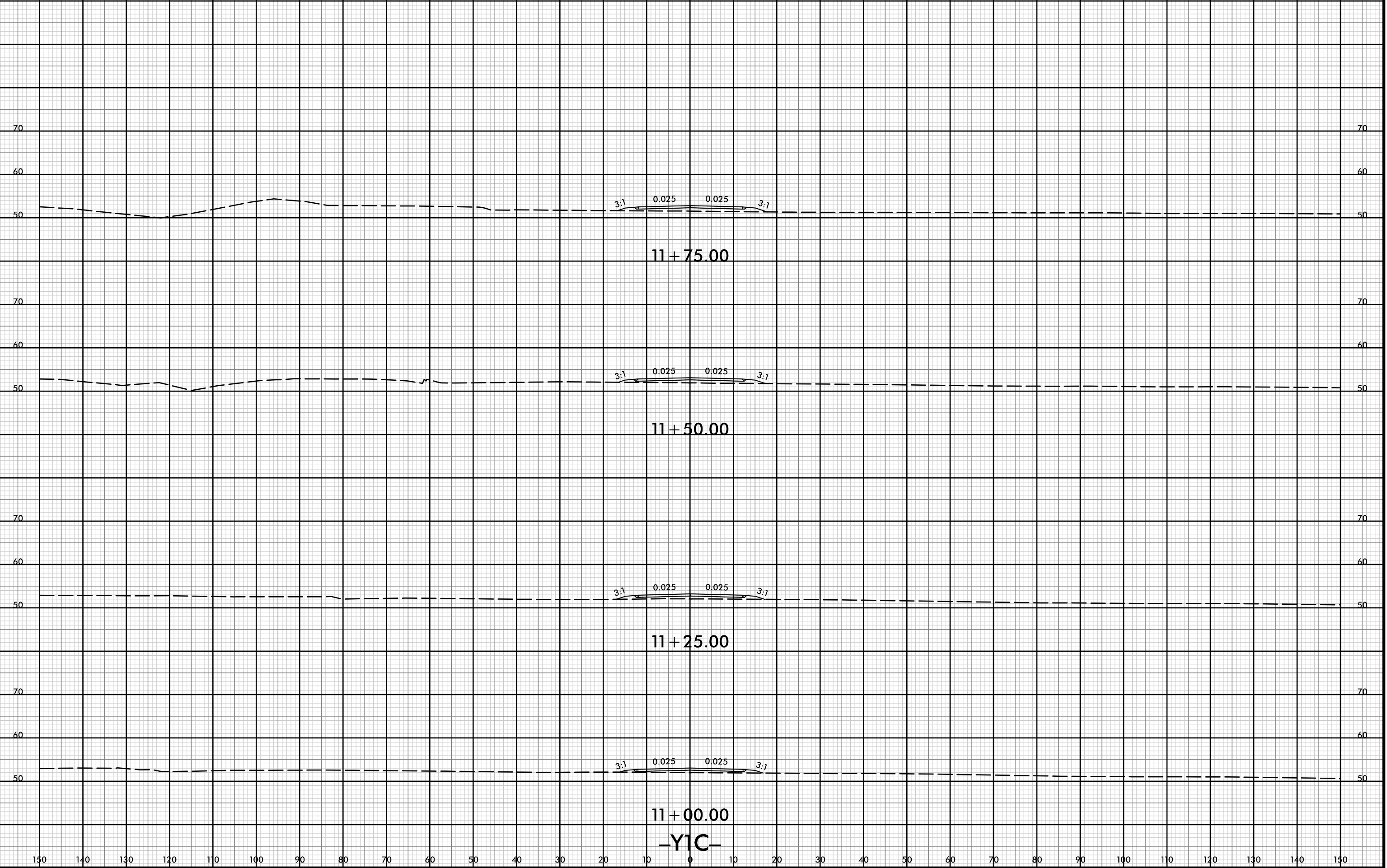

11+75.00

11+50.00

11+25.00

11+00.00

-YIC-

21-JUL-2021 10:38
 R:\p\dawej\XSCA\5021-rdy-xp-l-YIC.dgn
 HNTB



150 140 130 120 110 100 90 80 70 60 50 40 30 20 10 0 10 20 30 40 50 60 70 80 90 100 110 120 130 140 150

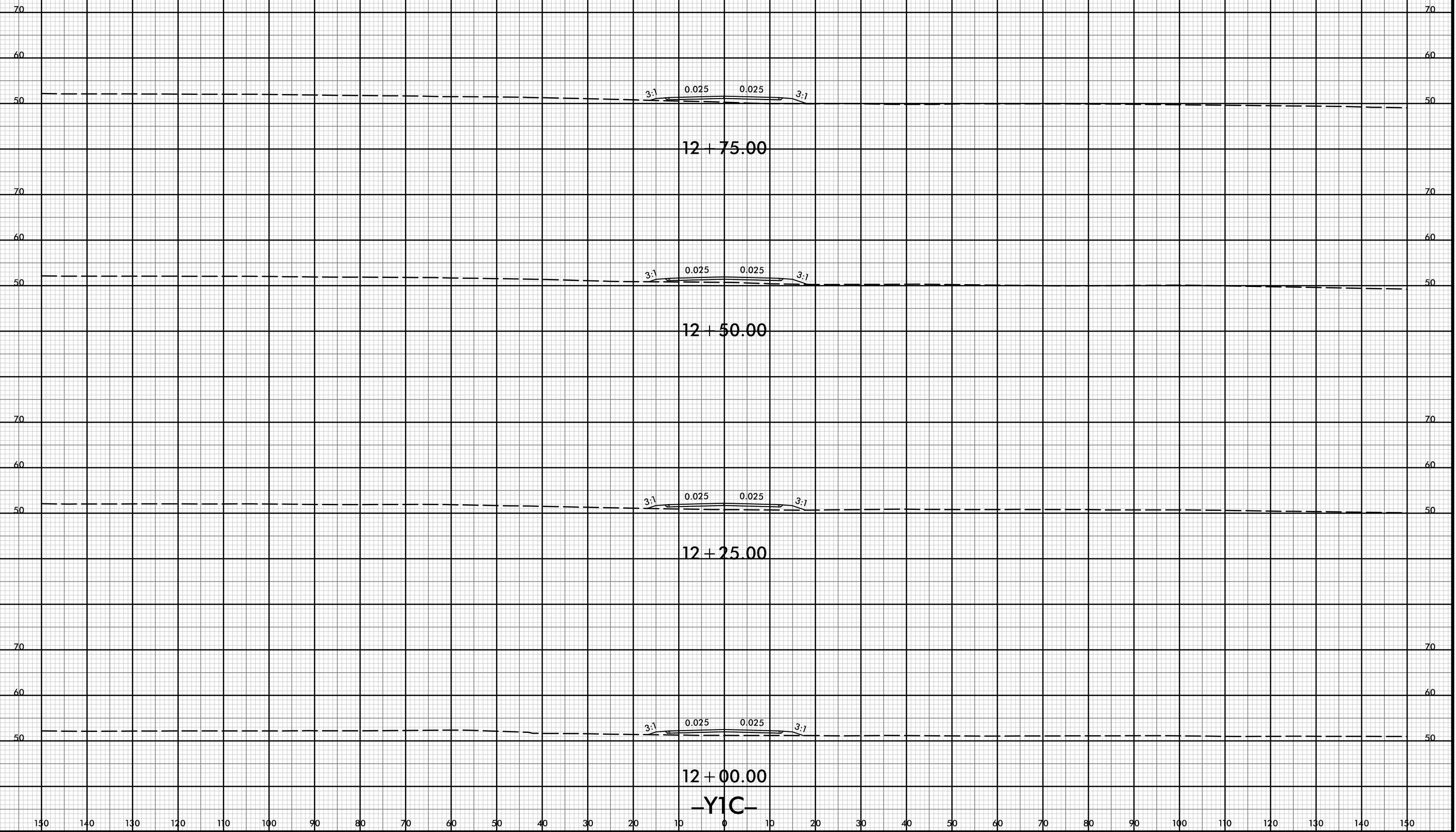

12 + 75.00

12 + 50.00

12 + 25.00

12 + 00.00

-Y1C-

8/23/99



PROJ. REFERENCE NO.
R-5021

SHEET NO.
X-259

150 140 130 120 110 100 90 80 70 60 50 40 30 20 10 0 10 20 30 40 50 60 70 80 90 100 110 120 130 140 150

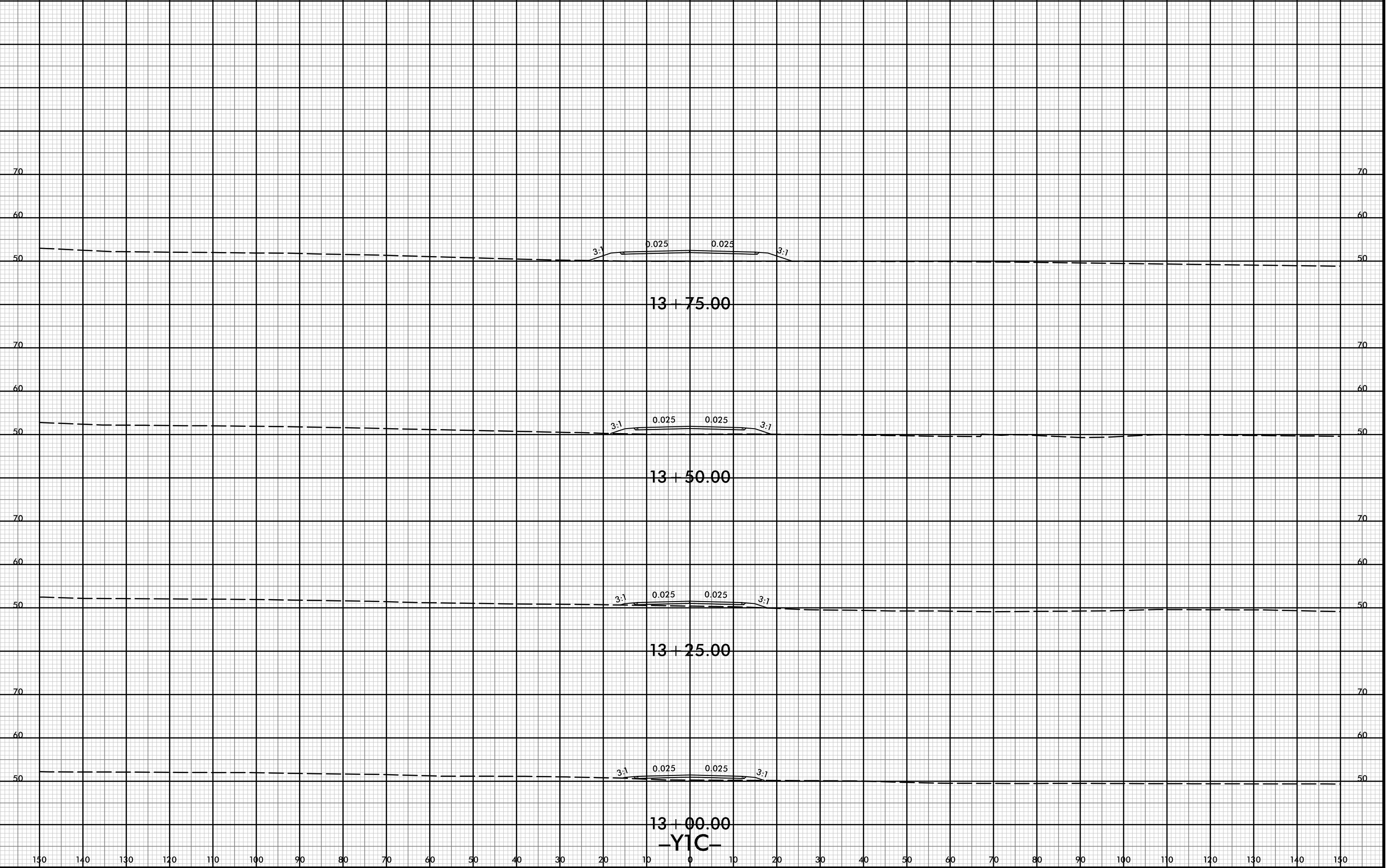

150 140 130 120 110 100 90 80 70 60 50 40 30 20 10 0 10 20 30 40 50 60 70 80 90 100 110 120 130 140 150

21-Jul-2021 10:38
R:\p\dawej\XSCA\5021-rdy-xp-l-YIC.dgn
HTB



150 140 130 120 110 100 90 80 70 60 50 40 30 20 10 0 10 20 30 40 50 60 70 80 90 100 110 120 130 140 150

70 70

60 60

50 50

14 + 75.00

70 70

60 60

50 50

14 + 50.00

70 70

60 60

50 50

14 + 25.00

70 70

60 60

50 50

14 + 00.00

-YIC-

150 140 130 120 110 100 90 80 70 60 50 40 30 20 10 0 10 20 30 40 50 60 70 80 90 100 110 120 130 140 150



150 140 130 120 110 100 90 80 70 60 50 40 30 20 10 0 10 20 30 40 50 60 70 80 90 100 110 120 130 140 150

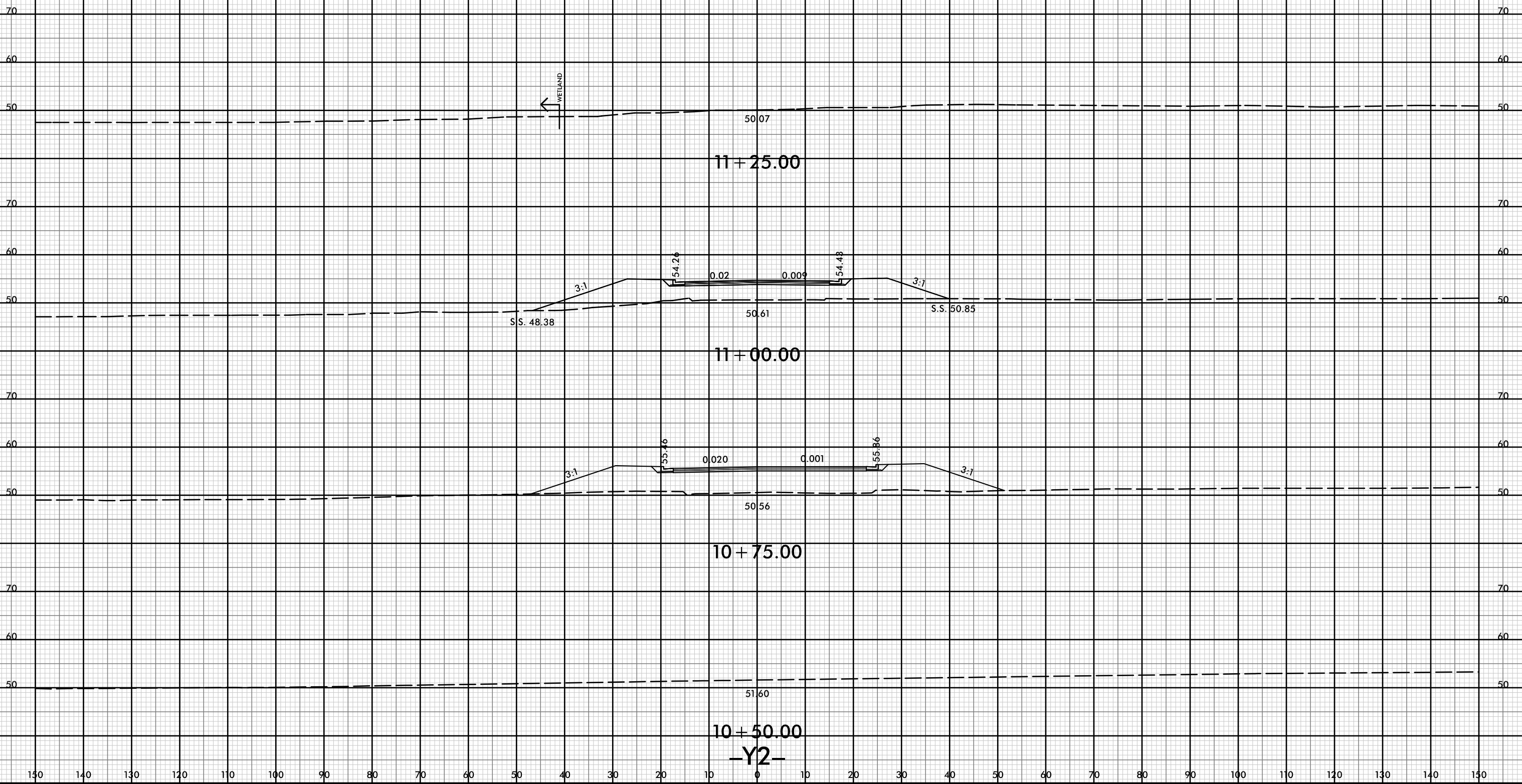



150 140 130 120 110 100 90 80 70 60 50 40 30 20 10 0 10 20 30 40 50 60 70 80 90 100 110 120 130 140 150

70 70

60 60

50 50

40 40

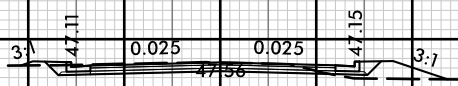

10 + 75.00

60 60

50 50

40 40

45.55

10 + 50.00

60 60

50 50

40 40

45.79

10 + 25.00

60 60

50 50

40 40

46.48

10 + 00.00

-Y2A-

150 140 130 120 110 100 90 80 70 60 50 40 30 20 10 0 10 20 30 40 50 60 70 80 90 100 110 120 130 140 150

8/23/99



PROJ. REFERENCE NO.
R-5021

SHEET NO.
X-263

150 140 130 120 110 100 90 80 70 60 50 40 30 20 10 0 10 20 30 40 50 60 70 80 90 100 110 120 130 140 150

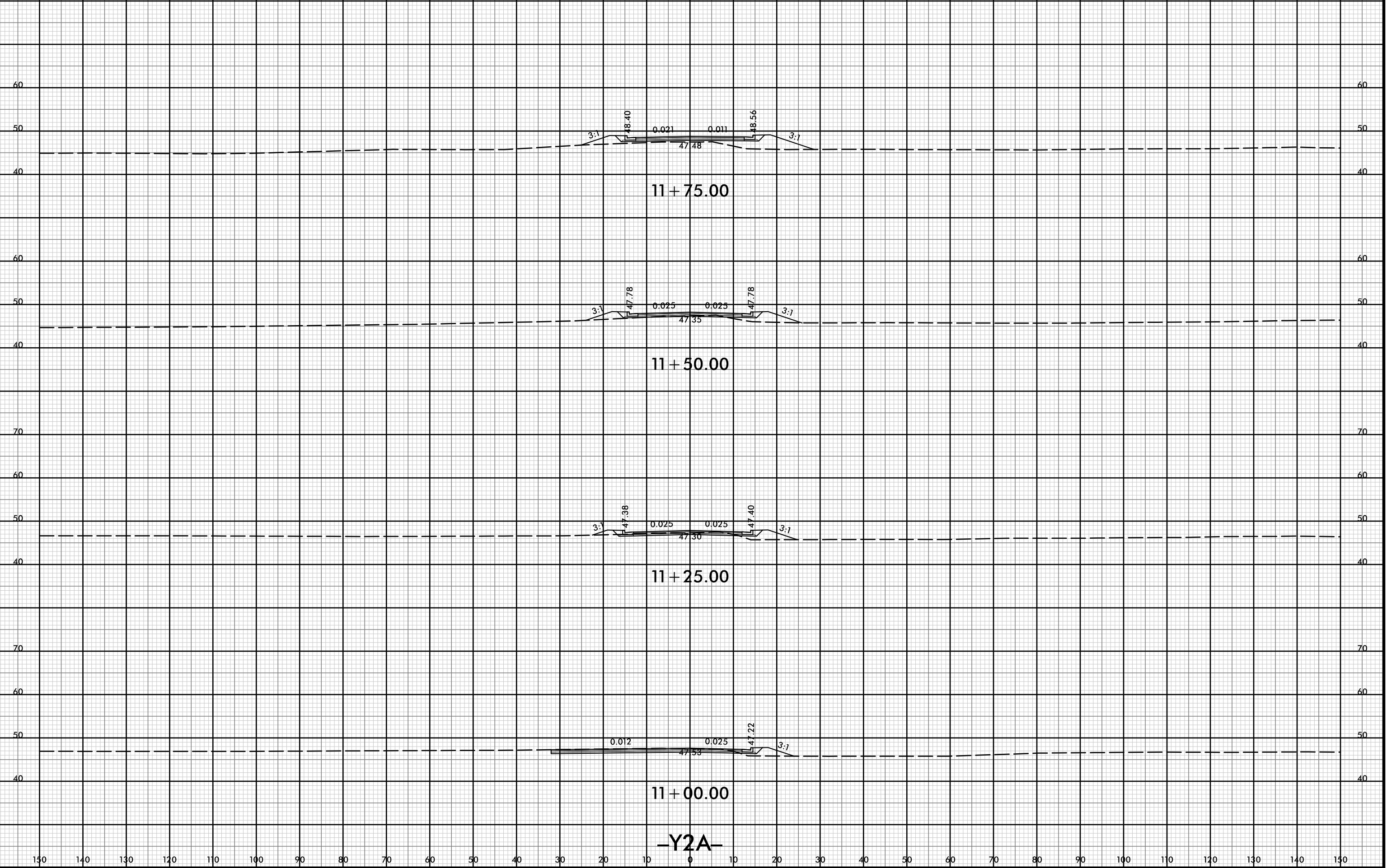

21-Jul-2021 10:38
R:\p\dawej\XSCA\5021-rdy-yp-1-Y2A.dgn
HTB

8/23/99



PROJ. REFERENCE NO.
R-5021

SHEET NO.
X-264

150 140 130 120 110 100 90 80 70 60 50 40 30 20 10 0 10 20 30 40 50 60 70 80 90 100 110 120 130 140 150

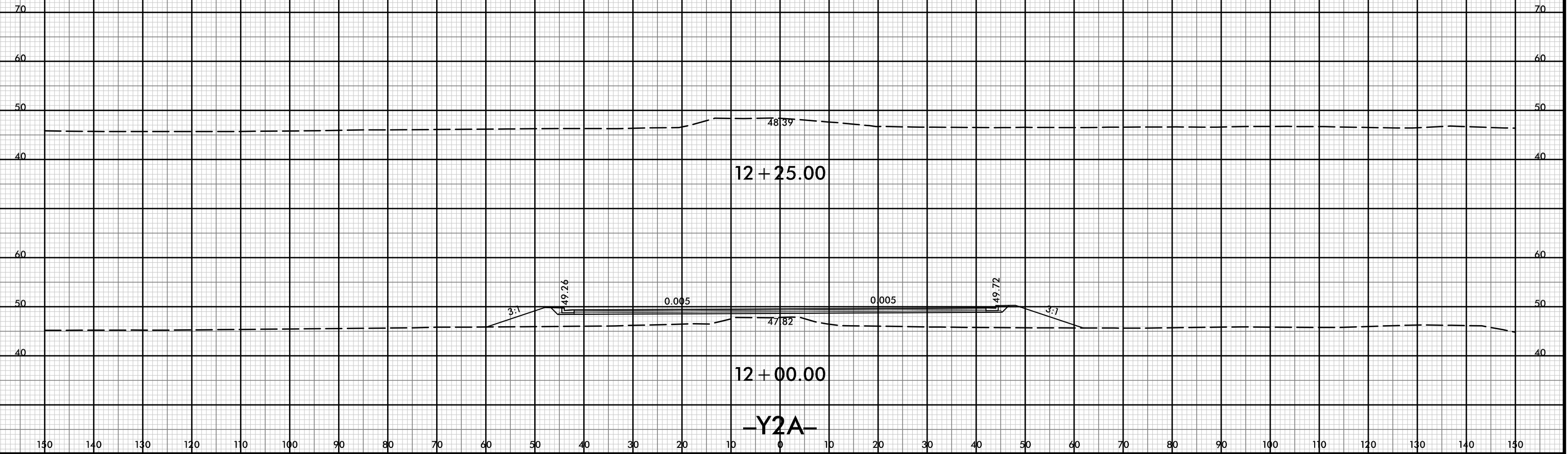

21-Jul-2021 10:38
 R:\p\dawej\XSCA\5021-rdy-yp1-Y2A.dgn
 HNTB



150 140 130 120 110 100 90 80 70 60 50 40 30 20 10 0 10 20 30 40 50 60 70 80 90 100 110 120 130 140 150

60 60

50 50

40 40

0.010 45.61 0.010

10 + 00.00

60 60

50 50

40 40

45.57

9 + 75.00

60 60

50 50

40 40

45.81

9 + 50.00

60 60

50 50

40 40

45.47

9 + 25.00

-Y3-

150 140 130 120 110 100 90 80 70 60 50 40 30 20 10 0 10 20 30 40 50 60 70 80 90 100 110 120 130 140 150

150 140 130 120 110 100 90 80 70 60 50 40 30 20 10 0 10 20 30 40 50 60 70 80 90 100 110 120 130 140 150

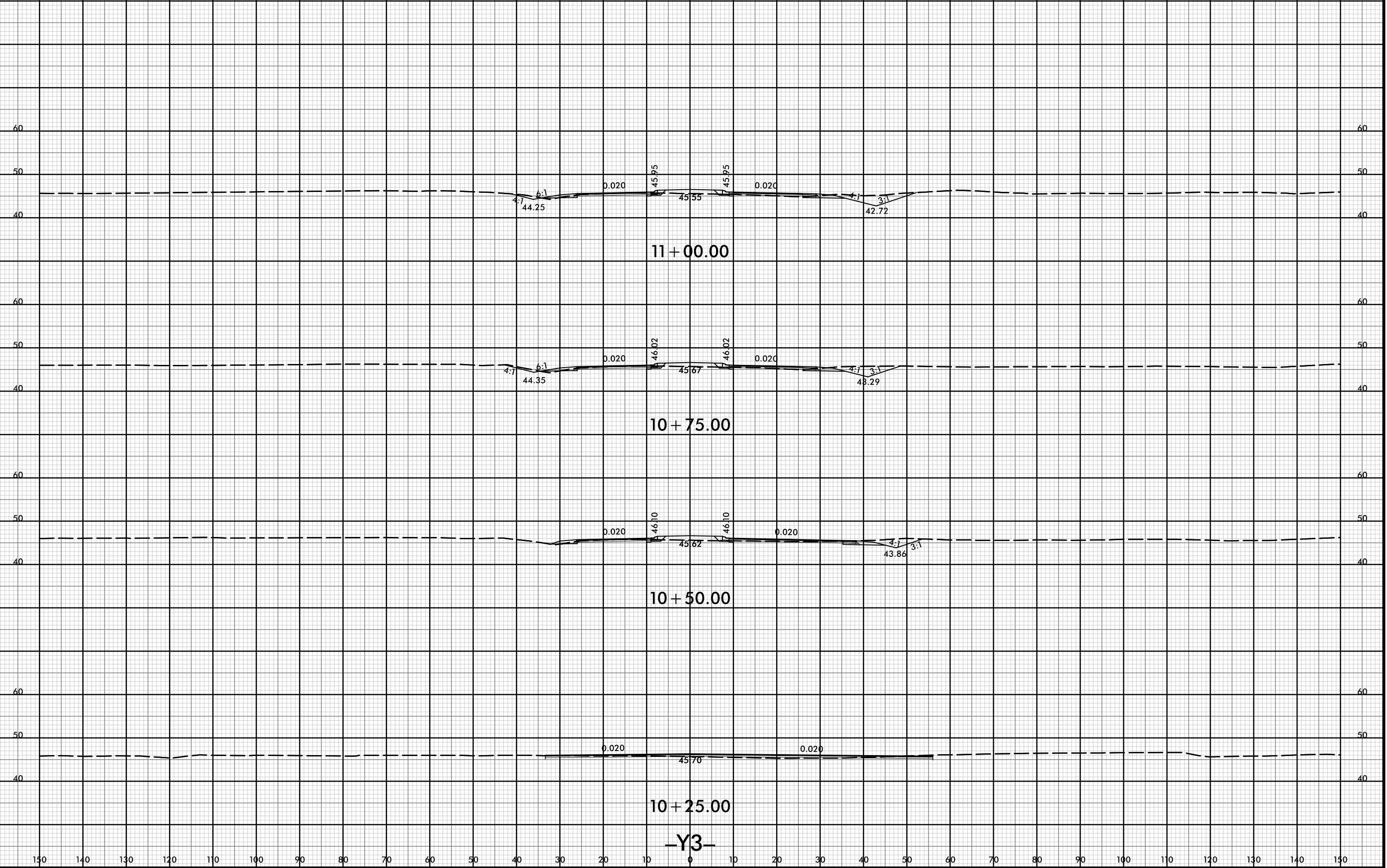

11+00.00

10+75.00

10+50.00

10+25.00

-Y3-



150 140 130 120 110 100 90 80 70 60 50 40 30 20 10 0 10 20 30 40 50 60 70 80 90 100 110 120 130 140 150

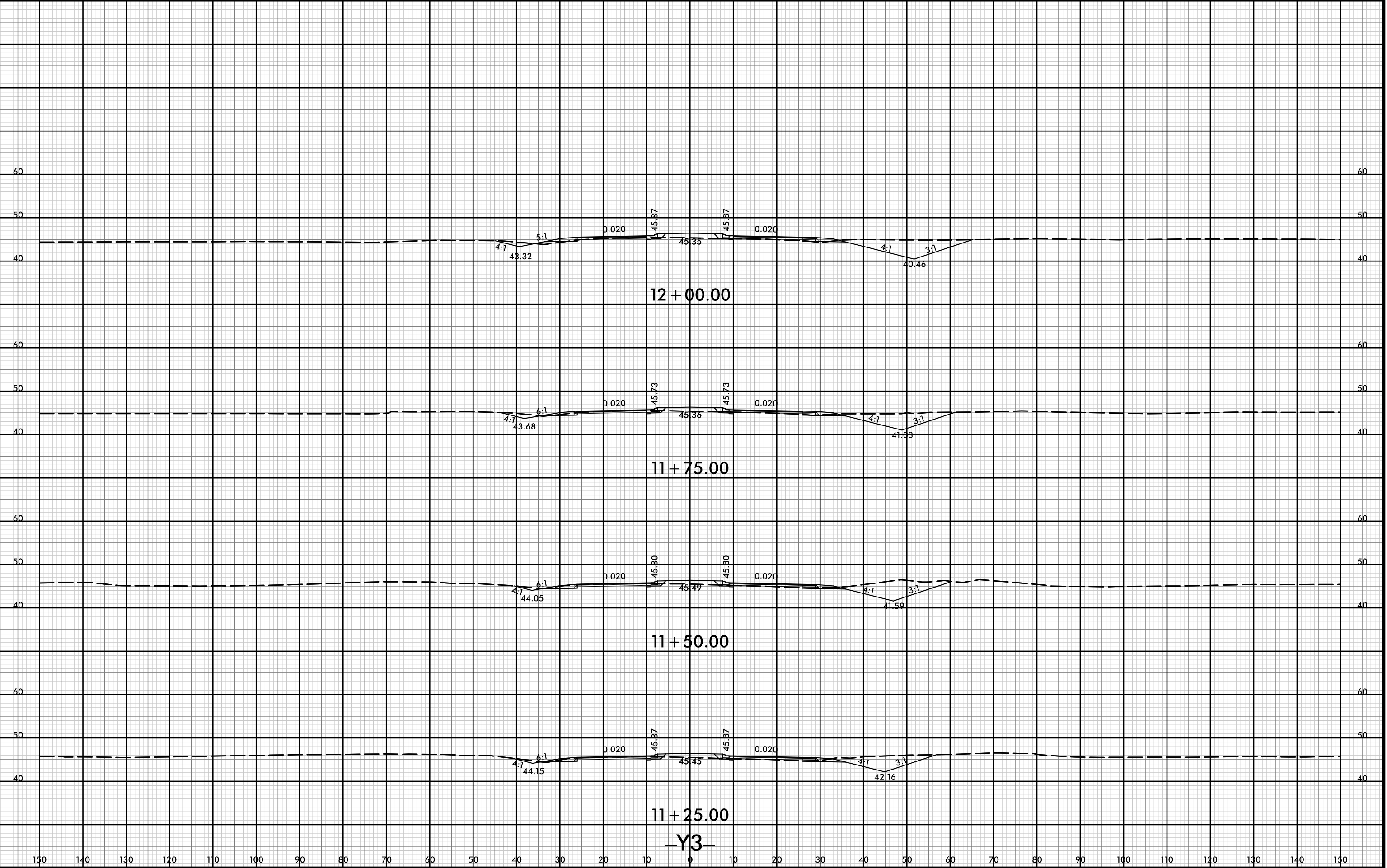

12 + 00.00

11 + 75.00

11 + 50.00

11 + 25.00

-Y3-



150 140 130 120 110 100 90 80 70 60 50 40 30 20 10 0 10 20 30 40 50 60 70 80 90 100 110 120 130 140 150

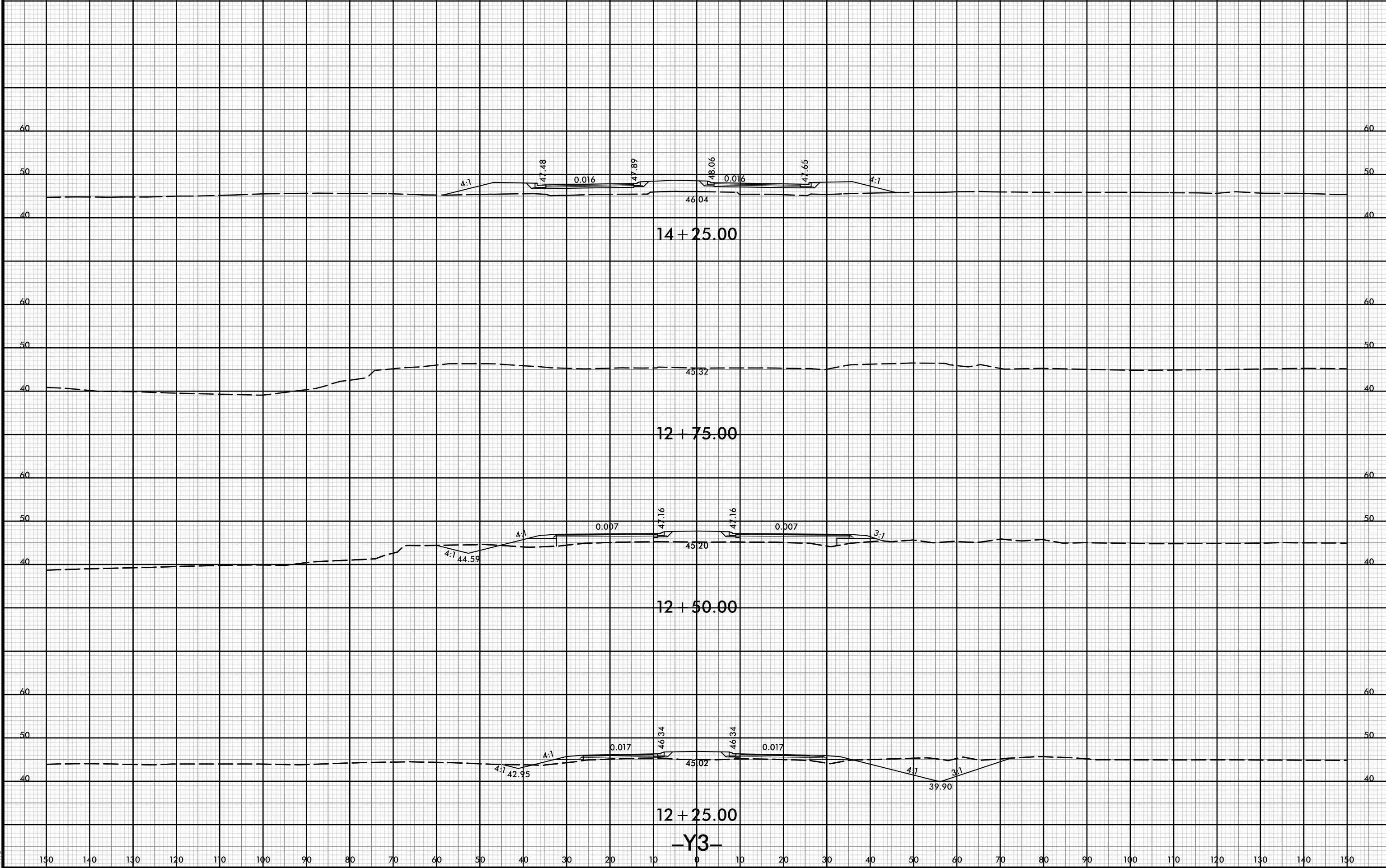

14 + 25.00

12 + 75.00

12 + 50.00

12 + 25.00

-Y3-

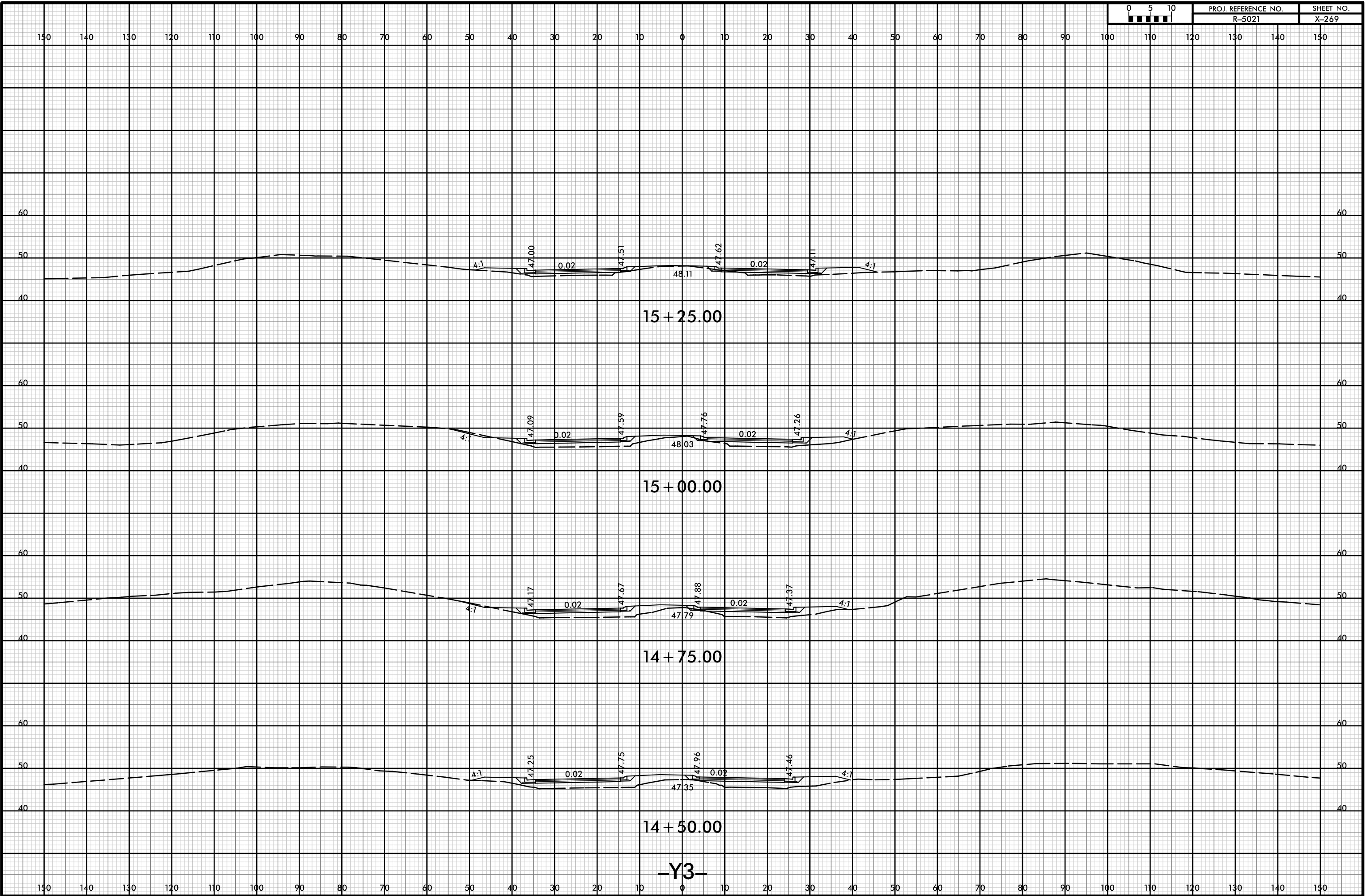

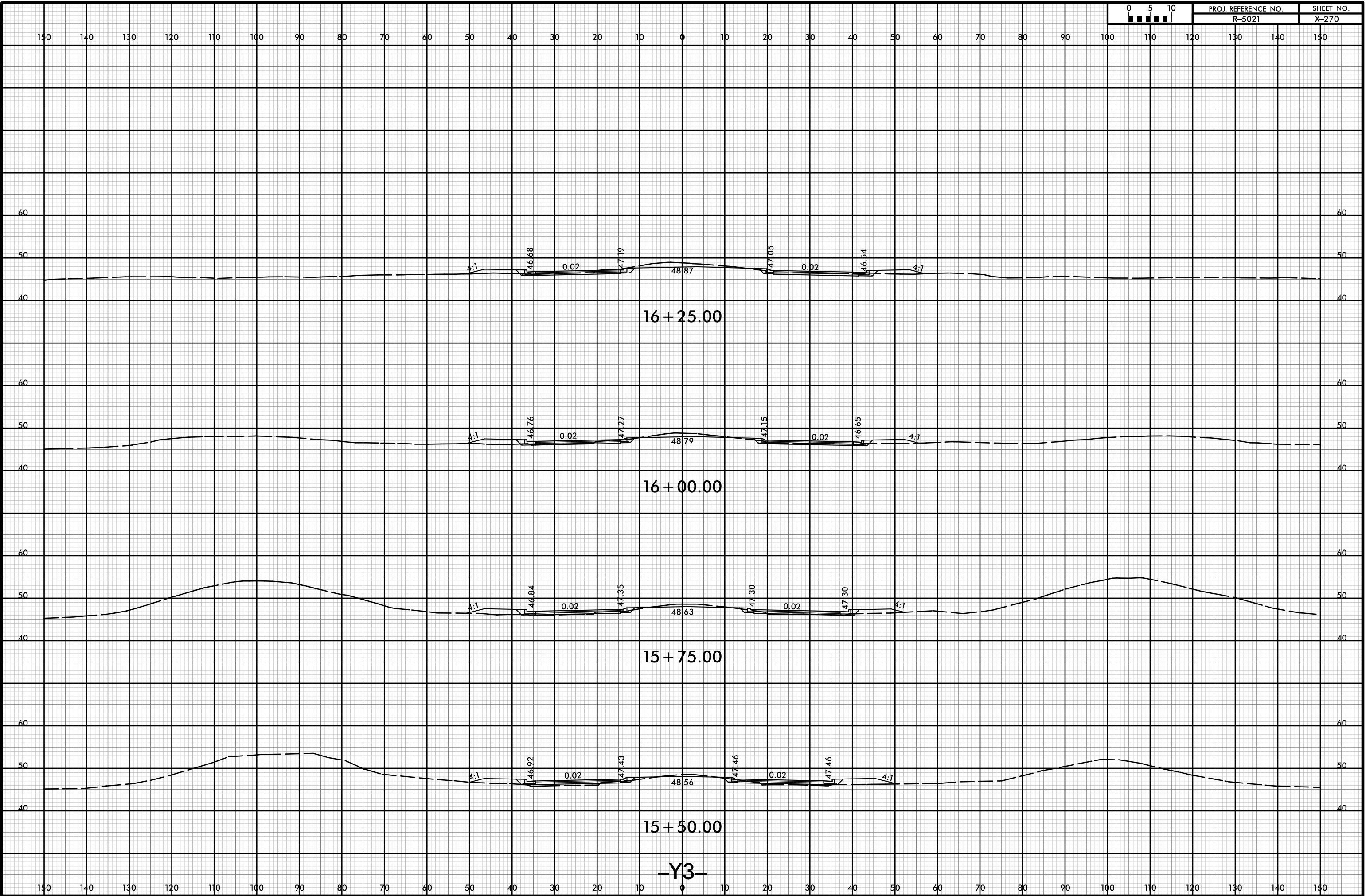

150 140 130 120 110 100 90 80 70 60 50 40 30 20 10 0 10 20 30 40 50 60 70 80 90 100 110 120 130 140 150

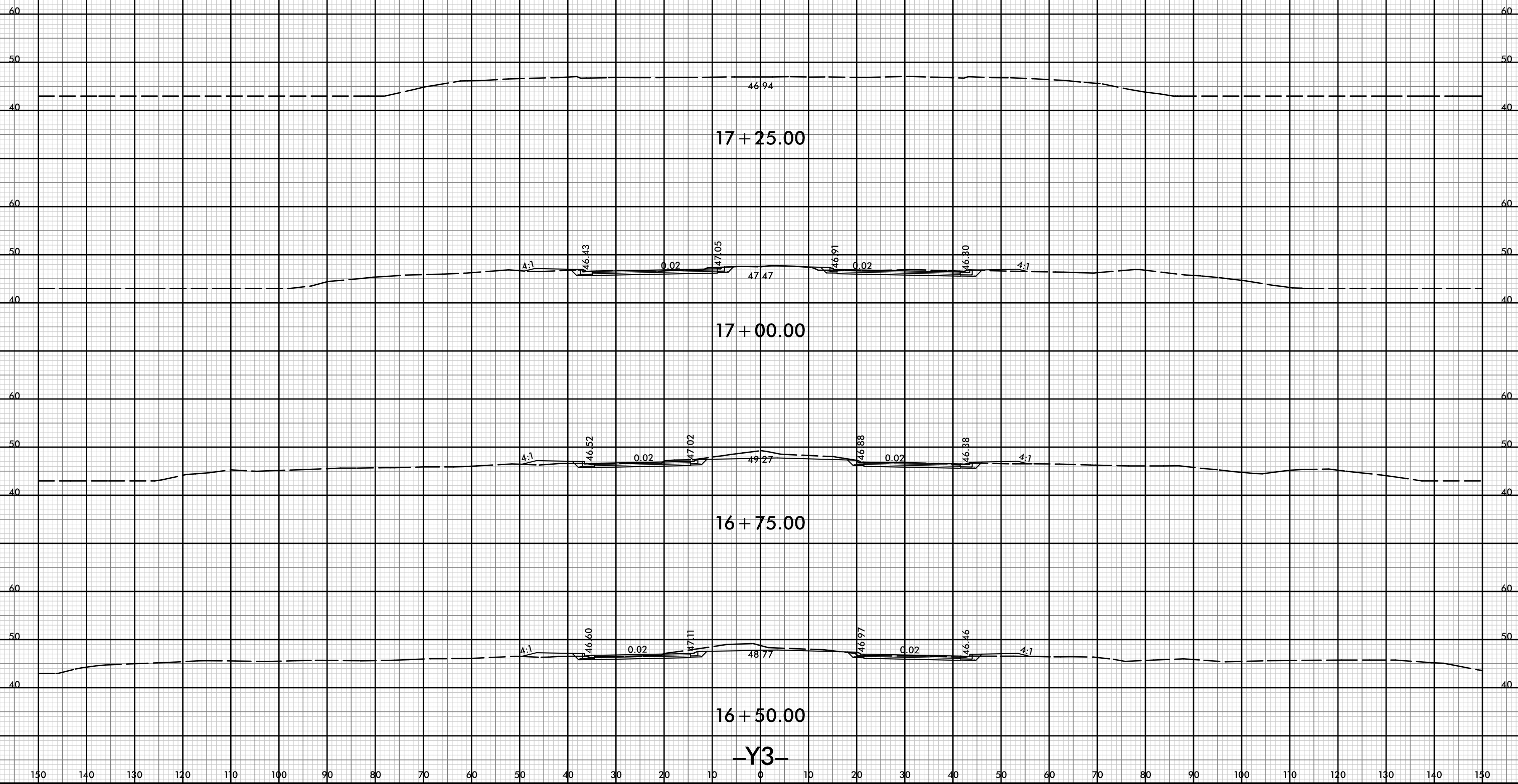

-Y3-



150 140 130 120 110 100 90 80 70 60 50 40 30 20 10 0 10 20 30 40 50 60 70 80 90 100 110 120 130 140 150

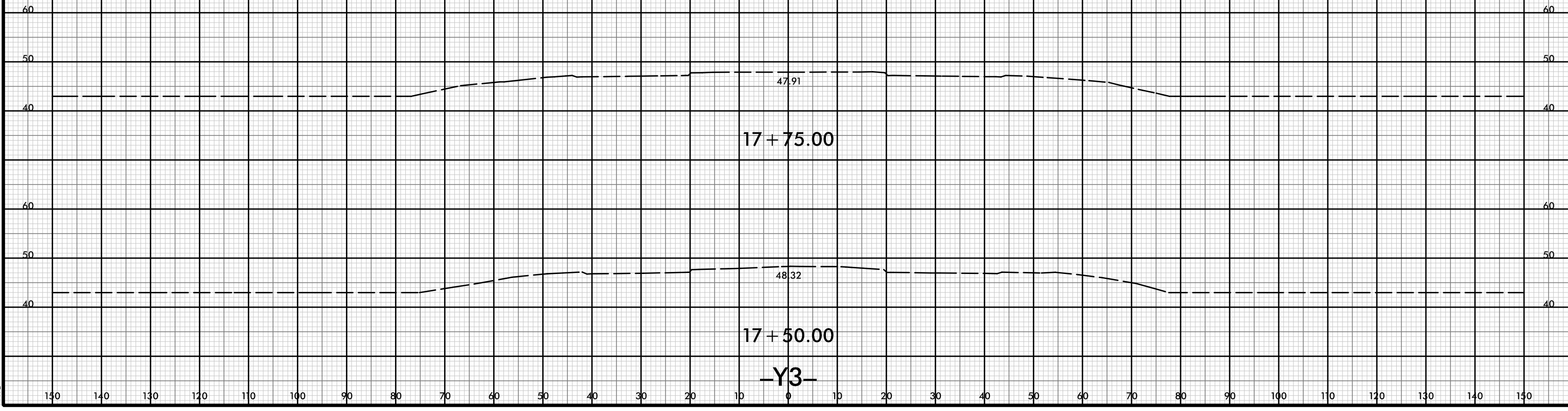

150 140 130 120 110 100 90 80 70 60 50 40 30 20 10 0 10 20 30 40 50 60 70 80 90 100 110 120 130 140 150

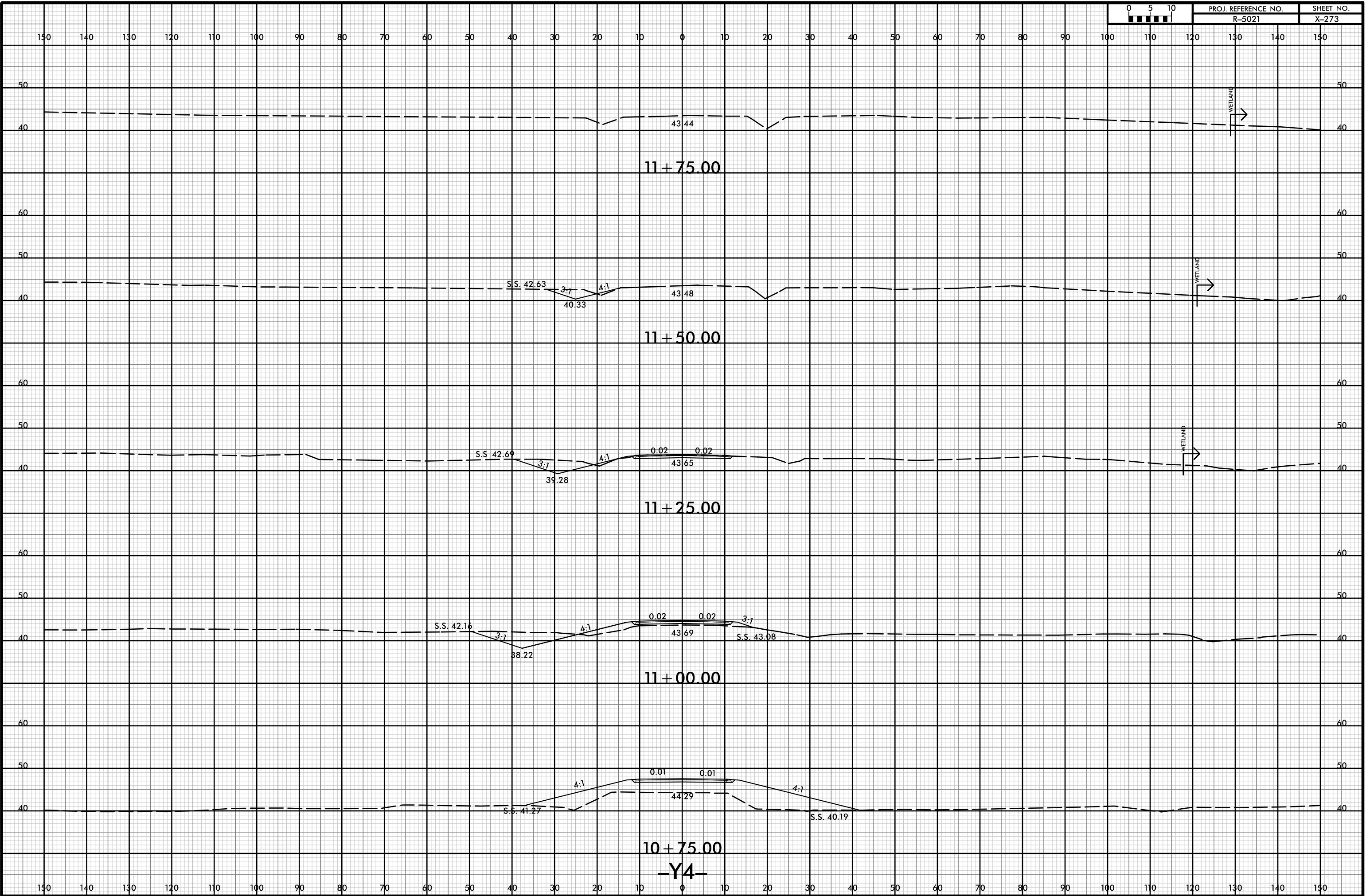



150 140 130 120 110 100 90 80 70 60 50 40 30 20 10 0 10 20 30 40 50 60 70 80 90 100 110 120 130 140 150

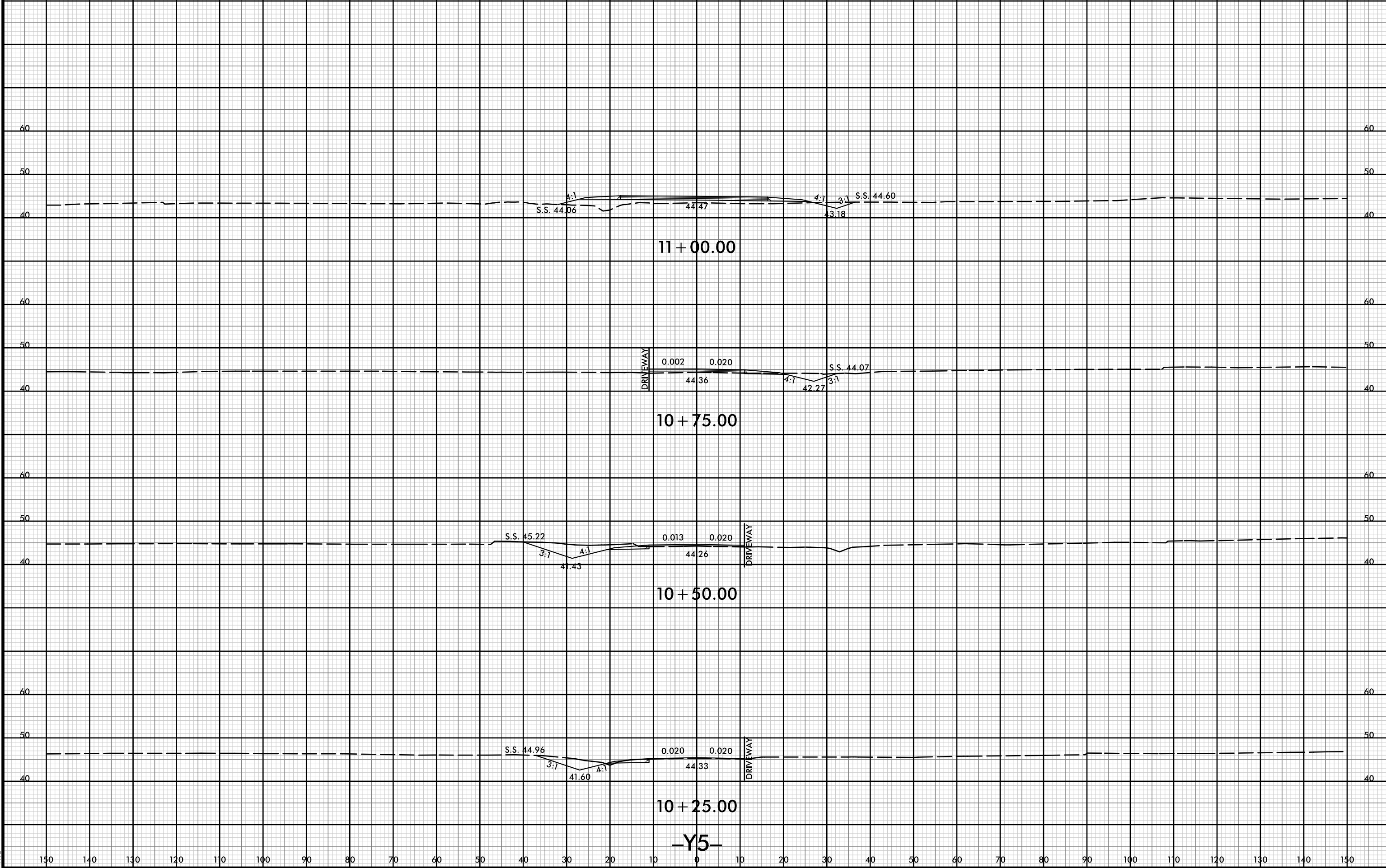

150 140 130 120 110 100 90 80 70 60 50 40 30 20 10 0 10 20 30 40 50 60 70 80 90 100 110 120 130 140 150

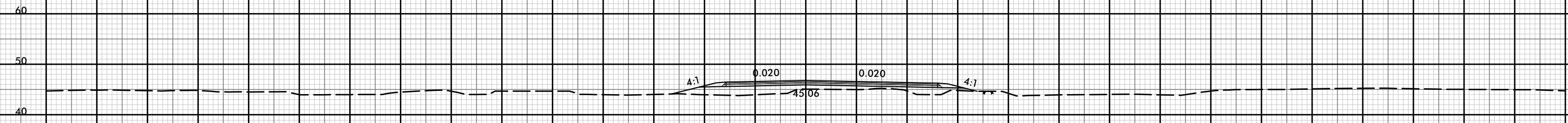

10 + 75.00

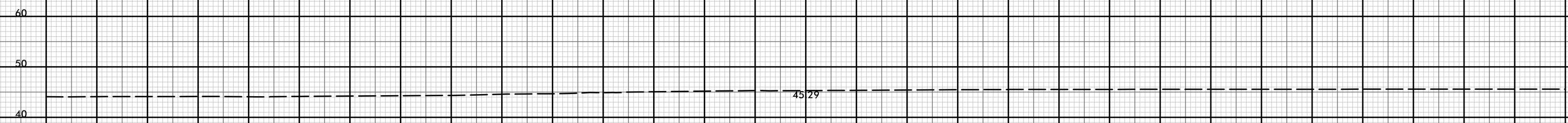

10 + 50.00

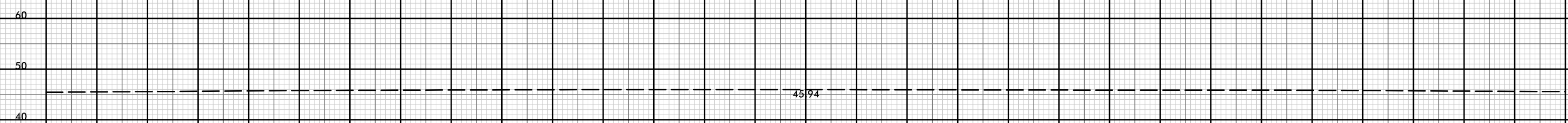

10 + 25.00

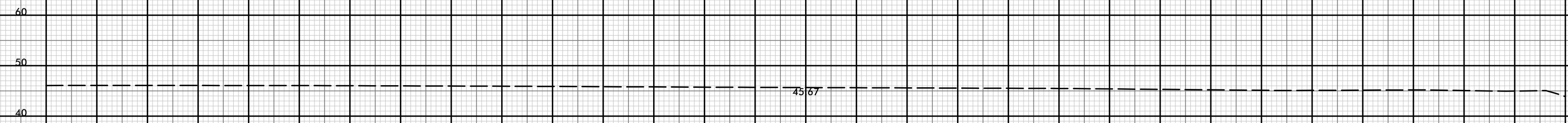

10 + 00.00

-Y5A-

150 140 130 120 110 100 90 80 70 60 50 40 30 20 10 0 10 20 30 40 50 60 70 80 90 100 110 120 130 140 150

8/23/99



PROJ. REFERENCE NO.
R-5021

SHEET NO.
X-276

150 140 130 120 110 100 90 80 70 60 50 40 30 20 10 0 10 20 30 40 50 60 70 80 90 100 110 120 130 140 150

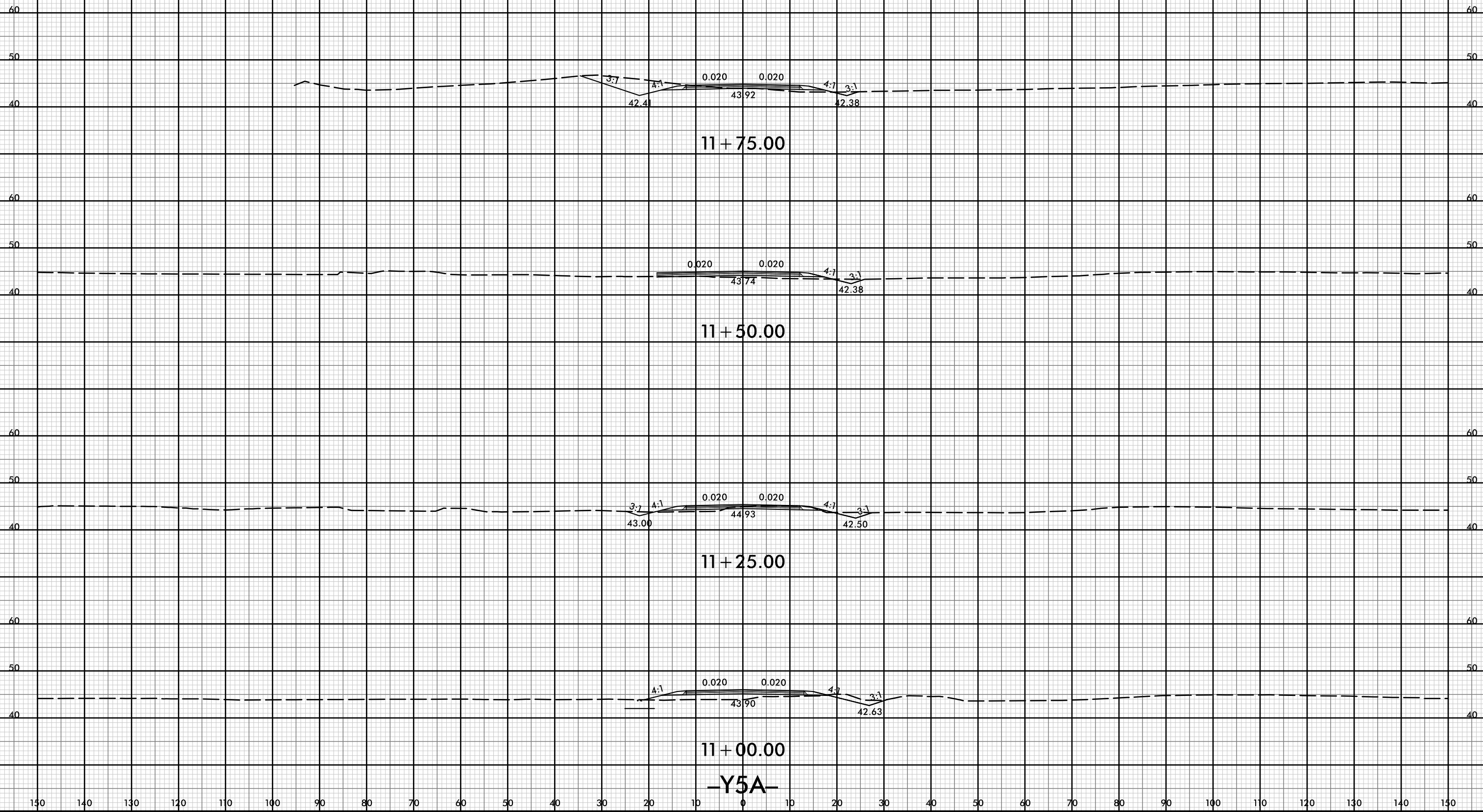

-Y5A-

21-JUL-2021 10:38
P:\Roadway\XSCA\5021-rdy-xl-Y5A.dgn
HTB

8/23/99



PROJ. REFERENCE NO.
R-5021

SHEET NO.
X-277

150 140 130 120 110 100 90 80 70 60 50 40 30 20 10 0 10 20 30 40 50 60 70 80 90 100 110 120 130 140 150

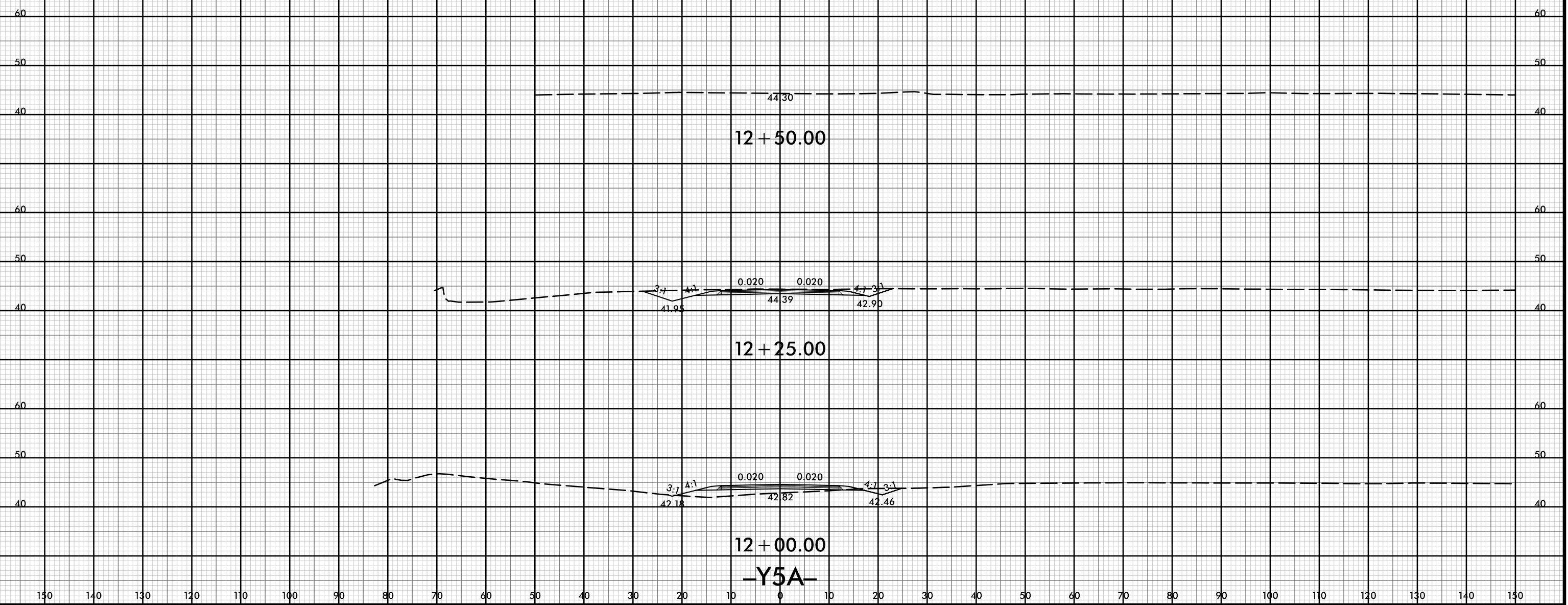

21-Jul-2021 10:38
R:\pawej\XSCA\5021-rdy-xl-Y5A.dgn
HTB

150 140 130 120 110 100 90 80 70 60 50 40 30 20 10 0 10 20 30 40 50 60 70 80 90 100 110 120 130 140 150

8/23/99



PROJ. REFERENCE NO.
R-5021

SHEET NO.
X-278

150 140 130 120 110 100 90 80 70 60 50 40 30 20 10 0 10 20 30 40 50 60 70 80 90 100 110 120 130 140 150

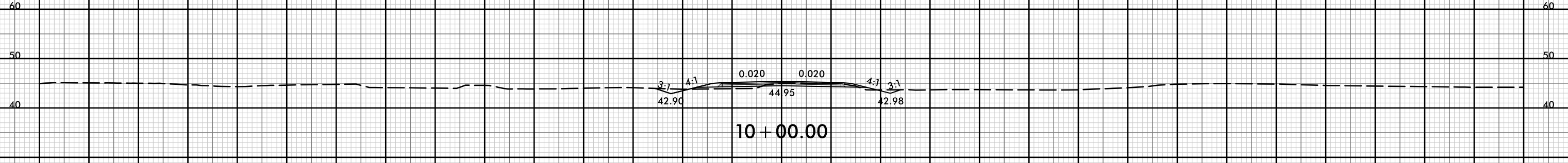
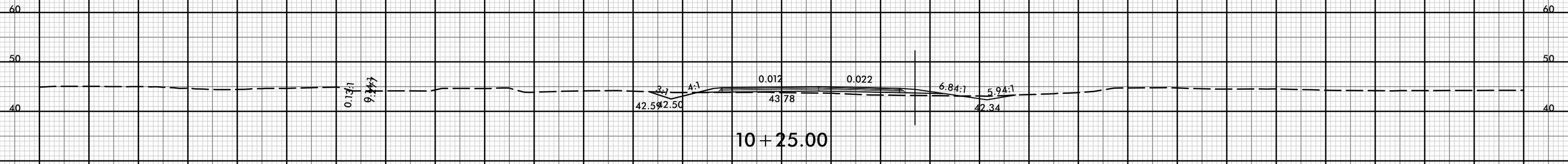
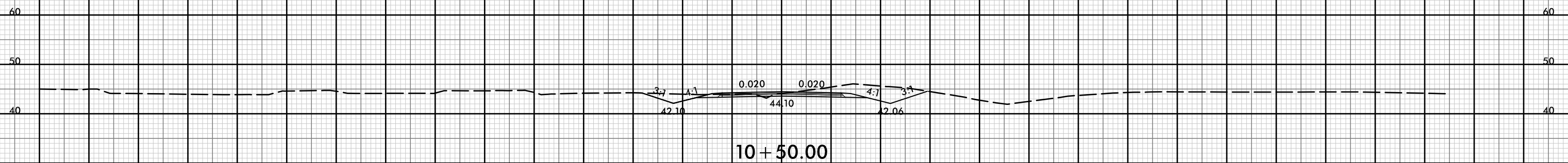
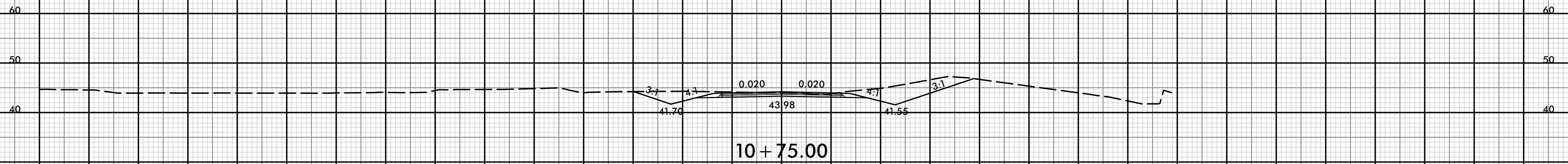

-Y5B-

150 140 130 120 110 100 90 80 70 60 50 40 30 20 10 0 10 20 30 40 50 60 70 80 90 100 110 120 130 140 150

P:\JUL-2021\03-38
R\p\dwg\XSC\5021-rdy-yp-l-Y5B.dgn
HTB

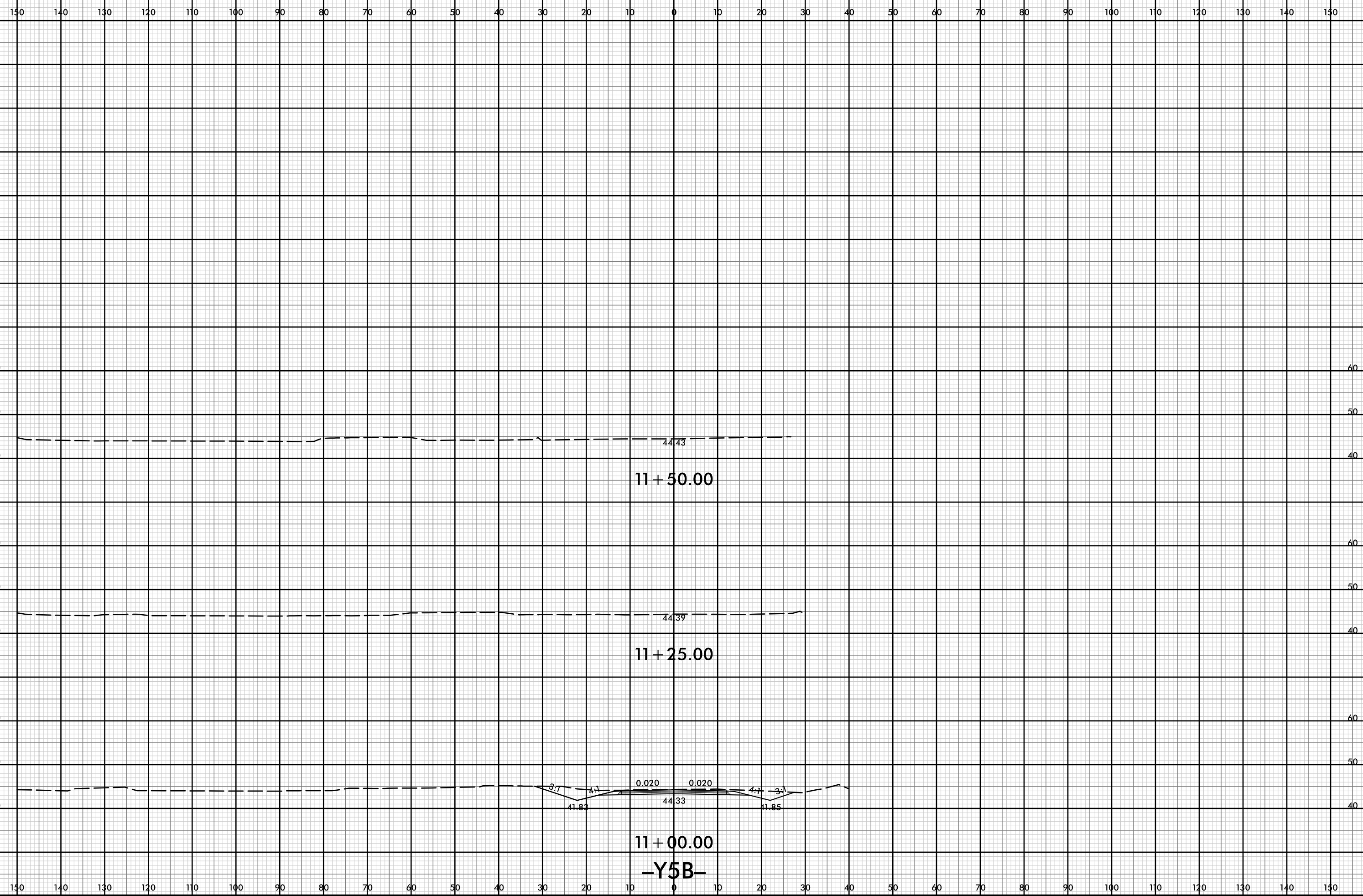

8/23/99

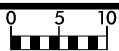

PROJ. REFERENCE NO.
R-5021

SHEET NO.
X-280

150 140 130 120 110 100 90 80 70 60 50 40 30 20 10 0 10 20 30 40 50 60 70 80 90 100 110 120 130 140 150

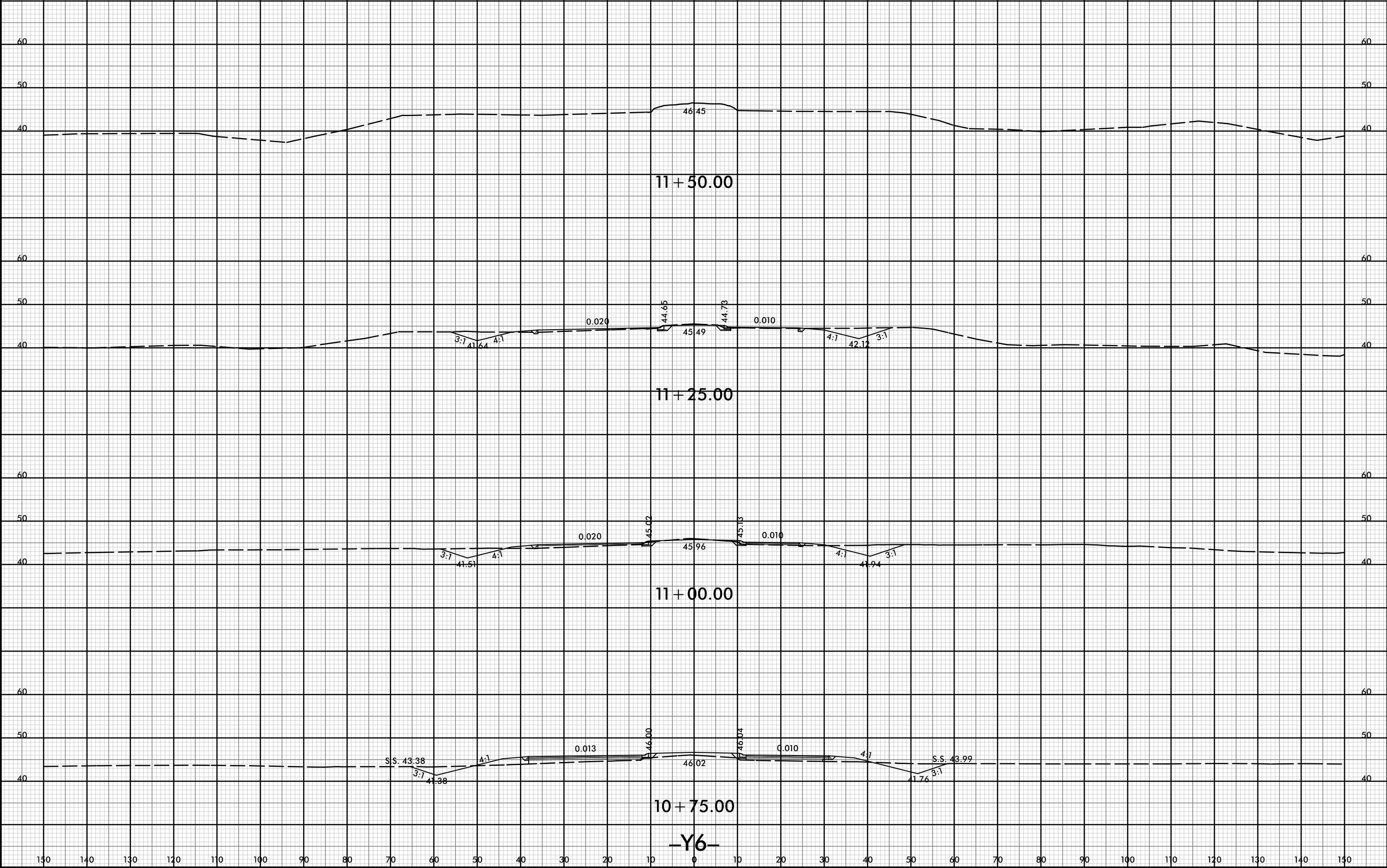

11+00.00

11+25.00

11+50.00

10+75.00

-Y6-

21-Jul-2021 10:38
R:\cdawej\XSC\5021-rdy-xl-Y6.dgn
HTB



150 140 130 120 110 100 90 80 70 60 50 40 30 20 10 0 10 20 30 40 50 60 70 80 90 100 110 120 130 140 150

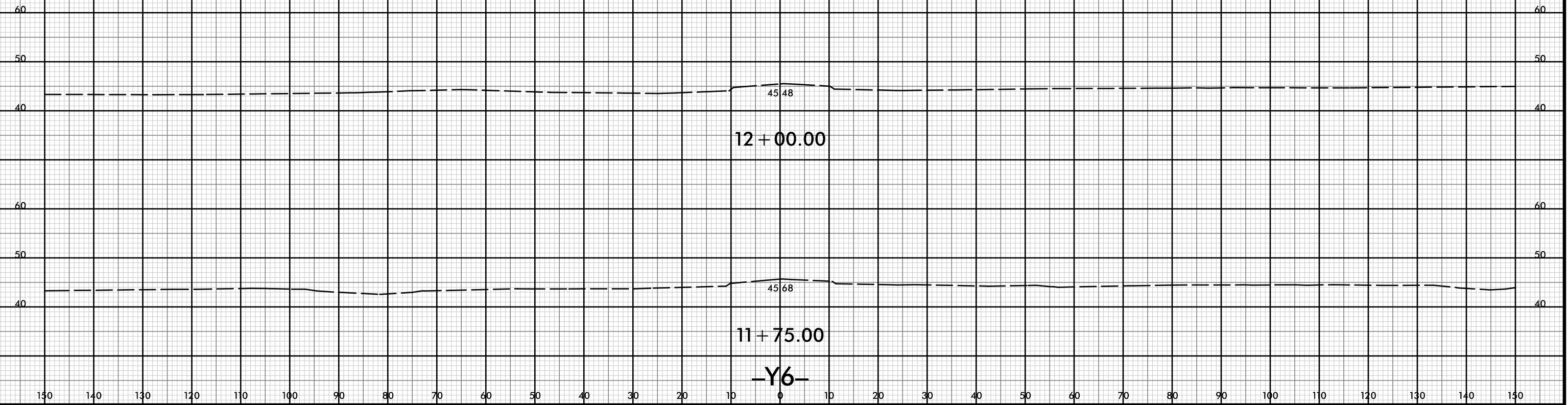



150 140 130 120 110 100 90 80 70 60 50 40 30 20 10 0 10 20 30 40 50 60 70 80 90 100 110 120 130 140 150

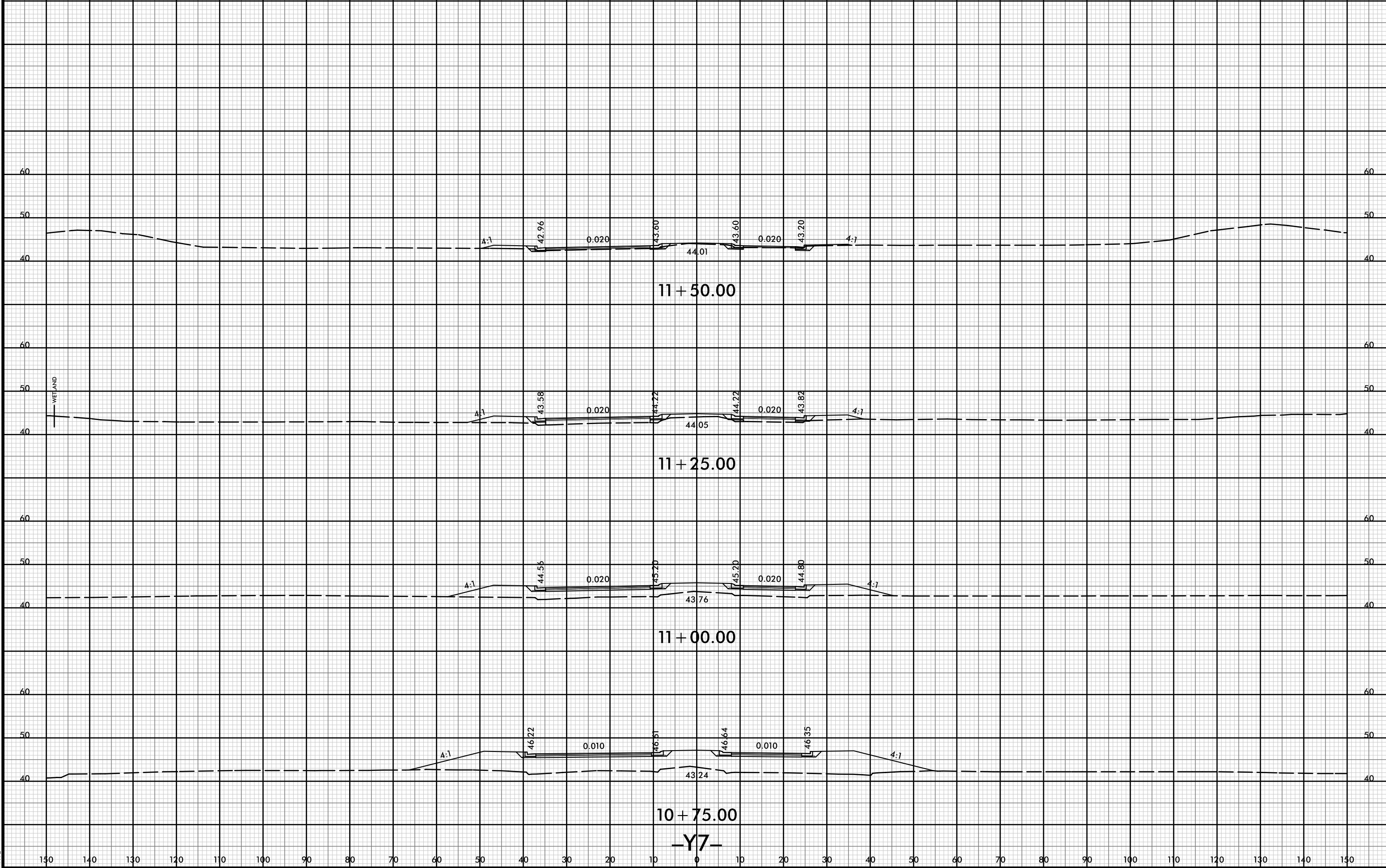

11 + 50.00

11 + 25.00

11 + 00.00

10 + 75.00

-Y7-

WETLAND



150 140 130 120 110 100 90 80 70 60 50 40 30 20 10 0 10 20 30 40 50 60 70 80 90 100 110 120 130 140 150

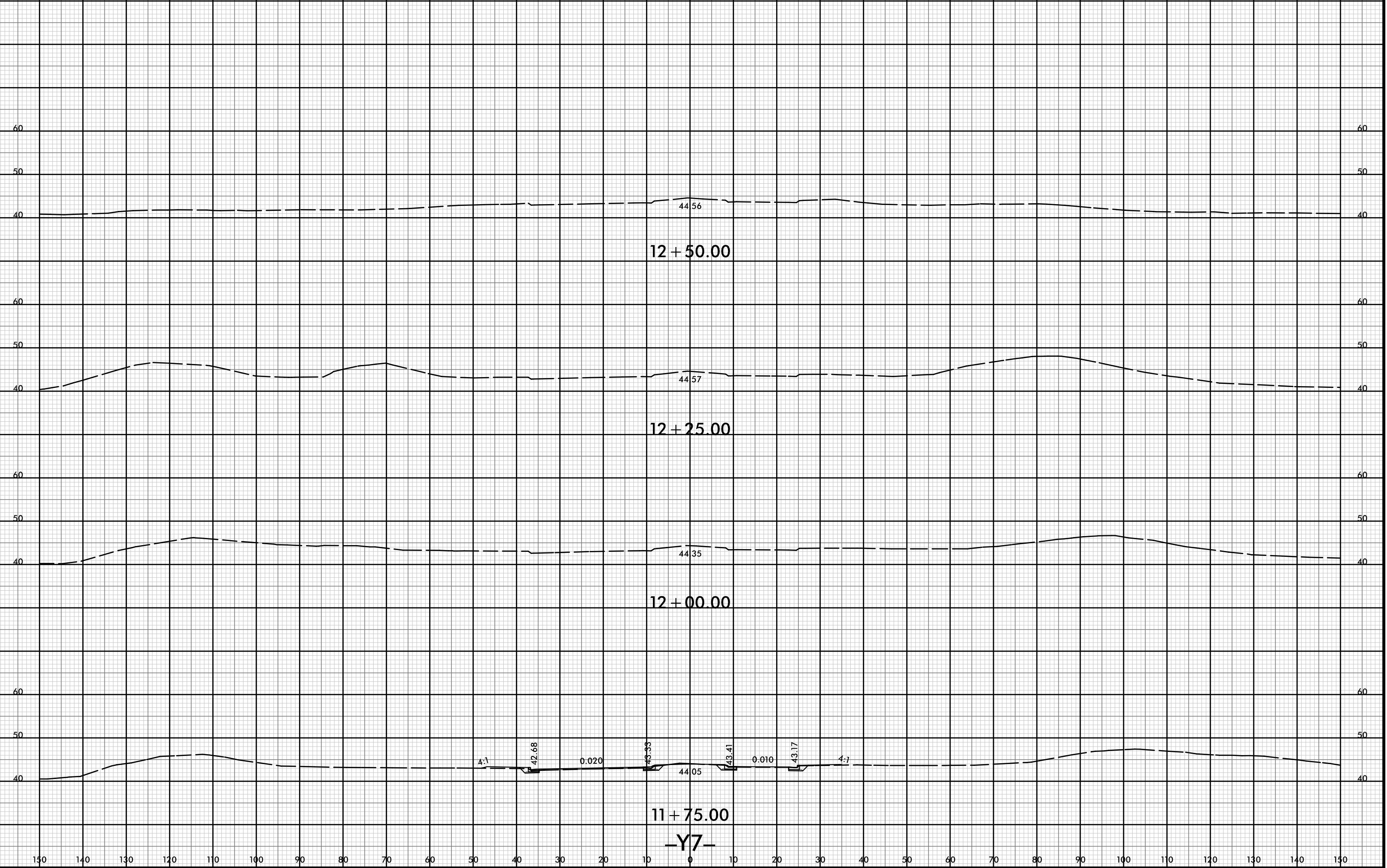

12 + 50.00

12 + 25.00

12 + 00.00

11 + 75.00

-Y7-

150 140 130 120 110 100 90 80 70 60 50 40 30 20 10 0 10 20 30 40 50 60 70 80 90 100 110 120 130 140 150

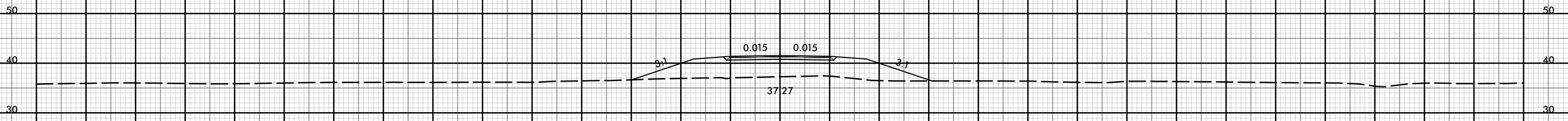

10 + 75.00

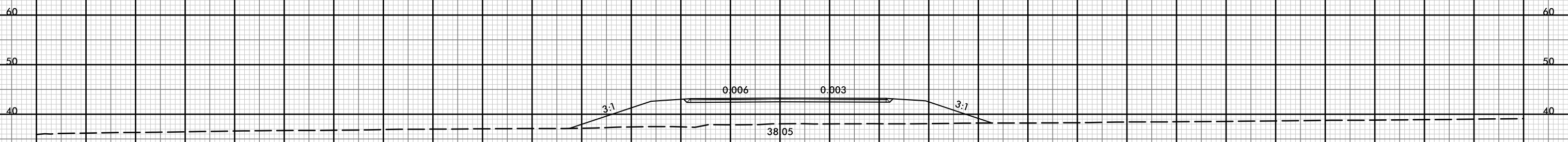

10 + 50.00

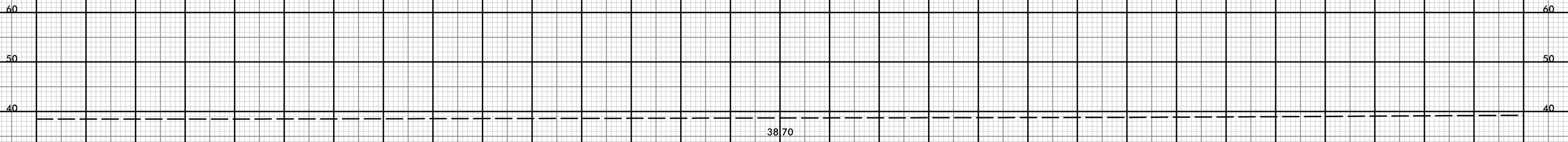

10 + 25.00

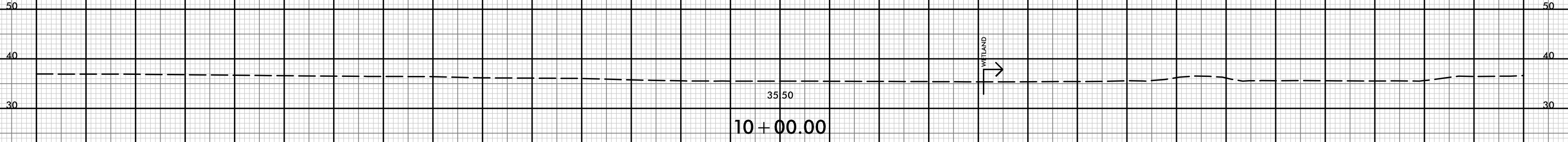

10 + 00.00

-Y8-

8/23/99



PROJ. REFERENCE NO.
R-5021

SHEET NO.
X-285

150 140 130 120 110 100 90 80 70 60 50 40 30 20 10 0 10 20 30 40 50 60 70 80 90 100 110 120 130 140 150

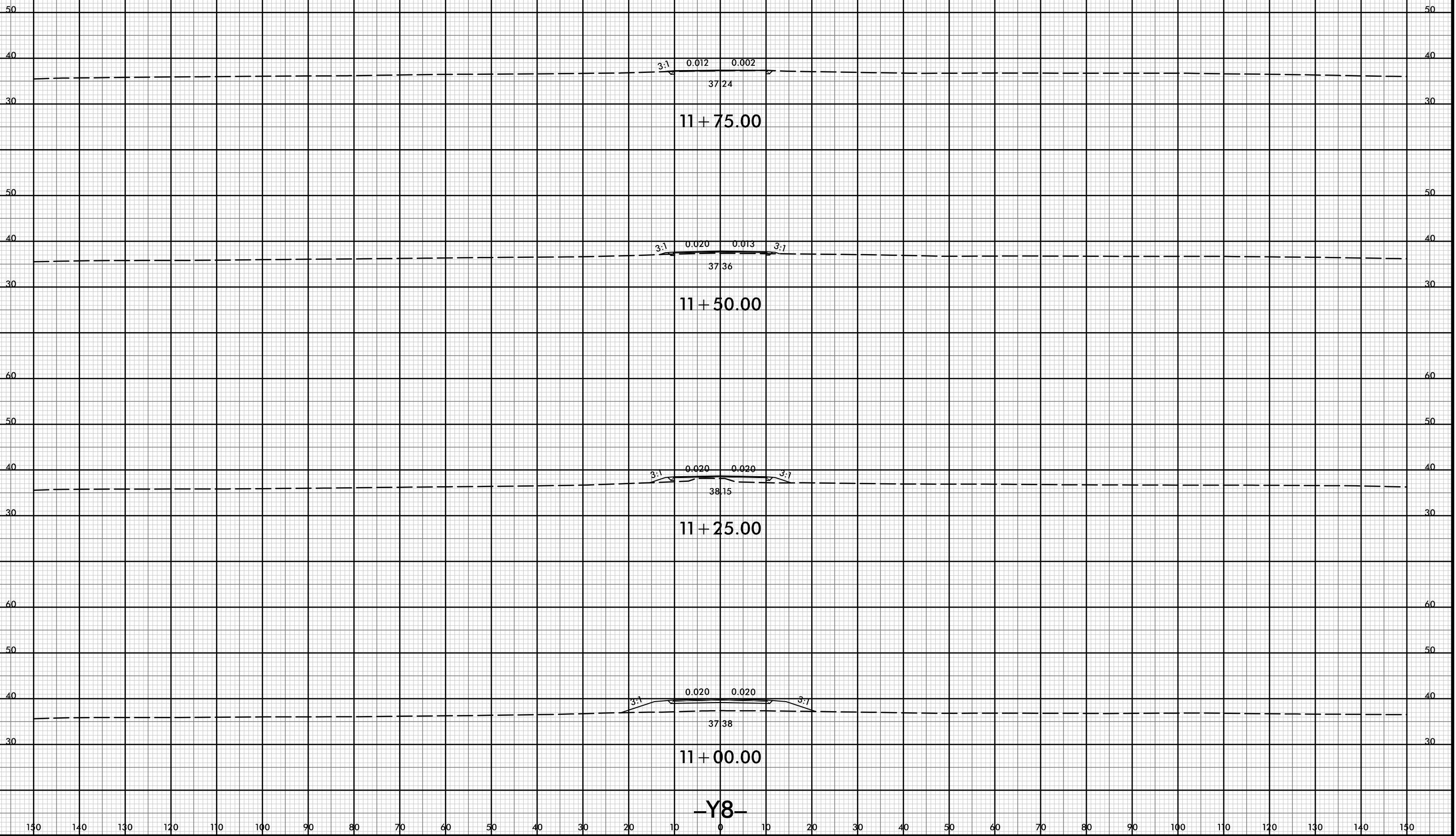

21-Jul-2021 10:38
R:\p\dawej\XSCA\5021-rdy-yp1-y8.dgn
HTB



150 140 130 120 110 100 90 80 70 60 50 40 30 20 10 0 10 20 30 40 50 60 70 80 90 100 110 120 130 140 150

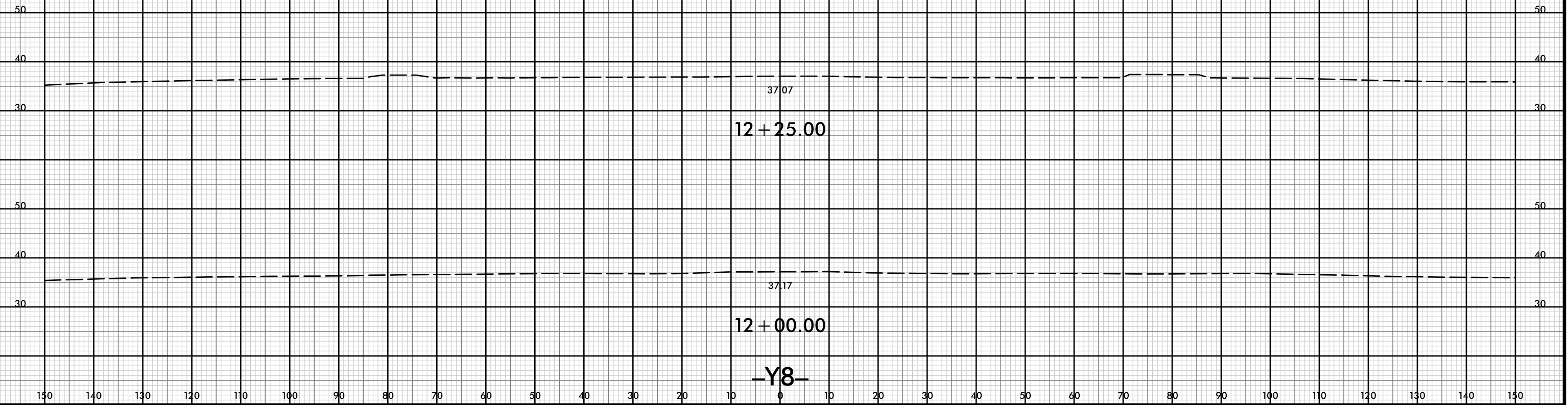

150 140 130 120 110 100 90 80 70 60 50 40 30 20 10 0 10 20 30 40 50 60 70 80 90 100 110 120 130 140 150



150 140 130 120 110 100 90 80 70 60 50 40 30 20 10 0 10 20 30 40 50 60 70 80 90 100 110 120 130 140 150

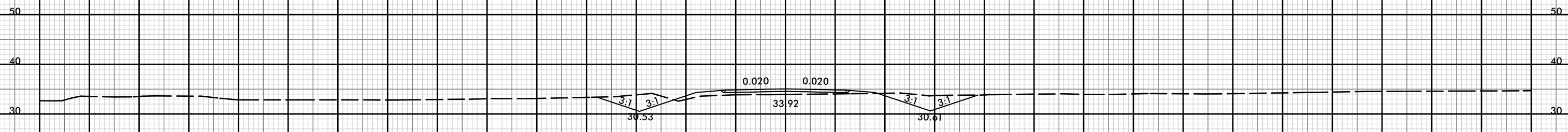

11 + 50.00

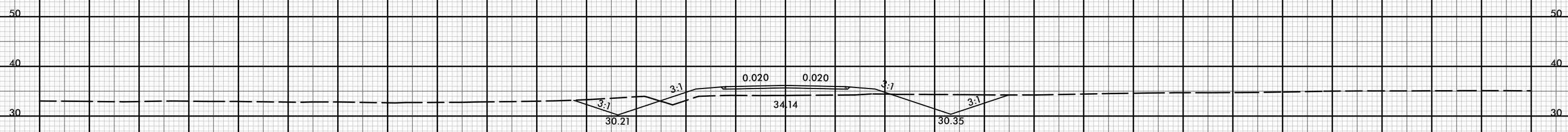

11 + 25.00

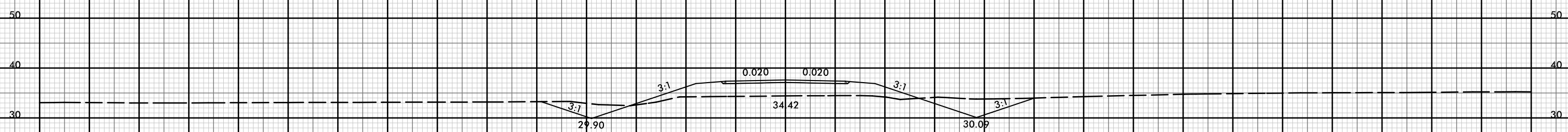

11 + 00.00

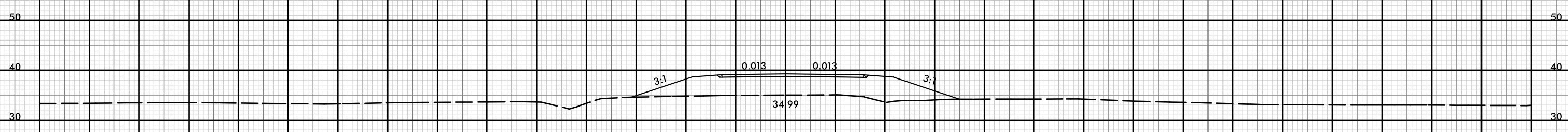

10 + 75.00

-Y9-

150 140 130 120 110 100 90 80 70 60 50 40 30 20 10 0 10 20 30 40 50 60 70 80 90 100 110 120 130 140 150



150 140 130 120 110 100 90 80 70 60 50 40 30 20 10 0 10 20 30 40 50 60 70 80 90 100 110 120 130 140 150

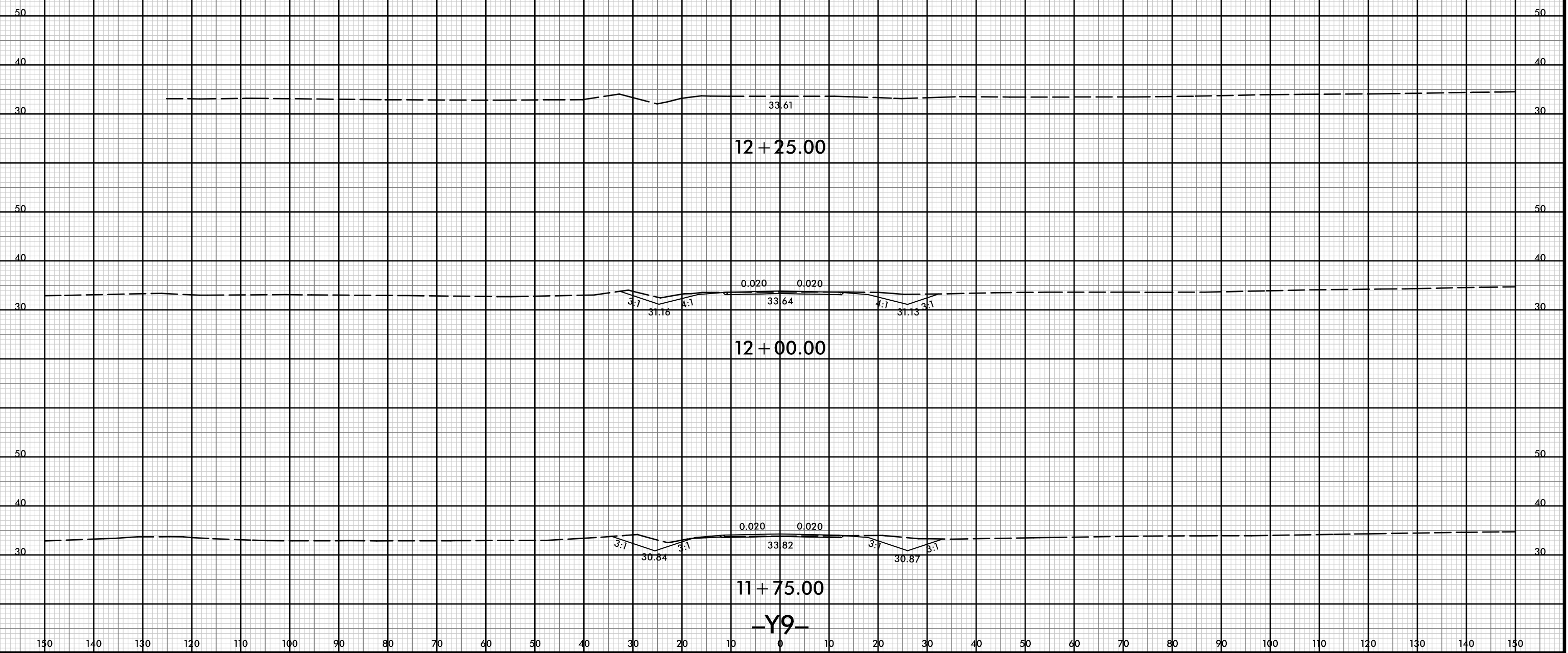



150 140 130 120 110 100 90 80 70 60 50 40 30 20 10 0 10 20 30 40 50 60 70 80 90 100 110 120 130 140 150

50 50

40 40

30 30

10 + 75.00

50 50

40 40

30 30

10 + 50.00

50 50

40 40

30 30

10 + 25.00

50 50

40 40

30 30

10 + 00.00

-Y9A-

150 140 130 120 110 100 90 80 70 60 50 40 30 20 10 0 10 20 30 40 50 60 70 80 90 100 110 120 130 140 150

8/23/99



PROJ. REFERENCE NO.
R-5021

SHEET NO.
X-290

150 140 130 120 110 100 90 80 70 60 50 40 30 20 10 0 10 20 30 40 50 60 70 80 90 100 110 120 130 140 150

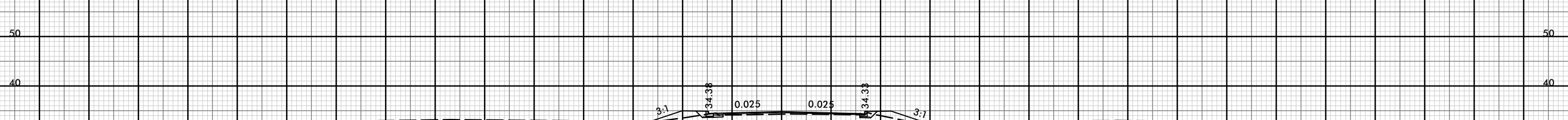
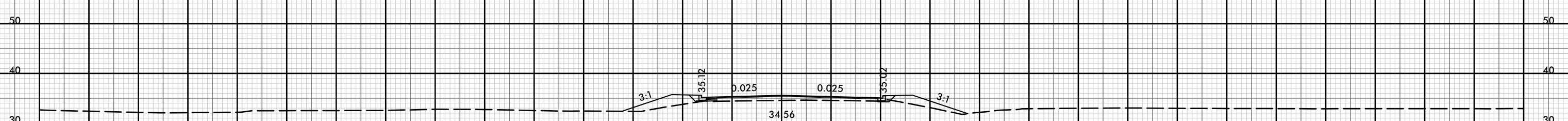
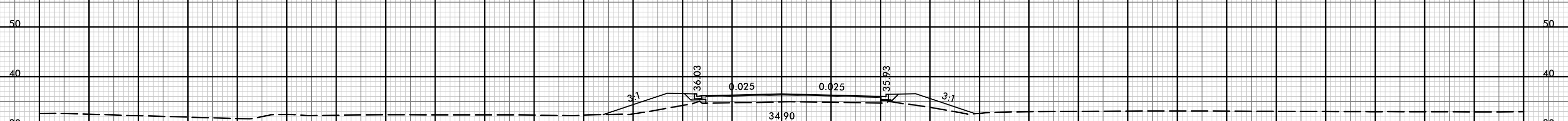
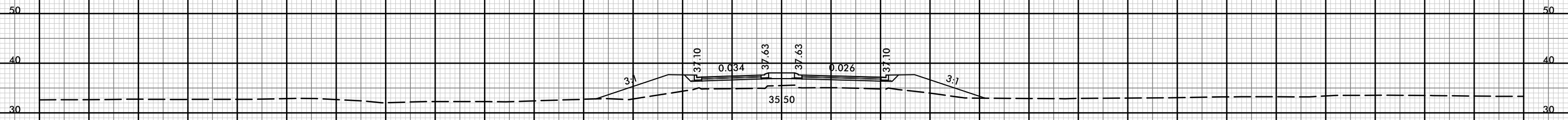

11+00.00

-Y9A-

150 140 130 120 110 100 90 80 70 60 50 40 30 20 10 0 10 20 30 40 50 60 70 80 90 100 110 120 130 140 150

21-Jul-2021 10:38
R:\p\dawej\XSCA\5021-rdy-1-Y9A.dgn
HTB

8/23/99



PROJ. REFERENCE NO.	SHEET NO.
R-5021	X-291

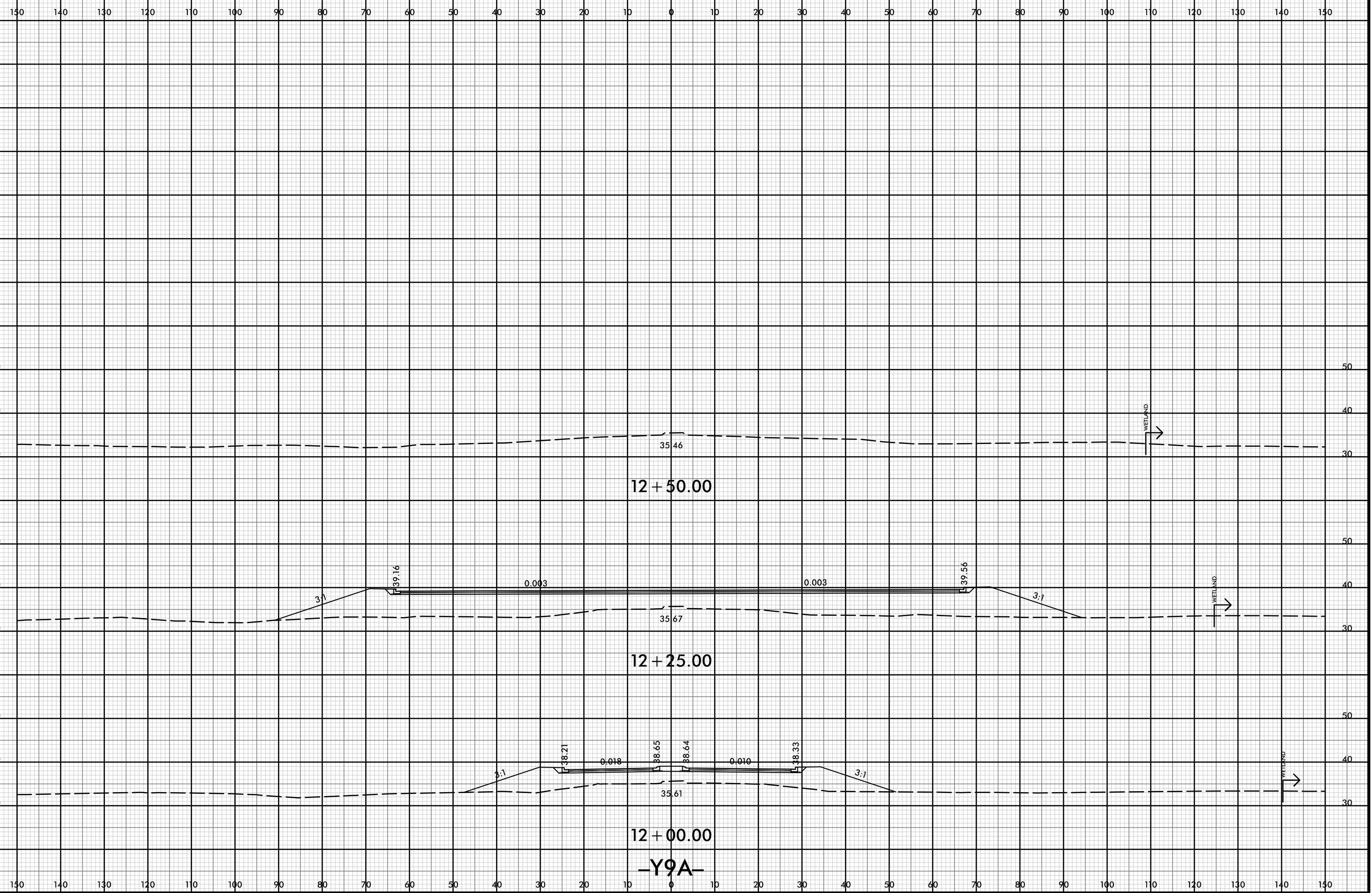

21-Jul-2021 10:38
 R:\p\dawej\XSCA\5021-rdy-xl-Y9A.dgn
 HNTB

150 140 130 120 110 100 90 80 70 60 50 40 30 20 10 0 10 20 30 40 50 60 70 80 90 100 110 120 130 140 150

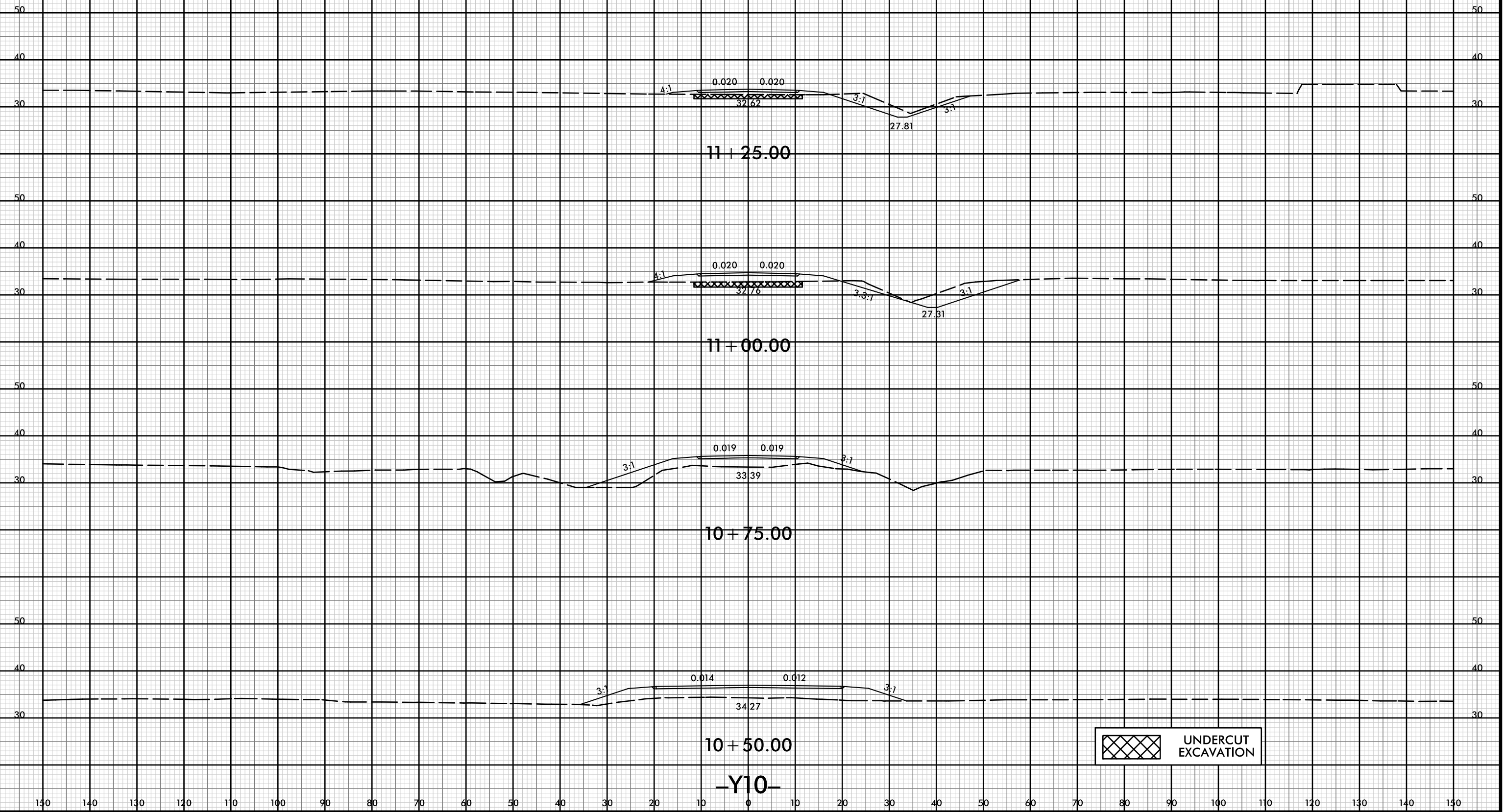

UNDERCUT EXCAVATION

150 140 130 120 110 100 90 80 70 60 50 40 30 20 10 0 10 20 30 40 50 60 70 80 90 100 110 120 130 140 150

8/23/99



PROJ. REFERENCE NO.
R-5021

SHEET NO.
X-293

150 140 130 120 110 100 90 80 70 60 50 40 30 20 10 0 10 20 30 40 50 60 70 80 90 100 110 120 130 140 150

50 50

40 40

30 30

12 + 00.00

50 50

40 40

30 30

11 + 75.00

50 50

40 40

30 30

11 + 50.00

-Y10-

 UNDERCUT EXCAVATION

150 140 130 120 110 100 90 80 70 60 50 40 30 20 10 0 10 20 30 40 50 60 70 80 90 100 110 120 130 140 150

I:\JUL-2001\00-38
 R\Roadway\XSC\5021-rdy-yp-1-Y10.dgn
 HNTB

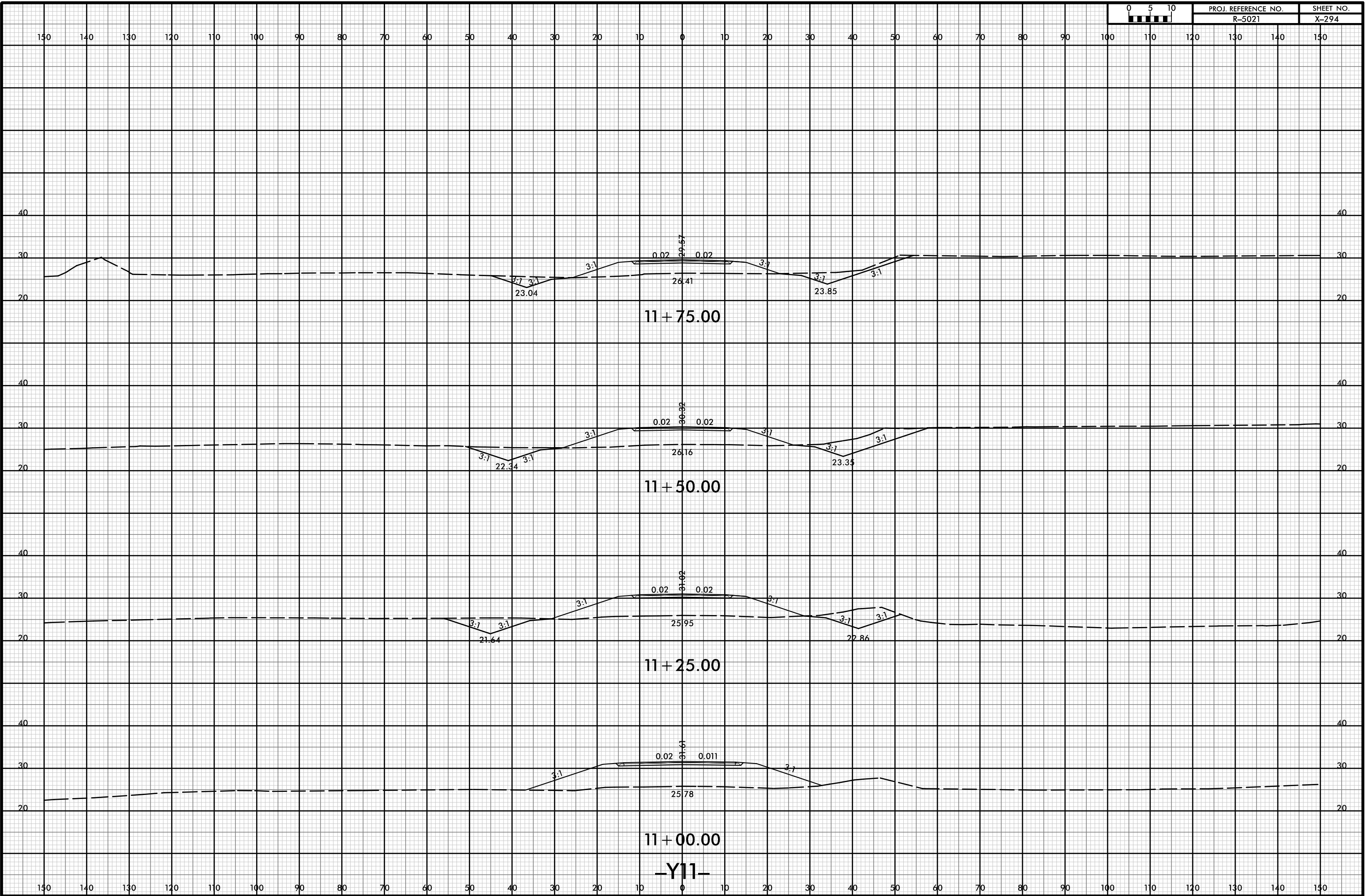

8/23/99



PROJ. REFERENCE NO.
R-5021

SHEET NO.
X-295

150 140 130 120 110 100 90 80 70 60 50 40 30 20 10 0 10 20 30 40 50 60 70 80 90 100 110 120 130 140 150

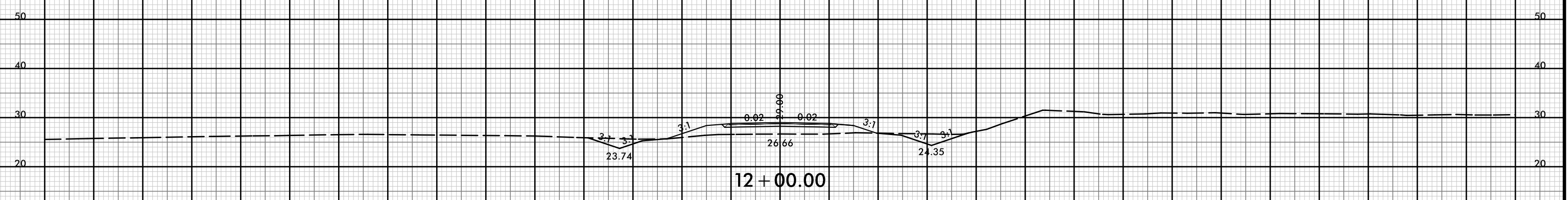
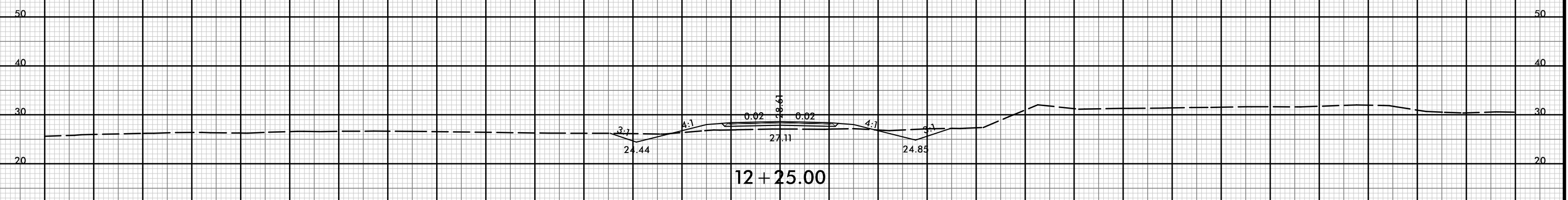
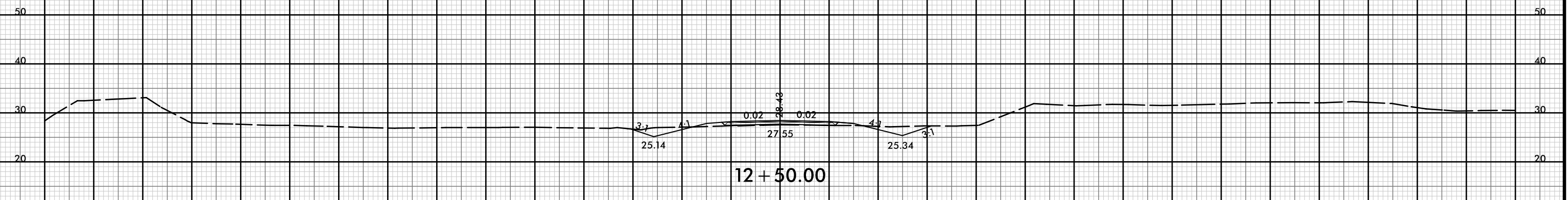

-Y11-

150 140 130 120 110 100 90 80 70 60 50 40 30 20 10 0 10 20 30 40 50 60 70 80 90 100 110 120 130 140 150

I:\JUL-2021\03-38
 R\Roadway\XSCA\5021-rdy-yp-1-Y11.dgn
 HNTB

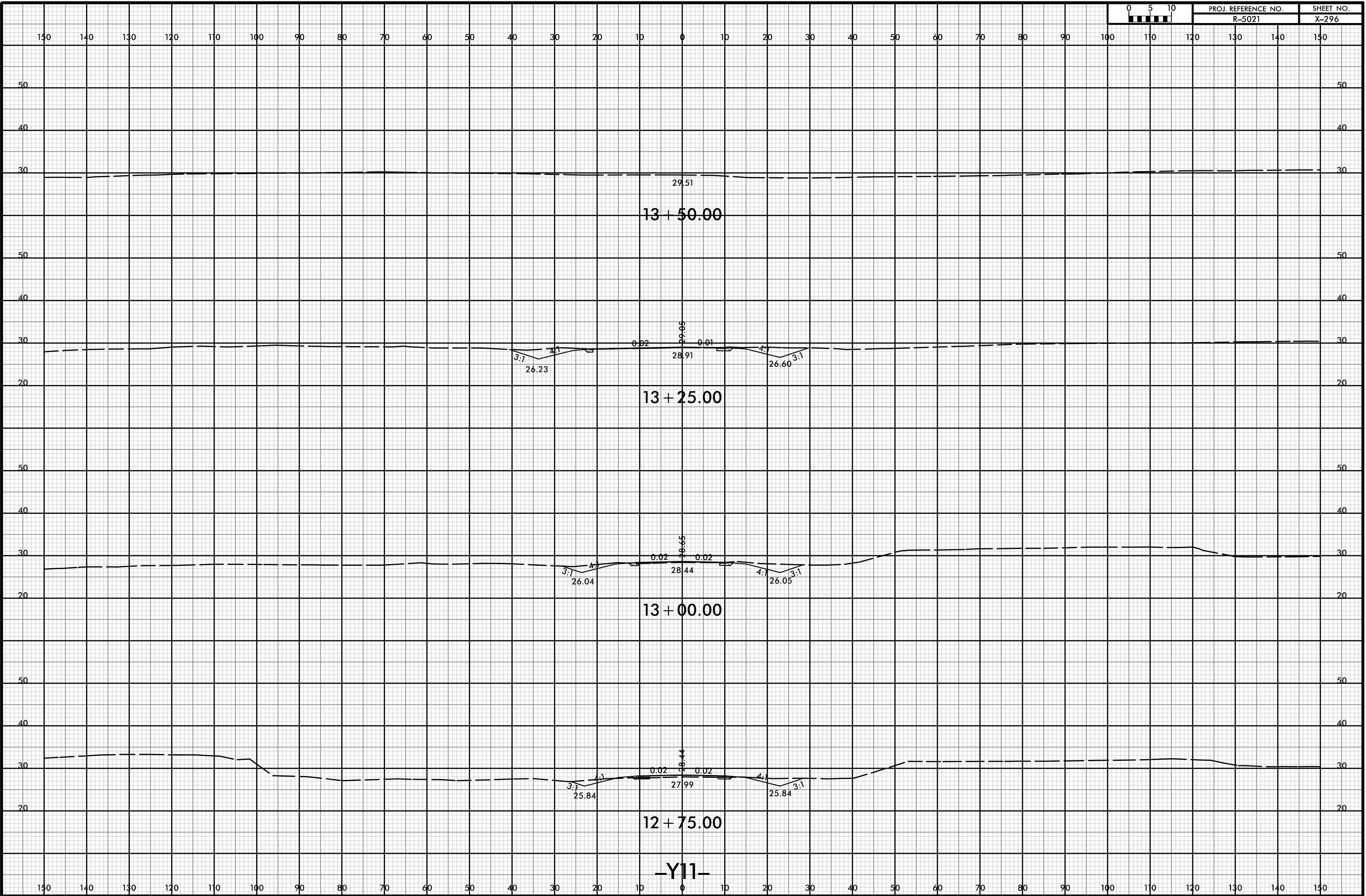

-Y11-



150 140 130 120 110 100 90 80 70 60 50 40 30 20 10 0 10 20 30 40 50 60 70 80 90 100 110 120 130 140 150

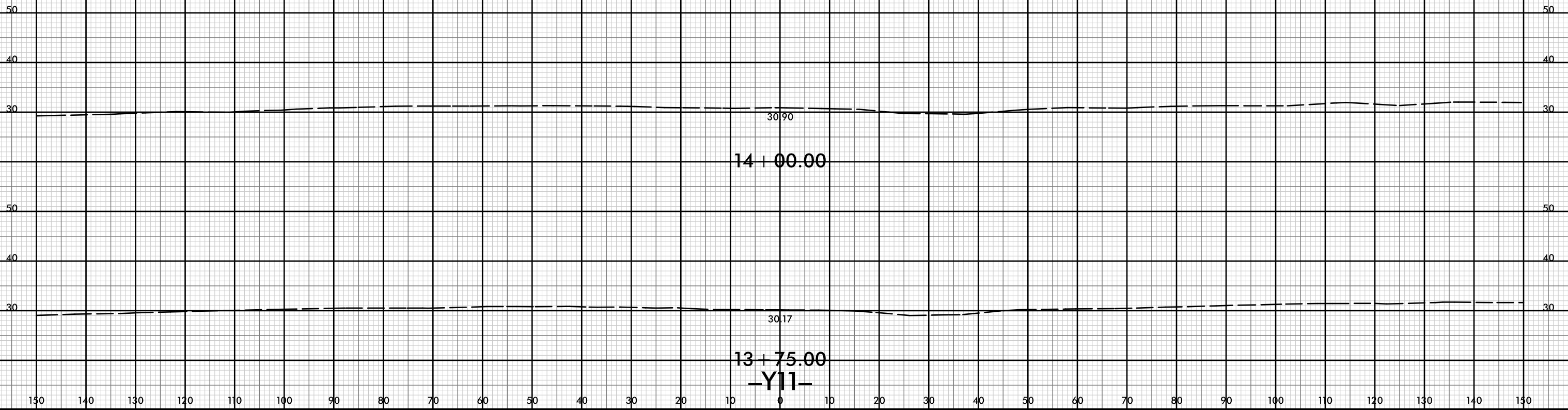

14 + 00.00

30.90

13 + 75.00

30.17

-Y11-



150 140 130 120 110 100 90 80 70 60 50 40 30 20 10 0 10 20 30 40 50 60 70 80 90 100 110 120 130 140 150

50 50

40 40

30 30

0.007 0.023
30.39 27.00
4:1 3:1

11 + 75.00

50 50

40 40

30 30

30.48

11 + 50.00

50 50

40 40

30 30

11 + 25.00

50 50

40 40

30 30

11 + 00.00

-Y12-

150 140 130 120 110 100 90 80 70 60 50 40 30 20 10 0 10 20 30 40 50 60 70 80 90 100 110 120 130 140 150

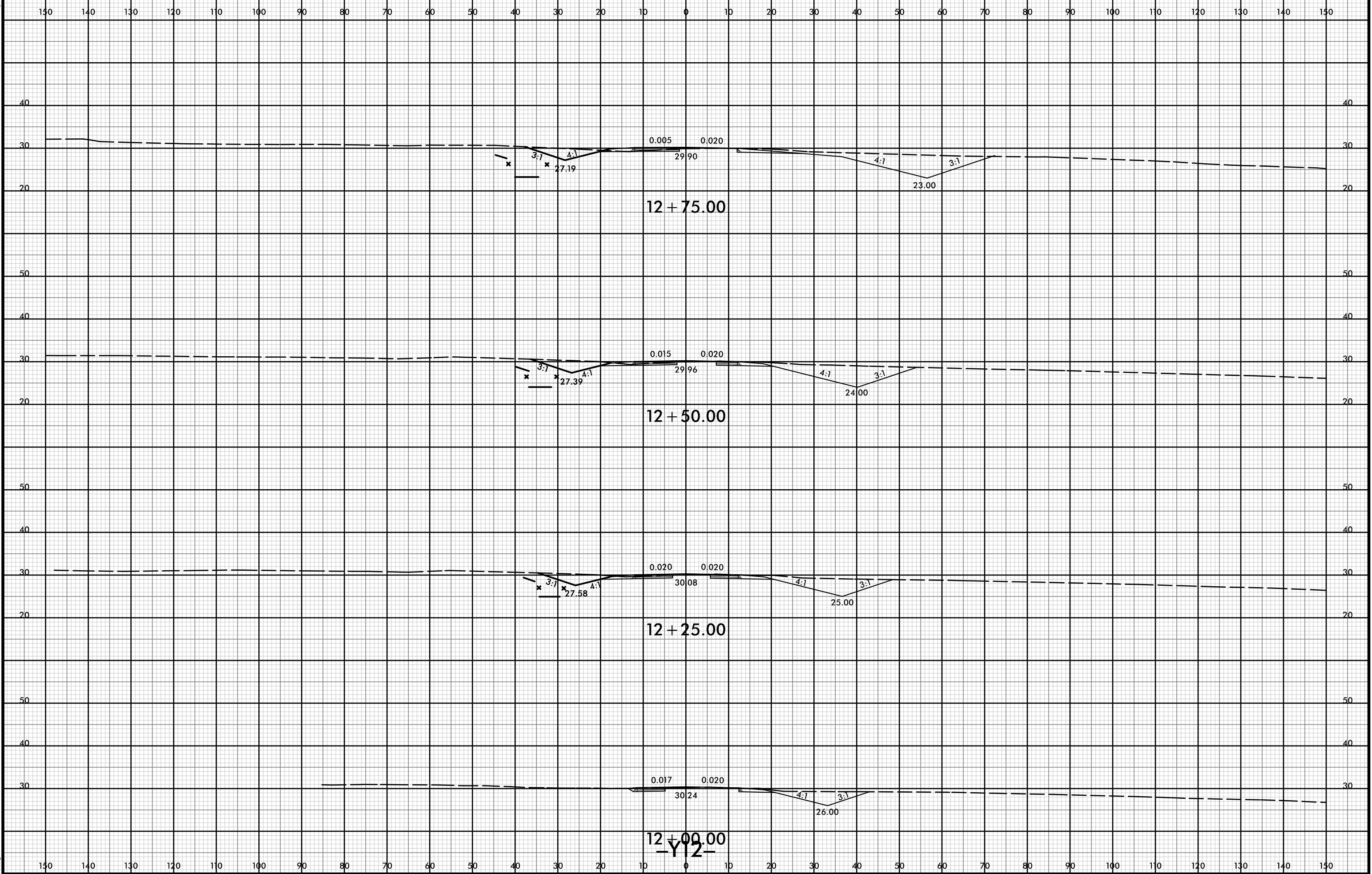

8/23/99



PROJ. REFERENCE NO.
R-5021

SHEET NO.
X-300

150 140 130 120 110 100 90 80 70 60 50 40 30 20 10 0 10 20 30 40 50 60 70 80 90 100 110 120 130 140 150

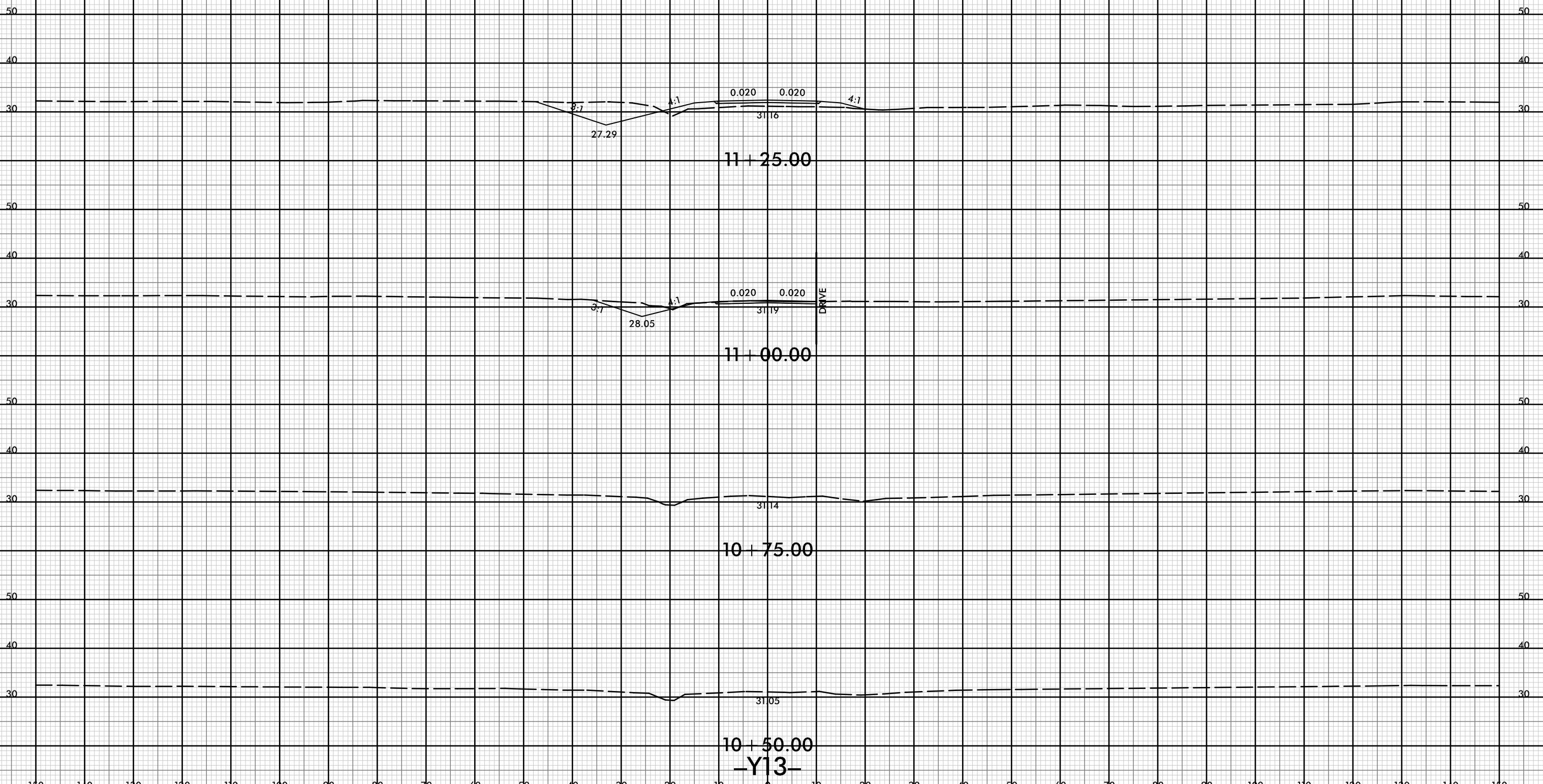

$10 + 50.00$
-Y13-

21-Jul-2021 10:38
R:\p\dawej\XSCA\5021-rdy-xp-l-Y13.dgn
HTB

150 140 130 120 110 100 90 80 70 60 50 40 30 20 10 0 10 20 30 40 50 60 70 80 90 100 110 120 130 140 150

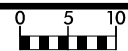

150 140 130 120 110 100 90 80 70 60 50 40 30 20 10 0 10 20 30 40 50 60 70 80 90 100 110 120 130 140 150

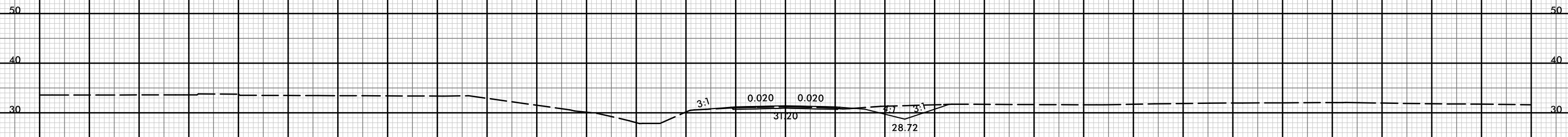

11 + 25.00

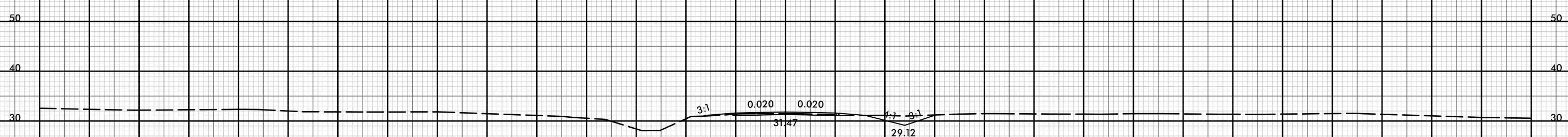

11 + 00.00

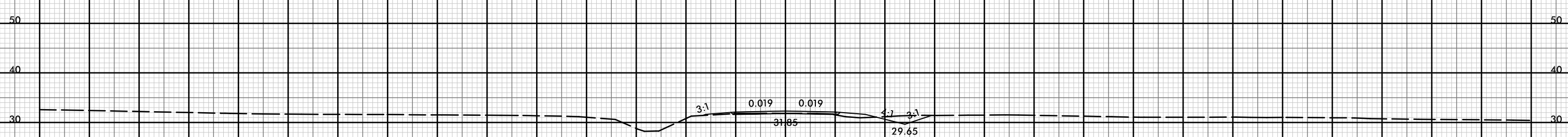

10 + 75.00

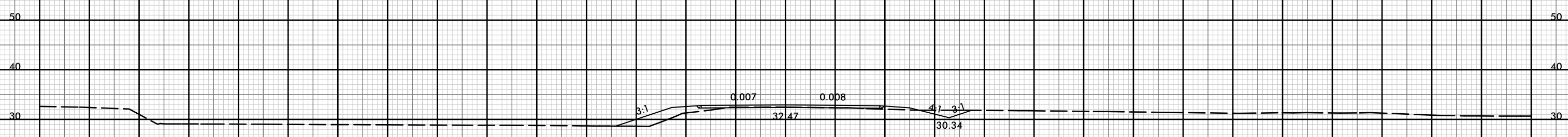

10 + 50.00

-Y14-

150 140 130 120 110 100 90 80 70 60 50 40 30 20 10 0 10 20 30 40 50 60 70 80 90 100 110 120 130 140 150



150 140 130 120 110 100 90 80 70 60 50 40 30 20 10 0 10 20 30 40 50 60 70 80 90 100 110 120 130 140 150

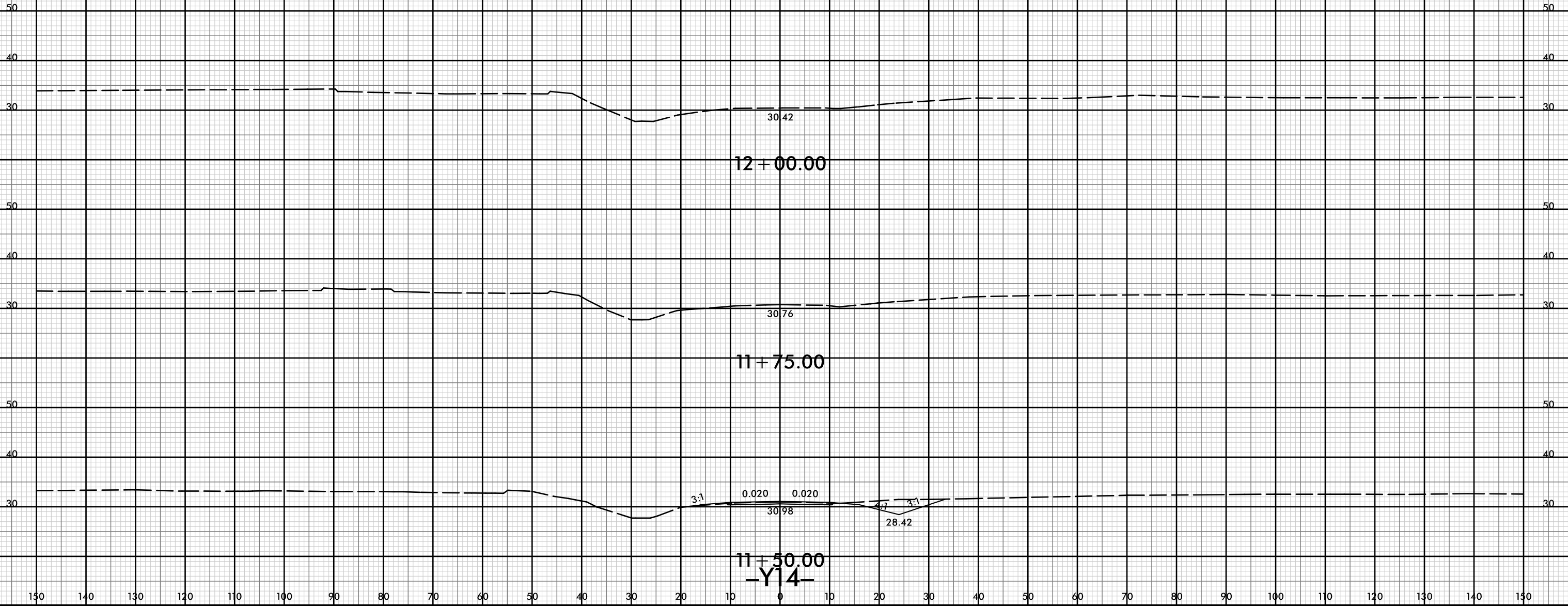

150 140 130 120 110 100 90 80 70 60 50 40 30 20 10 0 10 20 30 40 50 60 70 80 90 100 110 120 130 140 150

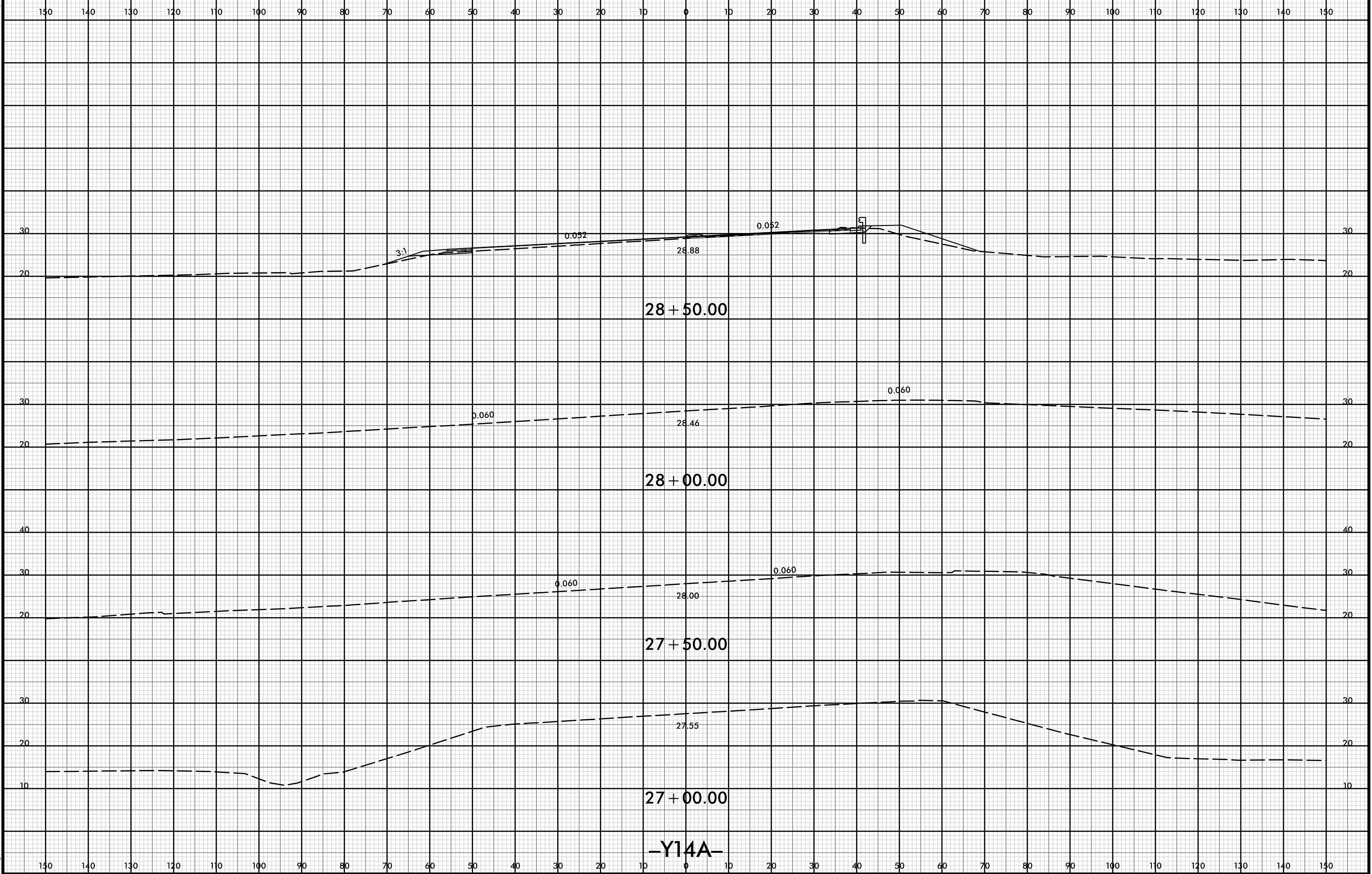

150 140 130 120 110 100 90 80 70 60 50 40 30 20 10 0 10 20 30 40 50 60 70 80 90 100 110 120 130 140 150

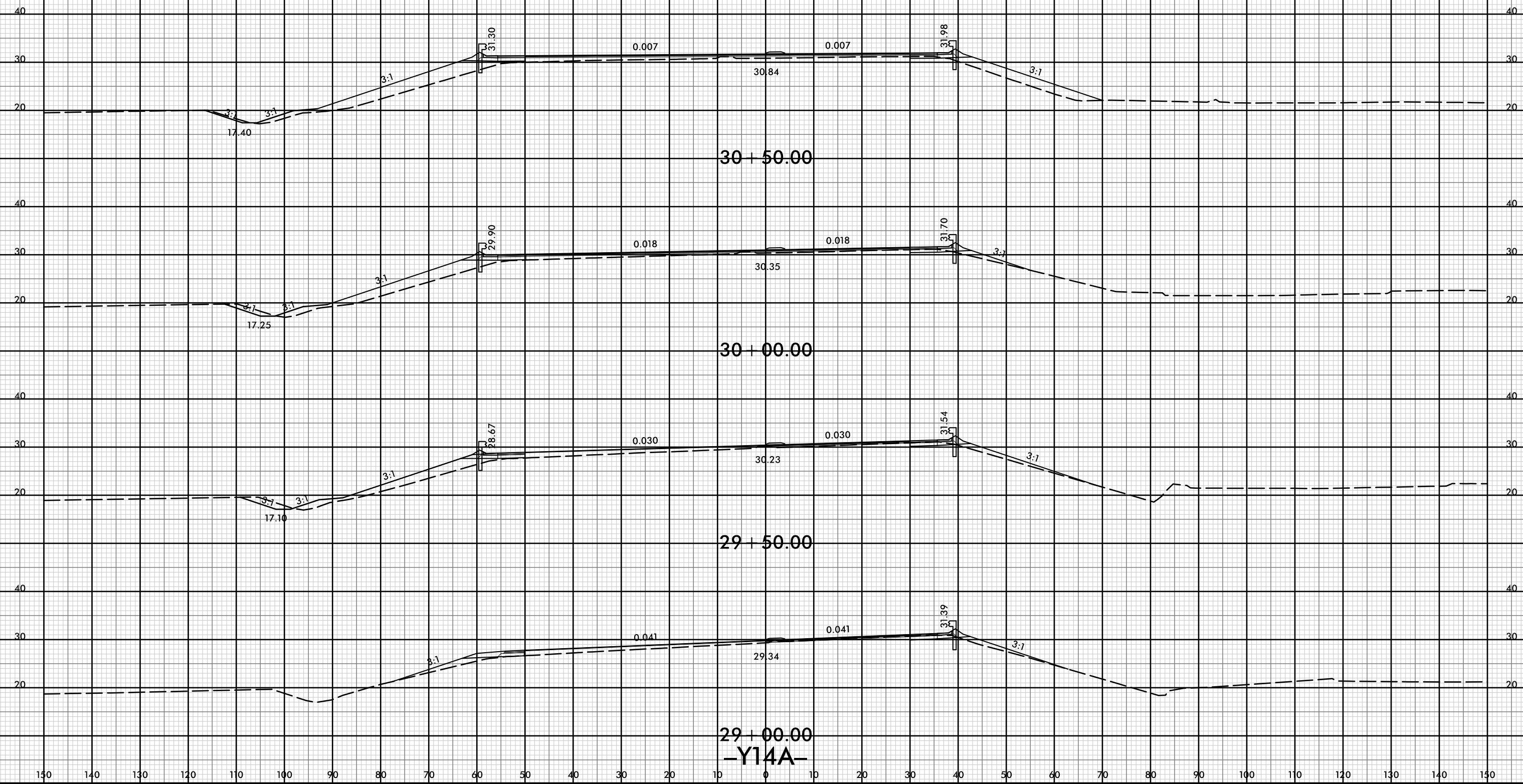

29 + 00.00
-Y14A-

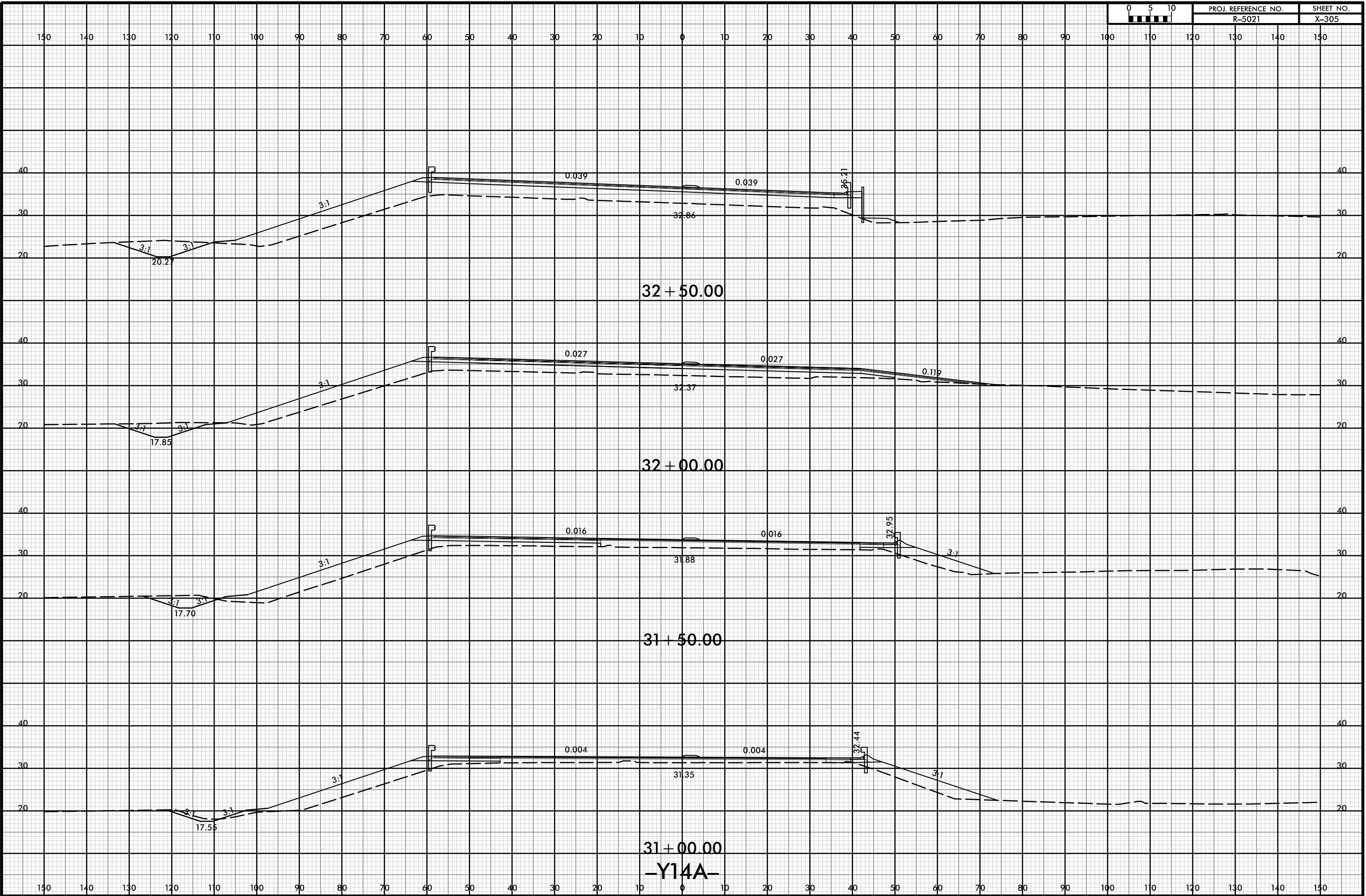



150 140 130 120 110 100 90 80 70 60 50 40 30 20 10 0 10 20 30 40 50 60 70 80 90 100 110 120 130 140 150

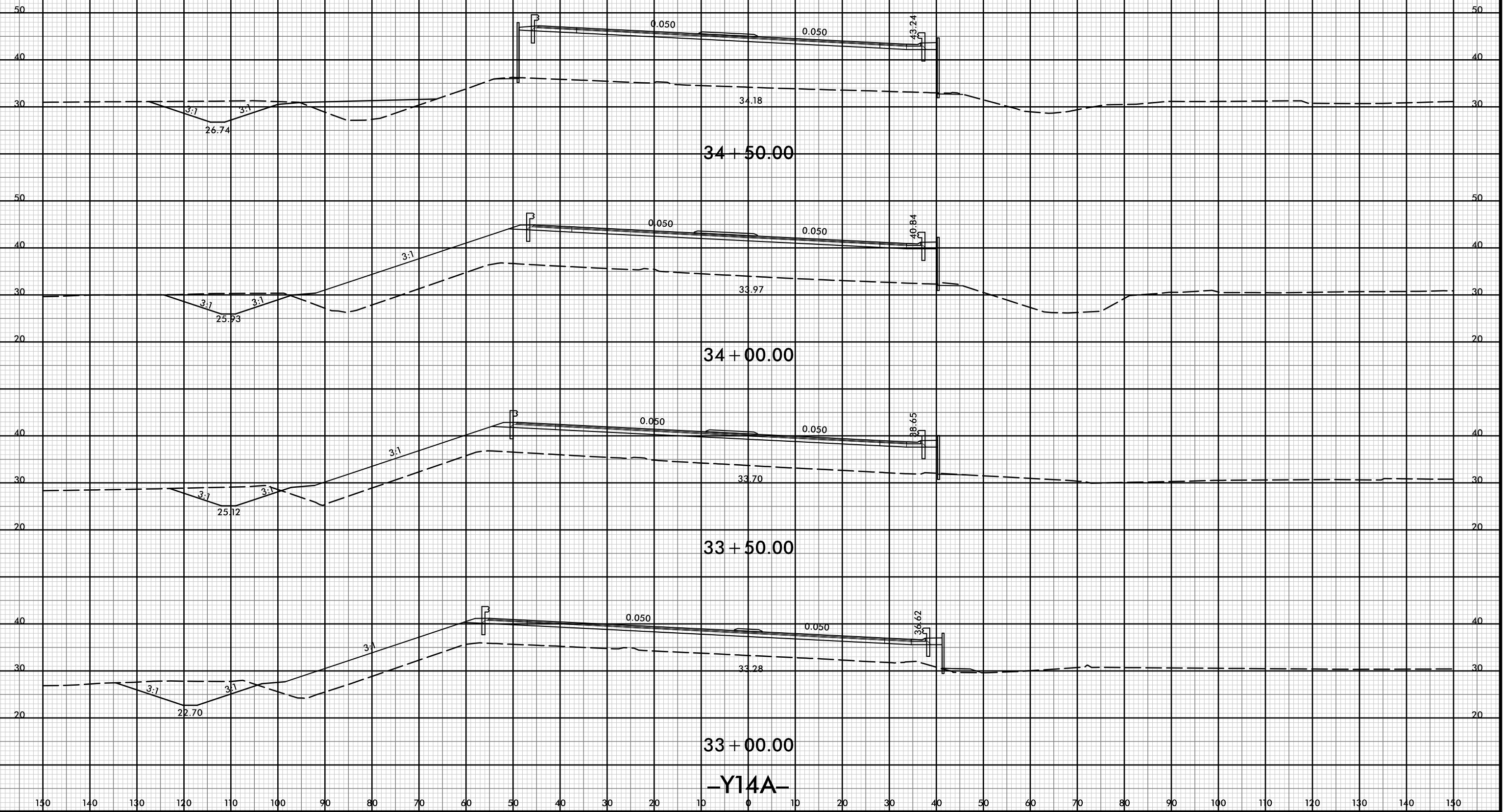

34 + 50.00

34 + 00.00

33 + 50.00

33 + 00.00

-Y14A-



150 140 130 120 110 100 90 80 70 60 50 40 30 20 10 0 10 20 30 40 50 60 70 80 90 100 110 120 130 140 150

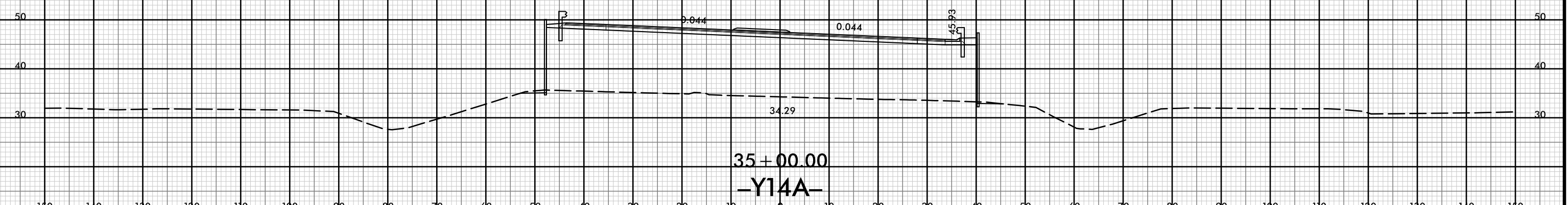
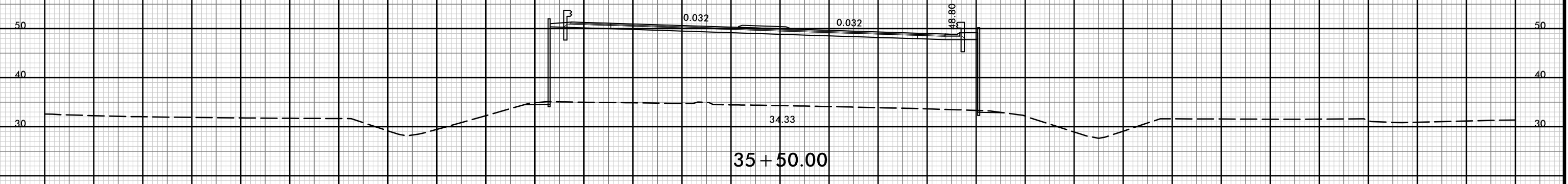
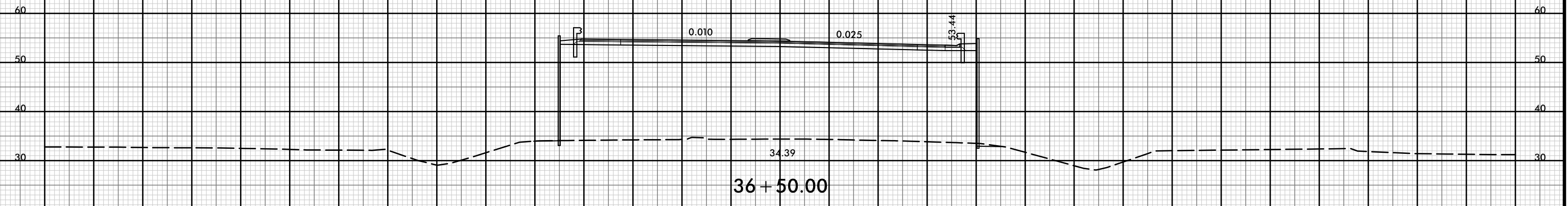

-Y14A-



150 140 130 120 110 100 90 80 70 60 50 40 30 20 10 0 10 20 30 40 50 60 70 80 90 100 110 120 130 140 150

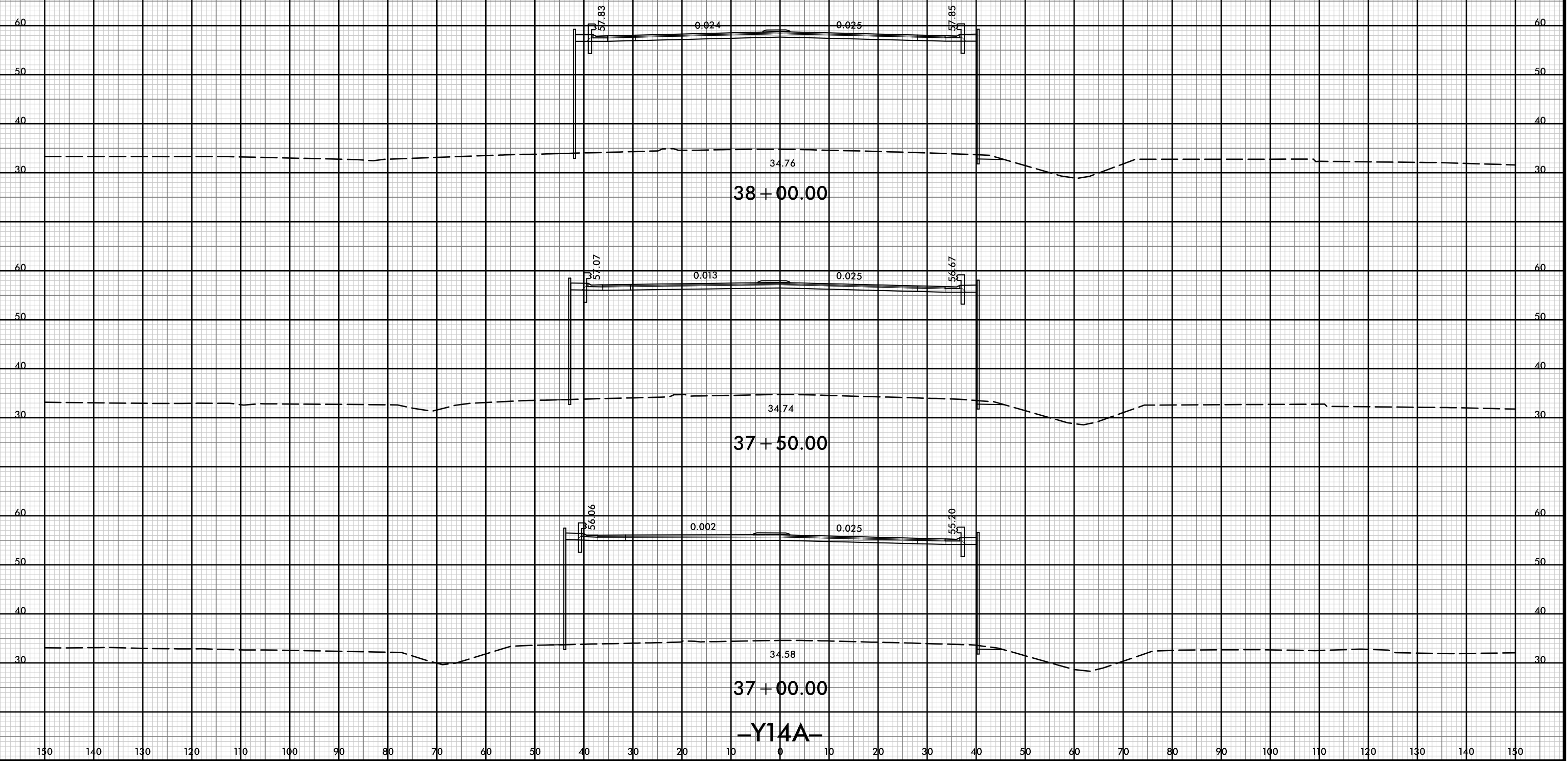

-Y14A-

8/23/99



PROJ. REFERENCE NO.
R-5021

SHEET NO.
X-309

150 140 130 120 110 100 90 80 70 60 50 40 30 20 10 0 10 20 30 40 50 60 70 80 90 100 110 120 130 140 150

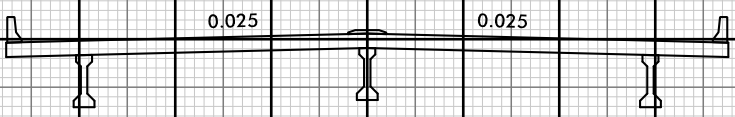

39 + 50.00

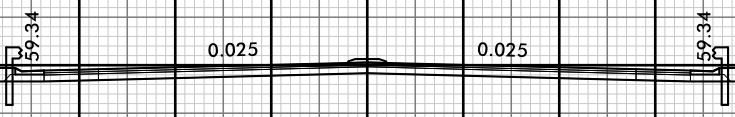

35.24

39 + 00.00

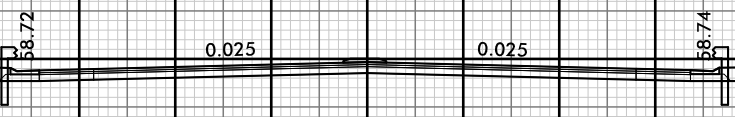

34.99

38 + 50.00

-Y14A-

150 140 130 120 110 100 90 80 70 60 50 40 30 20 10 0 10 20 30 40 50 60 70 80 90 100 110 120 130 140 150

21-Jul-2021 10:39
R:\pawej\XSCA\5021-rdy-xp-l-Y14A.dgn
HTB

150 140 130 120 110 100 90 80 70 60 50 40 30 20 10 0 10 20 30 40 50 60 70 80 90 100 110 120 130 140 150

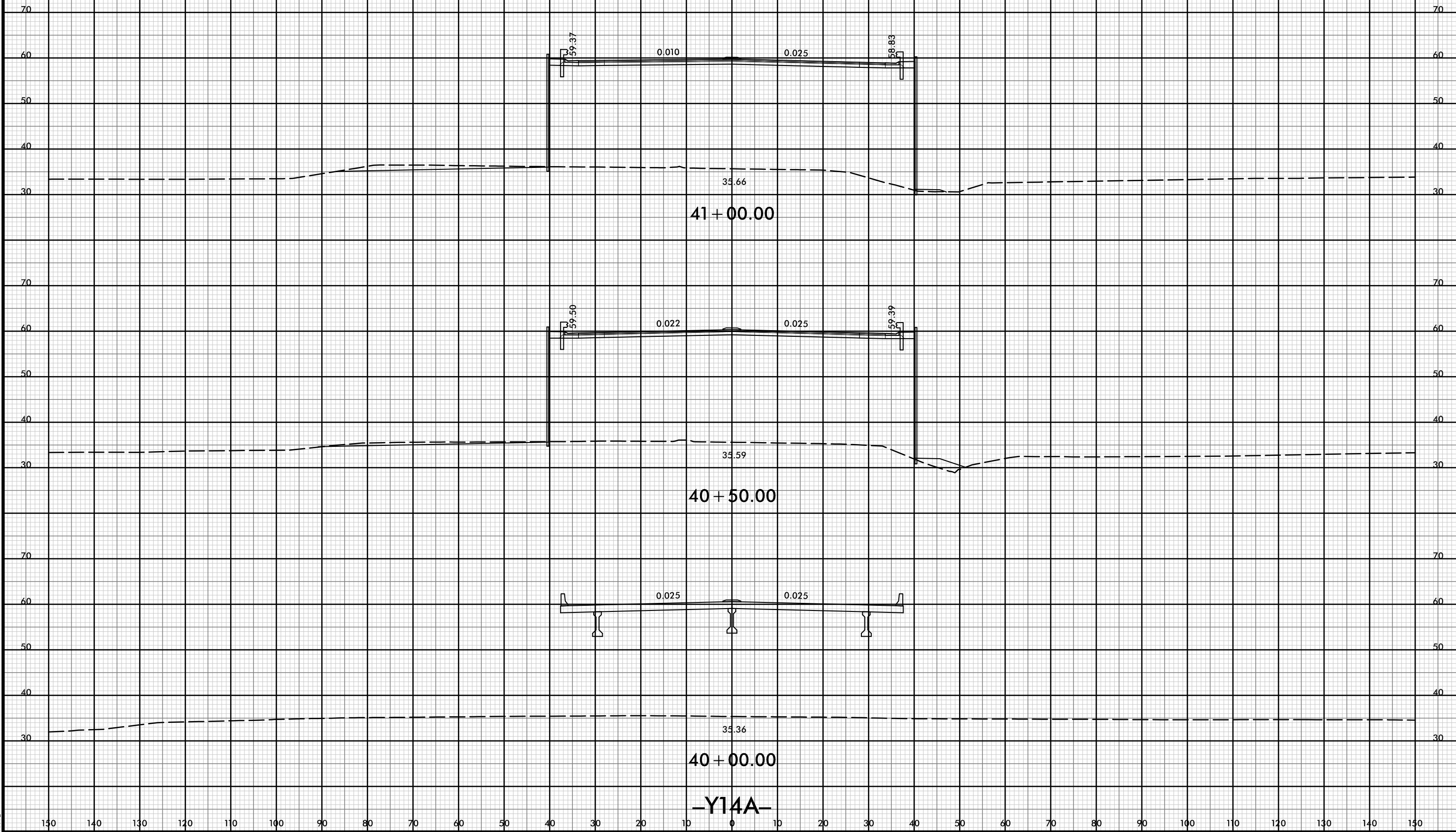

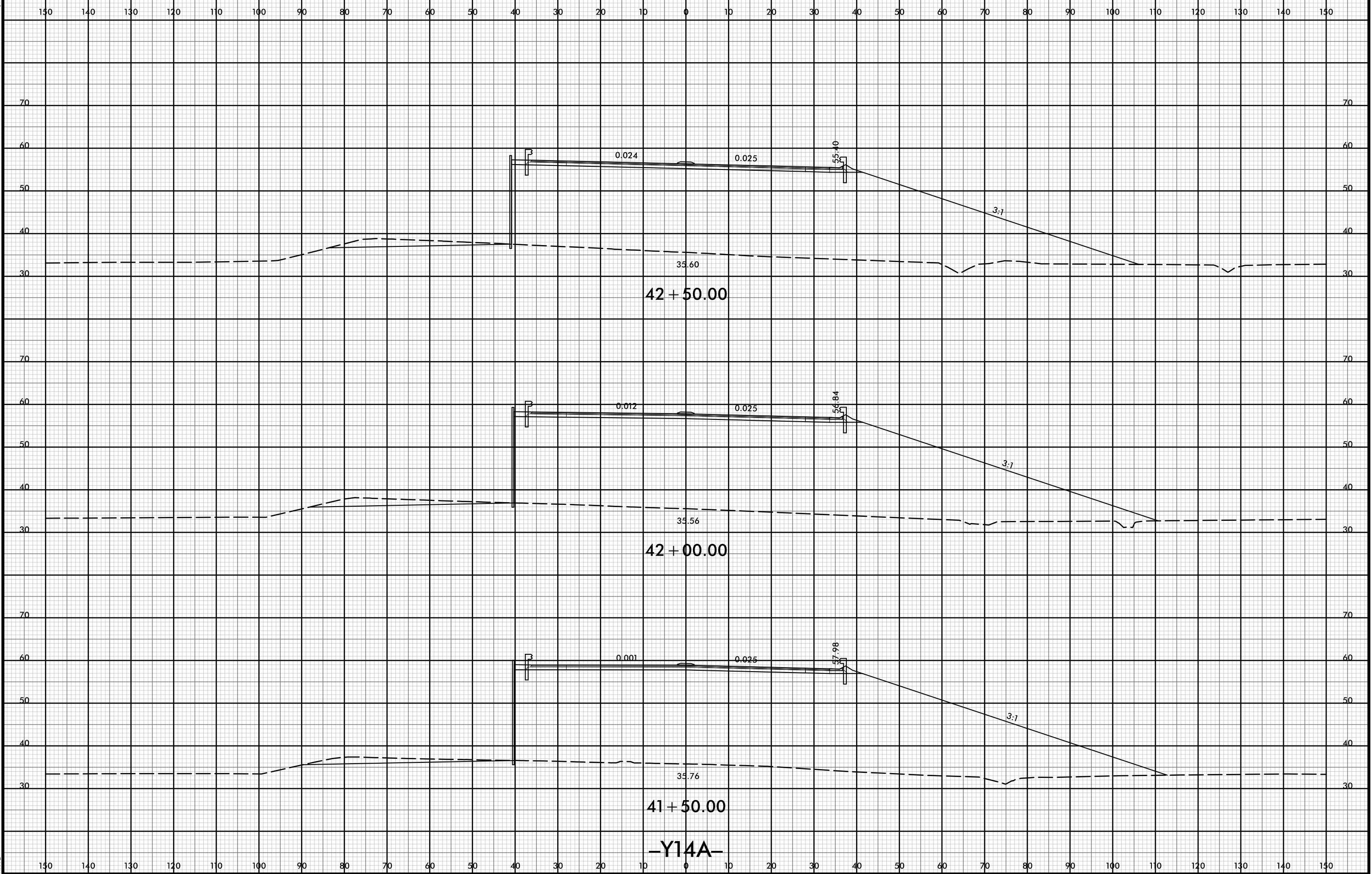



150 140 130 120 110 100 90 80 70 60 50 40 30 20 10 0 10 20 30 40 50 60 70 80 90 100 110 120 130 140 150

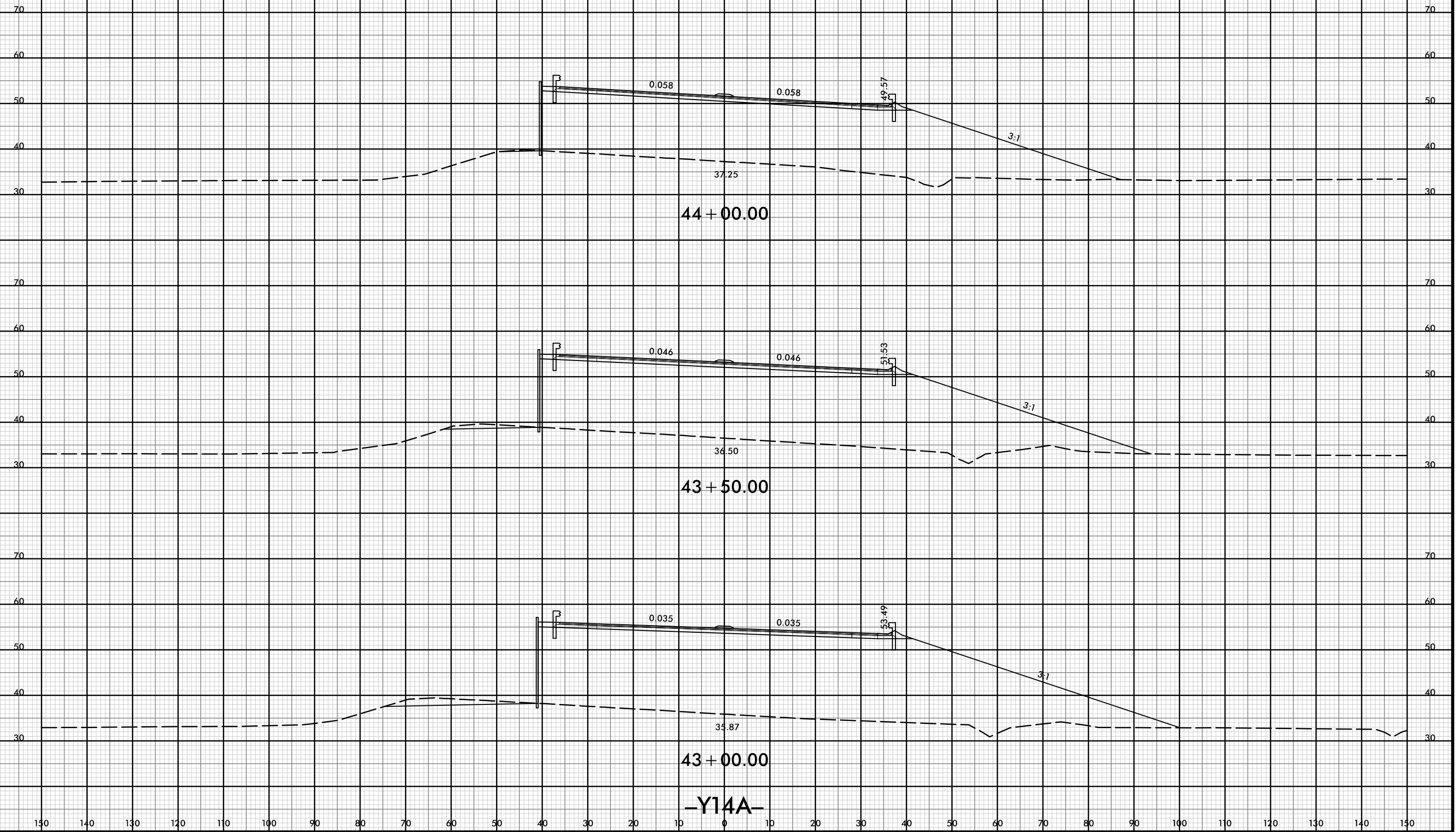

-Y14A-



150 140 130 120 110 100 90 80 70 60 50 40 30 20 10 0 10 20 30 40 50 60 70 80 90 100 110 120 130 140 150

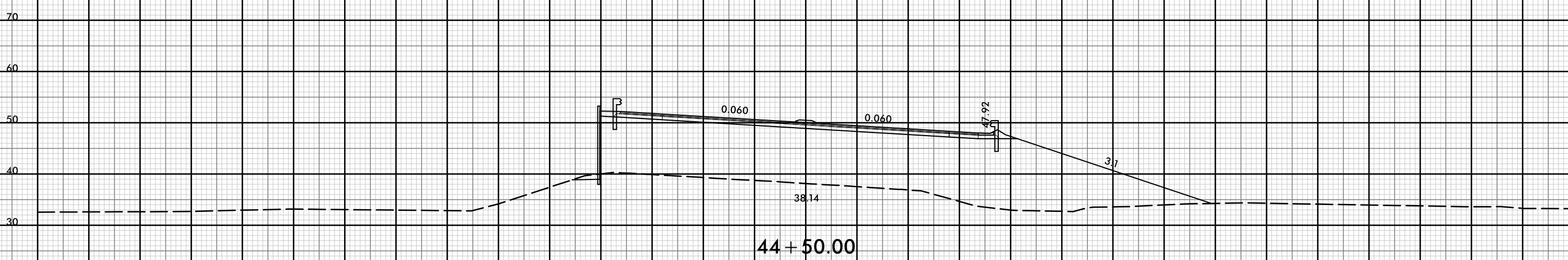
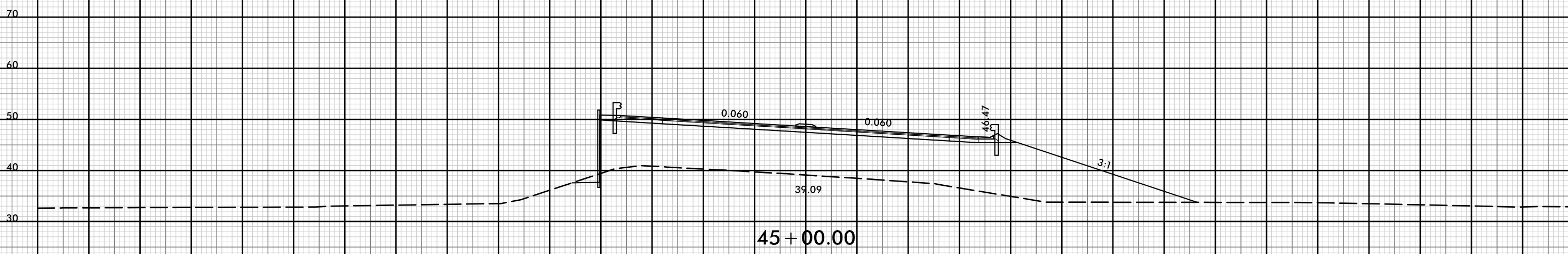
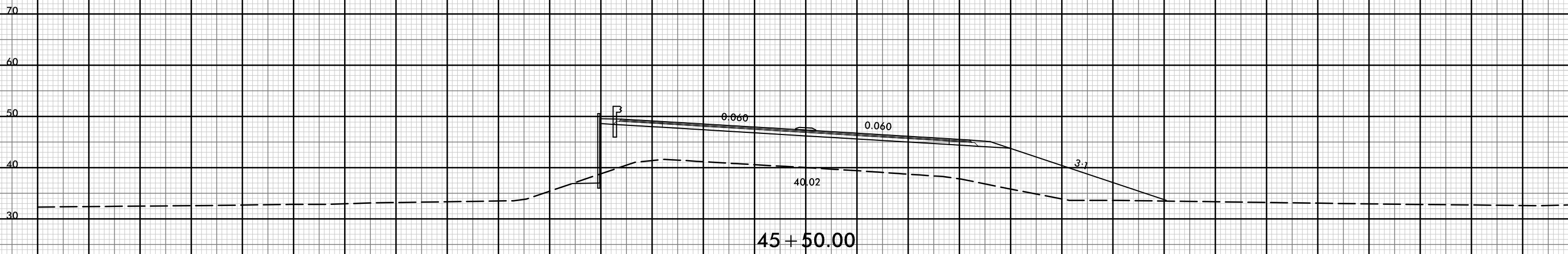

-Y14A-

150 140 130 120 110 100 90 80 70 60 50 40 30 20 10 0 10 20 30 40 50 60 70 80 90 100 110 120 130 140 150



150 140 130 120 110 100 90 80 70 60 50 40 30 20 10 0 10 20 30 40 50 60 70 80 90 100 110 120 130 140 150

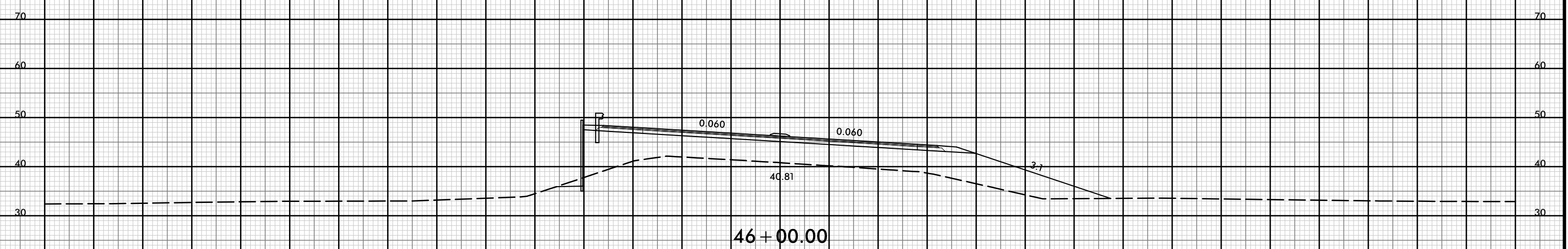
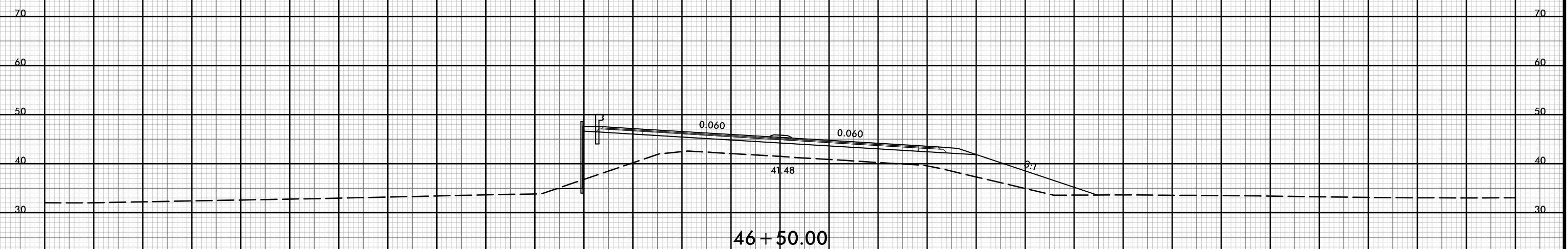
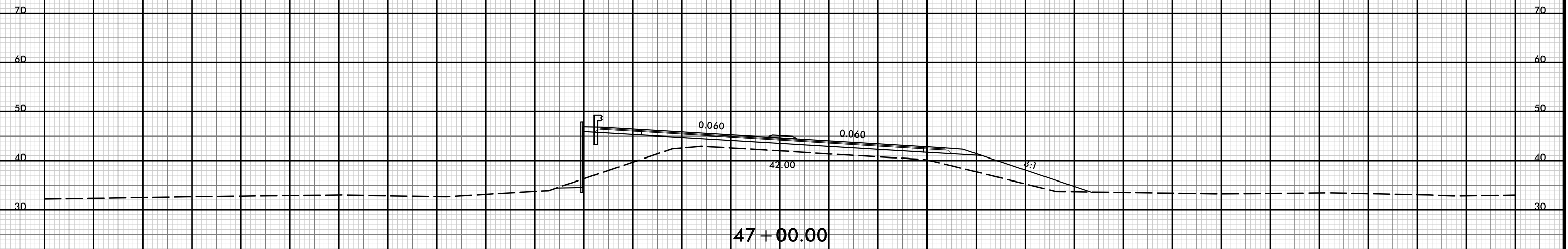

-Y14A-

150 140 130 120 110 100 90 80 70 60 50 40 30 20 10 0 10 20 30 40 50 60 70 80 90 100 110 120 130 140 150



150 140 130 120 110 100 90 80 70 60 50 40 30 20 10 0 10 20 30 40 50 60 70 80 90 100 110 120 130 140 150



48 + 50.00

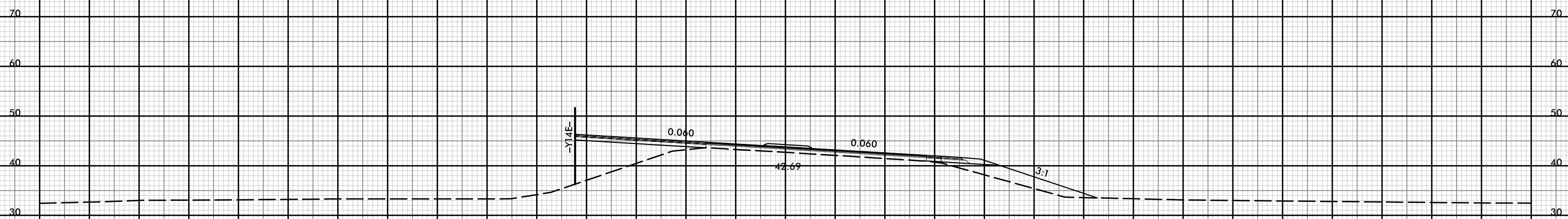

48 + 00.00

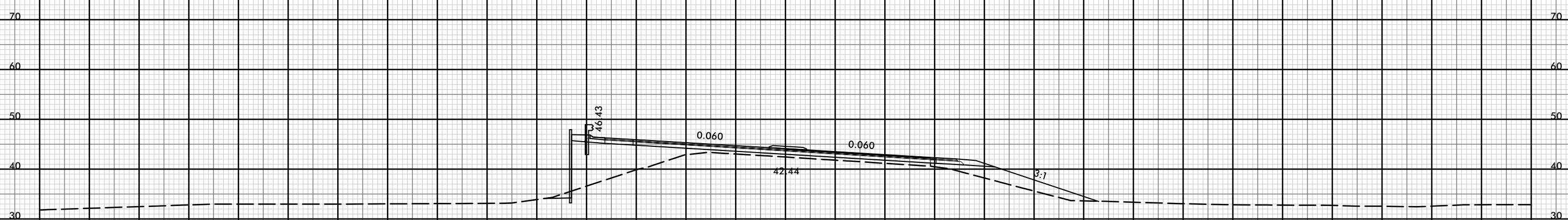

47 + 50.00

-Y14A-

150 140 130 120 110 100 90 80 70 60 50 40 30 20 10 0 10 20 30 40 50 60 70 80 90 100 110 120 130 140 150



150 140 130 120 110 100 90 80 70 60 50 40 30 20 10 0 10 20 30 40 50 60 70 80 90 100 110 120 130 140 150

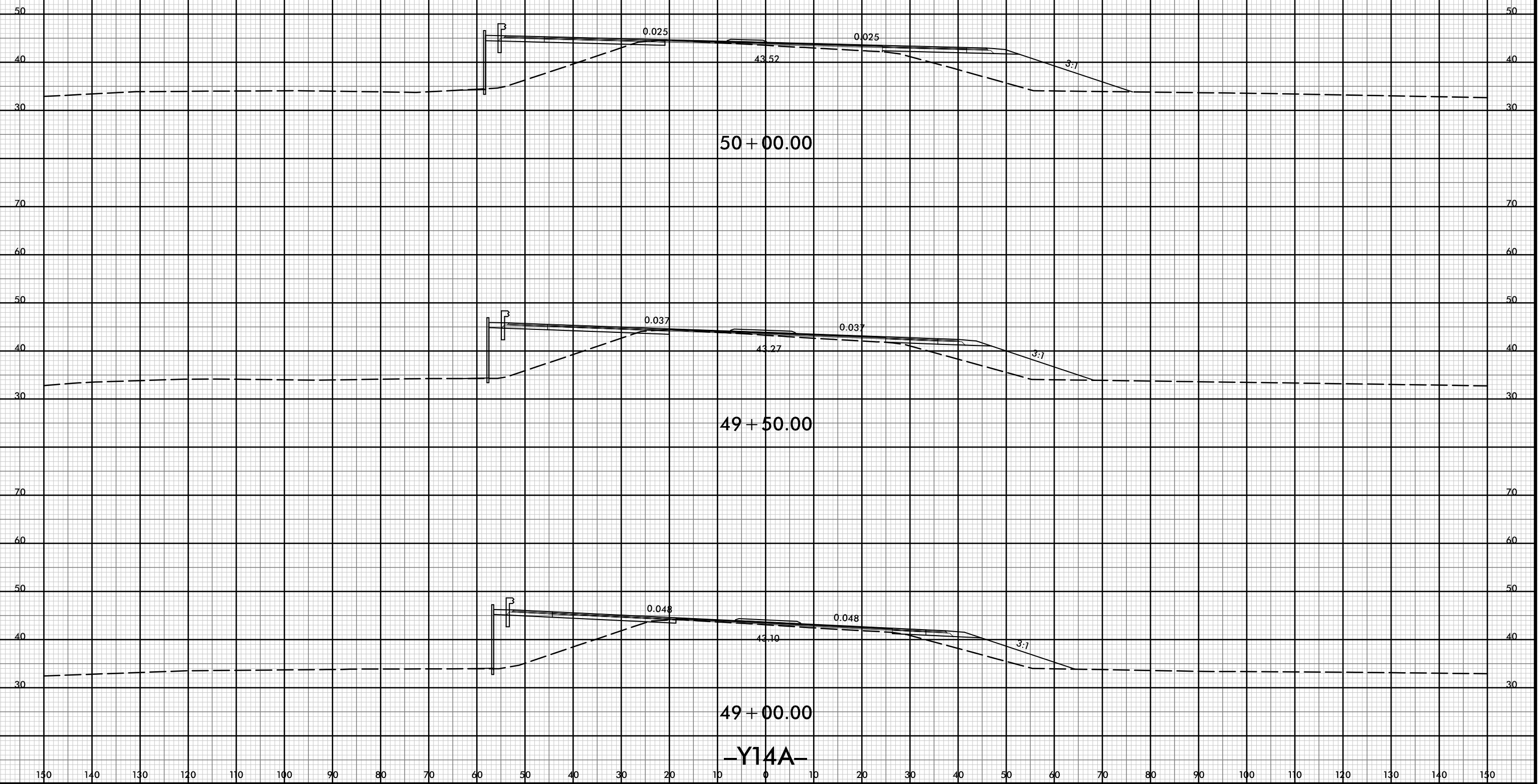

50 + 00.00

49 + 50.00

49 + 00.00

-Y14A-

150 140 130 120 110 100 90 80 70 60 50 40 30 20 10 0 10 20 30 40 50 60 70 80 90 100 110 120 130 140 150

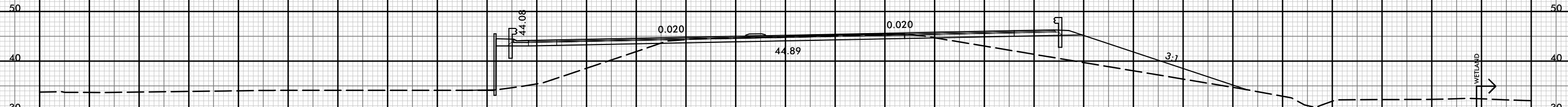

52 + 00.00

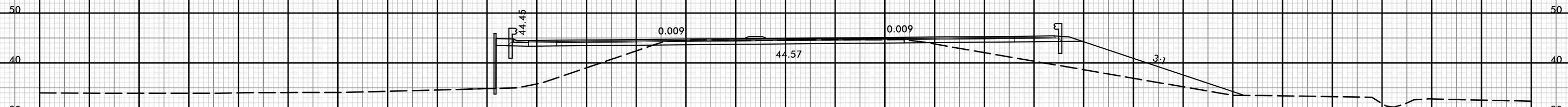

51 + 50.00

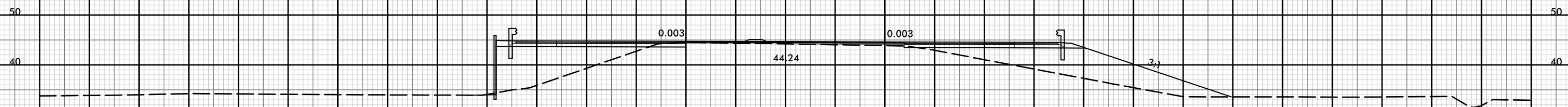

51 + 00.00

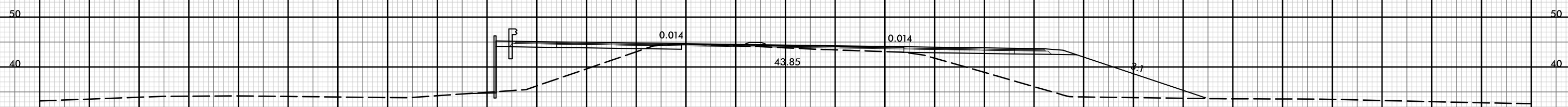

50 + 50.00

-Y14A-

150 140 130 120 110 100 90 80 70 60 50 40 30 20 10 0 10 20 30 40 50 60 70 80 90 100 110 120 130 140 150

150 140 130 120 110 100 90 80 70 60 50 40 30 20 10 0 10 20 30 40 50 60 70 80 90 100 110 120 130 140 150

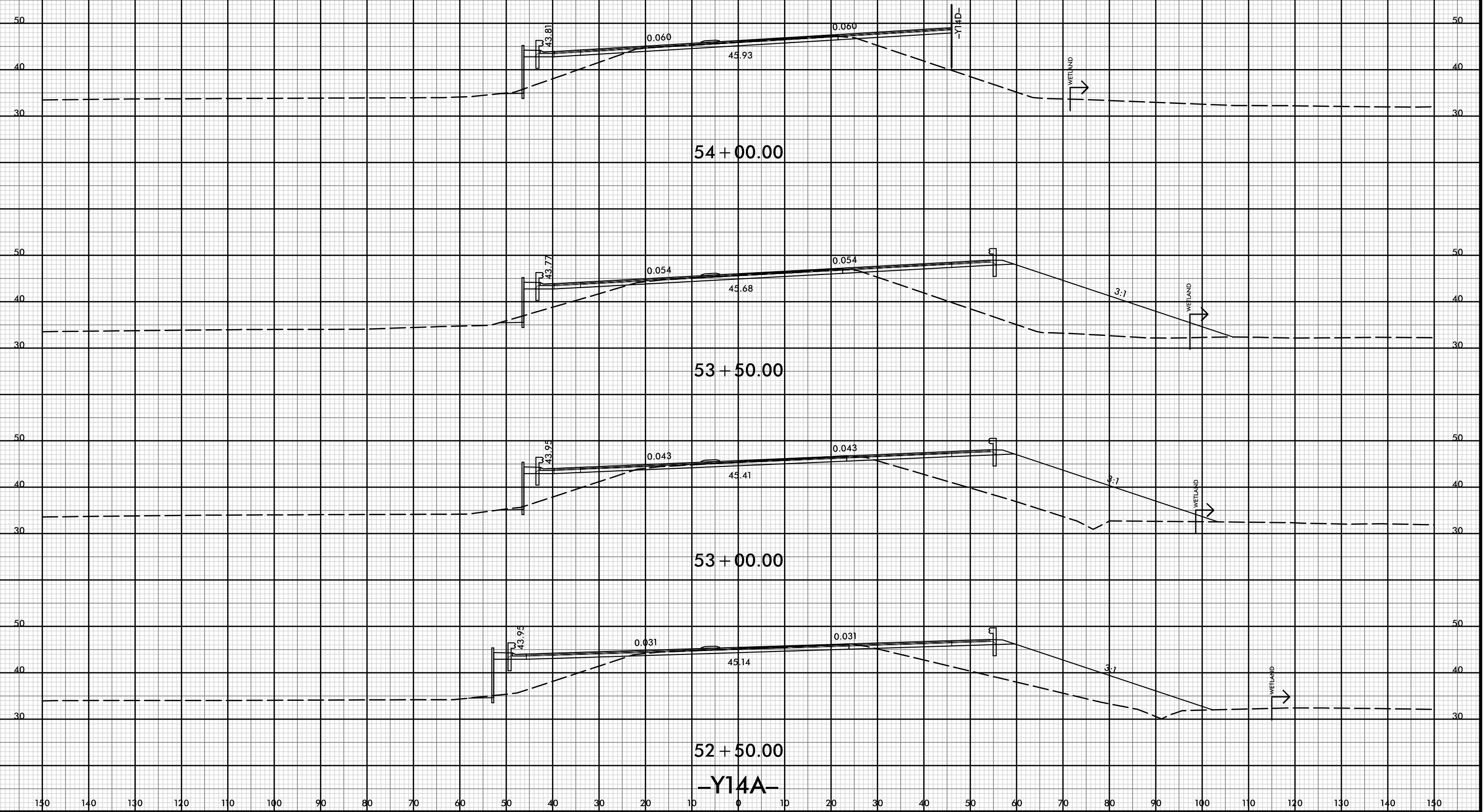

150 140 130 120 110 100 90 80 70 60 50 40 30 20 10 0 10 20 30 40 50 60 70 80 90 100 110 120 130 140 150

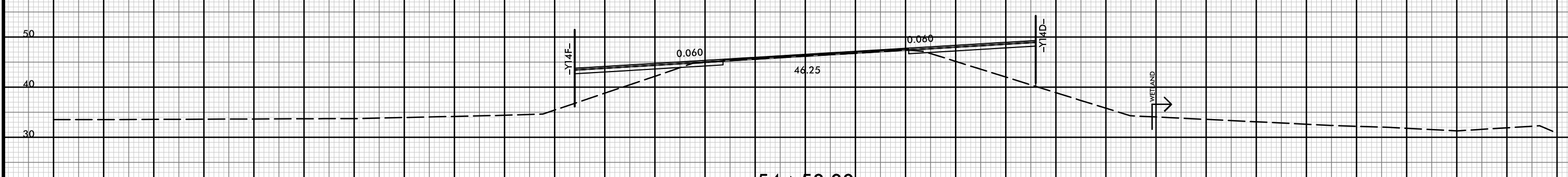
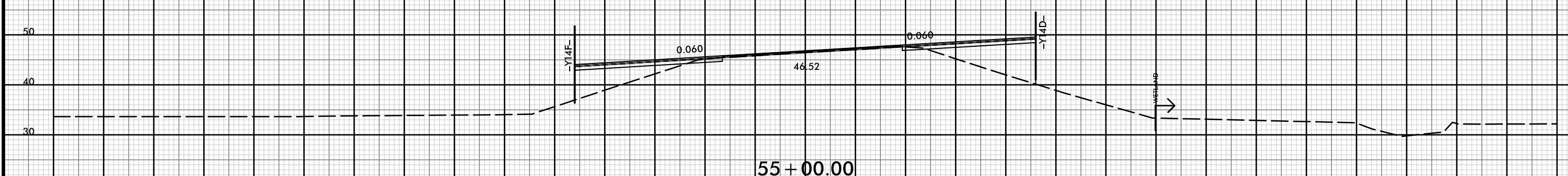
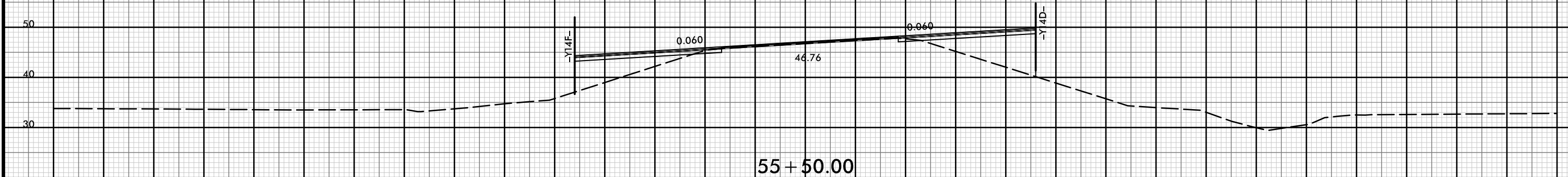
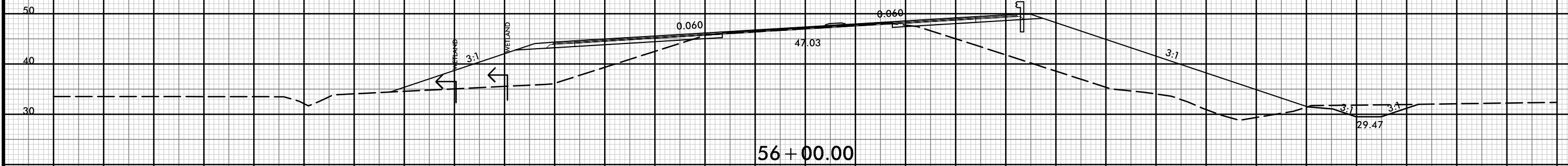

150 140 130 120 110 100 90 80 70 60 50 40 30 20 10 0 10 20 30 40 50 60 70 80 90 100 110 120 130 140 150



150 140 130 120 110 100 90 80 70 60 50 40 30 20 10 0 10 20 30 40 50 60 70 80 90 100 110 120 130 140 150

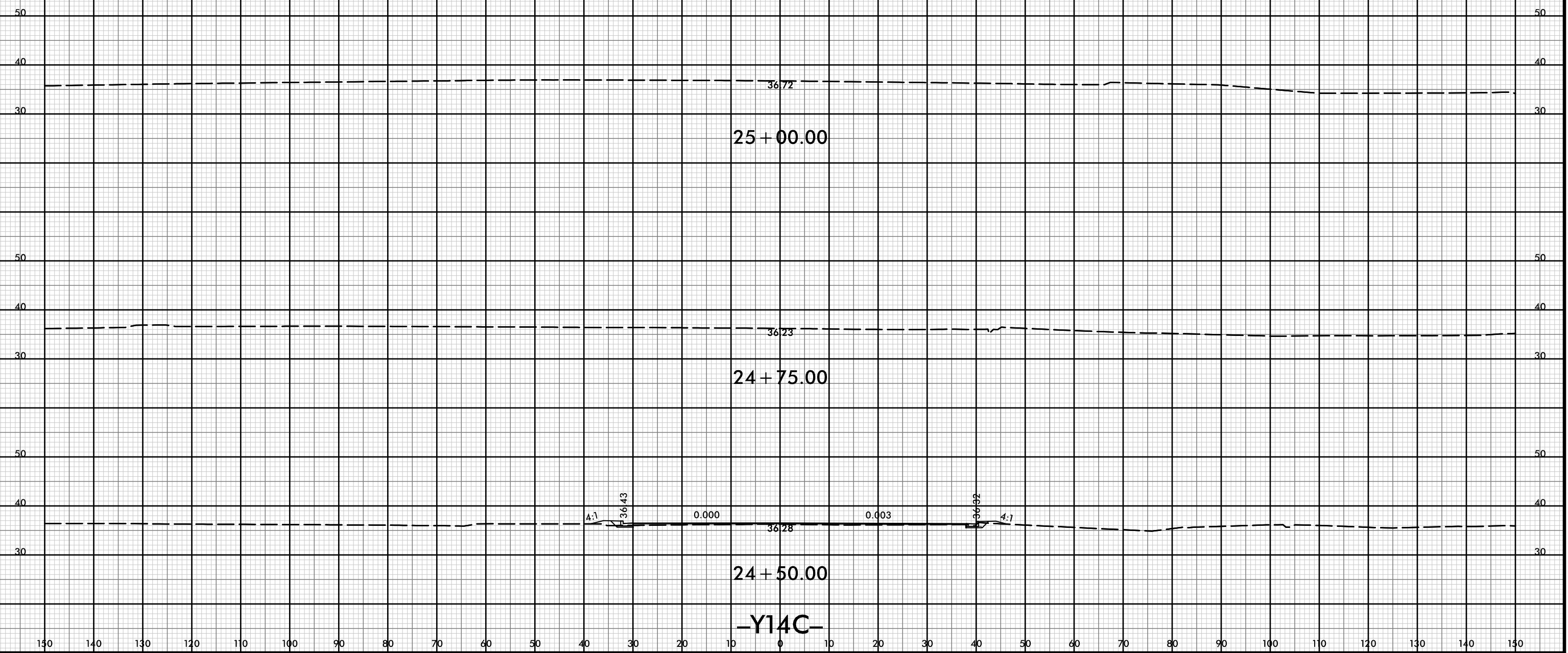

150 140 130 120 110 100 90 80 70 60 50 40 30 20 10 0 10 20 30 40 50 60 70 80 90 100 110 120 130 140 150

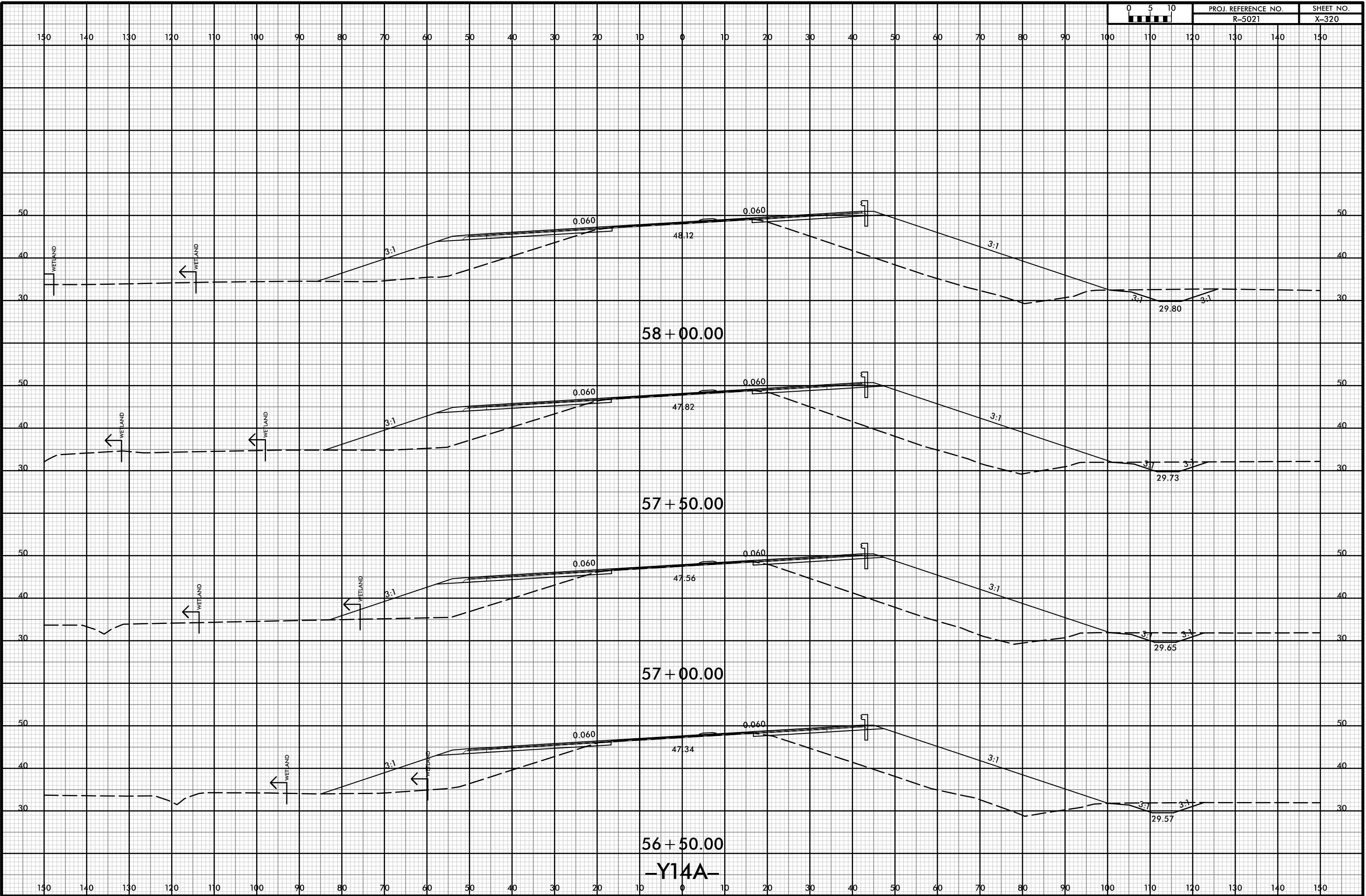

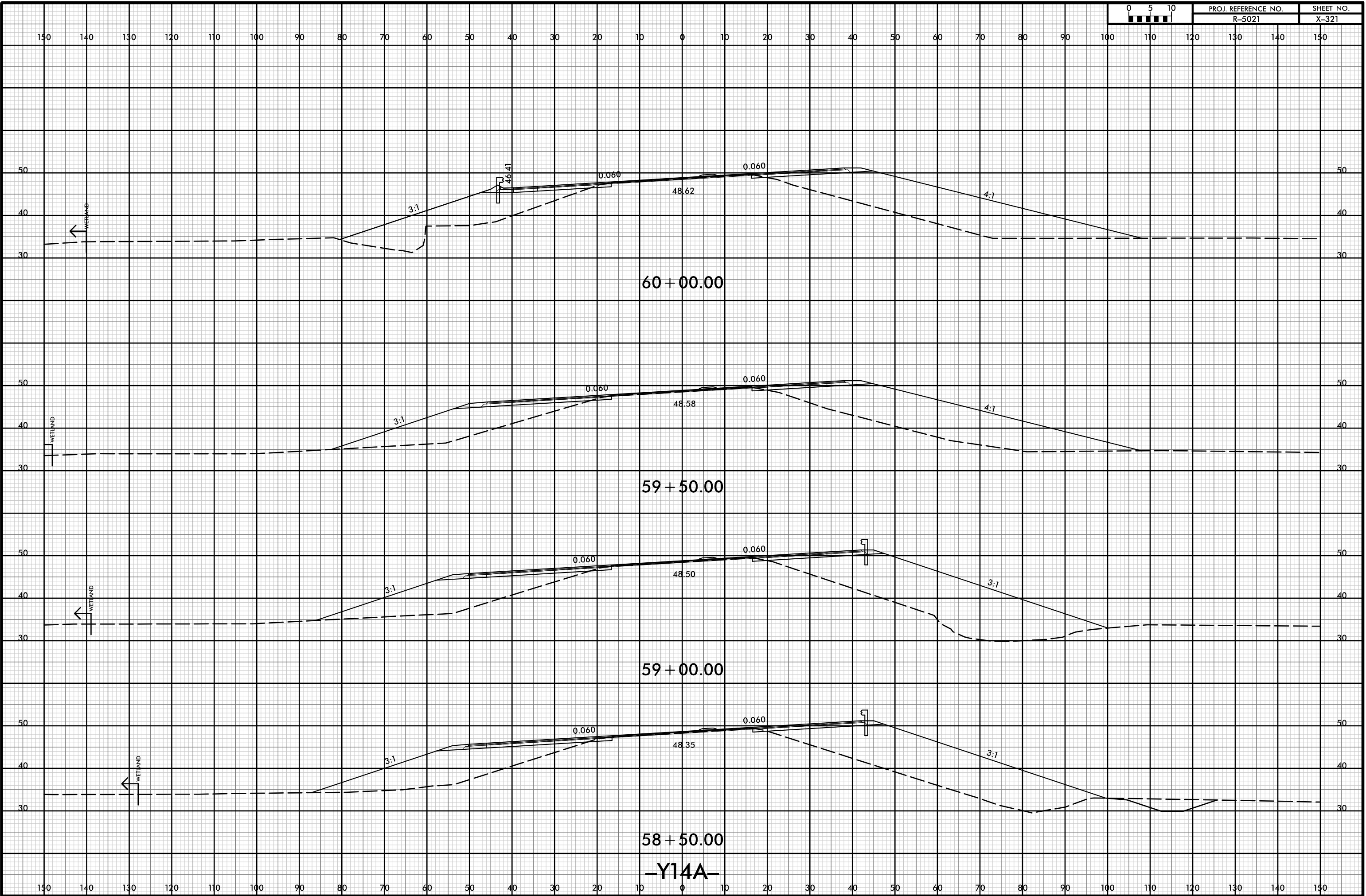



150 140 130 120 110 100 90 80 70 60 50 40 30 20 10 0 10 20 30 40 50 60 70 80 90 100 110 120 130 140 150

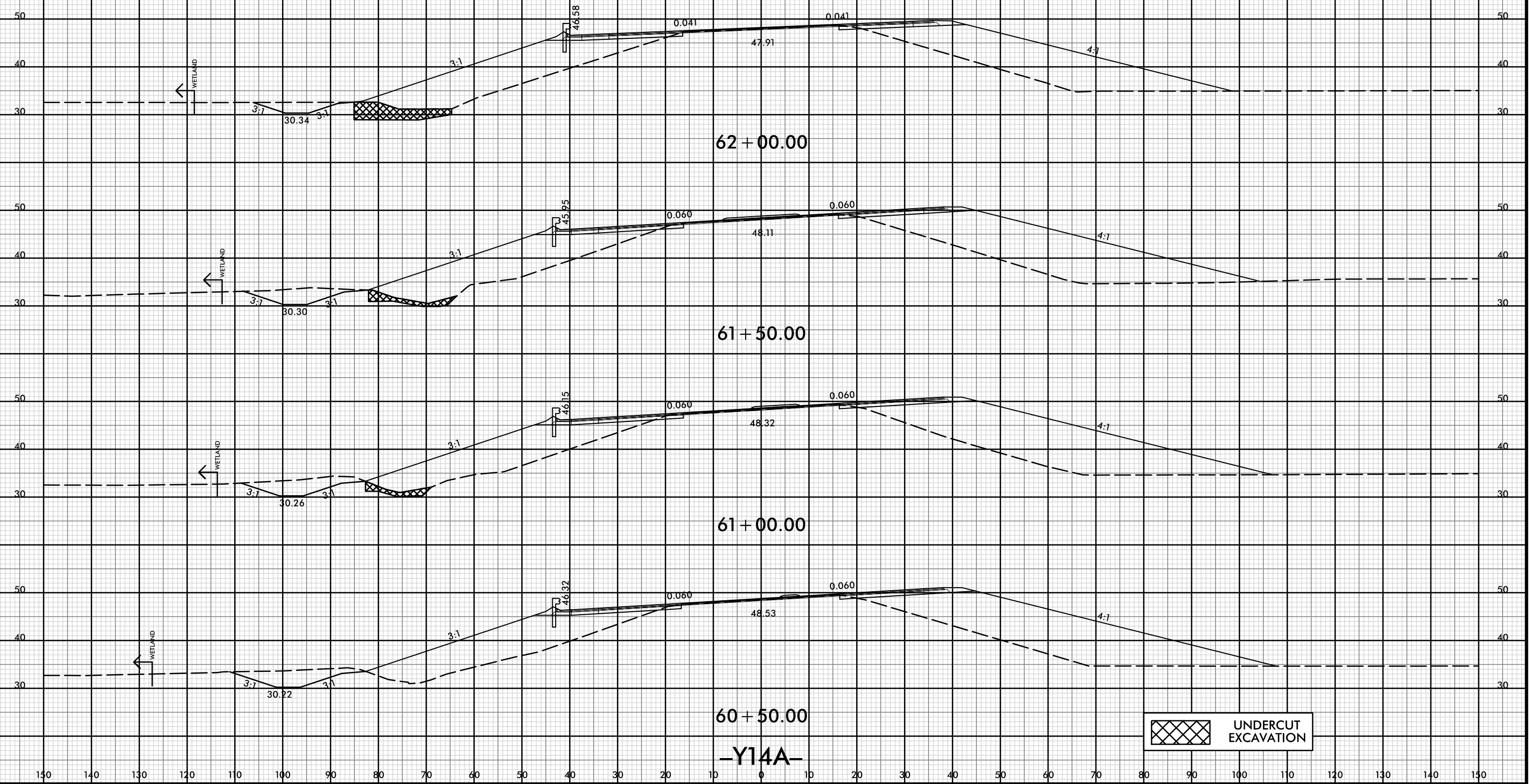

UNDERCUT EXCAVATION



150 140 130 120 110 100 90 80 70 60 50 40 30 20 10 0 10 20 30 40 50 60 70 80 90 100 110 120 130 140 150

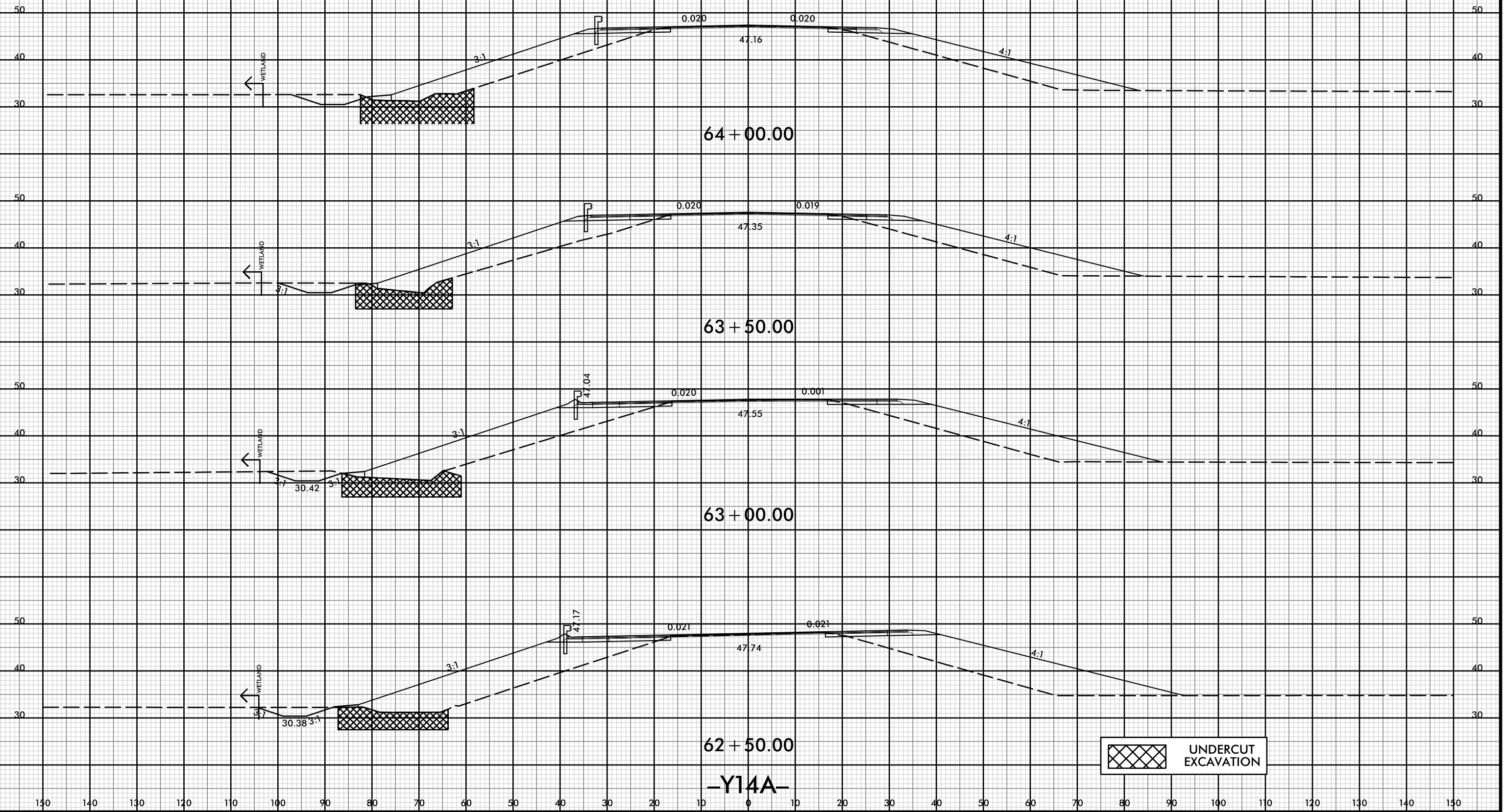

8/23/99



PROJ. REFERENCE NO.
R-5021

SHEET NO.
X-324

150 140 130 120 110 100 90 80 70 60 50 40 30 20 10 0 10 20 30 40 50 60 70 80 90 100 110 120 130 140 150

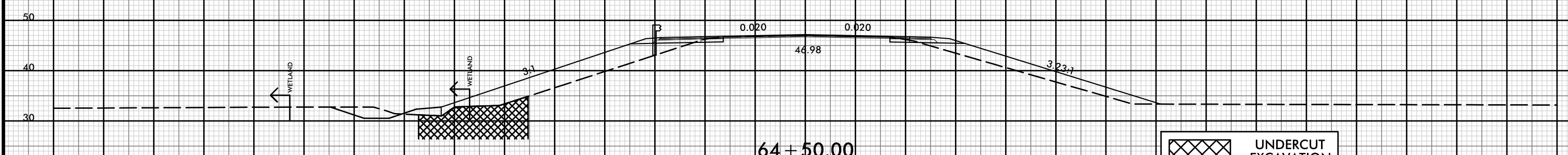
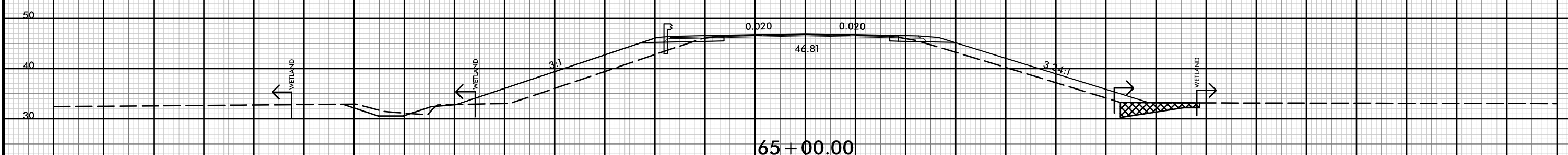
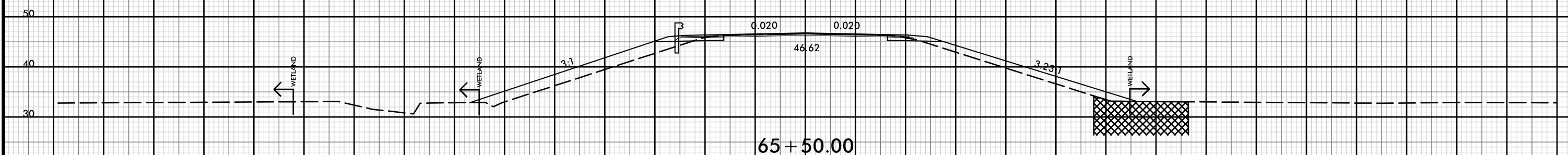
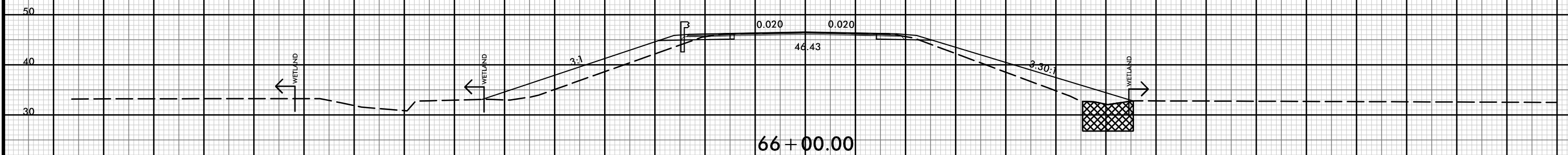

UNDERCUT EXCAVATION

-Y14A-

150 140 130 120 110 100 90 80 70 60 50 40 30 20 10 0 10 20 30 40 50 60 70 80 90 100 110 120 130 140 150

21-JUL-2021 10:39
R:\p\dawej\XSCA\5021-rdy-yp-l-Y14A.dgn
HNTB



150 140 130 120 110 100 90 80 70 60 50 40 30 20 10 0 10 20 30 40 50 60 70 80 90 100 110 120 130 140 150

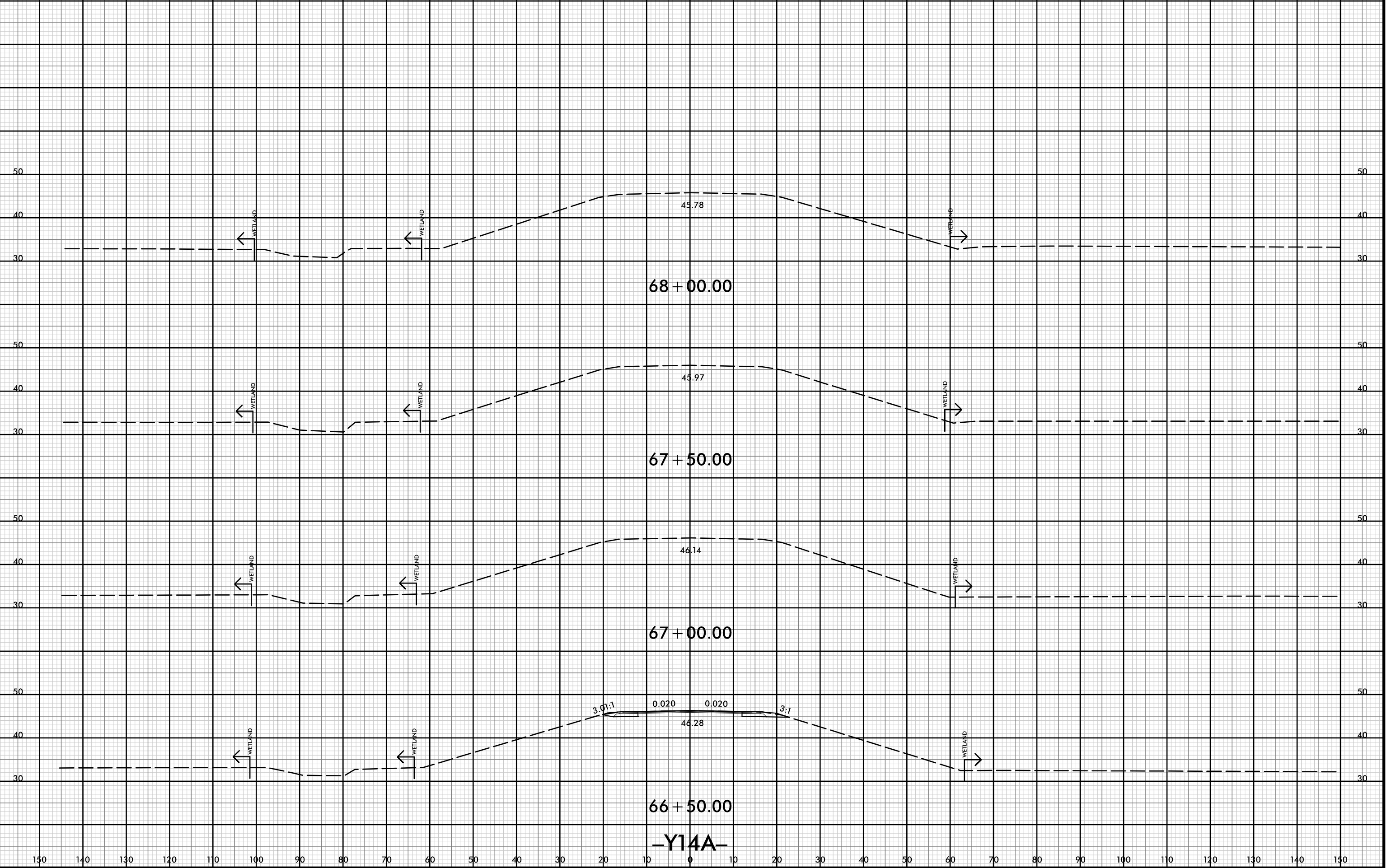

68 + 00.00

67 + 50.00

67 + 00.00

66 + 50.00

-Y14A-

45.78

45.97

46.14

46.28

3.01:1

0.020

0.020

3:1

WETLAND

WETLAND

WETLAND

WETLAND

WETLAND

WETLAND

WETLAND

WETLAND

WETLAND

WETLAND

WETLAND

WETLAND



150 140 130 120 110 100 90 80 70 60 50 40 30 20 10 0 10 20 30 40 50 60 70 80 90 100 110 120 130 140 150

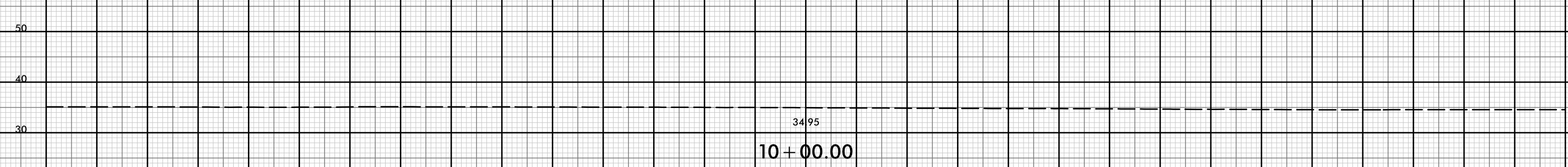
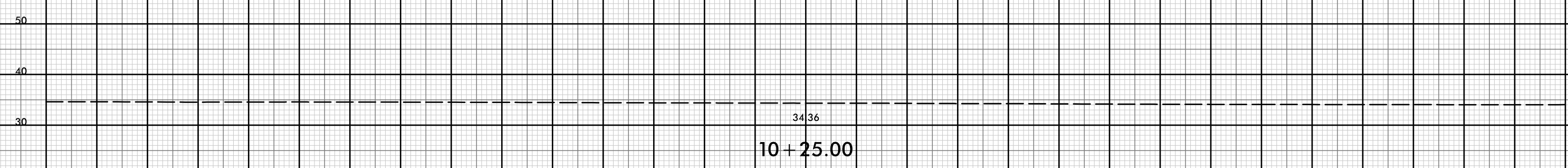
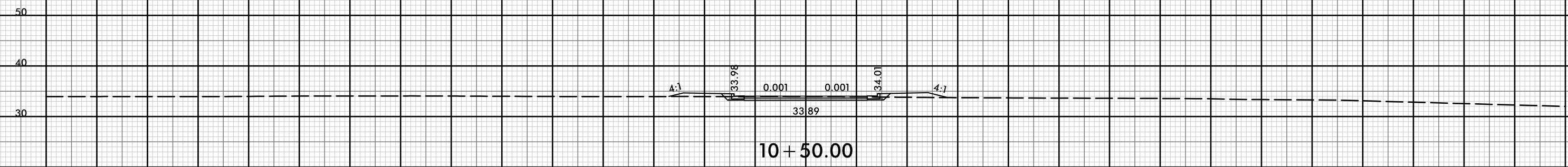
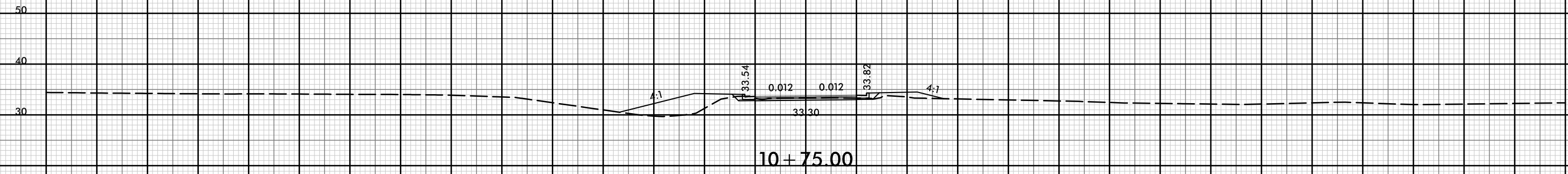

-Y14B-

150 140 130 120 110 100 90 80 70 60 50 40 30 20 10 0 10 20 30 40 50 60 70 80 90 100 110 120 130 140 150

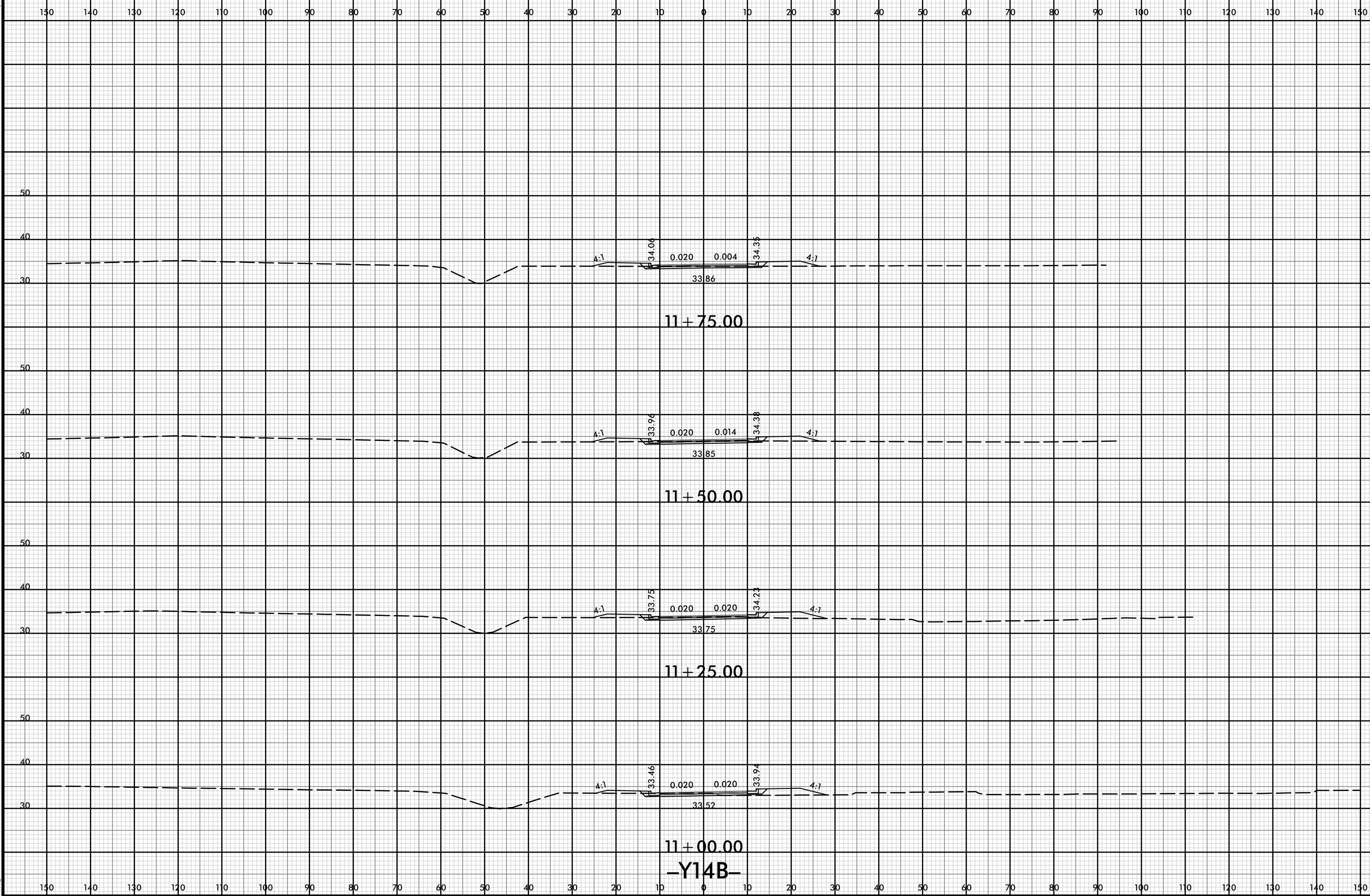



150 140 130 120 110 100 90 80 70 60 50 40 30 20 10 0 10 20 30 40 50 60 70 80 90 100 110 120 130 140 150

50 50

40 40

30 30

33.71
12 + 75.00

50 50

40 40

30 30

33.97
12 + 50.00

50 50

40 40

30 30

34.29
12 + 25.00

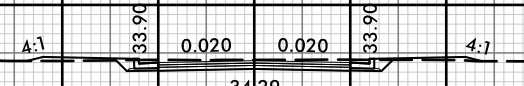

50 50

40 40

30 30

33.93
12 + 00.00

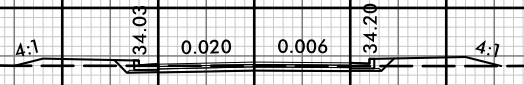

-Y14B-

150 140 130 120 110 100 90 80 70 60 50 40 30 20 10 0 10 20 30 40 50 60 70 80 90 100 110 120 130 140 150



150 140 130 120 110 100 90 80 70 60 50 40 30 20 10 0 10 20 30 40 50 60 70 80 90 100 110 120 130 140 150

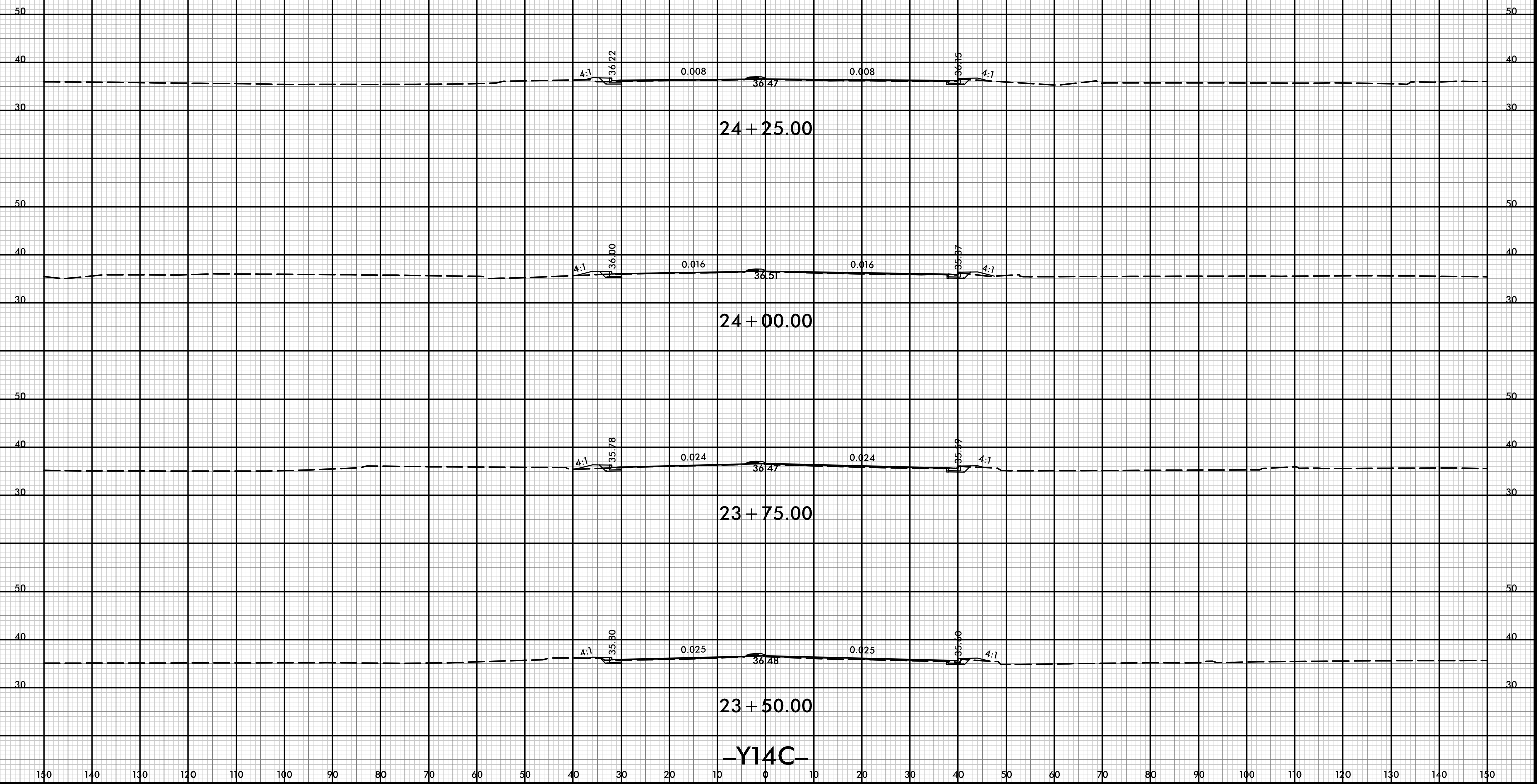

24 + 25.00

24 + 00.00

23 + 75.00

23 + 50.00

-Y14C-



150 140 130 120 110 100 90 80 70 60 50 40 30 20 10 0 10 20 30 40 50 60 70 80 90 100 110 120 130 140 150

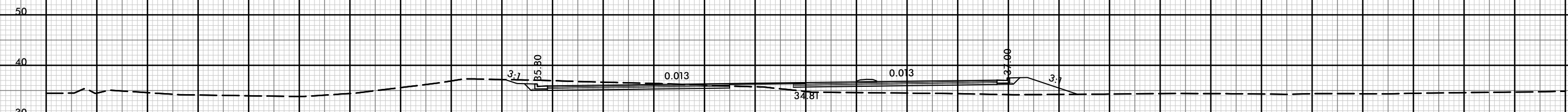

11 + 50.00

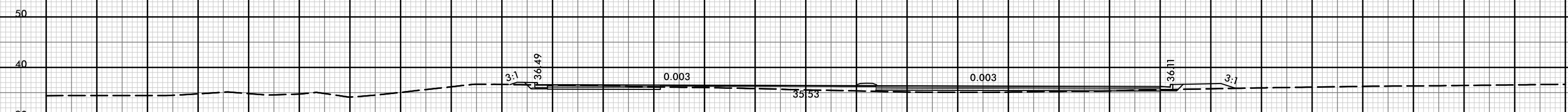

11 + 00.00

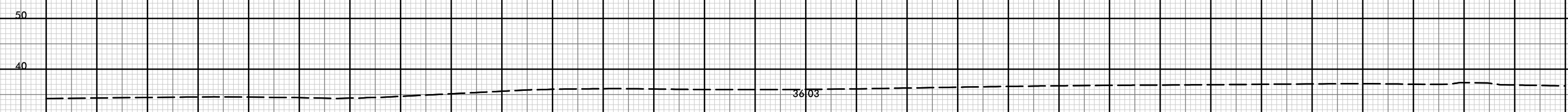

10 + 50.00

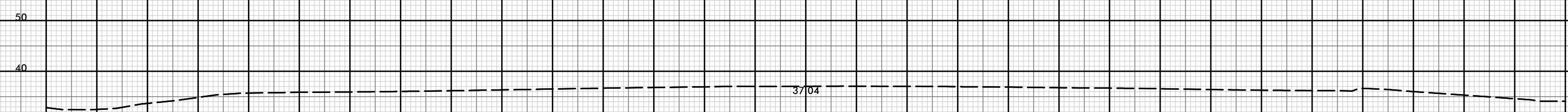

10 + 00.00

-Y14D-

150 140 130 120 110 100 90 80 70 60 50 40 30 20 10 0 10 20 30 40 50 60 70 80 90 100 110 120 130 140 150



150 140 130 120 110 100 90 80 70 60 50 40 30 20 10 0 10 20 30 40 50 60 70 80 90 100 110 120 130 140 150

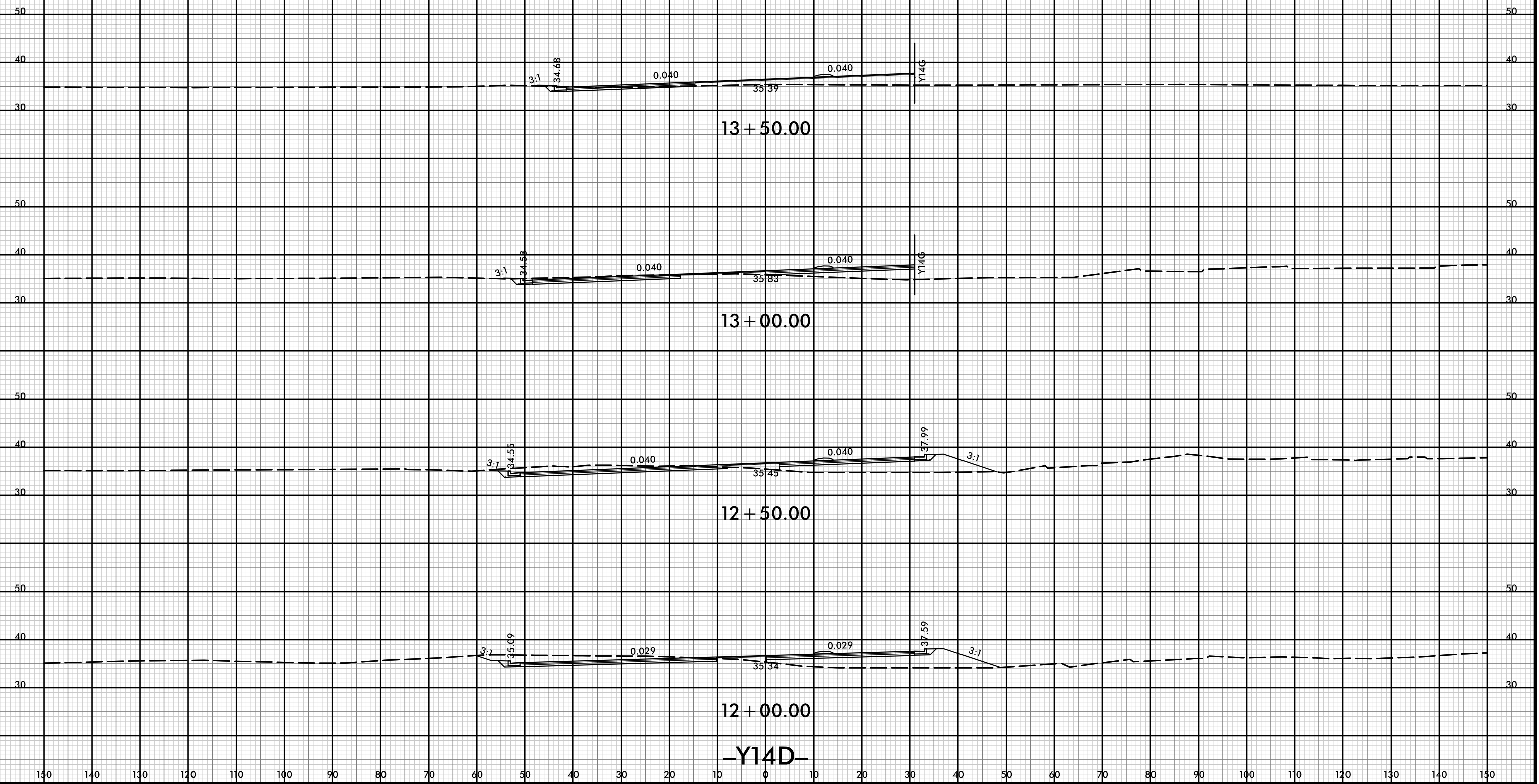

13 + 50.00

13 + 00.00

12 + 50.00

12 + 00.00

-Y14D-



150 140 130 120 110 100 90 80 70 60 50 40 30 20 10 0 10 20 30 40 50 60 70 80 90 100 110 120 130 140 150

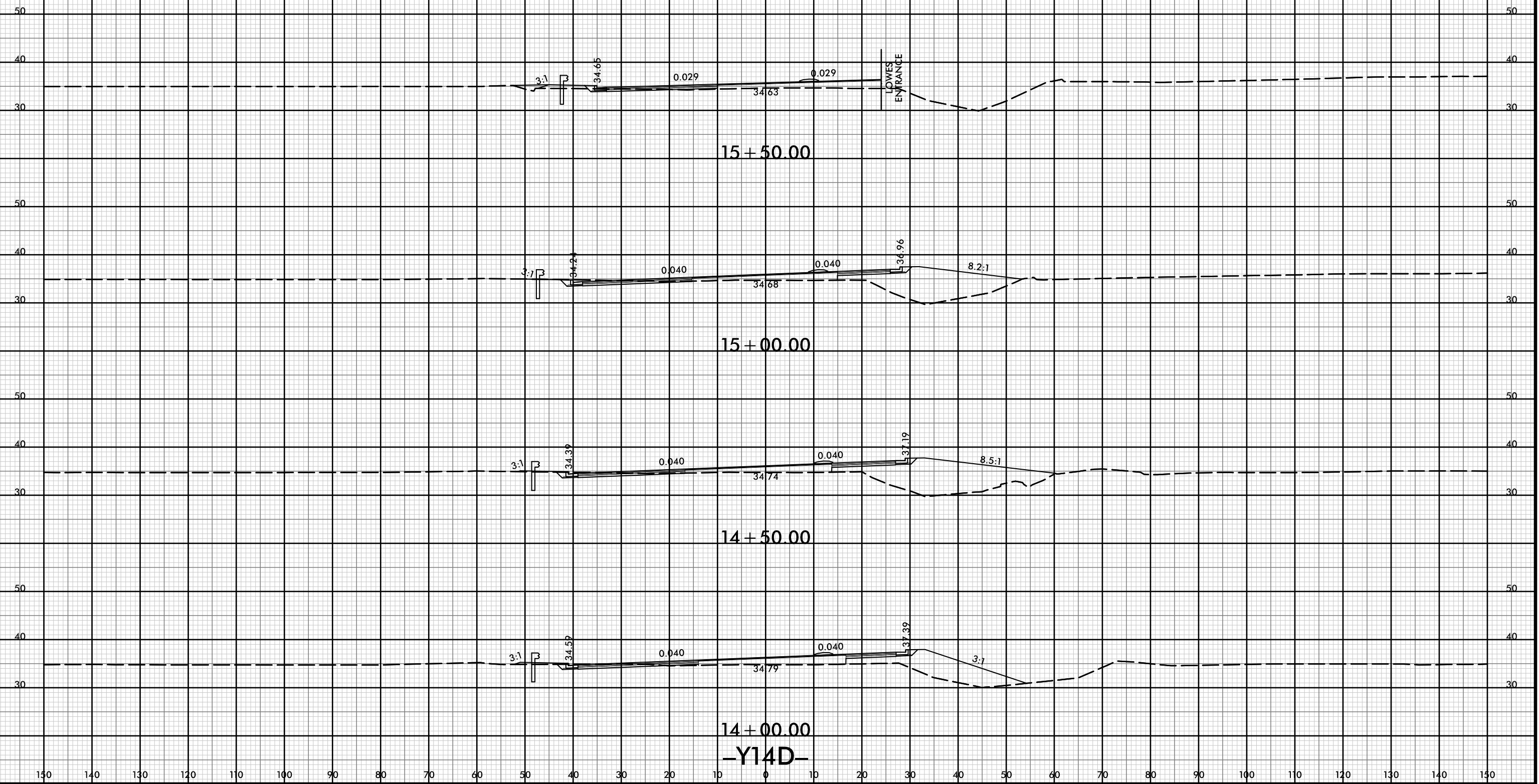

15 + 50.00

15 + 00.00

14 + 50.00

14 + 00.00

-Y14D-

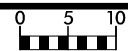

150 140 130 120 110 100 90 80 70 60 50 40 30 20 10 0 10 20 30 40 50 60 70 80 90 100 110 120 130 140 150

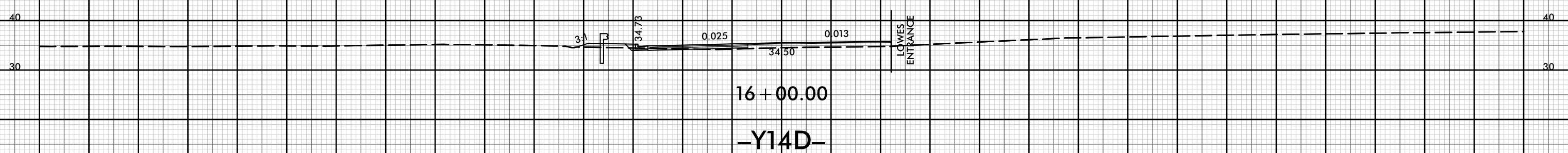
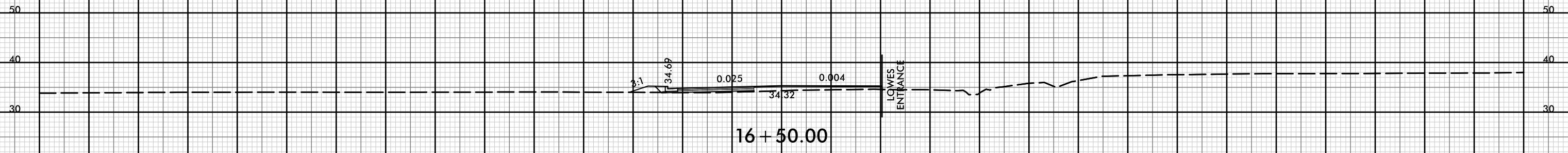
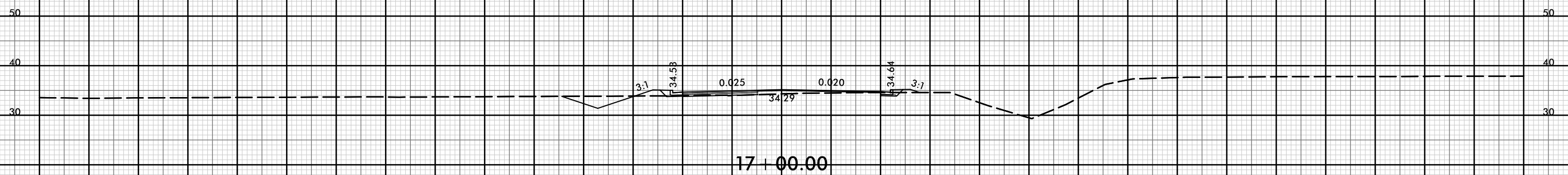
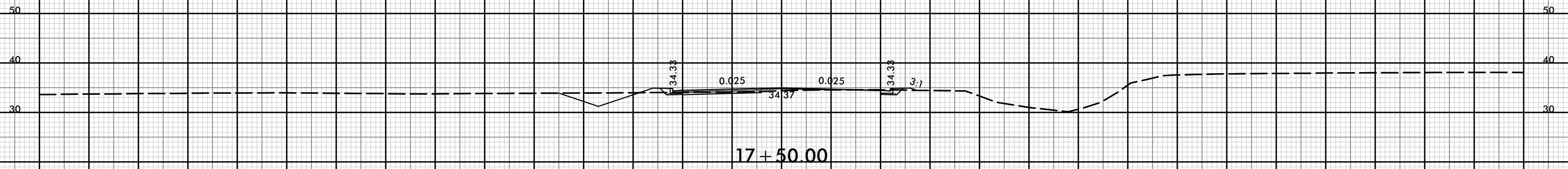

-Y14D-

150 140 130 120 110 100 90 80 70 60 50 40 30 20 10 0 10 20 30 40 50 60 70 80 90 100 110 120 130 140 150



150 140 130 120 110 100 90 80 70 60 50 40 30 20 10 0 10 20 30 40 50 60 70 80 90 100 110 120 130 140 150

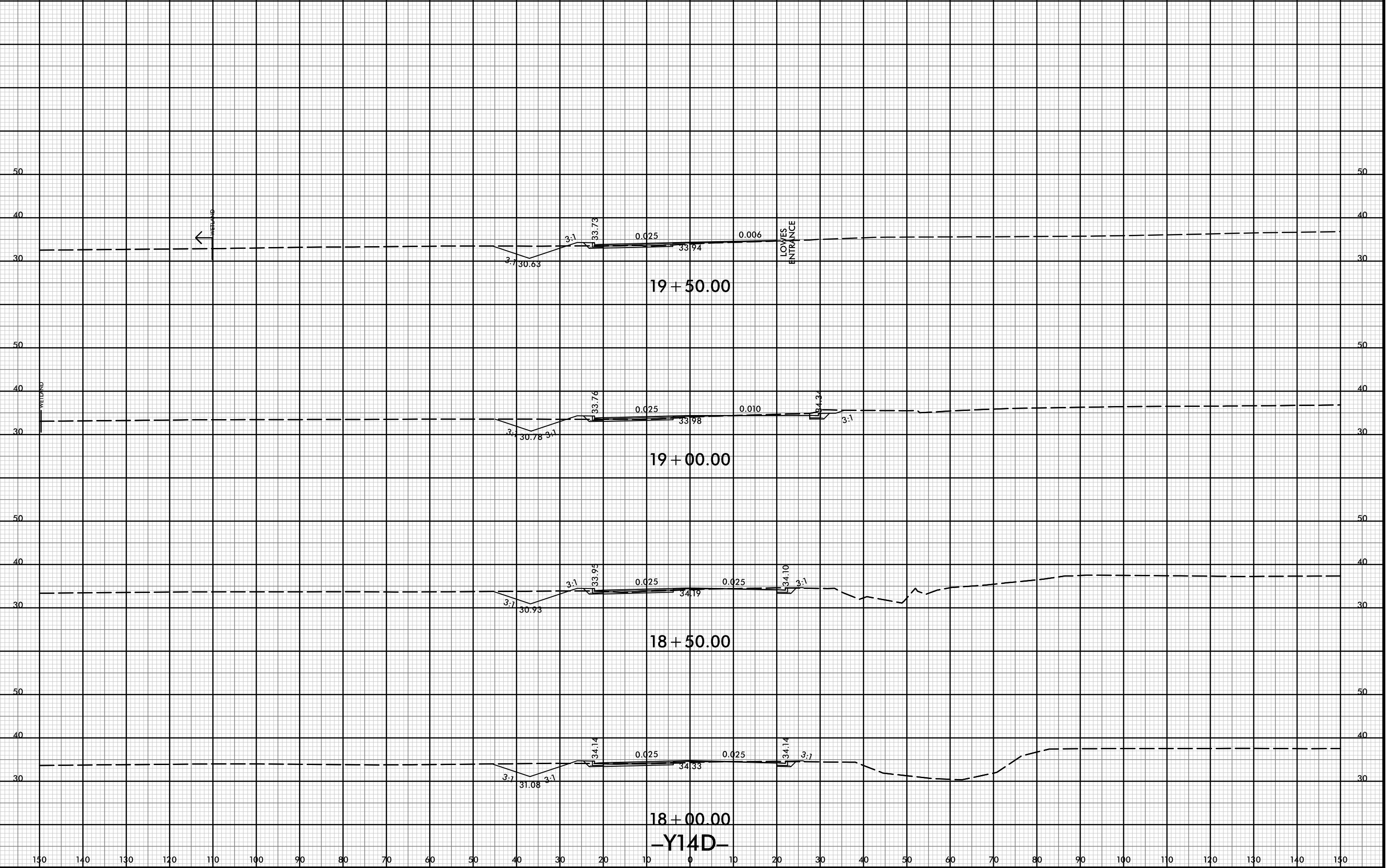

18+00.00
-Y14D-

150 140 130 120 110 100 90 80 70 60 50 40 30 20 10 0 10 20 30 40 50 60 70 80 90 100 110 120 130 140 150

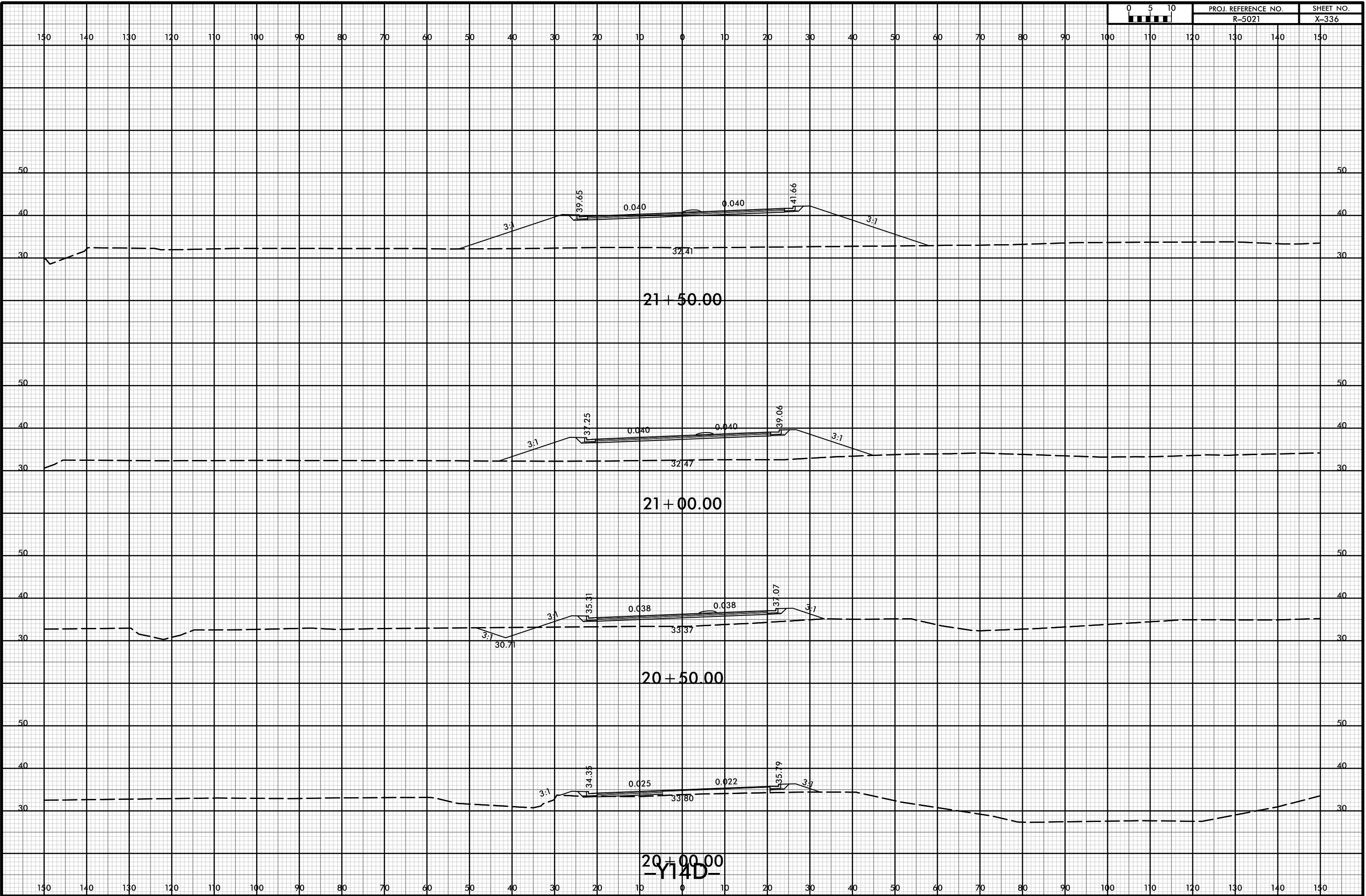

21 + 50.00

21 + 00.00

20 + 50.00

20 + 00.00

Y14D

150 140 130 120 110 100 90 80 70 60 50 40 30 20 10 0 10 20 30 40 50 60 70 80 90 100 110 120 130 140 150

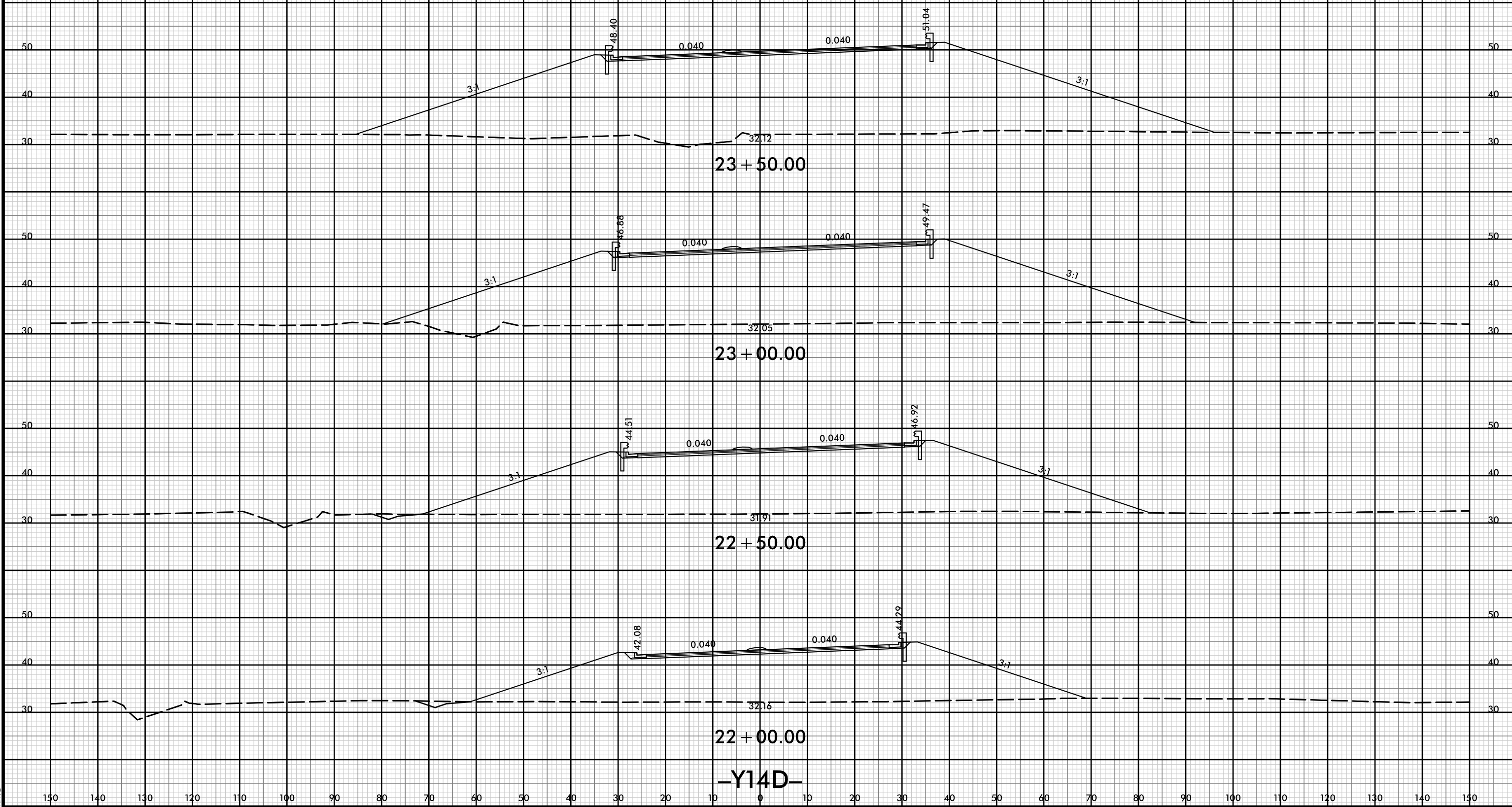

-Y14D-



150 140 130 120 110 100 90 80 70 60 50 40 30 20 10 0 10 20 30 40 50 60 70 80 90 100 110 120 130 140 150

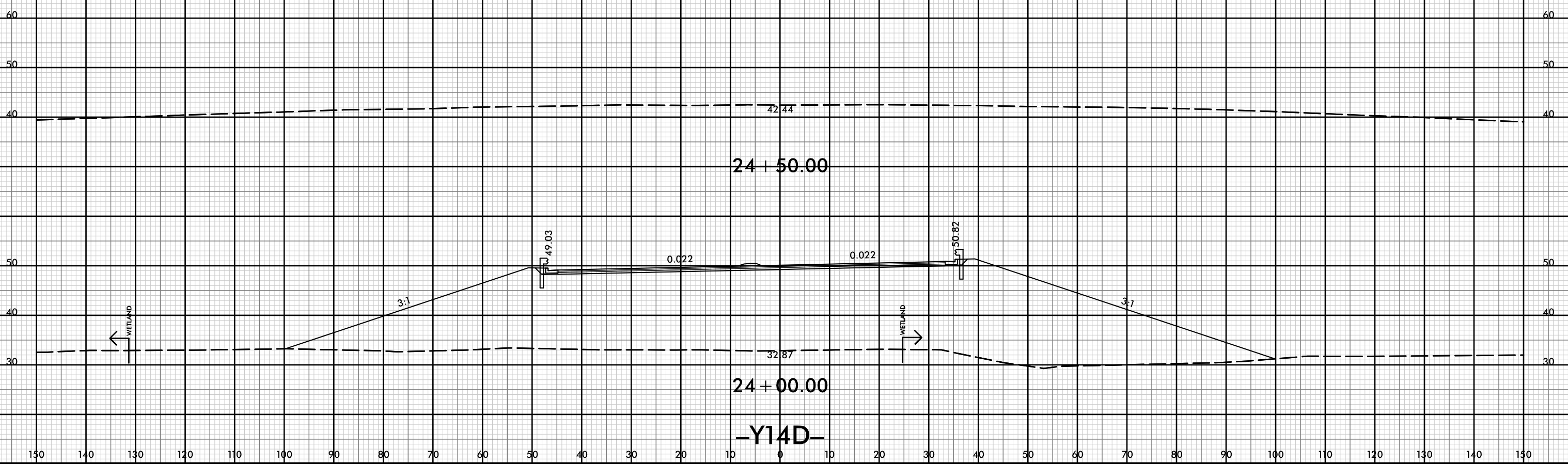

150 140 130 120 110 100 90 80 70 60 50 40 30 20 10 0 10 20 30 40 50 60 70 80 90 100 110 120 130 140 150

8/23/99



PROJ. REFERENCE NO.
R-5021

SHEET NO.
X-339

150 140 130 120 110 100 90 80 70 60 50 40 30 20 10 0 10 20 30 40 50 60 70 80 90 100 110 120 130 140 150

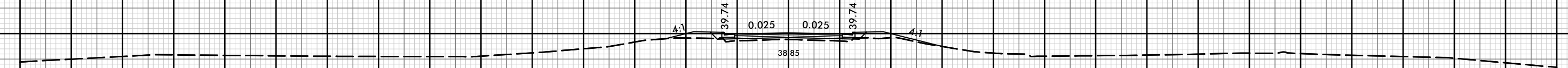

10 + 50.00

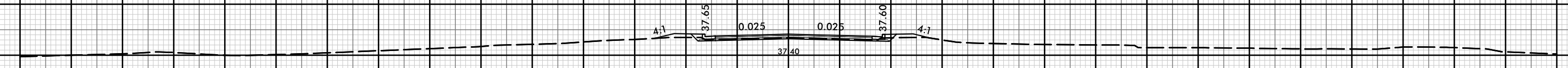

10 + 25.00

-Y14E-

150 140 130 120 110 100 90 80 70 60 50 40 30 20 10 0 10 20 30 40 50 60 70 80 90 100 110 120 130 140 150

27-OCT-2021 15:52
\\P01dwa\XSC\5021-rdy-xp-l-Y14E.dgn

8/23/99



PROJ. REFERENCE NO.	SHEET NO.
R-5021	X-340

150 140 130 120 110 100 90 80 70 60 50 40 30 20 10 0 10 20 30 40 50 60 70 80 90 100 110 120 130 140 150

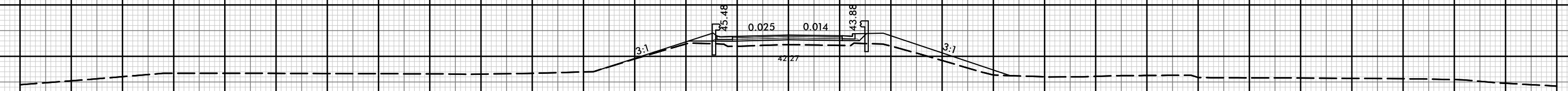

11 + 00.00

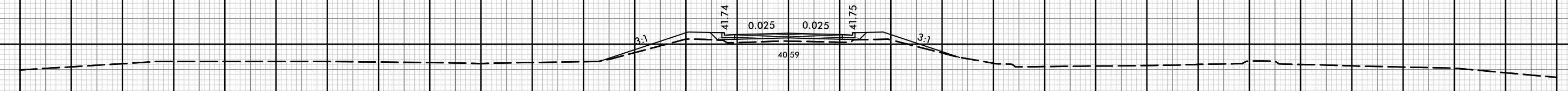

10 + 75.00
-Y14E-

150 140 130 120 110 100 90 80 70 60 50 40 30 20 10 0 10 20 30 40 50 60 70 80 90 100 110 120 130 140 150

27-OCT-2021 15:52
\\P01dwa\XSC\5021-rdy-yp-l-Y14E.dgn

8/23/99



PROJ. REFERENCE NO.	SHEET NO.
R-5021	X-400

150 140 130 120 110 100 90 80 70 60 50 40 30 20 10 0 10 20 30 40 50 60 70 80 90 100 110 120 130 140 150

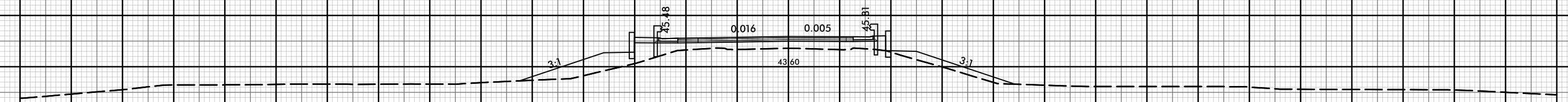

11+25.00

-Y14E-

150 140 130 120 110 100 90 80 70 60 50 40 30 20 10 0 10 20 30 40 50 60 70 80 90 100 110 120 130 140 150

27-OCT-2021 15:52
 R:\p\dwg\XSC\5021-rdy-yp-l-Y14E.dgn
 HNTB



150 140 130 120 110 100 90 80 70 60 50 40 30 20 10 0 10 20 30 40 50 60 70 80 90 100 110 120 130 140 150

50 50

40 40

30 30

10 + 75.00

33.52

50 50

40 40

30 30

10 + 50.00

33.40

50 50

40 40

30 30

10 + 25.00

33.32

50 50

40 40

30 30

10 + 00.00

33.28

-Y14F-



150 140 130 120 110 100 90 80 70 60 50 40 30 20 10 0 10 20 30 40 50 60 70 80 90 100 110 120 130 140 150

150 140 130 120 110 100 90 80 70 60 50 40 30 20 10 0 10 20 30 40 50 60 70 80 90 100 110 120 130 140 150

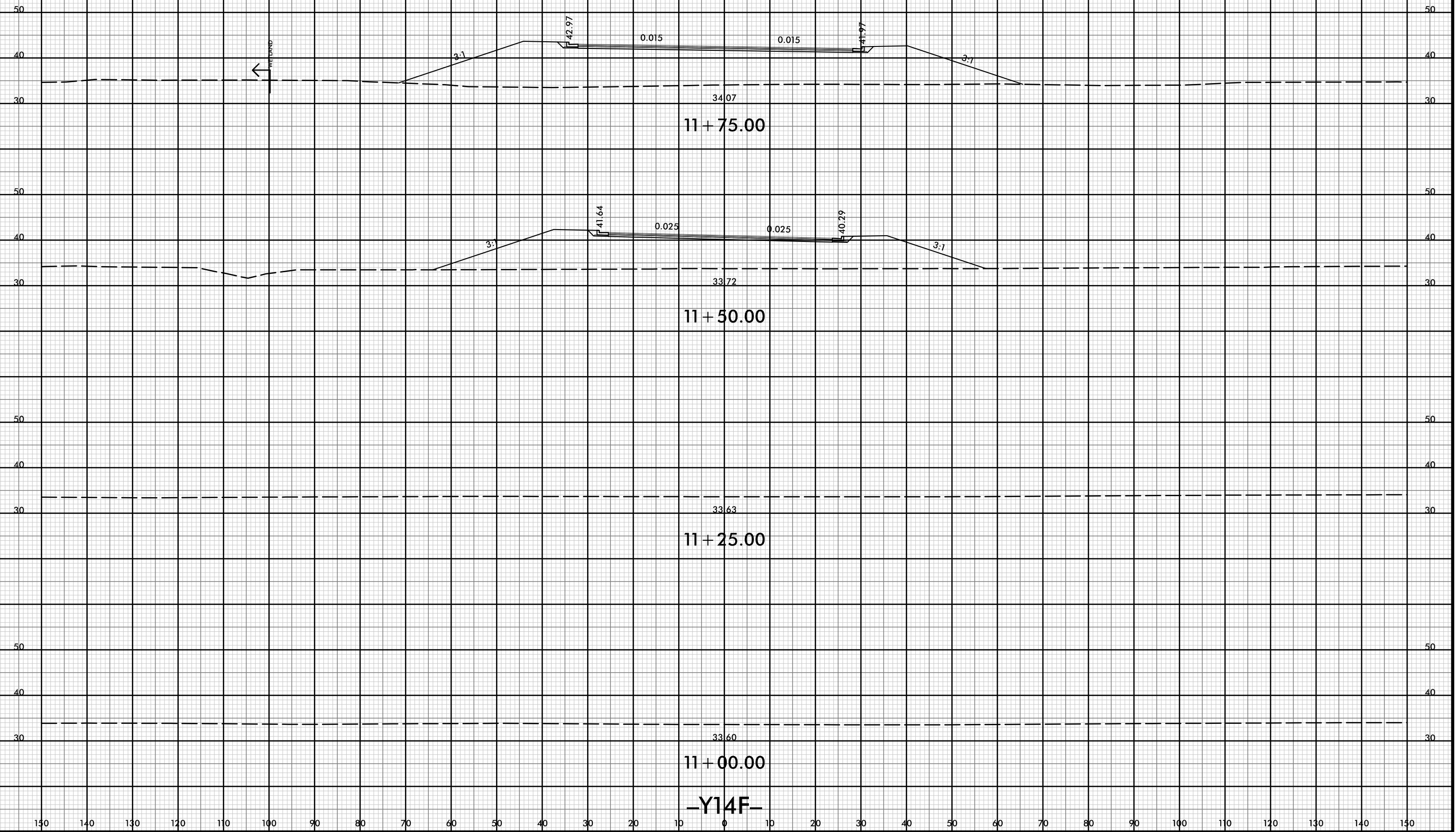



150 140 130 120 110 100 90 80 70 60 50 40 30 20 10 0 10 20 30 40 50 60 70 80 90 100 110 120 130 140 150

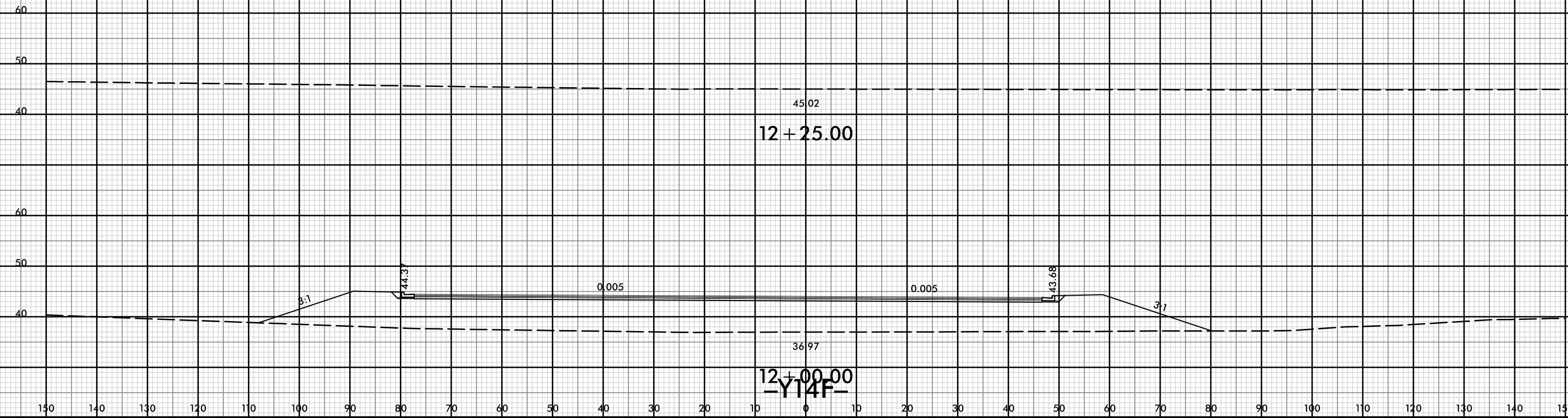

8/23/99



PROJ. REFERENCE NO. R-5021	SHEET NO. X-345
-------------------------------	--------------------

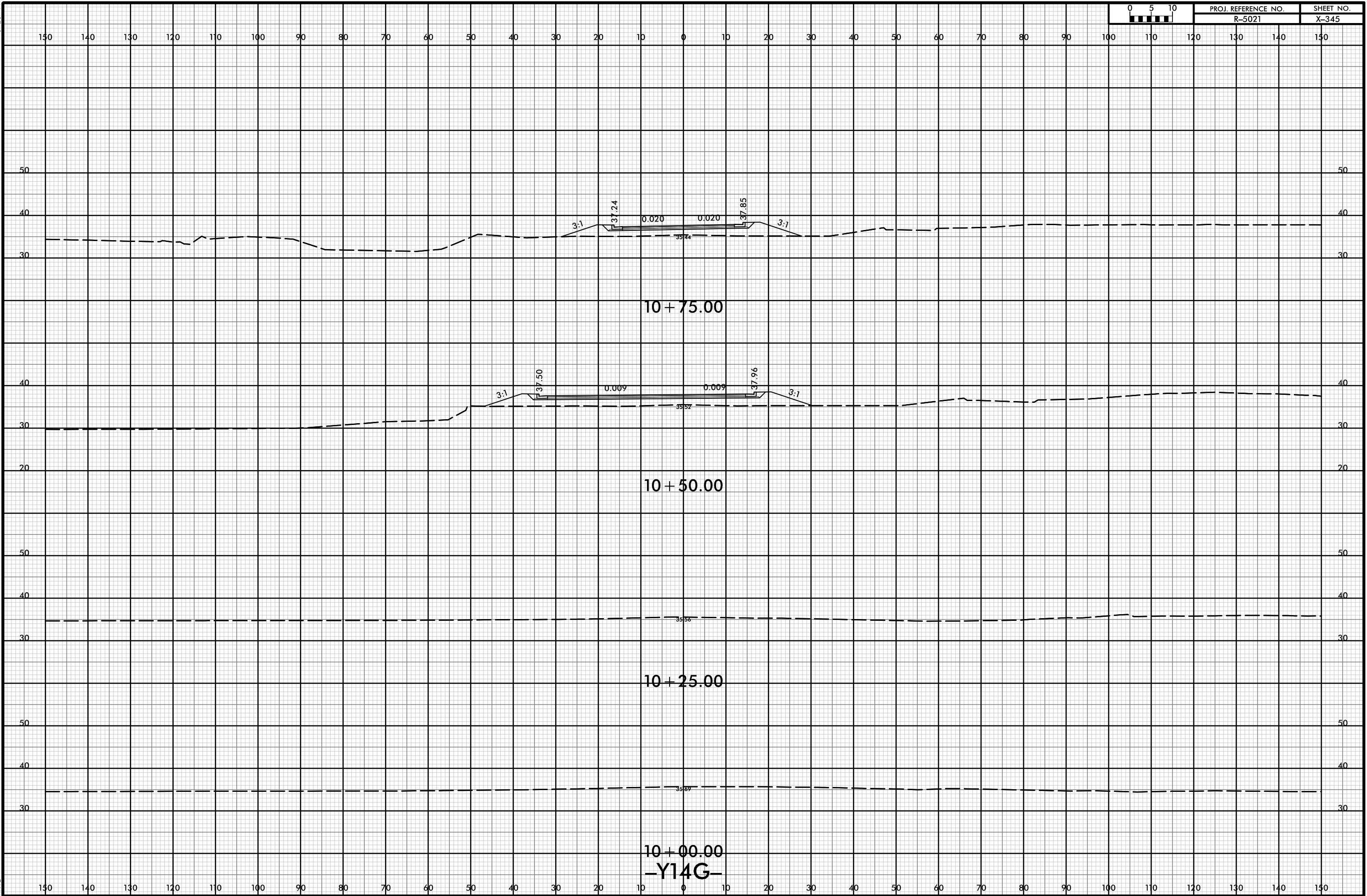

21-JUL-2021 10:39
R:\p\dawej\XSCA\5021-rdy-yp-l-Y14G.dgn
HTB



150 140 130 120 110 100 90 80 70 60 50 40 30 20 10 0 10 20 30 40 50 60 70 80 90 100 110 120 130 140 150

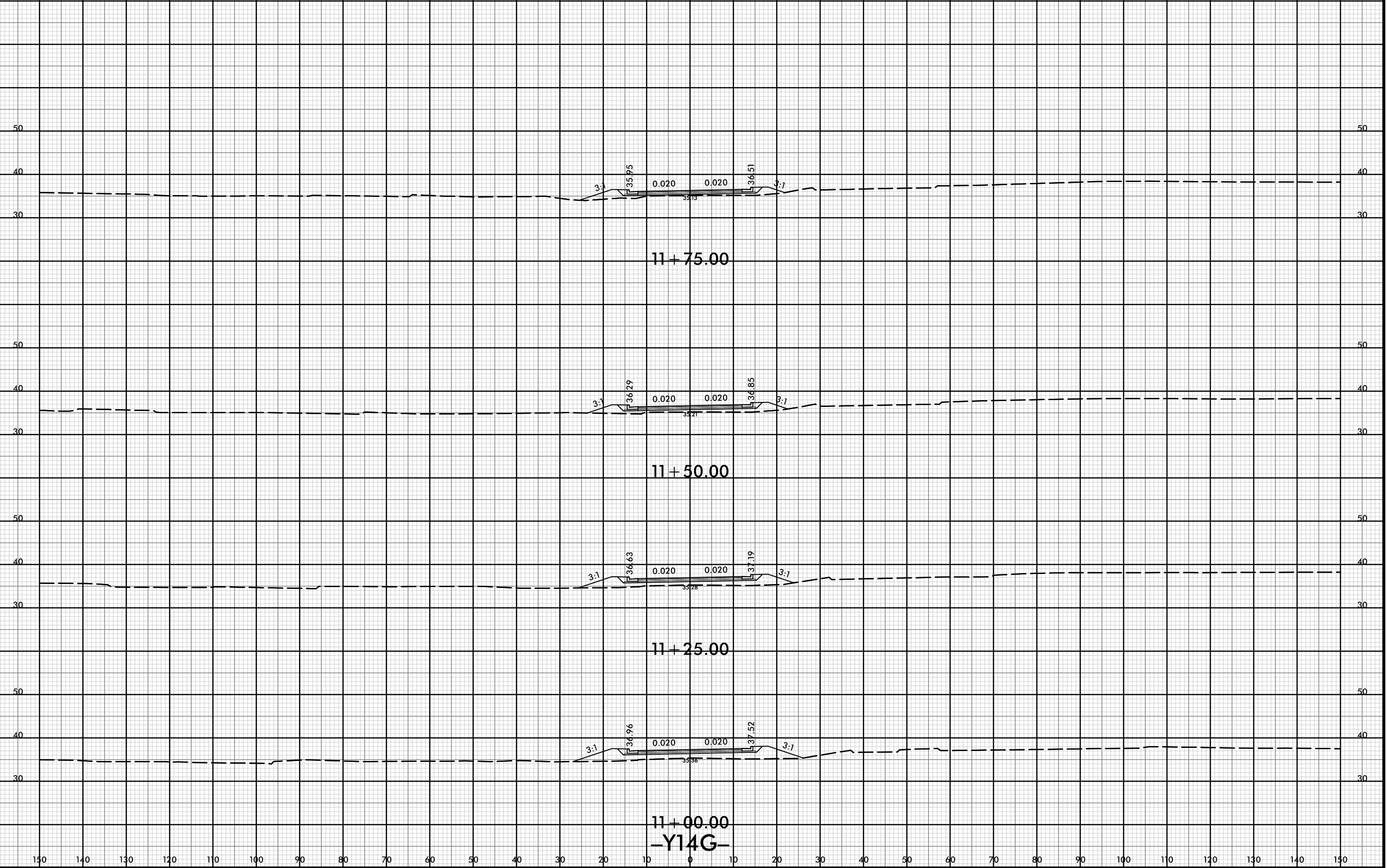

11+75.00

11+50.00

11+25.00

11+00.00

-Y14G-



150 140 130 120 110 100 90 80 70 60 50 40 30 20 10 0 10 20 30 40 50 60 70 80 90 100 110 120 130 140 150

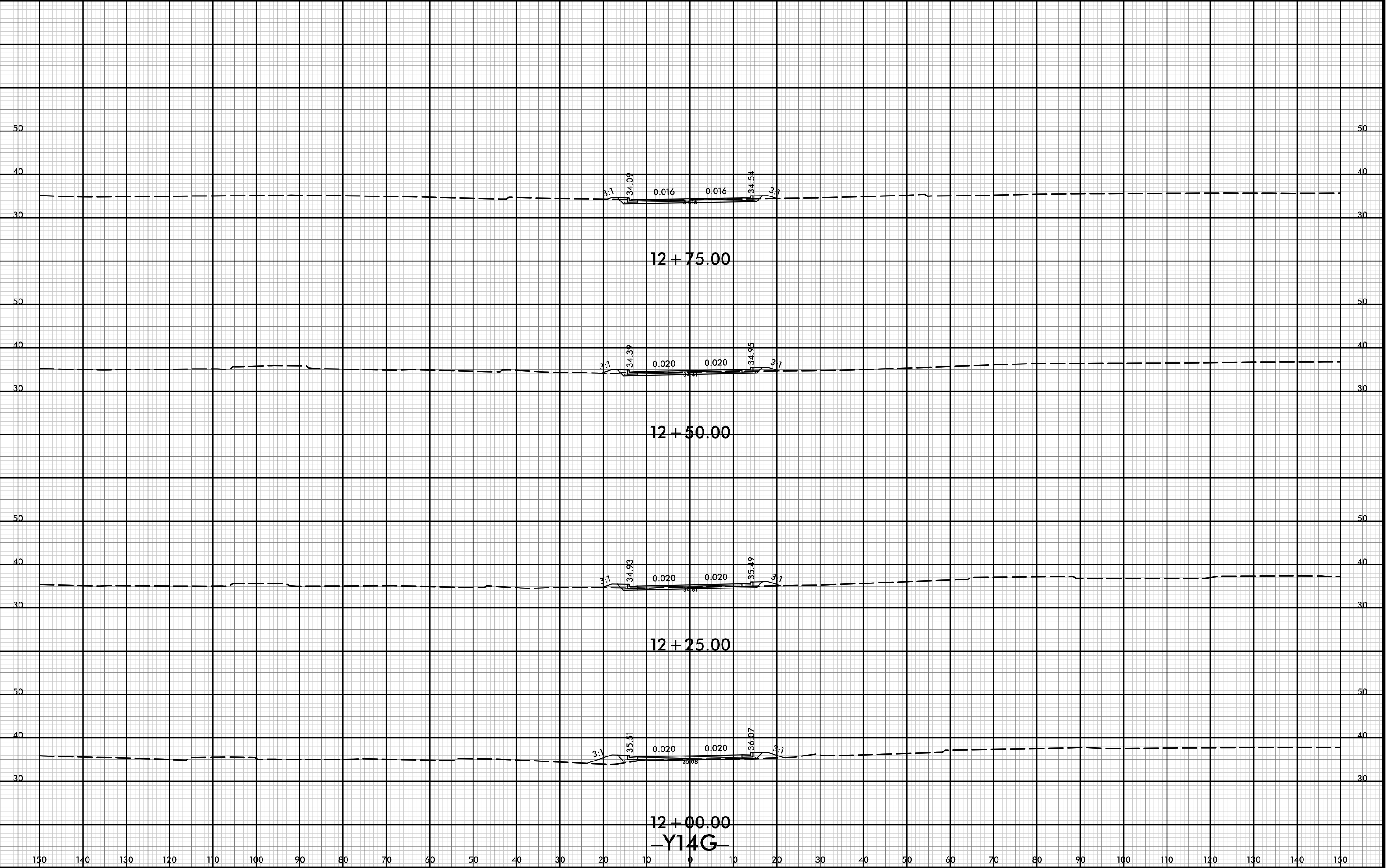

150 140 130 120 110 100 90 80 70 60 50 40 30 20 10 0 10 20 30 40 50 60 70 80 90 100 110 120 130 140 150

8/23/99



PROJ. REFERENCE NO. R-5021	SHEET NO. X-348
-------------------------------	--------------------

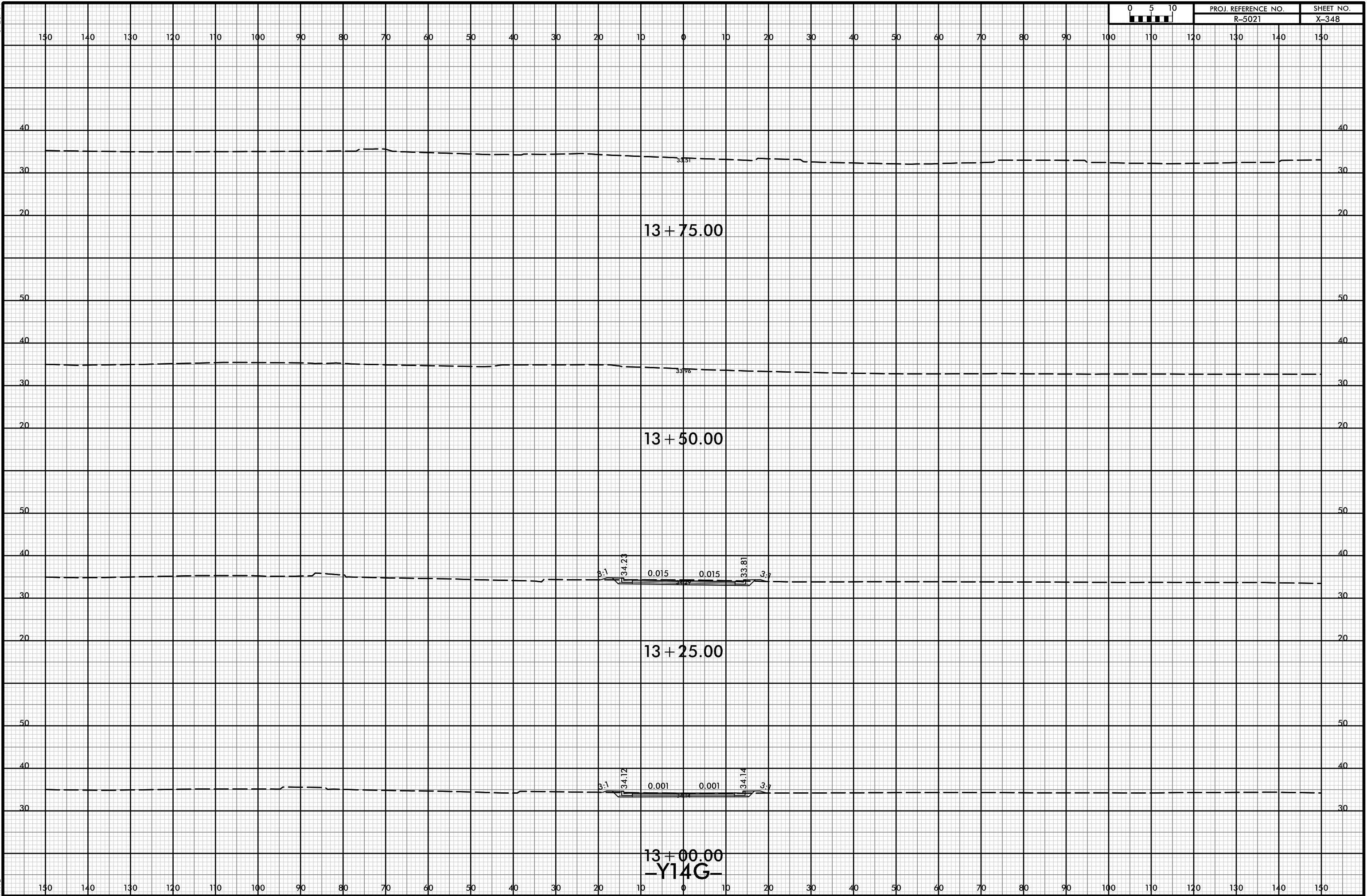

21-Jul-2021 10:39
 R:\p\dawej\XSCA\5021-rdy-yp-l-Y14G.dgn
 HNTB

13+00.00
 -Y14G-



150 140 130 120 110 100 90 80 70 60 50 40 30 20 10 0 10 20 30 40 50 60 70 80 90 100 110 120 130 140 150

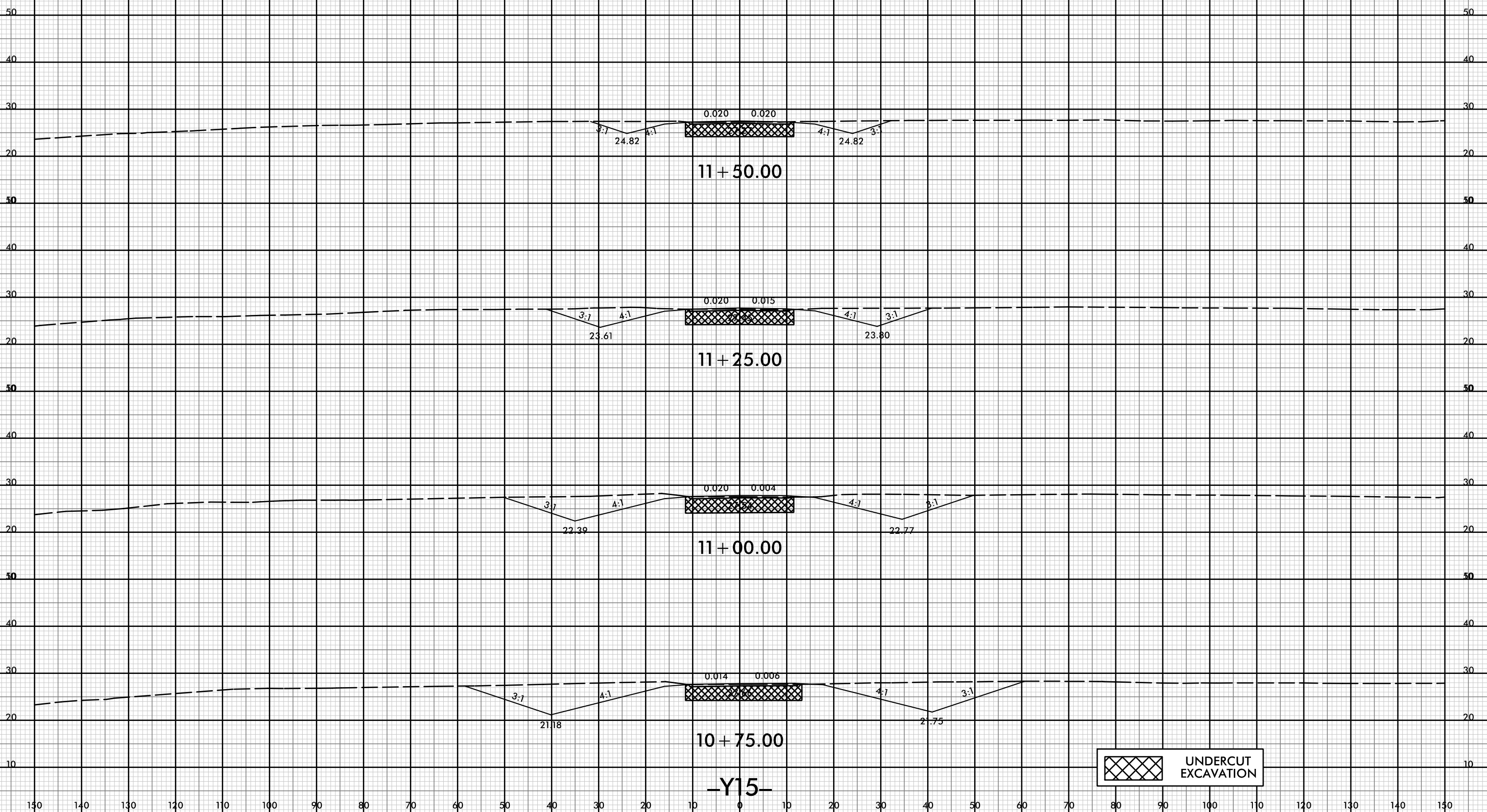

 UNDERCUT EXCAVATION

-Y15-



150 140 130 120 110 100 90 80 70 60 50 40 30 20 10 0 10 20 30 40 50 60 70 80 90 100 110 120 130 140 150

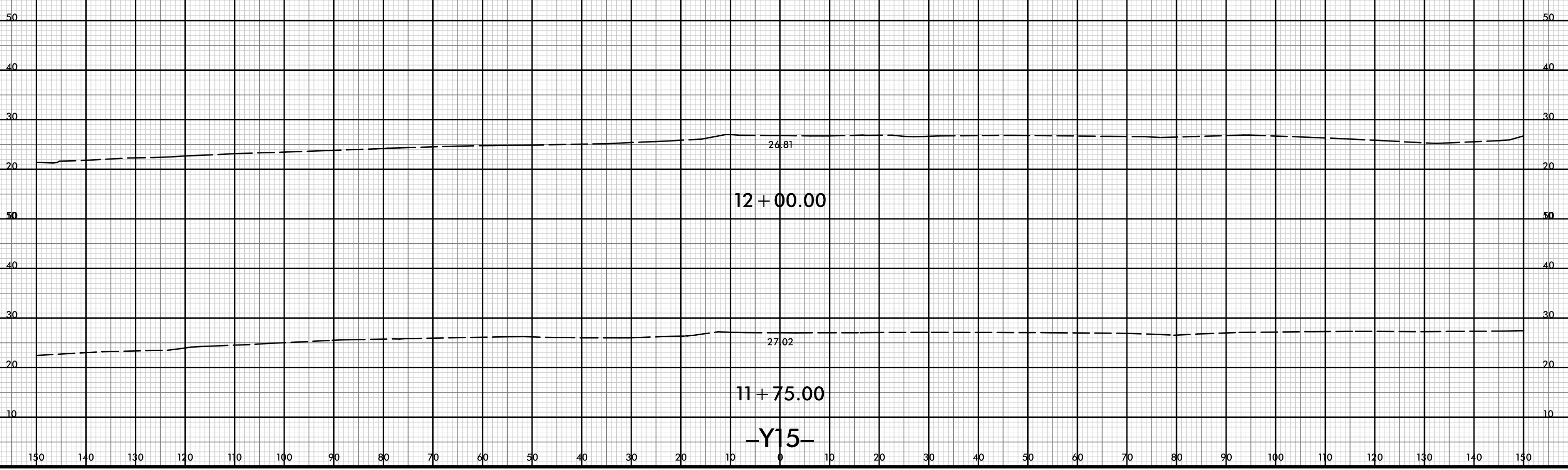



150 140 130 120 110 100 90 80 70 60 50 40 30 20 10 0 10 20 30 40 50 60 70 80 90 100 110 120 130 140 150

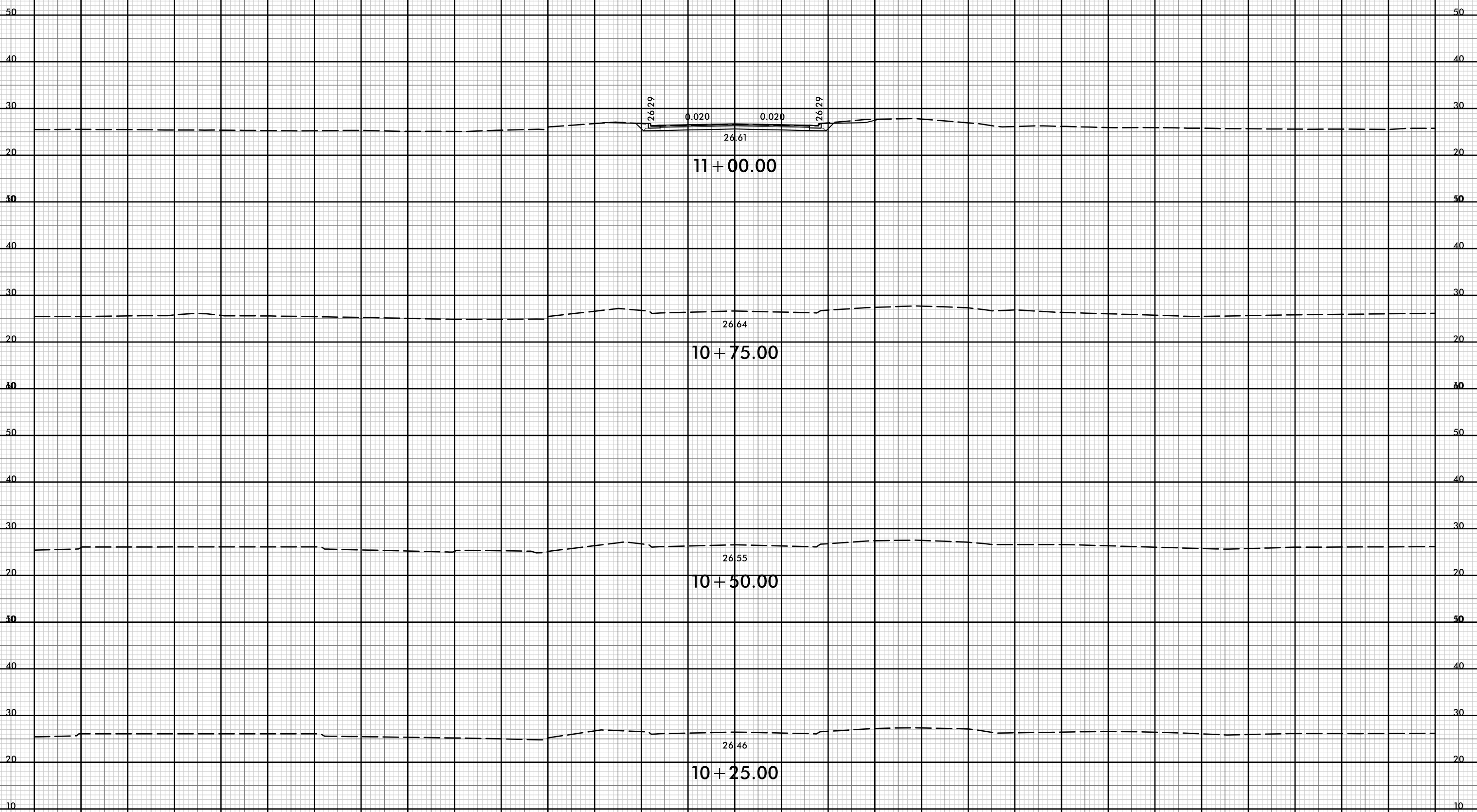

-Y16-



150 140 130 120 110 100 90 80 70 60 50 40 30 20 10 0 10 20 30 40 50 60 70 80 90 100 110 120 130 140 150

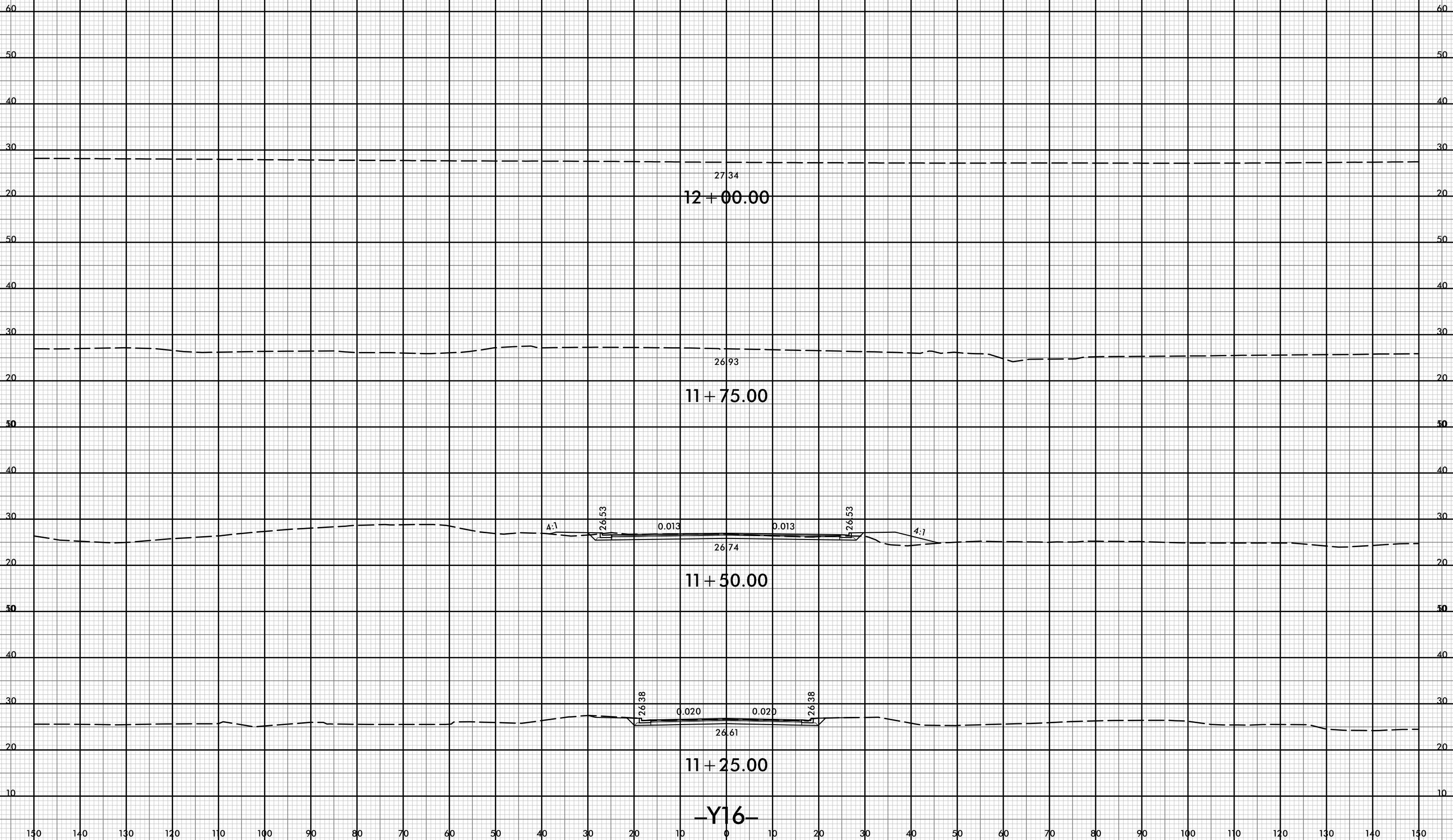

27.34
12 + 00.00

26.93
11 + 75.00

26.74
11 + 50.00

26.61
11 + 25.00

-Y16-

4:1 26.53 0.013 0.013 26.53 4:1

26.38 0.020 0.020 26.38

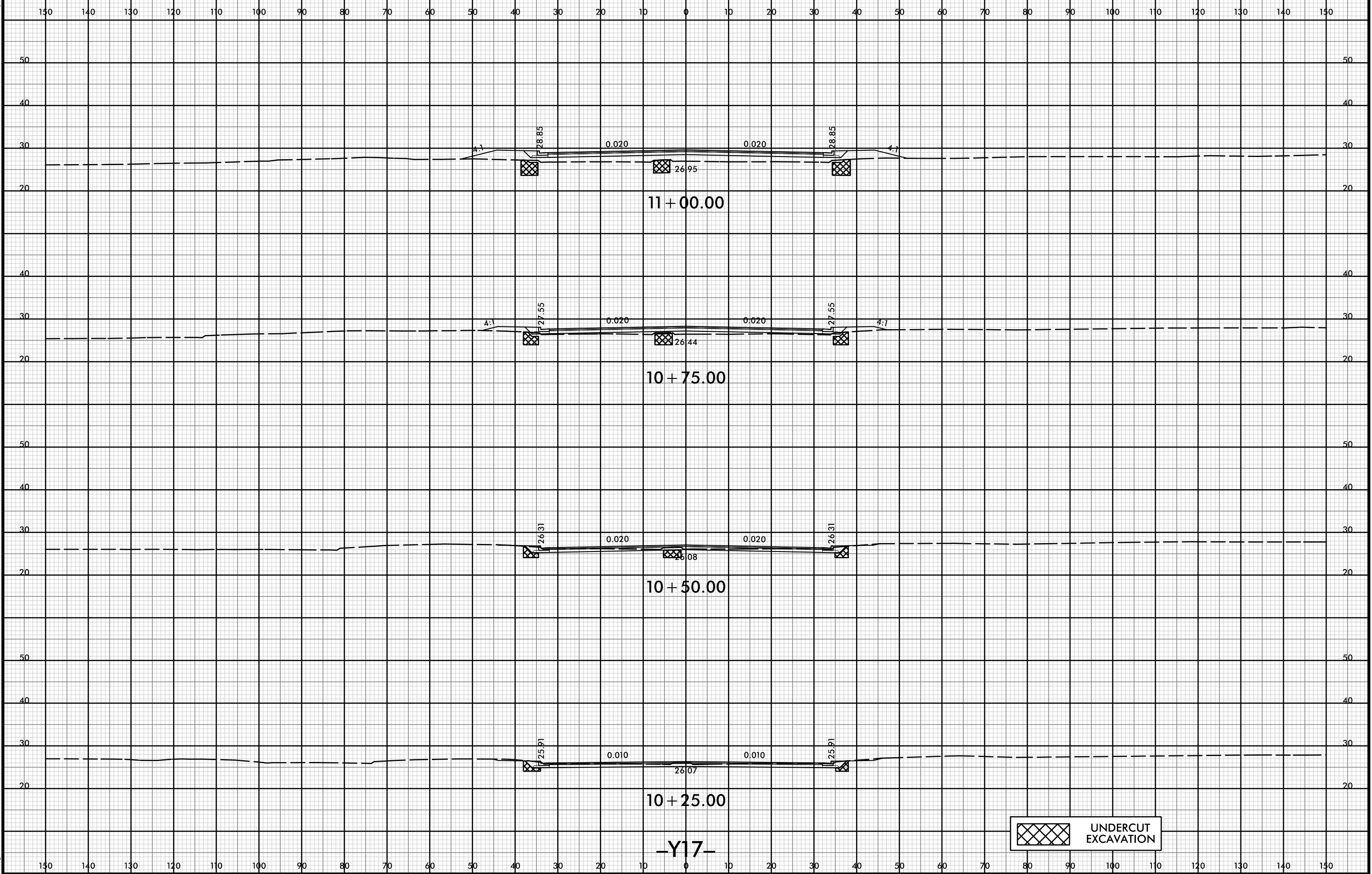

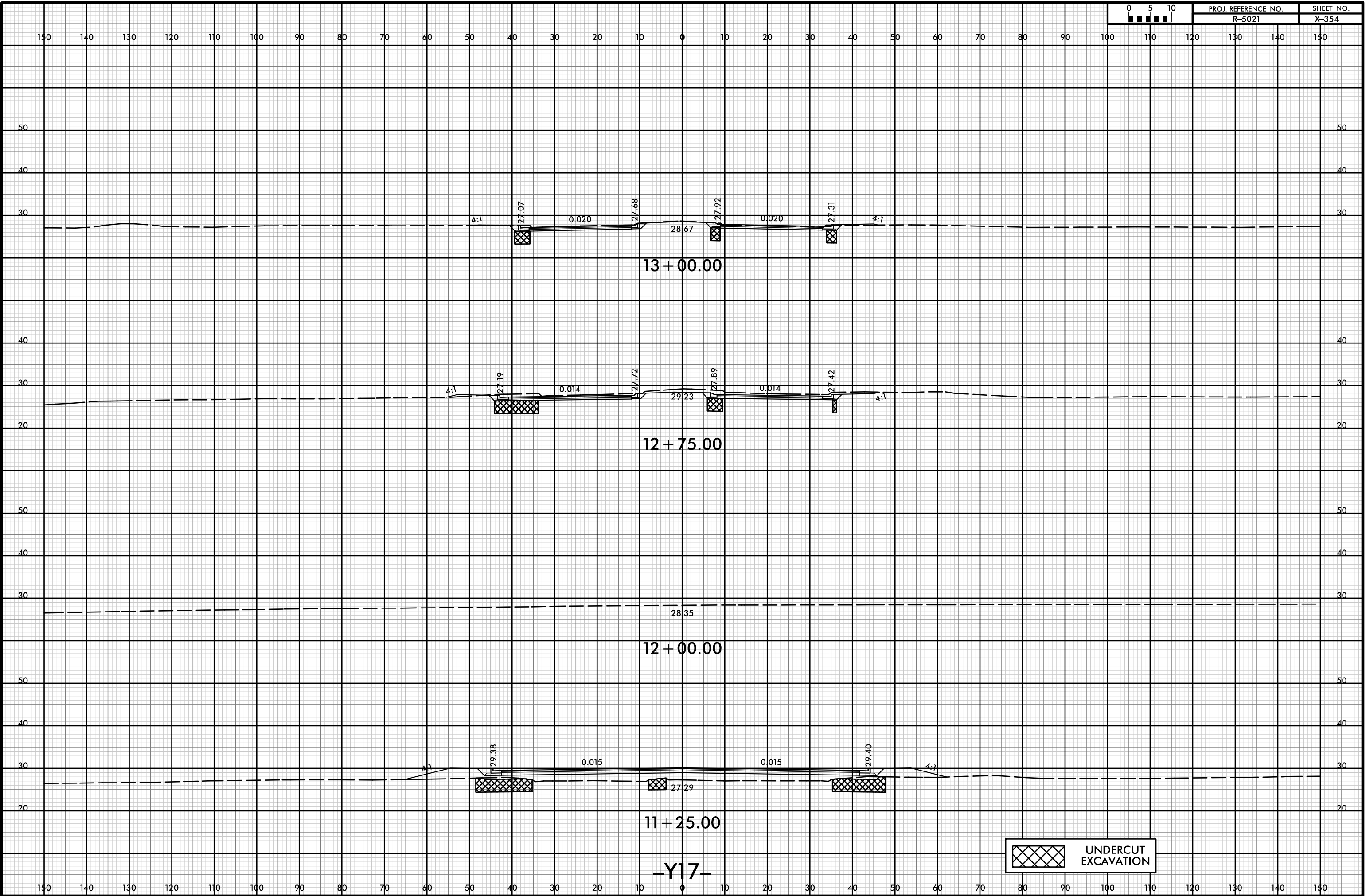

 UNDERCUT EXCAVATION

8/23/99



PROJ. REFERENCE NO.
R-5021

SHEET NO.
X-355

150 140 130 120 110 100 90 80 70 60 50 40 30 20 10 0 10 20 30 40 50 60 70 80 90 100 110 120 130 140 150

50 50

40 40

30 30

20 20

21-Jul-2021 10:39
R:\p\dawej\XSCA\5021-rdy-yp-l-Y17.dgn
HTB

26.55

0.020

27.41

27.88

27.63

0.020

27.00

4:1

13 + 25.00

-Y17-



UNDERCUT EXCAVATION

150 140 130 120 110 100 90 80 70 60 50 40 30 20 10 0 10 20 30 40 50 60 70 80 90 100 110 120 130 140 150



150 140 130 120 110 100 90 80 70 60 50 40 30 20 10 0 10 20 30 40 50 60 70 80 90 100 110 120 130 140 150

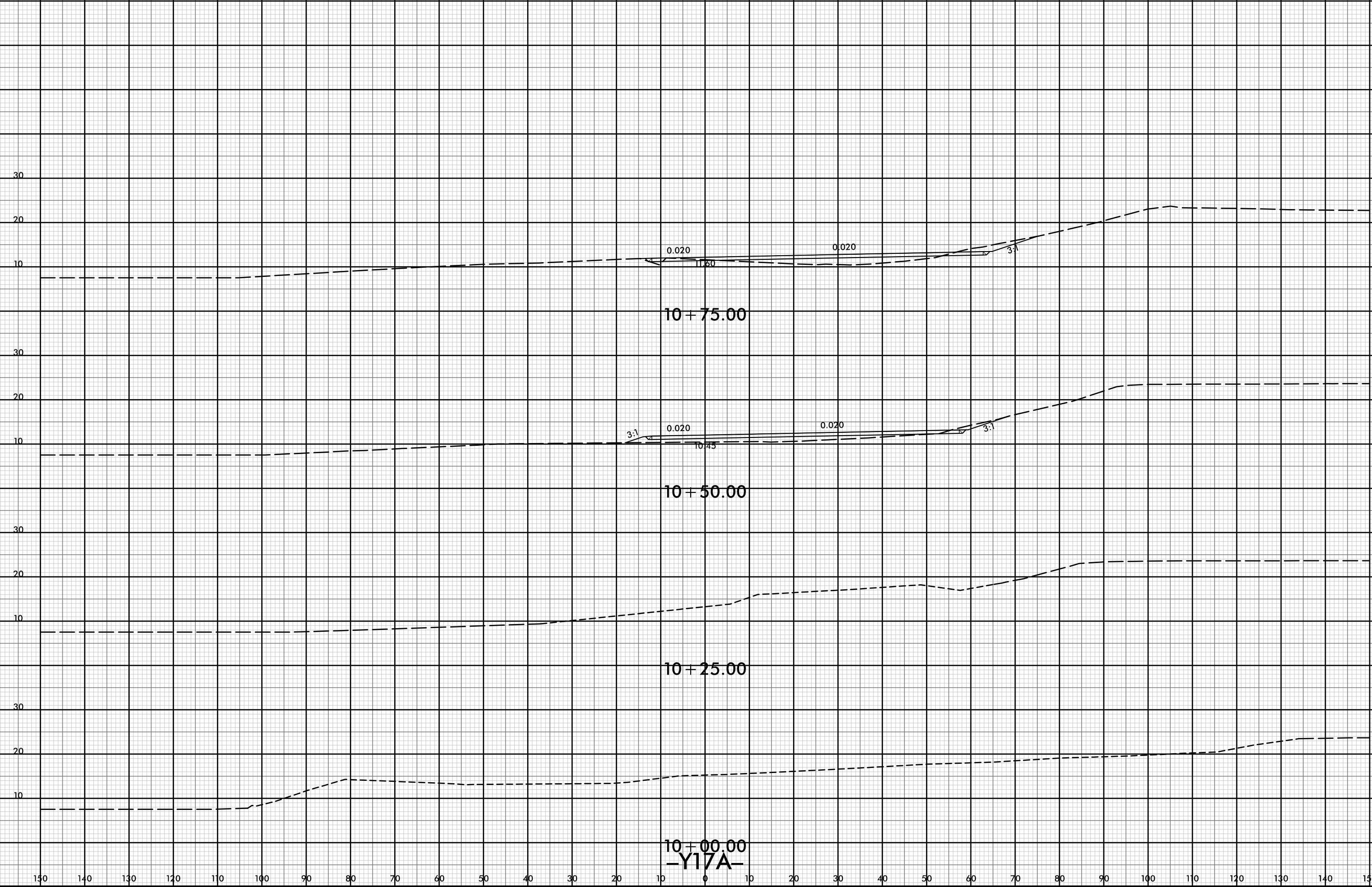

10+75.00

10+50.00

10+25.00

10+00.00

-Y17A-



150 140 130 120 110 100 90 80 70 60 50 40 30 20 10 0 10 20 30 40 50 60 70 80 90 100 110 120 130 140 150

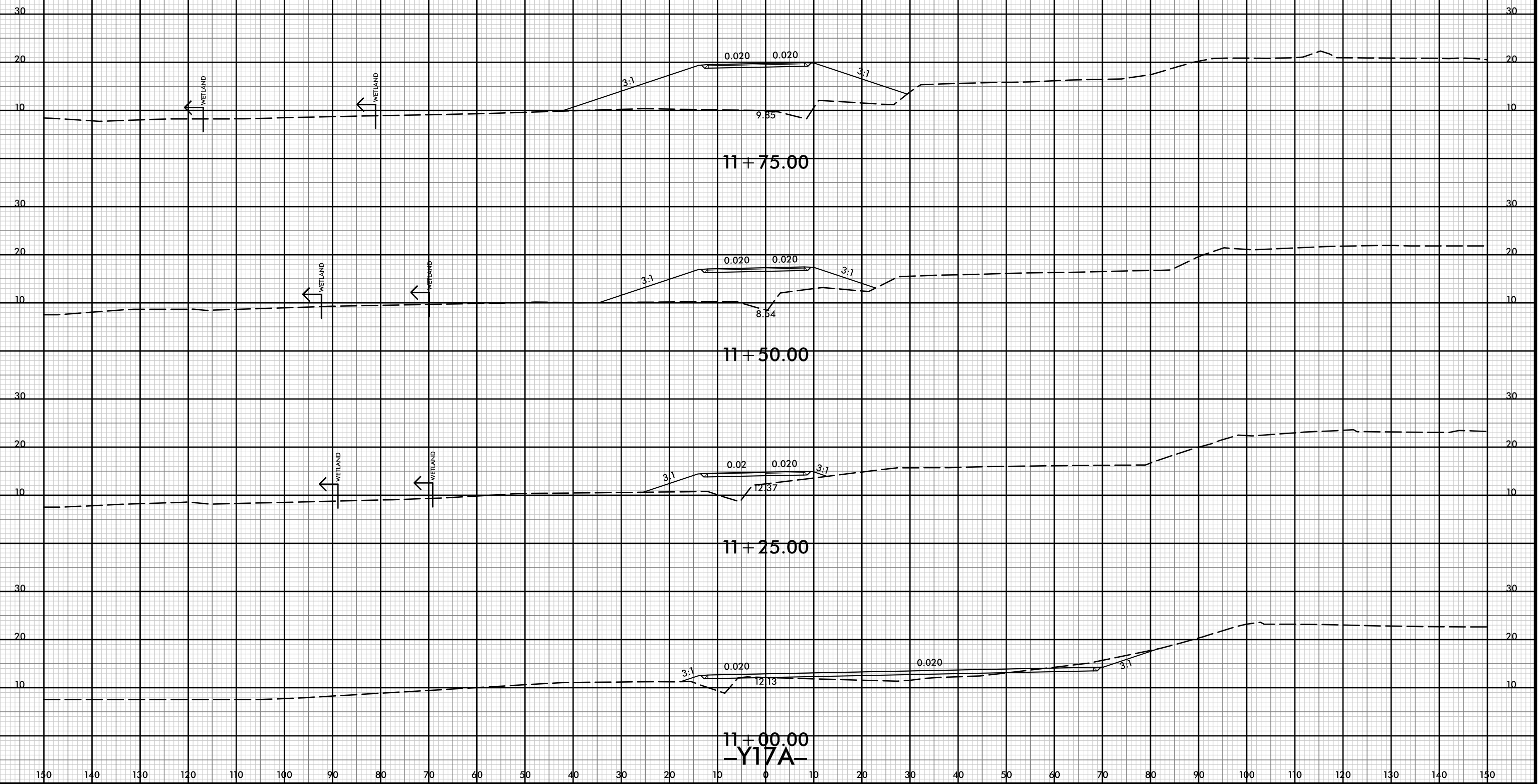

11+75.00

11+50.00

11+25.00

11+00.00

-Y17A-



150 140 130 120 110 100 90 80 70 60 50 40 30 20 10 0 10 20 30 40 50 60 70 80 90 100 110 120 130 140 150

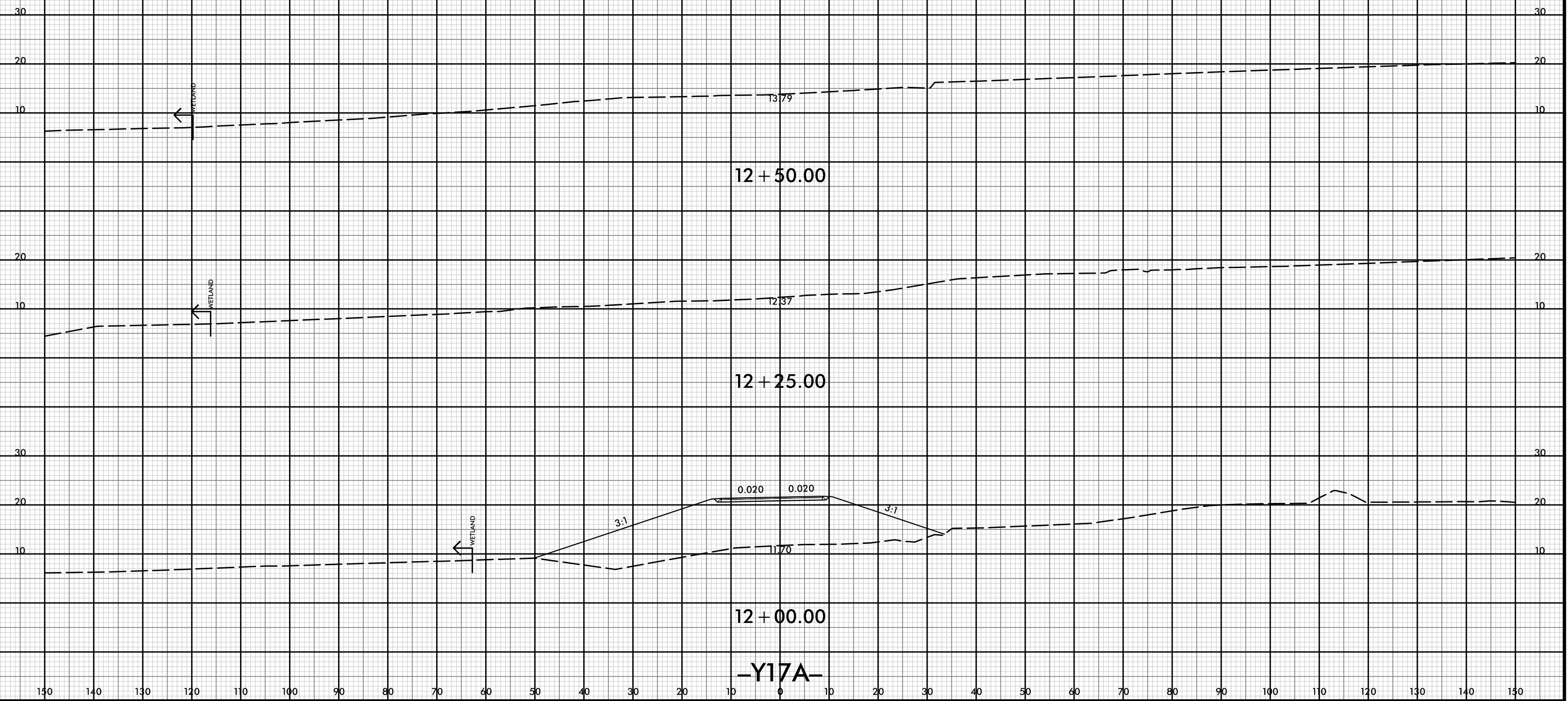

12 + 50.00

12 + 25.00

12 + 00.00

-Y17A-



150 140 130 120 110 100 90 80 70 60 50 40 30 20 10 0 10 20 30 40 50 60 70 80 90 100 110 120 130 140 150

40 40

30 30

20 20

40 40

30 30

20 20

40 40

30 30

20 20

10 + 75.00

40 40

30 30

20 20

10 + 50.00

-Y18A-

150 140 130 120 110 100 90 80 70 60 50 40 30 20 10 0 10 20 30 40 50 60 70 80 90 100 110 120 130 140 150

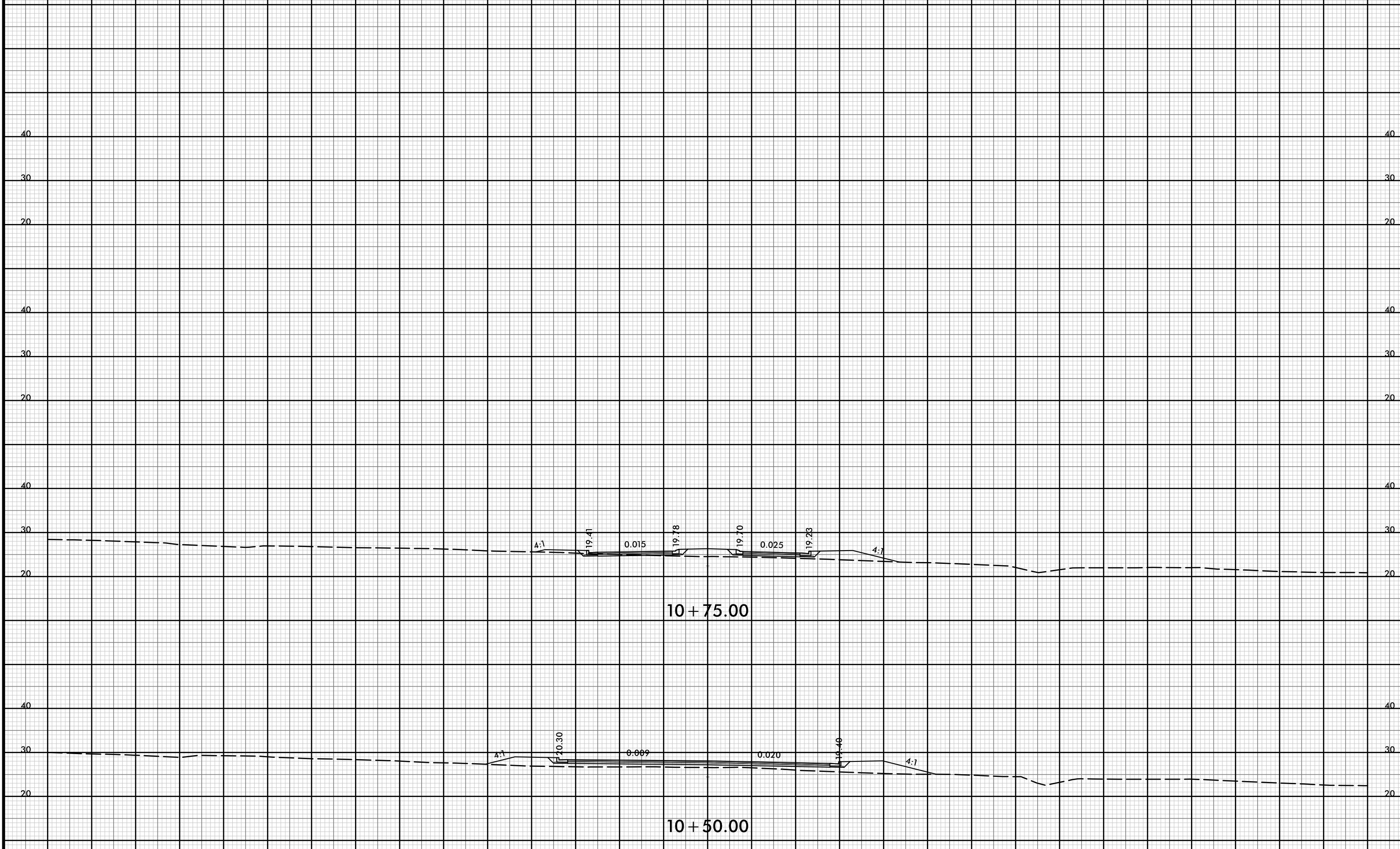

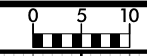

150 140 130 120 110 100 90 80 70 60 50 40 30 20 10 0 10 20 30 40 50 60 70 80 90 100 110 120 130 140 150

40 40

30 30

20 20

40 40

30 30

20 20

40 40

30 30

20 20

11 + 25.00

40 40

30 30

20 20

11 + 00.00

-Y18A-

150 140 130 120 110 100 90 80 70 60 50 40 30 20 10 0 10 20 30 40 50 60 70 80 90 100 110 120 130 140 150

8/23/99



PROJ. REFERENCE NO.
R-5021

SHEET NO.
X-361

150 140 130 120 110 100 90 80 70 60 50 40 30 20 10 0 10 20 30 40 50 60 70 80 90 100 110 120 130 140 150

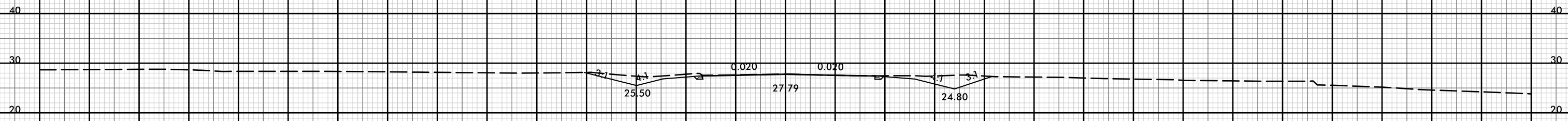

11 + 75.00

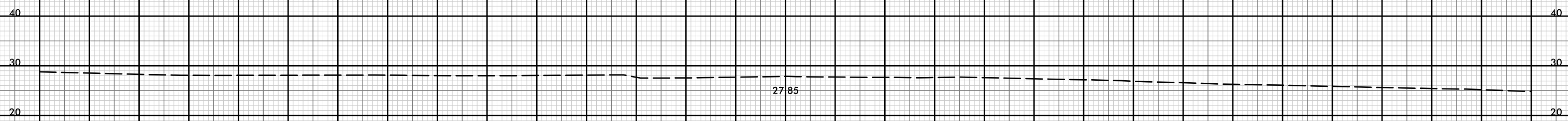

11 + 50.00

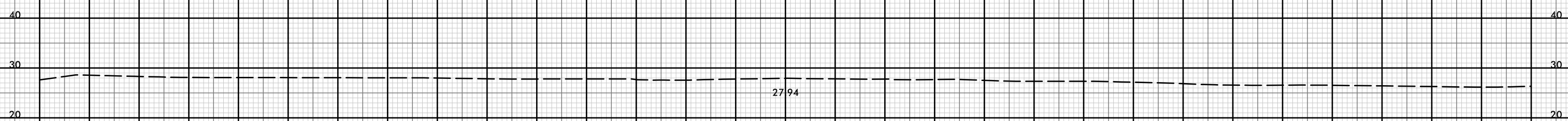

11 + 25.00

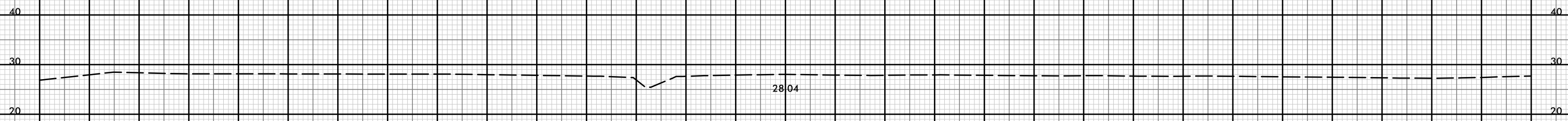

11 + 00.00

~~Y19REV~~

150 140 130 120 110 100 90 80 70 60 50 40 30 20 10 0 10 20 30 40 50 60 70 80 90 100 110 120 130 140 150

21-JUL-2021 10:39
\\P01dweu\XSCA\5021-rdy-yp-l-Y19REV.dgn
HTB

8/23/99

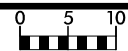

PROJ. REFERENCE NO.
R-5021

SHEET NO.
X-362

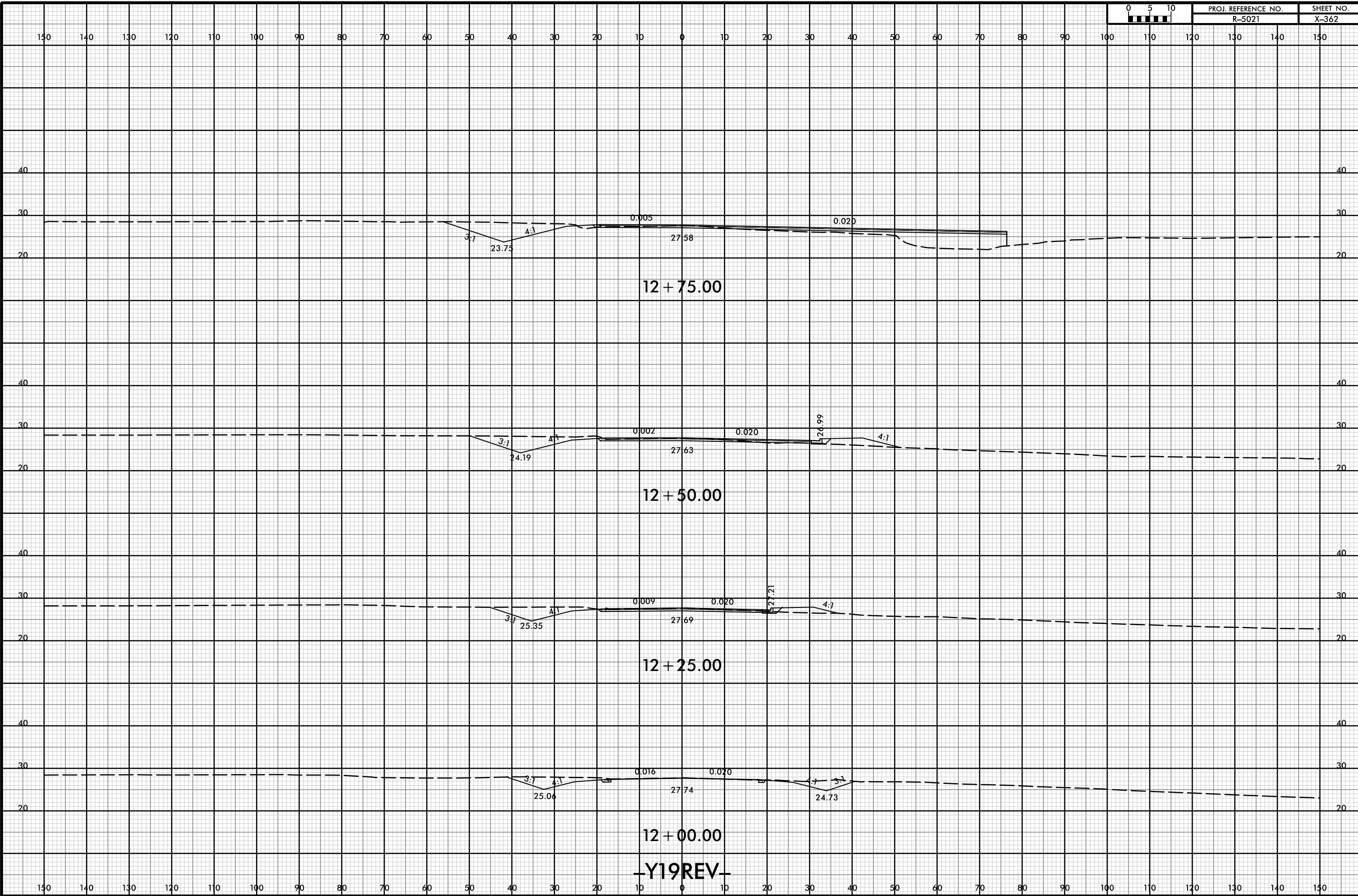

12 + 00.00

Y19REV

21 JUL 2021 10:39
X:\Roadway\XSCA\5021_rdy_xpl_Y19REV.dgn

8/23/99



PROJ. REFERENCE NO.
R-5021

SHEET NO.
X-363

150 140 130 120 110 100 90 80 70 60 50 40 30 20 10 0 10 20 30 40 50 60 70 80 90 100 110 120 130 140 150

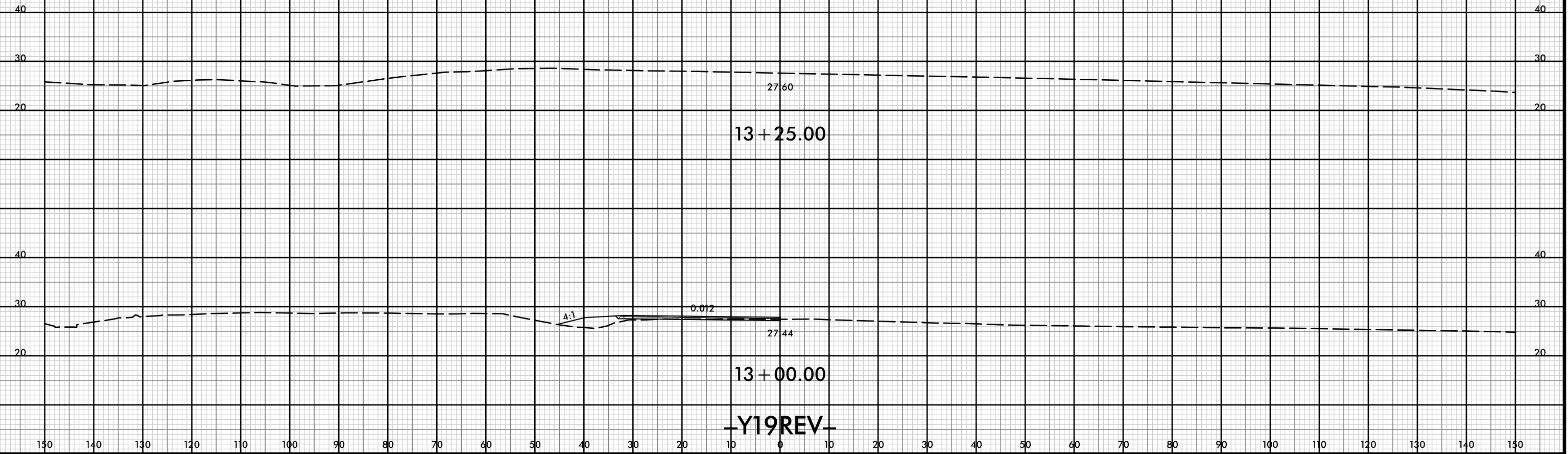

~~Y19REV~~

21-Jul-2021 10:39
R:\p\dawej\XSCA\5021-r-dj-xp-l-Y19REV.dgn
HNTB

150 140 130 120 110 100 90 80 70 60 50 40 30 20 10 0 10 20 30 40 50 60 70 80 90 100 110 120 130 140 150

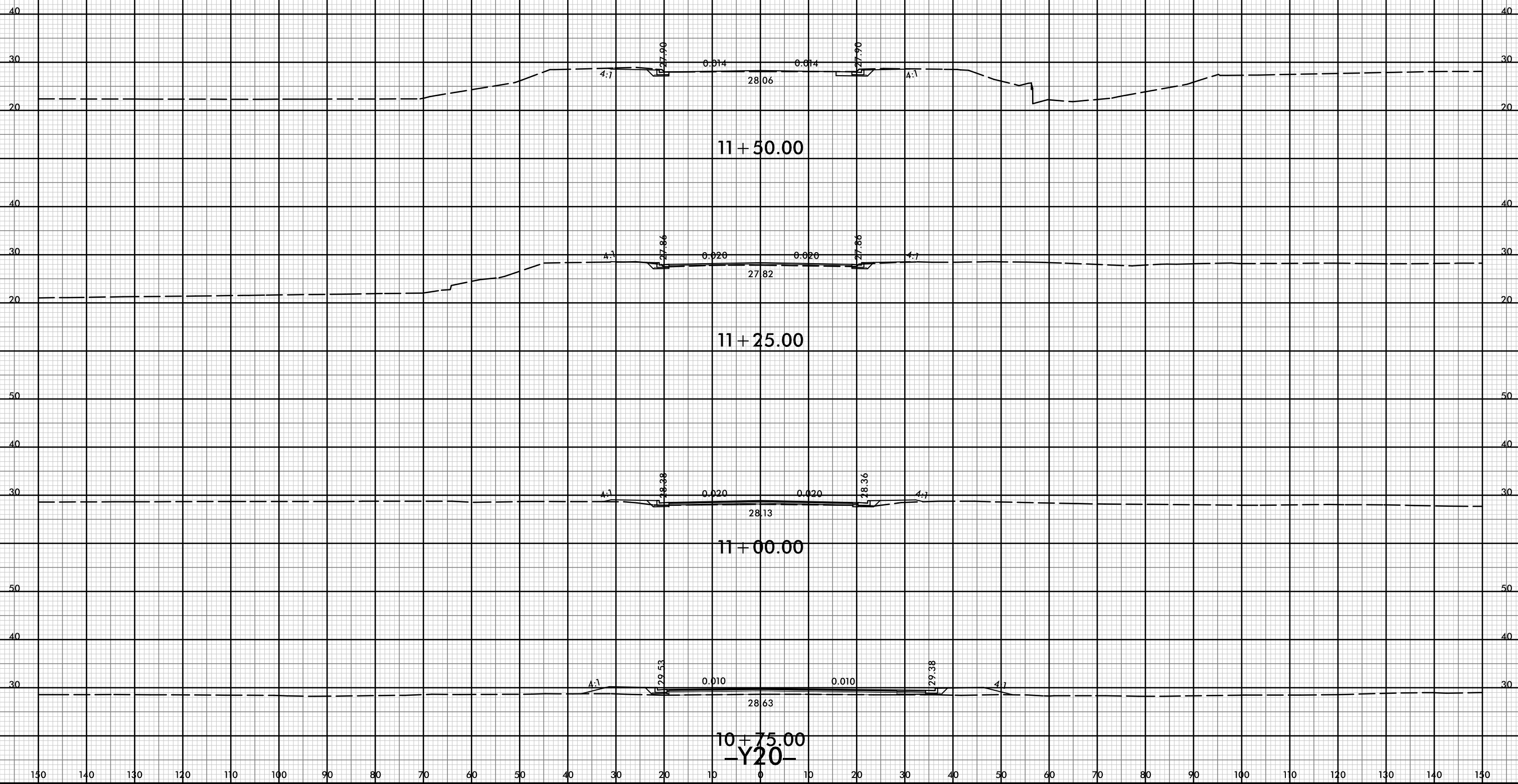

10+75.00
-Y20-

8/23/99



PROJ. REFERENCE NO.
R-5021

SHEET NO.
X-365

150 140 130 120 110 100 90 80 70 60 50 40 30 20 10 0 10 20 30 40 50 60 70 80 90 100 110 120 130 140 150

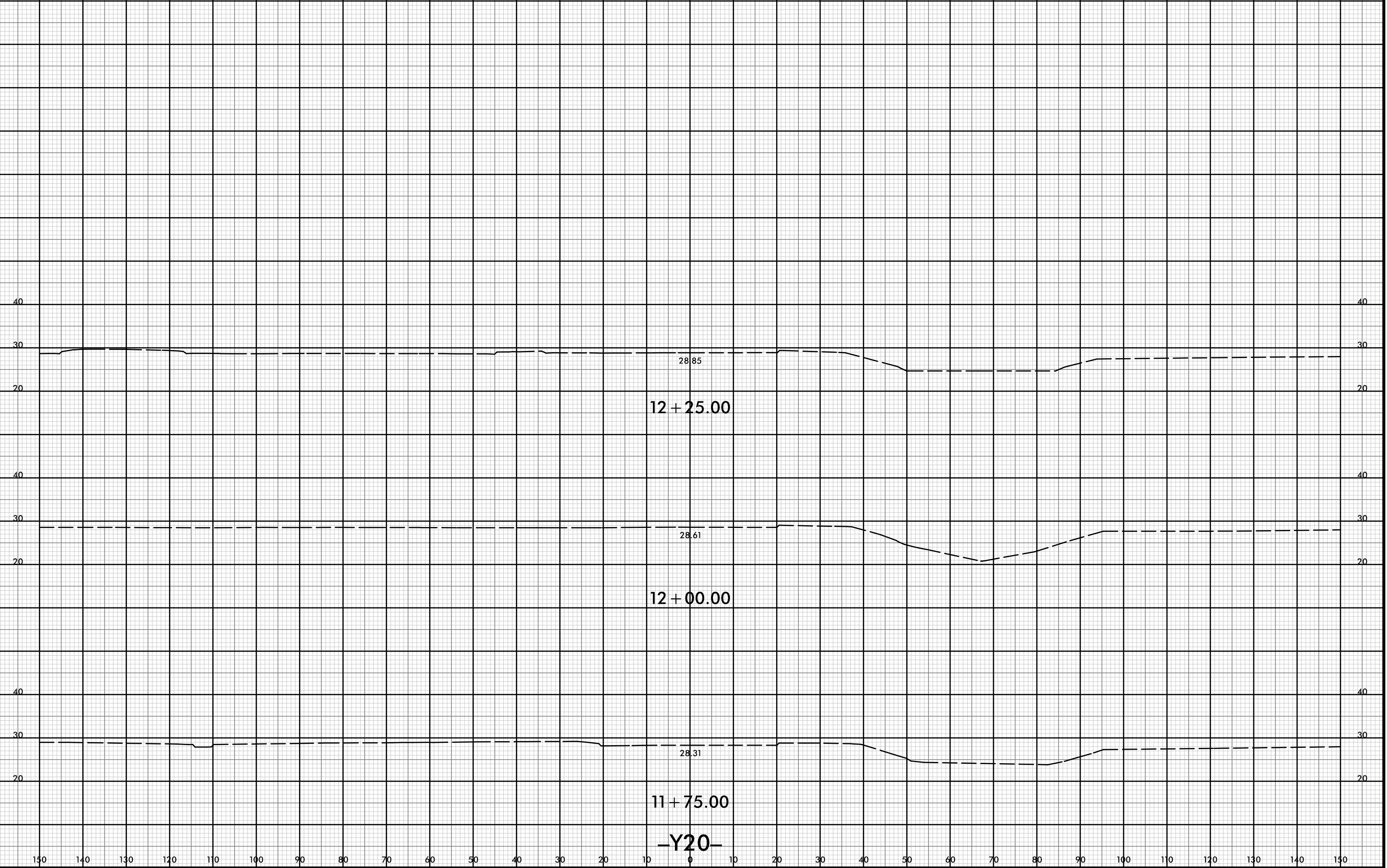

21-Jul-2021 10:39
\\P01dweu\XSC\5021-rdy-11-Y20.dgn
HTB

150 140 130 120 110 100 90 80 70 60 50 40 30 20 10 0 10 20 30 40 50 60 70 80 90 100 110 120 130 140 150

-Y20-

8/23/99

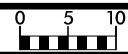

PROJ. REFERENCE NO.
R-5021

SHEET NO.
X-366

150 140 130 120 110 100 90 80 70 60 50 40 30 20 10 0 10 20 30 40 50 60 70 80 90 100 110 120 130 140 150

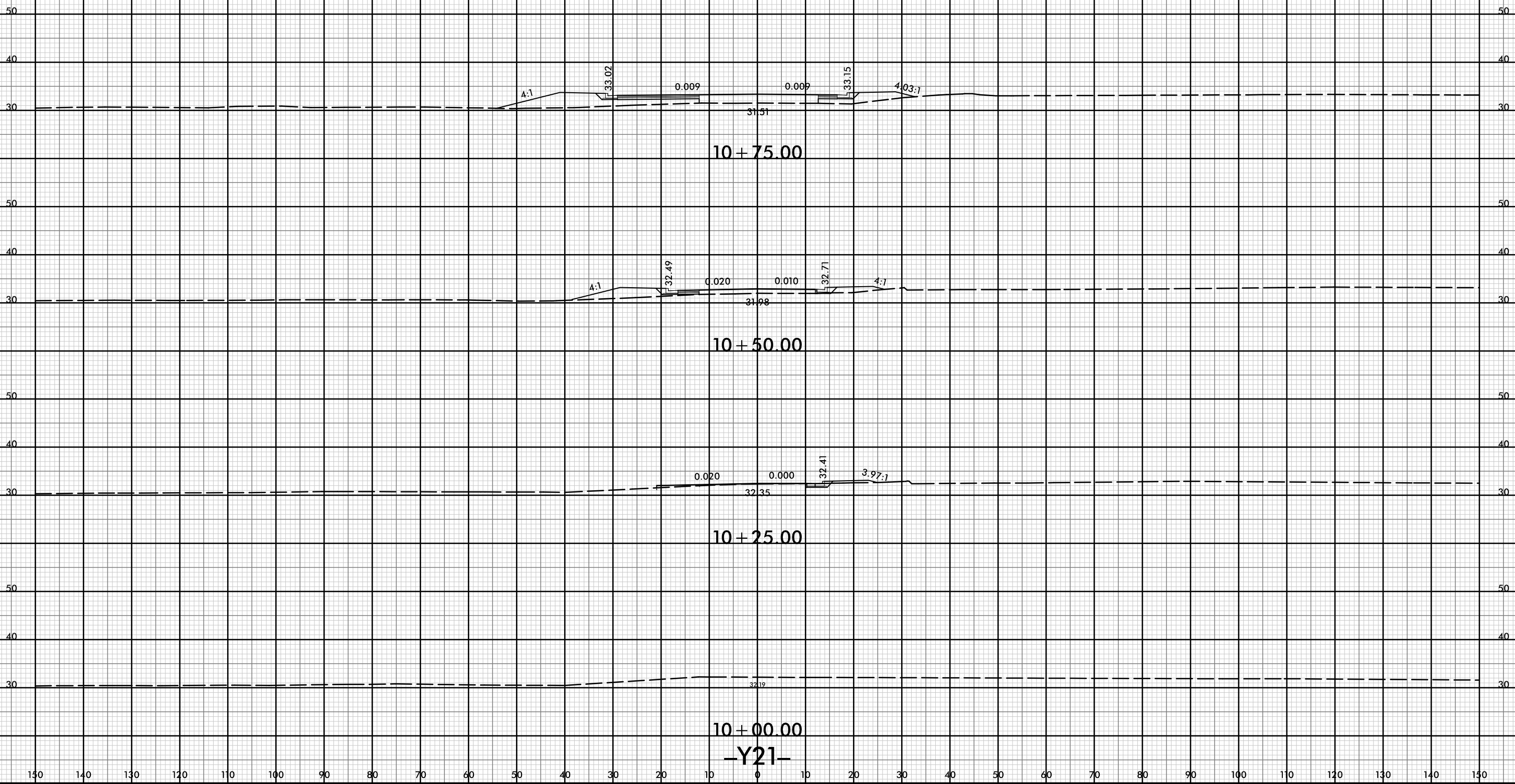

10 + 00.00
-Y21-

21-Jul-2021 10:39
R:\p\dawej\XSC\5021-rdy-yp-l-y21.dgn
HTB



150 140 130 120 110 100 90 80 70 60 50 40 30 20 10 0 10 20 30 40 50 60 70 80 90 100 110 120 130 140 150

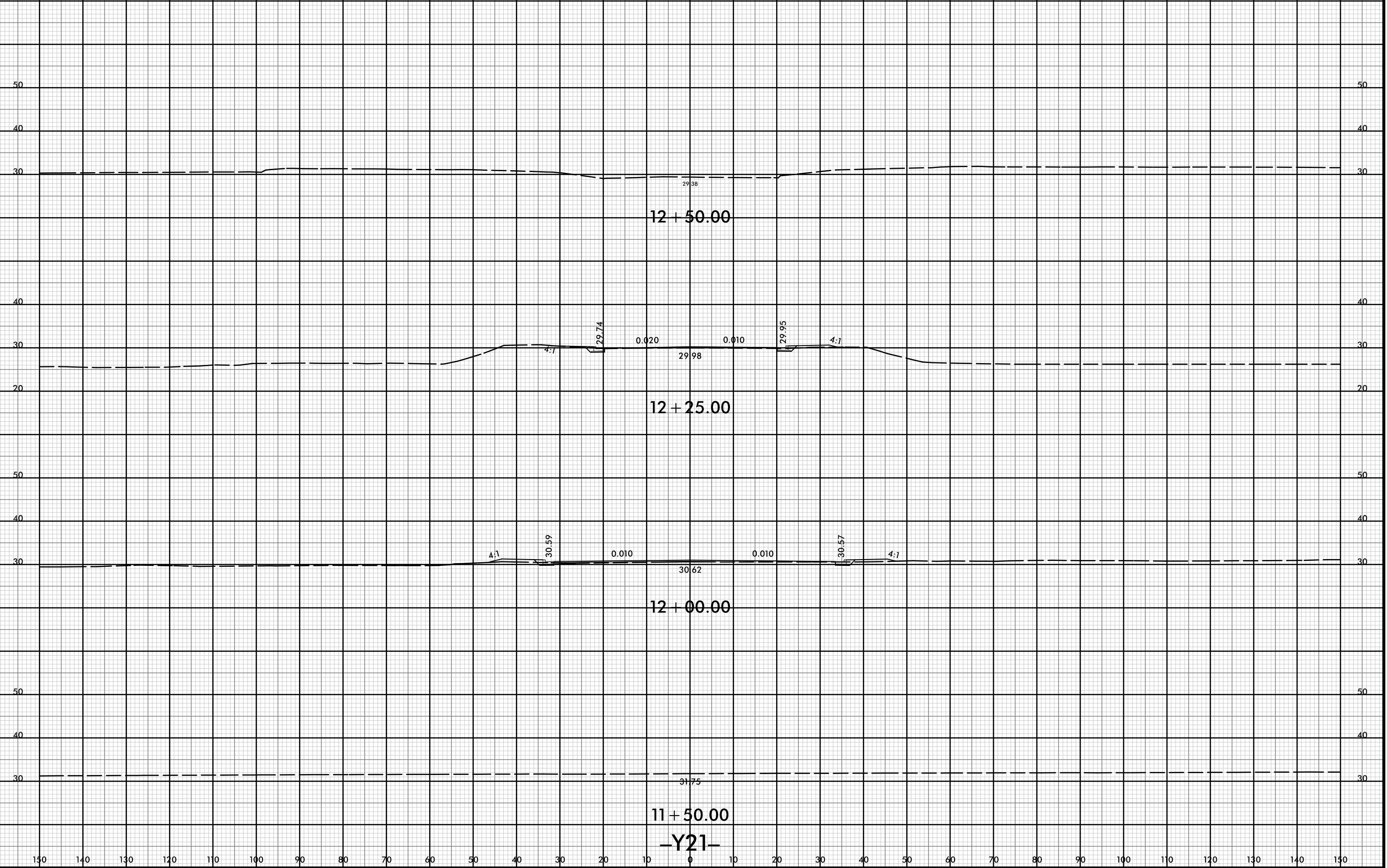

12 + 50.00

12 + 25.00

12 + 00.00

11 + 50.00

-Y21-

29.38

29.74

29.95

4:1

4:1

0.020

0.010

29.98

4:1

30.59

0.010

0.010

30.57

4:1

30.62

31.75



150 140 130 120 110 100 90 80 70 60 50 40 30 20 10 0 10 20 30 40 50 60 70 80 90 100 110 120 130 140 150

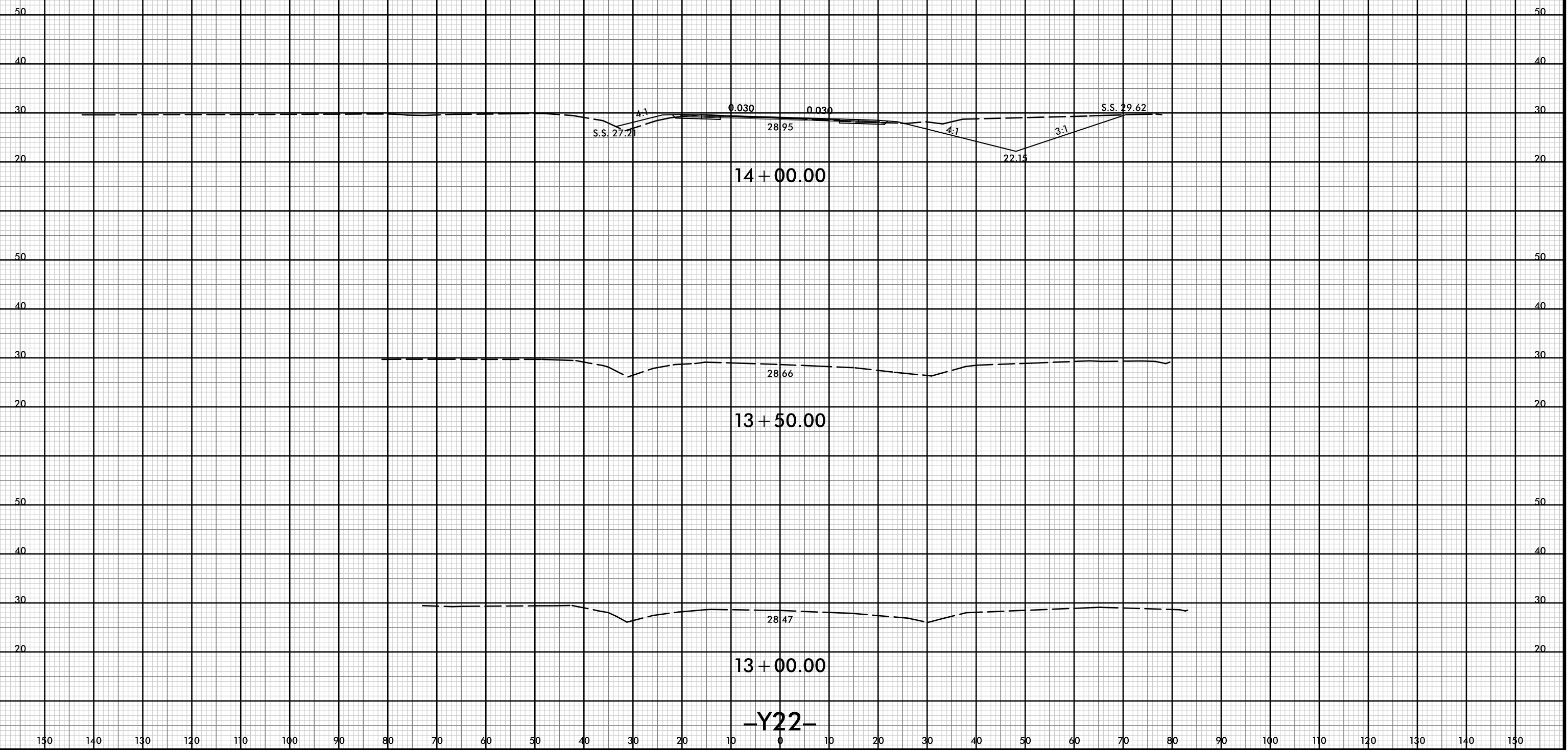

150 140 130 120 110 100 90 80 70 60 50 40 30 20 10 0 10 20 30 40 50 60 70 80 90 100 110 120 130 140 150

8/23/99



PROJ. REFERENCE NO.
R-5021

SHEET NO.
X-369

150 140 130 120 110 100 90 80 70 60 50 40 30 20 10 0 10 20 30 40 50 60 70 80 90 100 110 120 130 140 150

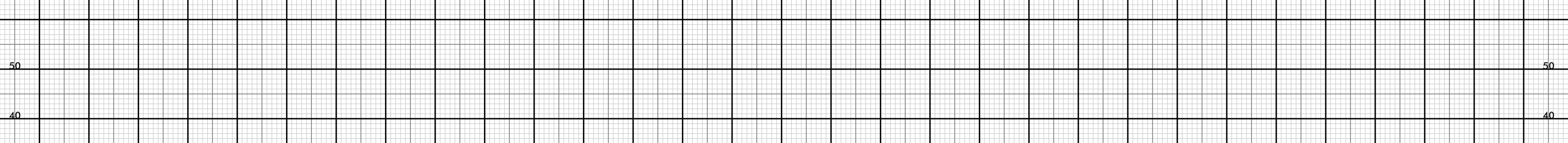
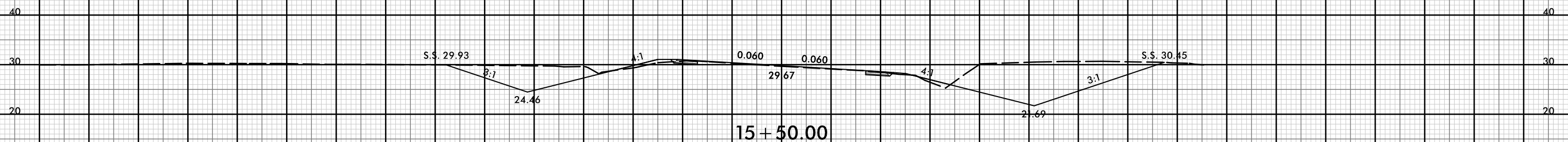
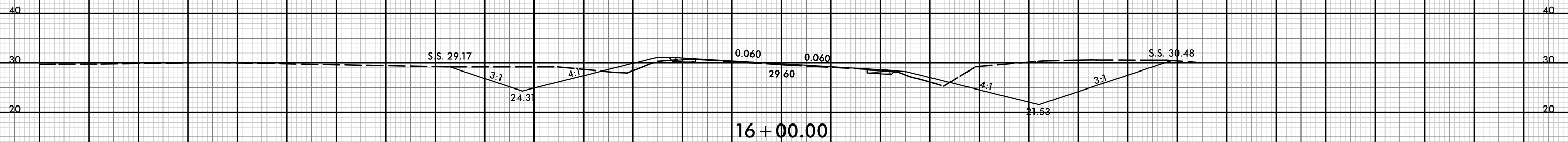

150 140 130 120 110 100 90 80 70 60 50 40 30 20 10 0 10 20 30 40 50 60 70 80 90 100 110 120 130 140 150

-Y22-

21-Jul-2021 10:40
P:\Roadway\XSC\5021-rdy-yp-1-Y22.dgn
HTB

8/23/99



PROJ. REFERENCE NO. R-5021	SHEET NO. X-370
-------------------------------	--------------------

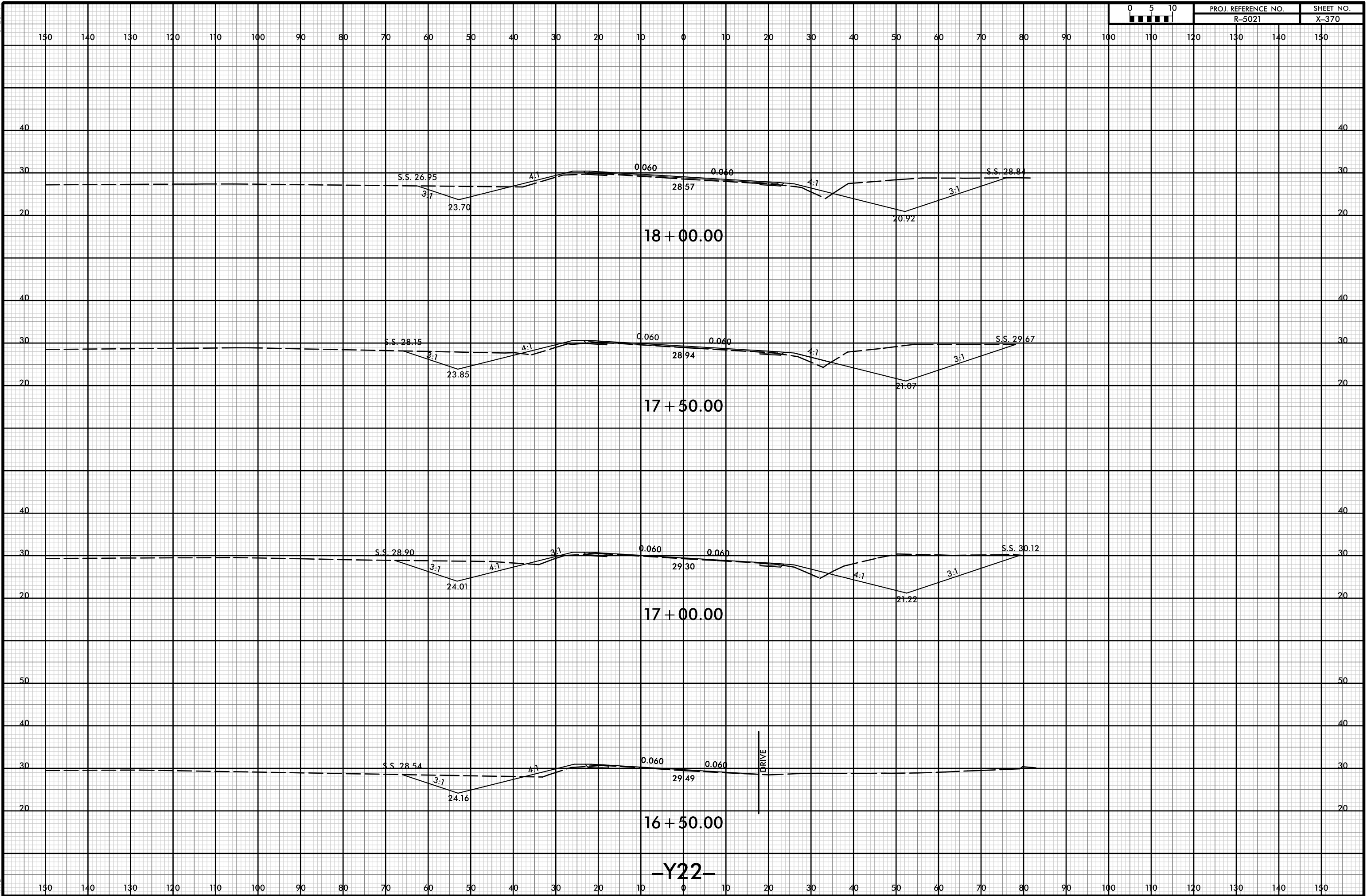

21-Jul-2021 10:40
R:\p\dawej\XSC\5021-rdy-yp-1-Y22.dgn
HTB

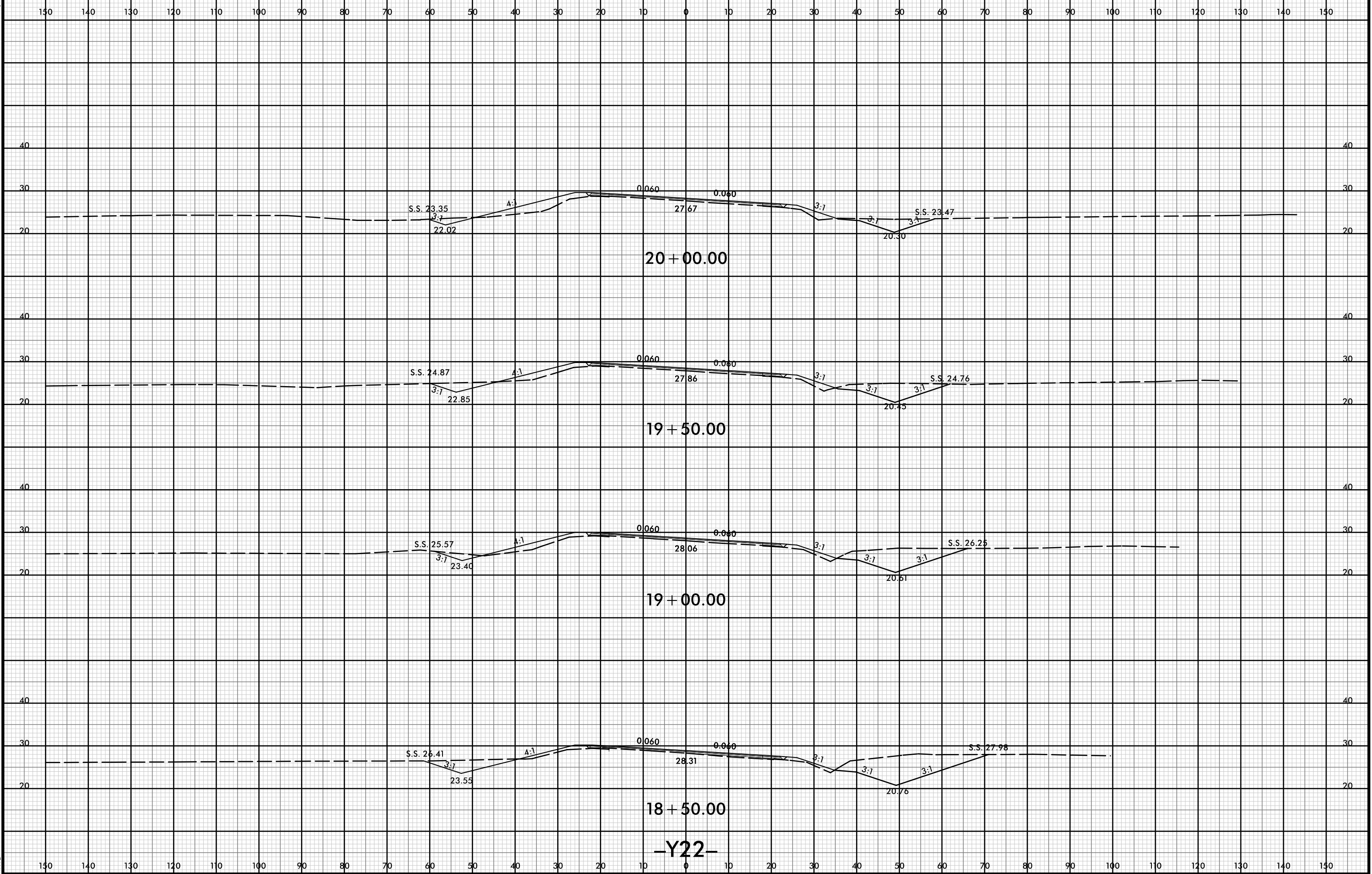

-Y22-

8/23/99



PROJ. REFERENCE NO.
R-5021

SHEET NO.
X-372

150 140 130 120 110 100 90 80 70 60 50 40 30 20 10 0 10 20 30 40 50 60 70 80 90 100 110 120 130 140 150

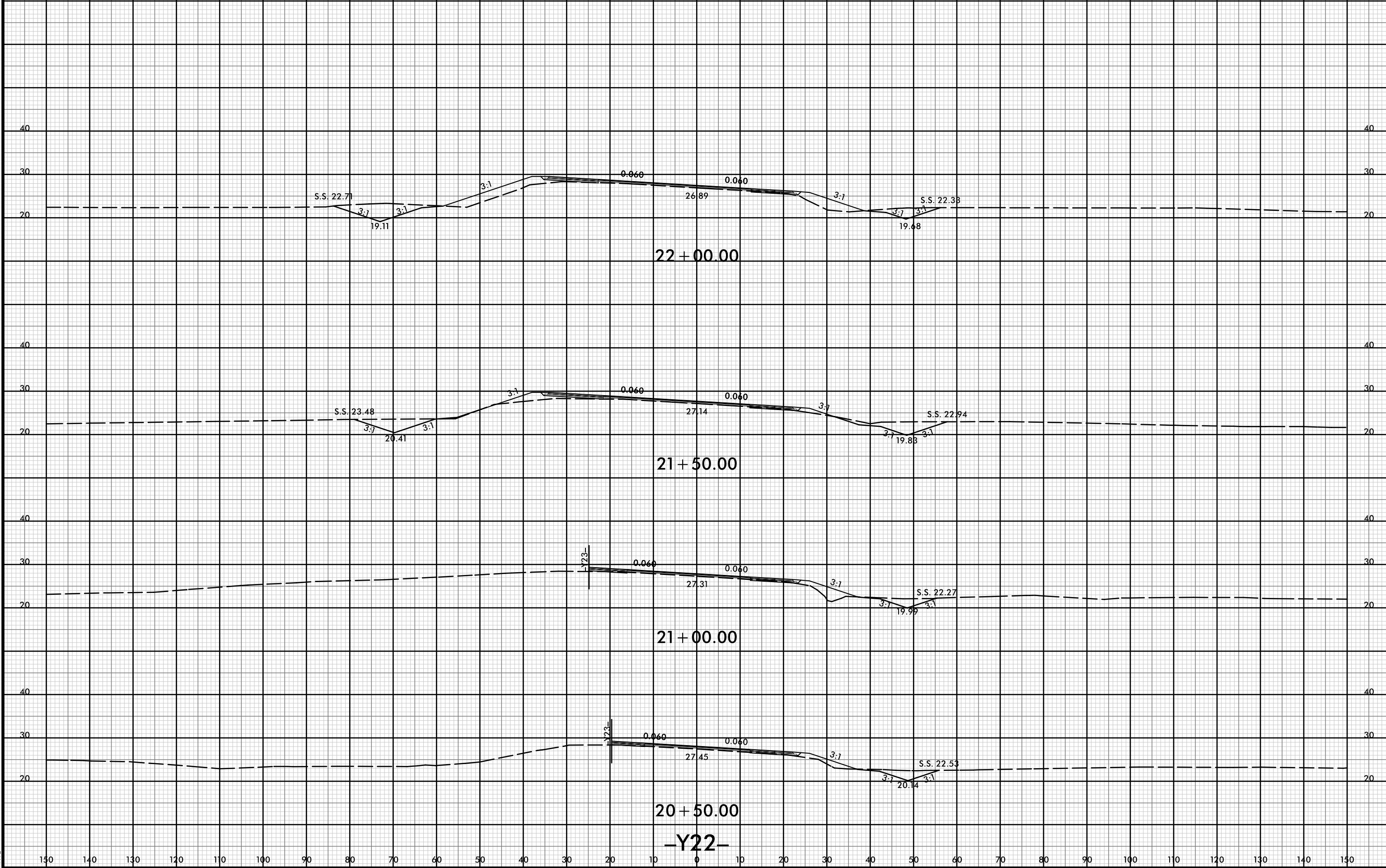

150 140 130 120 110 100 90 80 70 60 50 40 30 20 10 0 10 20 30 40 50 60 70 80 90 100 110 120 130 140 150

21-Jul-2021 10:40
R:\p\dawej\XSC\5021-rdy-xp-1-Y22.dgn
HTB

8/23/99

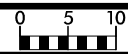

PROJ. REFERENCE NO.
R-5021

SHEET NO.
X-373

150 140 130 120 110 100 90 80 70 60 50 40 30 20 10 0 10 20 30 40 50 60 70 80 90 100 110 120 130 140 150

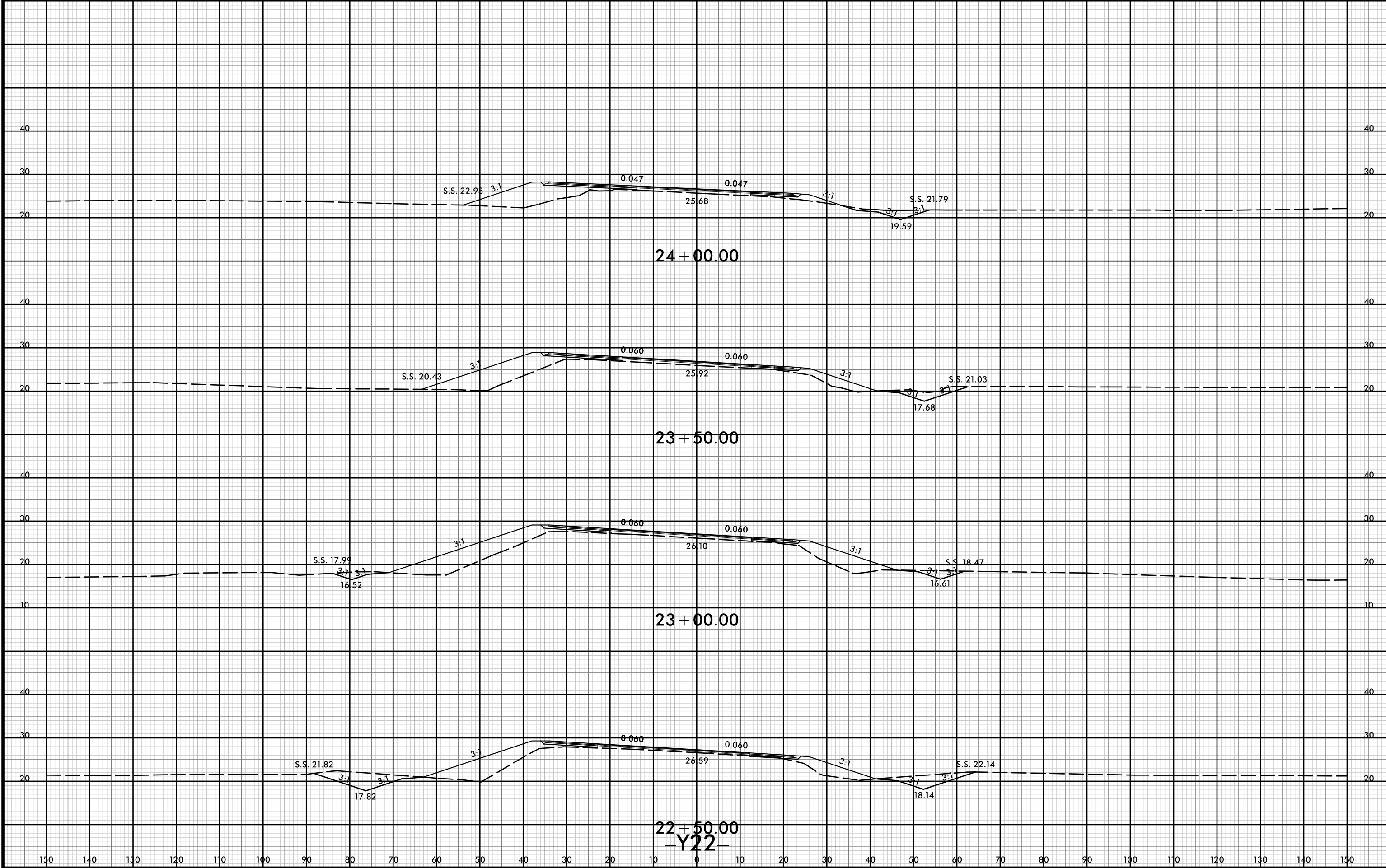

24 + 00.00

23 + 50.00

23 + 00.00

22 + 50.00

-Y22-

21 JUL 2001 10:40
P:\cdawej\XSC\5021-rdy-yp-1-Y22.dgn
HTB

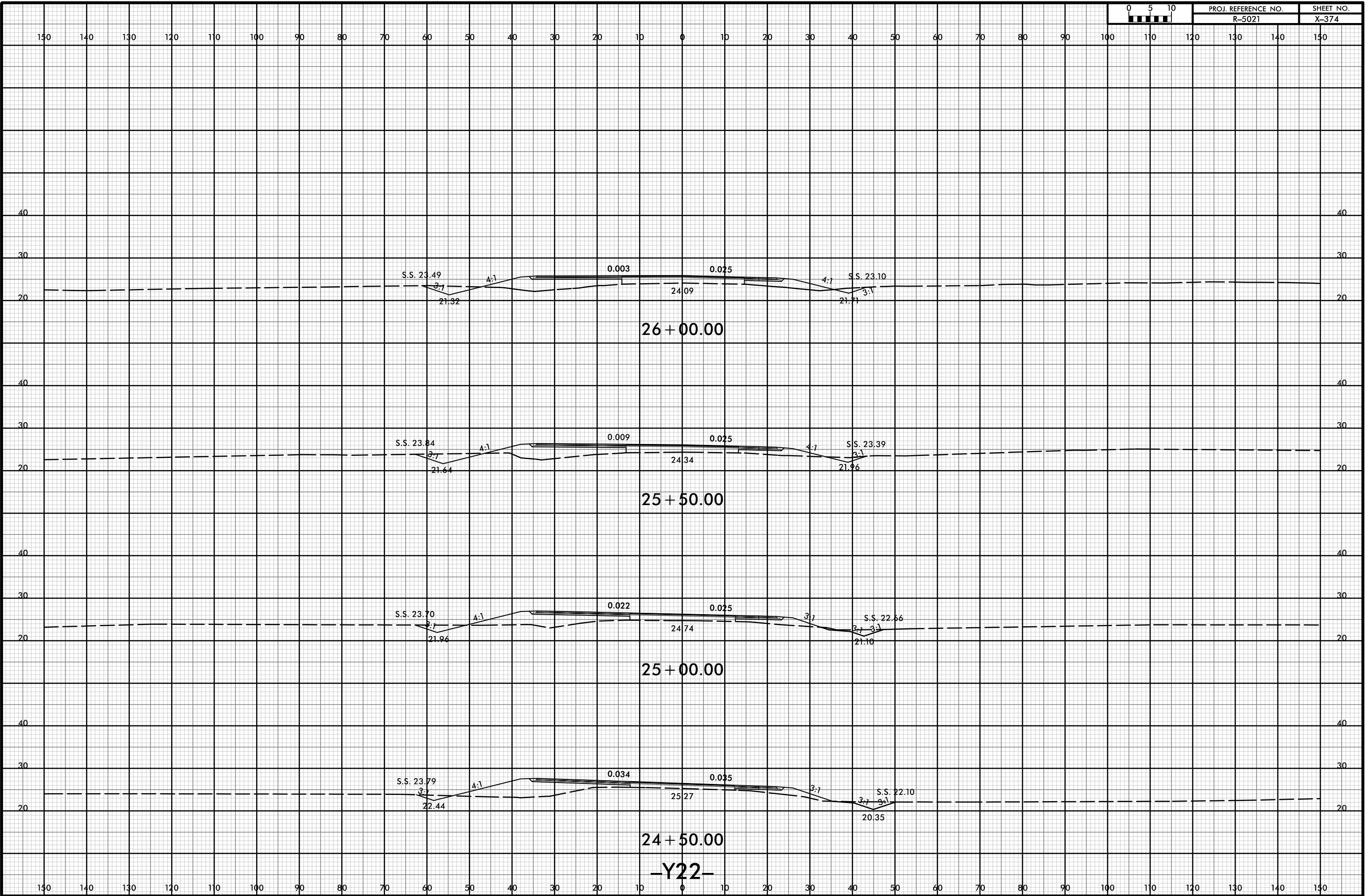

8/23/99

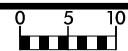

PROJ. REFERENCE NO.
R-5021

SHEET NO.
X-375

150 140 130 120 110 100 90 80 70 60 50 40 30 20 10 0 10 20 30 40 50 60 70 80 90 100 110 120 130 140 150

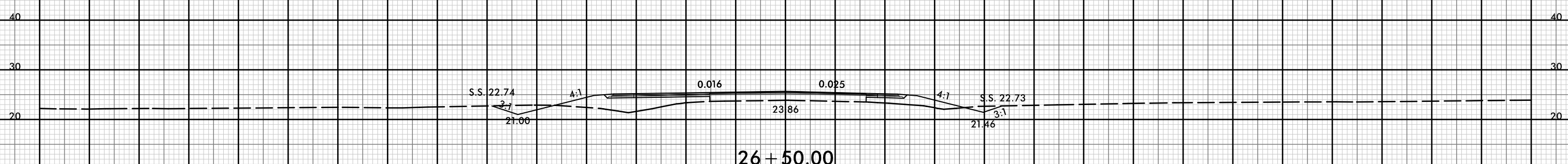
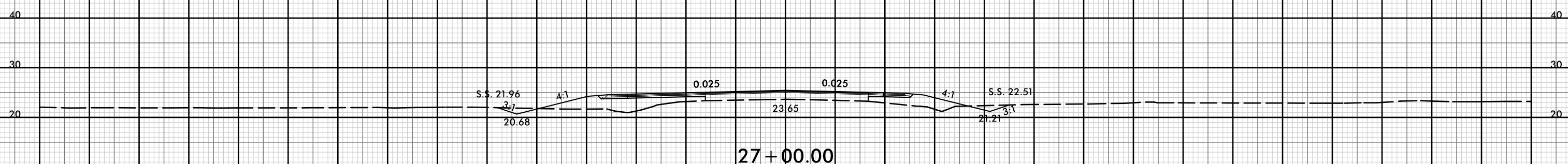
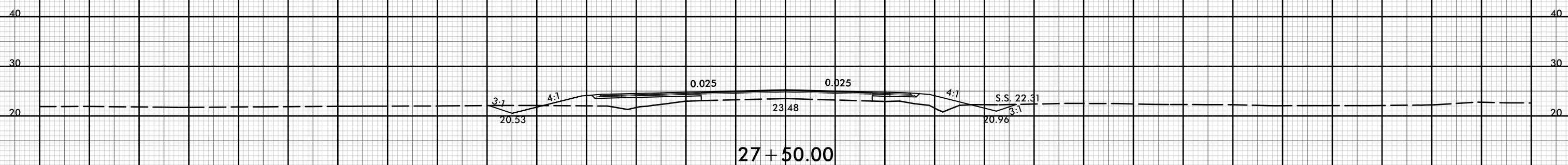
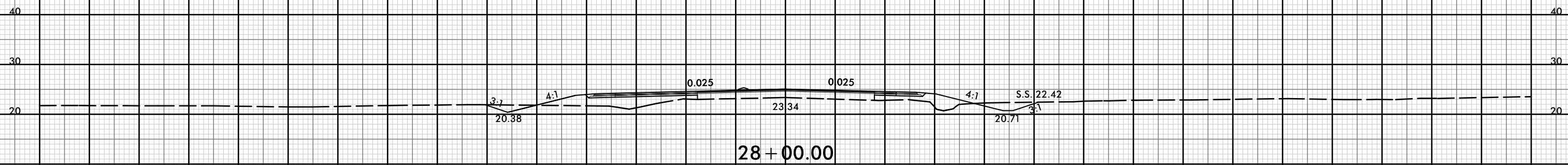

-Y22-

150 140 130 120 110 100 90 80 70 60 50 40 30 20 10 0 10 20 30 40 50 60 70 80 90 100 110 120 130 140 150

21-Jul-2021 10:40
R:\p\dawej\XSC\5021-rdy-yp-1-Y22.dgn
HTB



150 140 130 120 110 100 90 80 70 60 50 40 30 20 10 0 10 20 30 40 50 60 70 80 90 100 110 120 130 140 150

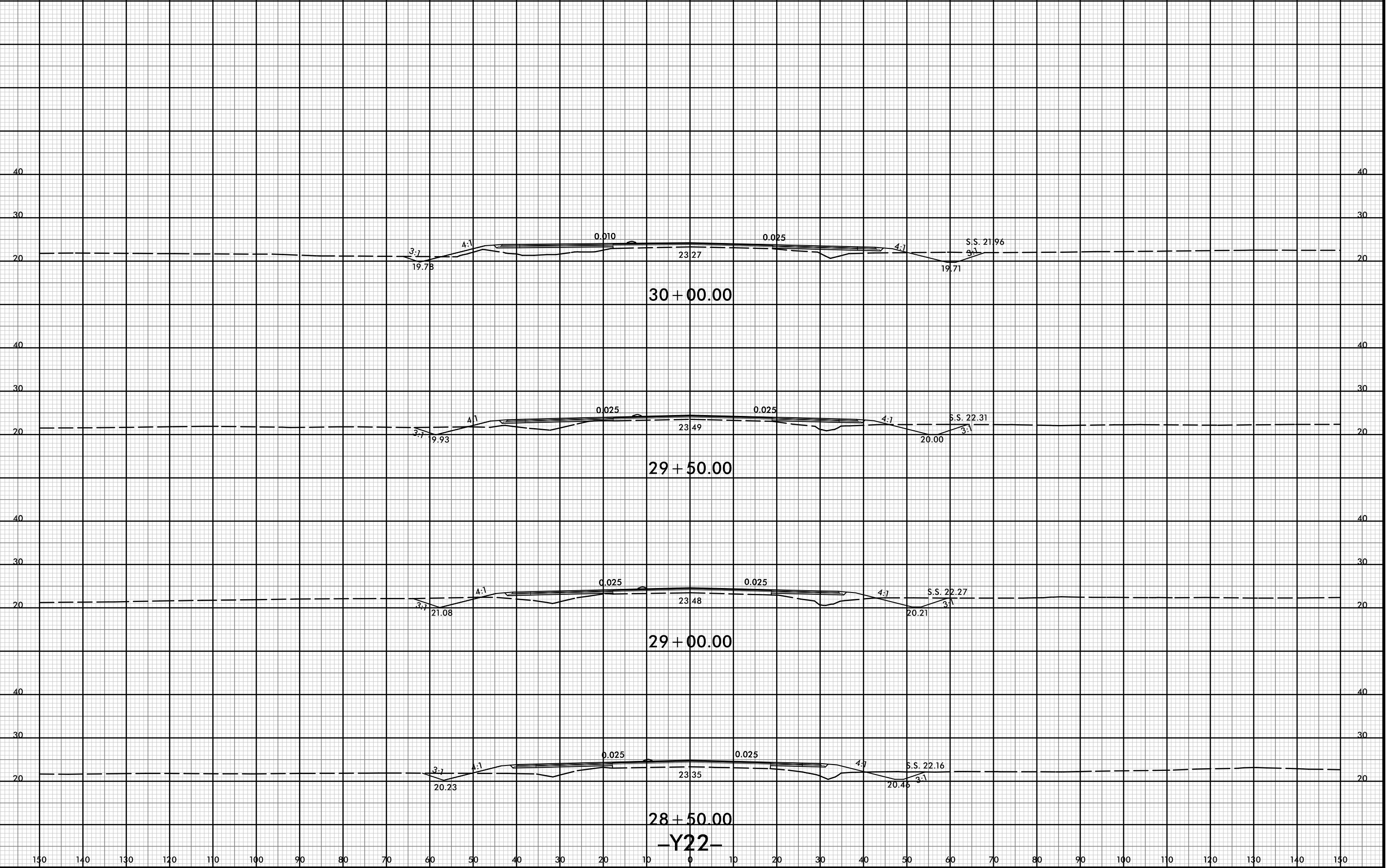

150 140 130 120 110 100 90 80 70 60 50 40 30 20 10 0 10 20 30 40 50 60 70 80 90 100 110 120 130 140 150



150 140 130 120 110 100 90 80 70 60 50 40 30 20 10 0 10 20 30 40 50 60 70 80 90 100 110 120 130 140 150

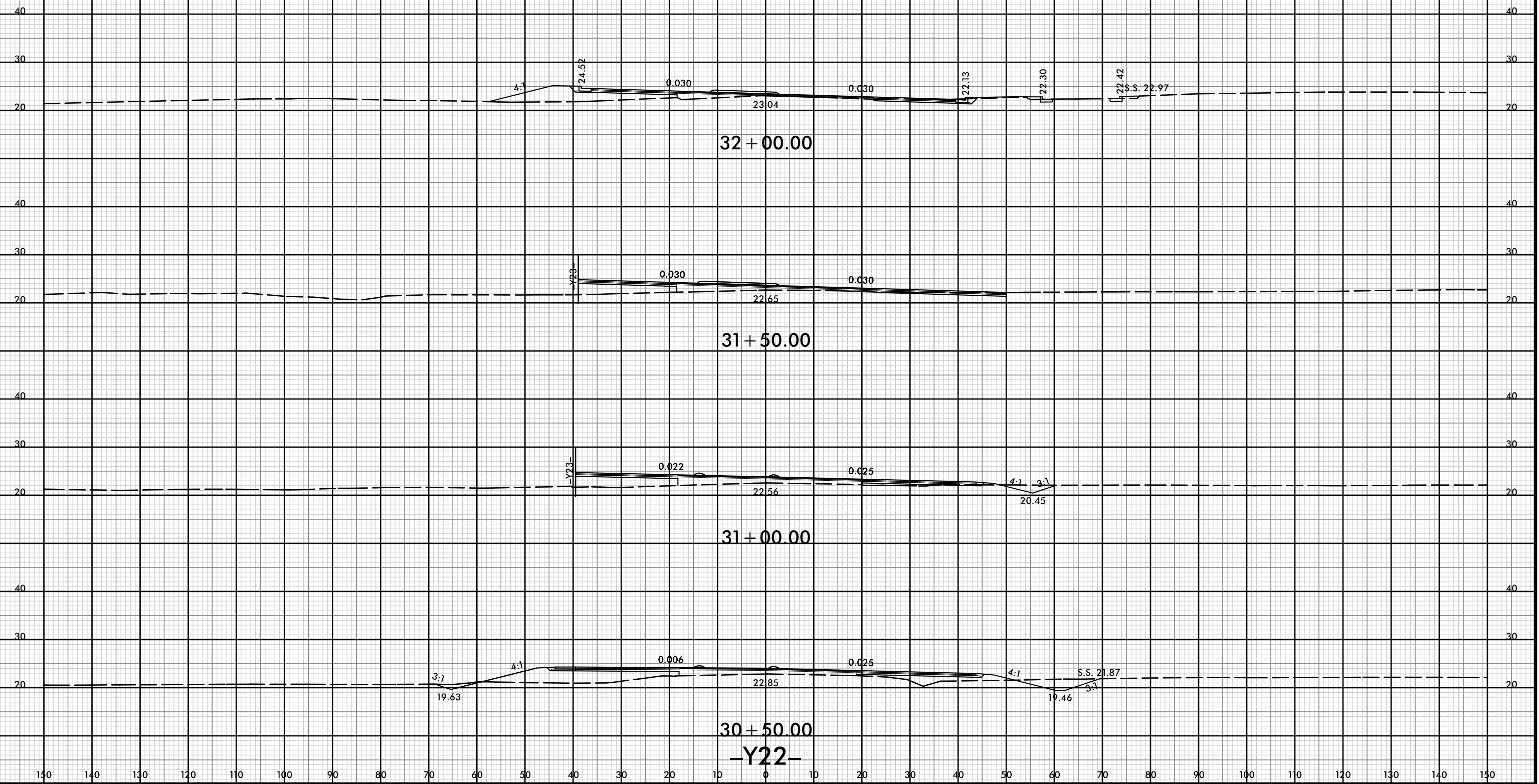

150 140 130 120 110 100 90 80 70 60 50 40 30 20 10 0 10 20 30 40 50 60 70 80 90 100 110 120 130 140 150

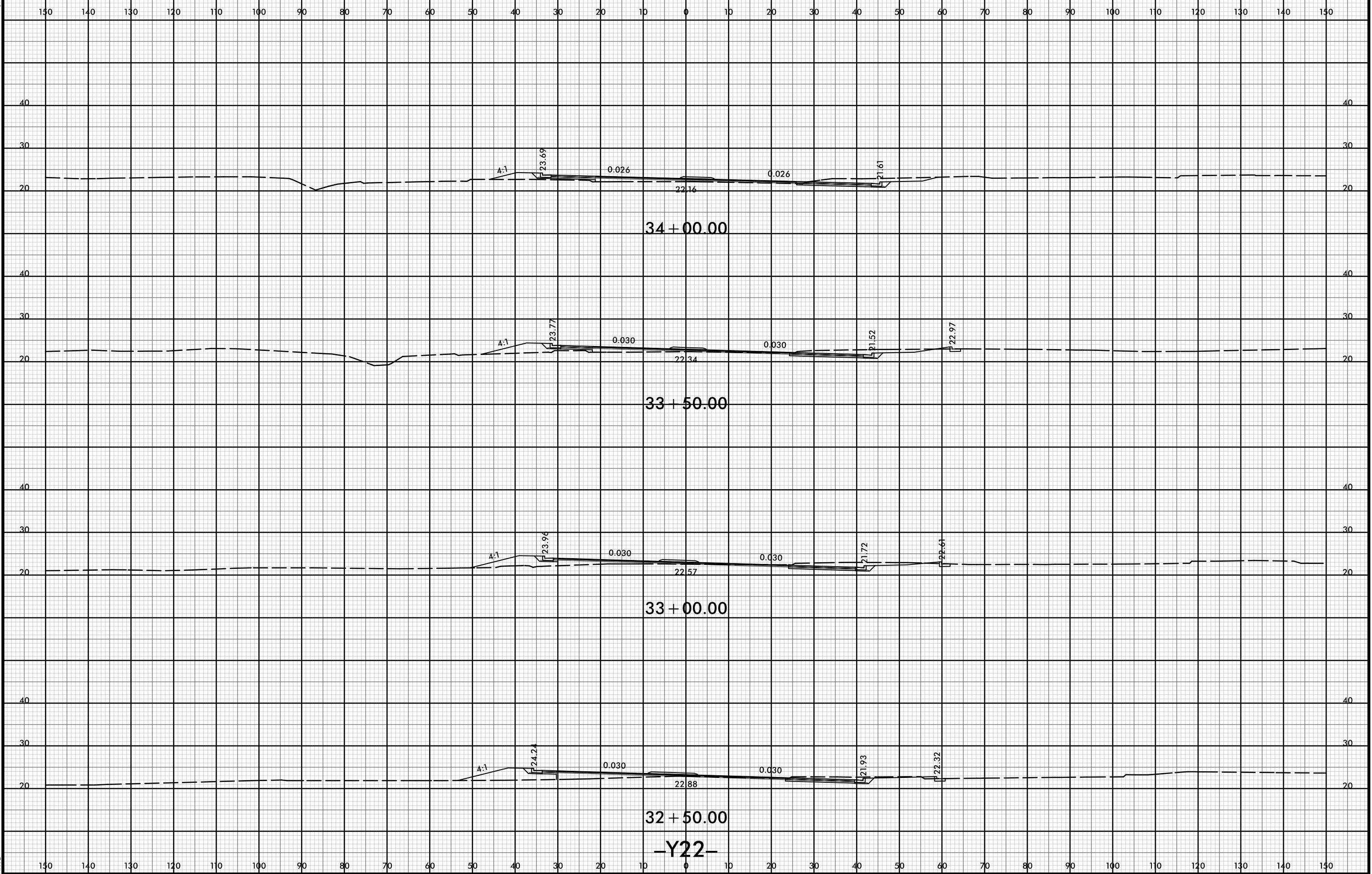

-Y22-

8/23/99



PROJ. REFERENCE NO.
R-5021

SHEET NO.
X-379

150 140 130 120 110 100 90 80 70 60 50 40 30 20 10 0 10 20 30 40 50 60 70 80 90 100 110 120 130 140 150

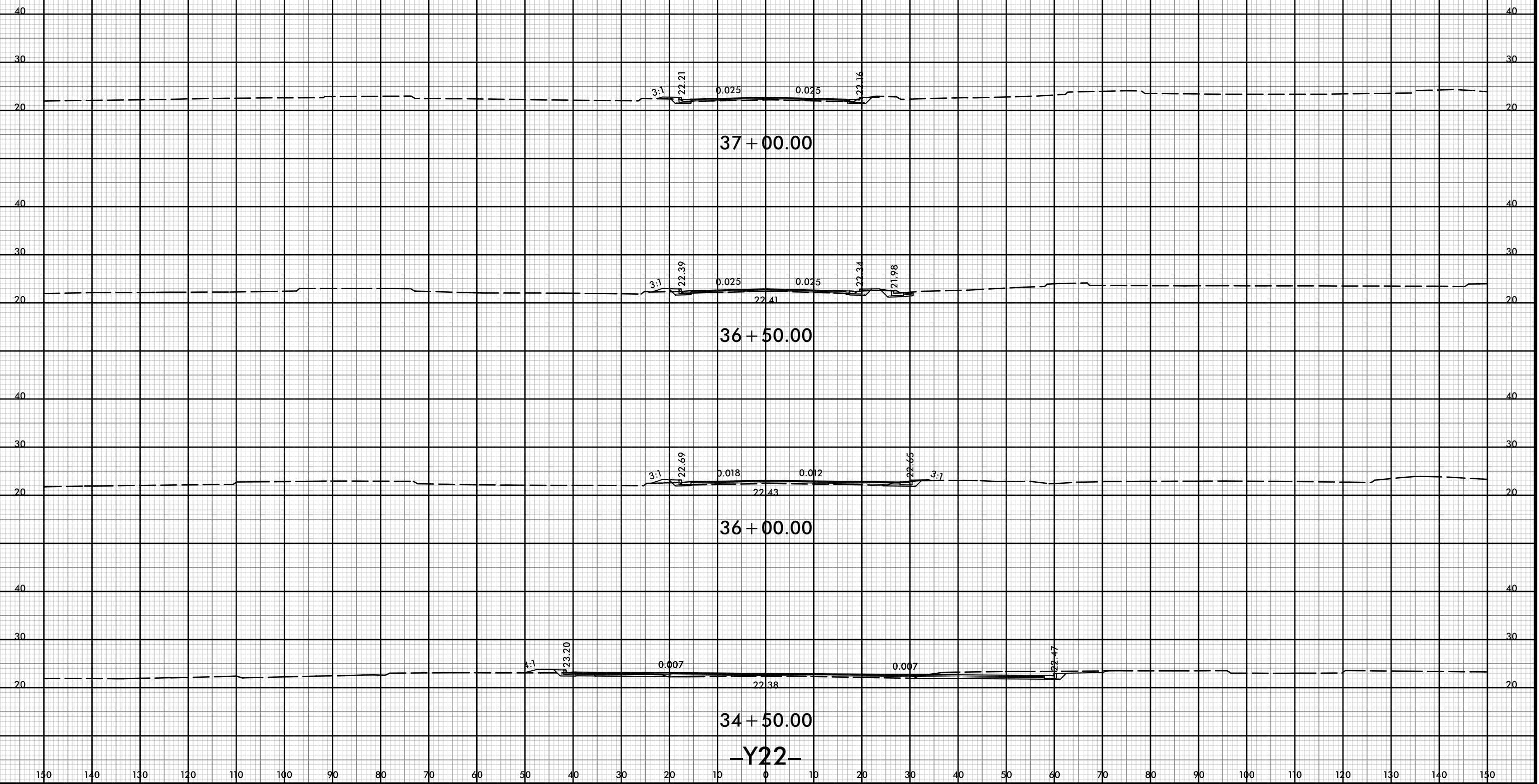

21-Jul-2021 10:40
R:\p\dawej\XSC\5021-rdy-xl-1\Y22.dgn
HTB

150 140 130 120 110 100 90 80 70 60 50 40 30 20 10 0 10 20 30 40 50 60 70 80 90 100 110 120 130 140 150

-Y22-

150 140 130 120 110 100 90 80 70 60 50 40 30 20 10 0 10 20 30 40 50 60 70 80 90 100 110 120 130 140 150

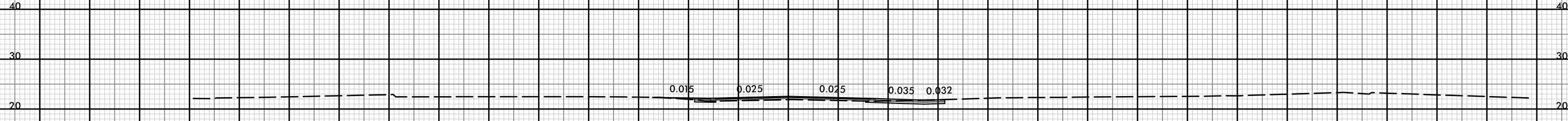
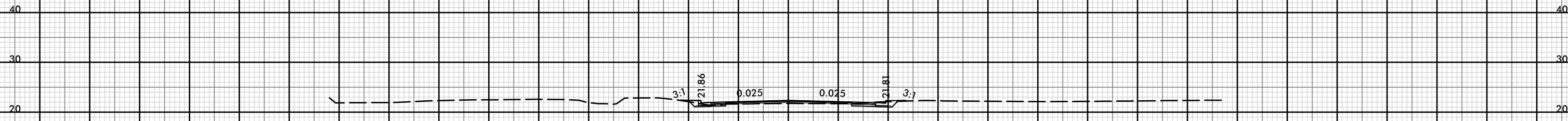
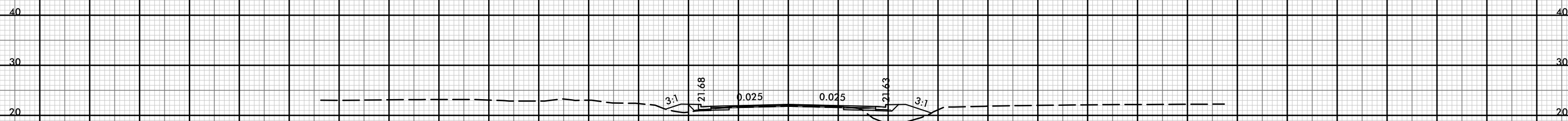
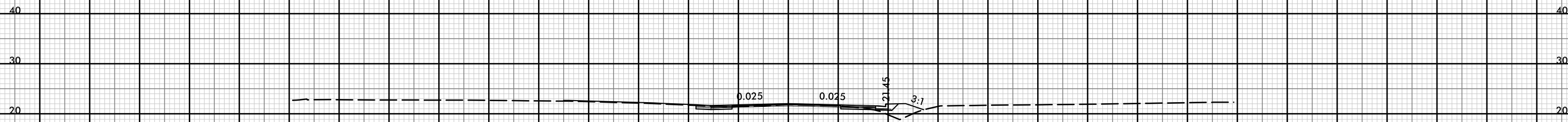

150 140 130 120 110 100 90 80 70 60 50 40 30 20 10 0 10 20 30 40 50 60 70 80 90 100 110 120 130 140 150

-Y22-

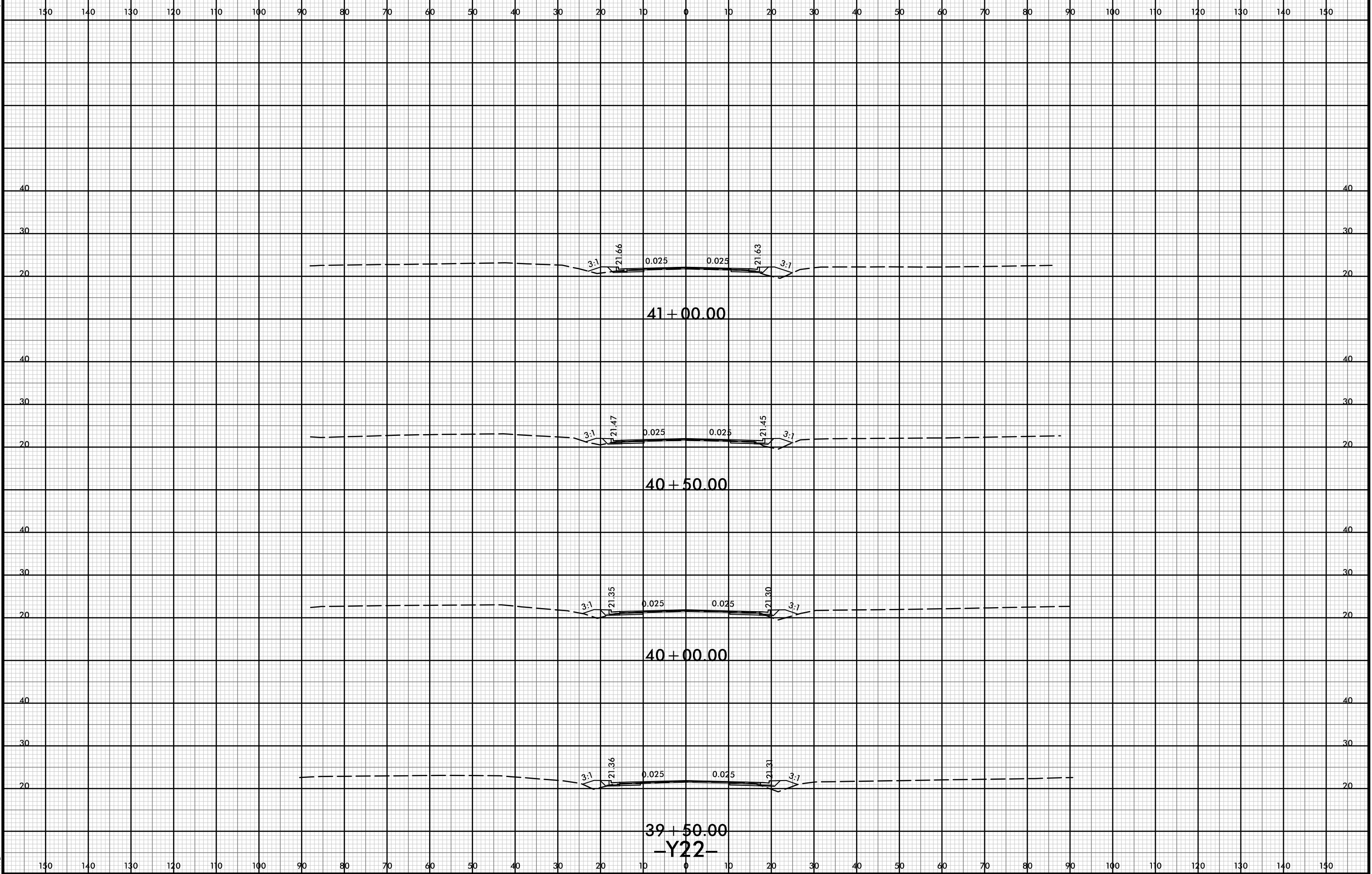



150 140 130 120 110 100 90 80 70 60 50 40 30 20 10 0 10 20 30 40 50 60 70 80 90 100 110 120 130 140 150

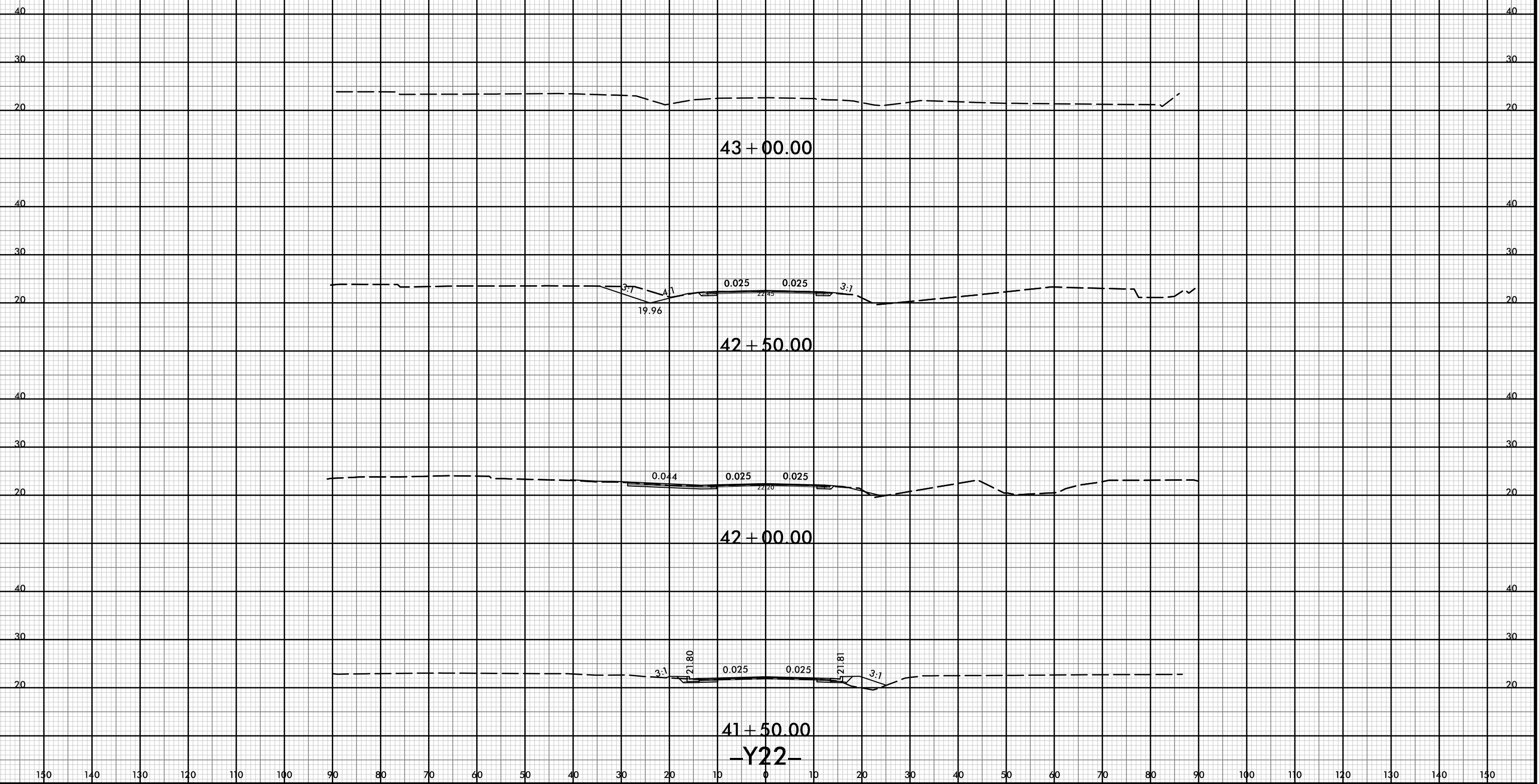

150 140 130 120 110 100 90 80 70 60 50 40 30 20 10 0 10 20 30 40 50 60 70 80 90 100 110 120 130 140 150

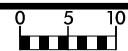

150 140 130 120 110 100 90 80 70 60 50 40 30 20 10 0 10 20 30 40 50 60 70 80 90 100 110 120 130 140 150

40 40

30 30

20 20

10 + 75.00

40 40

30 30

20 20

10 + 50.00

40 40

30 30

20 20

10 + 25.00

40 40

30 30

20 20

10 + 00.00

-Y22A-

150 140 130 120 110 100 90 80 70 60 50 40 30 20 10 0 10 20 30 40 50 60 70 80 90 100 110 120 130 140 150



150 140 130 120 110 100 90 80 70 60 50 40 30 20 10 0 10 20 30 40 50 60 70 80 90 100 110 120 130 140 150

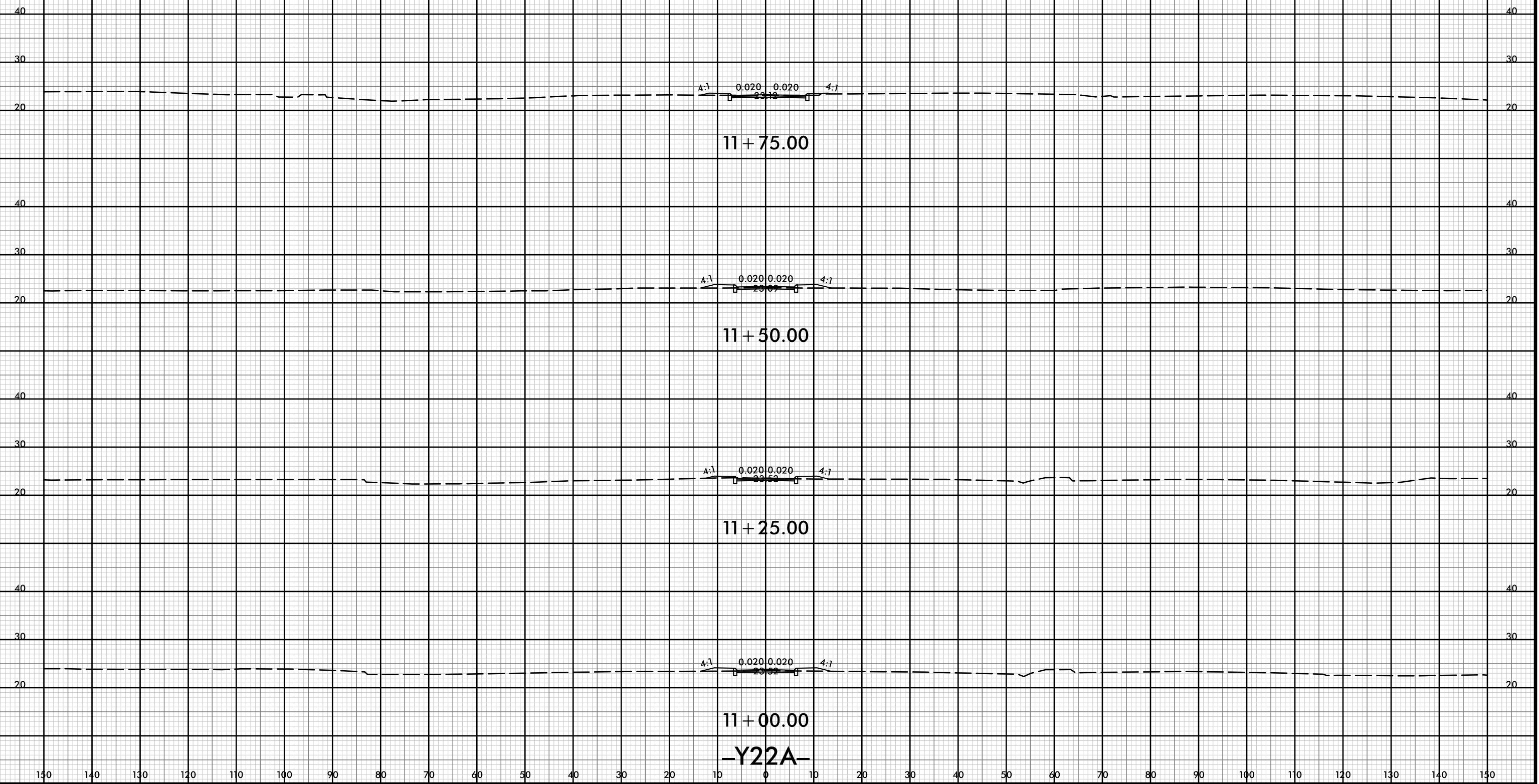

11 + 75.00

11 + 50.00

11 + 25.00

11 + 00.00

-Y22A-



150 140 130 120 110 100 90 80 70 60 50 40 30 20 10 0 10 20 30 40 50 60 70 80 90 100 110 120 130 140 150

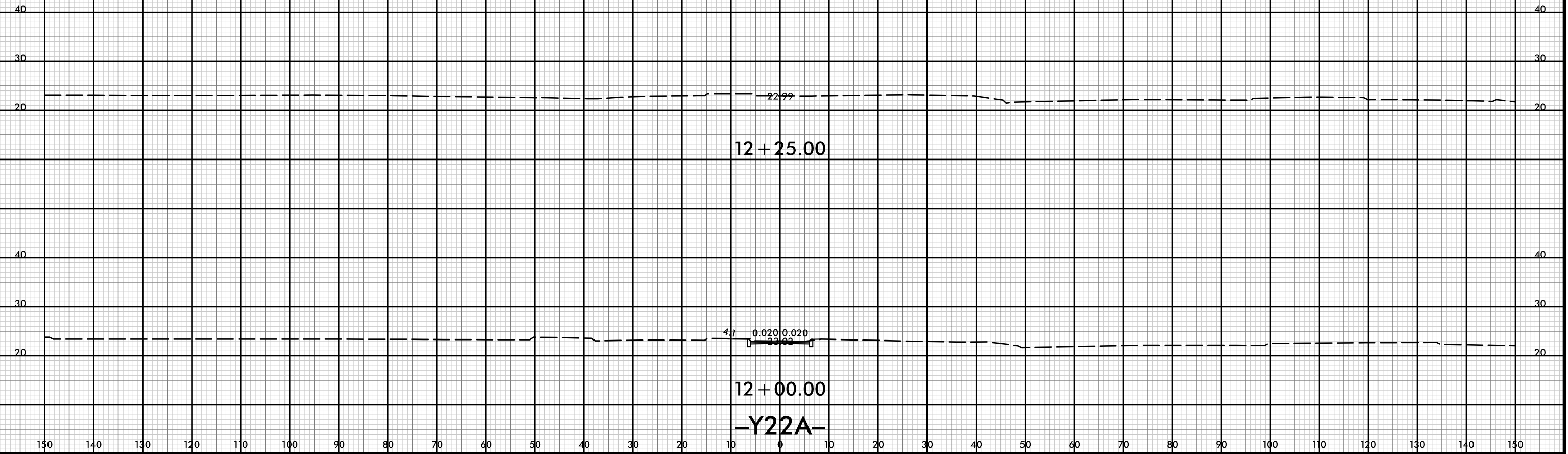

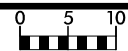

150 140 130 120 110 100 90 80 70 60 50 40 30 20 10 0 10 20 30 40 50 60 70 80 90 100 110 120 130 140 150

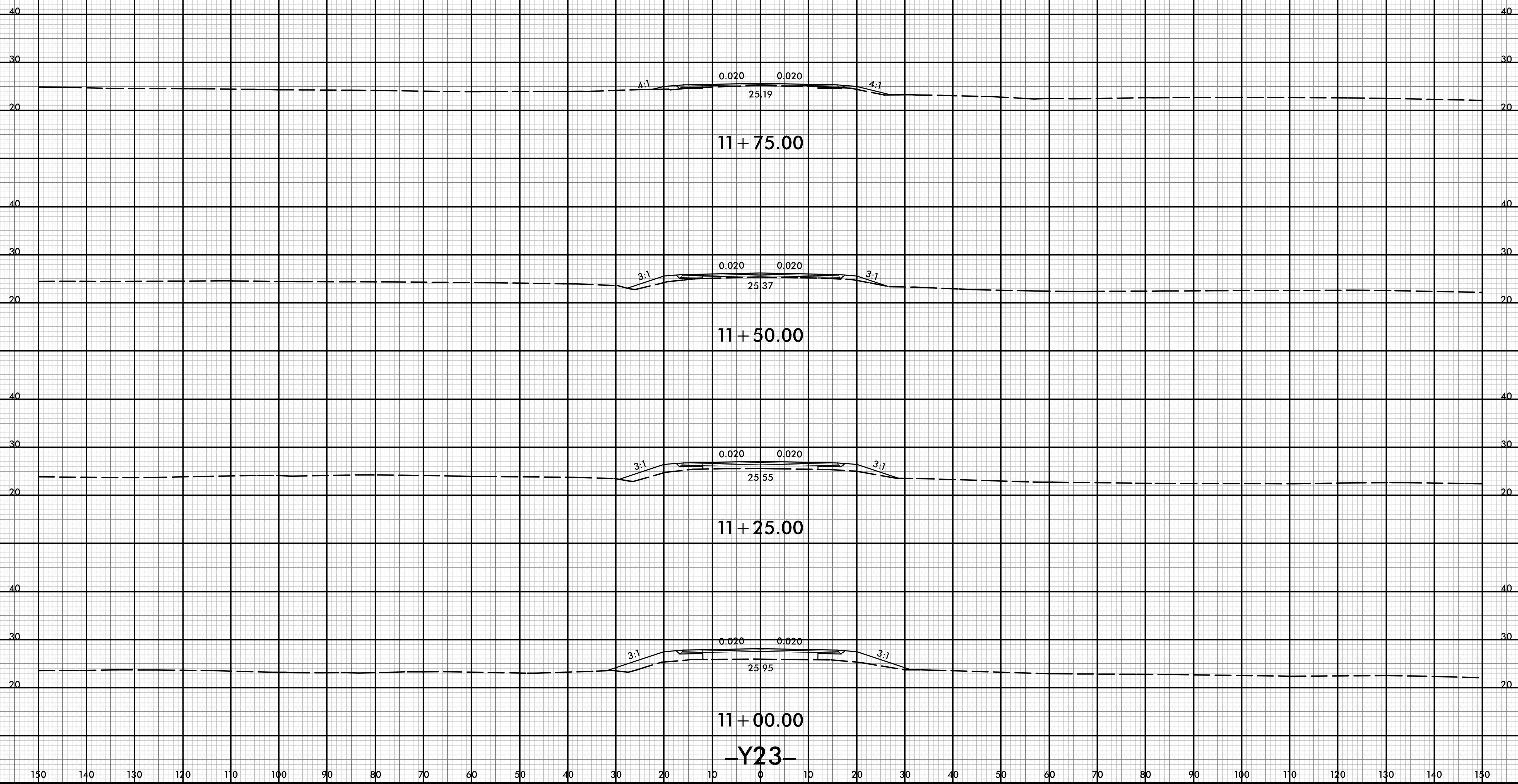

150 140 130 120 110 100 90 80 70 60 50 40 30 20 10 0 10 20 30 40 50 60 70 80 90 100 110 120 130 140 150



150 140 130 120 110 100 90 80 70 60 50 40 30 20 10 0 10 20 30 40 50 60 70 80 90 100 110 120 130 140 150

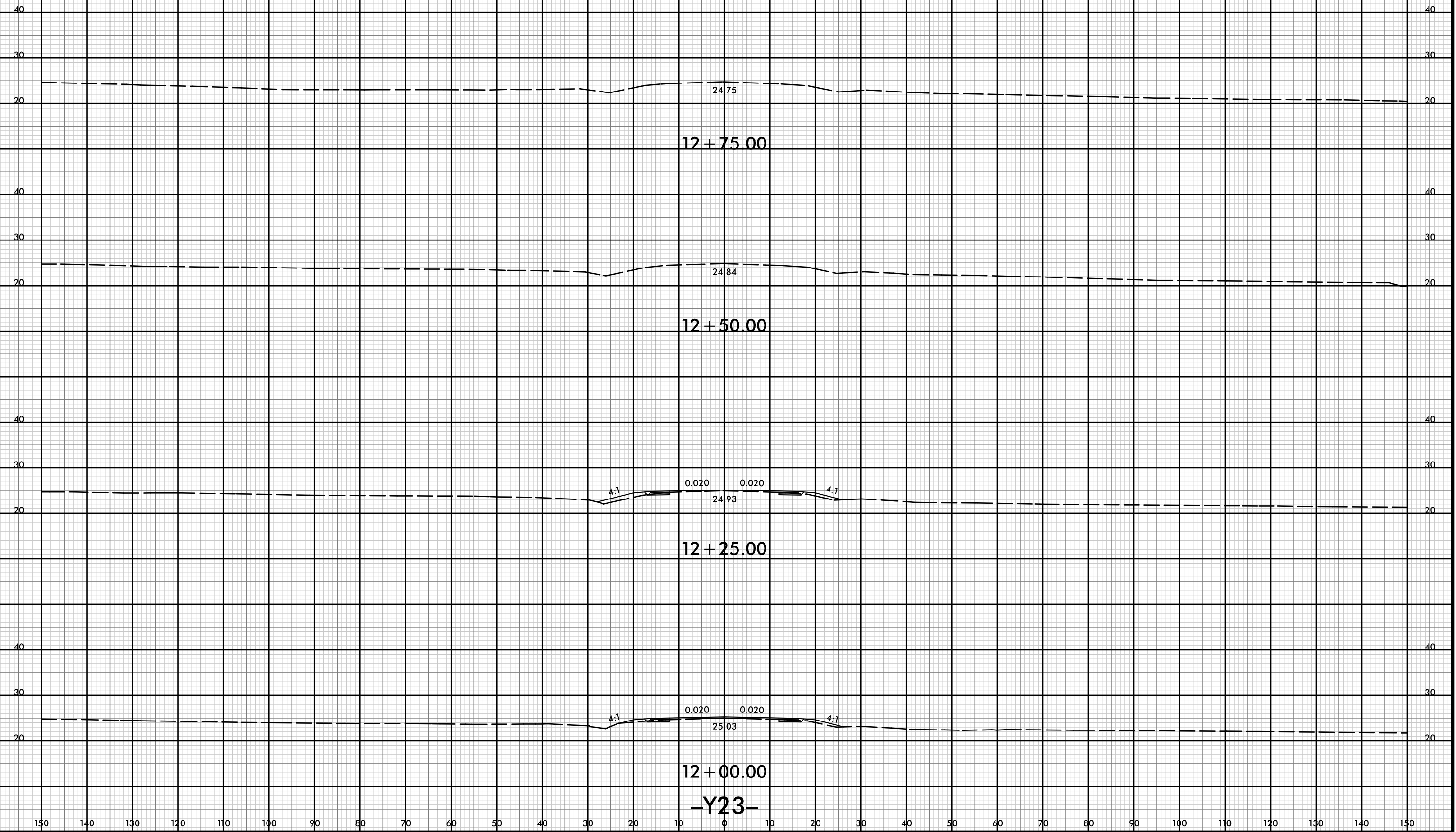

24.75

12 + 75.00

24.84

12 + 50.00

4:1

0.020 0.020
24.93

12 + 25.00

4:1

0.020 0.020
25.03

12 + 00.00

-Y23-

150 140 130 120 110 100 90 80 70 60 50 40 30 20 10 0 10 20 30 40 50 60 70 80 90 100 110 120 130 140 150



150 140 130 120 110 100 90 80 70 60 50 40 30 20 10 0 10 20 30 40 50 60 70 80 90 100 110 120 130 140 150

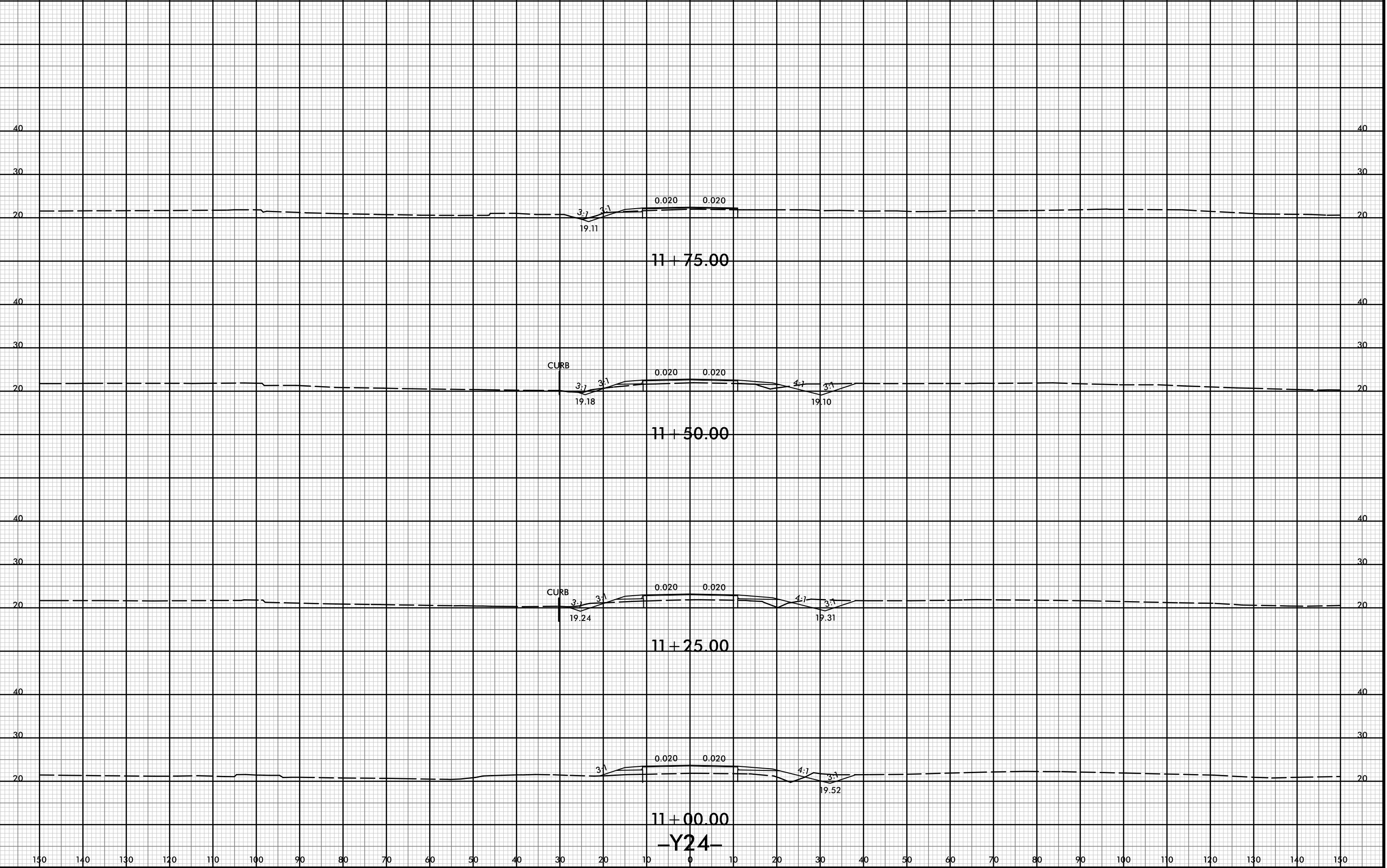

150 140 130 120 110 100 90 80 70 60 50 40 30 20 10 0 10 20 30 40 50 60 70 80 90 100 110 120 130 140 150

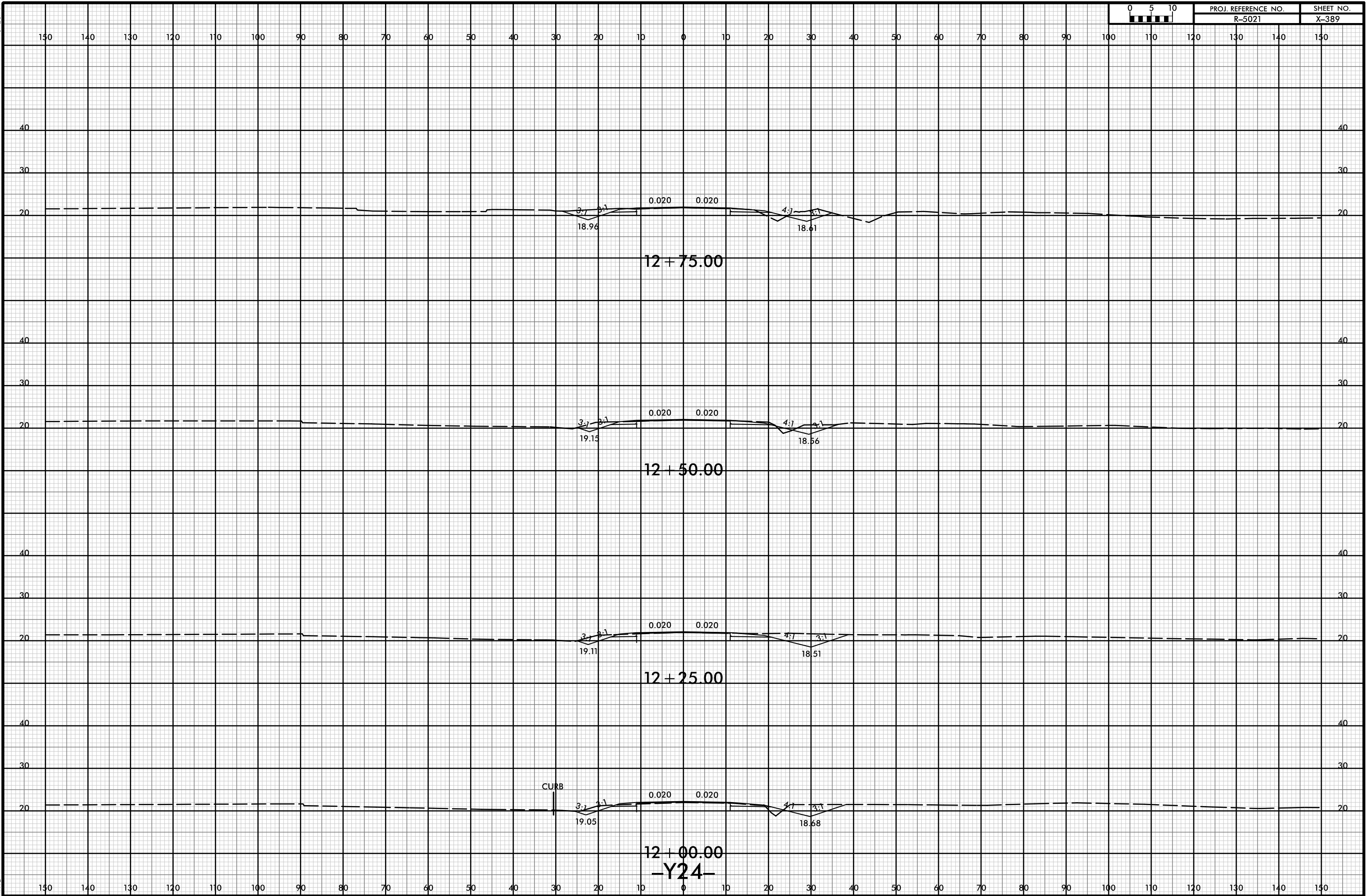



150 140 130 120 110 100 90 80 70 60 50 40 30 20 10 0 10 20 30 40 50 60 70 80 90 100 110 120 130 140 150

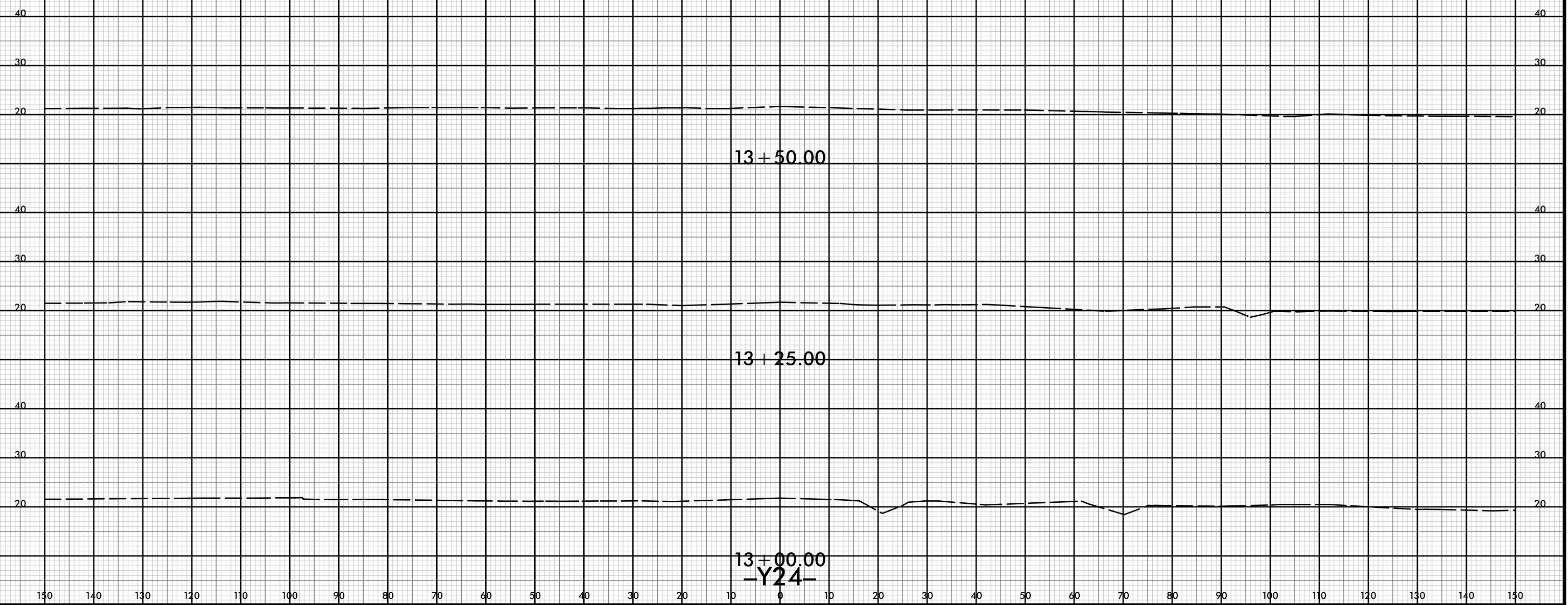

8/23/99

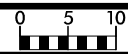

PROJ. REFERENCE NO.
R-5021

SHEET NO.
X-391

150 140 130 120 110 100 90 80 70 60 50 40 30 20 10 0 10 20 30 40 50 60 70 80 90 100 110 120 130 140 150

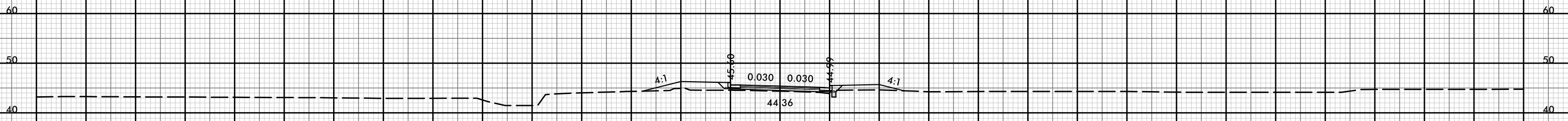

10+75.00

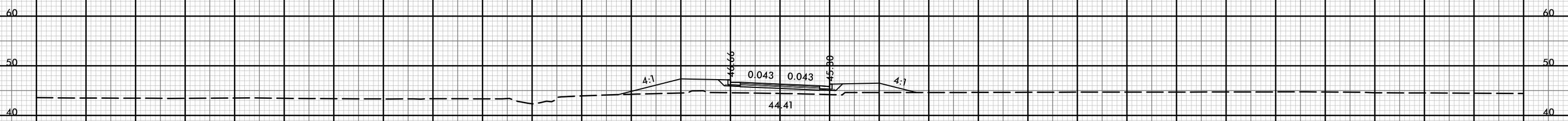

10+50.00

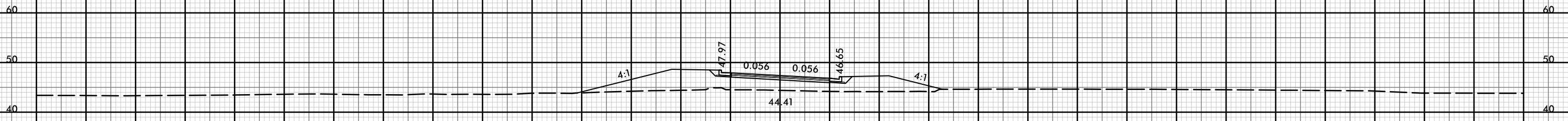

10+25.00

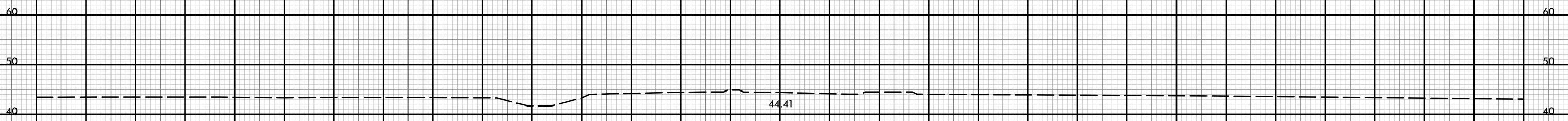

10+00.00

DRW01

SHALLOW UNDERCUT EXCAVATION

21-Jul-2021 10:40
\\P01dwej\XSC\5021-rdy-xp1-DRW01.dgn
HTB

150 140 130 120 110 100 90 80 70 60 50 40 30 20 10 0 10 20 30 40 50 60 70 80 90 100 110 120 130 140 150

8/23/99



PROJ. REFERENCE NO.
R-5021

SHEET NO.
X-392

150 140 130 120 110 100 90 80 70 60 50 40 30 20 10 0 10 20 30 40 50 60 70 80 90 100 110 120 130 140 150

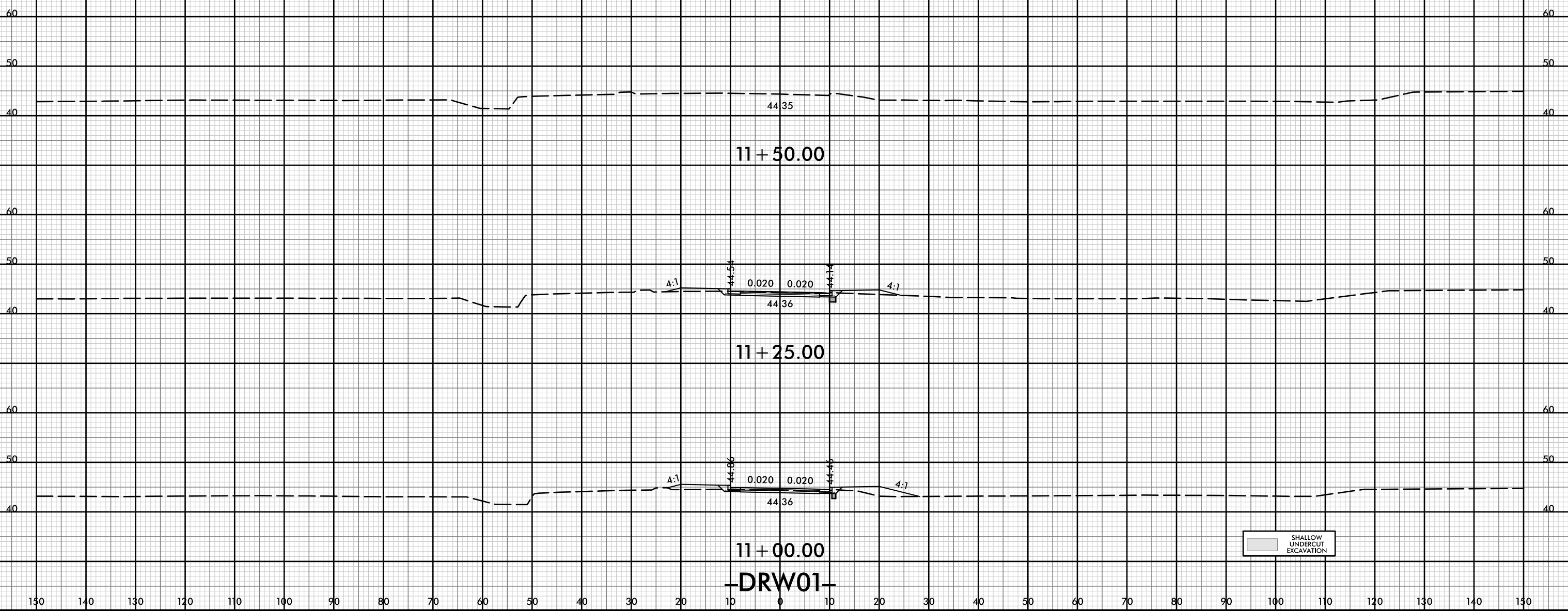

DRW01

21-JUL-2021 10:40
\\P01dwej\XSC\5021-rdy-xp1-DRW01.dgn
HTB



150 140 130 120 110 100 90 80 70 60 50 40 30 20 10 0 10 20 30 40 50 60 70 80 90 100 110 120 130 140 150

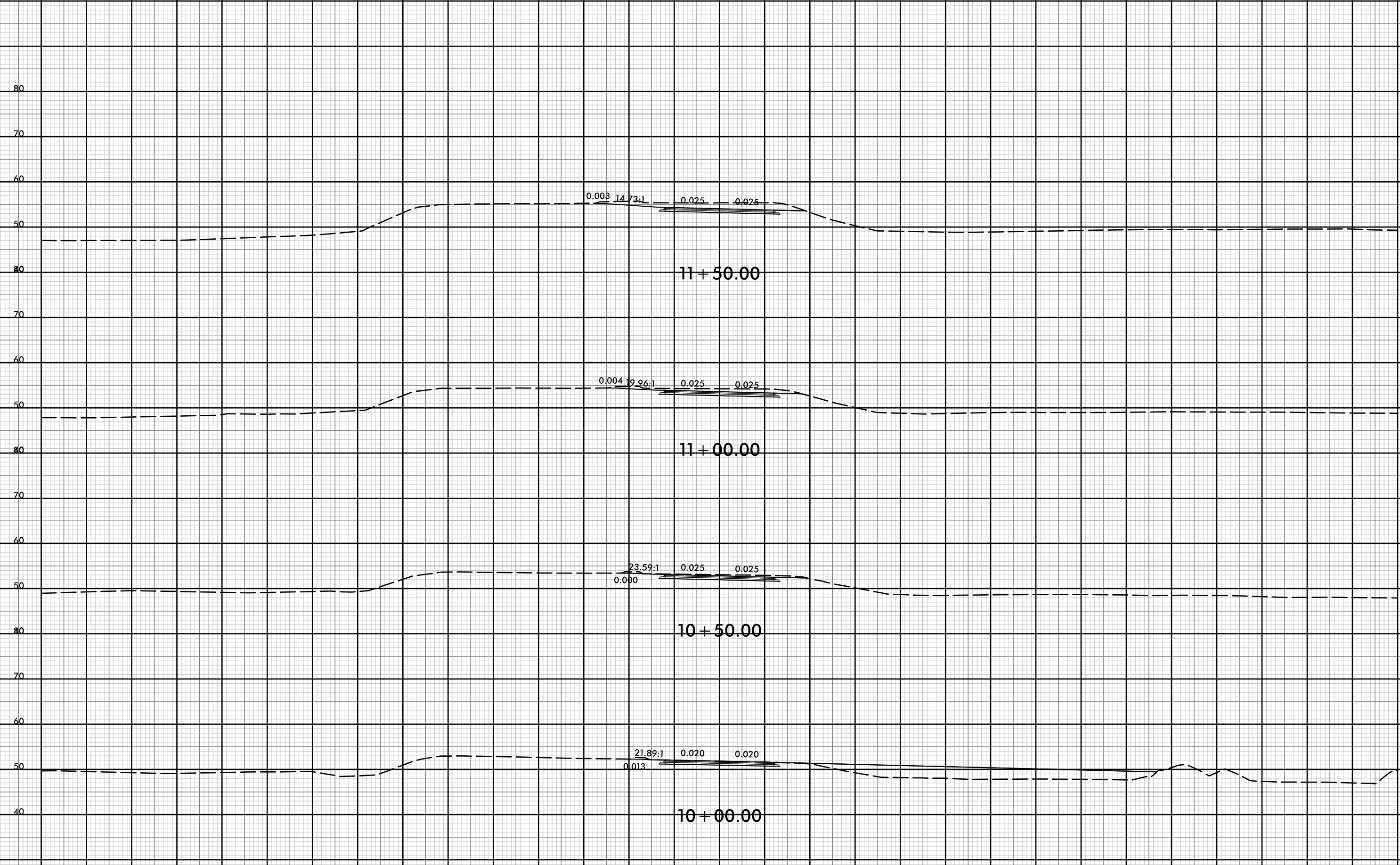

11 + 50.00

11 + 00.00

10 + 50.00

10 + 00.00

-YREVTCP1-

150 140 130 120 110 100 90 80 70 60 50 40 30 20 10 0 10 20 30 40 50 60 70 80 90 100 110 120 130 140 150

8/23/99



PROJ. REFERENCE NO.	SHEET NO.
R-5021	X-394

150 140 130 120 110 100 90 80 70 60 50 40 30 20 10 0 10 20 30 40 50 60 70 80 90 100 110 120 130 140 150

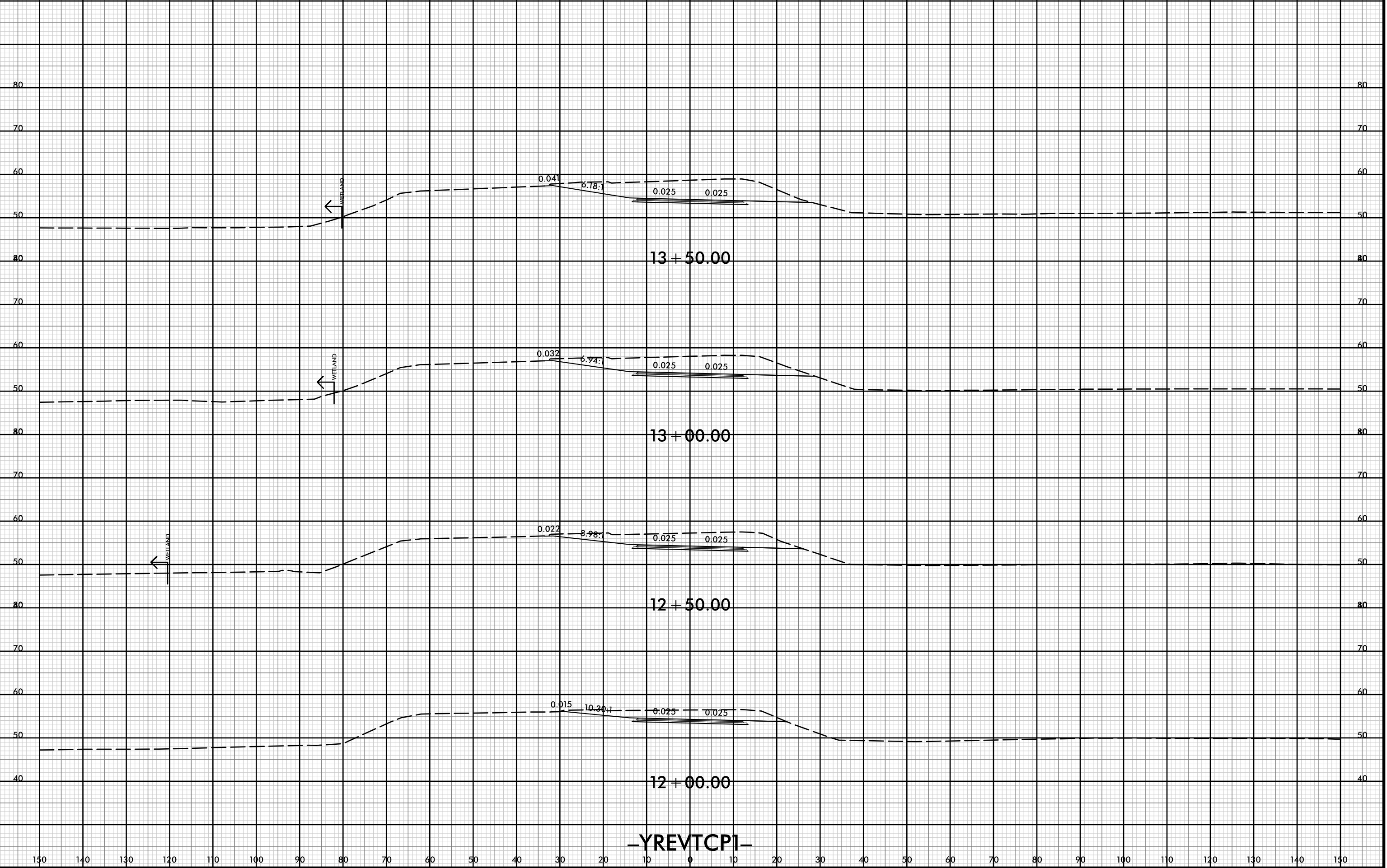

-YREVTCP1-

150 140 130 120 110 100 90 80 70 60 50 40 30 20 10 0 10 20 30 40 50 60 70 80 90 100 110 120 130 140 150

21-Jul-2021 10:40
 R:\p\dawej\XSC\5021-rdy-xp1-YREVTCP1.dgn
 HNTB



150 140 130 120 110 100 90 80 70 60 50 40 30 20 10 0 10 20 30 40 50 60 70 80 90 100 110 120 130 140 150

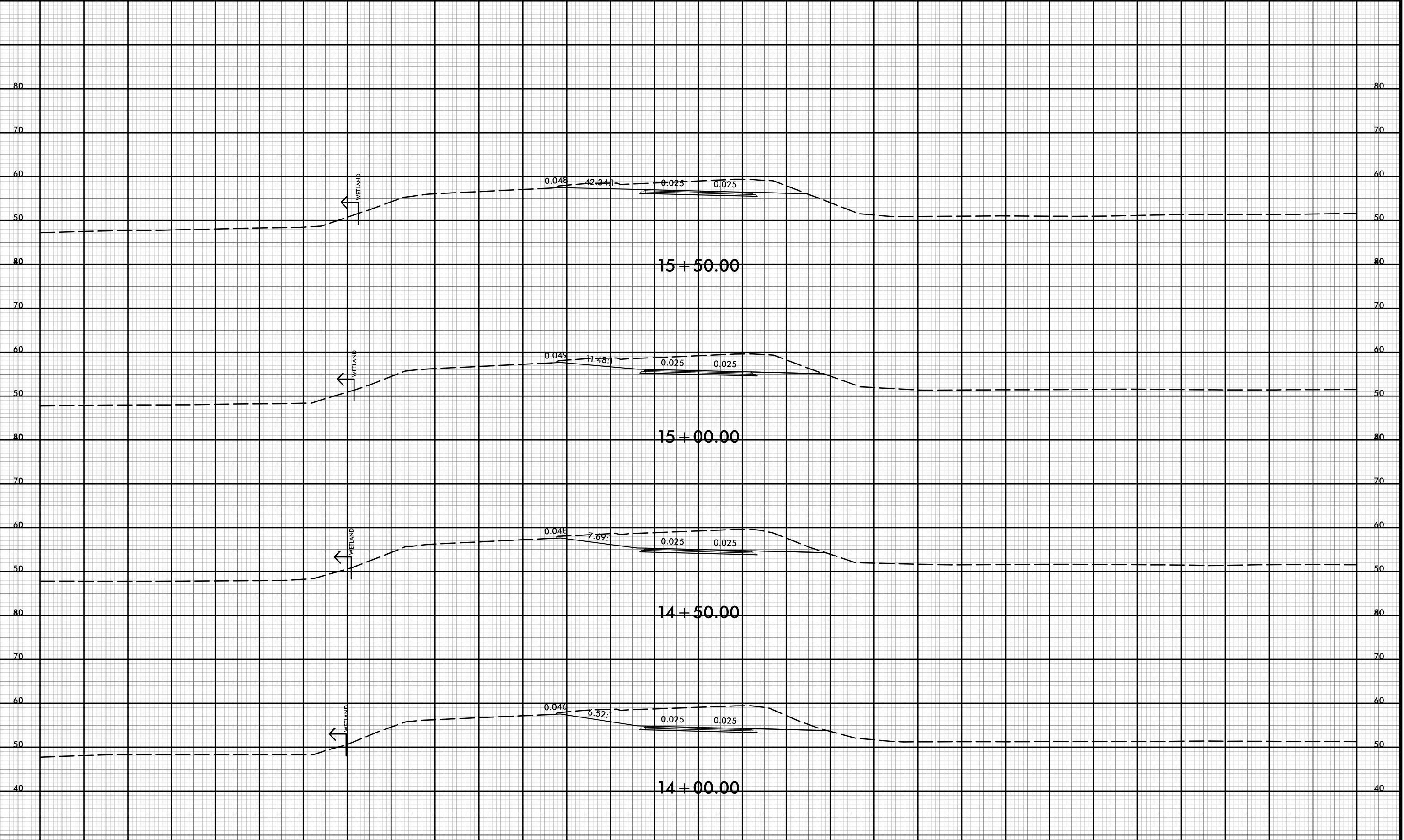

-YREVTCP1-

150 140 130 120 110 100 90 80 70 60 50 40 30 20 10 0 10 20 30 40 50 60 70 80 90 100 110 120 130 140 150



150 140 130 120 110 100 90 80 70 60 50 40 30 20 10 0 10 20 30 40 50 60 70 80 90 100 110 120 130 140 150

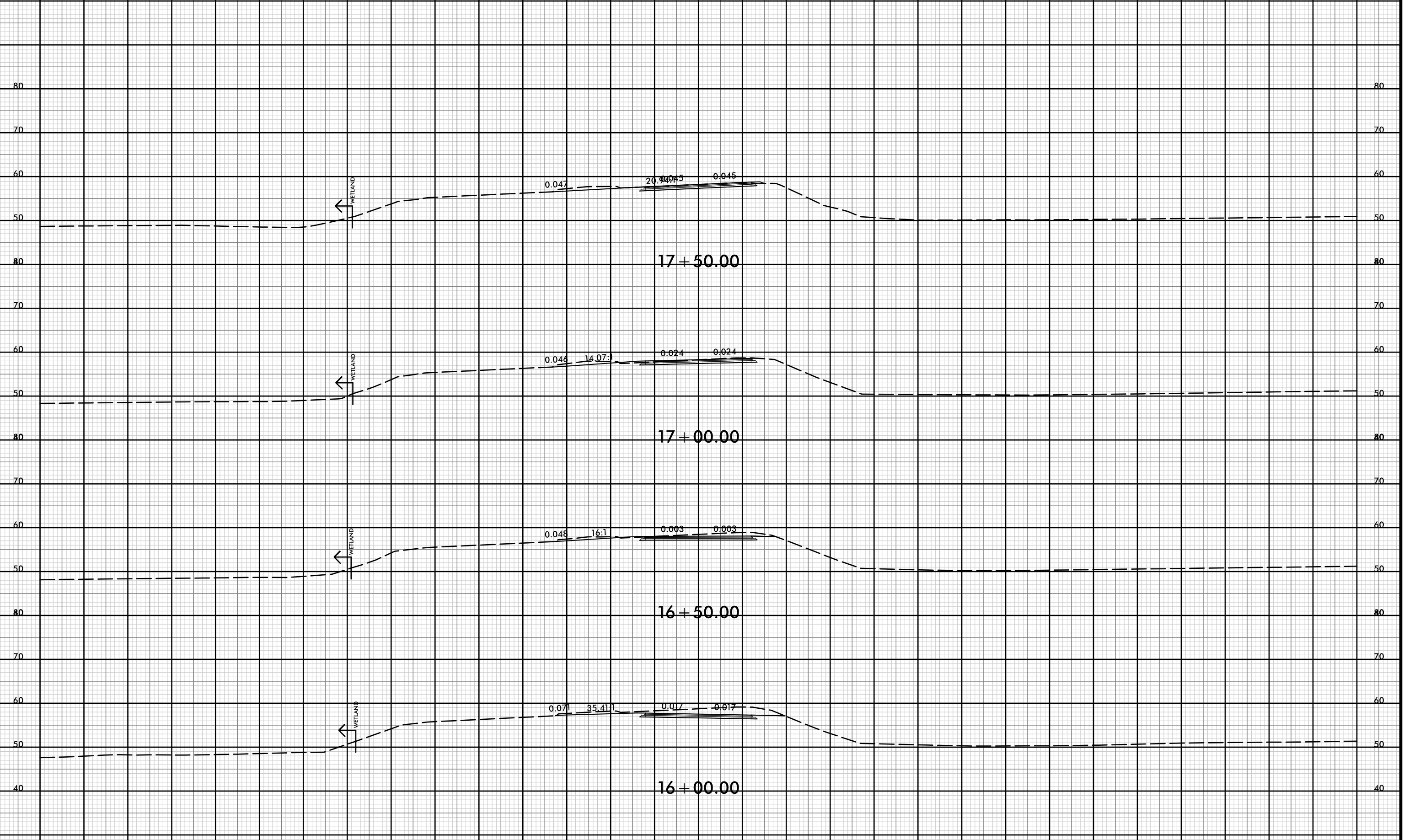

-YREVTCP1-

150 140 130 120 110 100 90 80 70 60 50 40 30 20 10 0 10 20 30 40 50 60 70 80 90 100 110 120 130 140 150



PROJ. REFERENCE NO.
R-5021

SHEET NO.
X-397

150 140 130 120 110 100 90 80 70 60 50 40 30 20 10 0 10 20 30 40 50 60 70 80 90 100 110 120 130 140 150

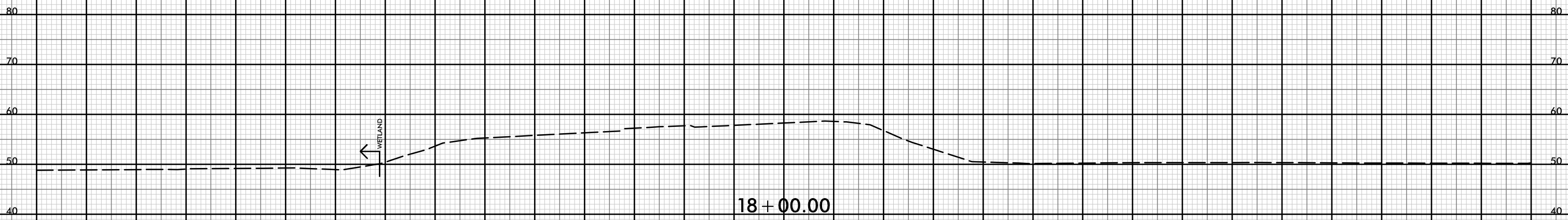

18 + 00.00
-YREVTCP1-



150 140 130 120 110 100 90 80 70 60 50 40 30 20 10 0 10 20 30 40 50 60 70 80 90 100 110 120 130 140 150

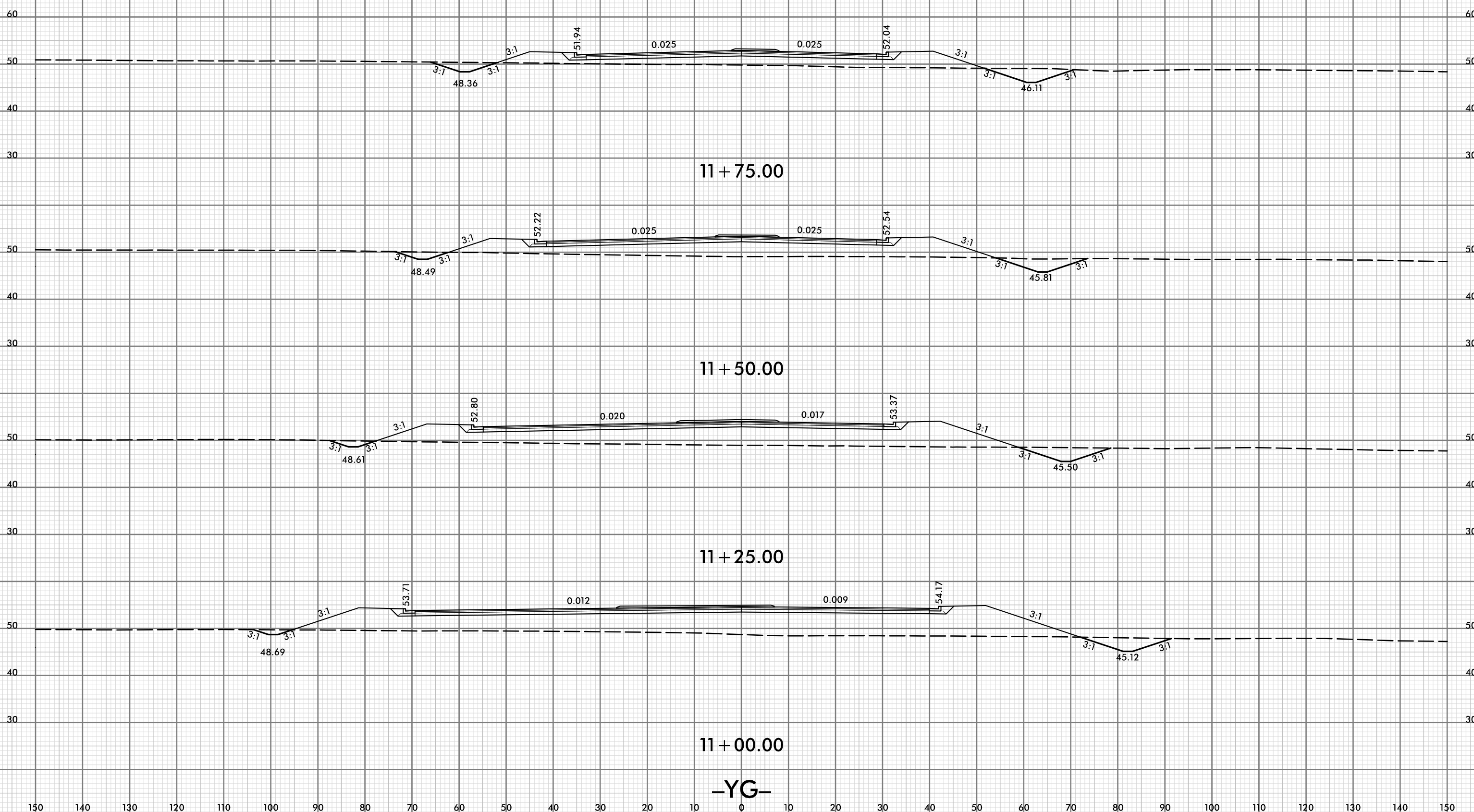

-YG-



150 140 130 120 110 100 90 80 70 60 50 40 30 20 10 0 10 20 30 40 50 60 70 80 90 100 110 120 130 140 150

60 60

50 50

40 40

12 + 75.00

60 60

50 50

40 40

12 + 50.00

60 60

50 50

40 40

12 + 25.00

60 60

50 50

40 40

12 + 00.00

-YG-

150 140 130 120 110 100 90 80 70 60 50 40 30 20 10 0 10 20 30 40 50 60 70 80 90 100 110 120 130 140 150

3:1

51.44

0.025

0.025

51.44

3:1

3:1

48.11

3:1

51.49

0.025

0.025

51.49

3:1

46.72

3:1

3:1

48.24

3:1

51.69

0.025

0.025

51.70

3:1

46.42

3:1



150 140 130 120 110 100 90 80 70 60 50 40 30 20 10 0 10 20 30 40 50 60 70 80 90 100 110 120 130 140 150

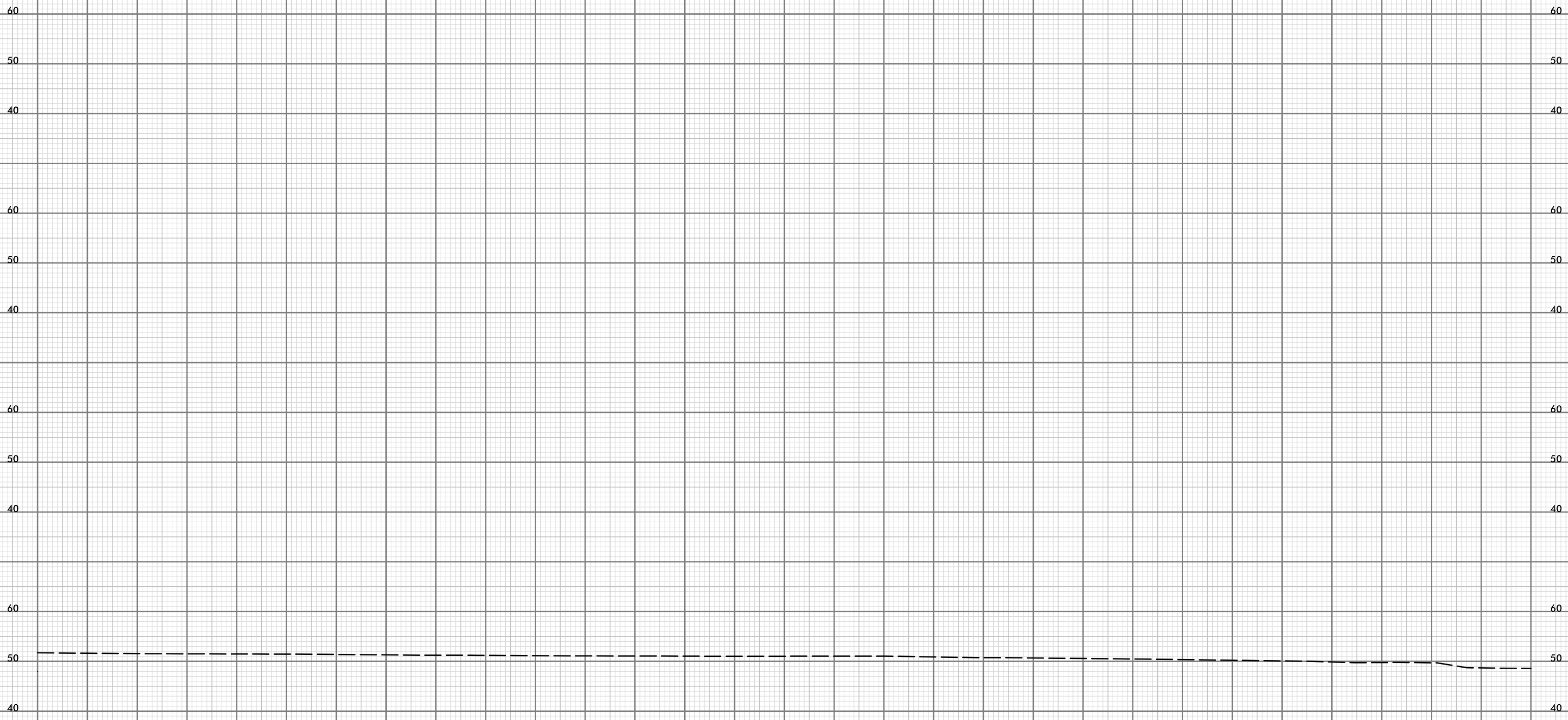

13 + 00.00
-YG-

150 140 130 120 110 100 90 80 70 60 50 40 30 20 10 0 10 20 30 40 50 60 70 80 90 100 110 120 130 140 150



150 140 130 120 110 100 90 80 70 60 50 40 30 20 10 0 10 20 30 40 50 60 70 80 90 100 110 120 130 140 150

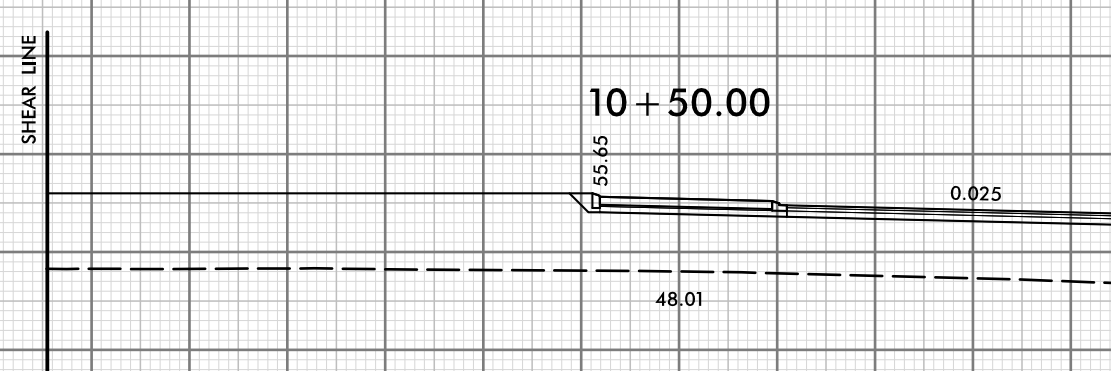
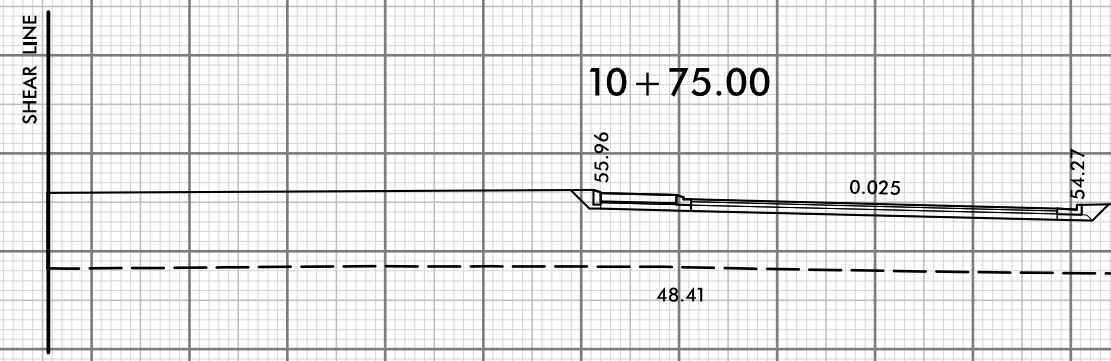
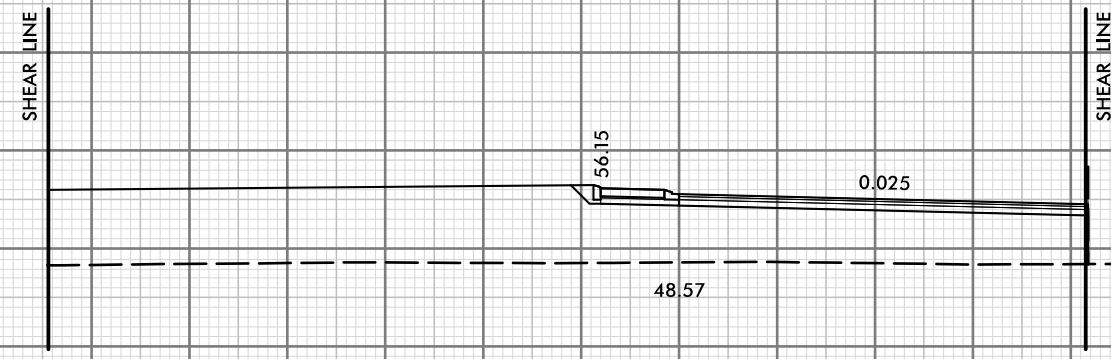

10 + 00.00
-RAB-

150 140 130 120 110 100 90 80 70 60 50 40 30 20 10 0 10 20 30 40 50 60 70 80 90 100 110 120 130 140 150



150 140 130 120 110 100 90 80 70 60 50 40 30 20 10 0 10 20 30 40 50 60 70 80 90 100 110 120 130 140 150

SHEAR LINE

SHEAR LINE

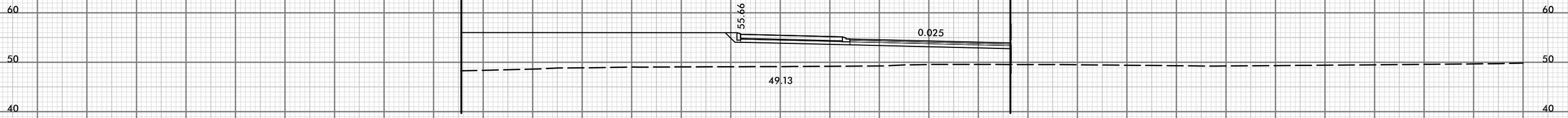

11 + 75.00

SHEAR LINE

SHEAR LINE

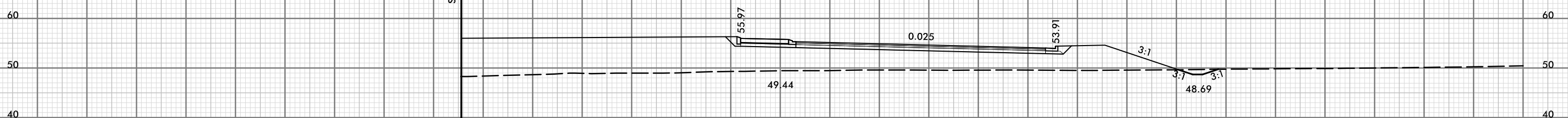

11 + 50.00

SHEAR LINE

SHEAR LINE

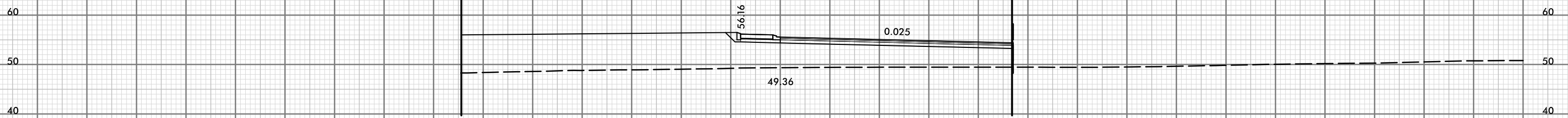

11 + 25.00

SHEAR LINE

SHEAR LINE

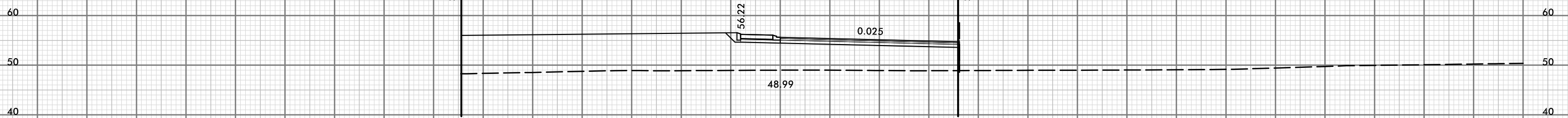

11 + 00.00
-RAB-

150 140 130 120 110 100 90 80 70 60 50 40 30 20 10 0 10 20 30 40 50 60 70 80 90 100 110 120 130 140 150

150 140 130 120 110 100 90 80 70 60 50 40 30 20 10 0 10 20 30 40 50 60 70 80 90 100 110 120 130 140 150

SHEAR LINE

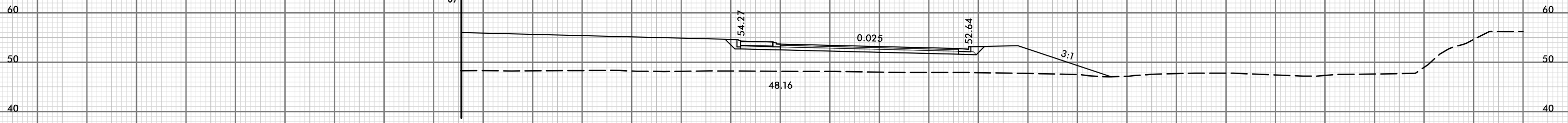

SHEAR LINE

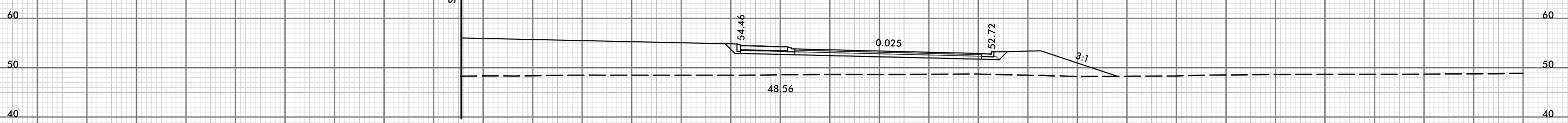

SHEAR LINE

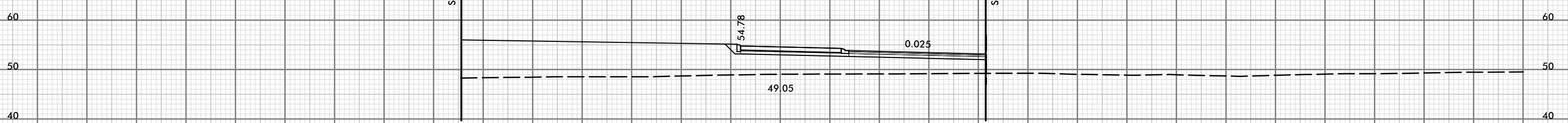

SHEAR LINE

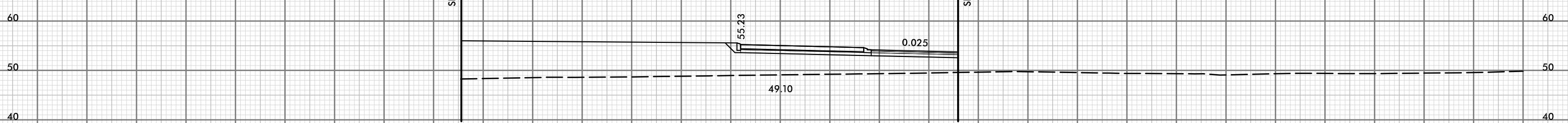

12 + 00.00
-RAB-

150 140 130 120 110 100 90 80 70 60 50 40 30 20 10 0 10 20 30 40 50 60 70 80 90 100 110 120 130 140 150



150 140 130 120 110 100 90 80 70 60 50 40 30 20 10 0 10 20 30 40 50 60 70 80 90 100 110 120 130 140 150

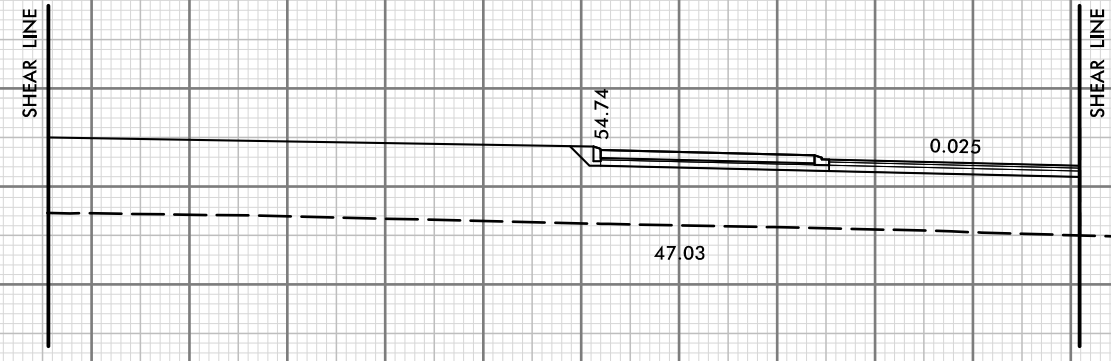

13 + 75.00

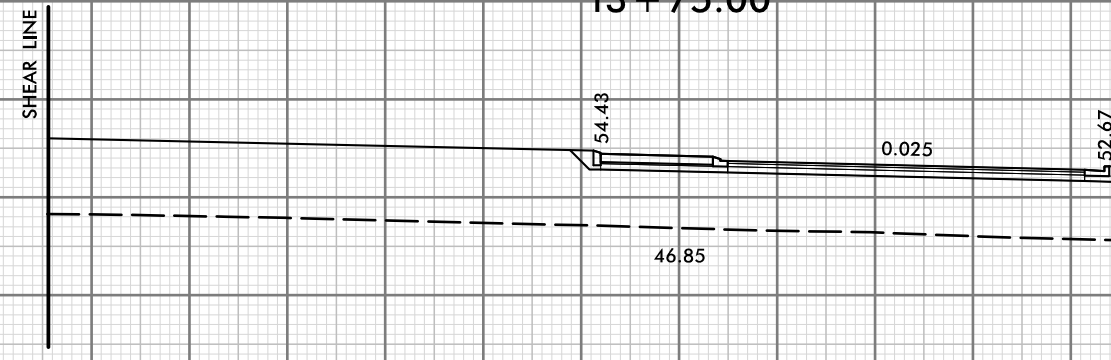

13 + 50.00

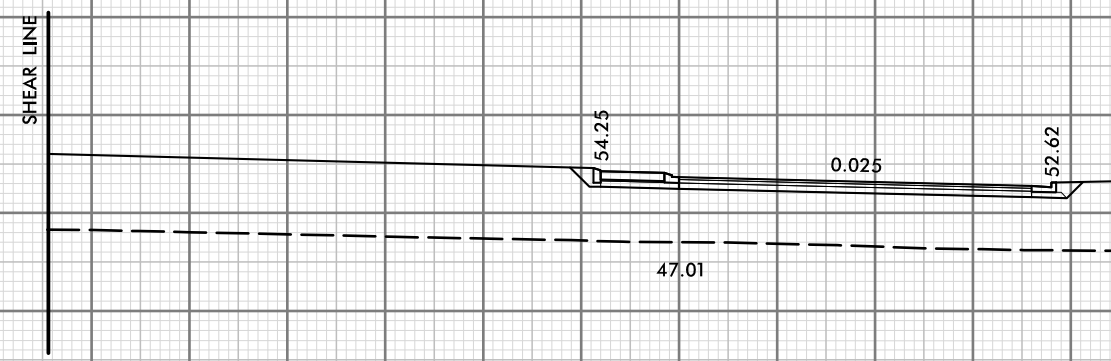

13 + 25.00

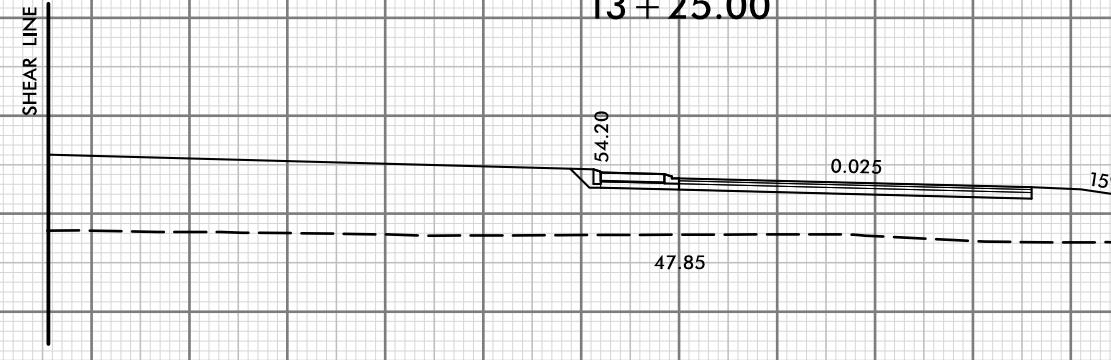

13 + 00.00

-RAB-

150 140 130 120 110 100 90 80 70 60 50 40 30 20 10 0 10 20 30 40 50 60 70 80 90 100 110 120 130 140 150



150 140 130 120 110 100 90 80 70 60 50 40 30 20 10 0 10 20 30 40 50 60 70 80 90 100 110 120 130 140 150

60 60

50 50

40 40

60 60

50 50

40 40

60 60

50 50

40 40

60 60

50 50

40 40

SHEAR LINE

SHEAR LINE

55.17

0.025

47.39

14 + 00.00
-RAB-

150 140 130 120 110 100 90 80 70 60 50 40 30 20 10 0 10 20 30 40 50 60 70 80 90 100 110 120 130 140 150