

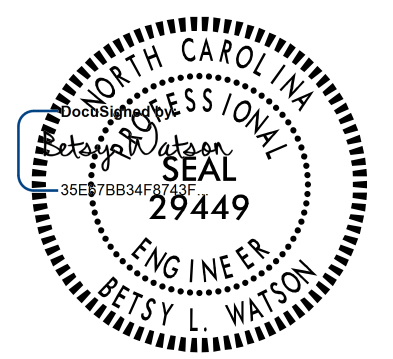

PROJECT NOTES

- 1 DISPOSAL OF SIGN SYSTEM, OVERHEAD
- 2 DISPOSAL OF SIGN SYSTEM, STEEL BEAM
- 3 DISPOSAL OF SIGN SYSTEM, U-CHANNEL
- 4 DISPOSAL OF SIGN, A OR B (OVERHEAD)
- 5 DISPOSAL OF SIGN, D, E OR F
- 6 DISPOSAL OF LIGHTING SYSTEM
- 7 DISPOSAL OF WALKWAY

- 8 SIGN ERECTION, TYPE A (OVERHEAD)
- 9 SIGN ERECTION, TYPE B (OVERHEAD)
- 10 SIGN ERECTION, TYPE A (GROUND MOUNTED)
- 11 SIGN ERECTION, TYPE D, E, AND F
- 12 SIGN ERECTION, OVERLAY (OVERHEAD)
- 13 DISPOSAL OF OVERLAY (OVERHEAD)
- 14 CUTTING OF SIGN HANGERS (OVERHEAD)

TIP NO. U-5754	SHEET NO. SIGN - 10
APPROVED: _____	
DATE: _____	
SEAL	
	
1/16/2019	
DOCUMENT NOT CONSIDERED FINAL UNLESS ALL SIGNATURES COMPLETED	
	

MATCHLINE SEE SHEET SIGN-9



I-40 WBL/BUS I-85 SBL

SEE NOTE 12
Overlay Panel #702
165" x 24"

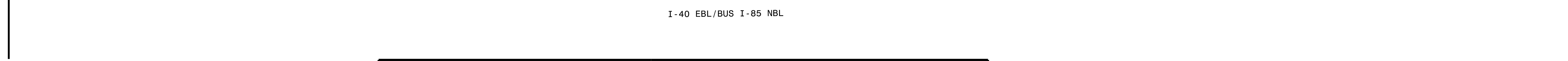
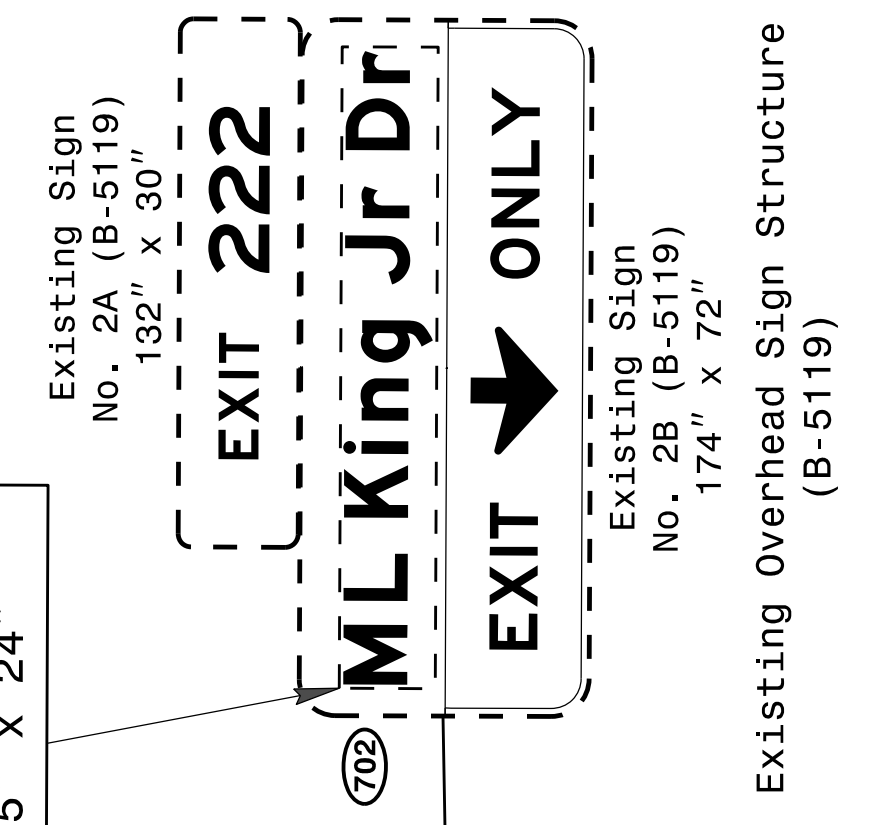

I-40 EBL/BUS I-85 NBL

MATCHLINE SEE SHEET SIGN-11

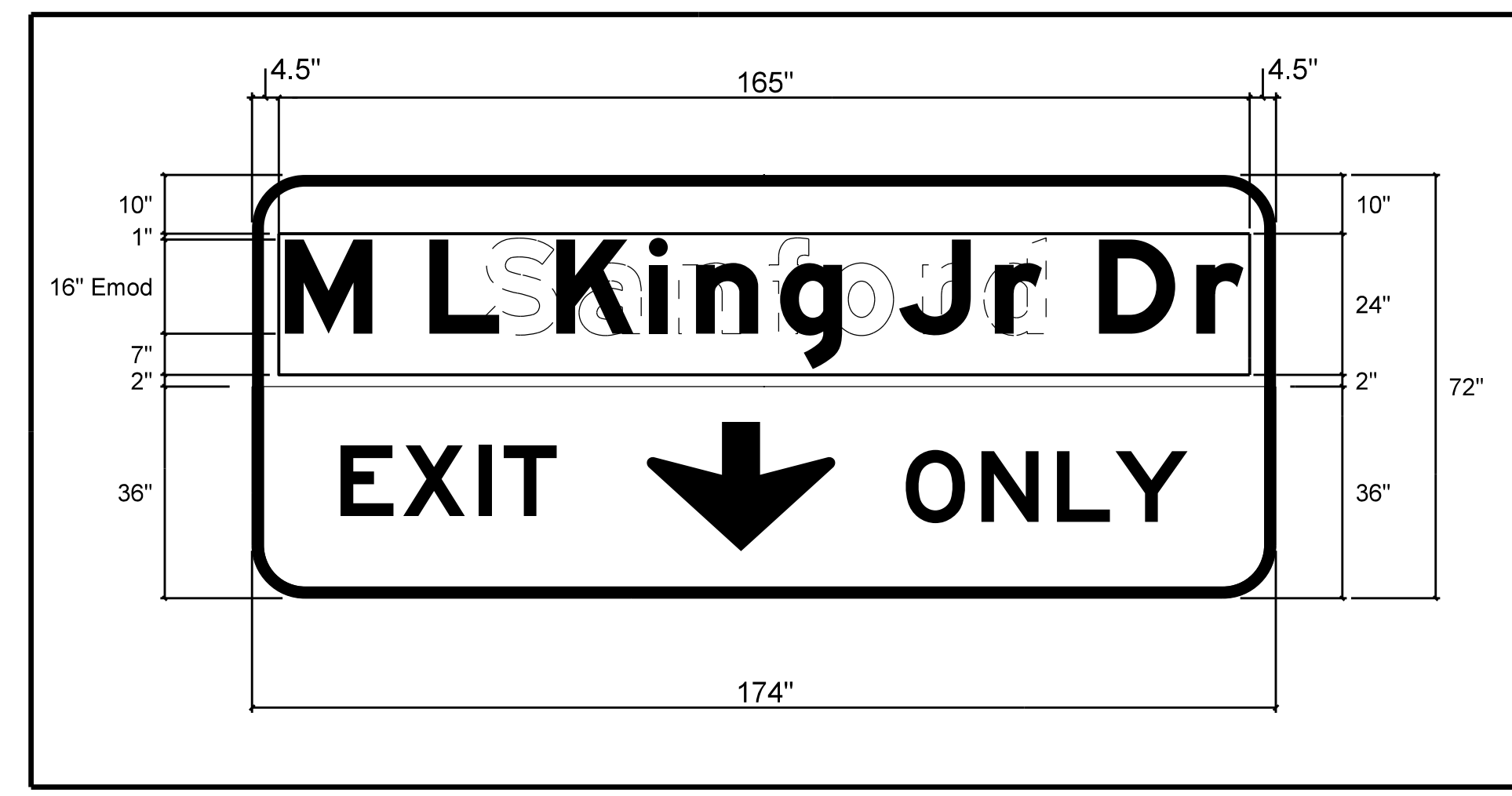

Overlay Placement Detail
Overlay Panel #702
(165" x 24")



\$\$\$\$\$SYTIME\$\$\$\$\$
\$\$\$\$\$DGN\$\$\$\$\$
\$\$\$\$\$USERNAM\$\$\$\$\$

EXISTING/PROPOSED SIGNING

PROJECT NOTES

- 1 DISPOSAL OF SIGN SYSTEM, OVERHEAD
- 2 DISPOSAL OF SIGN SYSTEM, STEEL BEAM
- 3 DISPOSAL OF SIGN SYSTEM, U-CHANNEL
- 4 DISPOSAL OF SIGN, A OR B (OVERHEAD)
- 5 DISPOSAL OF SIGN, D, E OR F
- 6 DISPOSAL OF LIGHTING SYSTEM
- 7 DISPOSAL OF WALKWAY

- 8 SIGN ERECTION, TYPE A (OVERHEAD)
- 9 SIGN ERECTION, TYPE B (OVERHEAD)
- 10 SIGN ERECTION, TYPE A (GROUND MOUNTED)
- 11 SIGN ERECTION, TYPE D, E, AND F
- 12 SIGN ERECTION, OVERLAY (OVERHEAD)
- 13 DISPOSAL OF OVERLAY (OVERHEAD)
- 14 CUTTING OF SIGN HANGERS (OVERHEAD)

TIP NO. U-5754	SHEET NO. SIGN-11
APPROVED: _____	
DATE: _____	
SEAL	
	
1/16/2019	
DOCUMENT NOT CONSIDERED FINAL UNLESS ALL SIGNATURES COMPLETED	
	

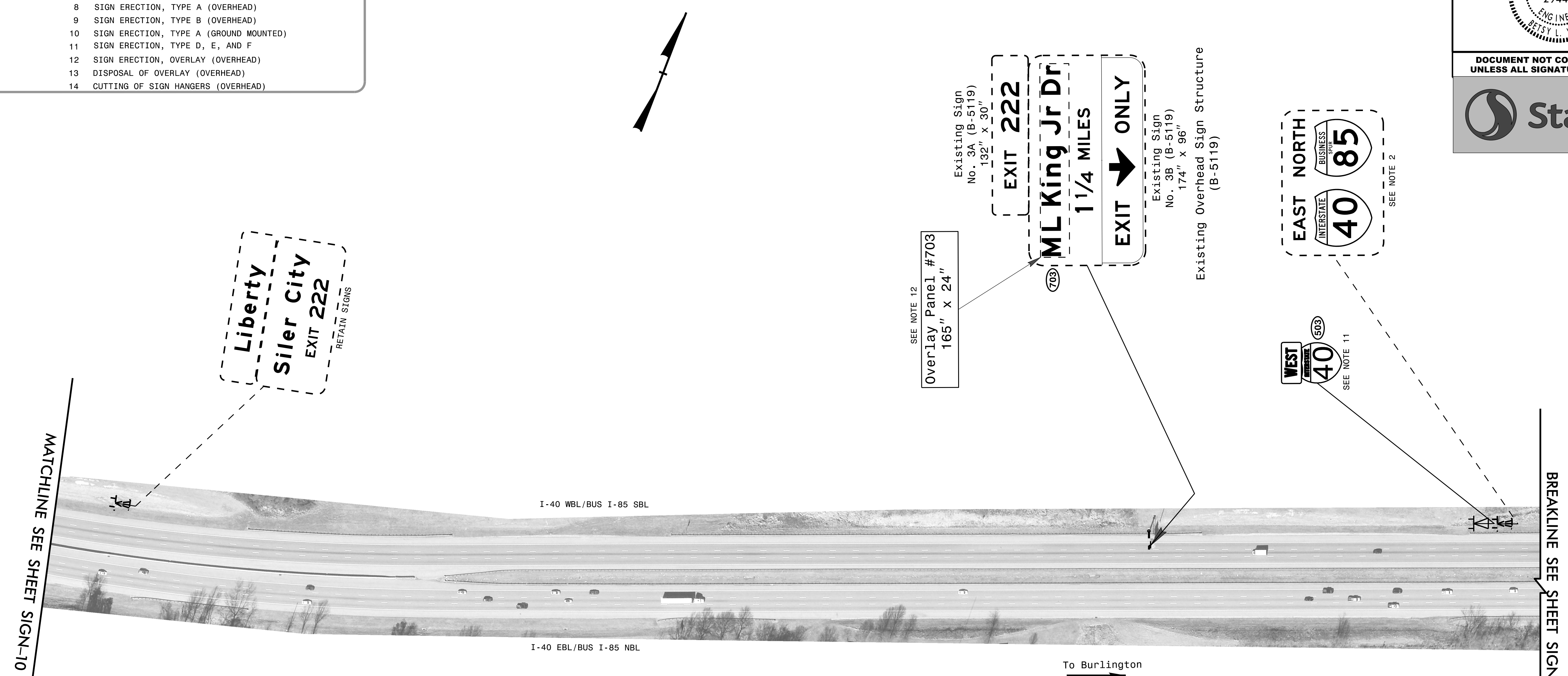

MATCHLINE SEE SHEET SIGN-10

BREAKLINE SEE SHEET SIGN-12

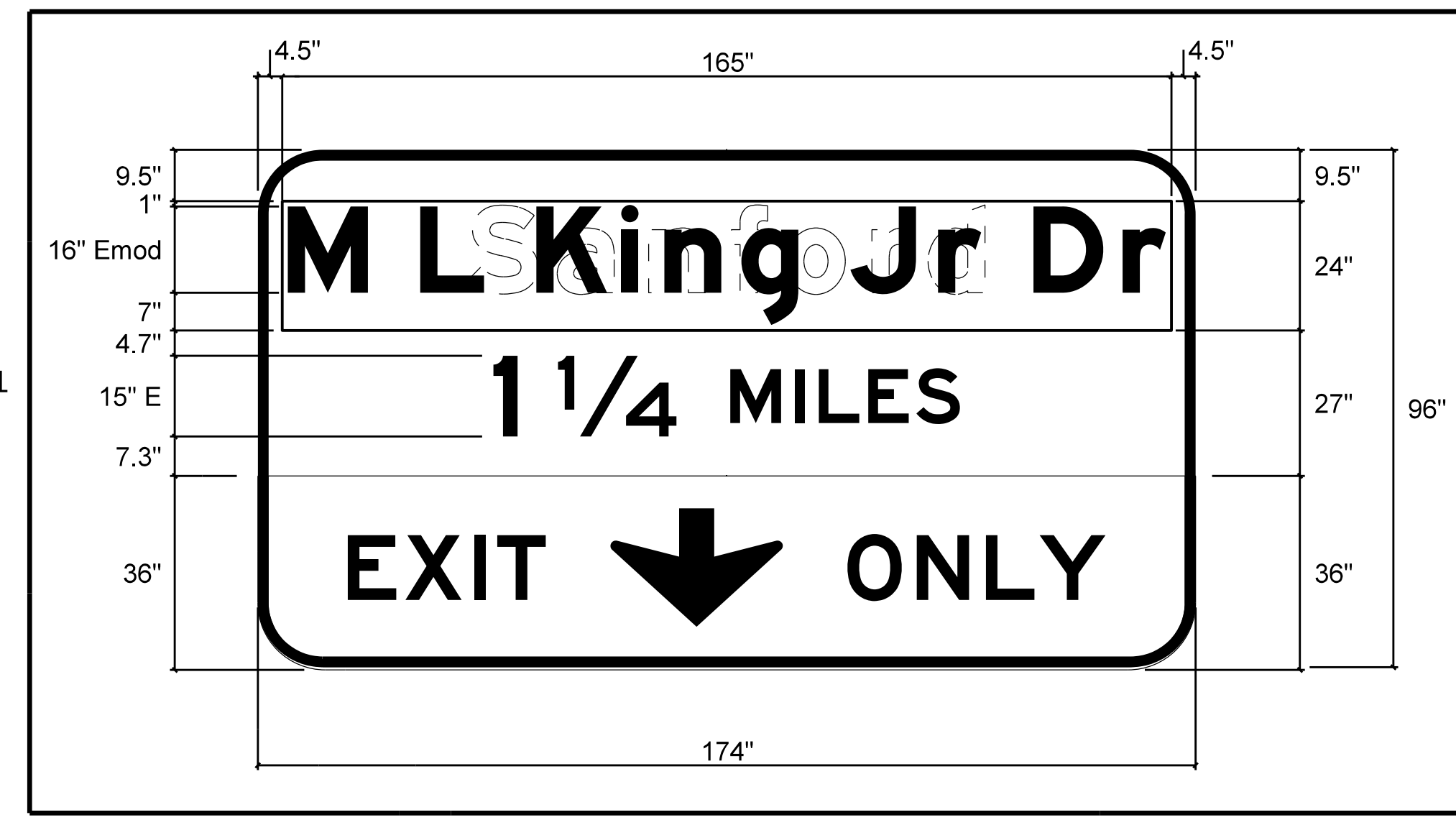

To Burlington

Overlay Placement Detail
Overlay Panel #703
(165" x 24")

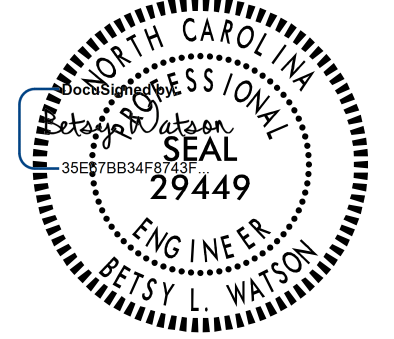

EXISTING/PROPOSED SIGNING

\$\$\$\$\$SYTIME\$\$\$\$\$
\$\$\$\$\$DGN\$\$\$\$\$
\$\$\$\$\$USERNAME\$\$\$\$\$

TIP NO. U-5754	SHEET NO. SIGN - 12
APPROVED: _____	
DATE: _____	
SEAL	
	
1/16/2019	
DOCUMENT NOT CONSIDERED FINAL UNLESS ALL SIGNATURES COMPLETED	
	

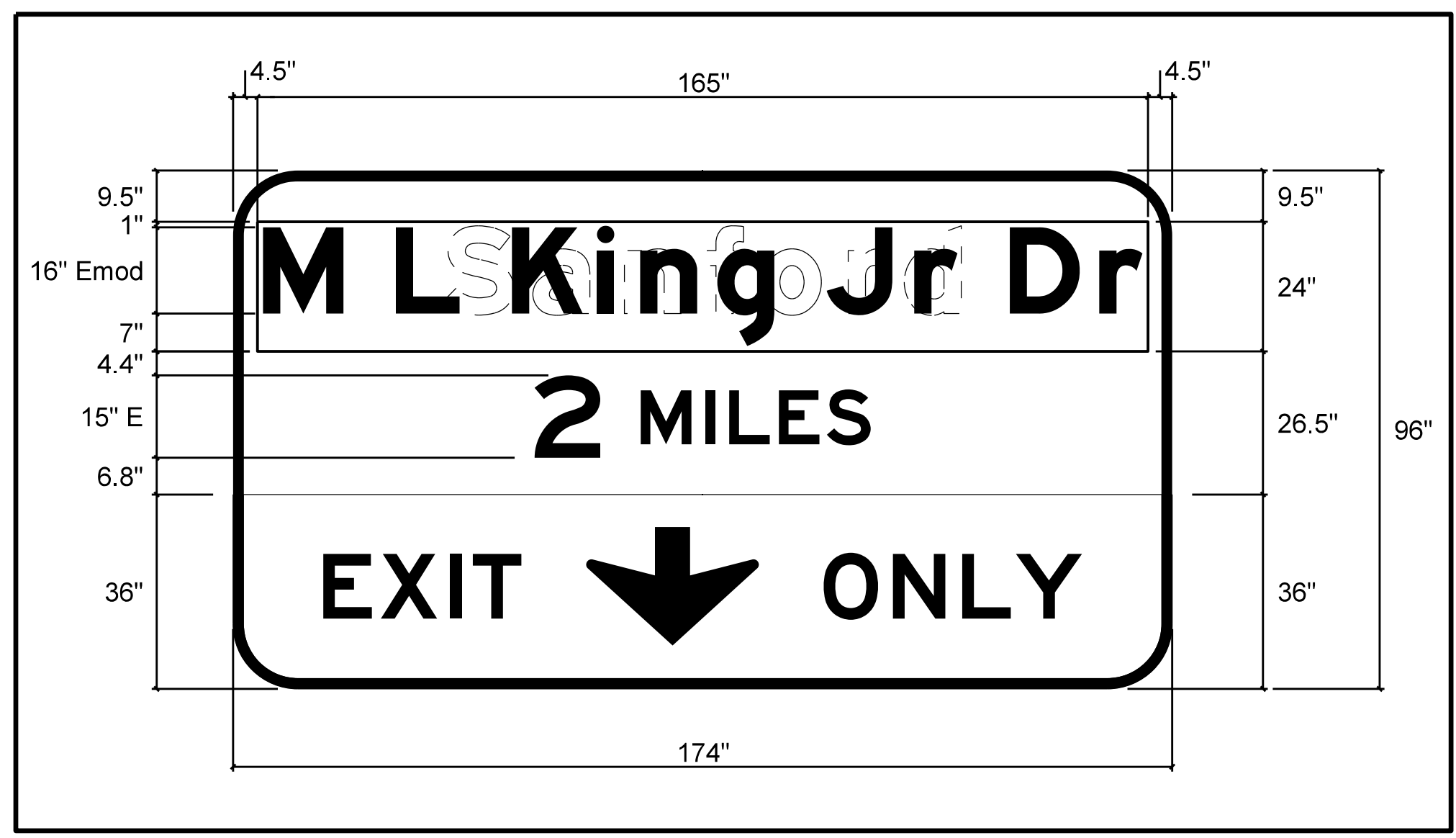

Overlay Placement Detail
Overlay Panel #704
(165" x 24")

BREAKLINE SEE SHEET SIGN-11

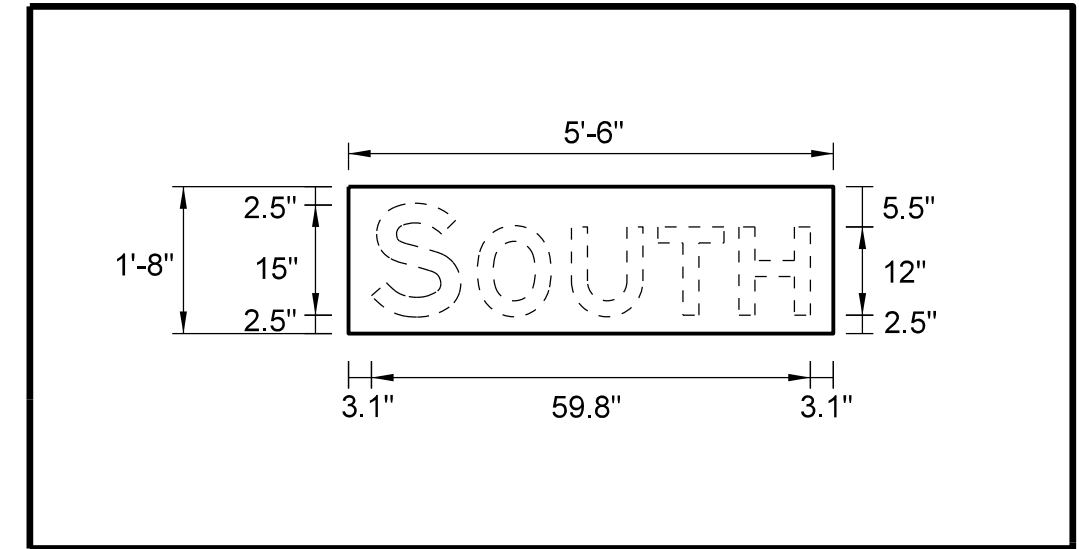
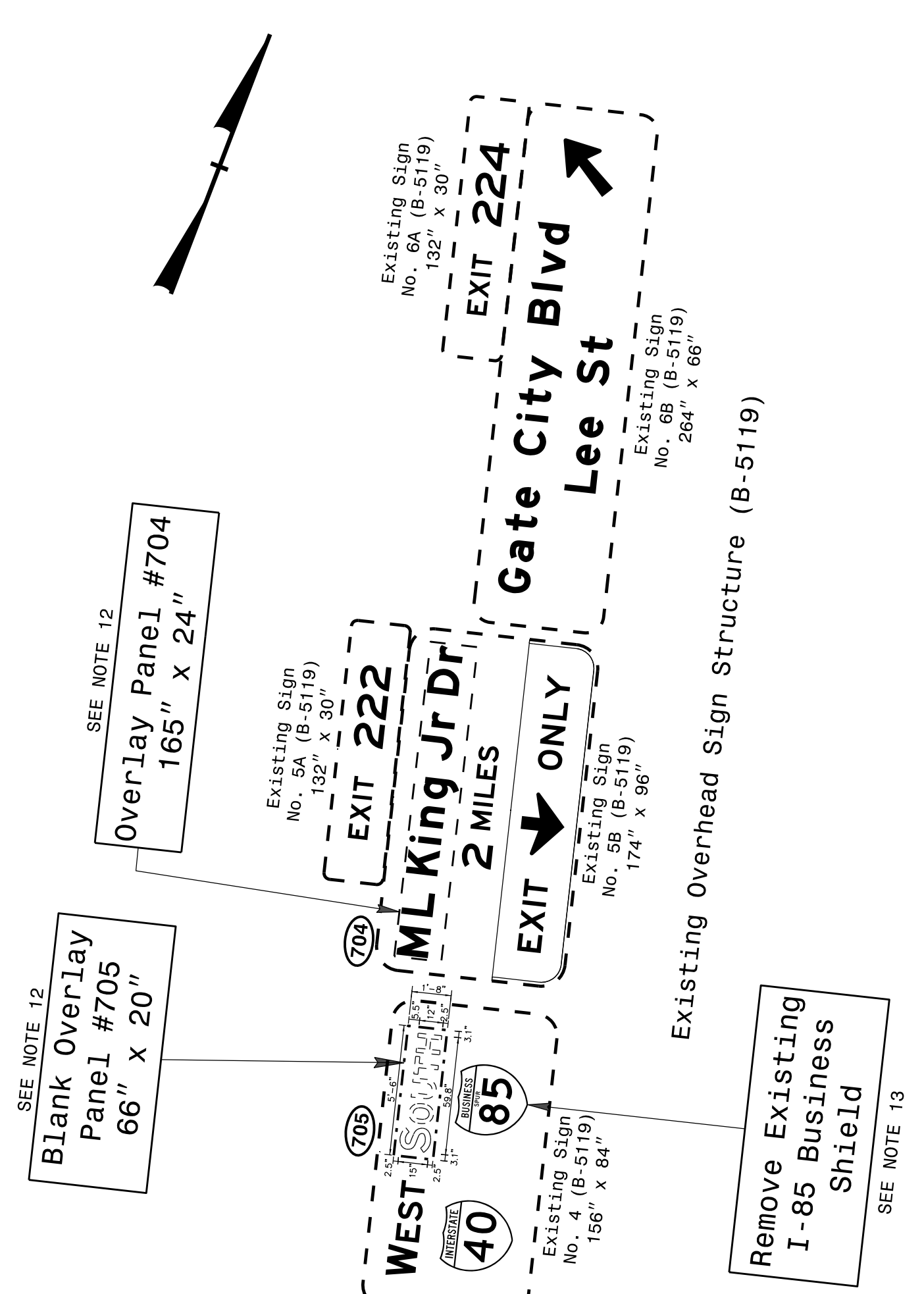
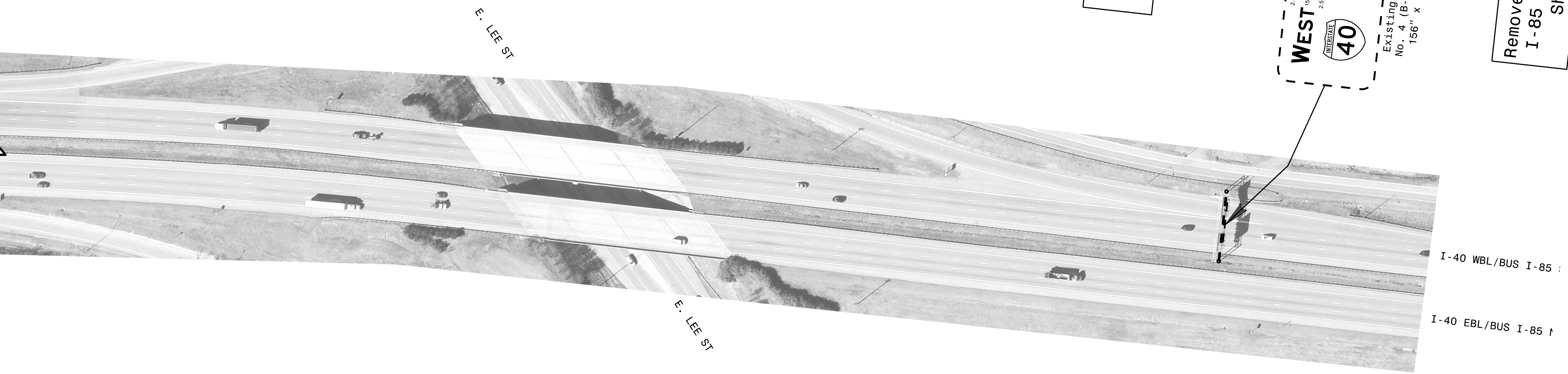



Overlay Placement Detail
Overlay Panel #705
(66" x 20")

PROJECT NOTES

- 1 DISPOSAL OF SIGN SYSTEM, OVERHEAD
- 2 DISPOSAL OF SIGN SYSTEM, STEEL BEAM
- 3 DISPOSAL OF SIGN SYSTEM, U-CHANNEL
- 4 DISPOSAL OF SIGN, A OR B (OVERHEAD)
- 5 DISPOSAL OF SIGN, D, E OR F
- 6 DISPOSAL OF LIGHTING SYSTEM
- 7 DISPOSAL OF WALKWAY
- 8 SIGN ERECTION, TYPE A (OVERHEAD)
- 9 SIGN ERECTION, TYPE B (OVERHEAD)
- 10 SIGN ERECTION, TYPE A (GROUND MOUNTED)
- 11 SIGN ERECTION, TYPE D, E, AND F
- 12 SIGN ERECTION, OVERLAY (OVERHEAD)
- 13 DISPOSAL OF OVERLAY (OVERHEAD)
- 14 CUTTING OF SIGN HANGERS (OVERHEAD)

EXISTING AND PROPOSED SIGNING
EXISTING OVERHEAD SIGN STRUCTURE #5

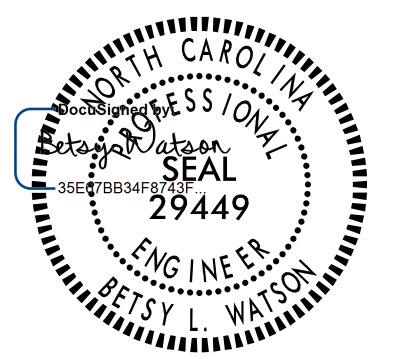
\$\$\$\$\$SYTIME\$\$\$\$\$
\$\$\$\$\$USER\$\$\$\$\$
\$\$\$\$\$USERNAME\$\$\$\$\$

TIP NO. U-5754	SHEET NO. SIGN-13
APPROVED: _____	
DATE: _____	
SEAL	
	
1/16/2019	
DOCUMENT NOT CONSIDERED FINAL UNLESS ALL SIGNATURES COMPLETED	
	

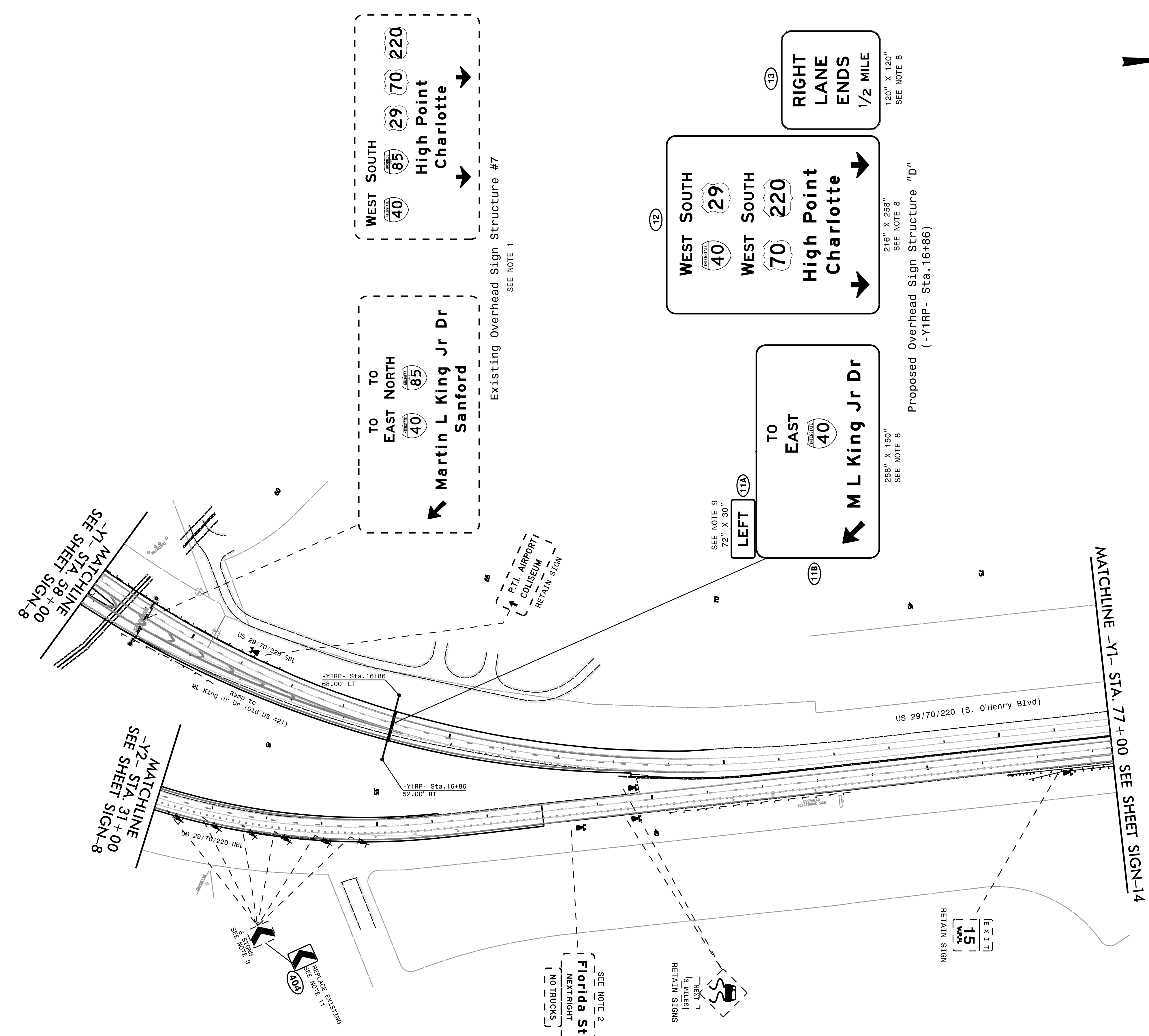

- PROJECT NOTES**
- 1 DISPOSAL OF SIGN SYSTEM, OVERHEAD
 - 2 DISPOSAL OF SIGN SYSTEM, STEEL BEAM
 - 3 DISPOSAL OF SIGN SYSTEM, U-CHANNEL
 - 4 DISPOSAL OF SIGN, A OR B (OVERHEAD)
 - 5 DISPOSAL OF SIGN, D, E OR F
 - 6 DISPOSAL OF LIGHTING SYSTEM
 - 7 DISPOSAL OF WALKWAY
 - 8 SIGN ERECTION, TYPE A (OVERHEAD)
 - 9 SIGN ERECTION, TYPE B (OVERHEAD)
 - 10 SIGN ERECTION, TYPE A (GROUND MOUNTED)
 - 11 SIGN ERECTION, TYPE D, E, AND F
 - 12 SIGN ERECTION, OVERLAY (OVERHEAD)
 - 13 DISPOSAL OF OVERLAY (OVERHEAD)
 - 14 CUTTING OF SIGN HANGERS (OVERHEAD)

EXISTING AND PROPOSED SIGNING
 PROPOSED OVERHEAD SIGN STRUCTURE "D"
 EXISTING OVERHEAD SIGN STRUCTURE #7

\$\$\$\$\$SYTIME\$\$\$\$\$
 \$\$\$DDGN\$\$\$\$\$
 \$\$\$USERNAM\$\$\$\$\$

TIP NO.	SHEET NO.
U-5754	SIGN-14

APPROVED: _____
DATE: _____

SEAL

1/16/2019

DOCUMENT NOT CONSIDERED FINAL
UNLESS ALL SIGNATURES COMPLETED

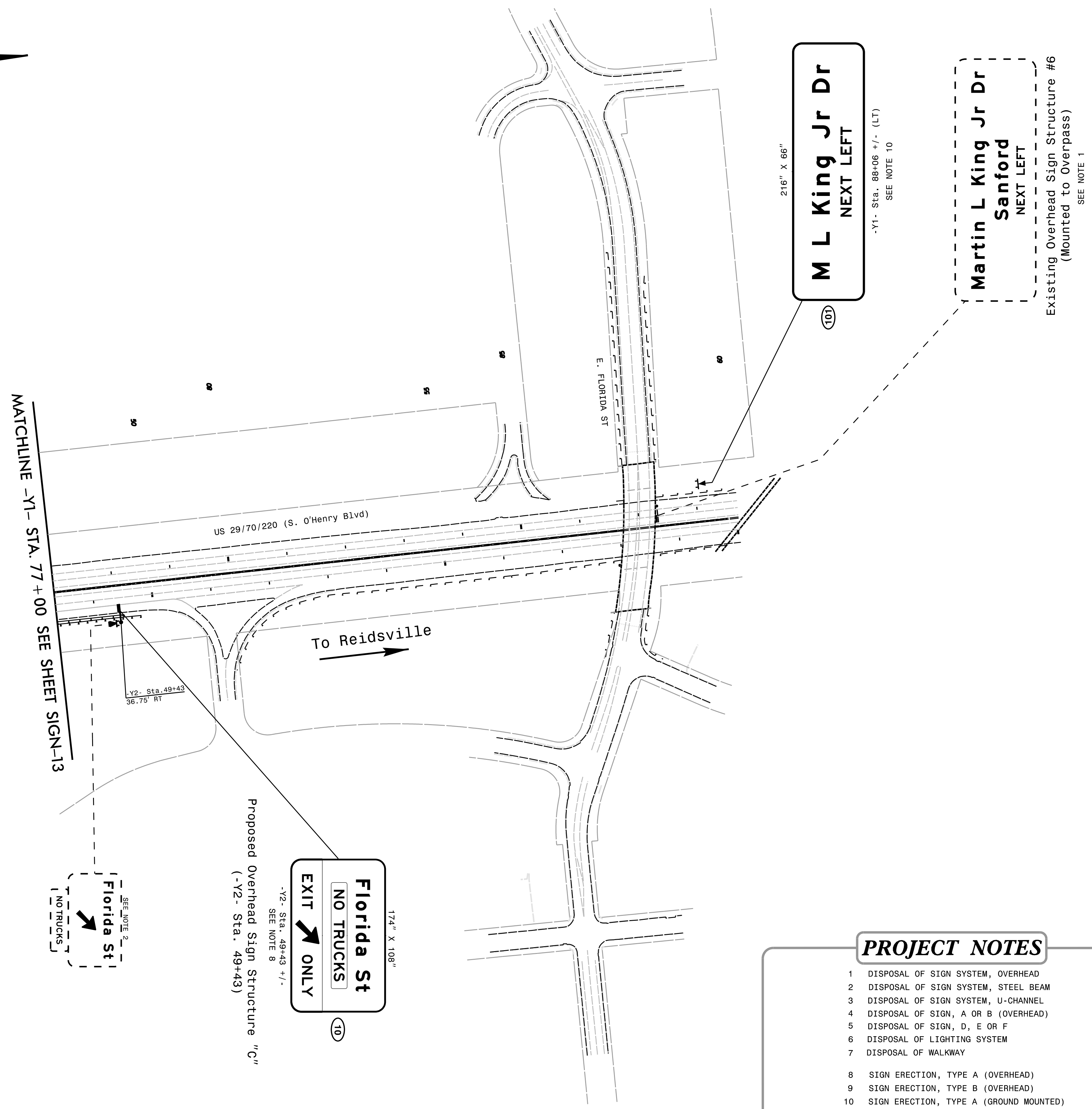
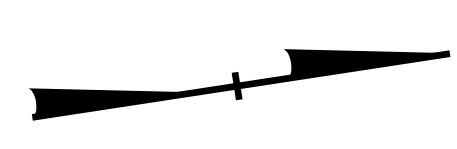

PROJECT NOTES

- 1 DISPOSAL OF SIGN SYSTEM, OVERHEAD
- 2 DISPOSAL OF SIGN SYSTEM, STEEL BEAM
- 3 DISPOSAL OF SIGN SYSTEM, U-CHANNEL
- 4 DISPOSAL OF SIGN, A OR B (OVERHEAD)
- 5 DISPOSAL OF SIGN, D, E OR F
- 6 DISPOSAL OF LIGHTING SYSTEM
- 7 DISPOSAL OF WALKWAY
- 8 SIGN ERECTION, TYPE A (OVERHEAD)
- 9 SIGN ERECTION, TYPE B (OVERHEAD)
- 10 SIGN ERECTION, TYPE A (GROUND MOUNTED)
- 11 SIGN ERECTION, TYPE D, E, AND F
- 12 SIGN ERECTION, OVERLAY (OVERHEAD)
- 13 DISPOSAL OF OVERLAY (OVERHEAD)
- 14 CUTTING OF SIGN HANGERS (OVERHEAD)

EXISTING AND PROPOSED SIGNING
PROPOSED OVERHEAD SIGN STRUCTURE "C"
EXISTING OVERHEAD SIGN STRUCTURE #6

\$\$\$\$\$SYTIME\$\$\$\$\$
\$\$\$\$\$DDGN\$\$\$\$\$
\$\$\$\$\$USERNAME\$\$\$\$\$