

**This electronic collection of documents is provided
for the convenience of the user
and is Not a Certified Document –**

**The documents contained herein were originally issued
and sealed by the individuals whose names and license
numbers appear on each page, on the dates appearing
with their signature on that page.**

**This file or an individual page
shall not be considered a certified document.**

STATE OF NORTH CAROLINA
DIVISION OF HIGHWAYS

CROSS SECTION SUMMARY SHEET

Note: Embankment does not include backfill for undercut.

Station	Uncl. Exc. (LT)	Undercut (LT)	Embt (LT)	Uncl. Exc. (CL)	Undercut (CL)	Embt (CL)	Uncl. Exc. (RT)	Undercut (RT)	Embt (RT)	Station	Uncl. Exc. (LT)	Undercut (LT)	Embt (LT)	Uncl. Exc. (CL)	Undercut (CL)	Embt (CL)	Uncl. Exc. (RT)	Undercut (RT)	Embt (RT)
-L-	(cu. yd.)	(cu. yd.)	(cu. yd.)	(cu. yd.)	(cu. yd.)	(cu. yd.)	(cu. yd.)	(cu. yd.)	(cu. yd.)	-L-	(cu. yd.)	(cu. yd.)	(cu. yd.)	(cu. yd.)	(cu. yd.)	(cu. yd.)	(cu. yd.)	(cu. yd.)	(cu. yd.)
15+65.00									0	42+00.00	3		30	1		48	4		25
16+00.00	2		25			44	3		38	42+50.00	2		33			54	4		38
16+50.00	1		57			63	4		68	43+00.00	1		50			58	5		33
17+00.00			84			57	3		86	43+50.00			58			61	5		29
17+50.00			86			46	2		96	44+00.00	1		62			60	5		30
18+00.00			74			34	2		93	44+50.00	3		46			58	4		43
18+50.00			62			25	3		71	45+00.00	1		14			29	2		27
19+00.00			63			28	3		58	45+50.00									
19+50.00			70			28	2		61	46+00.00	1		16			29	7		143
20+00.00			57			32	2		68	46+50.00	2		44			72	2		71
20+50.00	2		27			36	2		45	47+00.00	2		42			73	2		71
21+00.00	3		19			38	6		28	47+50.00	4		23			59	2		39
21+50.00	3		33			40	6		37	48+00.00	4		26			58	3		31
22+00.00	1		44			33	3		45	48+50.00	2		60			60	5		17
22+50.00			55			27	2		51	49+00.00	1		89			57	5		20
23+00.00			66			20	2		44	49+50.00			80			59	3		32
23+50.00	9		72			16	2		35	50+00.00			81			66	3		33
24+00.00	19		76			17	3		31	50+50.00			98			75	3		31
24+50.00	17		86			17	3		27	51+00.00	1		109			78	4		22
25+00.00	11		96			19	3		37	51+50.00	2		121			84	5		24
25+50.00	5		66			28	2		55	52+00.00	2		124			99	3		37
26+00.00	2		70			36	2		57	52+50.00	2		119			118	3		45
26+50.00	1		93			42	2		46	53+00.00	1		122			124	4		61
27+00.00			65			46	2		37	53+50.00	1		131			117	6		79
27+50.00	1		47			42	2		35	54+00.00			136			119	5		88
28+00.00	2		39			35	3		36	54+50.00			137			125	5		96
28+50.00	2		28	1		31	3		32	55+00.00			136			127	6		90
29+00.00	9		19	1		26	3		28	55+50.00			133			131	6		75
29+50.00	9		20			22	3		26	56+00.00			125			134	6		61
30+00.00	2		22			14	4		21	56+50.00			99			132	6		49
30+50.00	3		27			12	3		35	57+00.00	1		66			131	6		39
31+00.00	2		46			24	3		40	57+50.00	1		56			131	5		30
31+50.00	2		60			33	3		36	58+00.00			63			131	7		27
32+00.00	3		41			32	2		38	58+50.00			70			133	8		35
32+50.00	3		38			34	2		40	59+00.00			74			141	9		44
33+00.00	3		49			37	3		50	59+50.00			77			138	12		48
33+50.00	3		44			29	3		43	60+00.00			75			130	13		49
34+00.00	3		41			22	3		40	60+50.00			70			125	10		57
34+50.00	3		39			20	3		40	61+00.00			74			117	5		79
35+00.00	2		39			18	3		35	61+50.00	1		95			119	7		88
35+50.00	1		39			22	4		34	62+00.00			97			117			117
36+00.00	2		34			27	3		34	62+50.00			79			87			121
36+50.00	3		35			33	3		43	63+00.00			71			57	12		121
37+00.00	1		54			46	2		49	63+50.00			66			31	25		112
37+50.00			70			67	1		56	64+00.00			66			11	25		109
38+00.00			85			88	1		74	64+50.00			65			7	26		110
38+50.00			97			101	1		79	65+00.00			67	1		5	14		97
39+00.00			100			109	1		59	65+50.00			70			5			89
39+50.00			73			106	1		53	66+00.00			54	2		15	1		86
40+00.00			57			88	1		45	66+50.00	1		34	4		14			69
40+50.00	1		59	1		65	2		30	67+00.00	1		38	7		1			51
41+00.00	3		45	2		48	3		32	67+50.00			38	6		32			64
41+50.00	3		40	2		43	4		20	68+00.00			24	2		66			96

Note: "Quantities are approximate only. The Resident Engineer will re-cross-section the work accurately when the project is staked out. These cross-section notes will be used in computing the final quantities for which the contractor will be paid. The Embankment Column does not include backfill for Undercut"

5/28/99

05-MAR-2019 11:26
C:\cnc\Roadway\XSC\4405\rdy\XSC-summary.dgn

STATE OF NORTH CAROLINA
DIVISION OF HIGHWAYS

CROSS SECTION SUMMARY SHEET

Note: Embankment does not include backfill for undercut.

Station	Uncl. Exc. (LT)	Undercut (LT)	Embt (LT)	Uncl. Exc. (CL)	Undercut (CL)	Embt (CL)	Uncl. Exc. (RT)	Undercut (RT)	Embt (RT)	Station	Uncl. Exc. (LT)	Undercut (LT)	Embt (LT)	Uncl. Exc. (CL)	Undercut (CL)	Embt (CL)	Uncl. Exc. (RT)	Undercut (RT)	Embt (RT)
-L-	(cu. yd.)	(cu. yd.)	(cu. yd.)	(cu. yd.)	(cu. yd.)	(cu. yd.)	(cu. yd.)	(cu. yd.)	(cu. yd.)	-L-	(cu. yd.)	(cu. yd.)	(cu. yd.)	(cu. yd.)	(cu. yd.)	(cu. yd.)	(cu. yd.)	(cu. yd.)	(cu. yd.)
68+50.00			18	1		67	1		103	95+00.00	31						4		4
69+00.00	1		12	1		69	2		62	95+50.00	27		9				6		6
69+50.00	3		5	1		79	2		43	96+00.00	24		9				6		8
70+00.00	12		1	1		92	2		67	96+50.00	27						5		13
70+50.00	24			1		101	3		68	97+00.00	22		1				4		20
71+00.00	21					106	4		65	97+50.00	13		7				4		25
71+50.00	8		2			106	4		65	98+00.00	7		8				3		33
72+00.00	5		3			96	2		57	98+50.00	2		2				1		21
72+50.00	4		3			74	1		45	99+00.00									2
73+00.00	4		6			60	6		45	99+50.00									
73+50.00	5		33			57	11		53	100+00.00									
74+00.00	4		58			55	10		36	100+50.00	4		5				3		4
74+50.00	3		58			55	7		14	101+00.00	25		5				8		3
75+00.00	3		60			60	4		14	101+50.00	43		2				13		
75+50.00	2		62			75	7		13	102+00.00	50		9				11		5
76+00.00	1		32			42	5		6	102+50.00	57		12				5		18
76+50.00							2		7	103+00.00	53		18				3		28
77+00.00										103+50.00	43		26				3		31
77+50.00			85				1		14	104+00.00	32		30				3		34
78+00.00			223				1		44	104+50.00	16		28				4		42
78+50.00			298						54	105+00.00	9		20				5		55
79+00.00	1		320				1		43	105+50.00	9		16				7		68
79+50.00	12		357				44		23	106+00.00	7		18				7		68
80+00.00	12		526				44		19										
80+50.00			778			11	1		37										
81+00.00			1022			31			44										
81+50.00			1111			48			46										
82+00.00			1011			61			48										
82+50.00			800			72			56										
83+00.00			603			88	1		140										
83+50.00			510			107	2		208										
84+00.00			403			118	1		241										
84+50.00			311			114	1		274										
85+00.00			246			102	1		280										
85+50.00			103	1		78	2		275										
86+00.00				3		58	2		217										
86+50.00			57	3		56	2		154										
87+00.00			99	2		57	1		124										
87+50.00			82	1		57			125										
88+00.00			72			60			125										
88+50.00	1		66			66			120										
89+00.00	1		69			70			84										
89+50.00	3		64			49			43										
90+00.00	7		50			36			60										
90+50.00	7		43			38			85										
91+00.00	2		41			31			81										
91+50.00	1		34			31			80										
92+00.00	2		55			36			78										
92+50.00	5		75			43			74										
93+00.00	9		52			38			65										
93+50.00	13		26			16			58										
94+00.00	17		7						45										
94+50.00	24		1				1		20										

Note: "Quantities are approximate only. The Resident Engineer will re-cross-section the work accurately when the project is staked out. These cross-section notes will be used in computing the final quantities for which the contractor will be paid. The Embankment Column does not include backfill for Undercut"

5/28/99

05_MAR_2019_11:26
C:\Users\jpratt\OneDrive\Documents\Roadway\NCDOT\U-4405\Roadway\XSC\4405_rdy...XSC_summary.dgn

STATE OF NORTH CAROLINA
DIVISION OF HIGHWAYS

CROSS SECTION SUMMARY SHEET

Note: Embankment does not include backfill for undercut.

Station	Uncl. Exc. (LT)	Undercut (LT)	Embt (LT)	Uncl. Exc. (CL)	Undercut (CL)	Embt (CL)	Uncl. Exc. (RT)	Undercut (RT)	Embt (RT)	Station	Uncl. Exc. (LT)	Undercut (LT)	Embt (LT)	Station	Uncl. Exc. (CL)	Undercut (CL)	Embt (CL)	Station	Uncl. Exc. (RT)	Undercut (RT)	Embt (RT)
-L1-	(cu. yd.)	(cu. yd.)	(cu. yd.)	(cu. yd.)	(cu. yd.)	(cu. yd.)	(cu. yd.)	(cu. yd.)	(cu. yd.)	-Y1-	(cu. yd.)	(cu. yd.)	(cu. yd.)	-Y7-	(cu. yd.)	(cu. yd.)	(cu. yd.)		(cu. yd.)	(cu. yd.)	(cu. yd.)
96+00.00			73							14+20.00			15	13+20.00							
96+50.00	8		73							14+50.00	2		15	13+50.00	31		1				
97+00.00	5		156							14+76.00	3		26	14+00.00	55		11				
97+50.00	22		124											14+50.00	35		6				
98+00.00	36		58											15+00.00	12		19				
98+50.00	63		54											15+50.00	2		5				
99+00.00	103		53											16+00.00	68		16				
99+50.00	108		48											16+45.00	115		9				
100+00.00	105		39																		
100+50.00	98		40																		
101+00.00	47		67																		
101+50.00	6		85																		
102+00.00	6		83																		
102+50.00	8		78																		
103+00.00	7		77																		
103+50.00	5		90																		
104+00.00	5		105																		
104+50.00	5		105																		
105+00.00	5		96																		
105+50.00	5		88																		
106+00.00	5		80																		
106+50.00	4		75																		
107+00.00	6		55																		
107+50.00	11		26																		
108+00.00	9		55																		
108+50.00	5		91																		
109+00.00	16		46																		
109+50.00	27		7																		
110+00.00	17		24																		
110+50.00	8		61																		
111+00.00	7		82																		
111+50.00	8		70																		
112+00.00	8		60																		
112+50.00	10		35																		
113+00.00	12		18																		
113+50.00	10		28																		
114+00.00	9		30																		
114+50.00	9		26																		
115+00.00	9		44																		
115+50.00	9		68																		
115+65.00	3		22																		

Note: "Quantities are approximate only. The Resident Engineer will re-cross-section the work accurately when the project is staked out. These cross-section notes will be used in computing the final quantities for which the contractor will be paid. The Embankment Column does not include backfill for Undercut"

5/28/99

05-MAR-2019 11:26
C:\Users\Roadway\NCDDT\U-4405\Roadway\XSC\4405_rdy_XSC_summary.dgn

140 130 120 110 100 90 80 70 60 50 40 30 20 10 0 10 20 30 40 50 60 70 80 90 100 110 120 130 140

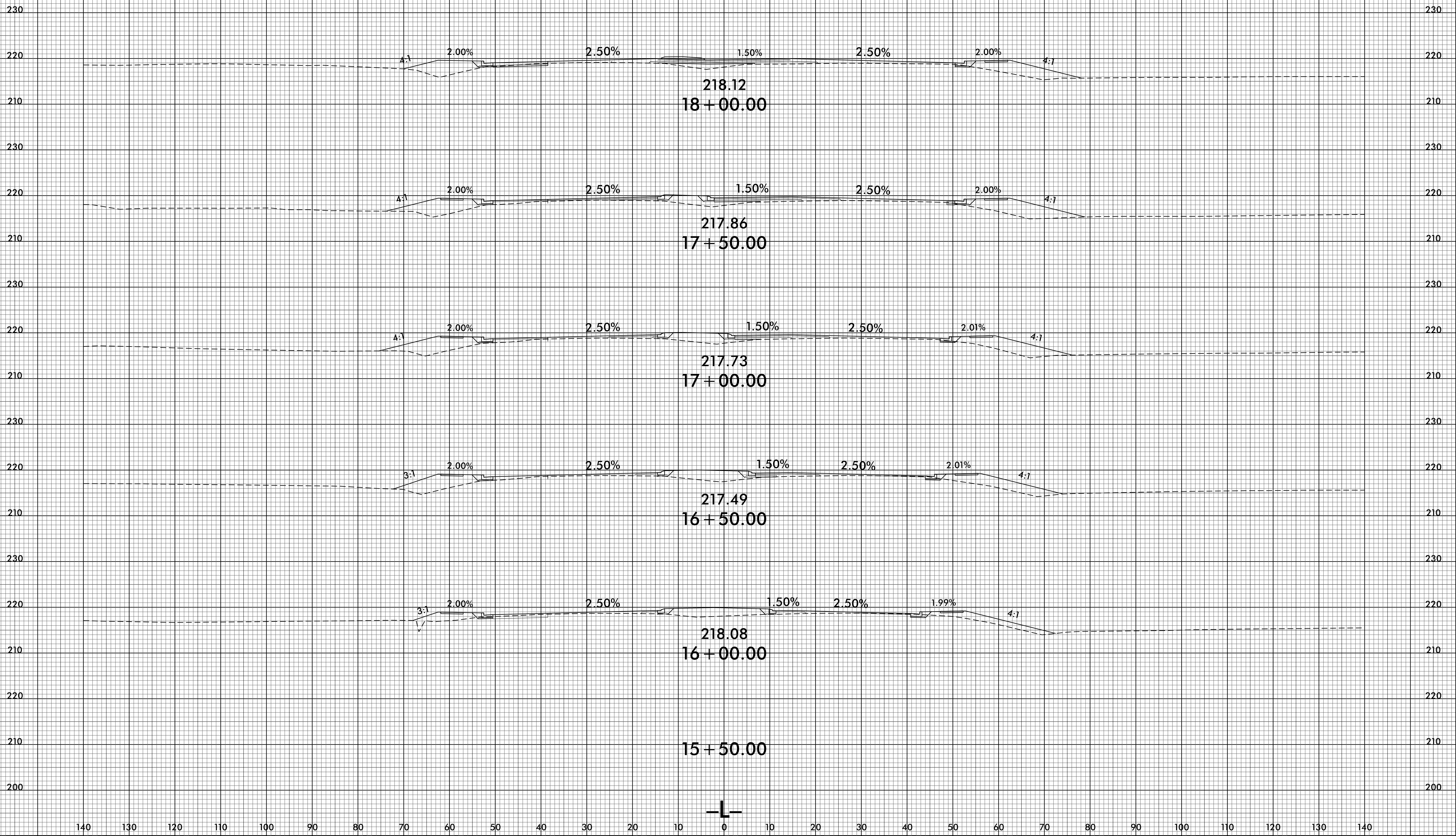

140 130 120 110 100 90 80 70 60 50 40 30 20 10 0 10 20 30 40 50 60 70 80 90 100 110 120 130 140

8/23/99

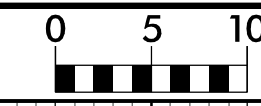

PROJ. REFERENCE NO.
U-4405A

SHEET NO.
X-2

140 130 120 110 100 90 80 70 60 50 40 30 20 10 0 10 20 30 40 50 60 70 80 90 100 110 120 130 140

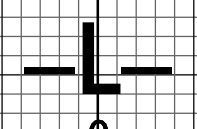
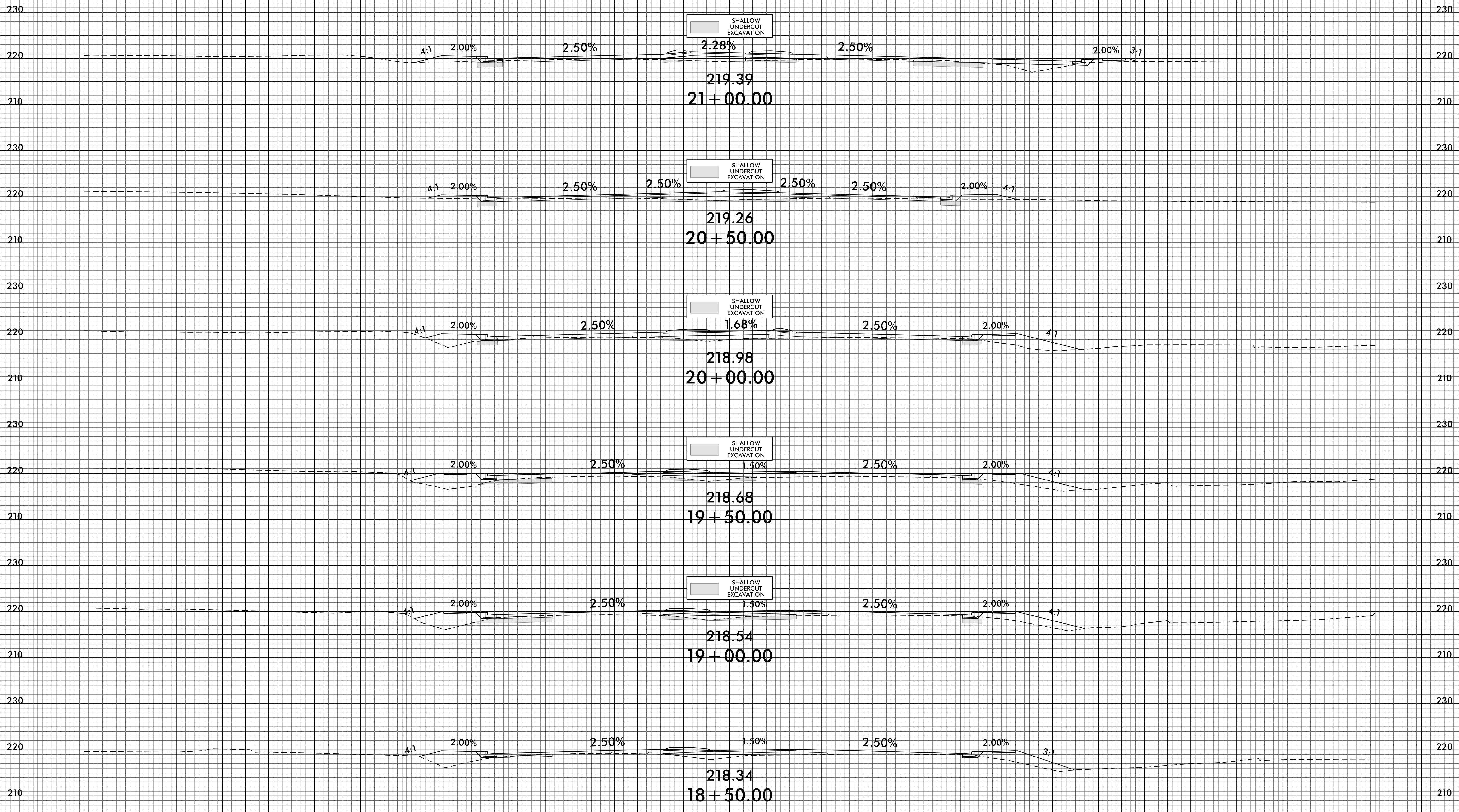

140 130 120 110 100 90 80 70 60 50 40 30 20 10 0 10 20 30 40 50 60 70 80 90 100 110 120 130 140

10-JUN-2021 15:17
P:\PROJECTS\X\4405A\4405A_r.dwg
\$\$\$\$

8/23/99

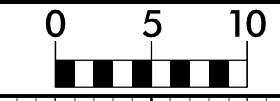

PROJ. REFERENCE NO.
U-4405A

SHEET NO.
X-3

140 130 120 110 100 90 80 70 60 50 40 30 20 10 0 10 20 30 40 50 60 70 80 90 100 110 120 130 140

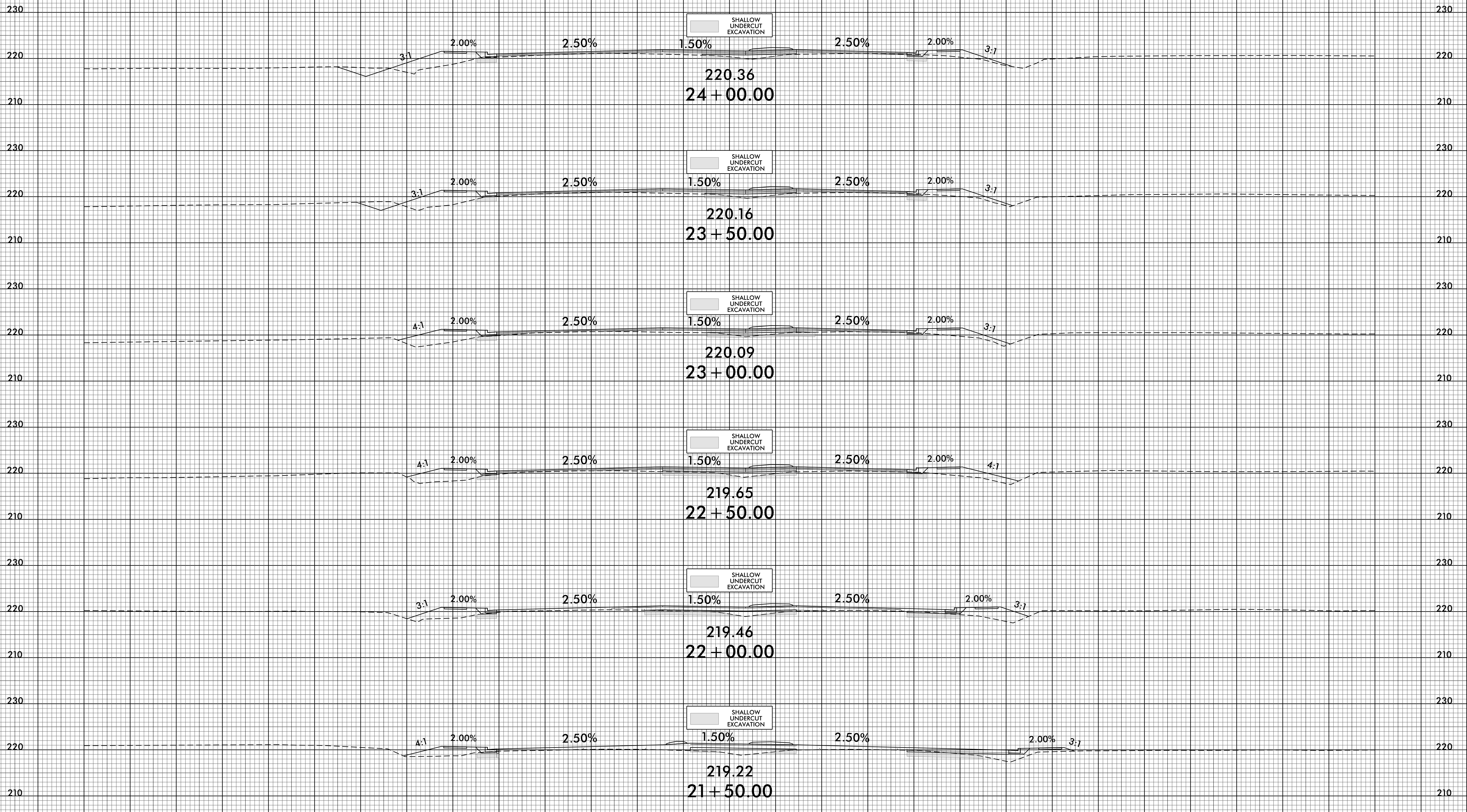

10-JUN-2021 15:18
R:\PROJECTS\2021\210615\210615.dgn

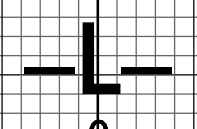

140 130 120 110 100 90 80 70 60 50 40 30 20 10 0 10 20 30 40 50 60 70 80 90 100 110 120 130 140

140 130 120 110 100 90 80 70 60 50 40 30 20 10 0 10 20 30 40 50 60 70 80 90 100 110 120 130 140

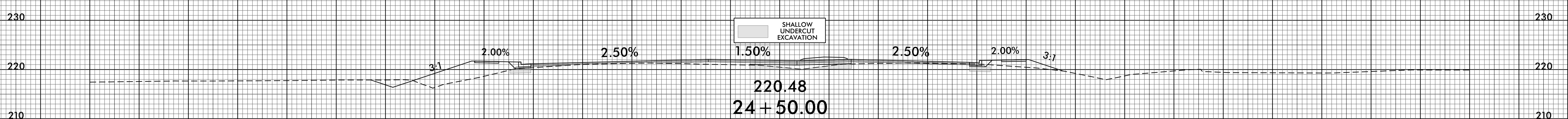
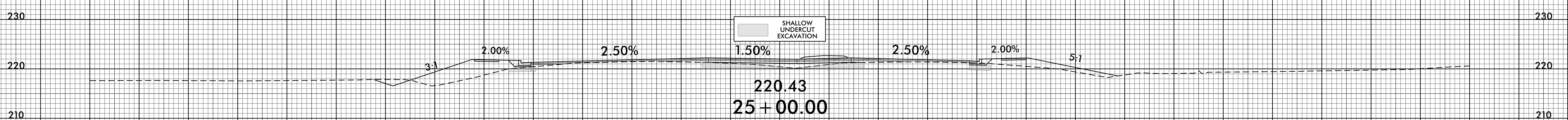
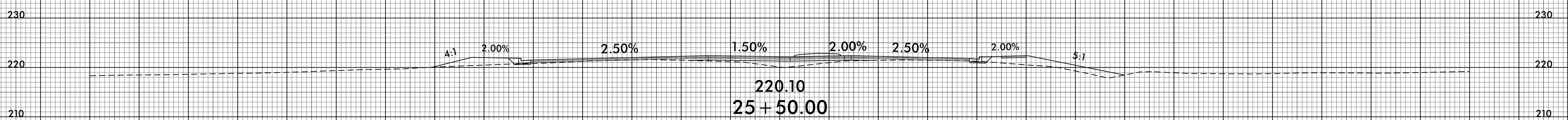
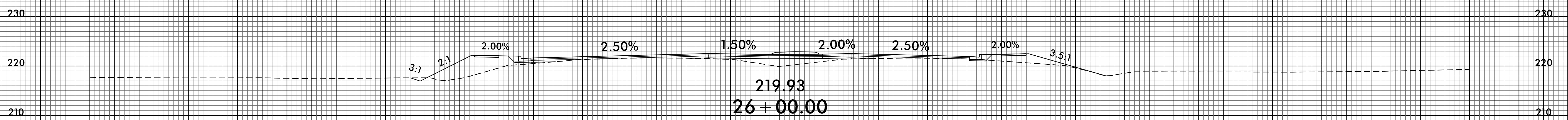
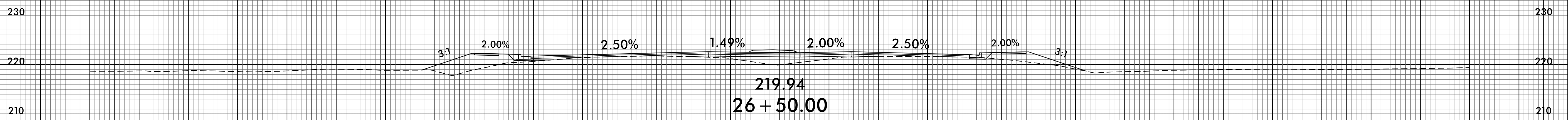
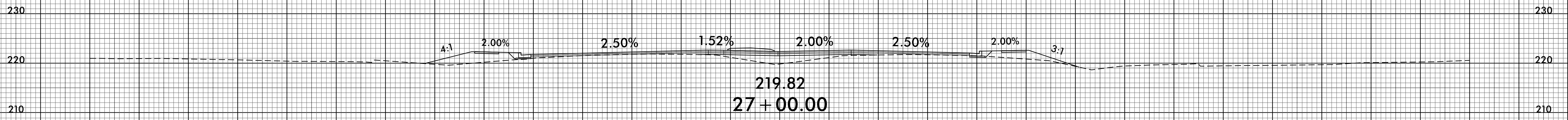

140 130 120 110 100 90 80 70 60 50 40 30 20 10 0 10 20 30 40 50 60 70 80 90 100 110 120 130 140

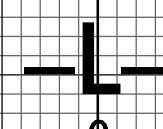

140 130 120 110 100 90 80 70 60 50 40 30 20 10 0 10 20 30 40 50 60 70 80 90 100 110 120 130 140

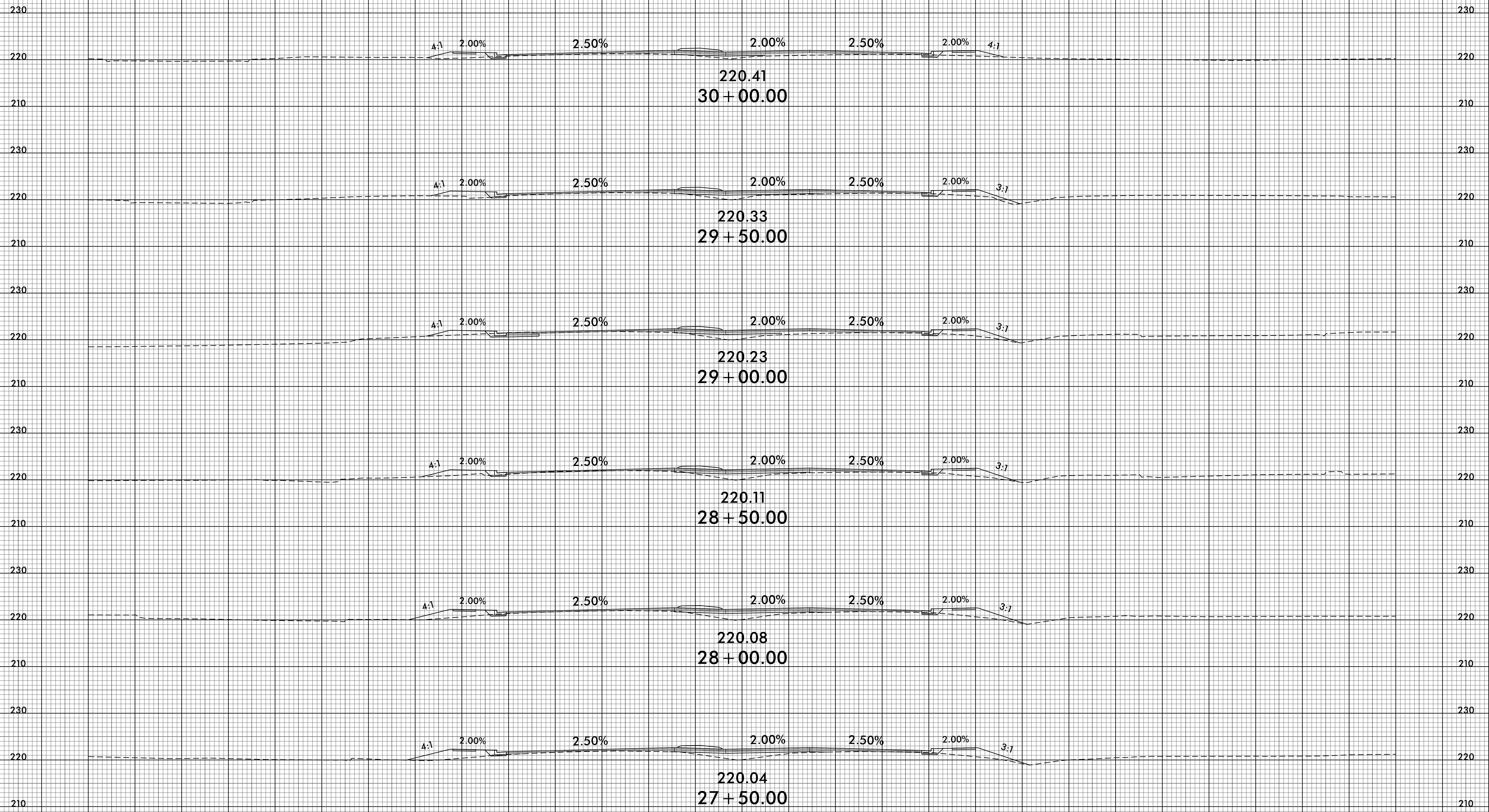

140 130 120 110 100 90 80 70 60 50 40 30 20 10 0 10 20 30 40 50 60 70 80 90 100 110 120 130 140

8/23/99



PROJ. REFERENCE NO.
U-4405A

SHEET NO.
X-6

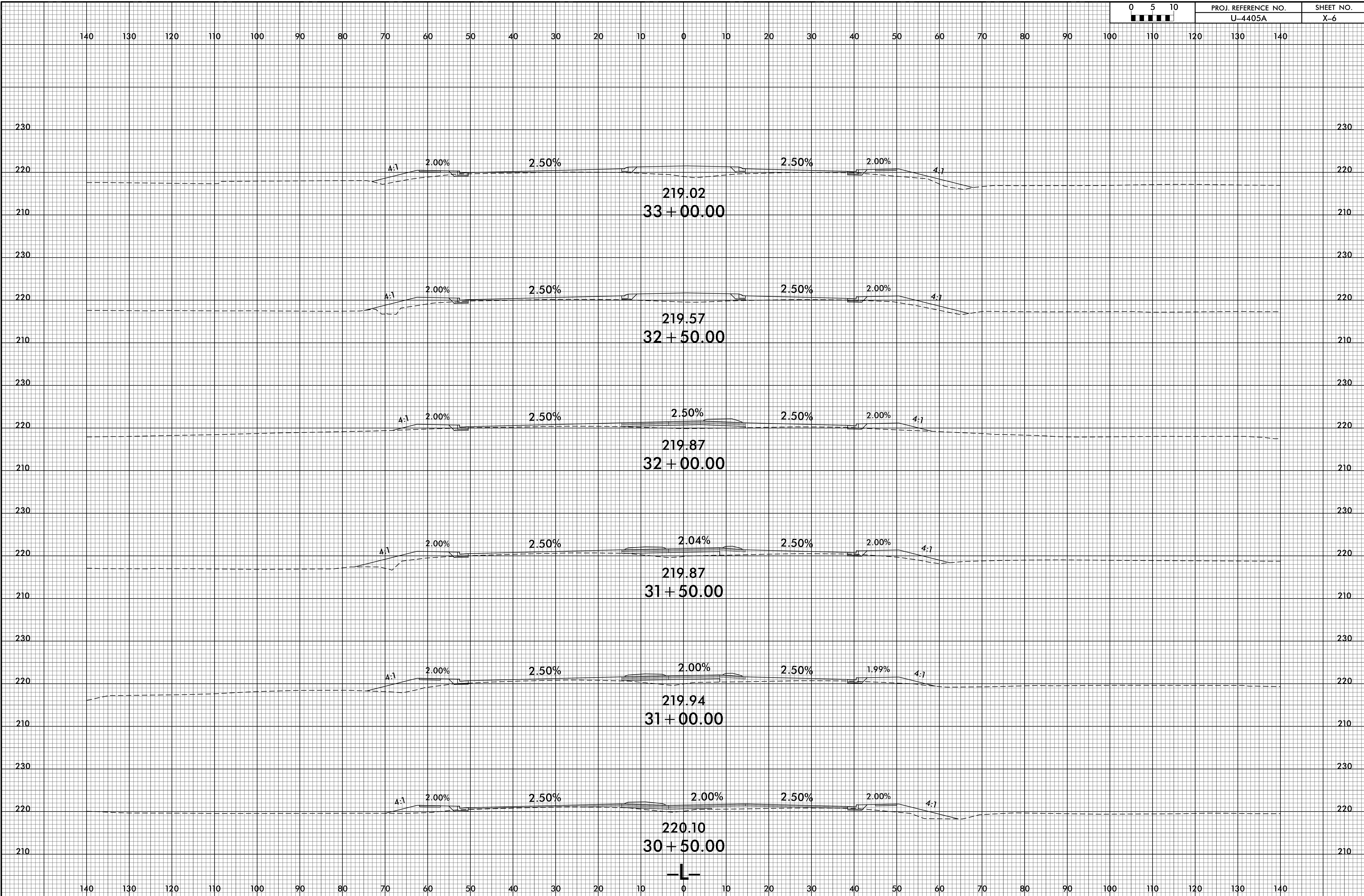

I:\JUN-2021\15:47
 R:\CADD\X\U-4405A_rdu_xpl.dgn
 \$USER\$

8/23/99

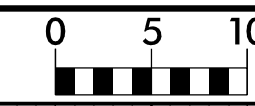

PROJ. REFERENCE NO.
U-4405A

SHEET NO.
X-7

140 130 120 110 100 90 80 70 60 50 40 30 20 10 0 10 20 30 40 50 60 70 80 90 100 110 120 130 140

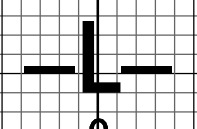
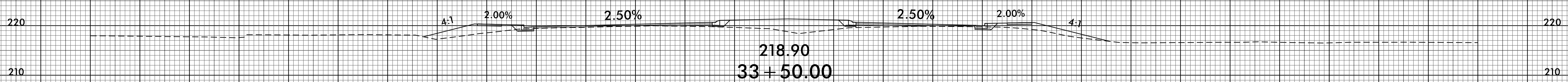
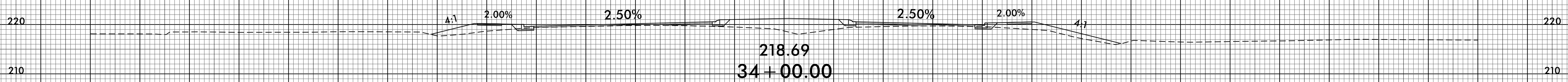
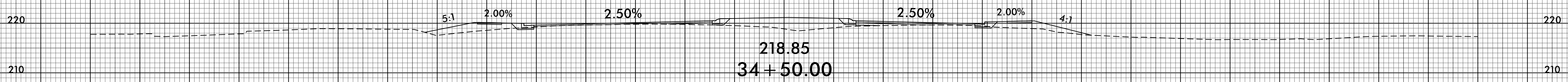
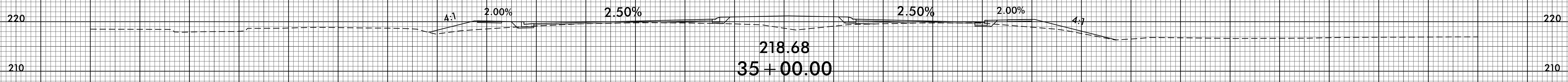
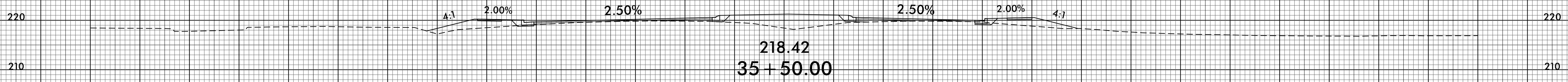
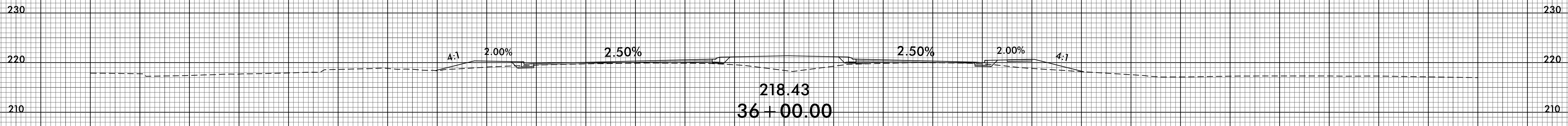

140 130 120 110 100 90 80 70 60 50 40 30 20 10 0 10 20 30 40 50 60 70 80 90 100 110 120 130 140

I:\JUN-2021\15448
R:\CADD\X\U-4405A_rdu_xpl.dgn
8/23/99

8/23/99

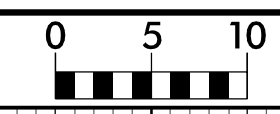

PROJ. REFERENCE NO.
U-4405A

SHEET NO.
X-8

140 130 120 110 100 90 80 70 60 50 40 30 20 10 0 10 20 30 40 50 60 70 80 90 100 110 120 130 140

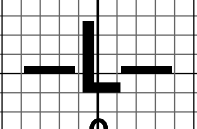
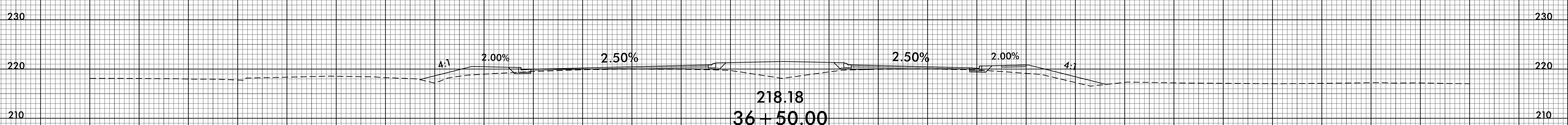
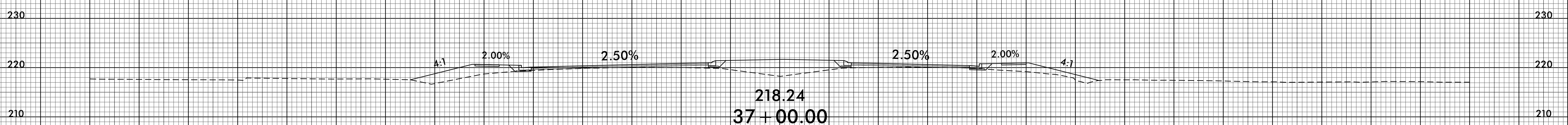
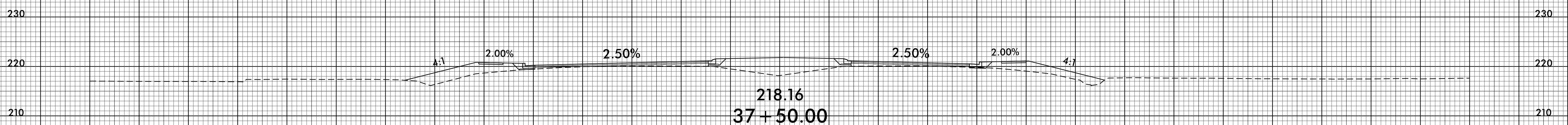
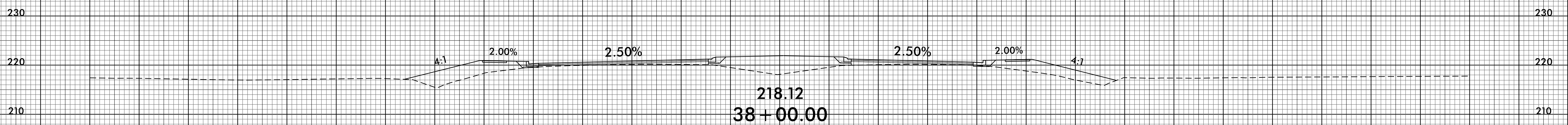
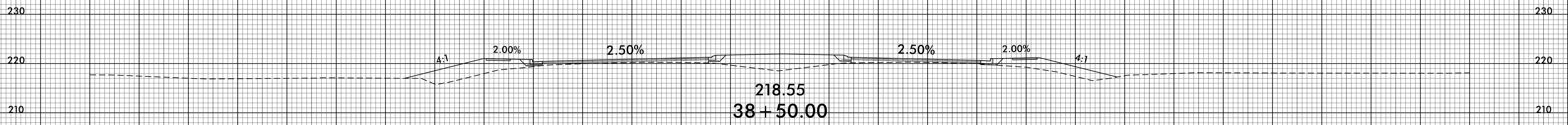
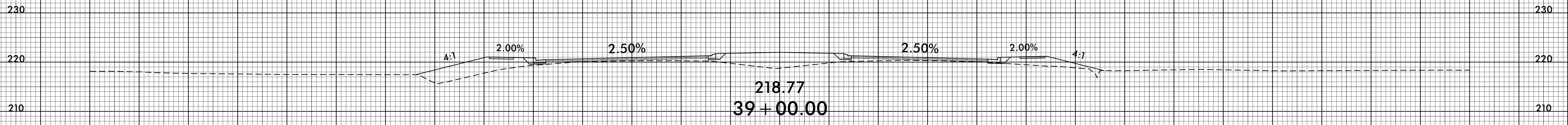

140 130 120 110 100 90 80 70 60 50 40 30 20 10 0 10 20 30 40 50 60 70 80 90 100 110 120 130 140

I:\JUN-2021\15:50
R:\PROJECTS\X\4405A\4405A_rdu_xpl.dgn
\$\$\$\$\$

8/23/99



PROJ. REFERENCE NO.
U-4405A

SHEET NO.
X-9

140 130 120 110 100 90 80 70 60 50 40 30 20 10 0 10 20 30 40 50 60 70 80 90 100 110 120 130 140

230 230

220 220

210 210

230 230

220 220

210 210

230 230

220 220

210 210

230 230

220 220

210 210

230 230

220 220

210 210

230 230

220 220

210 210

140 130 120 110 100 90 80 70 60 50 40 30 20 10 0 10 20 30 40 50 60 70 80 90 100 110 120 130 140

4:1 2.00% 2.50% 1.50% 2.50% 2.00% 4:1

218.94
42 + 00.00

4:1 2.00% 2.50% 2.00% 2.50% 2.00% 4:1

219.33
41 + 50.00

4:1 2.00% 2.50% 2.00% 2.50% 2.00% 4:1

219.56
41 + 00.00

4:1 2.00% 2.50% 2.00% 2.50% 2.00% 4:1

219.42
40 + 50.00

4:1 2.00% 2.50% 2.00% 2.50% 2.00% 4:1

219.19
40 + 00.00

4:1 2.00% 2.50% 1.96% 2.50% 2.00% 4:1

219.01
39 + 50.00

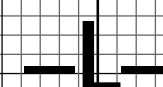

10-JUN-2021 15:55
R:\PROJECTS\X\4405A\4405A_rdu_xpl.dgn
USER:RDU

8/23/99

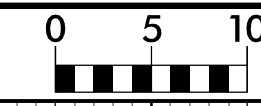

PROJ. REFERENCE NO.
U-4405A

SHEET NO.
X-10

140 130 120 110 100 90 80 70 60 50 40 30 20 10 0 10 20 30 40 50 60 70 80 90 100 110 120 130 140

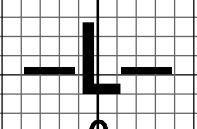
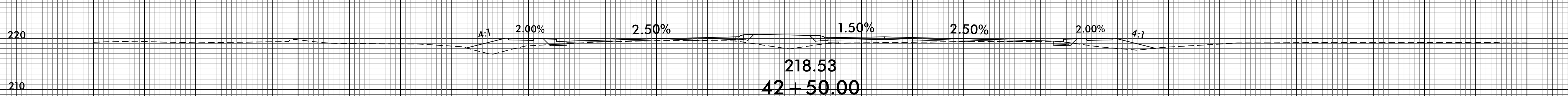
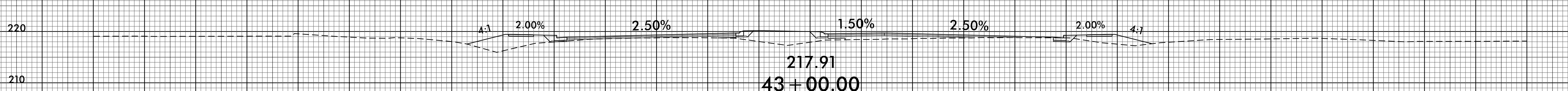
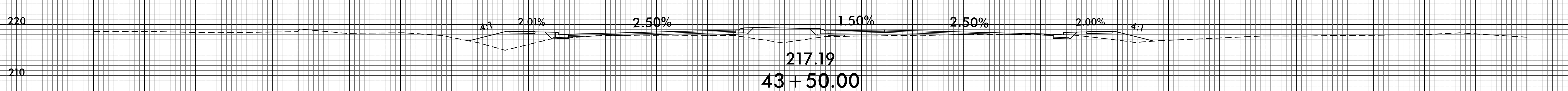
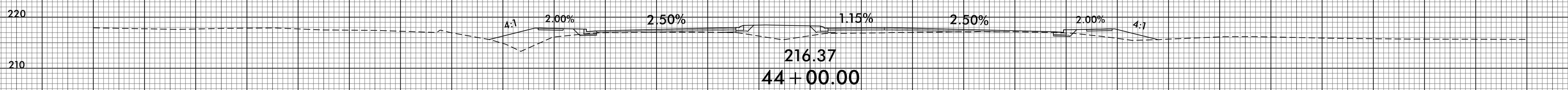
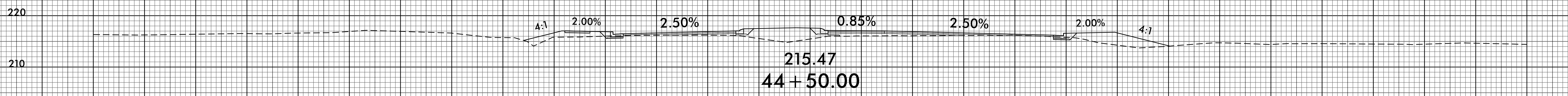
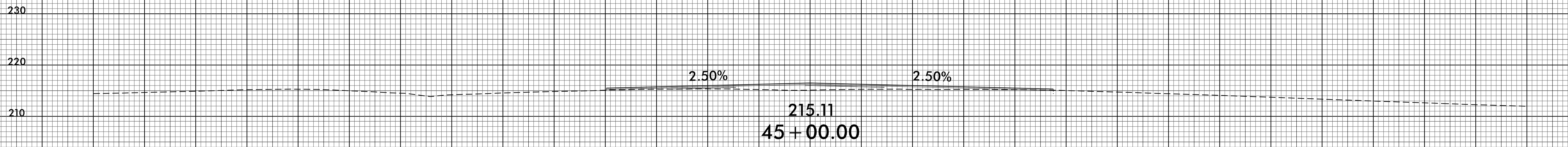

140 130 120 110 100 90 80 70 60 50 40 30 20 10 0 10 20 30 40 50 60 70 80 90 100 110 120 130 140

10-JUN-2021 15:56
R:\PROJECTS\X\4405A_r.dwg
\$\$\$\$

140 130 120 110 100 90 80 70 60 50 40 30 20 10 0 10 20 30 40 50 60 70 80 90 100 110 120 130 140

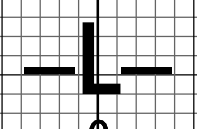
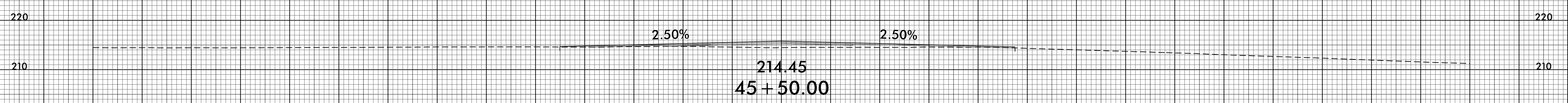
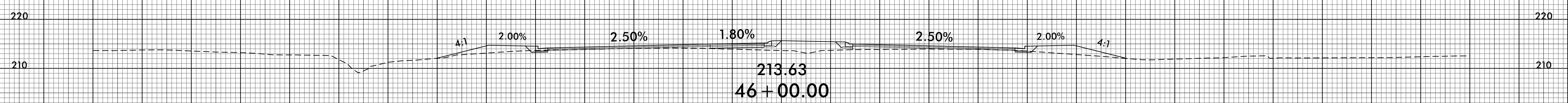
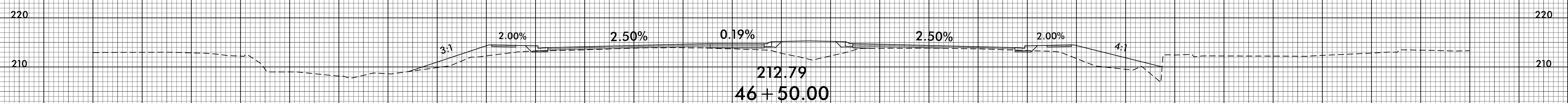
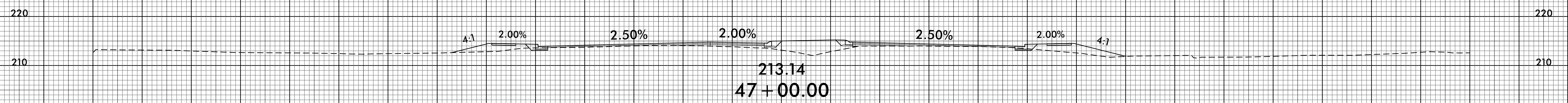
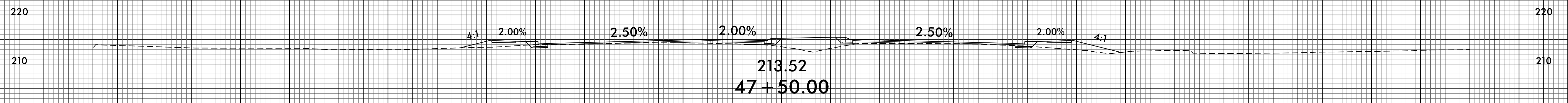
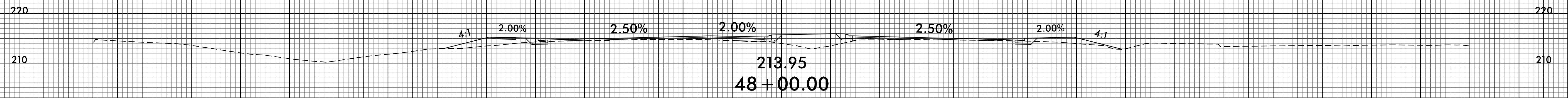

140 130 120 110 100 90 80 70 60 50 40 30 20 10 0 10 20 30 40 50 60 70 80 90 100 110 120 130 140

8/23/99

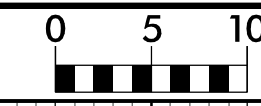

PROJ. REFERENCE NO.
U-4405A

SHEET NO.
X-12

140 130 120 110 100 90 80 70 60 50 40 30 20 10 0 10 20 30 40 50 60 70 80 90 100 110 120 130 140

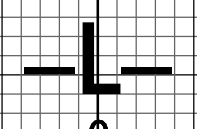
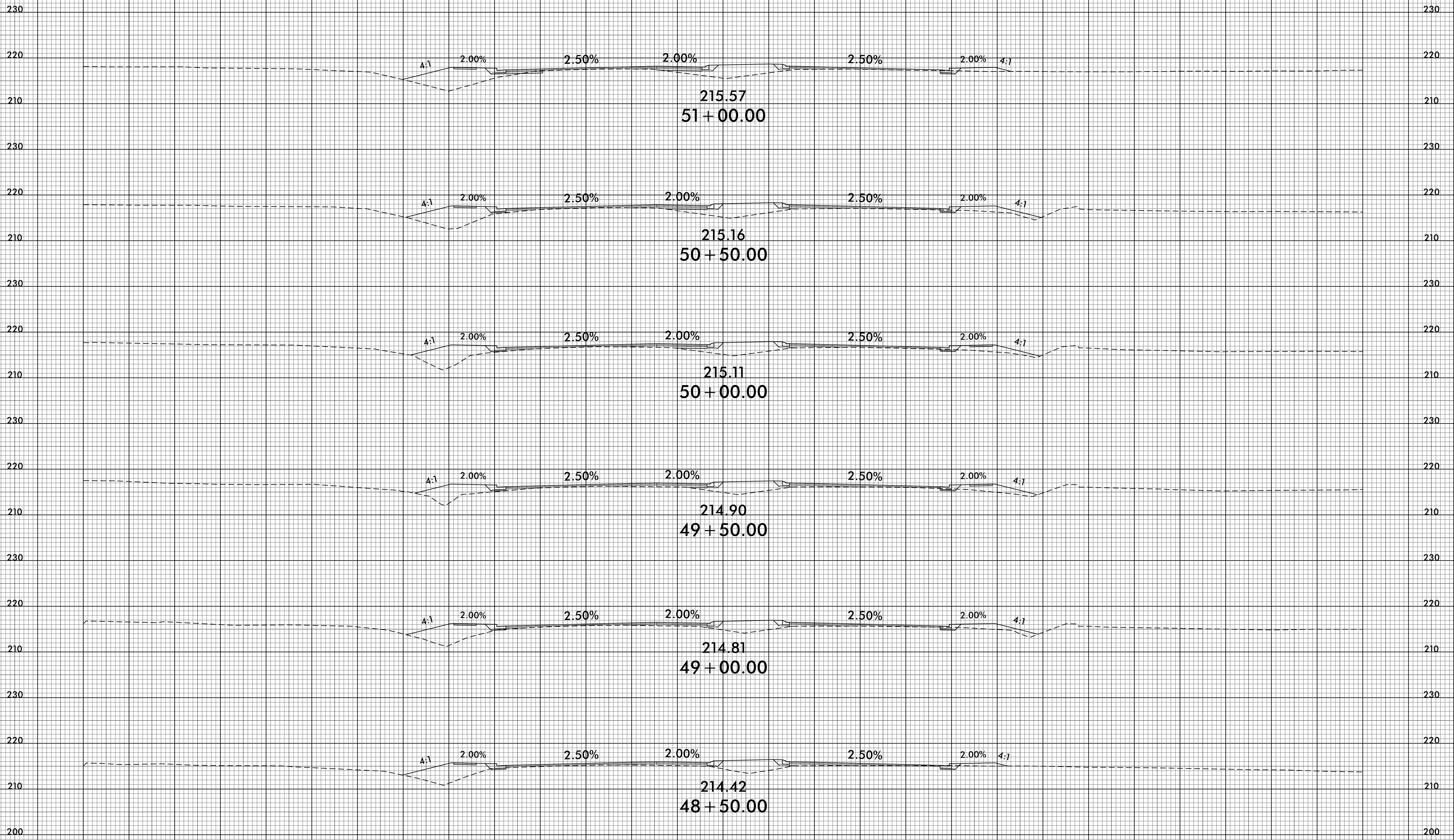

10-JUN-2021 15:58
R:\PROJECTS\X\4405A\4405A_rdu_xpl.dgn

140 130 120 110 100 90 80 70 60 50 40 30 20 10 0 10 20 30 40 50 60 70 80 90 100 110 120 130 140

230 230

220 220

210 210

217.07
54 + 00.00

230 230

220 220

210 210

216.97
53 + 50.00

230 230

220 220

210 210

216.51
53 + 00.00

230 230

220 220

210 210

215.47
52 + 50.00

230 230

220 220

210 210

215.58
52 + 00.00

230 230

220 220

210 210

215.68
51 + 50.00

200 200

140 130 120 110 100 90 80 70 60 50 40 30 20 10 0 10 20 30 40 50 60 70 80 90 100 110 120 130 140

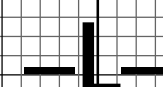

8/23/99

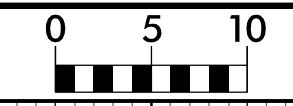

PROJ. REFERENCE NO.
U-4405A

SHEET NO.
X-14

140 130 120 110 100 90 80 70 60 50 40 30 20 10 0 10 20 30 40 50 60 70 80 90 100 110 120 130 140

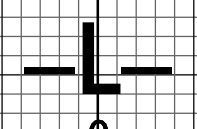
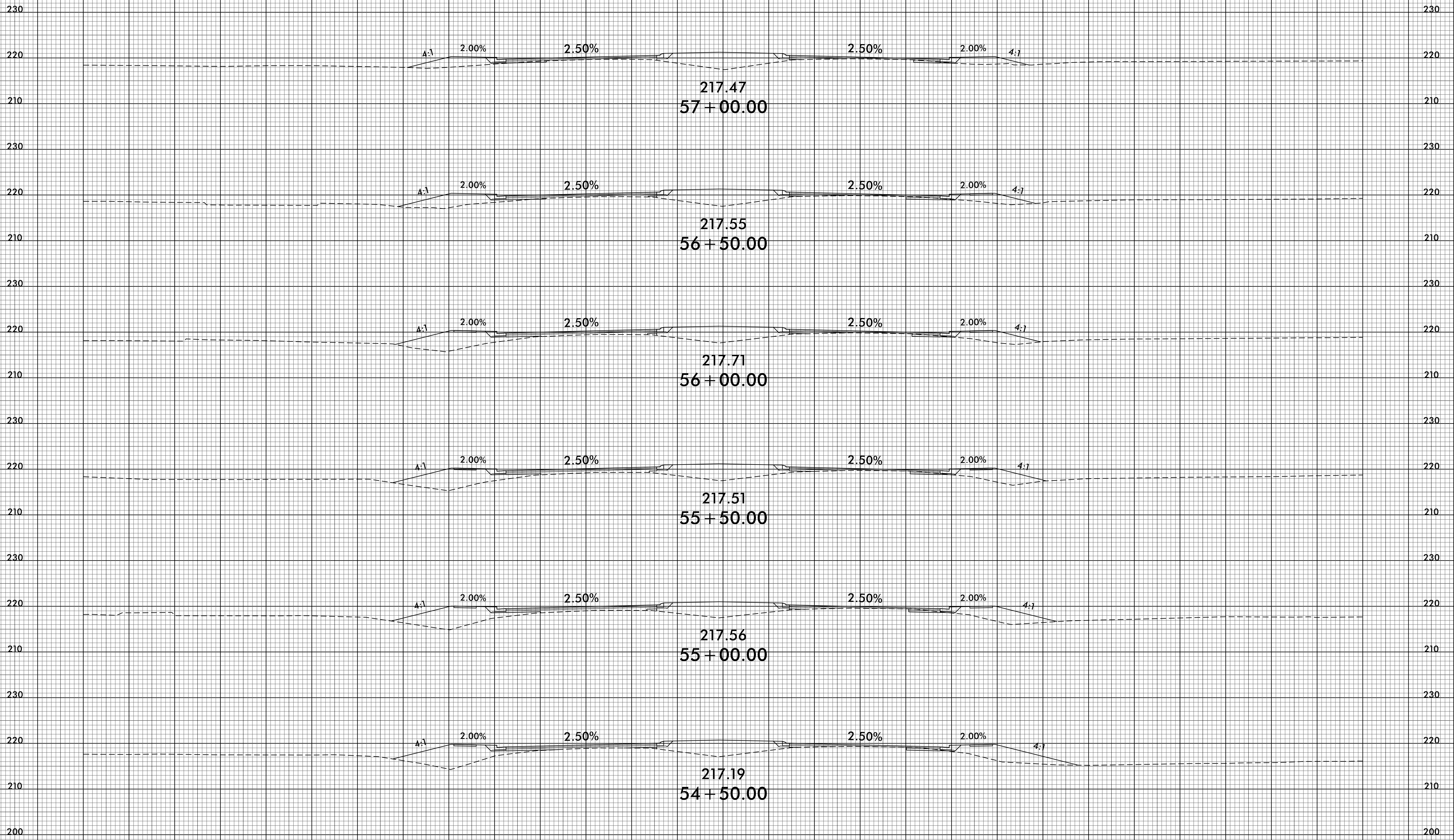

140 130 120 110 100 90 80 70 60 50 40 30 20 10 0 10 20 30 40 50 60 70 80 90 100 110 120 130 140

10-JUN-2021 16:01
P:\PROJECTS\X\4405A_r.dwg
U-4405A_r.dwg

140 130 120 110 100 90 80 70 60 50 40 30 20 10 0 10 20 30 40 50 60 70 80 90 100 110 120 130 140

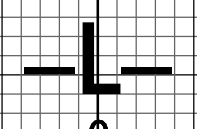
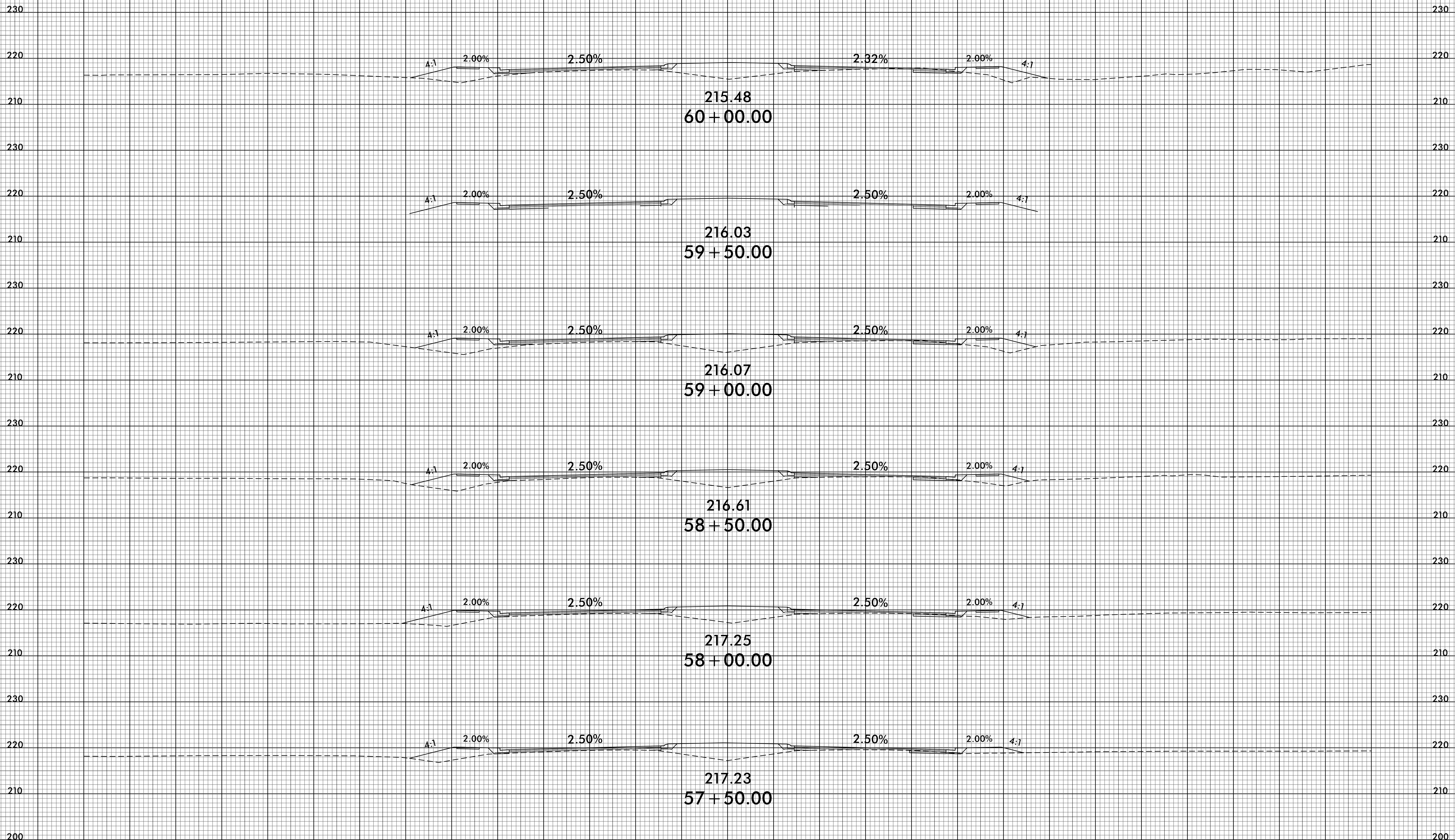

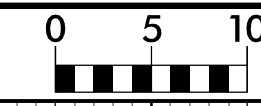

140 130 120 110 100 90 80 70 60 50 40 30 20 10 0 10 20 30 40 50 60 70 80 90 100 110 120 130 140

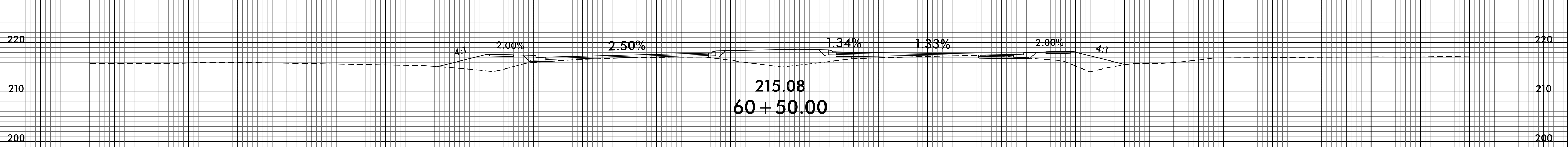
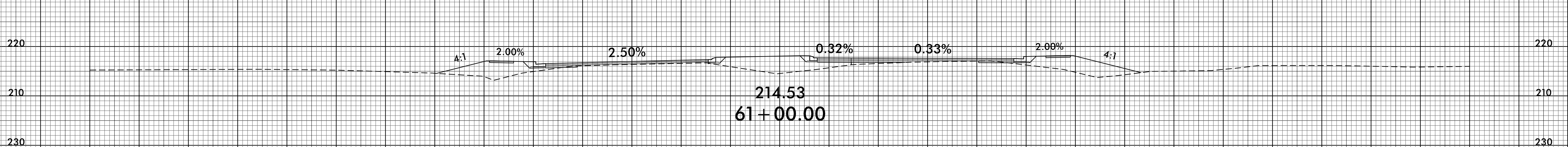
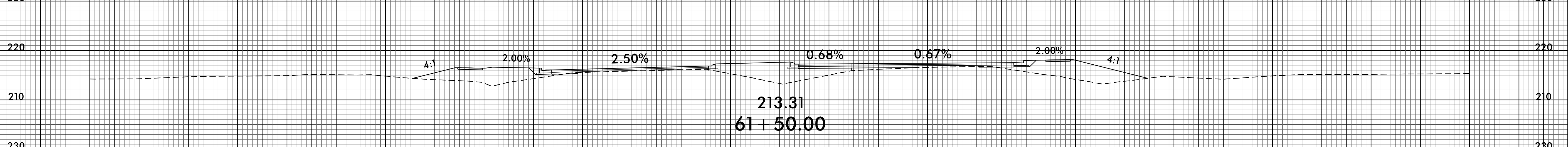
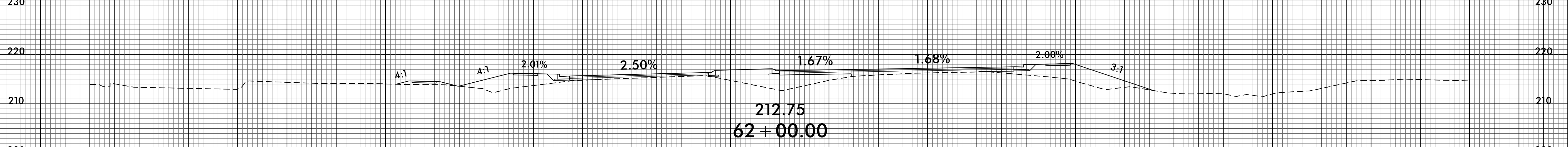
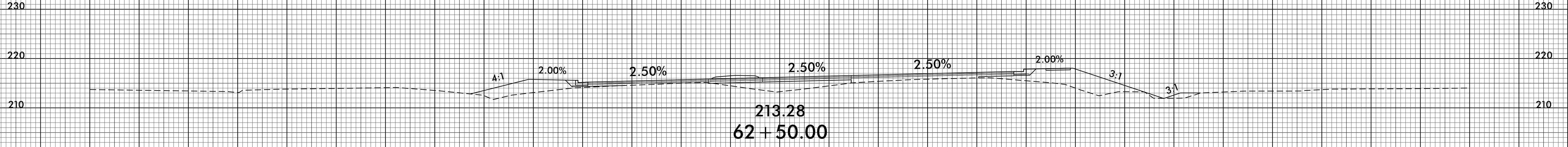
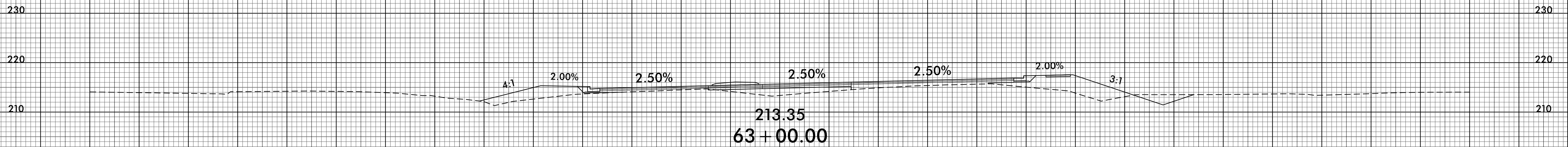

140 130 120 110 100 90 80 70 60 50 40 30 20 10 0 10 20 30 40 50 60 70 80 90 100 110 120 130 140

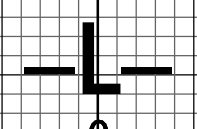

140 130 120 110 100 90 80 70 60 50 40 30 20 10 0 10 20 30 40 50 60 70 80 90 100 110 120 130 140

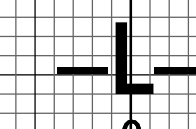
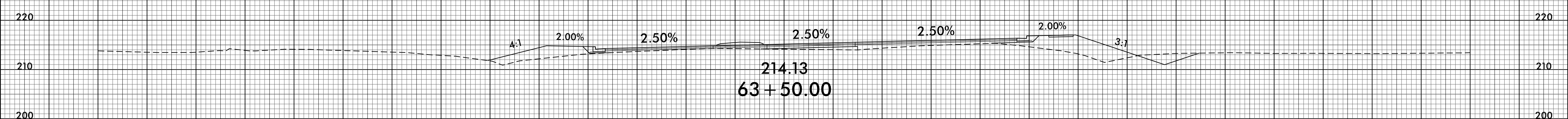
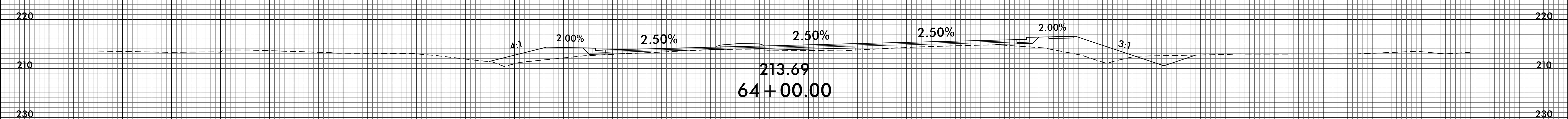
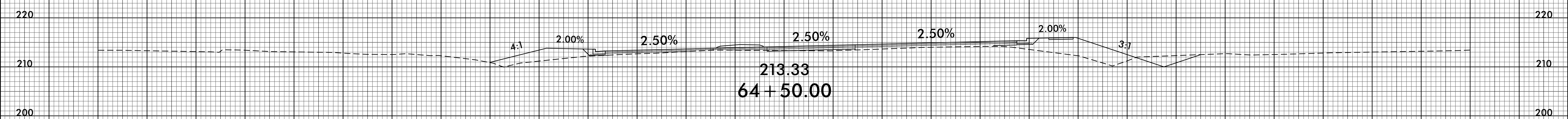
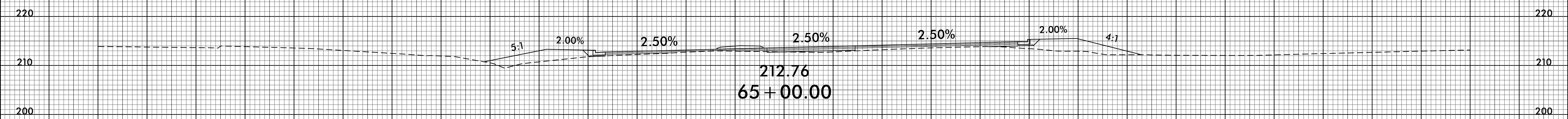
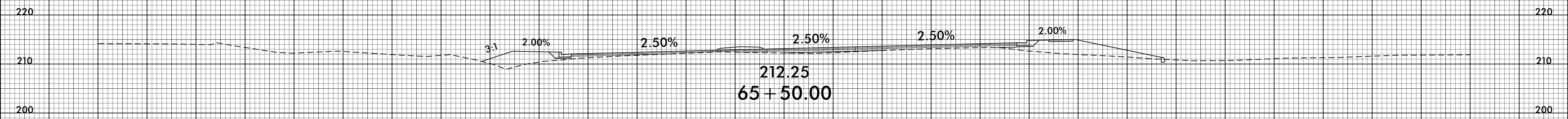
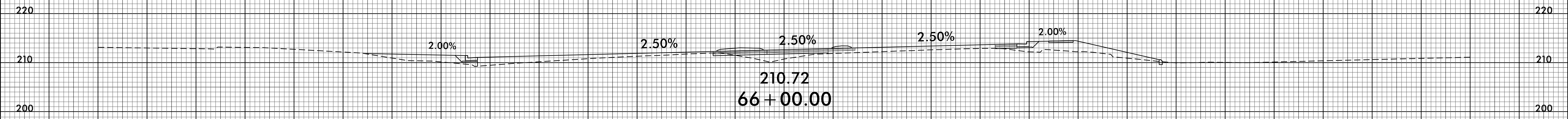

140 130 120 110 100 90 80 70 60 50 40 30 20 10 0 10 20 30 40 50 60 70 80 90 100 110 120 130 140

140 130 120 110 100 90 80 70 60 50 40 30 20 10 0 10 20 30 40 50 60 70 80 90 100 110 120 130 140

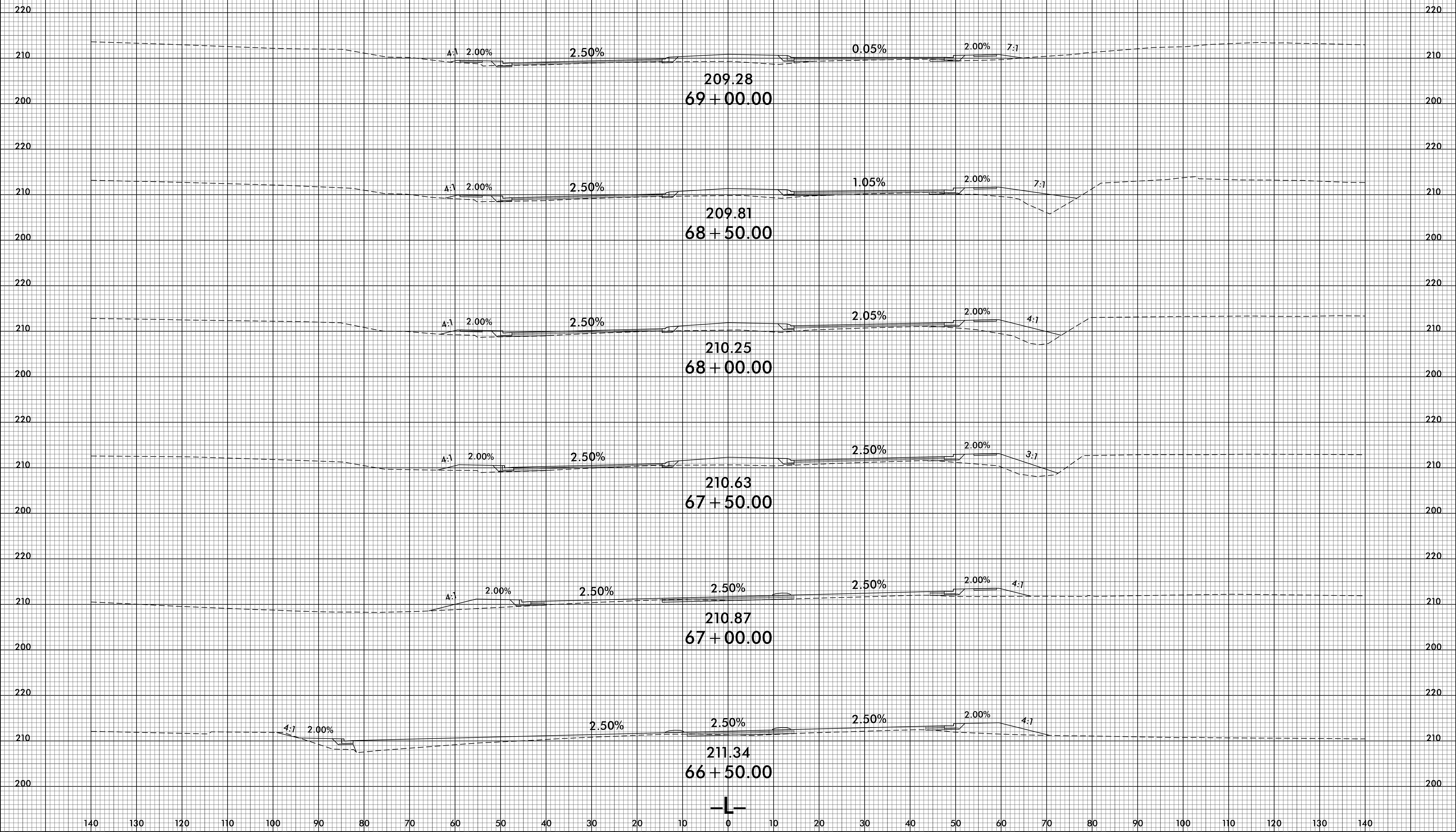

8/23/99

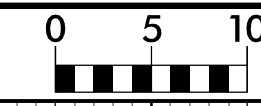

PROJ. REFERENCE NO.
U-4405A

SHEET NO.
X-19

140 130 120 110 100 90 80 70 60 50 40 30 20 10 0 10 20 30 40 50 60 70 80 90 100 110 120 130 140

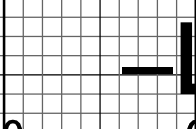
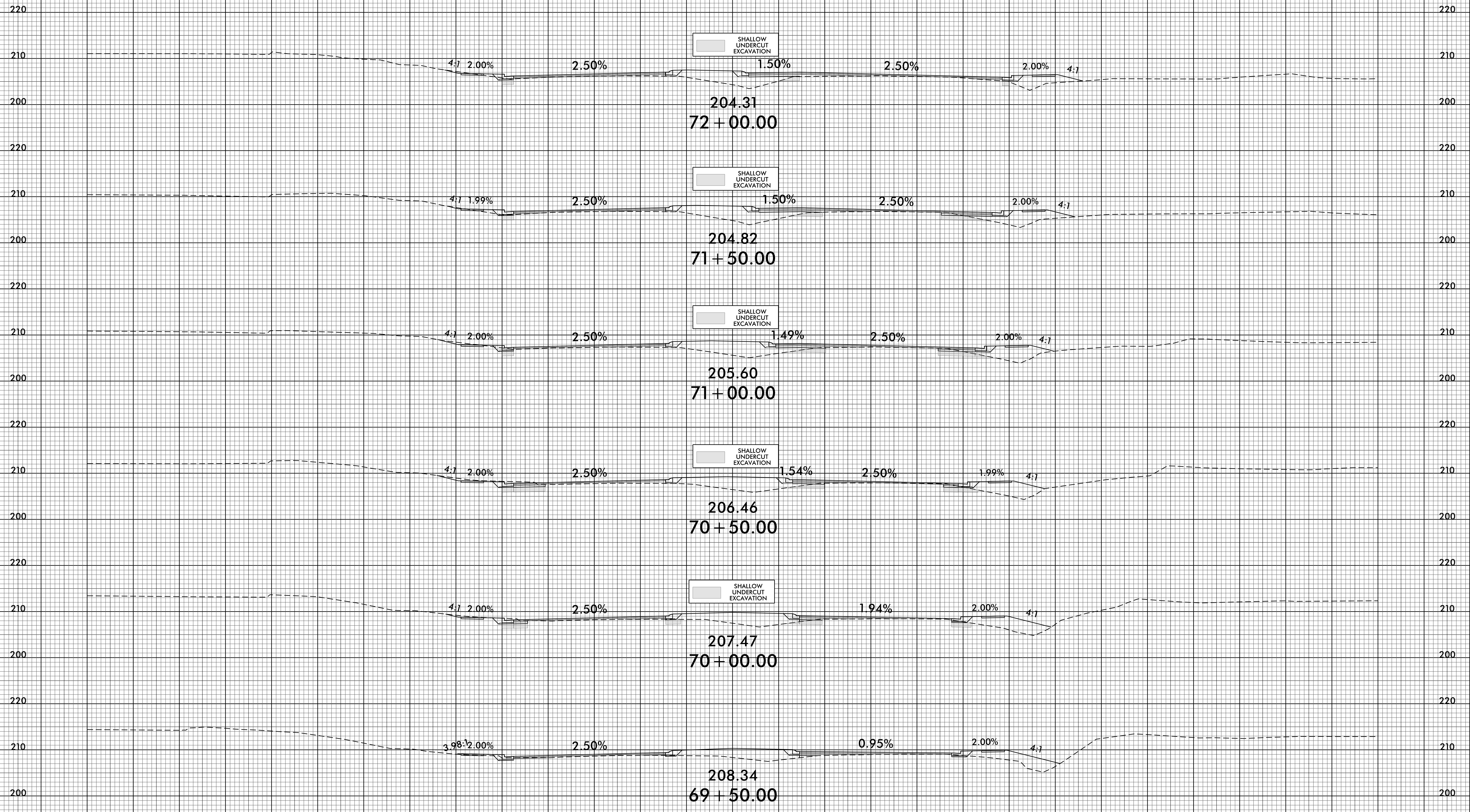

10-JUN-2021 16:27
R:\PROJECTS\X\A\4405A_r.dwg
\$\$\$\$

140 130 120 110 100 90 80 70 60 50 40 30 20 10 0 10 20 30 40 50 60 70 80 90 100 110 120 130 140

140 130 120 110 100 90 80 70 60 50 40 30 20 10 0 10 20 30 40 50 60 70 80 90 100 110 120 130 140

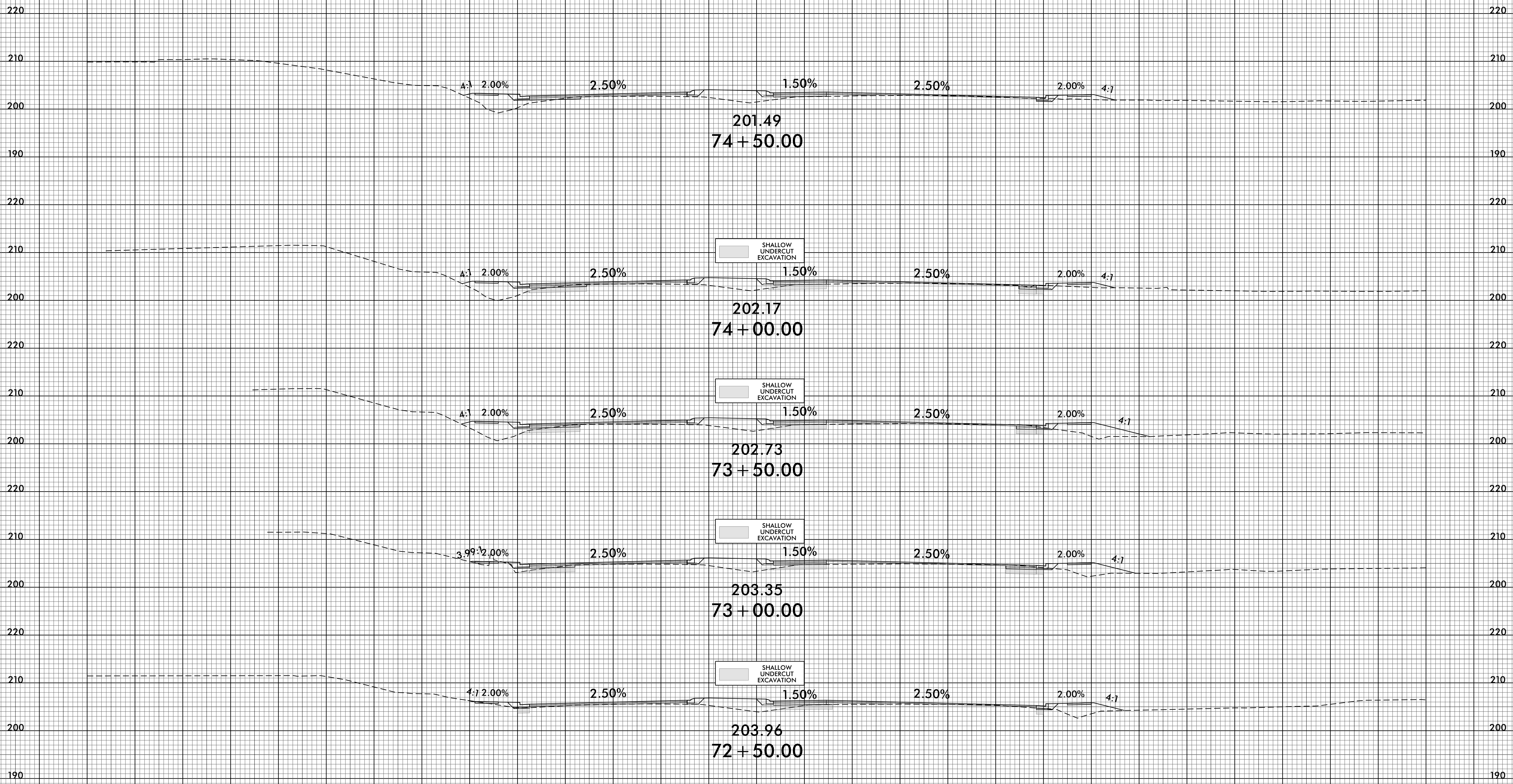

140 130 120 110 100 90 80 70 60 50 40 30 20 10 0 10 20 30 40 50 60 70 80 90 100 110 120 130 140

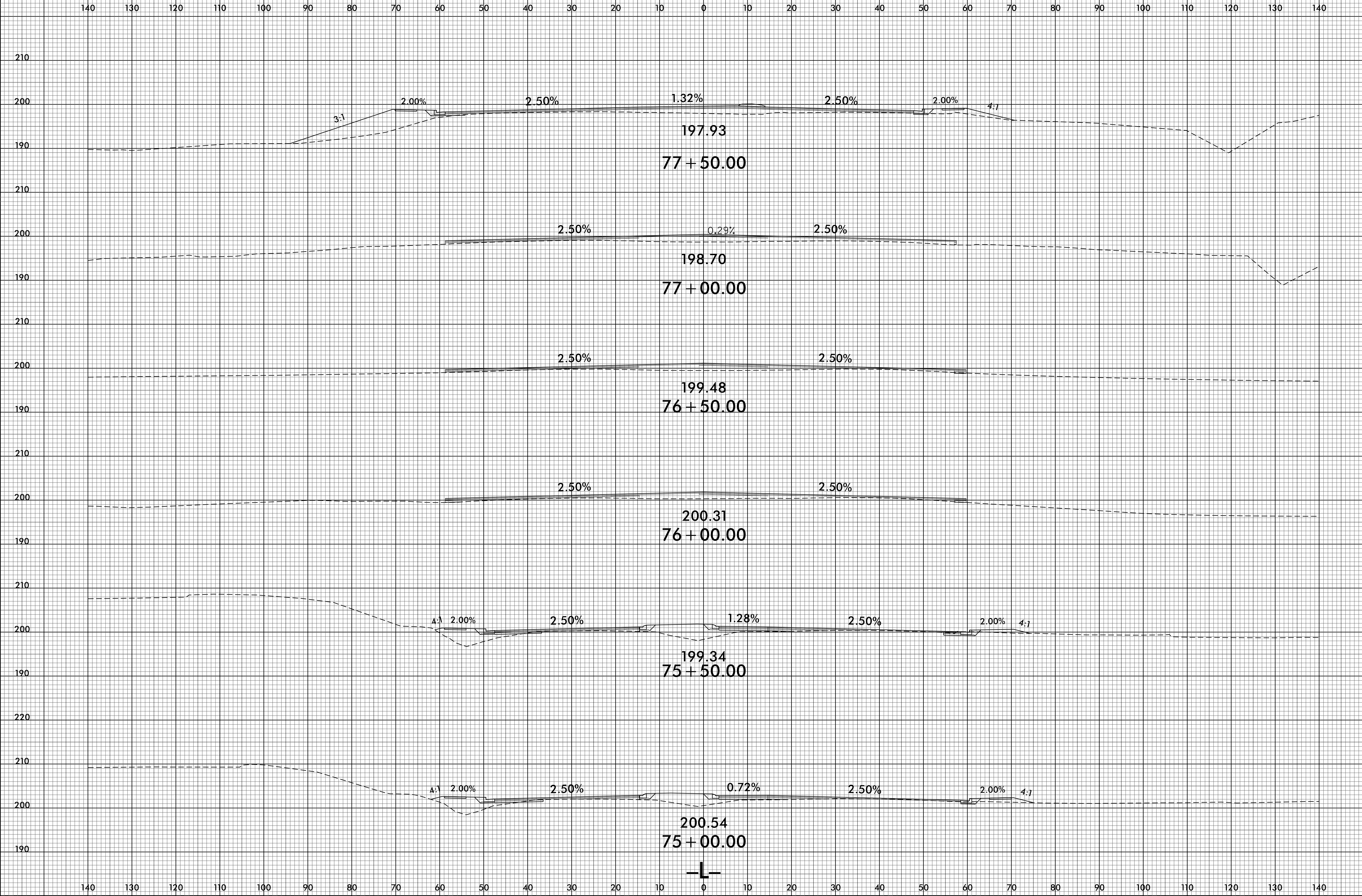

140 130 120 110 100 90 80 70 60 50 40 30 20 10 0 10 20 30 40 50 60 70 80 90 100 110 120 130 140

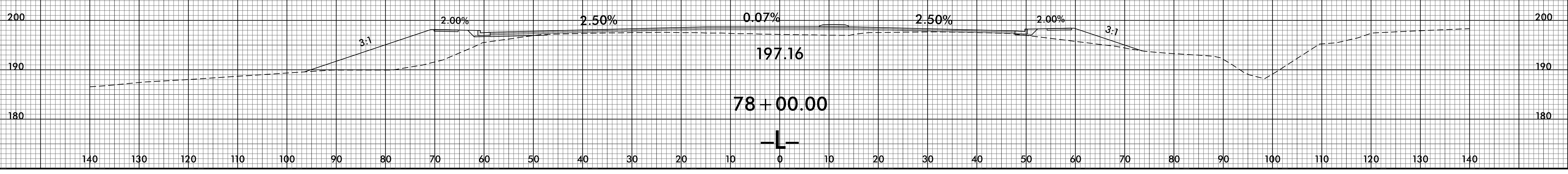
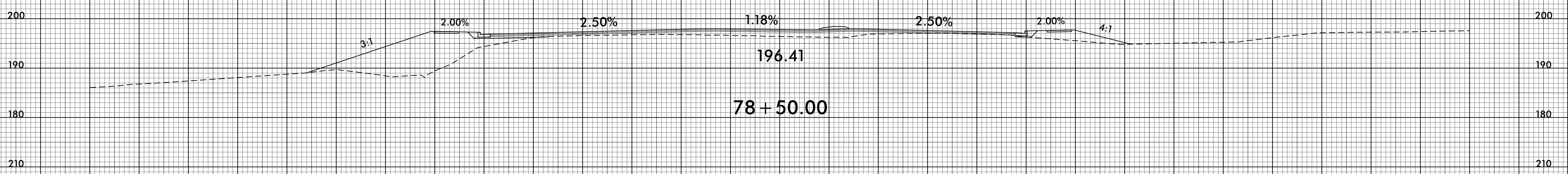
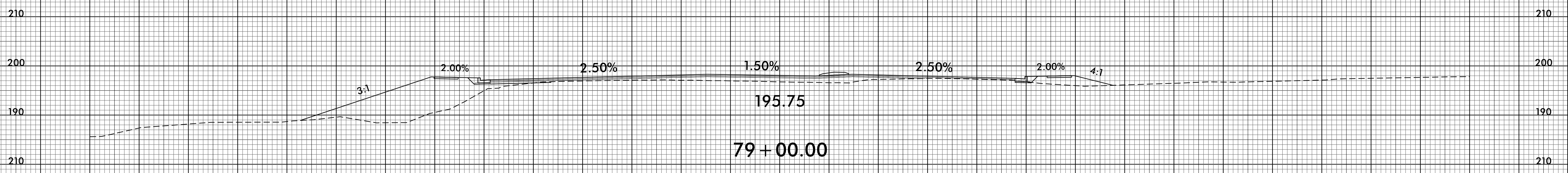
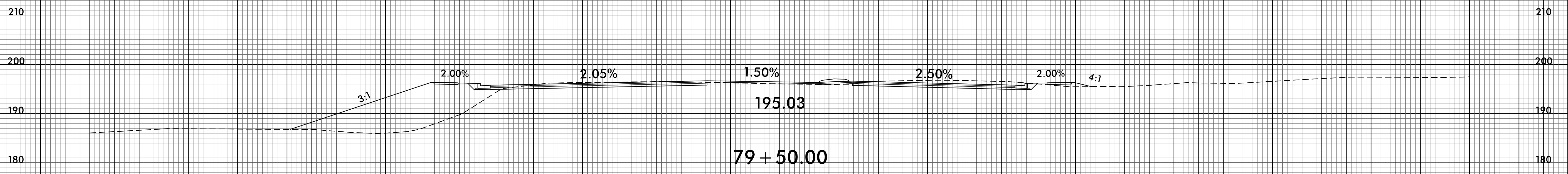
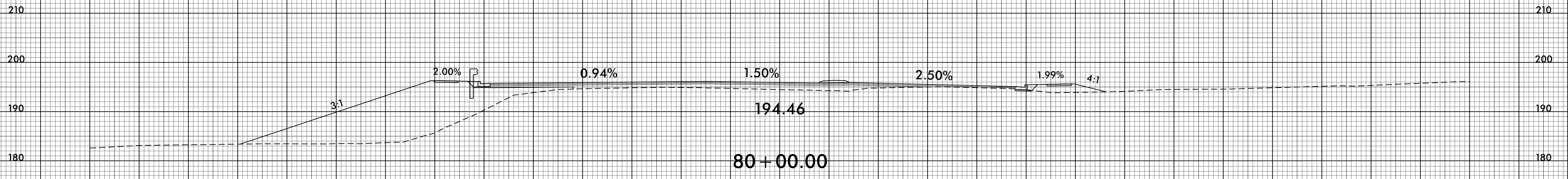

140 130 120 110 100 90 80 70 60 50 40 30 20 10 0 10 20 30 40 50 60 70 80 90 100 110 120 130 140

8/23/99

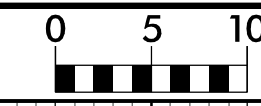

PROJ. REFERENCE NO.
U-4405A

SHEET NO.
X-23

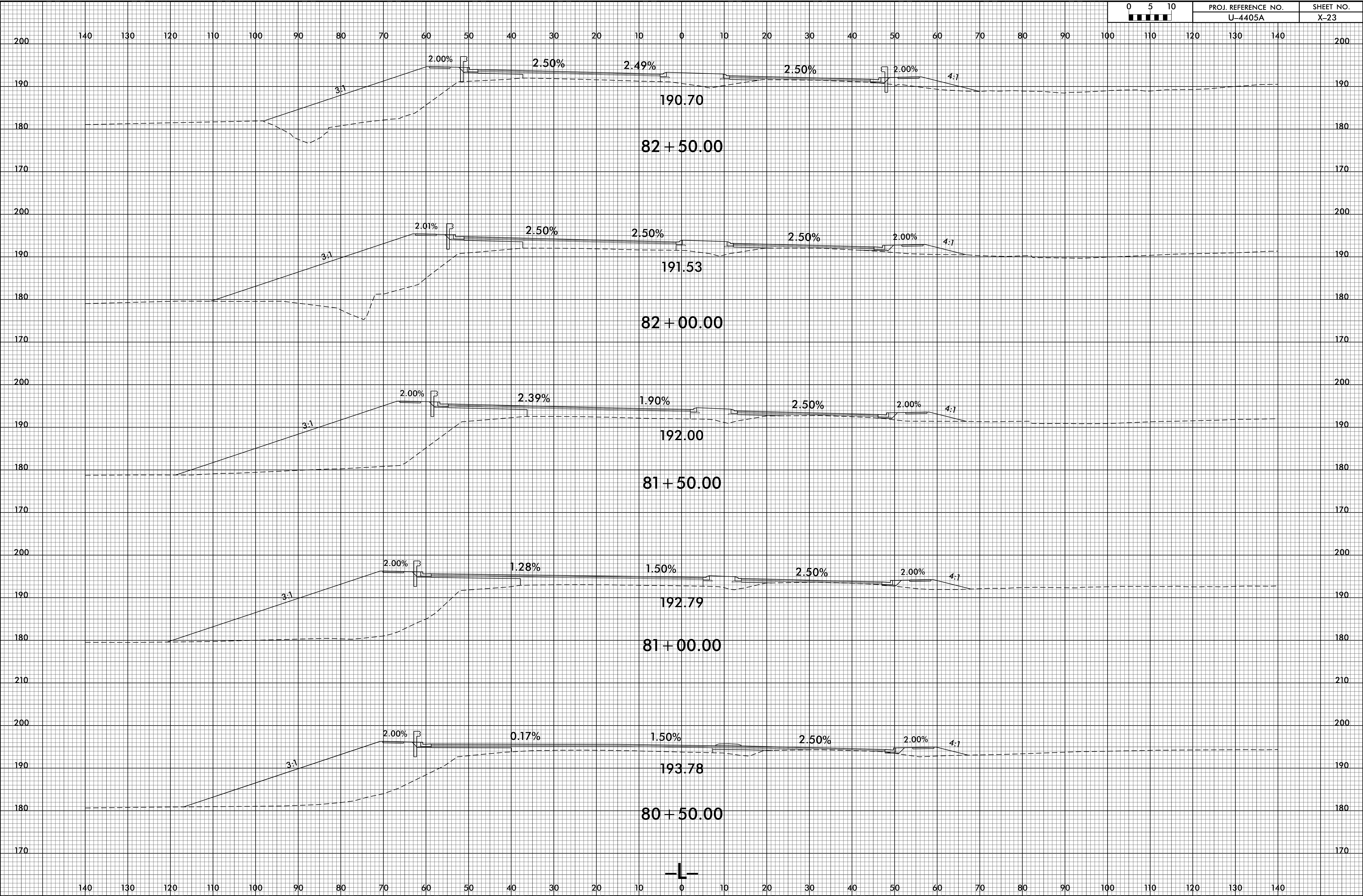

10-JUN-2021 16:32
R:\PROJECTS\X\4405A\4405A_r.dwg
\$\$\$\$

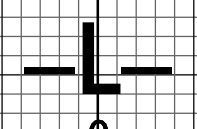

8/23/99

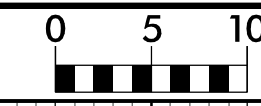

PROJ. REFERENCE NO.
U-4405A

SHEET NO.
X-24

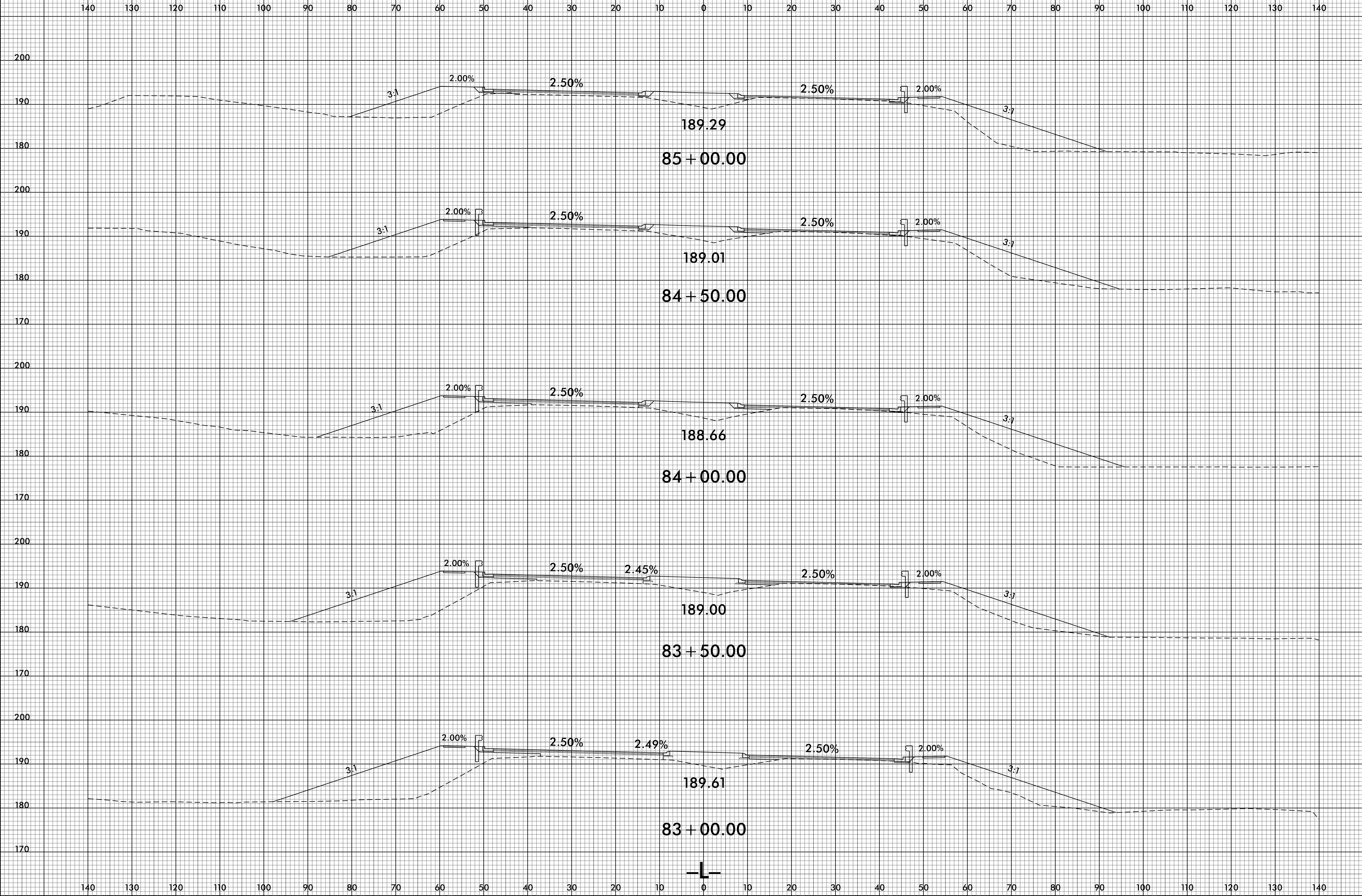

140 130 120 110 100 90 80 70 60 50 40 30 20 10 0 10 20 30 40 50 60 70 80 90 100 110 120 130 140

200

190

180

200

190

180

170

200

190

180

170

200

190

180

170

200

190

180

170

140 130 120 110 100 90 80 70 60 50 40 30 20 10 0 10 20 30 40 50 60 70 80 90 100 110 120 130 140

189.29

85 + 00.00

189.01

84 + 50.00

188.66

84 + 00.00

189.00

83 + 50.00

189.61

83 + 00.00

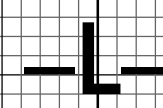

10-JUN-2021 16:33
 P:\PROJECTS\X\A4405A_r.dwg
 \$USER\$

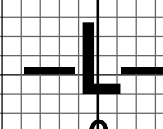
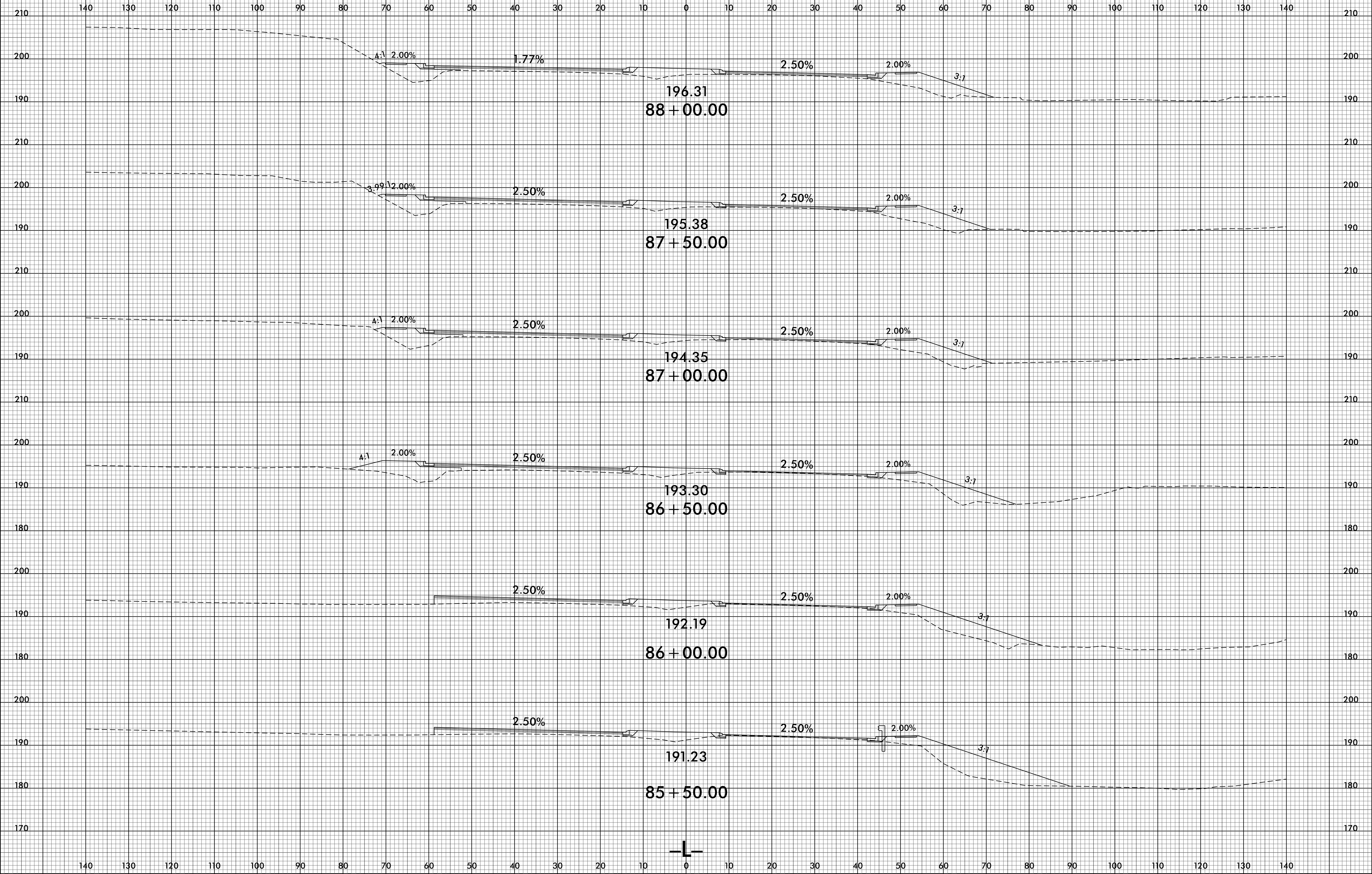

8/23/99

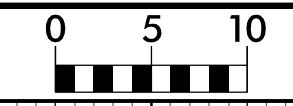

PROJ. REFERENCE NO.
U-4405A

SHEET NO.
X-26

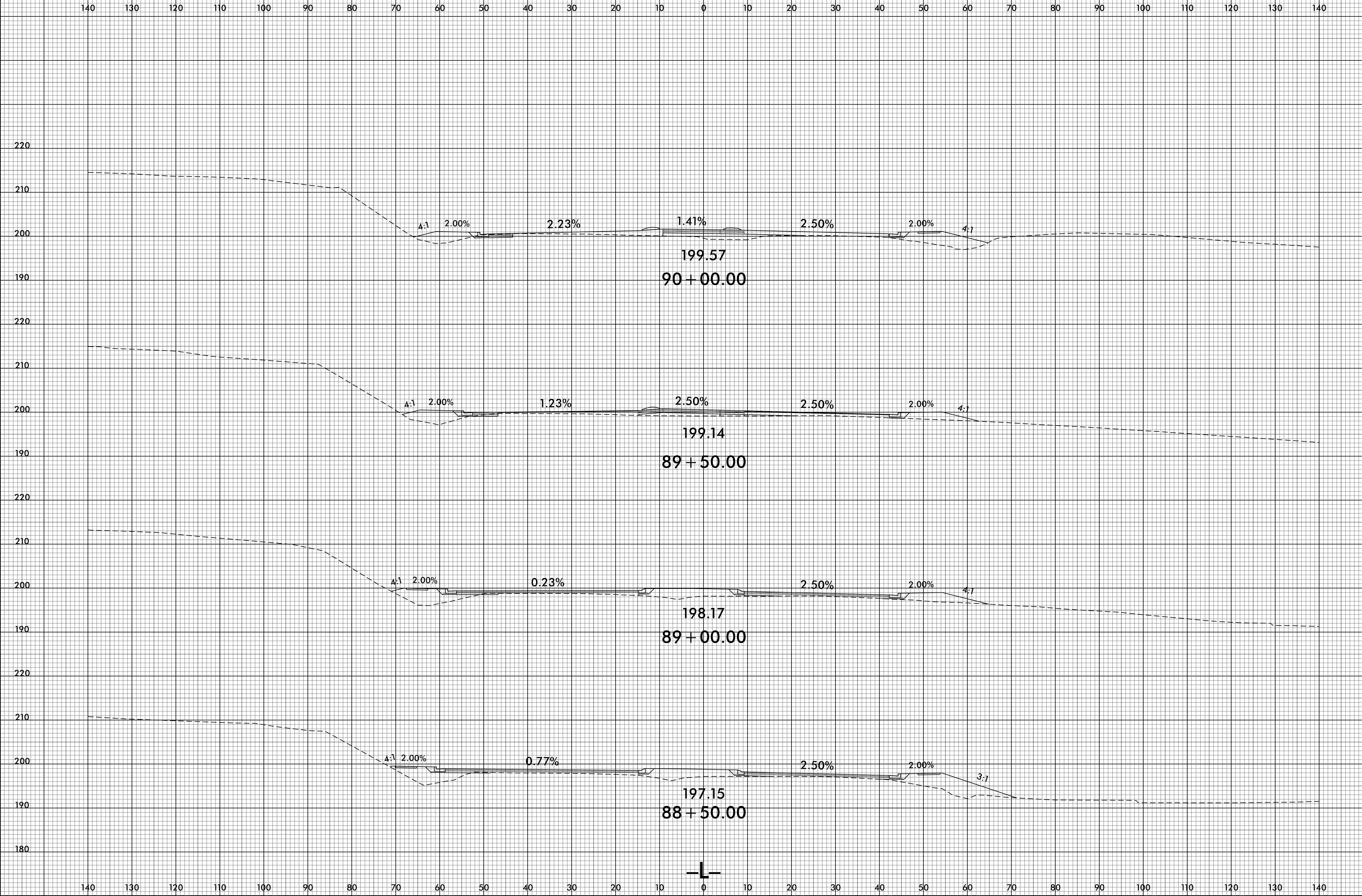

10-JUN-2021 16:35
R:\PROJECTS\X\4405A\4405A_r.dwg
\$\$\$\$

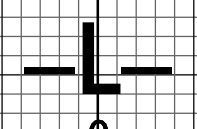

140 130 120 110 100 90 80 70 60 50 40 30 20 10 0 10 20 30 40 50 60 70 80 90 100 110 120 130 140

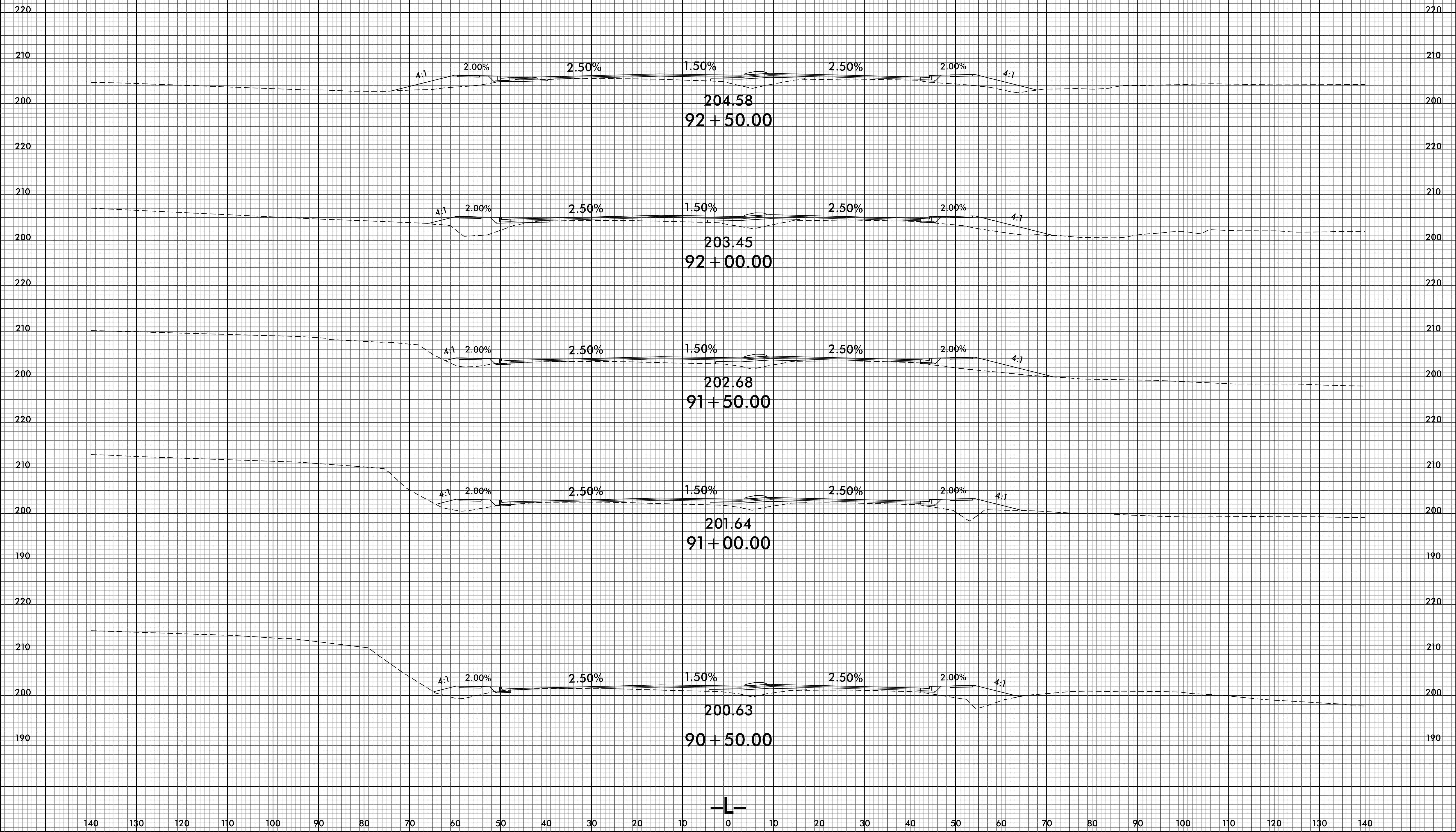

8/23/99

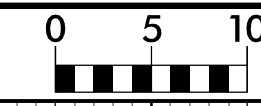

PROJ. REFERENCE NO.
U-4405A

SHEET NO.
X-28

140 130 120 110 100 90 80 70 60 50 40 30 20 10 0 10 20 30 40 50 60 70 80 90 100 110 120 130 140

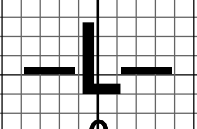
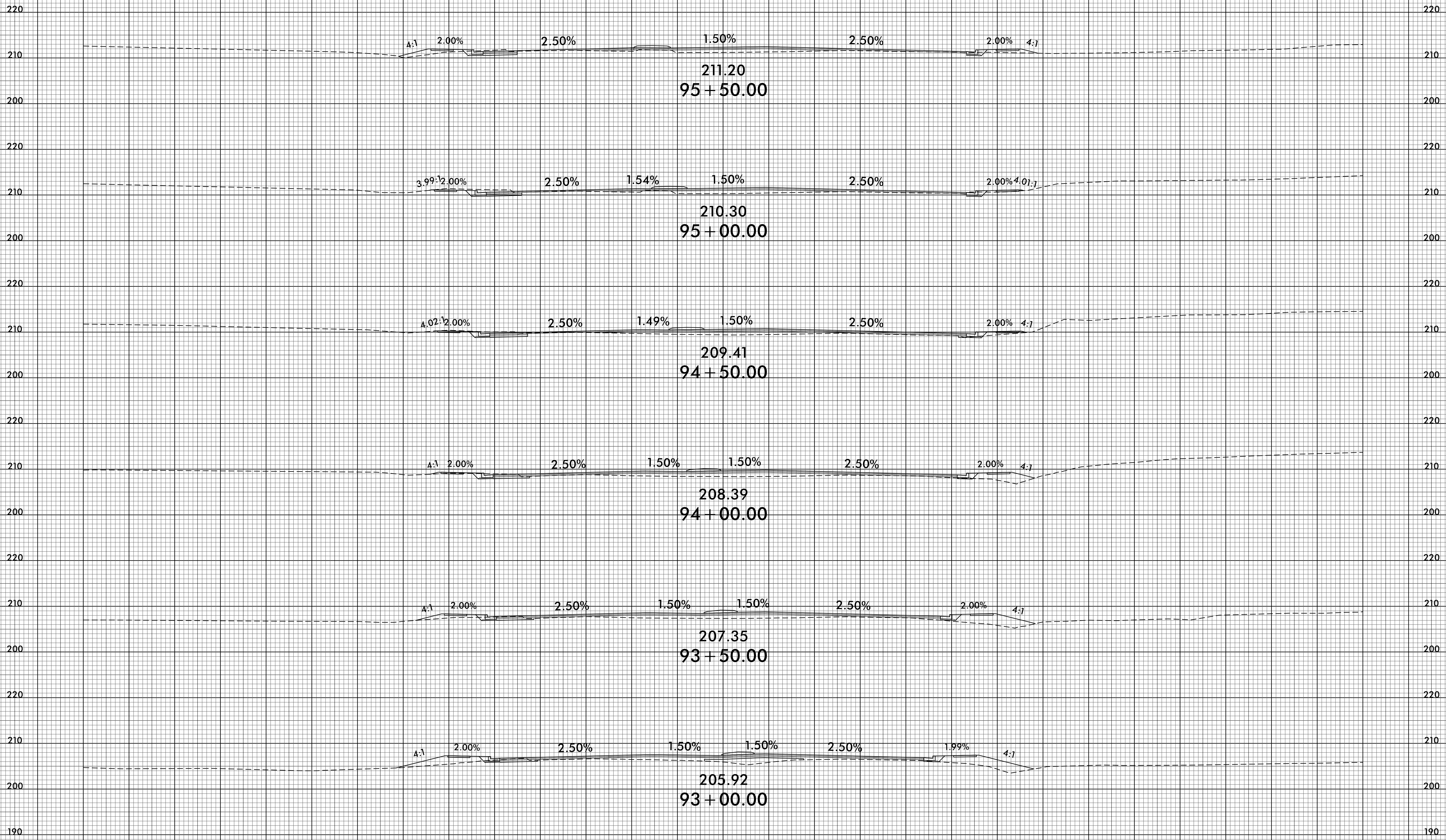

140 130 120 110 100 90 80 70 60 50 40 30 20 10 0 10 20 30 40 50 60 70 80 90 100 110 120 130 140

10-JUN-2021 16:37
R:\PROJECTS\X\A\4405A_rdu_xpl.dgn

8/23/99

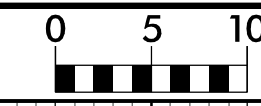

PROJ. REFERENCE NO.
U-4405A

SHEET NO.
X-29

140 130 120 110 100 90 80 70 60 50 40 30 20 10 0 10 20 30 40 50 60 70 80 90 100 110 120 130 140

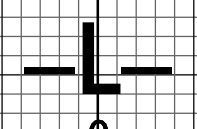
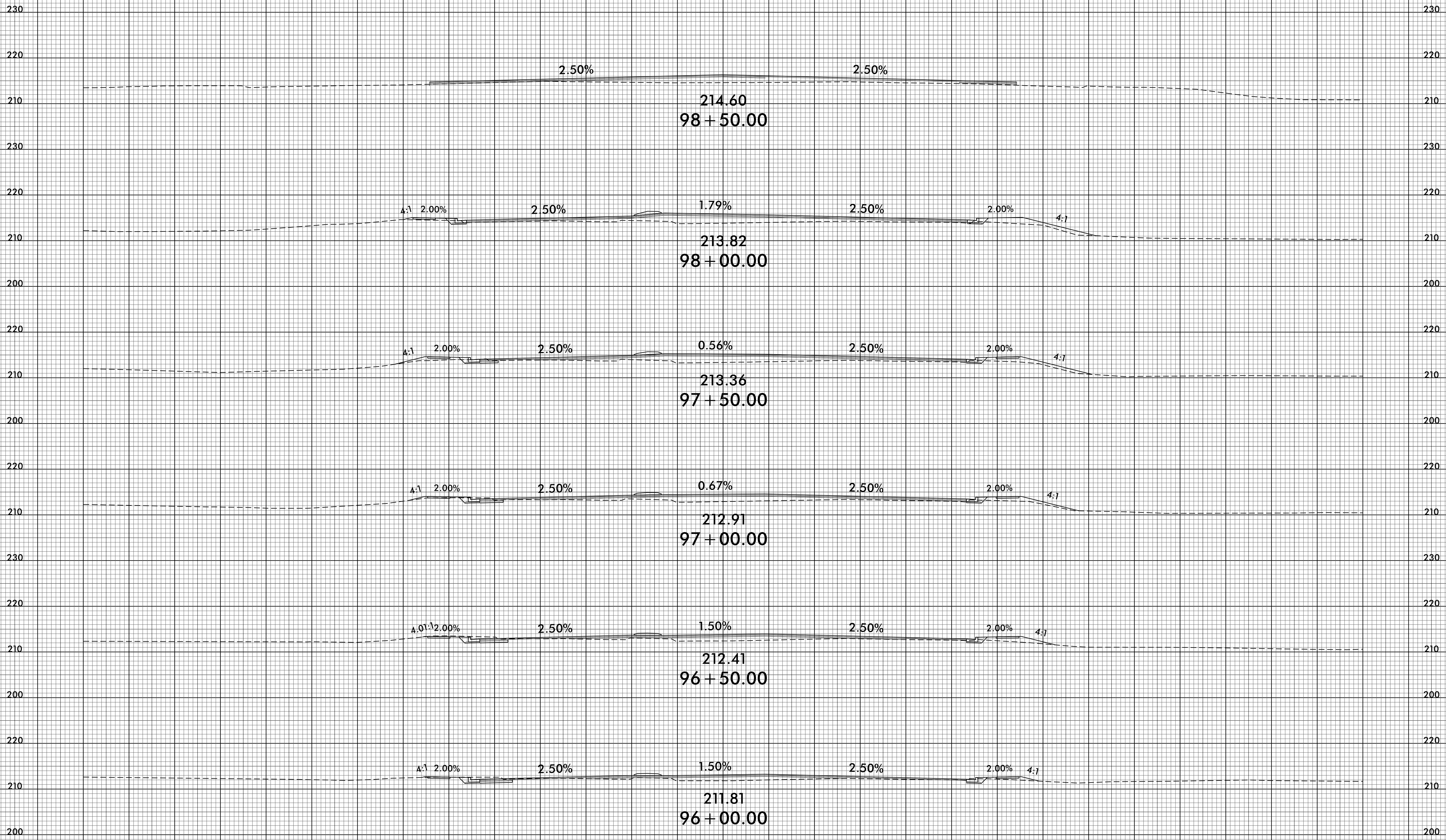

10-JUN-2021 16:42
R:\PROJECTS\X\A\4405A_r.dwg
\$\$\$\$

8/23/99

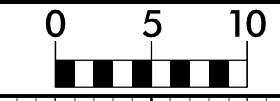

PROJ. REFERENCE NO.
U-4405A

SHEET NO.
X-30

140 130 120 110 100 90 80 70 60 50 40 30 20 10 0 10 20 30 40 50 60 70 80 90 100 110 120 130 140

230 230

220 220

210 210

216.82
101 + 50.00

4:1 2.00% 2.50% 0.99% 2.50% 2.00% 4:1

230 230

220 220

210 210

216.61
101 + 00.00

4:1 2.00% 2.50% 0.26% 2.50% 2.00% 4:1

230 230

220 220

210 210

216.42
100 + 50.00

4:1 2.00% 2.50% 1.51% 2.50% 2.00% 4:1

230 230

220 220

210 210

216.16
100 + 00.00

2.50% 2.50%

230 230

220 220

210 210

215.63
99 + 50.00

2.50% 2.50%

230 230

220 220

210 210

215.16
99 + 00.00

2.50% 2.50%

200 200

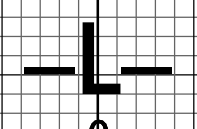

140 130 120 110 100 90 80 70 60 50 40 30 20 10 0 10 20 30 40 50 60 70 80 90 100 110 120 130 140

\\JUN-20210721
R:\PROJECTS\X\4405A_rdu_xpl.dgn

8/23/99

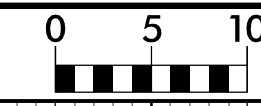

PROJ. REFERENCE NO.
U-4405A

SHEET NO.
X-31

140 130 120 110 100 90 80 70 60 50 40 30 20 10 0 10 20 30 40 50 60 70 80 90 100 110 120 130 140

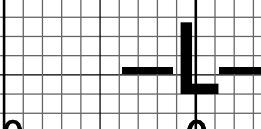
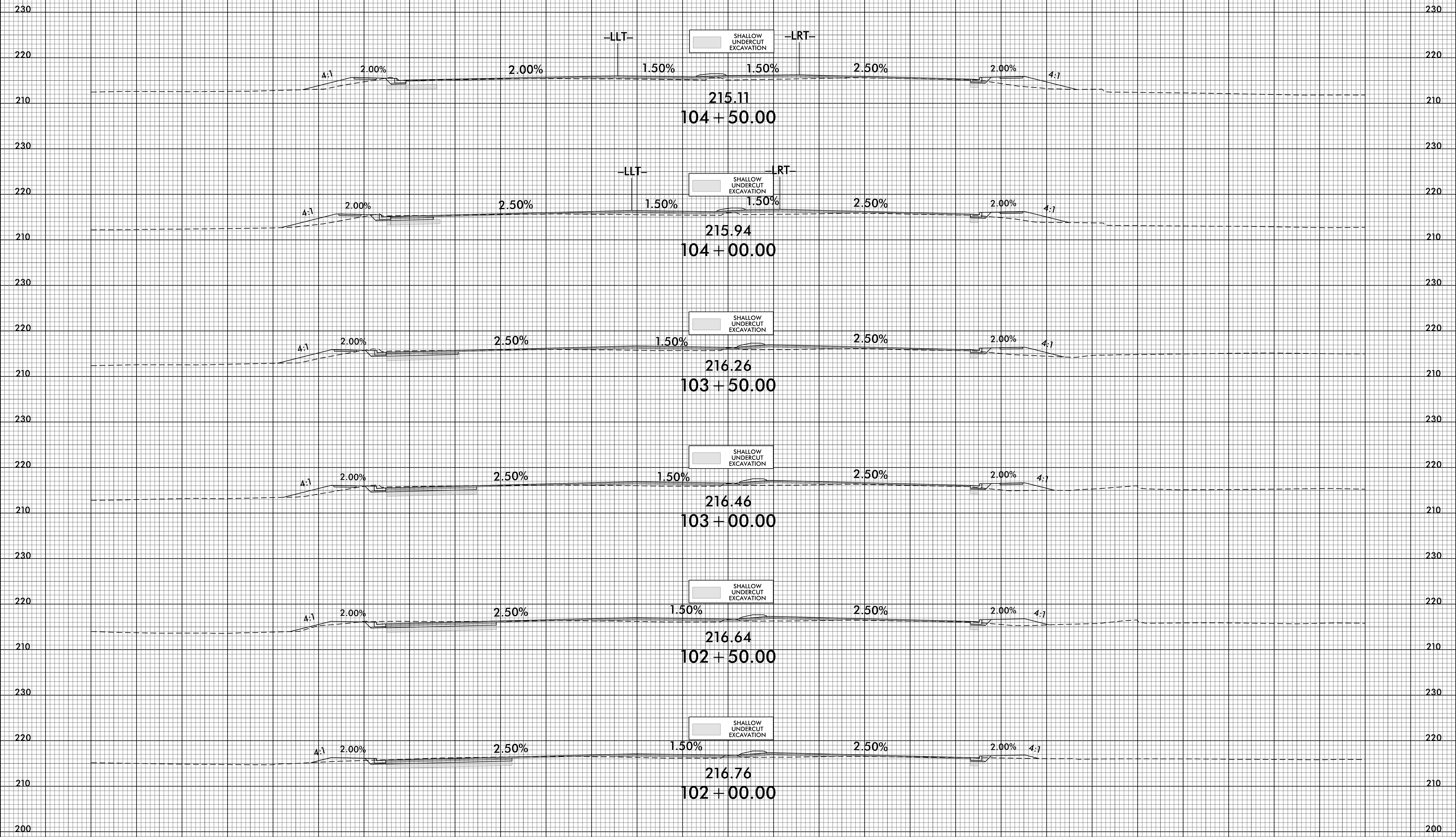

140 130 120 110 100 90 80 70 60 50 40 30 20 10 0 10 20 30 40 50 60 70 80 90 100 110 120 130 140

\\JUN-20210726
R:\PROJECTS\X\4405A\4405A_rdu_xpl.dgn

8/23/99

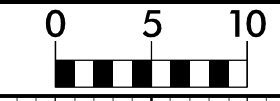

PROJ. REFERENCE NO.
U-4405A

SHEET NO.
X-32

140 130 120 110 100 90 80 70 60 50 40 30 20 10 0 10 20 30 40 50 60 70 80 90 100 110 120 130 140

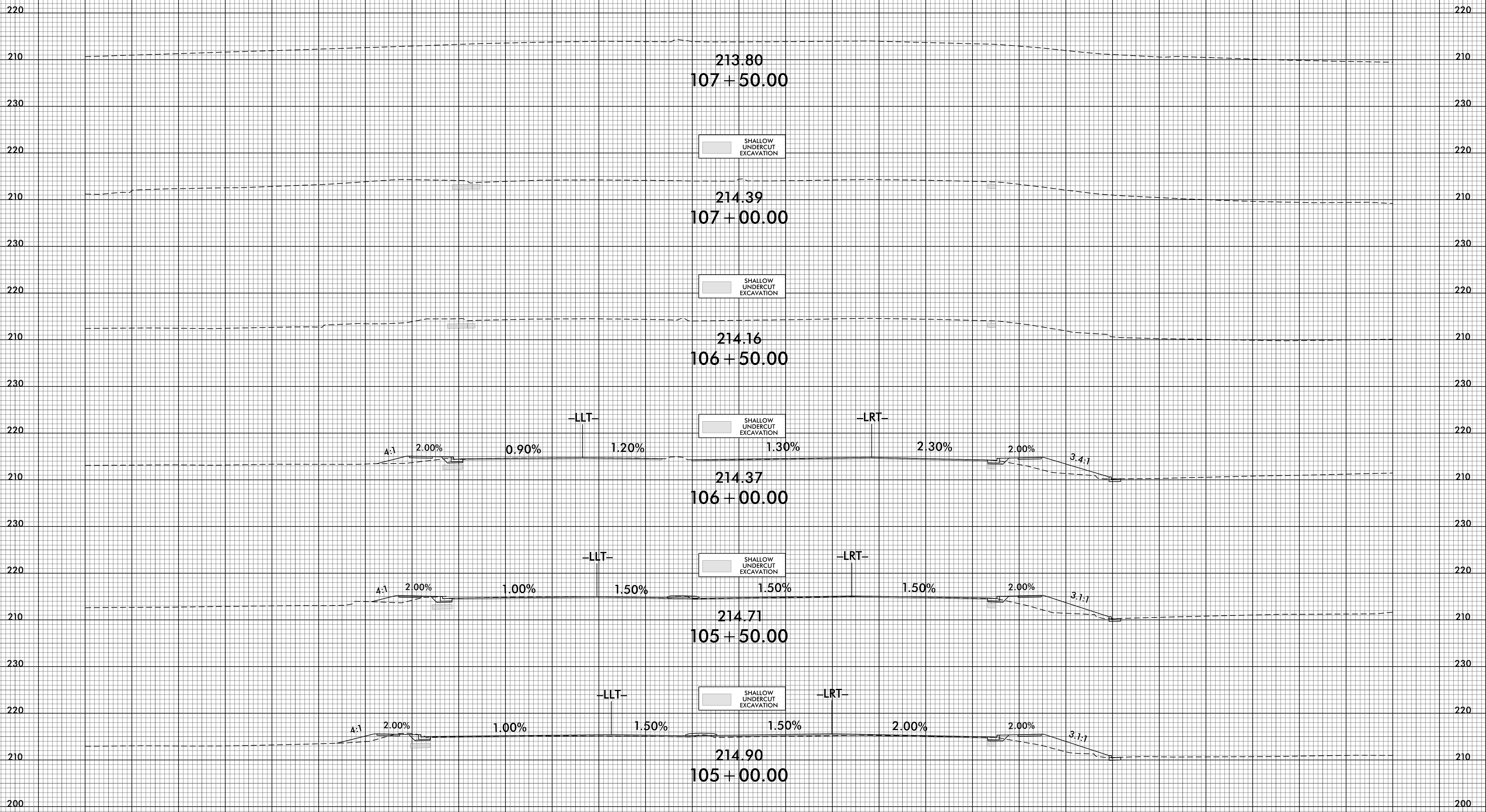

140 130 120 110 100 90 80 70 60 50 40 30 20 10 0 10 20 30 40 50 60 70 80 90 100 110 120 130 140

\\JUN-20210728
R:\PROJECTS\X\4405A_r.dwg
8/23/99

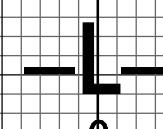

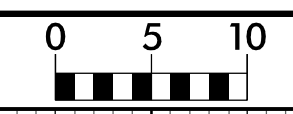

140 130 120 110 100 90 80 70 60 50 40 30 20 10 0 10 20 30 40 50 60 70 80 90 100 110 120 130 140

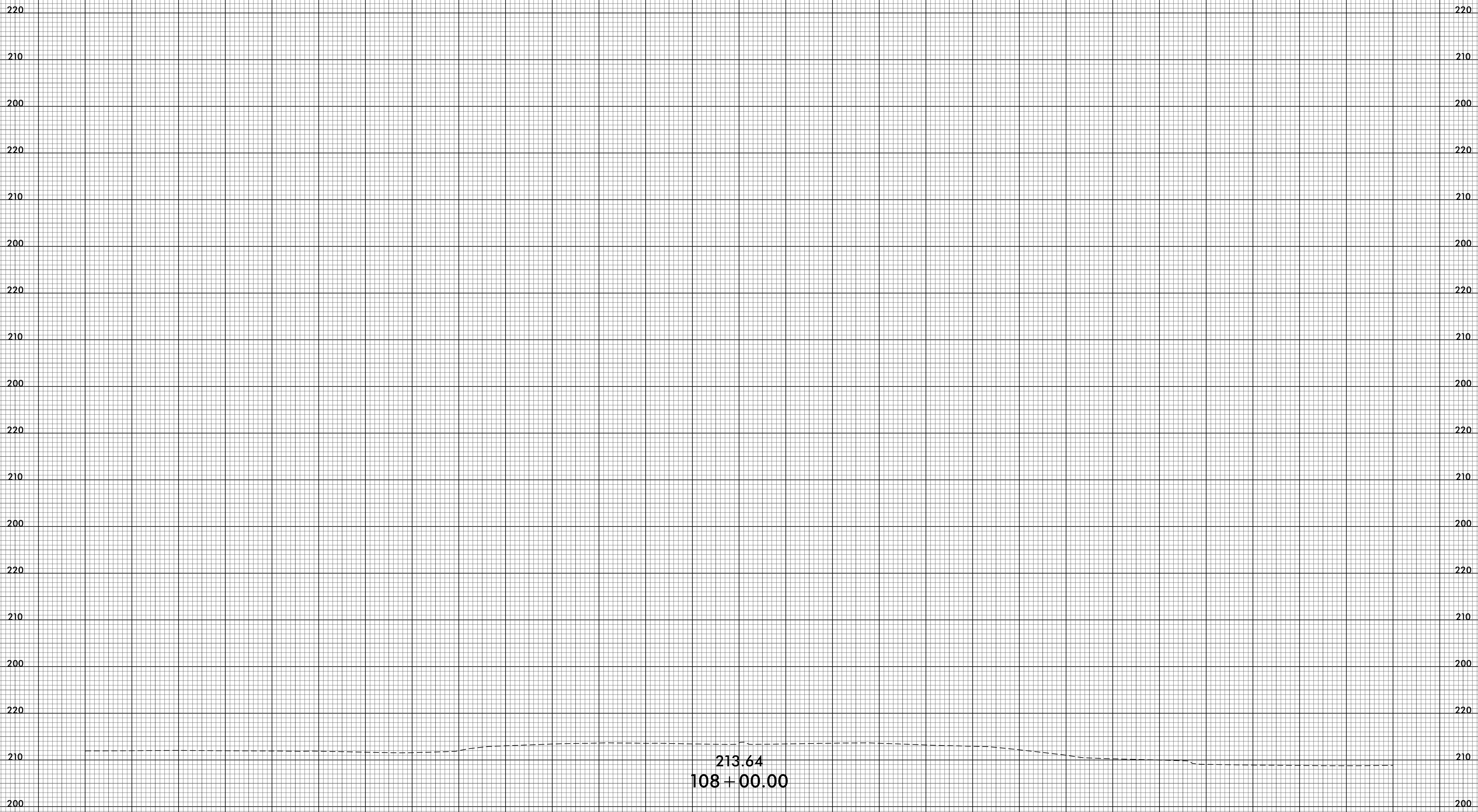

213.64
108+00.00

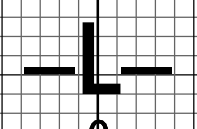

140 130 120 110 100 90 80 70 60 50 40 30 20 10 0 10 20 30 40 50 60 70 80 90 100 110 120 130 140

8/23/99

0 5 10
█ █ █ █ █ █

PROJ. REFERENCE NO.
U-4405A

SHEET NO.
X-34

140 130 120 110 100 90 80 70 60 50 40 30 20 10 0 10 20 30 40 50 60 70 80 90 100 110 120 130 140

230

230

220

220

219.73
15 + 00.00

230

230

220

220

4:1 2.00% 0.20% 1.00% 2.00% 4:1

219.93
14 + 50.00

230

230

220

220

221.08
14 + 00.00

-Y1-

140 130 120 110 100 90 80 70 60 50 40 30 20 10 0 10 20 30 40 50 60 70 80 90 100 110 120 130 140

I:\JUN-2021\0412
R:\G050901\X\CA\4405A_rdu_xpl.dgn
\$\$\$\$\$

140 130 120 110 100 90 80 70 60 50 40 30 20 10 0 10 20 30 40 50 60 70 80 90 100 110 120 130 140

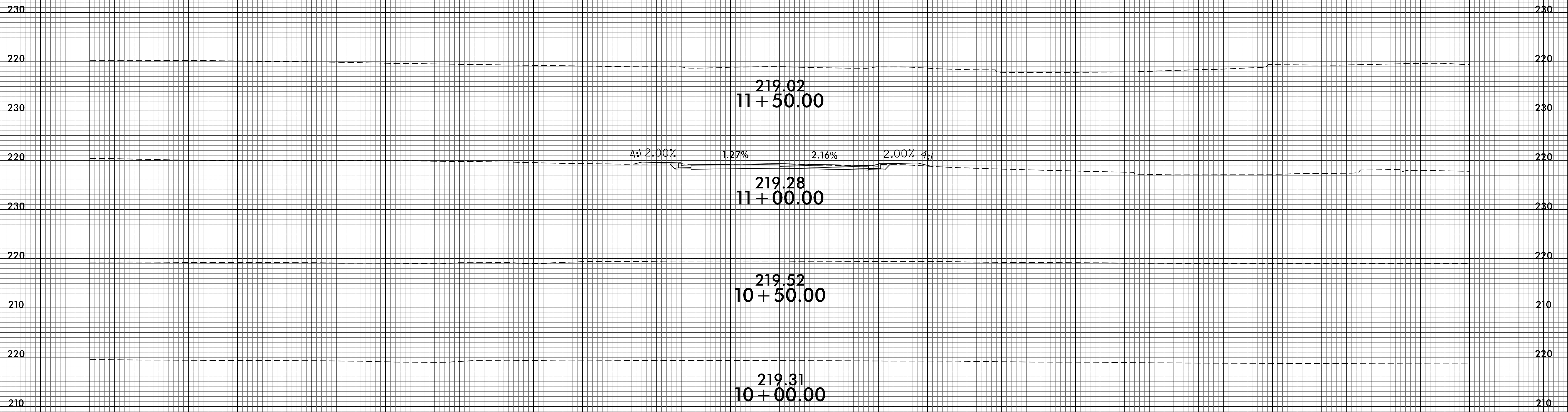

-Y2-

140 130 120 110 100 90 80 70 60 50 40 30 20 10 0 10 20 30 40 50 60 70 80 90 100 110 120 130 140

8/23/99

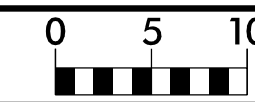

PROJ. REFERENCE NO.
U-4405A

SHEET NO.
X-36

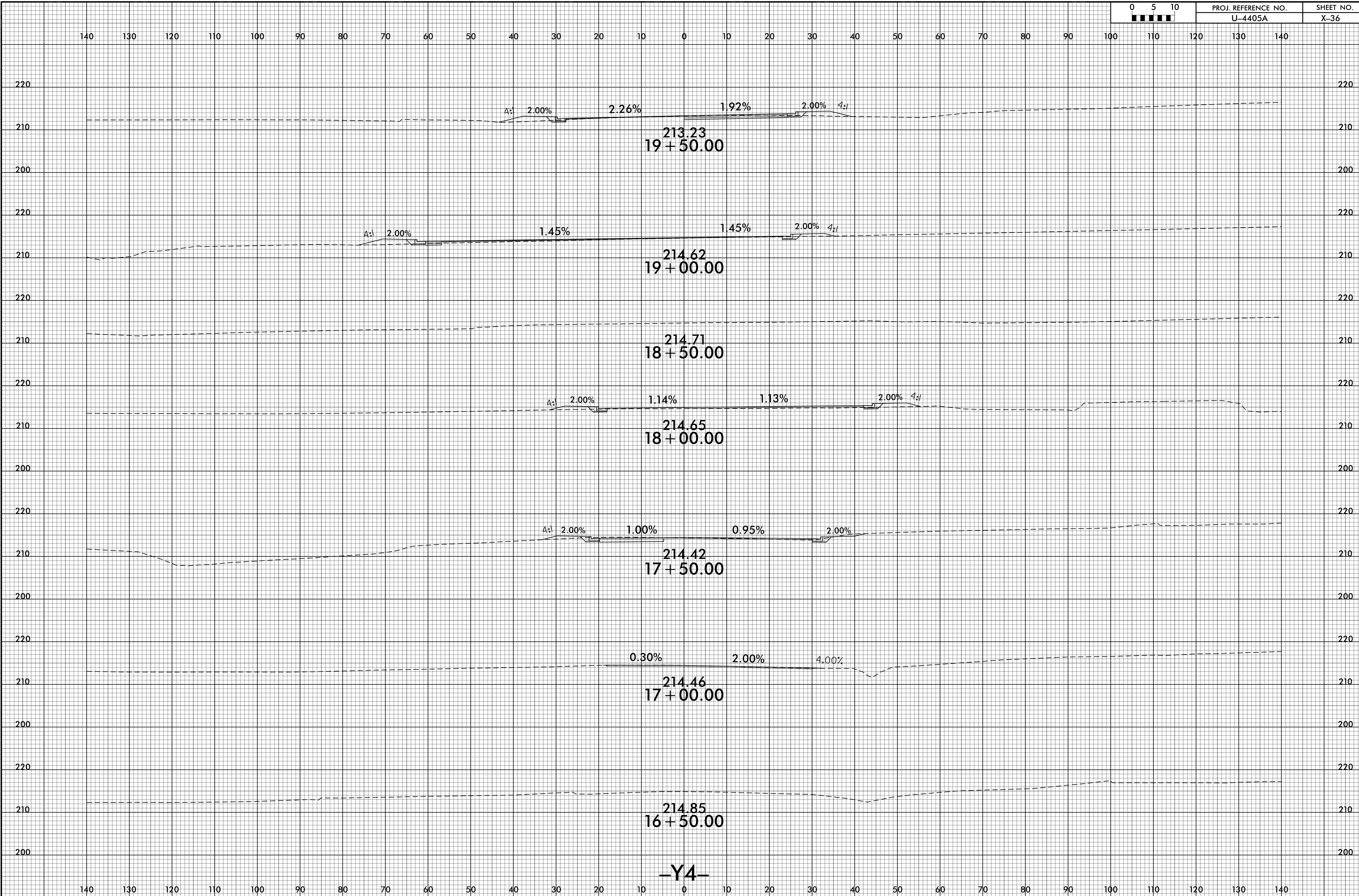

-Y4-

I:\JUN-2021\0433
R:\CADD\X\CA\4405A_rdu_xpl.dgn
\$\$\$\$\$

8/23/99

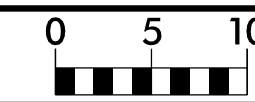

PROJ. REFERENCE NO.
U-4405A

SHEET NO.
X-37

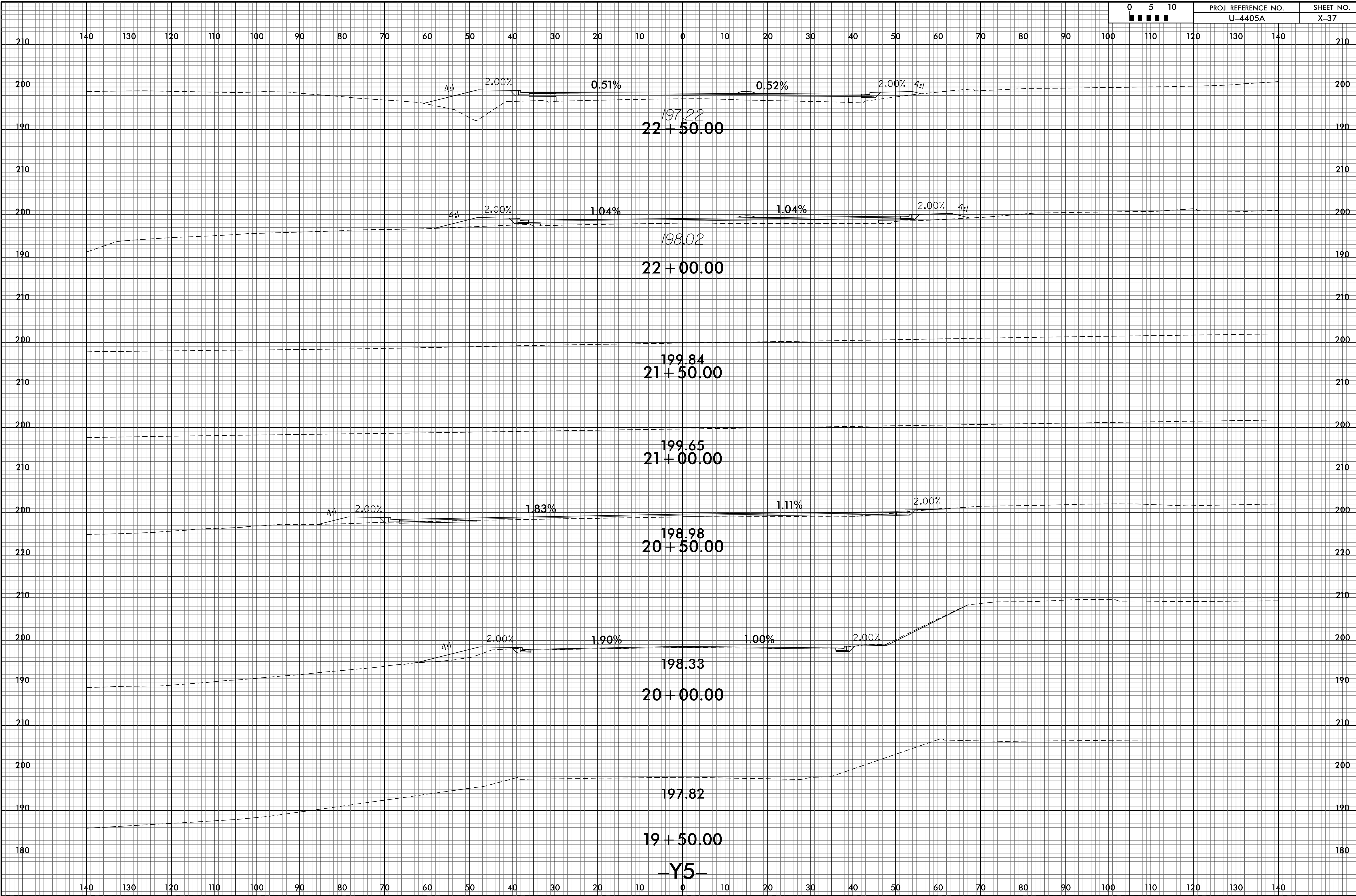

II:JUN-2021 10:36
R:\PROJECTS\X\4405A\4405A_rdu_xpl.dgn
USER:VLM

-Y5-

8/23/99



PROJ. REFERENCE NO.
U-4405A

SHEET NO.
X-38

140 130 120 110 100 90 80 70 60 50 40 30 20 10 0 10 20 30 40 50 60 70 80 90 100 110 120 130 140

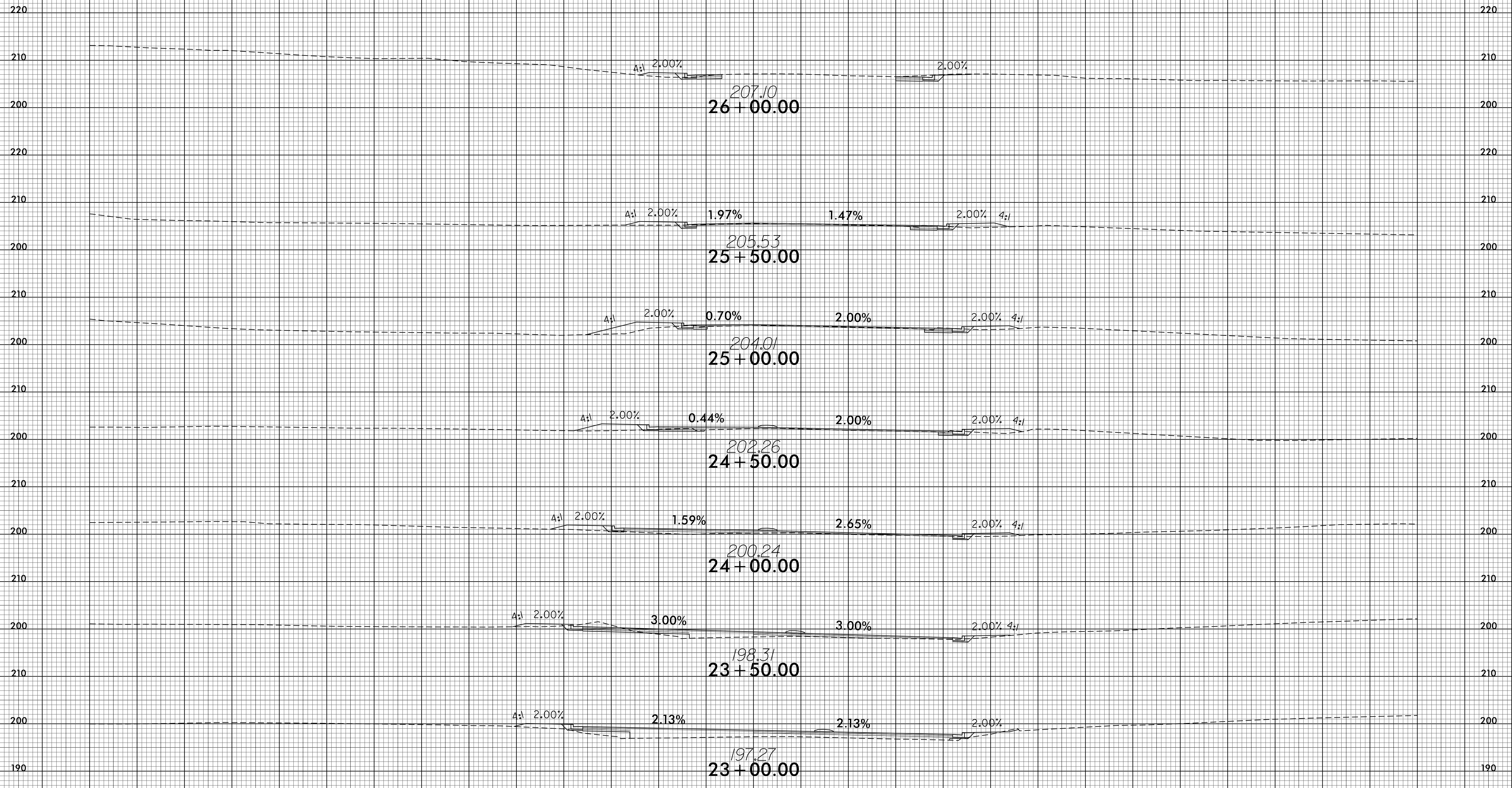

-Y5-

140 130 120 110 100 90 80 70 60 50 40 30 20 10 0 10 20 30 40 50 60 70 80 90 100 110 120 130 140

I:\JUN-2010\46
R:\PROJECTS\X\CA\4405A_rdu_xpl.dgn
8/23/99

8/23/99

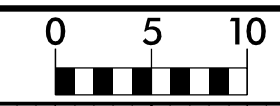

PROJ. REFERENCE NO.
U-4405A

SHEET NO.
X-39

140 130 120 110 100 90 80 70 60 50 40 30 20 10 0 10 20 30 40 50 60 70 80 90 100 110 120 130 140

215 215

210 210

212.78
28 + 00.00

215 215

210 210

211.70
27 + 50.00

215 215

210 210

210.24
27 + 00.00

210 210

205 205

208.56
26 + 50.00

200 200

-Y5-

140 130 120 110 100 90 80 70 60 50 40 30 20 10 0 10 20 30 40 50 60 70 80 90 100 110 120 130 140

I:\JUN-2021\0448
R:\PROJECTS\X\CA\4405A_rdu_xpl.dgn
\$\$\$\$USER\$\$\$\$

8/23/99

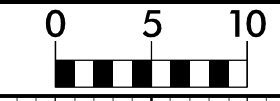

PROJ. REFERENCE NO.
U-4405A

SHEET NO.
X-40

140 130 120 110 100 90 80 70 60 50 40 30 20 10 0 10 20 30 40 50 60 70 80 90 100 110 120 130 140

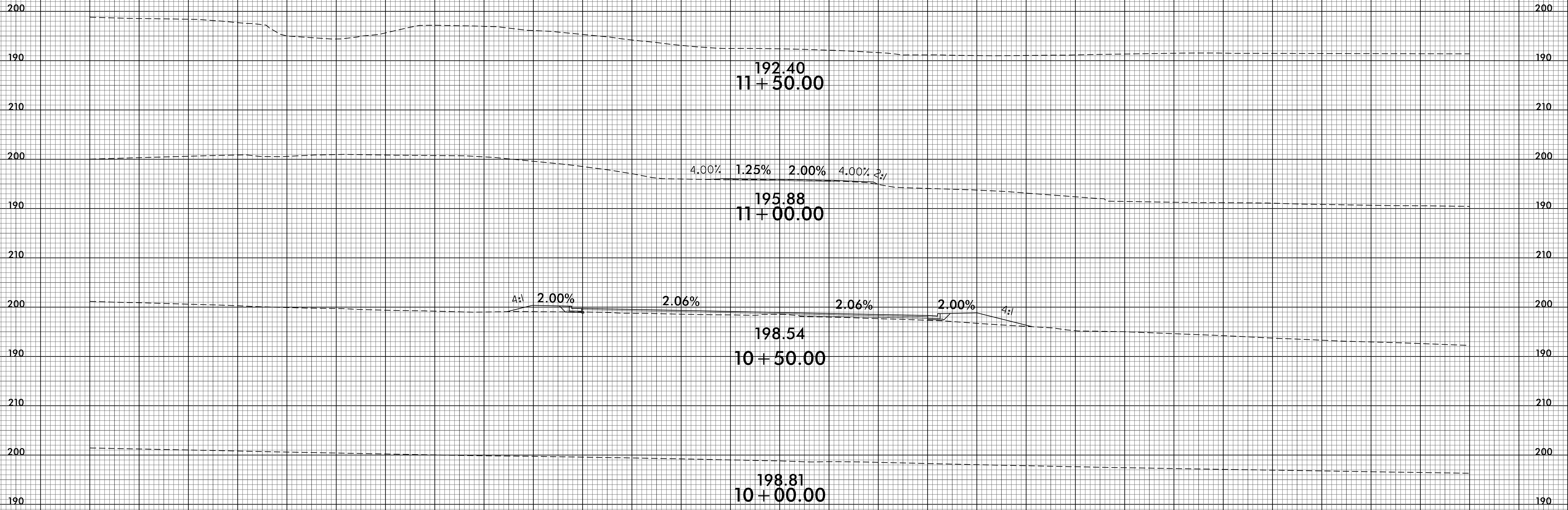

140 130 120 110 100 90 80 70 60 50 40 30 20 10 0 10 20 30 40 50 60 70 80 90 100 110 120 130 140

-Y6-

II-JUN-2021 10:48
R:\PROJECTS\X\4405A_r.dwg
\$\$\$\$

8/23/99

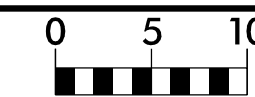

PROJ. REFERENCE NO.
U-4405A

SHEET NO.
X-41

140 130 120 110 100 90 80 70 60 50 40 30 20 10 0 10 20 30 40 50 60 70 80 90 100 110 120 130 140

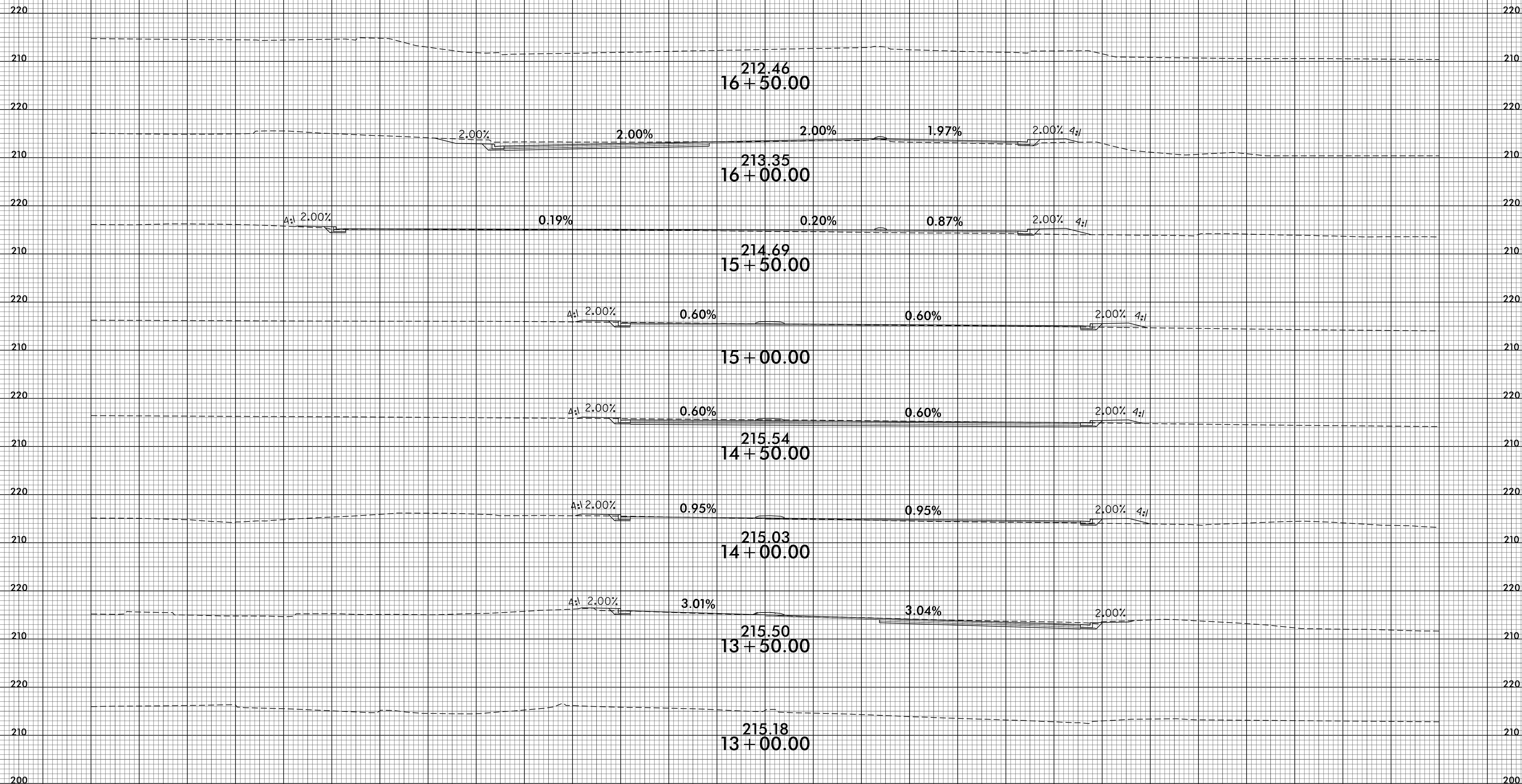

-Y7-

I:\JUN-2021\0449
R:\PROJECTS\X\CA\4405A_rdu_xpl.dgn
\$\$\$\$\$

140 130 120 110 100 90 80 70 60 50 40 30 20 10 0 10 20 30 40 50 60 70 80 90 100 110 120 130 140

8/23/99

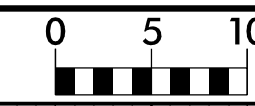

PROJ. REFERENCE NO.
U-4405A

SHEET NO.
X-42

150 140 130 120 110 100 90 80 70 60 50 40 30 20 10 0 10 20 30 40 50 60 70 80 90 100 110 120 130 140 150

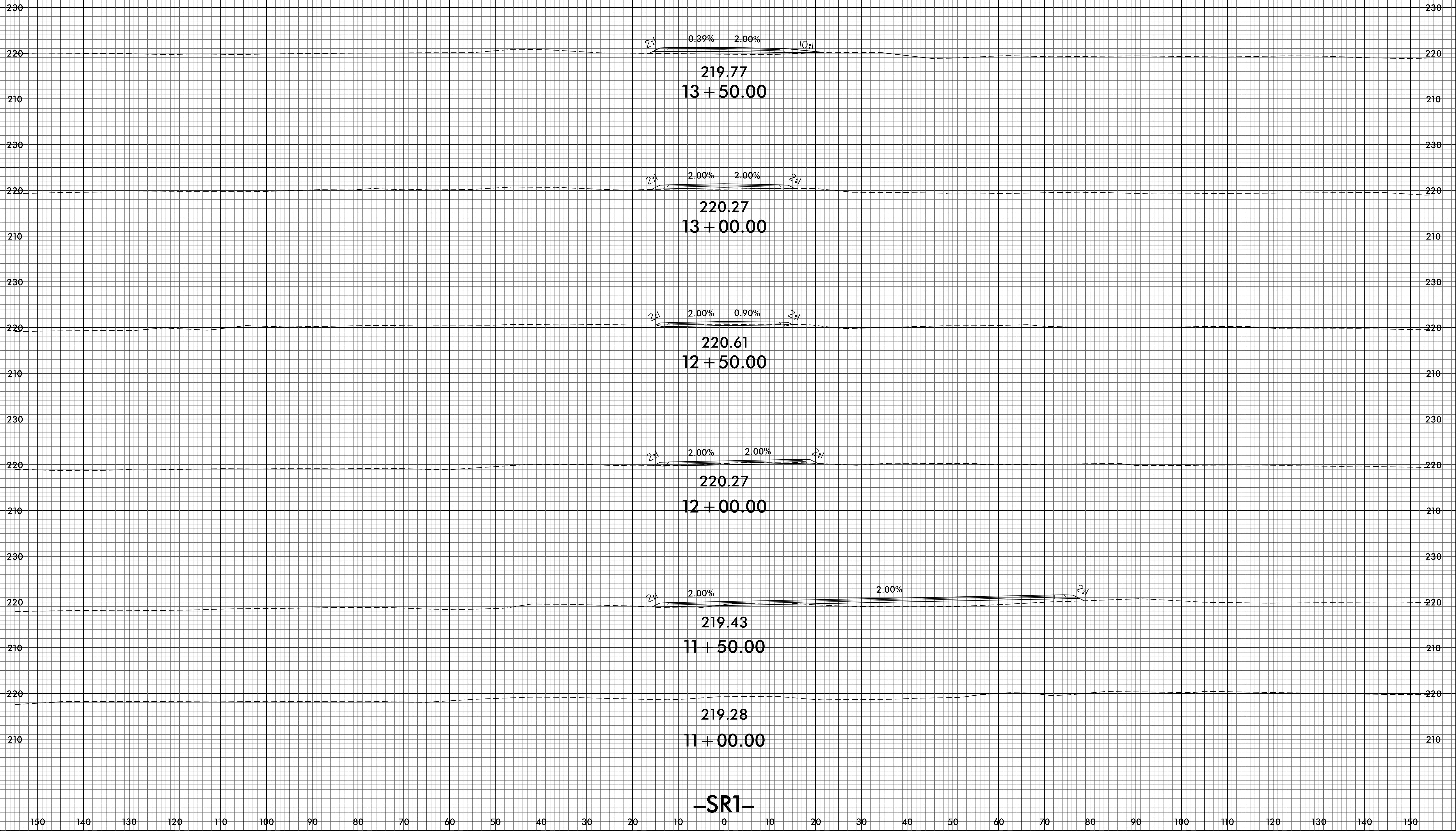

-SR1-

I:\JUN-2021\0452
R:\G0569\X\CA\4405A_rdu_xpl.dgn
#30569\X\CA\4405A_rdu_xpl.dgn

8/23/99

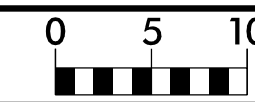

PROJ. REFERENCE NO.
U-4405A

SHEET NO.
X-43

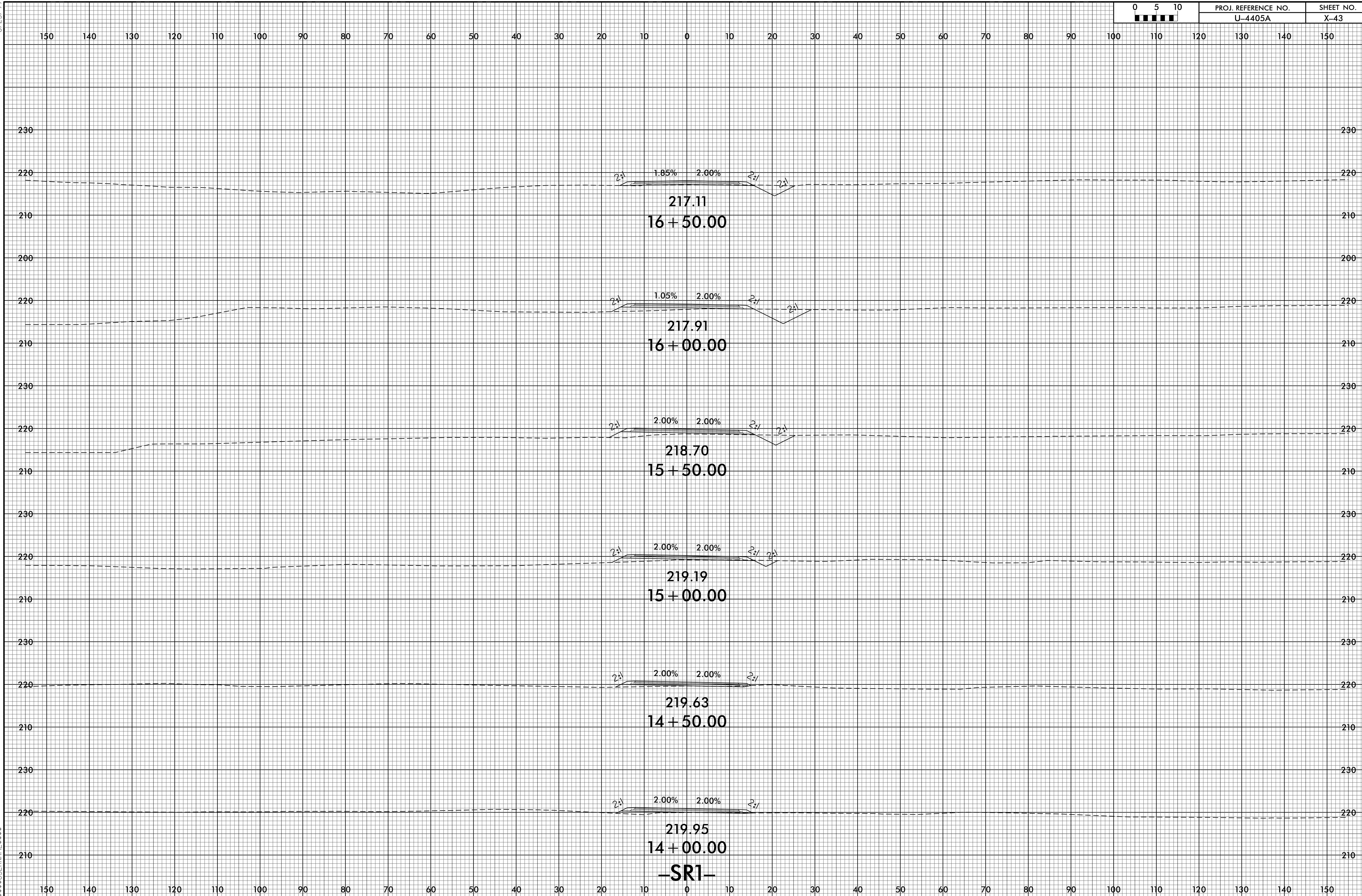

-SR1-

I:\JUN-2010\53
R:\G0599\X\CA\4405A_rdu_xpl.dgn
#30599\X\CA\4405A

150 140 130 120 110 100 90 80 70 60 50 40 30 20 10 0 10 20 30 40 50 60 70 80 90 100 110 120 130 140 150

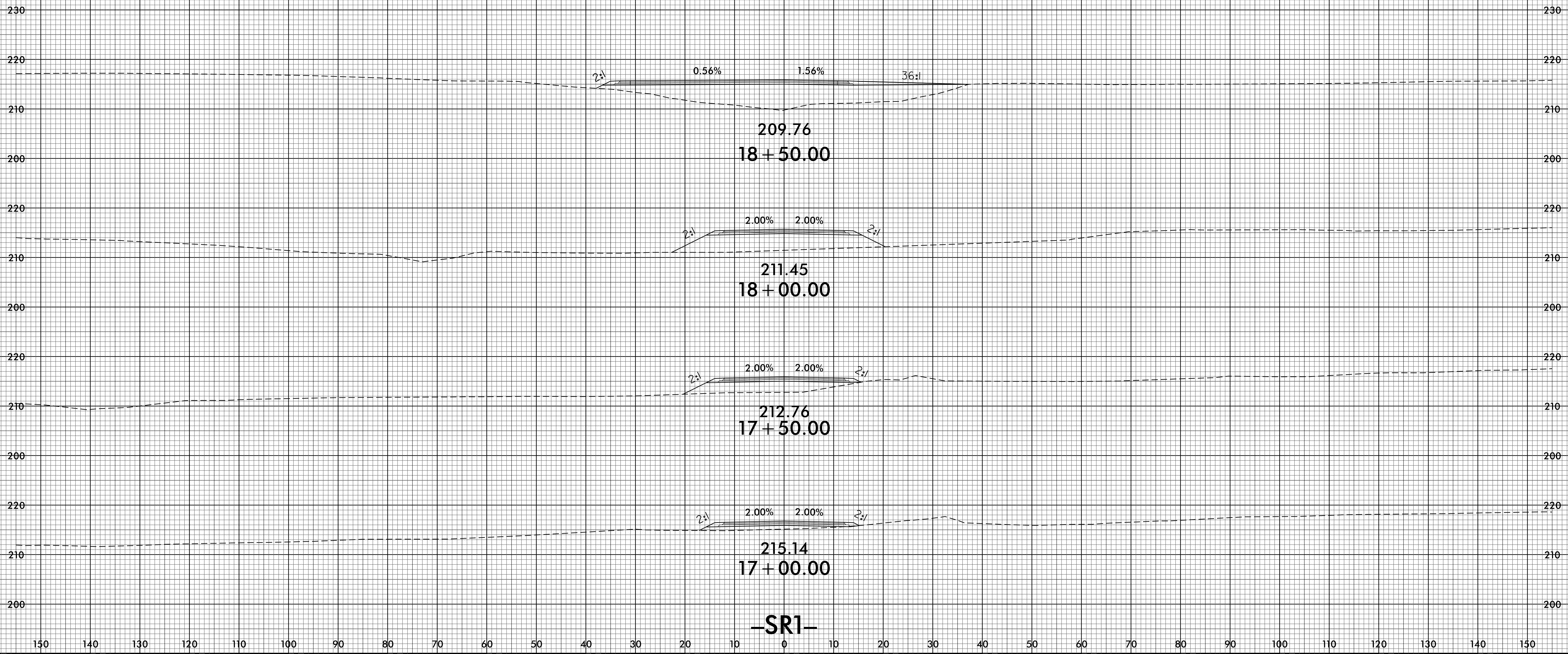

8/23/99



PROJ. REFERENCE NO.
U-4405A

SHEET NO.
X-45

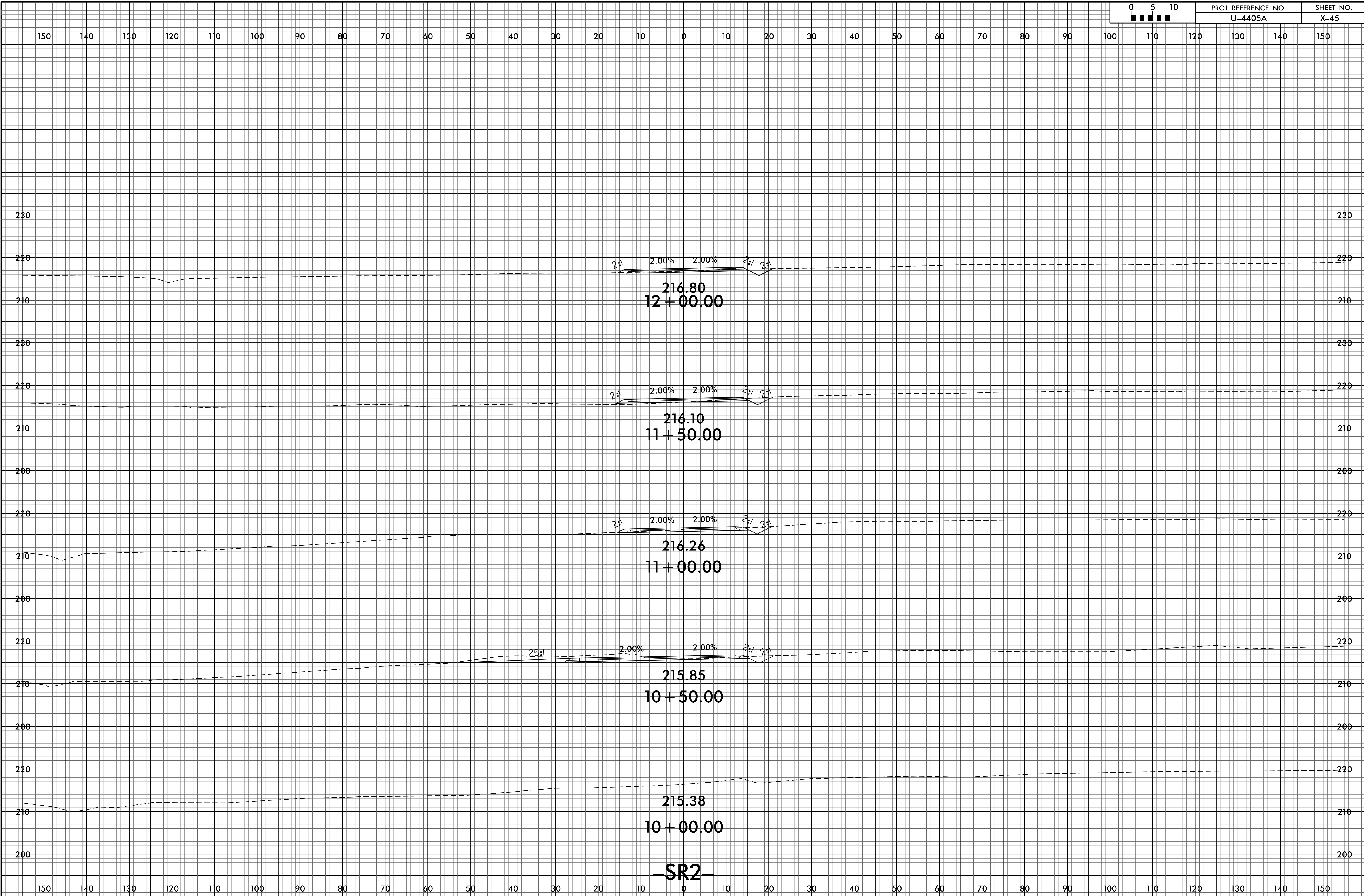

-SR2-

I:\JUN-2021\0455
R:\G0509\X\CA\4405A_rdu_xpl.dgn
P:\USER\N\16888

150 140 130 120 110 100 90 80 70 60 50 40 30 20 10 0 10 20 30 40 50 60 70 80 90 100 110 120 130 140 150

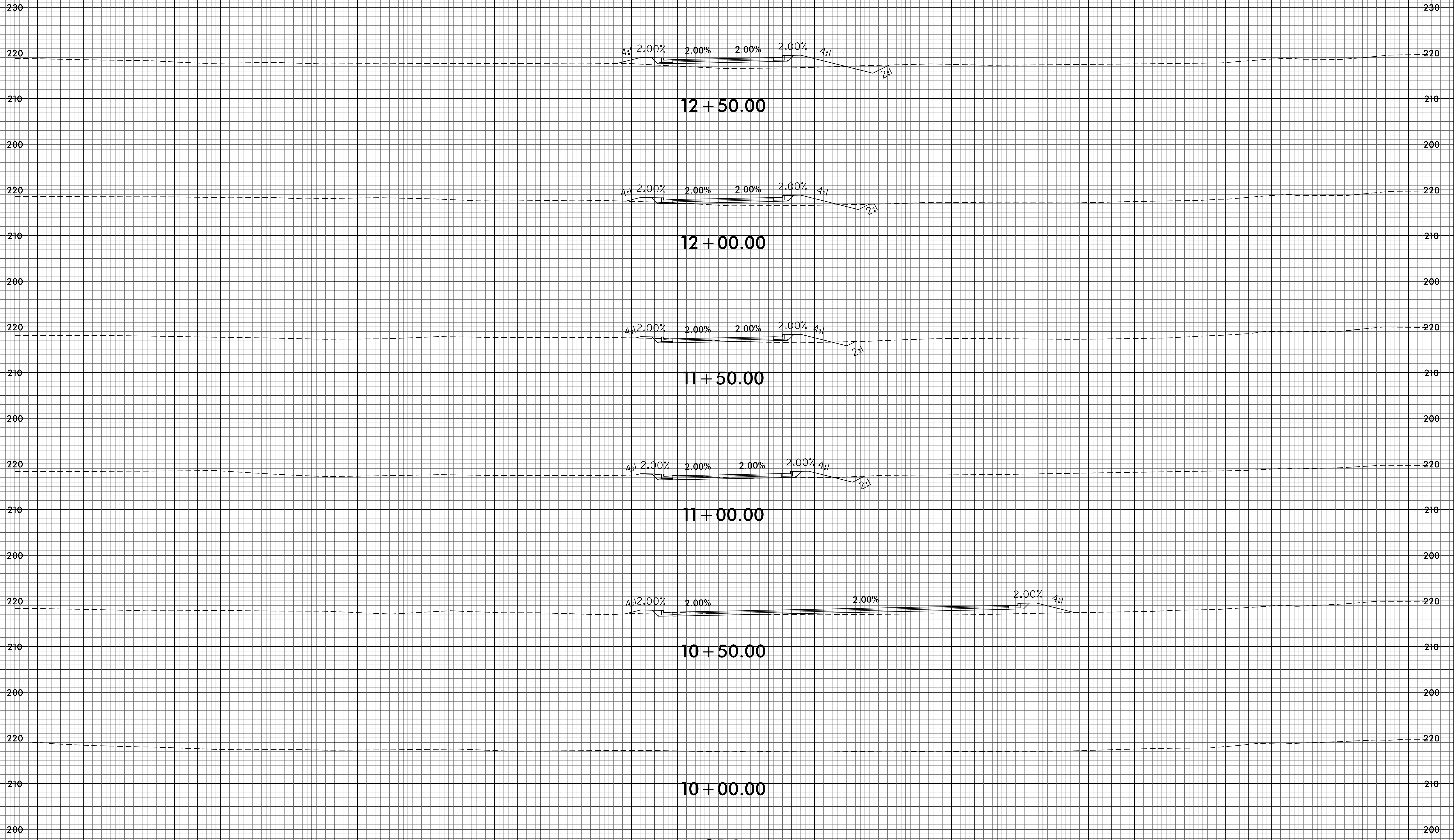

-SR3-

150 140 130 120 110 100 90 80 70 60 50 40 30 20 10 0 10 20 30 40 50 60 70 80 90 100 110 120 130 140 150

150 140 130 120 110 100 90 80 70 60 50 40 30 20 10 0 10 20 30 40 50 60 70 80 90 100 110 120 130 140 150

220 220

13 + 50.00

230 230

4% 2.00% 2.00% 2.00% 4%

220 220

13 + 00.00

210 210

-SR3-

200 200

150 140 130 120 110 100 90 80 70 60 50 40 30 20 10 0 10 20 30 40 50 60 70 80 90 100 110 120 130 140 150

8/23/99

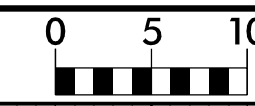

PROJ. REFERENCE NO.
U-4405A

SHEET NO.
X-48

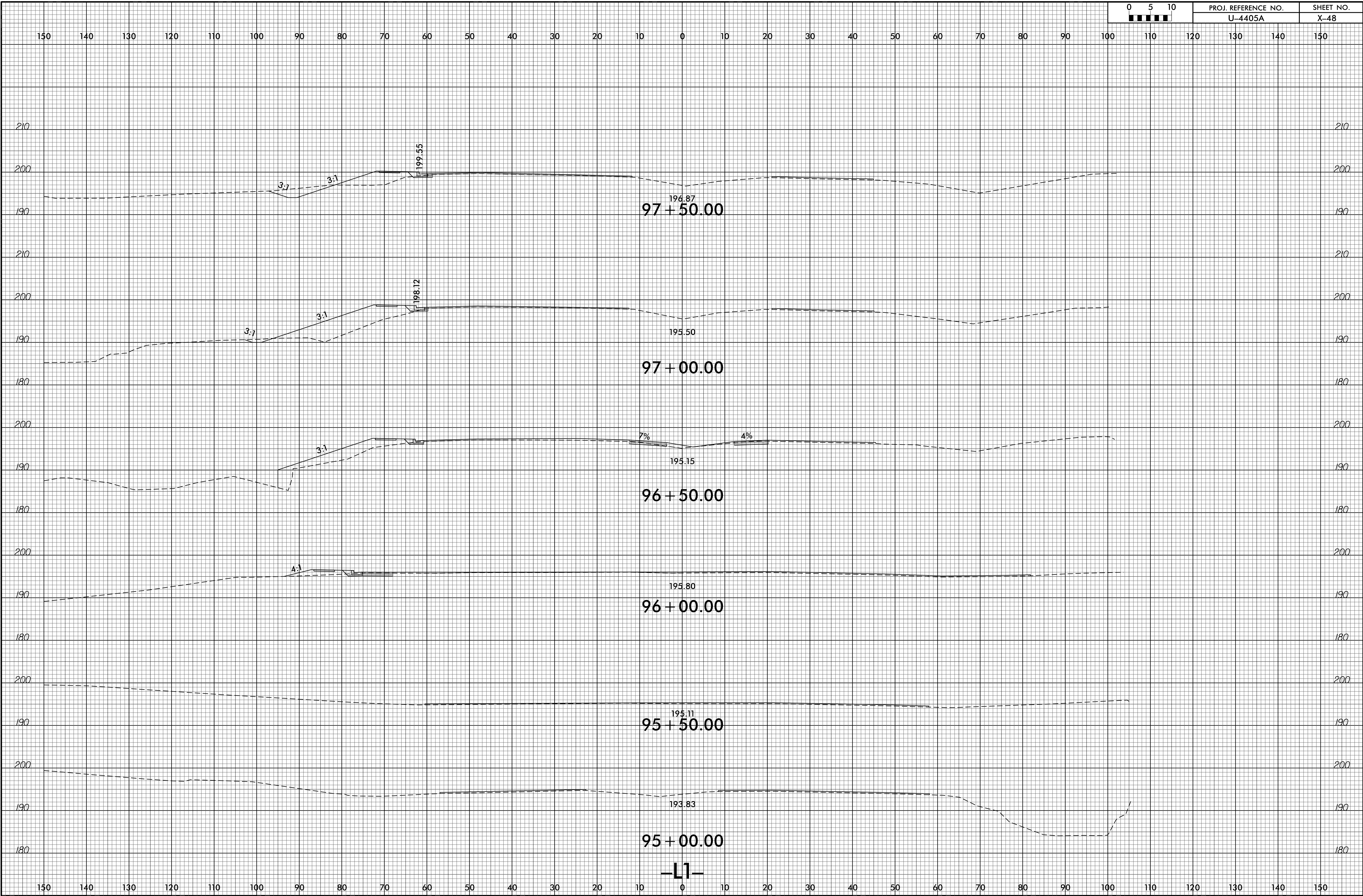

-L1-

I:\JUN-2021\1137
R:\CADD\X\4405A\rd\1.dgn
#305E\1137

8/23/99

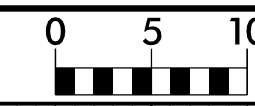

PROJ. REFERENCE NO.
U-4405A

SHEET NO.
X-49

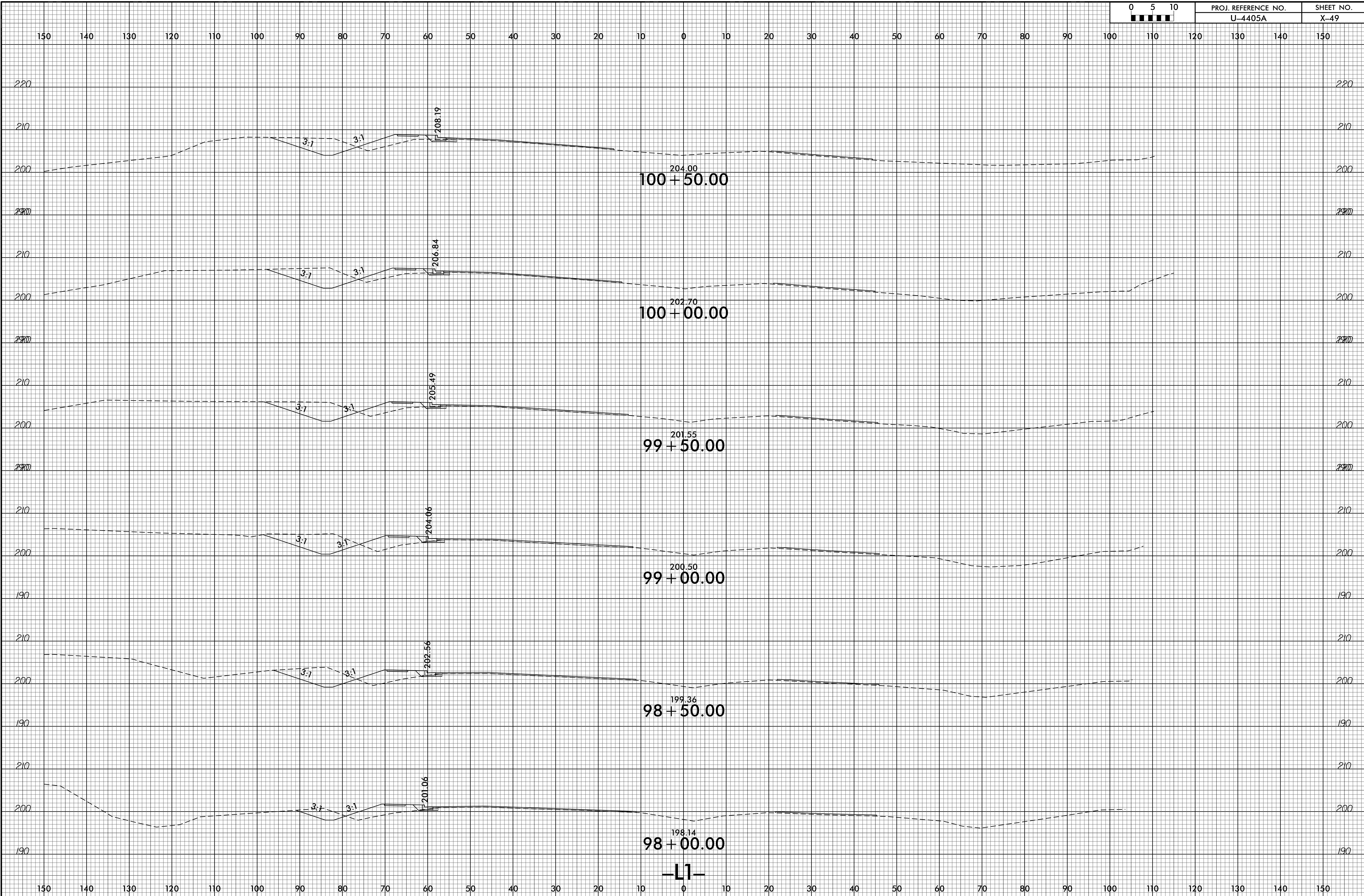

I:\JUN-2021\1138
R:\CADD\PROJECTS\X-49\4405A_rdu_xpl.dgn
8/23/99

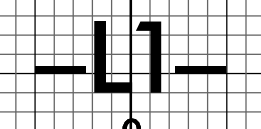

8/23/99

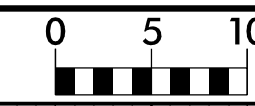

PROJ. REFERENCE NO.
U-4405A

SHEET NO.
X-50

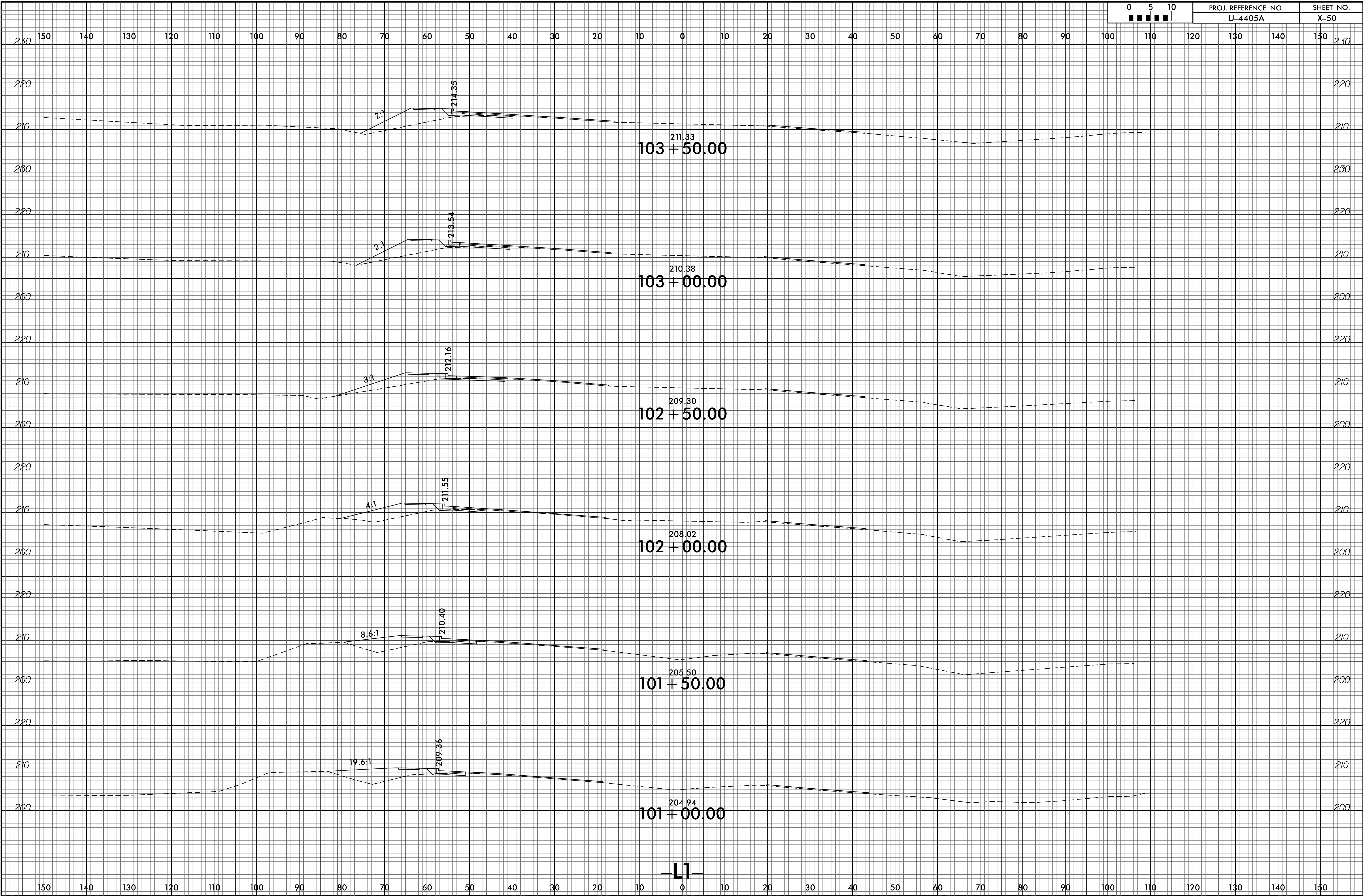

-L1-

II:JUN-2021 15:05
R:\PROJECTS\X\CA\4405A_rdu_xpl.dgn
\$\$\$\$\$

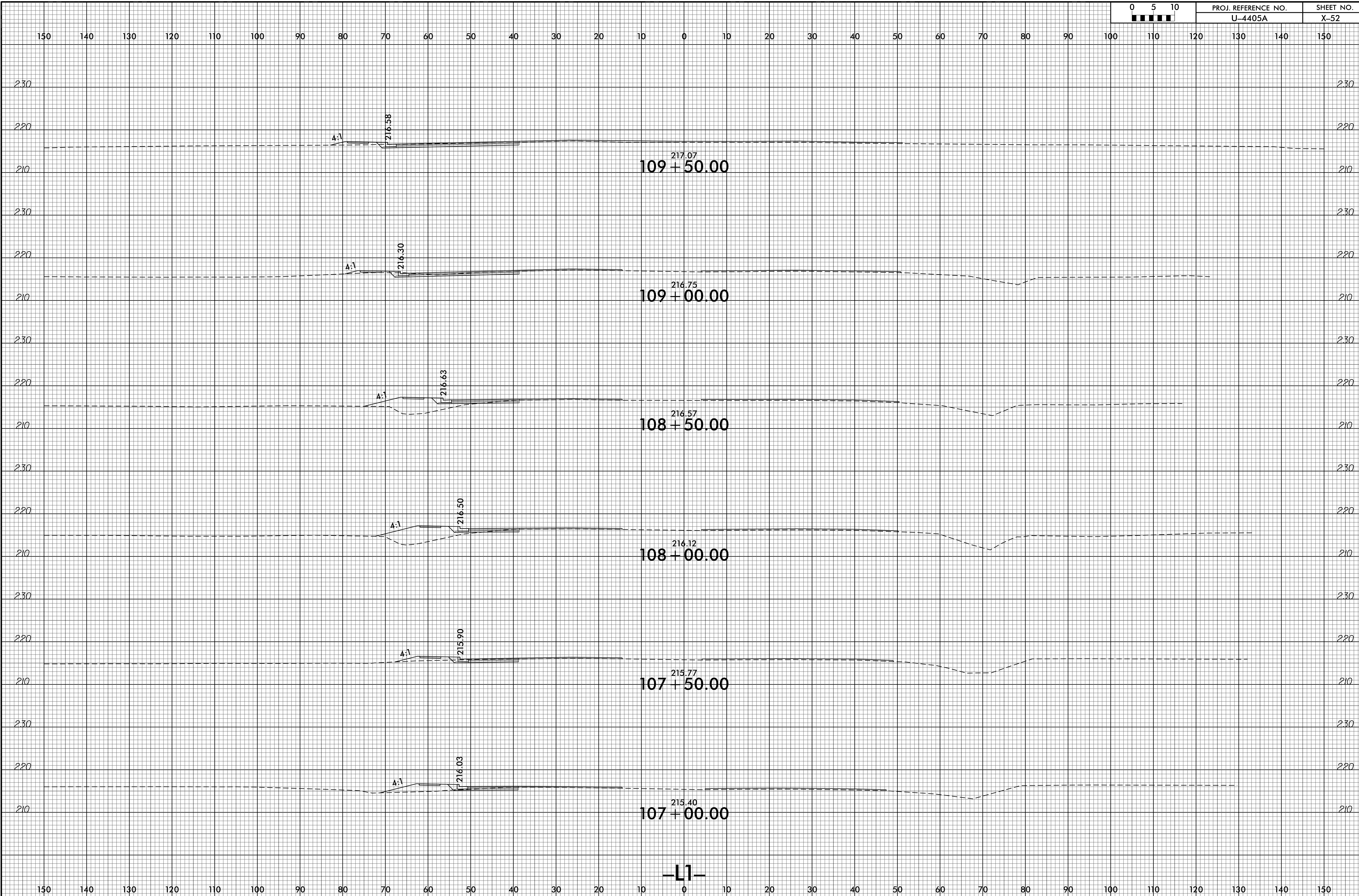

8/23/99

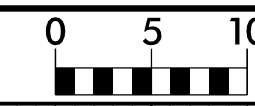

PROJ. REFERENCE NO.
U-4405A

SHEET NO.
X-53

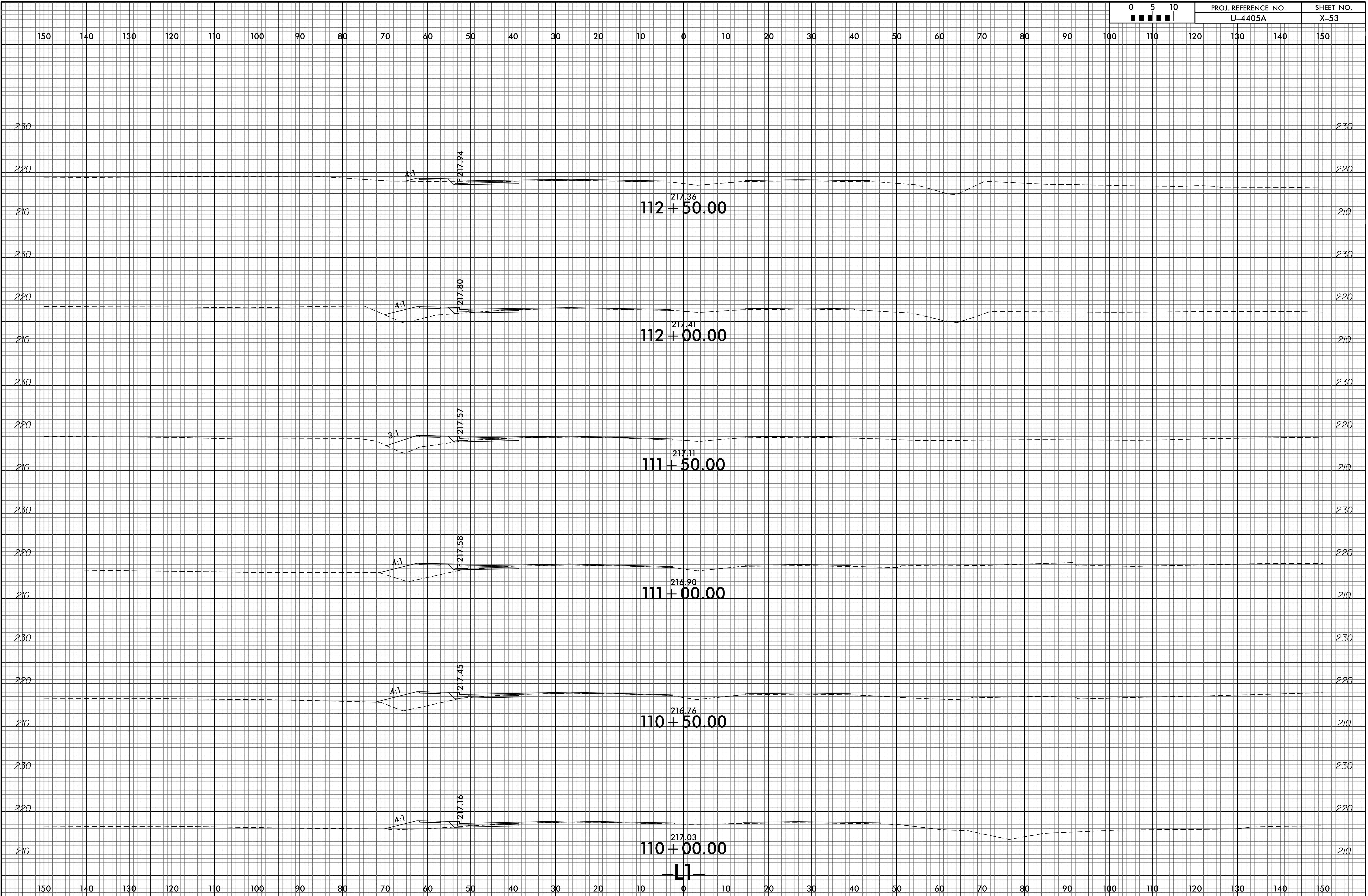

I:\JUN-2001\5413
R:\CADD\X\CA\4405A_rdu_xpl.dgn
#305E\110\1E\$3\$

150 140 130 120 110 100 90 80 70 60 50 40 30 20 10 0 10 20 30 40 50 60 70 80 90 100 110 120 130 140 150

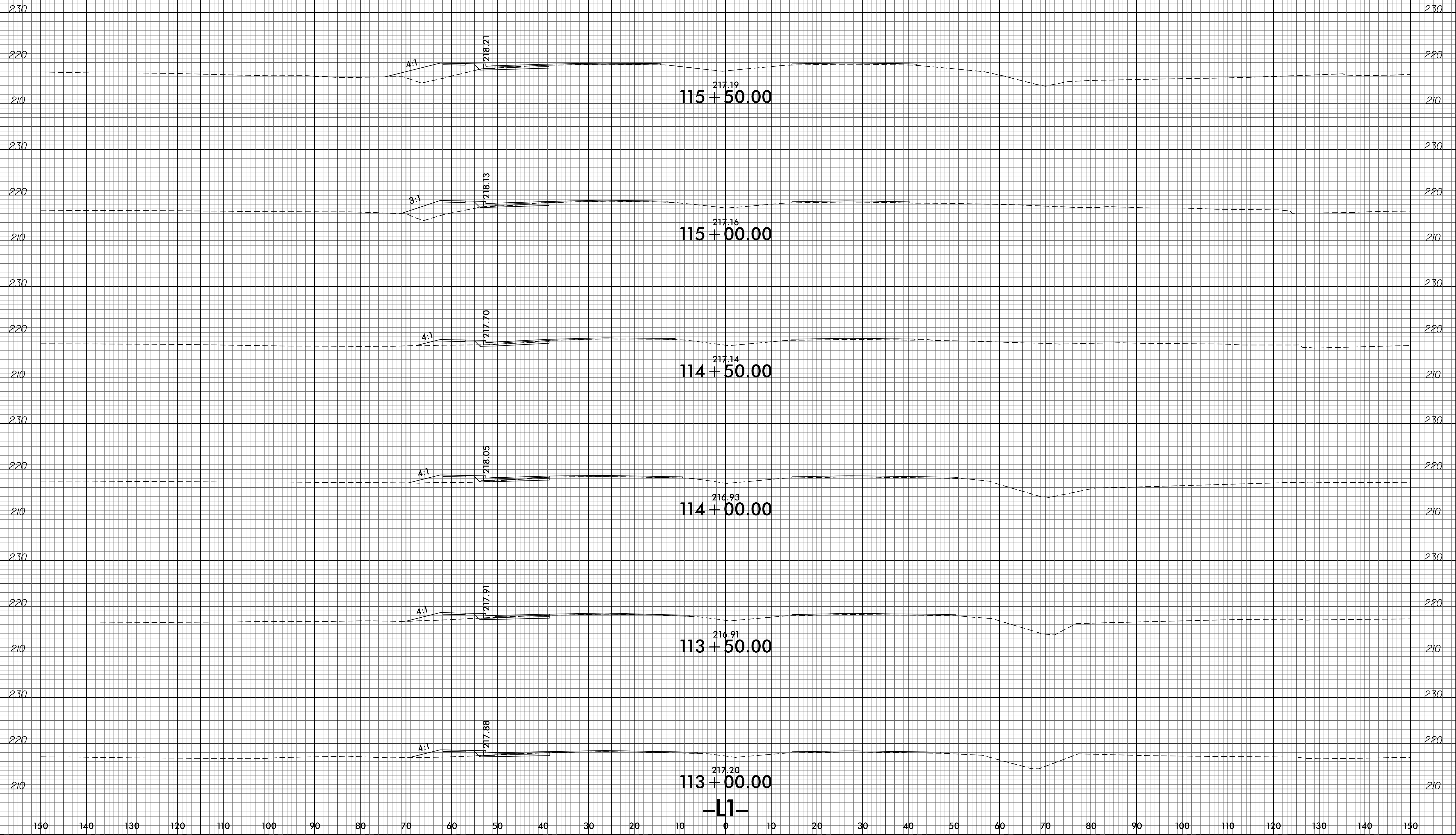

-L1-