

STATE OF NORTH CAROLINA
DEPARTMENT OF TRANSPORTATION
RALEIGH, N.C.

PROPOSAL

INCLUDES ADDENDUM No.1 DATED 10-29-2021

DATE AND TIME OF BID OPENING: **NOVEMBER 16, 2021 AT 2:00 PM**

CONTRACT ID C204404
WBS 39049.3.2

FEDERAL-AID NO. STPDA-0401(300)
COUNTY CUMBERLAND
T.I.P. NO. U-4405A
MILES 2.102
ROUTE NO. US 401
LOCATION US-401 FROM OLD RAEFORD RD TO EAST OF NC-162 (BUNCE RD).

TYPE OF WORK GRADING, DRAINAGE, PAVING, SIGNALS, AND STRUCTURE.

NOTICE:

ALL BIDDERS SHALL COMPLY WITH ALL APPLICABLE LAWS REGULATING THE PRACTICE OF GENERAL CONTRACTING AS CONTAINED IN CHAPTER 87 OF THE GENERAL STATUTES OF NORTH CAROLINA WHICH REQUIRES THE BIDDER TO BE LICENSED BY THE N.C. LICENSING BOARD FOR CONTRACTORS WHEN BIDDING ON ANY NON-FEDERAL AID PROJECT WHERE THE BID IS \$30,000 OR MORE, EXCEPT FOR CERTAIN SPECIALTY WORK AS DETERMINED BY THE LICENSING BOARD. BIDDERS SHALL ALSO COMPLY WITH ALL OTHER APPLICABLE LAWS REGULATING THE PRACTICES OF ELECTRICAL, PLUMBING, HEATING AND AIR CONDITIONING AND REFRIGERATION CONTRACTING AS CONTAINED IN CHAPTER 87 OF THE GENERAL STATUTES OF NORTH CAROLINA. NOTWITHSTANDING THESE LIMITATIONS ON BIDDING, THE BIDDER WHO IS AWARDED ANY FEDERAL - AID FUNDED PROJECT SHALL COMPLY WITH CHAPTER 87 OF THE GENERAL STATUTES OF NORTH CAROLINA FOR LICENSING REQUIREMENTS WITHIN 60 CALENDAR DAYS OF BID OPENING.

BIDS WILL BE RECEIVED AS SHOWN BELOW:

THIS IS A ROADWAY & STRUCTURE PROPOSAL

5% BID BOND OR BID DEPOSIT REQUIRED

**PROPOSAL FOR THE CONSTRUCTION OF
CONTRACT No. C204404 IN CUMBERLAND COUNTY, NORTH CAROLINA**

Date _____ 20 _____

**DEPARTMENT OF TRANSPORTATION,
RALEIGH, NORTH CAROLINA**

The Bidder has carefully examined the location of the proposed work to be known as Contract No. **C204404** has carefully examined the plans and specifications, which are acknowledged to be part of the proposal, the special provisions, the proposal, the form of contract, and the forms of contract payment bond and contract performance bond; and thoroughly understands the stipulations, requirements and provisions. The undersigned bidder agrees to bound upon his execution of the bid and subsequent award to him by the Board of Transportation in accordance with this proposal to provide the necessary contract payment bond and contract performance bond within fourteen days after the written notice of award is received by him. The undersigned Bidder further agrees to provide all necessary machinery, tools, labor, and other means of construction; and to do all the work and to furnish all materials, except as otherwise noted, necessary to perform and complete the said contract in accordance with *the 2018 Standard Specifications for Roads and Structures* by the dates(s) specified in the Project Special Provisions and in accordance with the requirements of the Engineer, and at the unit or lump sum prices, as the case may be, for the various items given on the sheets contained herein.

The Bidder shall provide and furnish all the materials, machinery, implements, appliances and tools, and perform the work and required labor to construct and complete State Highway Contract No. **C204404** in **Cumberland County**, for the unit or lump sum prices, as the case may be, bid by the Bidder in his bid and according to the proposal, plans, and specifications prepared by said Department, which proposal, plans, and specifications show the details covering this project, and hereby become a part of this contract.

The published volume entitled *North Carolina Department of Transportation, Raleigh, Standard Specifications for Roads and Structures, January 2018* with all amendments and supplements thereto, is by reference incorporated into and made a part of this contract; that, except as herein modified, all the construction and work included in this contract is to be done in accordance with the specifications contained in said volume, and amendments and supplements thereto, under the direction of the Engineer.

If the proposal is accepted and the award is made, the contract is valid only when signed either by the Contract Officer or such other person as may be designated by the Secretary to sign for the Department of Transportation. The conditions and provisions herein cannot be changed except over the signature of the said Contract Officer.

The quantities shown in the itemized proposal for the project are considered to be approximate only and are given as the basis for comparison of bids. The Department of Transportation may increase or decrease the quantity of any item or portion of the work as may be deemed necessary or expedient.

An increase or decrease in the quantity of an item will not be regarded as sufficient ground for an increase or decrease in the unit prices, nor in the time allowed for the completion of the work, except as provided for the contract.

Accompanying this bid is a bid bond secured by a corporate surety, or certified check payable to the order of the Department of Transportation, for five percent of the total bid price, which deposit is to be forfeited as liquidated damages in case this bid is accepted and the Bidder shall fail to provide the required payment and performance bonds with the Department of Transportation, under the condition of this proposal, within 14 calendar days after the written notice of award is received by him, as provided in the *Standard Specifications*; otherwise said deposit will be returned to the Bidder.



State Contract Officer

DocuSigned by:

Ronald E. Davenport, Jr.

F81B6038A47A442... 10/29/2021

TABLE OF CONTENTS

**COVER SHEET
PROPOSAL SHEET**

PROJECT SPECIAL PROVISIONS

CONTRACT TIME AND LIQUIDATED DAMAGES: G-1
 INTERMEDIATE CONTRACT TIME NUMBER 1 AND LIQUIDATED DAMAGES: G-1
 INTERMEDIATE CONTRACT TIME NUMBER 2 AND LIQUIDATED DAMAGES: G-2
 INTERMEDIATE CONTRACT TIME NUMBER 3 AND LIQUIDATED DAMAGES: G-2
 INTERMEDIATE CONTRACT TIME NUMBER 4 AND LIQUIDATED DAMAGES: G-3
 INTERMEDIATE CONTRACT TIME NUMBER 5 AND LIQUIDATED DAMAGES: G-4
 INTERMEDIATE CONTRACT TIME NUMBER 6 AND LIQUIDATED DAMAGES: G-4
 INTERMEDIATE CONTRACT TIME NUMBER 7 AND LIQUIDATED DAMAGES: G-4
 INTERMEDIATE CONTRACT TIME NUMBER 8 AND LIQUIDATED DAMAGES: G-4
 INTERMEDIATE CONTRACT TIME NUMBER 9 AND LIQUIDATED DAMAGES: G-5
 PERMANENT VEGETATION ESTABLISHMENT:..... G-5
 MAJOR CONTRACT ITEMS: G-6
 SPECIALTY ITEMS: G-6
 FUEL PRICE ADJUSTMENT: G-6
 SCHEDULE OF ESTIMATED COMPLETION PROGRESS:..... G-7
 DISADVANTAGED BUSINESS ENTERPRISE: G-8
 CERTIFICATION FOR FEDERAL-AID CONTRACTS: G-21
 CONTRACTOR'S LICENSE REQUIREMENTS: G-22
 RESTRICTIONS ON ITS EQUIPMENT AND SERVICES:..... G-22
 USE OF UNMANNED AIRCRAFT SYSTEM (UAS): G-22
 EQUIPMENT IDLING GUIDELINES: G-23
 U.S. DEPARTMENT OF TRANSPORTATION HOTLINE: G-23
 CARGO PREFERENCE ACT: G-24
 SUBSURFACE INFORMATION:..... G-24
 MAINTENANCE OF THE PROJECT: G-24
 COOPERATION BETWEEN CONTRACTORS:..... G-25
 ELECTRONIC BIDDING:..... G-25
 TWELVE MONTH GUARANTEE: G-26
 EROSION AND SEDIMENT CONTROL/STORMWATER CERTIFICATION: G-26
 PROCEDURE FOR MONITORING BORROW PIT DISCHARGE:..... G-31
 NOTE TO CONTRACTOR (Parcel-55 Trees): G-33
 NOTE TO CONTRACTOR (Signals Communications): G-33

 ROADWAY R-1

STANDARD SPECIAL PROVISIONS

AVAILABILITY FUNDS – TERMINATION OF CONTRACTS SSP-1
 NCDOT GENERAL SEED SPECIFICATION FOR SEED QUALITY SSP-2
 ERRATA SSP-5
 PLANT AND PEST QUARANTINES SSP-6
 TITLE VI AND NONDISCRIMINATION SSP-7
 MINORITY AND FEMALE EMPLOYMENT REQUIREMENTS SSP-15

REQUIRED CONTRACT PROVISIONS FEDERAL-AID CONST. CONTRACTS SSP-18
 ON-THE-JOB TRAINING SSP-27
 MINIMUM WAGES SSP-30

UNIT PROJECT SPECIAL PROVISIONS

GEOTECHNICALGT-0.1
 GEOENVIRONMENTAL GV-1
 TRAFFIC CONTROL TC-1
 UTILITY CONSTRUCTION UC-1
 UTILITY BY OTHERSUBO-1
 EROSION CONTROLEC-1
 TRAFFIC SIGNALS TS-1
 STRUCTURE / CULVERTS..... ST-1

PERMITSP-1

PROPOSAL ITEM SHEET

ITEM SHEET(S) (TAN SHEETS)

PROJECT SPECIAL PROVISIONS**GENERAL****CONTRACT TIME AND LIQUIDATED DAMAGES:**

(8-15-00) (Rev. 12-18-07)

108

SP1 G07 A

The date of availability for this contract is **February 1, 2022**, except that work in jurisdictional waters and wetlands shall not begin until a meeting between the DOT, Regulatory Agencies, and the Contractor is held as stipulated in the permits contained elsewhere in this proposal. This delay in availability has been considered in determining the contract time for this project.

The completion date for this contract is **April 13, 2025**.

Except where otherwise provided by the contract, observation periods required by the contract will not be a part of the work to be completed by the completion date and/or intermediate contract times stated in the contract. The acceptable completion of the observation periods that extend beyond the final completion date shall be a part of the work covered by the performance and payment bonds.

The liquidated damages for this contract are **Two Hundred Dollars (\$ 200.00)** per calendar day. These liquidated damages will not be cumulative with any liquidated damages which may become chargeable under Intermediate Contract Time Number 1.

INTERMEDIATE CONTRACT TIME NUMBER 1 AND LIQUIDATED DAMAGES:

(7-1-95) (Rev. 2-21-12)

108

SP1 G13 A

Except for that work required under the Project Special Provisions entitled *Planting, Reforestation* and/or *Permanent Vegetation Establishment*, included elsewhere in this proposal, the Contractor will be required to complete all work included in this contract and shall place and maintain traffic on same.

The date of availability for this intermediate contract time is **February 1, 2022**.

The completion date for this intermediate contract time is **October 15, 2024**.

The liquidated damages for this intermediate contract time are **Three Thousand Dollars (\$ 3,000.00)** per calendar day.

Upon apparent completion of all the work required to be completed by this intermediate date, a final inspection will be held in accordance with Article 105-17 and upon acceptance, the Department will assume responsibility for the maintenance of all work except *Planting, Reforestation* and/or *Permanent Vegetation Establishment*. The Contractor will be responsible for and shall make corrections of all damages to the completed roadway caused by his planting operations, whether occurring prior to or after placing traffic through the project.

INTERMEDIATE CONTRACT TIME NUMBER 2 AND LIQUIDATED DAMAGES:

(2-20-07)

108

SP1 G14 C

The Contractor shall complete the required work of installing, maintaining, and removing the traffic control devices for lane closures and restoring traffic to a **minimum of a four (4)-lane, two (2)-way** traffic pattern. The Contractor shall not close or narrow a lane of traffic on **South Bound US 401 (SB -L1- and -L-) and North Bound US 401 (NB -L1- and -L-) from -L1- Sta. 95+00 +/- to -L- Sta. 95+00 +/-** during the following time restrictions:

DAY AND TIME RESTRICTIONS**Monday thru Sunday****6:00 A.M. to 7:00 P.M.**

The time of availability for this intermediate contract time will be the time the Contractor begins to install traffic control devices required for the lane closures according to the time restrictions stated herein.

The completion time for this intermediate contract time will be the time the Contractor is required to complete the removal of traffic control devices required for the lane closures according to the time restrictions stated herein and restore traffic to a **minimum of a four (4)-lane, two (2)-way** traffic pattern.

The liquidated damages are **One Thousand Dollars (\$ 1,000.00)** per hour.

INTERMEDIATE CONTRACT TIME NUMBER 3 AND LIQUIDATED DAMAGES:

(2-20-07)

108

SP1 G14 C

The Contractor shall complete the required work of installing, maintaining, and removing the traffic control devices for lane closures and restoring traffic to a **minimum of a four (4)-lane, two (2)-way** traffic pattern. The Contractor shall not close or narrow **two (2)** lanes of traffic on **North Bound US 401 (NB -L-) from -L- Sta. 95+00 +/- to -L- Sta. 110+00 +/-** during the following time restrictions:

DAY AND TIME RESTRICTIONS**Monday thru Sunday****6:00 A.M. to 7:00 P.M.**

The time of availability for this intermediate contract time will be the time the Contractor begins to install traffic control devices required for the lane closures according to the time restrictions stated herein.

The completion time for this intermediate contract time will be the time the Contractor is required to complete the removal of traffic control devices required for the lane closures according to the time restrictions stated herein and restore traffic to a **minimum of a four (4)-lane, two (2)-way** traffic pattern.

The liquidated damages are **Five Hundred Dollars (\$ 500.00)** per fifteen (15) minute time period.

INTERMEDIATE CONTRACT TIME NUMBER 4 AND LIQUIDATED DAMAGES:

(2-20-07)

108

SP1 G14 B

The Contractor shall not narrow or close a lane of traffic on **-L-, -Y1-, -Y2-, -Y3-, -Y4-, -Y5-, -Y6-, -Y7-, -Y50-, -Y51-, -Y52- and -Y53-**, detain and /or alter the traffic flow on or during holiday weekends, special events, or any other time when traffic is unusually heavy, including the following schedules:

HOLIDAY AND HOLIDAY WEEKEND LANE CLOSURE RESTRICTIONS

1. For **unexpected occurrence** that creates unusually high traffic volumes, as directed by the Engineer.
2. For **New Year's Day**, between the hours of **6:00 A.M.** December 31st and **7:00 P.M.** January 2nd. If New Year's Day is on a Friday, Saturday, Sunday or Monday, then until **7:00 P.M.** the following Tuesday.
3. For **Easter**, between the hours of **6:00 A.M.** Thursday and **7:00 P.M.** Monday.
4. For **Memorial Day**, between the hours of **6:00 A.M.** Friday and **7:00 P.M.** Tuesday.
5. For **Independence Day**, between the hours of **6:00 A.M.** the day before Independence Day and **7:00 P.M.** the day after Independence Day.

If **Independence Day** is on a Friday, Saturday, Sunday, or Monday, then between the hours of **6:00 A.M.** the Thursday before Independence Day and **7:00 P.M.** the Tuesday after Independence Day.
6. For **Labor Day**, between the hours of **6:00 A.M.** Friday and **7:00 P.M.** Tuesday.
7. For **Thanksgiving**, between the hours of **6:00 A.M.** Tuesday and **7:00 P.M.** Monday.
8. For **Christmas**, between the hours of **6:00 A.M.** the Friday before the week of Christmas Day and **7:00 P.M.** the following Tuesday after the week of Christmas Day.

The time of availability for this intermediate contract work shall be the time the Contractor begins to install all traffic control devices for lane closures according to the time restrictions listed herein.

The completion time for this intermediate contract work shall be the time the Contractor is required to complete the removal of all traffic control devices for lane closures according to the time restrictions stated herein and place traffic in the existing traffic pattern.

The liquidated damages are **One Thousand Dollars (\$ 1,000.00)** per hour.

INTERMEDIATE CONTRACT TIME NUMBER 5 AND LIQUIDATED DAMAGES:

(2-20-07) (Rev. 6-18-13)

108

SP1 G14 H

The Contractor shall complete the work required of **Phase I, Step #2B** and **Phase II, Step #1B** as shown on Sheet **TMP-3** and shall place and maintain traffic on same.

The date of availability for **each individual** intermediate contract time **will be the day after the end of the Cumberland County School Year.**

The completion date for **each individual** intermediate contract time is the date **that is the day before the beginning of the following Cumberland County School Year.**

For each individual intermediate contract time, the liquidated damages are **Five Hundred Dollars (\$ 500.00)** per calendar day.

INTERMEDIATE CONTRACT TIME NUMBER ICT 6 AND LIQUIDATED DAMAGES

(2-20-07)

SP1 G14 G

The Contractor shall complete the work required of **Phase I, Step #2C** as shown on Sheet **TMP-3** and shall place and maintain traffic on same.

The time of availability for this intermediate contract time **will be the Friday at 9:00 P.M.** that the Contractor elects to begin the work.

The completion time for this intermediate contract time **will be the following Monday at 5:00 A.M.** after the time of availability.

The liquidated damages are **Two Thousand Dollars (\$ 2,000.00)** per hour.

INTERMEDIATE CONTRACT TIME NUMBER ICT 7 AND LIQUIDATED DAMAGES

(2-20-07)

SP1 G14 G

The Contractor shall complete the work required of **Phase I, Step #2D** as shown on Sheet **TMP-3** and shall place and maintain traffic on same.

The time of availability for this intermediate contract time **will be the Friday at 9:00 P.M.** that the Contractor elects to begin the work.

The completion time for this intermediate contract time **will be the following Monday at 5:00 A.M.** after the time of availability.

The liquidated damages are **Two Thousand Dollars (\$ 2,000.00)** per hour.

INTERMEDIATE CONTRACT TIME NUMBER ICT 8 AND LIQUIDATED DAMAGES

(2-20-07)

SP1 G14 G

The Contractor shall complete the work required of **Phase II, Step #1C** as shown on Sheet **TMP-3** and shall place and maintain traffic on same.

The time of availability for this intermediate contract time **will be the Friday at 9:00 P.M.** that the Contractor elects to begin the work.

The completion time for this intermediate contract time **will be the following Monday at 5:00 A.M.** after the time of availability.

The liquidated damages are **Two Thousand Dollars (\$ 2,000.00)** per hour.

INTERMEDIATE CONTRACT TIME NUMBER ICT 9 AND LIQUIDATED DAMAGES

(2-20-07)

SP1 G14 G

The Contractor shall complete the work required of **Phase II, Step #1D** as shown on Sheet **TMP-3** and shall place and maintain traffic on same.

The time of availability for this intermediate contract time **will be the Friday at 9:00 P.M.** that the Contractor elects to begin the work.

The completion time for this intermediate contract time **will be the following Monday at 5:00 A.M.** after the time of availability.

The liquidated damages are **Two Thousand Dollars (\$ 2,000.00)** per hour.

PERMANENT VEGETATION ESTABLISHMENT:

(2-16-12) (Rev. 10-15-13)

104

SP1 G16

Establish a permanent stand of the vegetation mixture shown in the contract. During the period between initial vegetation planting and final project acceptance, perform all work necessary to establish permanent vegetation on all erodible areas within the project limits, as well as, in borrow and waste pits. This work shall include erosion control device maintenance and installation, repair seeding and mulching, supplemental seeding and mulching, mowing, and fertilizer topdressing, as directed. All work shall be performed in accordance with the applicable section of the *2018 Standard Specifications*. All work required for initial vegetation planting shall be performed as a part of the work necessary for the completion and acceptance of the Intermediate Contract Time (ICT). Between the time of ICT and Final Project acceptance, or otherwise referred to as the vegetation establishment period, the Department will be responsible for preparing the required National Pollutant Discharge Elimination System (NPDES) inspection records.

Once the Engineer has determined that the permanent vegetation establishment requirement has been achieved at an 80% vegetation density (the amount of established vegetation per given area to stabilize the soil) and no erodible areas exist within the project limits, the Contractor will be notified to remove the remaining erosion control devices that are no longer needed. The Contractor will be responsible for, and shall correct any areas disturbed by operations performed in permanent vegetation establishment and the removal of temporary erosion control measures, whether occurring prior to or after placing traffic on the project.

Payment for *Response for Erosion Control, Seeding and Mulching, Repair Seeding, Supplemental Seeding, Mowing, Fertilizer Topdressing, Silt Excavation, and Stone for Erosion Control* will be made at contract unit prices for the affected items. Work required that is not represented by contract line items will be paid in accordance with Articles 104-7 or 104-3 of the *2018 Standard Specifications*. No additional compensation will be made for maintenance and removal of temporary erosion control items.

MAJOR CONTRACT ITEMS:

(2-19-02)

104

SP1 G28

The following listed items are the major contract items for this contract (see Article 104-5 of the *2018 Standard Specifications*):

Line #	Description
52	Asphalt Concrete Base Course, Type B25.0C
53	Asphalt Concrete Intermediate Course, Type I19.0C
55	Asphalt Concrete Surface Course, Type S9.5C
132	24" Water Line

SPECIALTY ITEMS:

(7-1-95)(Rev. 7-20-21)

108-6

SP1 G37

Items listed below will be the specialty items for this contract (see Article 108-6 of the *2018 Standard Specifications*).

Line #	Description
91-94	Guardrail
99-105	Signing
119-122, 124	Long-Life Pavement Markings
125	Permanent Pavement Markers
127-175	Utility Construction
176-209	Erosion Control
210-265	Signals/ITS System

FUEL PRICE ADJUSTMENT:

(11-15-05) (Rev. 7-20-21)

109-8

SP1 G43

Revise the *2018 Standard Specifications* as follows:

Page 1-87, Article 109-8, Fuel Price Adjustments, add the following:

The base index price for DIESEL #2 FUEL is \$ **2.1926** per gallon. Where any of the following are included as pay items in the contract, they will be eligible for fuel price adjustment.

The pay items and the fuel factor used in calculating adjustments to be made will be as follows:

Description	Units	Fuel Usage Factor Diesel
Unclassified Excavation	Gal/CY	0.29
Borrow Excavation	Gal/CY	0.29
Class IV Subgrade Stabilization	Gal/Ton	0.55
Aggregate Base Course	Gal/Ton	0.55
Sub-Ballast	Gal/Ton	0.55
Asphalt Concrete Base Course, Type _____	Gal/Ton	0.90 or 2.90
Asphalt Concrete Intermediate Course, Type _____	Gal/Ton	0.90 or 2.90
Asphalt Concrete Surface Course, Type _____	Gal/Ton	0.90 or 2.90

Open-Graded Asphalt Friction Course	Gal/Ton	0.90 or 2.90
Permeable Asphalt Drainage Course, Type _____	Gal/Ton	0.90 or 2.90
Sand Asphalt Surface Course, Type _____	Gal/Ton	0.90 or 2.90
Aggregate for Cement Treated Base Course	Gal/Ton	0.55
Portland Cement for Cement Treated Base Course	Gal/Ton	0.55
" Portland Cement Concrete Pavement	Gal/SY	0.245
Concrete Shoulders Adjacent to ___ " Pavement	Gal/SY	0.245

For the asphalt items noted in the chart as eligible for fuel adjustments, the bidder may include the *Fuel Usage Factor Adjustment Form* with their bid submission if they elect to use the fuel usage factor. The *Fuel Usage Factor Adjustment Form* is found at the following link:

<https://connect.ncdot.gov/letting/LetCentral/Fuel%20Usage%20Factor%20Adjustment%20Form.pdf>

Select either 2.90 Gal/Ton fuel factor or 0.90 Gal/Ton fuel factor for each asphalt line item on the *Fuel Usage Factor Adjustment Form*. The selected fuel factor for each asphalt item will remain in effect for the duration of the contract.

Failure to complete the *Fuel Usage Factor Adjustment Form* will result in using 2.90 gallons per ton as the Fuel Usage Factor for Diesel for the asphalt items noted above. The contractor will not be permitted to change the Fuel Usage Factor after the bids are submitted.

SCHEDULE OF ESTIMATED COMPLETION PROGRESS:

(7-15-08) (Rev. 5-13-19)

108-2

SP1 G58

The Contractor's attention is directed to the Standard Special Provision entitled *Availability of Funds Termination of Contracts* included elsewhere in this proposal. The Department of Transportation's schedule of estimated completion progress for this project as required by that Standard Special Provision is as follows:

	<u>Fiscal Year</u>	<u>Progress (% of Dollar Value)</u>
2022	(7/01/21 - 6/30/22)	21% of Total Amount Bid
2023	(7/01/22 - 6/30/23)	41% of Total Amount Bid
2024	(7/01/23 - 6/30/24)	33% of Total Amount Bid
2025	(7/01/24 - 6/30/25)	5% of Total Amount Bid

The Contractor shall also furnish his own progress schedule in accordance with Article 108-2 of the *2018 Standard Specifications*. Any acceleration of the progress as shown by the Contractor's progress schedule over the progress as shown above shall be subject to the approval of the Engineer.

DISADVANTAGED BUSINESS ENTERPRISE:

(10-16-07)(Rev. 8-17-21)

102-15(J)

SP1 G61

Description

The purpose of this Special Provision is to carry out the U.S. Department of Transportation's policy of ensuring nondiscrimination in the award and administration of contracts financed in whole or in part with Federal funds. This provision is guided by 49 CFR Part 26.

Definitions

Additional DBE Subcontractors - Any DBE submitted at the time of bid that will not be used to meet the DBE goal. No submittal of a Letter of Intent is required.

Committed DBE Subcontractor - Any DBE submitted at the time of bid that is being used to meet the DBE goal by submission of a Letter of Intent. Or any DBE used as a replacement for a previously committed DBE firm.

Contract Goal Requirement - The approved DBE participation at time of award, but not greater than the advertised contract goal.

DBE Goal - A portion of the total contract, expressed as a percentage, that is to be performed by committed DBE subcontractor(s).

Disadvantaged Business Enterprise (DBE) - A firm certified as a Disadvantaged Business Enterprise through the North Carolina Unified Certification Program.

Goal Confirmation Letter - Written documentation from the Department to the bidder confirming the Contractor's approved, committed DBE participation along with a listing of the committed DBE firms.

Manufacturer - A firm that operates or maintains a factory or establishment that produces on the premises, the materials or supplies obtained by the Contractor.

Regular Dealer - A firm that owns, operates, or maintains a store, warehouse, or other establishment in which the materials or supplies required for the performance of the contract are bought, kept in stock, and regularly sold to the public in the usual course of business. A regular dealer engages in, as its principal business and in its own name, the purchase and sale or lease of the products in question. A regular dealer in such bulk items as steel, cement, gravel, stone, and petroleum products need not keep such products in stock, if it owns and operates distribution equipment for the products. Brokers and packagers are not regarded as manufacturers or regular dealers within the meaning of this section.

Replacement / Substitution - A full or partial reduction in the amount of work subcontracted to a committed (or an approved substitute) DBE firm.

North Carolina Unified Certification Program (NCUCP) - A program that provides comprehensive services and information to applicants for DBE certification, such that an applicant is required to apply only once for a DBE certification that will be honored by all recipients of

USDOT funds in the state and not limited to the Department of Transportation only. The Certification Program is in accordance with 49 CFR Part 26.

United States Department of Transportation (USDOT) - Federal agency responsible for issuing regulations (49 CFR Part 26) and official guidance for the DBE program.

Forms and Websites Referenced in this Provision

DBE Payment Tracking System - On-line system in which the Contractor enters the payments made to DBE subcontractors who have performed work on the project.
<https://apps.dot.state.nc.us/Vendor/PaymentTracking/>

DBE-IS Subcontractor Payment Information - Form for reporting the payments made to all DBE firms working on the project. This form is for paper bid projects only.
<https://connect.ncdot.gov/business/Turnpike/Documents/Form%20DBE-IS%20Subcontractor%20Payment%20Information.pdf>

RF-1 DBE Replacement Request Form - Form for replacing a committed DBE.
<http://connect.ncdot.gov/projects/construction/Construction%20Forms/DBE%20MBE%20WBE%20Replacement%20Request%20Form.pdf>

SAF Subcontract Approval Form - Form required for approval to sublet the contract.
<http://connect.ncdot.gov/projects/construction/Construction%20Forms/Subcontract%20Approval%20Form%20Rev.%202012.zip>

JC-1 Joint Check Notification Form - Form and procedures for joint check notification. The form acts as a written joint check agreement among the parties providing full and prompt disclosure of the expected use of joint checks.
<http://connect.ncdot.gov/projects/construction/Construction%20Forms/Joint%20Check%20Notification%20Form.pdf>

Letter of Intent - Form signed by the Contractor and the DBE subcontractor, manufacturer or regular dealer that affirms that a portion of said contract is going to be performed by the signed DBE for the estimated amount (based on quantities and unit prices) listed at the time of bid.
<http://connect.ncdot.gov/letting/LetCentral/Letter%20of%20Intent%20to%20Perform%20as%20a%20Subcontractor.pdf>

Listing of DBE Subcontractors Form - Form for entering DBE subcontractors on a project that will meet this DBE goal. This form is for paper bids only.
[http://connect.ncdot.gov/municipalities/Bid%20Proposals%20for%20LGA%20Content/08%20DBE%20Subcontractors%20\(Federal\).docx](http://connect.ncdot.gov/municipalities/Bid%20Proposals%20for%20LGA%20Content/08%20DBE%20Subcontractors%20(Federal).docx)

Subcontractor Quote Comparison Sheet - Spreadsheet for showing all subcontractor quotes in the work areas where DBEs quoted on the project. This sheet is submitted with good faith effort packages.
<http://connect.ncdot.gov/business/SmallBusiness/Documents/DBE%20Subcontractor%20Quote%20Comparison%20Example.xls>

DBE Goal

The following DBE goal for participation by Disadvantaged Business Enterprises is established for this contract:

Disadvantaged Business Enterprises **10.0 %**

- (A) *If the DBE goal is more than zero*, the Contractor shall exercise all necessary and reasonable steps to ensure that DBEs participate in at least the percent of the contract as set forth above as the DBE goal.
- (B) *If the DBE goal is zero*, the Contractor shall make an effort to recruit and use DBEs during the performance of the contract. Any DBE participation obtained shall be reported to the Department.

Directory of Transportation Firms (Directory)

Real-time information is available about firms doing business with the Department and firms that are certified through NCUCP in the Directory of Transportation Firms. Only firms identified in the Directory as DBE certified shall be used to meet the DBE goal. The Directory can be found at the following link. [https:// www.ebs.nc.gov/VendorDirectory/default.html](https://www.ebs.nc.gov/VendorDirectory/default.html)

The listing of an individual firm in the directory shall not be construed as an endorsement of the firm's capability to perform certain work.

Listing of DBE Subcontractors

At the time of bid, bidders shall submit all DBE participation that they anticipate to use during the life of the contract. Only those identified to meet the DBE goal will be considered committed, even though the listing shall include both committed DBE subcontractors and additional DBE subcontractors. Additional DBE subcontractor participation submitted at the time of bid will be used toward the Department's overall race-neutral goal. Only those firms with current DBE certification at the time of bid opening will be acceptable for listing in the bidder's submittal of DBE participation. The Contractor shall indicate the following required information:

- (A) Electronic Bids

Bidders shall submit a listing of DBE participation in the appropriate section of the electronic submittal file.

- (1) Submit the names and addresses of DBE firms identified to participate in the contract. If the bidder uses the updated listing of DBE firms shown in the electronic submittal file, the bidder may use the dropdown menu to access the name and address of the DBE firm.

- (2) Submit the contract line numbers of work to be performed by each DBE firm. When no figures or firms are entered, the bidder will be considered to have no DBE participation.
- (3) The bidder shall be responsible for ensuring that the DBE is certified at the time of bid by checking the Directory of Transportation Firms. If the firm is not certified at the time of the bid-letting, that DBE's participation will not count towards achieving the DBE goal.

(B) Paper Bids

- (1) *If the DBE goal is more than zero,*
 - (a) Bidders, at the time the bid proposal is submitted, shall submit a listing of DBE participation, including the names and addresses on *Listing of DBE Subcontractors* contained elsewhere in the contract documents in order for the bid to be considered responsive. Bidders shall indicate the total dollar value of the DBE participation for the contract.
 - (b) If bidders have no DBE participation, they shall indicate this on the *Listing of DBE Subcontractors* by entering the word "None" or the number "0." This form shall be completed in its entirety. **Blank forms will not be deemed to represent zero participation.** Bids submitted that do not have DBE participation indicated on the appropriate form will not be read publicly during the opening of bids. The Department will not consider these bids for award and the proposal will be rejected.
 - (c) The bidder shall be responsible for ensuring that the DBE is certified at the time of bid by checking the Directory of Transportation Firms. If the firm is not certified at the time of the bid-letting, that DBE's participation will not count towards achieving the corresponding goal.
- (2) *If the DBE goal is zero,* entries on the *Listing of DBE Subcontractors* are not required for the zero goal, however any DBE participation that is achieved during the project shall be reported in accordance with requirements contained elsewhere in the special provision.

DBE Prime Contractor

When a certified DBE firm bids on a contract that contains a DBE goal, the DBE firm is responsible for meeting the goal or making good faith efforts to meet the goal, just like any other bidder. In most cases, a DBE bidder on a contract will meet the DBE goal by virtue of the work it performs on the contract with its own forces. However, all the work that is performed by the DBE bidder and any other DBE subcontractors will count toward the DBE goal. The DBE bidder shall list itself along with any DBE subcontractors, if any, in order to receive credit toward the DBE goal.

For example, if the DBE goal is 45% and the DBE bidder will only perform 40% of the contract work, the prime will list itself at 40%, and the additional 5% shall be obtained through additional DBE participation with DBE subcontractors or documented through a good faith effort.

DBE prime contractors shall also follow Sections A and B listed under *Listing of DBE Subcontractor* just as a non-DBE bidder would.

Written Documentation – Letter of Intent

The bidder shall submit written documentation for each DBE that will be used to meet the DBE goal of the contract, indicating the bidder's commitment to use the DBE in the contract. This documentation shall be submitted on the Department's form titled *Letter of Intent*.

The documentation shall be received in the office of the State Contractor Utilization Engineer or at DBE@ncdot.gov no later than 10:00 a.m. of the sixth calendar day following opening of bids, unless the sixth day falls on an official state holiday. In that situation, it is due in the office of the State Contractor Utilization Engineer no later than 10:00 a.m. on the next official state business day.

If the bidder fails to submit the Letter of Intent from each committed DBE to be used toward the DBE goal, or if the form is incomplete (i.e. both signatures are not present), the DBE participation will not count toward meeting the DBE goal. If the lack of this participation drops the commitment below the DBE goal, the Contractor shall submit evidence of good faith efforts, completed in its entirety, to the State Contractor Utilization Engineer or DBE@ncdot.gov no later than 10:00 a.m. on the eighth calendar day following opening of bids, unless the eighth day falls on an official state holiday. In that situation, it is due in the office of the State Contractor Utilization Engineer no later than 10:00 a.m. on the next official state business day.

Submission of Good Faith Effort

If the bidder fails to meet or exceed the DBE goal, the apparent lowest responsive bidder shall submit to the Department documentation of adequate good faith efforts made to reach the DBE goal.

A hard copy and an electronic copy of this information shall be received in the office of the State Contractor Utilization Engineer or at DBE@ncdot.gov no later than 10:00 a.m. on the sixth calendar day following opening of bids unless the sixth day falls on an official state holiday. In that situation, it is due in the office of the State Contractor Utilization Engineer no later than 10:00 a.m. on the next official state business day. If the contractor cannot send the information electronically, then one complete set and 5 copies of this information shall be received under the same time constraints above.

Note: Where the information submitted includes repetitious solicitation letters, it will be acceptable to submit a representative letter along with a distribution list of the firms that were solicited. Documentation of DBE quotations shall be a part of the good faith effort submittal. This documentation may include written subcontractor quotations, telephone log notations of verbal quotations, or other types of quotation documentation.

Consideration of Good Faith Effort for Projects with DBE Goals More Than Zero

Adequate good faith efforts mean that the bidder took all necessary and reasonable steps to achieve the goal which, by their scope, intensity, and appropriateness, could reasonably be expected to obtain sufficient DBE participation. Adequate good faith efforts also mean that the bidder actively and aggressively sought DBE participation. Mere *pro forma* efforts are not considered good faith efforts.

The Department will consider the quality, quantity, and intensity of the different kinds of efforts a bidder has made. Listed below are examples of the types of actions a bidder will take in making a good faith effort to meet the goal and are not intended to be exclusive or exhaustive, nor is it intended to be a mandatory checklist.

- (A) Soliciting through all reasonable and available means (e.g. attendance at pre-bid meetings, advertising, written notices, use of verifiable electronic means through the use of the NCDOT Directory of Transportation Firms) the interest of all certified DBEs who have the capability to perform the work of the contract. The bidder must solicit this interest within at least 10 days prior to bid opening to allow the DBEs to respond to the solicitation. Solicitation shall provide the opportunity to DBEs within the Division and surrounding Divisions where the project is located. The bidder must determine with certainty if the DBEs are interested by taking appropriate steps to follow up initial solicitations.
- (B) Selecting portions of the work to be performed by DBEs in order to increase the likelihood that the DBE goals will be achieved.
 - (1) Where appropriate, break out contract work items into economically feasible units to facilitate DBE participation, even when the prime contractor might otherwise prefer to perform these work items with its own forces.
 - (2) Negotiate with subcontractors to assume part of the responsibility to meet the contract DBE goal when the work to be sublet includes potential for DBE participation (2nd and 3rd tier subcontractors).
- (C) Providing interested DBEs with adequate information about the plans, specifications, and requirements of the contract in a timely manner to assist them in responding to a solicitation.
- (D)
 - (1) Negotiating in good faith with interested DBEs. It is the bidder's responsibility to make a portion of the work available to DBE subcontractors and suppliers and to select those portions of the work or material needs consistent with the available DBE subcontractors and suppliers, to facilitate DBE participation. Evidence of such negotiation includes the names, addresses, and telephone numbers of DBEs that were considered; a description of the information provided regarding the plans and specifications for the work selected for subcontracting; and evidence as to why additional agreements could not be reached for DBEs to perform the work.
 - (2) A bidder using good business judgment would consider a number of factors in negotiating with subcontractors, including DBE subcontractors, and would take

a firm's price and capabilities as well as contract goals into consideration. However, the fact that there may be some additional costs involved in finding and using DBEs is not in itself sufficient reason for a bidder's failure to meet the contract DBE goal, as long as such costs are reasonable. Also, the ability or desire of a prime contractor to perform the work of a contract with its own organization does not relieve the bidder of the responsibility to make good faith efforts. Bidding contractors are not, however, required to accept higher quotes from DBEs if the price difference is excessive or unreasonable.

- (E) Not rejecting DBEs as being unqualified without sound reasons based on a thorough investigation of their capabilities. The bidder's standing within its industry, membership in specific groups, organizations, or associates and political or social affiliations (for example, union vs. non-union employee status) are not legitimate causes for the rejection or non-solicitation of bids in the bidder's efforts to meet the project goal.
- (F) Making efforts to assist interested DBEs in obtaining bonding, lines of credit, or insurance as required by the recipient or bidder.
- (G) Making efforts to assist interested DBEs in obtaining necessary equipment, supplies, materials, or related assistance or services.
- (H) Effectively using the services of available minority/women community organizations; minority/women contractors' groups; Federal, State, and local minority/women business assistance offices; and other organizations as allowed on a case-by-case basis to provide assistance in the recruitment and placement of DBEs. Contact within 7 days from the bid opening the Business Opportunity and Work Force Development Unit at BOWD@ncdot.gov to give notification of the bidder's inability to get DBE quotes.
- (I) Any other evidence that the bidder submits which shows that the bidder has made reasonable good faith efforts to meet the DBE goal.

In addition, the Department may take into account the following:

- (1) Whether the bidder's documentation reflects a clear and realistic plan for achieving the DBE goal.
- (2) The bidders' past performance in meeting the DBE goals.
- (3) The performance of other bidders in meeting the DBE goal. For example, when the apparent successful bidder fails to meet the DBE goal, but others meet it, you may reasonably raise the question of whether, with additional reasonable efforts the apparent successful bidder could have met the goal. If the apparent successful bidder fails to meet the DBE goal, but meets or exceeds the average DBE participation obtained by other bidders, the Department may view this, in conjunction with other factors, as evidence of the apparent successful bidder having made a good faith effort.

If the Department does not award the contract to the apparent lowest responsive bidder, the Department reserves the right to award the contract to the next lowest responsive bidder that can satisfy to the Department that the DBE goal can be met or that an adequate good faith effort has been made to meet the DBE goal.

Non-Good Faith Appeal

The State Prequalification Engineer will notify the contractor verbally and in writing of non-good faith. A contractor may appeal a determination of non-good faith made by the Goal Compliance Committee. If a contractor wishes to appeal the determination made by the Committee, they shall provide written notification to the State Prequalification Engineer or at DBE@ncdot.gov. The appeal shall be made within 2 business days of notification of the determination of non-good faith.

Counting DBE Participation Toward Meeting DBE Goal

(A) Participation

The total dollar value of the participation by a committed DBE will be counted toward the contract goal requirement. The total dollar value of participation by a committed DBE will be based upon the value of work actually performed by the DBE and the actual payments to DBE firms by the Contractor.

(B) Joint Checks

Prior notification of joint check use shall be required when counting DBE participation for services or purchases that involves the use of a joint check. Notification shall be through submission of Form JC-1 (*Joint Check Notification Form*) and the use of joint checks shall be in accordance with the Department's Joint Check Procedures.

(C) Subcontracts (Non-Trucking)

A DBE may enter into subcontracts. Work that a DBE subcontracts to another DBE firm may be counted toward the contract goal requirement. Work that a DBE subcontracts to a non-DBE firm does not count toward the contract goal requirement. If a DBE contractor or subcontractor subcontracts a significantly greater portion of the work of the contract than would be expected on the basis of standard industry practices, it shall be presumed that the DBE is not performing a commercially useful function. The DBE may present evidence to rebut this presumption to the Department. The Department's decision on the rebuttal of this presumption is subject to review by the Federal Highway Administration but is not administratively appealable to USDOT.

(D) Joint Venture

When a DBE performs as a participant in a joint venture, the Contractor may count toward its contract goal requirement a portion of the total value of participation with the DBE in the joint venture, that portion of the total dollar value being a distinct clearly defined portion of work that the DBE performs with its forces.

(E) Suppliers

A contractor may count toward its DBE requirement 60 percent of its expenditures for materials and supplies required to complete the contract and obtained from a DBE regular dealer and 100 percent of such expenditures from a DBE manufacturer.

(F) Manufacturers and Regular Dealers

A contractor may count toward its DBE requirement the following expenditures to DBE firms that are not manufacturers or regular dealers:

- (1) The fees or commissions charged by a DBE firm for providing a *bona fide* service, such as professional, technical, consultant, or managerial services, or for providing bonds or insurance specifically required for the performance of a DOT-assisted contract, provided the fees or commissions are determined to be reasonable and not excessive as compared with fees and commissions customarily allowed for similar services.
- (2) With respect to materials or supplies purchased from a DBE, which is neither a manufacturer nor a regular dealer, count the entire amount of fees or commissions charged for assistance in the procurement of the materials and supplies, or fees or transportation charges for the delivery of materials or supplies required on a job site (but not the cost of the materials and supplies themselves), provided the fees are determined to be reasonable and not excessive as compared with fees customarily allowed for similar services.

Commercially Useful Function

(A) DBE Utilization

The Contractor may count toward its contract goal requirement only expenditures to DBEs that perform a commercially useful function in the work of a contract. A DBE performs a commercially useful function when it is responsible for execution of the work of the contract and is carrying out its responsibilities by actually performing, managing, and supervising the work involved. To perform a commercially useful function, the DBE shall also be responsible with respect to materials and supplies used on the contract, for negotiating price, determining quality and quantity, ordering the material and installing (where applicable) and paying for the material itself. To determine whether a DBE is performing a commercially useful function, the Department will evaluate the amount of work subcontracted, industry practices, whether the amount the firm is to be paid under the contract is commensurate with the work it is actually performing and the DBE credit claimed for its performance of the work, and any other relevant factors.

(B) DBE Utilization in Trucking

The following factors will be used to determine if a DBE trucking firm is performing a commercially useful function:

- (1) The DBE shall be responsible for the management and supervision of the entire trucking operation for which it is responsible on a particular contract, and there shall not be a contrived arrangement for the purpose of meeting DBE goals.
- (2) The DBE shall itself own and operate at least one fully licensed, insured, and operational truck used on the contract.
- (3) The DBE receives credit for the total value of the transportation services it provides on the contract using trucks it owns, insures, and operates using drivers it employs.
- (4) The DBE may subcontract the work to another DBE firm, including an owner-operator who is certified as a DBE. The DBE who subcontracts work to another DBE receives credit for the total value of the transportation services the subcontracted DBE provides on the contract.
- (5) The DBE may also subcontract the work to a non-DBE firm, including from an owner-operator. The DBE who subcontracts the work to a non-DBE is entitled to credit for the total value of transportation services provided by the non-DBE subcontractor not to exceed the value of transportation services provided by DBE-owned trucks on the contract. Additional participation by non-DBE subcontractors receives credit only for the fee or commission it receives as a result of the subcontract arrangement. The value of services performed under subcontract agreements between the DBE and the Contractor will not count towards the DBE contract requirement.
- (6) A DBE may lease truck(s) from an established equipment leasing business open to the general public. The lease must indicate that the DBE has exclusive use of and control over the truck. This requirement does not preclude the leased truck from working for others during the term of the lease with the consent of the DBE, so long as the lease gives the DBE absolute priority for use of the leased truck. This type of lease may count toward the DBE's credit as long as the driver is under the DBE's payroll.
- (7) Subcontracted/leased trucks shall display clearly on the dashboard the name of the DBE that they are subcontracted/leased to and their own company name if it is not identified on the truck itself. Magnetic door signs are not permitted.

DBE Replacement

When a Contractor has relied on a commitment to a DBE subcontractor (or an approved substitute DBE subcontractor) to meet all or part of a contract goal requirement, the contractor shall not terminate the DBE subcontractor for convenience. This includes, but is not limited to, instances in which the Contractor seeks to perform the work of the terminated subcontractor with another

DBE subcontractor, a non-DBE subcontractor, or with the Contractor's own forces or those of an affiliate.

The Contractor must give notice in writing both by certified mail and email to the DBE subcontractor, with a copy to the Engineer of its intent to request to terminate and/or substitute, and the reason for the request. The Contractor must give the DBE subcontractor five (5) business days to respond to the Contractor's Notice of Intent to Request Termination and/or Substitution. If the DBE subcontractor objects to the intended termination/substitution, the DBE, within five (5) business days must advise the Contractor and the Department of the reasons why the action should not be approved. The five-day notice period shall begin on the next business day after written notice is provided to the DBE subcontractor.

A committed DBE subcontractor may only be terminated after receiving the Department's written approval based upon a finding of good cause for the proposed termination and/or substitution. For purposes of this section, good cause shall include the following circumstances:

- (a) The listed DBE subcontractor fails or refuses to execute a written contract;
- (b) The listed DBE subcontractor fails or refuses to perform the work of its subcontract in a way consistent with normal industry standards. Provided, however, that good cause does not exist if the failure or refusal of the DBE subcontractor to perform its work on the subcontract results from the bad faith or discriminatory action of the prime contractor;
- (c) The listed DBE subcontractor fails or refuses to meet the prime contractor's reasonable, nondiscriminatory bond requirements;
- (d) The listed DBE subcontractor becomes bankrupt, insolvent, or exhibits credit unworthiness;
- (e) The listed DBE subcontractor is ineligible to work on public works projects because of suspension and debarment proceedings pursuant to 2 CFR Parts 180, 215 and 1,200 or applicable state law;
- (f) The listed DBE subcontractor is not a responsible contractor;
- (g) The listed DBE voluntarily withdraws from the project and provides written notice of withdrawal;
- (h) The listed DBE is ineligible to receive DBE credit for the type of work required;
- (i) A DBE owner dies or becomes disabled with the result that the listed DBE contractor is unable to complete its work on the contract;
- (j) Other documented good cause that compels the termination of the DBE subcontractor. Provided, that good cause does not exist if the prime contractor seeks to terminate a DBE it relied upon to obtain the contract so that the prime contractor can self-perform the work for which the DBE contractor was engaged or so that the prime contractor can substitute another DBE or non-DBE contractor after contract award.

The Contractor shall comply with the following for replacement of a committed DBE:

(A) Performance Related Replacement

When a committed DBE is terminated for good cause as stated above, an additional DBE that was submitted at the time of bid may be used to fulfill the DBE commitment. A good faith effort will only be required for removing a committed DBE if there were no additional

DBEs submitted at the time of bid to cover the same amount of work as the DBE that was terminated.

If a replacement DBE is not found that can perform at least the same amount of work as the terminated DBE, the Contractor shall submit a good faith effort documenting the steps taken. Such documentation shall include, but not be limited to, the following:

- (1) Copies of written notification to DBEs that their interest is solicited in contracting the work defaulted by the previous DBE or in subcontracting other items of work in the contract.
 - (2) Efforts to negotiate with DBEs for specific subbids including, at a minimum:
 - (a) The names, addresses, and telephone numbers of DBEs who were contacted.
 - (b) A description of the information provided to DBEs regarding the plans and specifications for portions of the work to be performed.
 - (3) A list of reasons why DBE quotes were not accepted.
 - (4) Efforts made to assist the DBEs contacted, if needed, in obtaining bonding or insurance required by the Contractor.
- (B) Decertification Replacement
- (1) When a committed DBE is decertified by the Department after the SAF (*Subcontract Approval Form*) has been received by the Department, the Department will not require the Contractor to solicit replacement DBE participation equal to the remaining work to be performed by the decertified firm. The participation equal to the remaining work performed by the decertified firm will count toward the contract goal requirement.
 - (2) When a committed DBE is decertified prior to the Department receiving the SAF (*Subcontract Approval Form*) for the named DBE firm, the Contractor shall take all necessary and reasonable steps to replace the DBE subcontractor with another DBE subcontractor to perform at least the same amount of work to meet the DBE goal requirement. If a DBE firm is not found to do the same amount of work, a good faith effort must be submitted to NCDOT (see A herein for required documentation).
 - (3) Exception: If the DBE's ineligibility is caused solely by its having exceeded the size standard during the performance of the contract, the Department will not require the Contractor to solicit replacement DBE participation equal to the remaining work to be performed by the decertified firm. The participation equal to the remaining work performed by the decertified firm will count toward the contract goal requirement and overall goal.

All requests for replacement of a committed DBE firm shall be submitted to the Engineer for approval on Form RF-1 (*DBE Replacement Request*). If the Contractor fails to follow this procedure, the Contractor may be disqualified from further bidding for a period of up to 6 months.

Changes in the Work

When the Engineer makes changes that result in the reduction or elimination of work to be performed by a committed DBE, the Contractor will not be required to seek additional participation. When the Engineer makes changes that result in additional work to be performed by a DBE based upon the Contractor's commitment, the DBE shall participate in additional work to the same extent as the DBE participated in the original contract work.

When the Engineer makes changes that result in extra work, which has more than a minimal impact on the contract amount, the Contractor shall seek additional participation by DBEs unless otherwise approved by the Engineer.

When the Engineer makes changes that result in an alteration of plans or details of construction, and a portion or all of the work had been expected to be performed by a committed DBE, the Contractor shall seek participation by DBEs unless otherwise approved by the Engineer.

When the Contractor requests changes in the work that result in the reduction or elimination of work that the Contractor committed to be performed by a DBE, the Contractor shall seek additional participation by DBEs equal to the reduced DBE participation caused by the changes.

Reports and Documentation

A SAF (*Subcontract Approval Form*) shall be submitted for all work which is to be performed by a DBE subcontractor. The Department reserves the right to require copies of actual subcontract agreements involving DBE subcontractors.

When using transportation services to meet the contract commitment, the Contractor shall submit a proposed trucking plan in addition to the SAF. The plan shall be submitted prior to beginning construction on the project. The plan shall include the names of all trucking firms proposed for use, their certification type(s), the number of trucks owned by the firm, as well as the individual truck identification numbers, and the line item(s) being performed.

Within 30 calendar days of entering into an agreement with a DBE for materials, supplies or services, not otherwise documented by the SAF as specified above, the Contractor shall furnish the Engineer a copy of the agreement. The documentation shall also indicate the percentage (60% or 100%) of expenditures claimed for DBE credit.

Reporting Disadvantaged Business Enterprise Participation

The Contractor shall provide the Engineer with an accounting of payments made to all DBE firms, including material suppliers and contractors at all levels (prime, subcontractor, or second tier subcontractor). This accounting shall be furnished to the Engineer for any given month by the end of the following month. Failure to submit this information accordingly may result in the following action:

- (A) Withholding of money due in the next partial pay estimate; or
- (B) Removal of an approved contractor from the prequalified bidders' list or the removal of other entities from the approved subcontractors list.

While each contractor (prime, subcontractor, 2nd tier subcontractor) is responsible for accurate accounting of payments to DBEs, it shall be the prime contractor's responsibility to report all monthly and final payment information in the correct reporting manner.

Failure on the part of the Contractor to submit the required information in the time frame specified may result in the disqualification of that contractor and any affiliate companies from further bidding until the required information is submitted.

Failure on the part of any subcontractor to submit the required information in the time frame specified may result in the disqualification of that contractor and any affiliate companies from being approved for work on future DOT projects until the required information is submitted.

Contractors reporting transportation services provided by non-DBE lessees shall evaluate the value of services provided during the month of the reporting period only.

At any time, the Engineer can request written verification of subcontractor payments.

The Contractor shall report the accounting of payments through the Department's DBE Payment Tracking System.

Failure to Meet Contract Requirements

Failure to meet contract requirements in accordance with Subarticle 102-15(J) of the *2018 Standard Specifications* may be cause to disqualify the Contractor.

CERTIFICATION FOR FEDERAL-AID CONTRACTS:

(3-21-90)

SP1 G85

The prospective participant certifies, by signing and submitting this bid or proposal, to the best of his or her knowledge and belief, that:

- (A) No Federal appropriated funds have been paid or will be paid, by or on behalf of the undersigned, to any person for influencing or attempting to influence an officer or employee of any Federal agency, a Member of Congress, an officer or employee of Congress, or an employee of a Member of Congress in connection with the awarding of any Federal contract, the making of any Federal grant, the making of any Federal loan, the entering into of any cooperative agreement, and the extension, continuation, renewal, amendment, or modification of any Federal contract, grant, loan, or cooperative agreement.
- (B) If any funds other than Federal appropriated funds have been paid or will be paid to any person for influencing or attempting to influence an officer or employee of any Federal agency, a Member of Congress, an officer or employee of Congress, or an employee of a Member of Congress in connection with this Federal contract, grant, loan, or cooperative

agreement, the undersigned shall complete and submit Standard Form-LLL, *Disclosure Form to Report Lobbying*, in accordance with its instructions.

This certification is a material representation of fact upon which reliance was placed when this transaction was made or entered into. Submission of this certification is a prerequisite for making or entering into this transaction imposed by *Section 1352, Title 31, U.S. Code*. Any person who fails to file the required certification shall be subject to a civil penalty of not less than \$10,000 and not more than \$100,000 for each such failure.

The prospective participant also agrees by submitting his or her bid or proposal that he or she shall require that the language of this certification be included in all lower tier subcontracts, which exceed \$100,000 and that all such subrecipients shall certify and disclose accordingly.

CONTRACTOR'S LICENSE REQUIREMENTS:

(7-1-95)

102-14

SP1 G88

If the successful bidder does not hold the proper license to perform any plumbing, heating, air conditioning, or electrical work in this contract, he will be required to sublet such work to a contractor properly licensed in accordance with *Article 2 of Chapter 87 of the General Statutes* (licensing of heating, plumbing, and air conditioning contractors) and *Article 4 of Chapter 87 of the General Statutes* (licensing of electrical contractors).

RESTRICTIONS ON ITS EQUIPMENT AND SERVICES:

(11-17-20)

SP01 G090

All telecommunications, video or other ITS equipment or services installed or utilized on this project must be in conformance with UNIFORM ADMINISTRATIVE REQUIREMENTS, COST PRINCIPLES, AND AUDIT REQUIREMENTS FOR FEDERAL AWARDS **2 CFR, § 200.216** **Prohibition on certain telecommunications and video surveillance services or equipment.**

USE OF UNMANNED AIRCRAFT SYSTEM (UAS):

(8-20-19)

SP1 G092

The Contractor shall adhere to all Federal, State and Local regulations and guidelines for the use of Unmanned Aircraft Systems (UAS). This includes but is not limited to US 14 CFR Part 107 *Small UAS Rule*, NC GS 15A-300.2 *Regulation of launch and recovery sites*, NC GS 63-95 *Training required for the operation of unmanned aircraft systems*, NC GS 63-96 *Permit required for commercial operation of unmanned aircraft system*, and NCDOT UAS Policy. The required operator certifications include possessing a current Federal Aviation Administration (FAA) Remote Pilot Certificate, a NC UAS Operator Permit as well as operating a UAS registered with the FAA.

Prior to beginning operations, the Contractor shall complete the NCDOT UAS – Flight Operation Approval Form and submit it to the Engineer for approval. All UAS operations shall be approved by the Engineer prior to beginning the operations.

All contractors or subcontractors operating UAS shall have UAS specific general liability insurance to cover all operations under this contract.

The use of UAS is at the Contractor's discretion. No measurement or payment will be made for the use of UAS. In the event that the Department directs the Contractor to utilize UAS, payment will be in accordance with Article 104-7 Extra Work.

EQUIPMENT IDLING GUIDELINES:

(1-19-21)

107

SP1 G096

Exercise reduced fuel consumption and reduced equipment emissions during the construction of all work associated with this contract. Employees engaged in the construction of this project should turn off vehicles when stopped for more than thirty (30) minutes and off-highway equipment should idle no longer than fifteen (15) consecutive minutes.

These guidelines for turning off vehicles and equipment when idling do not apply to:

1. Idling when queuing.
2. Idling to verify the vehicle is in safe operating condition.
3. Idling for testing, servicing, repairing or diagnostic purposes.
4. Idling necessary to accomplish work for which the vehicle was designed (such as operating a crane, mixing concrete, etc.).
5. Idling required to bring the machine system to operating temperature.
6. Emergency vehicles, utility company, construction, and maintenance vehicles where the engines must run to perform needed work.
7. Idling to ensure safe operation of the vehicle.
8. Idling when the propulsion engine is providing auxiliary power for other than heating or air conditioning. (such as hydraulic systems for pavers)
9. When specific traffic, safety, or emergency situations arise.
10. If the ambient temperature is less than 32 degrees Fahrenheit. Limited idling to provide for the safety of vehicle occupants (e.g. to run the heater).
11. If the ambient temperature is greater than 90 degrees Fahrenheit. Limited idling to provide for the safety of vehicle occupants of off-highway equipment (e.g. to run the air conditioning) no more than 30 minutes.
12. Diesel powered vehicles may idle for up to 30 minutes to minimize restart problems.

Any vehicle, truck, or equipment in which the primary source of fuel is natural gas or electricity is exempt from the idling limitations set forth in this special provision.

U.S. DEPARTMENT OF TRANSPORTATION HOTLINE:

(11-22-94)

108-5

SP1 G100

To report bid rigging activities call: **1-800-424-9071**

The U.S. Department of Transportation (DOT) operates the above toll-free hotline Monday through Friday, 8:00 a.m. to 5:00 p.m. eastern time. Anyone with knowledge of possible bid rigging, bidder collusion, or other fraudulent activities should use the hotline to report such activities.

The hotline is part of the DOT's continuing effort to identify and investigate highway construction contract fraud and abuse is operated under the direction of the DOT Inspector General. All information will be treated confidentially and caller anonymity will be respected.

CARGO PREFERENCE ACT:

(2-16-16)

Privately owned United States-flag commercial vessels transporting cargoes are subject to the Cargo Preference Act (CPA) of 1954 requirements and regulations found in 46 CFR 381.7. Contractors are directed to clause (b) of 46 CFR 381.7 as follows:

(b) Contractor and Subcontractor Clauses. "Use of United States-flag vessels: The contractor agrees-

" (1) To utilize privately owned United States-flag commercial vessels to ship at least 50 percent of the gross tonnage (computed separately for dry bulk carriers, dry cargo liners, and tankers) involved, whenever shipping any equipment, material, or commodities pursuant to this contract, to the extent such vessels are available at fair and reasonable rates for United States-flag commercial vessels.

(2) To furnish within 20 days following the date of loading for shipments originating within the United States or within 30 working days following the date of loading for shipments originating outside the United States a legible copy of a rated, 'on-board' commercial ocean bill-of-lading in English for each shipment of cargo described in paragraph (b) (1) of this section to both the Contracting Officer (through the prime contractor in the case of subcontractor bills-of-lading) and to the Division of National Cargo, Office of Market Development, Maritime Administration, Washington, DC 20590.

(3) To insert the substance of the provisions of this clause in all subcontracts issued pursuant to this contract."

SUBSURFACE INFORMATION:

(7-1-95)

450

SP1 G112 A

Subsurface information is available on the roadway portion of this project only.

MAINTENANCE OF THE PROJECT:

(11-20-07) (Rev. 1-17-12)

104-10

SP1 G125

Revise the *2018 Standard Specifications* as follows:

Page 1-39, Article 104-10 Maintenance of the Project, line 25, add the following after the first sentence of the first paragraph:

All guardrail/guiderail within the project limits shall be included in this maintenance.

Page 1-39, Article 104-10 Maintenance of the Project, line 30, add the following as the last sentence of the first paragraph:

The Contractor shall perform weekly inspections of guardrail and guiderail and shall report damages to the Engineer on the same day of the weekly inspection. *Where damaged guardrail or guiderail is repaired or replaced as a result of maintaining the project in accordance with this article, such repair or replacement shall be performed within 7 consecutive calendar days of such inspection report.*

Page 1-39, Article 104-10 Maintenance of the Project, lines 42-44, replace the last sentence of the last paragraph with the following:

The Contractor will not be directly compensated for any maintenance operations necessary, except for maintenance of guardrail/guiderail, as this work will be considered incidental to the work covered by the various contract items. The provisions of Article 104-7, Extra Work, and Article 104-8, Compensation and Record Keeping will apply to authorized maintenance of guardrail/guiderail. Performance of weekly inspections of guardrail/guiderail, and the damage reports required as described above, will be considered to be an incidental part of the work being paid for by the various contract items.

COOPERATION BETWEEN CONTRACTORS:

(7-1-95)

105-7

SP1 G133

The Contractor's attention is directed to Article 105-7 of the *2018 Standard Specifications*.

U-4405B (Cumberland County) is anticipated for an April 18, 2023 Letting and is located adjacent to this project.

The Contractor on this project shall cooperate with the Contractor working within or adjacent to the limits of this project to the extent that the work can be carried out to the best advantage of all concerned.

ELECTRONIC BIDDING:

(2-19-19)

101, 102, 103

SP1 G140

Revise the *2018 Standard Specifications* as follows:

Page 1-4, Article 101-3, DEFINITIONS, BID (OR PROPOSAL) *Electronic Bid*, line 1, replace “Bid Express®” with “the approved electronic bidding provider”.

Page 1-15, Subarticle 102-8(B), Electronic Bids, lines 39-40, replace “to Bid Express®” with “via the approved electronic bidding provider”.

Page 1-15, Subarticle 102-8(B)(1), Electronic Bids, line 41, delete “from Bid Express®”

Page 1-17, Subarticle 102-9(C)(2), Electronic Bids, line 21, replace “Bid Express® miscellaneous folder within the .ebs” with “electronic submittal”.

Page 1-29, Subarticle 103-4(C)(2), Electronic Bids, line 32, replace “.ebs miscellaneous data file of Expedite” with “electronic submittal file”

TWELVE MONTH GUARANTEE:

(7-15-03)

108

SP1 G145

- (A) The Contractor shall guarantee materials and workmanship against latent and patent defects arising from faulty materials, faulty workmanship or negligence for a period of twelve months following the date of final acceptance of the work for maintenance and shall replace such defective materials and workmanship without cost to the Department. The Contractor will not be responsible for damage due to faulty design, normal wear and tear, for negligence on the part of the Department, and/or for use in excess of the design.
- (B) Where items of equipment or material carry a manufacturer's guarantee for any period in excess of twelve months, then the manufacturer's guarantee shall apply for that particular piece of equipment or material. The Department's first remedy shall be through the manufacturer although the Contractor is responsible for invoking the warranted repair work with the manufacturer. The Contractor's responsibility shall be limited to the term of the manufacturer's guarantee. NCDOT would be afforded the same warranty as provided by the Manufacturer.

This guarantee provision shall be invoked only for major components of work in which the Contractor would be wholly responsible for under the terms of the contract. Examples would include pavement structures, bridge components, and sign structures. This provision will not be used as a mechanism to force the Contractor to return to the project to make repairs or perform additional work that the Department would normally compensate the Contractor for. In addition, routine maintenance activities (i.e. mowing grass, debris removal, ruts in earth shoulders,) are not parts of this guarantee.

Appropriate provisions of the payment and/or performance bonds shall cover this guarantee for the project.

To ensure uniform application statewide the Division Engineer will forward details regarding the circumstances surrounding any proposed guarantee repairs to the Chief Engineer for review and approval prior to the work being performed.

EROSION AND SEDIMENT CONTROL/STORMWATER CERTIFICATION:

(1-16-07) (Rev 12-15-20)

105-16, 225-2, 16

SP1 G180

General

Schedule and conduct construction activities in a manner that will minimize soil erosion and the resulting sedimentation and turbidity of surface waters. Comply with the requirements herein regardless of whether or not a National Pollution discharge Elimination System (NPDES) permit for the work is required.

Establish a chain of responsibility for operations and subcontractors' operations to ensure that the *Erosion and Sediment Control/Stormwater Pollution Prevention Plan* is implemented and maintained over the life of the contract.

- (A) *Certified Supervisor* - Provide a certified Erosion and Sediment Control/Stormwater Supervisor to manage the Contractor and subcontractor operations, insure compliance with

Federal, State and Local ordinances and regulations, and manage the Quality Control Program.

- (B) *Certified Foreman* - Provide a certified, trained foreman for each construction operation that increases the potential for soil erosion or the possible sedimentation and turbidity of surface waters.
- (C) *Certified Installer* - Provide a certified installer to install or direct the installation for erosion or sediment/stormwater control practices.
- (D) *Certified Designer* - Provide a certified designer for the design of the erosion and sediment control/stormwater component of reclamation plans and, if applicable, for the design of the project erosion and sediment control/stormwater plan.

Roles and Responsibilities

- (A) *Certified Erosion and Sediment Control/Stormwater Supervisor* - The Certified Supervisor shall be Level II and responsible for ensuring the erosion and sediment control/stormwater plan is adequately implemented and maintained on the project and for conducting the quality control program. The Certified Supervisor shall be on the project within 24 hours notice from initial exposure of an erodible surface to the project's final acceptance. Perform the following duties:
 - (1) **Manage Operations** - Coordinate and schedule the work of subcontractors so that erosion and sediment control/stormwater measures are fully executed for each operation and in a timely manner over the duration of the contract.
 - (a) Oversee the work of subcontractors so that appropriate erosion and sediment control/stormwater preventive measures are conformed to at each stage of the work.
 - (b) Prepare the required National Pollutant Discharge Elimination System (NPDES) Inspection Record and submit to the Engineer.
 - (c) Attend all weekly or monthly construction meetings to discuss the findings of the NPDES inspection and other related issues.
 - (d) Implement the erosion and sediment control/stormwater site plans requested.
 - (e) Provide any needed erosion and sediment control/stormwater practices for the Contractor's temporary work not shown on the plans, such as, but not limited to work platforms, temporary construction, pumping operations, plant and storage yards, and cofferdams.
 - (f) Acquire applicable permits and comply with requirements for borrow pits, dewatering, and any temporary work conducted by the Contractor in jurisdictional areas.
 - (g) Conduct all erosion and sediment control/stormwater work in a timely and workmanlike manner.
 - (h) Fully perform and install erosion and sediment control/stormwater work prior to any suspension of the work.

- (i) Coordinate with Department, Federal, State and Local Regulatory agencies on resolution of erosion and sediment control/stormwater issues due to the Contractor's operations.
 - (j) Ensure that proper cleanup occurs from vehicle tracking on paved surfaces or any location where sediment leaves the Right-of-Way.
 - (k) Have available a set of erosion and sediment control/stormwater plans that are initialed and include the installation date of Best Management Practices. These practices shall include temporary and permanent groundcover and be properly updated to reflect necessary plan and field changes for use and review by Department personnel as well as regulatory agencies.
- (2) Requirements set forth under the NPDES Permit - The Department's NPDES Stormwater permit (NCS000250) outlines certain objectives and management measures pertaining to construction activities. The permit references *NCG010000, General Permit to Discharge Stormwater* under the NPDES, and states that the Department shall incorporate the applicable requirements into its delegated Erosion and Sediment Control Program for construction activities disturbing one or more acres of land. The Department further incorporates these requirements on all contracted bridge and culvert work at jurisdictional waters, regardless of size. Some of the requirements are, but are not limited to:
- (a) Control project site waste to prevent contamination of surface or ground waters of the state, i.e. from equipment operation/maintenance, construction materials, concrete washout, chemicals, litter, fuels, lubricants, coolants, hydraulic fluids, any other petroleum products, and sanitary waste.
 - (b) Inspect erosion and sediment control/stormwater devices and stormwater discharge outfalls at least once every 7 calendar days and within 24 hours after a rainfall event equal to or greater than 1.0 inch that occurs within a 24 hour period. Additional monitoring may be required at the discretion of Division of Water Resources personnel if the receiving stream is 303(d) listed for turbidity and the project has had documented problems managing turbidity.
 - (c) Maintain an onsite rain gauge or use the Department's Multi-Sensor Precipitation Estimate website to maintain a daily record of rainfall amounts and dates.
 - (d) Maintain erosion and sediment control/stormwater inspection records for review by Department and Regulatory personnel upon request.
 - (e) Implement approved reclamation plans on all borrow pits, waste sites and staging areas.
 - (f) Maintain a log of turbidity test results as outlined in the Department's Procedure for Monitoring Borrow Pit Discharge.
 - (g) Provide secondary containment for bulk storage of liquid materials.
 - (h) Provide training for employees concerning general erosion and sediment control/stormwater awareness, the Department's NPDES Stormwater Permit NCS000250 requirements, and the applicable requirements of the *General Permit, NCG010000*.

- (i) Report violations of the NPDES permit to the Engineer immediately who will notify the Division of Water Quality Regional Office within 24 hours of becoming aware of the violation.
- (3) Quality Control Program - Maintain a quality control program to control erosion, prevent sedimentation and follow provisions/conditions of permits. The quality control program shall:
- (a) Follow permit requirements related to the Contractor and subcontractors' construction activities.
 - (b) Ensure that all operators and subcontractors on site have the proper erosion and sediment control/stormwater certification.
 - (c) Notify the Engineer when the required certified erosion and sediment control/stormwater personnel are not available on the job site when needed.
 - (d) Conduct the inspections required by the NPDES permit.
 - (e) Take corrective actions in the proper timeframe as required by the NPDES permit for problem areas identified during the NPDES inspections.
 - (f) Incorporate erosion control into the work in a timely manner and stabilize disturbed areas with mulch/seed or vegetative cover on a section-by-section basis.
 - (g) Use flocculants approved by state regulatory authorities where appropriate and where required for turbidity and sedimentation reduction.
 - (h) Ensure proper installation and maintenance of temporary erosion and sediment control devices.
 - (i) Remove temporary erosion or sediment control devices when they are no longer necessary as agreed upon by the Engineer.
 - (j) The Contractor's quality control and inspection procedures shall be subject to review by the Engineer. Maintain NPDES inspection records and make records available at all times for verification by the Engineer.
- (B) *Certified Foreman* - At least one Certified Foreman shall be onsite for each type of work listed herein during the respective construction activities to control erosion, prevent sedimentation and follow permit provisions:
- (1) Foreman in charge of grading activities
 - (2) Foreman in charge of bridge or culvert construction over jurisdictional areas
 - (3) Foreman in charge of utility activities

The Contractor may request to use the same person as the Level II Supervisor and Level II Foreman. This person shall be onsite whenever construction activities as described above are taking place. This request shall be approved by the Engineer prior to work beginning.

The Contractor may request to name a single Level II Foreman to oversee multiple construction activities on small bridge or culvert replacement projects. This request shall be approved by the Engineer prior to work beginning.

- (C) *Certified Installers* - Provide at least one onsite, Level I Certified Installer for each of the following erosion and sediment control/stormwater crew:

- (1) Seeding and Mulching
- (2) Temporary Seeding
- (3) Temporary Mulching
- (4) Sodding
- (5) Silt fence or other perimeter erosion/sediment control device installations
- (6) Erosion control blanket installation
- (7) Hydraulic tackifier installation
- (8) Turbidity curtain installation
- (9) Rock ditch check/sediment dam installation
- (10) Ditch liner/matting installation
- (11) Inlet protection
- (12) Riprap placement
- (13) Stormwater BMP installations (such as but not limited to level spreaders, retention/detention devices)
- (14) Pipe installations within jurisdictional areas

If a Level I *Certified Installer* is not onsite, the Contractor may substitute a Level II Foreman for a Level I Installer, provided the Level II Foreman is not tasked to another crew requiring Level II Foreman oversight.

- (D) *Certified Designer* - Include the certification number of the Level III Certified Designer on the erosion and sediment control/stormwater component of all reclamation plans and if applicable, the certification number of the Level III Certified Designer on the design of the project erosion and sediment control/stormwater plan.

Preconstruction Meeting

Furnish the names of the *Certified Erosion and Sediment Control/Stormwater Supervisor*, *Certified Foremen*, *Certified Installers* and *Certified Designer* and notify the Engineer of changes in certified personnel over the life of the contract within 2 days of change.

Ethical Responsibility

Any company performing work for the North Carolina Department of Transportation has the ethical responsibility to fully disclose any reprimand or dismissal of an employee resulting from improper testing or falsification of records.

Revocation or Suspension of Certification

Upon recommendation of the Chief Engineer to the certification entity, certification for *Supervisor*, *Certified Foremen*, *Certified Installers* and *Certified Designer* may be revoked or suspended with the issuance of an *Immediate Corrective Action (ICA)*, *Notice of Violation (NOV)*, or *Cease and Desist Order* for erosion and sediment control/stormwater related issues.

The Chief Engineer may recommend suspension or permanent revocation of certification due to the following:

- (A) Failure to adequately perform the duties as defined within this certification provision.
- (B) Issuance of an ICA, NOV, or Cease and Desist Order.
- (C) Failure to fully perform environmental commitments as detailed within the permit conditions and specifications.
- (D) Demonstration of erroneous documentation or reporting techniques.
- (E) Cheating or copying another candidate's work on an examination.
- (F) Intentional falsification of records.
- (G) Directing a subordinate under direct or indirect supervision to perform any of the above actions.
- (H) Dismissal from a company for any of the above reasons.
- (I) Suspension or revocation of one's certification by another entity.

Suspension or revocation of a certification will be sent by certified mail to the certificant and the Corporate Head of the company that employs the certificant.

A certificant has the right to appeal any adverse action which results in suspension or permanent revocation of certification by responding, in writing, to the Chief Engineer within 10 calendar days after receiving notice of the proposed adverse action.

Chief Engineer
1536 Mail Service Center
Raleigh, NC 27699-1536

Failure to appeal within 10 calendar days will result in the proposed adverse action becoming effective on the date specified on the certified notice. Failure to appeal within the time specified will result in a waiver of all future appeal rights regarding the adverse action taken. The certificant will not be allowed to perform duties associated with the certification during the appeal process.

The Chief Engineer will hear the appeal and make a decision within 7 days of hearing the appeal. Decision of the Chief Engineer will be final and will be made in writing to the certificant.

If a certification is temporarily suspended, the certificant shall pass any applicable written examination and any proficiency examination, at the conclusion of the specified suspension period, prior to having the certification reinstated.

Measurement and Payment

Certified Erosion and Sediment Control/Stormwater Supervisor, Certified Foremen, Certified Installers and Certified Designer will be incidental to the project for which no direct compensation will be made.

PROCEDURE FOR MONITORING BORROW PIT DISCHARGE:

(2-20-07) (Rev. 4-5-19)

105-16, 230, 801

SP1 G181

Water discharge from borrow pit sites shall not cause surface waters to exceed 50 NTUs (nephelometric turbidity unit) in streams not designated as trout waters and 10 NTUs in streams, lakes or reservoirs designated as trout waters. For lakes and reservoirs not designated as trout waters, the turbidity shall not exceed 25 NTUs. If the turbidity exceeds these levels due to natural background conditions, the existing turbidity level shall not be increased.

If during any operating day, the downstream water quality exceeds the standard, the Contractor shall do all of the following:

- (A) Either cease discharge or modify the discharge volume or turbidity levels to bring the downstream turbidity levels into compliance, or
- (B) Evaluate the upstream conditions to determine if the exceedance of the standard is due to natural background conditions. If the background turbidity measurements exceed the standard, operation of the pit and discharge can continue as long as the stream turbidity levels are not increased due to the discharge.
- (C) Measure and record the turbidity test results (time, date and sampler) at all defined sampling locations 30 minutes after startup and at a minimum, one additional sampling of all sampling locations during that 24-hour period in which the borrow pit is discharging.
- (D) Notify DWQ within 24 hours of any stream turbidity standard exceedances that are not brought into compliance.

During the Environmental Assessment required by Article 230-4 of the *2018 Standard Specifications*, the Contractor shall define the point at which the discharge enters into the State's surface waters and the appropriate sampling locations. Sampling locations shall include points upstream and downstream from the point at which the discharge enters these waters. Upstream sampling location shall be located so that it is not influenced by backwater conditions and represents natural background conditions. Downstream sampling location shall be located at the point where complete mixing of the discharge and receiving water has occurred.

The discharge shall be closely monitored when water from the dewatering activities is introduced into jurisdictional wetlands. Any time visible sedimentation (deposition of sediment) on the wetland surface is observed, the dewatering activity will be suspended until turbidity levels in the stilling basin can be reduced to a level where sediment deposition does not occur. Staining of wetland surfaces from suspended clay particles, occurring after evaporation or infiltration, does not constitute sedimentation. No activities shall occur in wetlands that adversely affect the functioning of a wetland. Visible sedimentation will be considered an indication of possible adverse impacts on wetland use.

The Engineer will perform independent turbidity tests on a random basis. These results will be maintained in a log within the project records. Records will include, at a minimum, turbidity test results, time, date and name of sampler. Should the Department's test results exceed those of the Contractor's test results, an immediate test shall be performed jointly with the results superseding the previous test results of both the Department and the Contractor.

The Contractor shall use the *NCDOT Turbidity Reduction Options for Borrow Pits Matrix*, available at <https://connect.ncdot.gov/resources/roadside/FieldOperationsDocuments/TurbidityReductionOptionSheet.pdf> to plan, design, construct, and maintain BMPs to address water quality standards. Tier I Methods include stilling basins which are standard compensatory BMPs. Other Tier I methods are noncompensatory and shall be used when needed to meet the stream turbidity standards. Tier II Methods are also noncompensatory and are options that may

be needed for protection of rare or unique resources or where special environmental conditions exist at the site which have led to additional requirements being placed in the DWQ's 401 Certifications and approval letters, Isolated Wetland Permits, Riparian Buffer Authorization or a DOT Reclamation Plan's Environmental Assessment for the specific site. Should the Contractor exhaust all Tier I Methods on a site exclusive of rare or unique resources or special environmental conditions, Tier II Methods may be required by regulators on a case by case basis per supplemental agreement.

The Contractor may use cation exchange capacity (CEC) values from proposed site borings to plan and develop the bid for the project. CEC values exceeding 15 milliequivalents per 100 grams of soil may indicate a high potential for turbidity and should be avoided when dewatering into surface water is proposed.

No additional compensation for monitoring borrow pit discharge will be paid.

NOTE TO CONTRACTOR (Parcel-55 Trees):

Coordinate with the Engineer prior to removing any trees on Parcel 55 as noted on plan sheet 6.

NOTE TO CONTRACTOR (Signals Communications):

The Signals Communications Plans will be revised as part of a future construction revision to reflect the fact that the Department and/or City of Fayetteville has already performed some of the Signals Communications work that was proposed under the U-4405A project. Work already performed includes the installation of fiber optic trunk cable as well as hooking up the fiber to the existing signal cabinets. The revised plans will show this fiber as existing, and will relocate fiber communications equipment to new and relocated signal cabinets being installed under U-4405A. Additionally, the revised plans will retain information for the relocation of an existing CCTV and installation of a new DMS. Signals Communications quantities and specifications have already been updated to reflect the changes and are included in these contract documents.

PROJECT SPECIAL PROVISIONS**ROADWAY****CLEARING AND GRUBBING - METHOD II:**

(9-17-02) (Rev.8-18-15)

200

SP2 R02A

Perform clearing on this project to the limits established by Method "II" shown on Standard Drawing No. 200.02 of the *2018 Roadway Standard Drawings*. Conventional clearing methods may be used except where permit drawings or conditions have been included in the proposal which require certain areas to be cleared by hand methods.

BURNING RESTRICTIONS:

(7-1-95)

200, 210, 215

SP2 R05

Open burning is not permitted on any portion of the right-of-way limits established for this project. Do not burn the clearing, grubbing or demolition debris designated for disposal and generated from the project at locations within the project limits, off the project limits or at any waste or borrow sites in this county. Dispose of the clearing, grubbing and demolition debris by means other than burning, according to state or local rules and regulations.

SHOULDER AND FILL SLOPE MATERIAL:

(5-21-02)

235, 560

SP2 R45 B

Description

Perform the required shoulder and slope construction for this project in accordance with the applicable requirements of Section 560 and Section 235 of the *2018 Standard Specifications*.

Measurement and Payment

When the Contractor elects to obtain material from an area located beneath a proposed fill sections which does not require excavation for any reason other than to generate acceptable shoulder and fill slope material, the work of performing the excavation will be considered incidental to the item of *Borrow Excavation* or *Shoulder Borrow*. If there is no pay item for *Borrow* or *Shoulder Borrow* in the contract, this work will be considered incidental to *Unclassified Excavation*. Stockpile the excavated material in a manner to facilitate measurement by the Engineer. Fill the void created by the excavation of the shoulder and fill slope material with suitable material. Payment for material used from the stockpile will be made at the contract unit price for *Borrow Excavation* or *Shoulder Borrow*. If there is no pay item for *Borrow Excavation* or *Shoulder Borrow*, then the material will be paid for at the contract unit price for *Unclassified Excavation*. The material used to fill the void created by the excavation of the shoulder and fill slope material will be made at the contract unit price for *Unclassified Excavation*, *Borrow Excavation*, or *Shoulder Borrow*, depending on the source of the material.

Material generated from undercut excavation, unclassified excavation or clearing and grubbing operations that is placed directly on shoulders or slope areas, will not be measured separately for payment, as payment for the work requiring the excavation will be considered adequate compensation for depositing and grading the material on the shoulders or slopes.

When undercut excavation is performed at the direction of the Engineer and the material excavated is found to be suitable for use as shoulder and fill slope material, and there is no area on the project currently prepared to receive the material generated by the undercut operation, the Contractor may construct a stockpile for use as borrow at a later date. Payment for the material used from the stockpile will be made at the contract unit price for *Borrow Excavation* or *Shoulder Borrow*.

When shoulder material is obtained from borrow sources or from stockpiled material, payment for the work of shoulder construction will be made at the contract unit price per cubic yard for *Borrow Excavation* or *Shoulder Borrow* in accordance with the applicable provisions of Section 230 or Section 560 of the *2018 Standard Specifications*.

MANUFACTURED QUARRY FINES IN EMBANKMENTS:

(01-17-17)

235

SP02 R72

Description

This specification addresses the use of manufactured quarry fines that are not classified as select materials. The specification allows the Contractor an option, with the approval of the Engineer, to use manufactured quarry fines (MQFs) in embankments as a substitute for conventional borrow material. Furnish and place geotextile for pavement stabilization in accordance with the Geotextile for Pavement Stabilization special provision and detail. Geotextile for pavement stabilization is required to prevent pavement cracking and provide separation between the subgrade and pavement section at embankment locations where manufactured quarry fines are utilized and as directed by the Engineer.

Materials

Manufactured Quarry Fines.

Site specific approval of MQFs material will be required prior to beginning construction as detailed in the preconstruction requirements of this provision.

The following MQFs are unacceptable:

- (A) Frozen material,
- (B) Material with a maximum dry unit weight of less than 90 pounds per cubic foot when tested in accordance with AASHTO T-99 Method A or C.
- (C) Material with greater than 80% by weight Passing the #200 sieve

Collect and transport MQFs in a manner that will prevent nuisances and hazards to public health and safety. Moisture condition the MQFs as needed and transport in covered trucks to prevent dusting. If MQFs are blended with natural earth material, follow Borrow Criteria in Section 1018 of the *Standard Specifications*.

Geotextiles

Areas of embankment where MQFs are incorporated, Geotextile for Pavement Stabilization shall be used. If the Geotextile for Pavement Stabilization special provision is not included elsewhere in this contract, then it along with a detail will be incorporated as part of the contractors request to use. Notification of subgrade elevation, sampling and waiting period as required in the Construction Methods section of the Geotextile for Pavement Stabilization special provision are not required.

Preconstruction Requirements

When MQFs are to be used as a substitute for earth borrow material, request written approval from the Engineer at least ninety (90) days in advance of the intent to use MQFs and include the following details:

- (A) Description, purpose and location of project.
- (B) Estimated start and completion dates of project.
- (C) Estimated volume of MQFs to be used on project with specific locations and construction details of the placement.
- (D) The names, address, and contact information for the generator of the MQFs.
- (E) Physical location of the site at which the MQFs were generated.

The Engineer will forward this information to the State Materials Engineer for review and material approval.

Construction Methods

Place MQFs in the core of the embankment section with at least 4 feet of earth cover to the outside limits of the embankments or subgrade.

Construct embankments by placing MQFs in level uniform lifts with no more than a lift of 10 inches and compacted to at least a density of 95 percent as determined by test methods in AASHTO T-99, Determination of Maximum Dry Density and Optimum Moisture Content, Method A or C depending upon particle size of the product. Provide a moisture content at the time of compaction of within 4 percent of optimum but not greater than one percent above optimum as determined by AASHTO T-99, Method A or C.

Areas of embankment where MQFs are incorporated, Geotextile for Pavement Stabilization shall be used. See Geotextile for Pavement Stabilization special provision for geotextile type and construction method.

Measurement and Payment

Borrow Excavation will be measured by truck volume and paid in cubic yards in accordance with Article 230-5 of the *2018 Standard Specifications*. As an alternate weigh tickets can be provided and payment made by converting weight to cubic yards based on the verifiable unit weight.

Where the pay item of *Geotextile for Pavement Stabilization* is included in the original contract the material will be measured and paid in square yards (see Geotextile for Pavement Stabilization special provision). Where the pay item of *Geotextile for Pavement Stabilization* is not included in the original contract then no payment will be made for this item and will be considered incidental to the use of MQFs in embankment.

FLOWABLE FILL:

(9-17-02) (Rev 1-17-12)

300, 340, 1000, 1530, 1540, 1550

SP3 R30

Description

This work consists of all work necessary to place flowable fill in accordance with these provisions, the plans, and as directed.

Materials

Refer to Division 10 of the *2018 Standard Specifications*.

Item	Section
Flowable Fill	1000-6

Construction Methods

Discharge flowable fill material directly from the truck into the space to be filled, or by other approved methods. The mix may be placed full depth or in lifts as site conditions dictate. The Contractor shall provide a method to plug the ends of the existing pipe in order to contain the flowable fill.

Measurement and Payment

At locations where flowable fill is called for on the plans and a pay item for flowable fill is included in the contract, *Flowable Fill* will be measured in cubic yards and paid as the actual number of cubic yards that have been satisfactorily placed and accepted. Such price and payment will be full compensation for all work covered by this provision including, but not limited to, the mix design, furnishing, hauling, placing and containing the flowable fill.

Payment will be made under:

Pay Item	Pay Unit
Flowable Fill	Cubic Yard

CORRUGATED ALUMINUM ALLOY CULVERT PIPE:

(9-21-21)

305, 310

SP3 R34

Revise the *Standard Specifications* as follows:

Page 3-1, Article 305-2, MATERIALS, add the following after line 16:

Item	Section
Waterborne Paint	1080-9
Hot Bitumen	1081-3

Page 3-1, Article 305-3, CONSTRUCTION METHODS, add the following after line 24:

Coating must be applied to the aluminum when in contact with concrete. Immediately prior to coating, aluminum surfaces to be coated shall be cleaned by a method that will remove all dirt, oil,

grease, chips, and other foreign substances. Aluminum to be coated shall be given one coat of suitable quality coating such as:

Approved waterborne paint (Section 1080-9)

Approved Hot Bitumen (Section 1081-3)

Other coating materials may be submitted to the Engineer for approval.

Page 3-7, Article 310-6, MEASUREMENT AND PAYMENT, lines 6-11, delete the fourth sentence and replace with the following:

Select bedding and backfill material and coating will be included in the cost of the installed pipe. Such price and payment will be full compensation for all materials, labor, equipment, and other incidentals necessary to complete the work.

POLYPROPYLENE CULVERT PIPE:

(8-20-19)

305,310

SP3 R35

Revise the *2018 Standard Specifications* as follows:

Page 3-5, Article 305-1 DESCRIPTION, lines 12-14, replace with the following:

Where shown in the plans, the Contractor may use reinforced concrete pipe, aluminum alloy pipe, aluminized corrugated steel pipe, HDPE pipe, Polypropylene Pipe, or PVC pipe in accordance with the following requirements.

Page 3-5, Article 305-2 MATERIALS, add the following after line 16:

Item	Section
Polypropylene Pipe	1032-9

Page 3-6, Article 310-2 MATERIALS, add the following after line 9:

Item	Section
Polypropylene Pipe	1032-9

Page 3-6, Article 310-4 SIDE DRAIN PIPE, lines 24-25, replace the first sentence of the second paragraph with the following:

Where shown in the plans, side drain pipe may be Class II reinforced concrete pipe, aluminized corrugated steel pipe, corrugated aluminum alloy pipe, polypropylene pipe, HDPE pipe or PVC pipe.

Page 3-7, Article 310-5 PIPE END SECTIONS, lines 2-4, replace the second sentence with the following:

Both corrugated steel and concrete pipe end sections will work on concrete pipe, corrugated steel pipe, polypropylene pipe, and HDPE smooth lined corrugated plastic pipe.

Page 3-7, Article 310-6 MEASUREMENT AND PAYMENT, add the following after line 14:

Pay Item	Pay Unit
__" Polypropylene Pipe	Linear Foot

Page 10-60, add Article 1032-9:

(A) General

Use polypropylene pipe from sources participating in the Department's Polypropylene Pipe QA/QC Program. A list of participating sources is available from the Materials and Tests Unit. The Department will remove a manufacturer of polypropylene pipe from this program if the monitoring efforts indicated that non-specification material is being provided or test procedures are not being followed.

Use polypropylene culvert pipe that meets AASHTO M 330 for Type S or Type D, or ASTM F2881 or ASTM F2764 Double or Triple wall; and has been evaluated by NTPEP.

(B) End Treatments, Pipe Tees and Elbows

End treatments, pipe tees and elbows shall meet AASHTO M 330, Section 7.7, or ASTM F2764, Section 6.6.

(C) Marking

Clearly mark each section of pipe, end section, tee and elbow and other accessories according to the Department's Polypropylene Pipe QC/QA Program:

- (1) AASHTO or ASTM Designation
- (2) The date of manufacture
- (3) Name or trademark of the manufacturer

When polypropylene pipe, end sections, tees and elbows have been inspected and accepted a sticker will be applied to the inside of the pipe. Do not use pipe sections, flared end sections, tees or elbows which do not have this seal of approval.

4" PVC SLEEVE:

General

The work covered by the provision shall consist of furnishing and installing duct pipe, including elbows, as shown on the plans (or as directed by the Engineer) under sidewalks and roadway. Place sleeve at a depth of 2' below finished grade to extend 18" beyond pavement on each side.

Mark the location of the sleeve by driving a rebar stake in line at each end (1" exposed above finished grade).

Material

The duct shall be rigid (Polyvinyl Chloride) heavy wall, UL approved for underground use without concrete encasement per UL 651 "Rigid Non-Metallic Conduit or Encasement".

Installation

Excavate, place encasement pipe and backfill so that encasement is in line with piping. Backfill shall be compacted to 95% or in accordance with subgrade requirements, whichever is greater.

Measurement and Payment

Measurement and payment for PVC Duct shall be at the contract unit price per linear foot for "4"

PVC Sleeve" as installed, and will be full compensation for all work covered by this section.

Payment will be made under:

Pay Item	Pay Unit
4" PVC Sleeve	LF

PERMANENT SOIL REINFORCEMENT MAT:

Description

This work consists of furnishing and placing *Permanent Soil Reinforcement Mat*, of the type specified, over previously prepared areas as directed.

Materials

The product shall be a permanent erosion control reinforcement mat and shall be constructed of synthetic or a combination of coconut and synthetic fibers evenly distributed throughout the mat between a bottom UV stabilized netting and a heavy duty UV stabilized top net. The matting shall be stitched together with UV stabilized polypropylene thread to form a permanent three-dimensional structure. The mat shall have the following minimum physical properties:

Property	Test Method	Value	Unit
Light Penetration	ASTM D6567	9	%
Thickness	ASTM D6525	0.40	in
Mass Per Unit Area	ASTM D6566	0.55	lb/sy
Tensile Strength	ASTM D6818	385	lb/ft
Elongation (Maximum)	ASTM D6818	49	%
Resiliency	ASTM D1777	>70	%
UV Stability *	ASTM D4355	≥80	%
Porosity (Permanent Net)	ECTC Guidelines	≥85	%
Maximum Permissible Shear Stress (Vegetated)	Performance Bench Test	≥8.0	lb/ft ²
Maximum Allowable Velocity (Vegetated)	Performance Bench Test	≥16.0	ft/s

*ASTM D1682 Tensile Strength and % strength retention of material after 1000 hours of exposure.

Submit a certification (Type 1, 2, or 3) from the manufacturer showing:

- (A) the chemical and physical properties of the mat used, and
- (B) conformance of the mat with this specification.

Construction Methods

Matting shall be installed in accordance with Subarticle 1631-3(B) of the *Standard Specifications*.

All areas to be protected with the mat shall be brought to final grade and seeded in accordance with Section 1660 of the *Standard Specifications*. The surface of the soil shall be smooth, firm, stable and free of rocks, clods, roots or other obstructions that would prevent the mat from lying in direct contact with the soil surface. Areas where the mat is to be placed will not need to be mulched.

Measurement and Payment

Permanent Soil Reinforcement Mat will be measured and paid for as the actual number of square yards measured along the surface of the ground over which Permanent Soil Reinforcement Mat is installed and accepted. Overlaps will not be included in the measurement, and will be considered as incidental to the work. Such payment shall be full compensation for furnishing and installing the mat, including overlaps, and for all required maintenance.

Payment will be made under:

Pay Item

Permanent Soil Reinforcement Mat

Pay Unit

Square Yard

AGGREGATE SUBGRADE:

(5-15-18)

505

SP5 R8

Revise the *2018 Standard Specifications* as follows:

Page 5-8, Article 505-1 DESCRIPTION, lines 4-6, replace the paragraph with the following:

Construct aggregate subgrades in accordance with the contract. Install geotextile for soil stabilization and place Class IV subgrade stabilization at locations shown in the plans and as directed.

Undercut natural soil materials if necessary to construct aggregate subgrades. Define “subbase” as the portion of the roadbed below the Class IV subgrade stabilization. For Type 2 aggregate subgrades, undercut subbases as needed. The types of aggregate subgrade with thickness and compaction requirements for each are as shown below.

Type 1 – A 6 to 24 inch thick aggregate subgrade with Class IV subgrade stabilization compacted to 92% of AASHTO T 180 as modified by the Department or to the highest density that can be reasonably obtained.

Type 2 – An 8 inch thick aggregate subgrade on a proof rolled subbase with Class IV subgrade stabilization compacted to 97% of AASHTO T 180 as modified by the Department.

Page 5-8, Article 505-3 CONSTRUCTION METHODS, line 12, insert the following after the first sentence of the first paragraph:

For Type 2 aggregate subgrades, proof roll subbases in accordance with Section 260 before installing geotextile for soil stabilization.

Page 5-8, Article 505-3 CONSTRUCTION METHODS, lines 16-17, replace the last sentence of the first paragraph with the following:

Compact ABC as required for the type of aggregate subgrade constructed.

Page 5-8, Article 505-4 MEASUREMENT AND PAYMENT, line 26, insert the following after the last sentence of the first paragraph:

Undercut Excavation of natural soil materials from subbases for Type 2 aggregate subgrades will be measured and paid in accordance with Article 225-7 or 226-3. No measurement will be made for any undercut excavation of fill materials from subbases.

PRICE ADJUSTMENT - ASPHALT BINDER FOR PLANT MIX:

(11-21-00)

620

SP6 R25

Price adjustments for asphalt binder for plant mix will be made in accordance with Section 620 of the *2018 Standard Specifications*.

The base price index for asphalt binder for plant mix is **\$ 507.27** per ton.

This base price index represents an average of F.O.B. selling prices of asphalt binder at supplier's terminals on **September 1, 2021**.

MILLING ASPHALT PAVEMENT:

(1-15-19)

607

SP6 R59

Revise the *2018 Standard Specifications* as follows:

Page 6-5, Article 607-2, EQUIPMENT, lines 14-16, delete the seventh sentence of this Article and replace with the following:

Use either a non-contacting laser or sonar type ski system with a minimum of three referencing stations mounted on the milling machine at a length of at least 24 feet.

ASPHALT CONCRETE PLANT MIX PAVEMENTS:

(2-20-18) (Rev.1-15-19)

610, 1012

SP6 R65

Revise the *2018 Standard Specifications* as follows:

Page 6-14, Table 609-3, LIMITS OF PRECISION FOR TEST RESULTS, replace with the following:

Mix Property	Limits of Precision
25.0 mm sieve (Base Mix)	± 10.0%
19.0 mm sieve (Base Mix)	± 10.0%
12.5 mm sieve (Intermediate & Type P-57)	± 6.0%
9.5 mm sieve (Surface Mix)	± 5.0%
4.75 mm sieve (Surface Mix)	± 5.0%
2.36 mm sieve (All Mixes, except S4.75A)	± 5.0%
1.18 mm sieve (S4.75A)	± 5.0%
0.075 mm sieve (All Mixes)	± 2.0%
Asphalt Binder Content	± 0.5%
Maximum Specific Gravity (G_{mm})	± 0.020
Bulk Specific Gravity (G_{mb})	± 0.030
TSR	± 15.0%
QA retest of prepared QC Gyratory Compacted Volumetric Specimens	± 0.015
Retest of QC Core Sample	± 1.2% (% Compaction)
Comparison QA Core Sample	± 2.0% (% Compaction)
QA Verification Core Sample	± 2.0% (% Compaction)
Density Gauge Comparison of QC Test	± 2.0% (% Compaction)
QA Density Gauge Verification Test	± 2.0% (% Compaction)

Page 6-17, Table 610-1, MIXING TEMPERATURE AT THE ASPHALT PLANT, replace with the following:

Binder Grade	JMF Temperature
PG 58-28; PG 64-22	250 - 290°F
PG 76-22	300 - 325°F

Page 6-17, Subarticle 610-3(C), Job Mix Formula (JMF), lines 38-39, delete the fourth paragraph.

Page 6-18, Subarticle 610-3(C), Job Mix Formula (JMF), line 12, replace “SF9.5A” with “S9.5B”.

Page 6-18, Table 610-3, MIX DESIGN CRITERIA, replace with the following:

Mix Type	Design ESALs millions ^A	Binder PG Grade	Compaction Levels G _{mm} @	Max. Rut	Volumetric Properties ^B		
					VMA	VTM	VFA

			N _{ini}	N _{des}	Depth (mm)	% Min.	%	Min.-Max.	%G _{mm} @ N _{ini}
S4.75A	< 1	64 - 22	6	50	11.5	16.0	4.0 - 6.0	65 - 80	≤ 91.5
S9.5B	0 - 3	64 - 22	6	50	9.5	16.0	3.0 - 5.0	70 - 80	≤ 91.5
S9.5C	3 - 30	64 - 22	7	65	6.5	15.5	3.0 - 5.0	65 - 78	≤ 90.5
S9.5D	> 30	76 - 22	8	100	4.5	15.5	3.0 - 5.0	65 - 78	≤ 90.0
I19.0C	ALL	64 - 22	7	65	-	13.5	3.0 - 5.0	65 - 78	≤ 90.5
B25.0C	ALL	64 - 22	7	65	-	12.5	3.0 - 5.0	65 - 78	≤ 90.5
Design Parameter					Design Criteria				
All Mix Types	Dust to Binder Ratio (P _{0.075} / P _{be})				0.6 - 1.4 ^C				
	Tensile Strength Ratio (TSR) ^D				85% Min. ^E				

- A. Based on 20 year design traffic.
- B. Volumetric Properties based on specimens compacted to N_{des} as modified by the Department.
- C. Dust to Binder Ratio (P_{0.075} / P_{be}) for Type S4.75A is 1.0 - 2.0.
- D. NCDOT-T-283 (No Freeze-Thaw cycle required).
- E. TSR for Type S4.75A & B25.0C mixes is 80% minimum.

Page 6-19, Table 610-5, BINDER GRADE REQUIREMENTS (BASED ON RBR%), replace with the following:

**TABLE 610-5
BINDER GRADE REQUIREMENTS (BASED ON RBR%)**

Mix Type	%RBR ≤ 20%	21% ≤ %RBR ≤ 30%	%RBR ≥ 30%
S4.75A, S9.5B, S9.5C, I19.0C, B25.0C	PG 64-22	PG 64-22 ^A	PG-58-28
S9.5D, OGFC	PG 76-22 ^B	n/a	n/a

- A. If the mix contains any amount of RAS, the virgin binder shall be PG 58-28.
- B. Maximum Recycled Binder Replacement (%RBR) is 18% for mixes using PG 76-22 binder.

Page 6-20, Table 610-6, PLACEMENT TEMPERATURES FOR ASPHALT, replace with the following:

TABLE 610-6 PLACEMENT TEMPERATURES FOR ASPHALT	
Asphalt Concrete Mix Type	Minimum Surface and Air Temperature
B25.0C	35°F
I19.0C	35°F
S4.75A, S9.5B, S9.5C	40°F ^A
S9.5D	50°F

- A. For the final layer of surface mixes containing recycled asphalt shingles (RAS), the minimum surface and air temperature shall be 50°F.

Page 6-21, Article 610-8, SPREADING AND FINISHING, lines 34-35, delete the second sentence and replace with the following:

Use an MTV for all surface mix regardless of binder grade on Interstate, US Routes, and NC Routes (primary routes) that have 4 or more lanes and median divided.

Page 6-21, Article 610-8, SPREADING AND FINISHING, lines 36-38, delete the fourth sentence and replace with the following:

Use MTV for all ramps, loops, Y-line that have 4 or more lanes and are median divided, full width acceleration lanes, full width deceleration lanes, and full width turn lanes that are greater than 1000 feet in length.

Page 6-23, Table 610-7, DENSITY REQUIREMENTS, replace with the following:

TABLE 610-7 DENSITY REQUIREMENTS	
Mix Type	Minimum % G_{mm} (Maximum Specific Gravity)
S4.75A	85.0 ^A
S9.5B	90.0
S9.5C, S9.5D, I19.0C, B25.0C	92.0

- A. Compaction to the above specified density will be required when the S4.75A mix is applied at a rate of 100 lbs/sy or higher.

Page 6-24, Article 610-13, FINAL SURFACE TESTING, lines 35-36, delete the second sentence and replace with the following:

Final surface testing is not required on ramps, loops and turn lanes.

Page 6-26, Subarticle 610-13(A)(1), Acceptance for New Construction, lines 29-30, delete the second sentence and replace with the following:

Areas excluded from testing by the profiler may be tested using a 10-foot straightedge in accordance with Article 610-12.

Page 6-27, Subarticle 610-13(B), Option 2- North Carolina Hearne Straightedge, lines 41-46, delete the eighth and ninth sentence of this paragraph and replace with the following:

Take profiles over the entire length of the final surface travel lane pavement exclusive of structures, approach slabs, paved shoulders, tapers, or other irregular shaped areas of pavement, unless otherwise approved by the Engineer. Test in accordance with this provision all mainline travel lanes, full width acceleration or deceleration lanes and collector lanes.

Page 6-28, Subarticle 610-13(B), Option 2- North Carolina Hearne Straightedge, lines 1-2, delete these two lines.

Page 6-32, Article 610-16 MEASUREMENT AND PAYMENT, replace with the following:

Pay Item	Pay Unit
Asphalt Concrete Base Course, Type B25.0C	Ton
Asphalt Concrete Intermediate Course, Type I19.0C	Ton
Asphalt Concrete Surface Course, Type S4.75A	Ton
Asphalt Concrete Surface Course, Type S9.5B	Ton
Asphalt Concrete Surface Course, Type S9.5C	Ton
Asphalt Concrete Surface Course, Type S9.5D	Ton

Page 10-30, Table 1012-1, AGGREGATE CONSENSUS PROPERTIES, replace with the following:

**TABLE 1012-1
AGGREGATE CONSENSUS PROPERTIES^A**

Mix Type	Coarse Aggregate Angularity^B	Fine Aggregate Angularity % Minimum	Sand Equivalent % Minimum	Flat and Elongated 5 : 1 Ratio % Maximum
<i>Test Method</i>	<i>ASTM D5821</i>	<i>AASHTO T 304</i>	<i>AASHTO T 176</i>	<i>ASTM D4791</i>
S4.75A; S9.5B	75 / -	40	40	-
S9.5C; I19.0C; B25.0C	95 / 90	45	45	10
S9.5D	100 / 100	45	50	10
OGFC	100 / 100	45	45	10
UBWC	100 / 85	45	45	10

A. Requirements apply to the design aggregate blend.

B. 95 / 90 denotes that 95% of the coarse aggregate has one fractured face and 90% has 2 or more fractured faces.

AUTOMATED MACHINE GUIDANCE

(1-2-11)

801

SP8 R01

General

This Special Provision contains requirements to be followed if the Contractor elects to use Global Positioning System (GPS) machine control grading and shall be used in conjunction with Section 801 of the *Standard Specifications*. The use of this technology is referenced as Automated Machine Guidance (AMG).

All equipment using AMG shall be able to generate end results that meet the *Standard Specifications*. Perform test sections for each type of work to be completed with AMG to demonstrate that the system has the capability to achieve acceptable results. If acceptable results cannot be achieved, conform to the requirements for conventional stakeout.

The Contractor shall be responsible for all errors resulting from the use of AMG and shall correct deficiencies to the satisfaction of the Engineer at no cost to the Department.

Submittals

If the Contractor elects to use AMG, a Digital Terrain Model (DTM) of the design surface and all intermediate surfaces shall be developed and submitted to the Engineer for review.

At least 90 days prior to beginning grading operations, the Contractor shall submit to the Engineer an AMG work plan to include, but not limited to, proposed equipment, control software manufacturer and version, types of work to be completed using AMG, project site calibration report, repetitive calibration methods for construction equipment and rover units to be used for the

duration of the project, and local GPS base station to be used for broadcasting differential correction data to rover units (this may include the NC Network RTK). All surveys must be tied to existing project control as established by NCDOT.

Inspection

The Engineer will perform quality assurance checks of all work associated with AMG. If it is determined that work is not being performed in a manner that will assure accurate results, the Engineer may require corrective action at no cost to the Department.

The Contractor shall provide the Engineer with one GPS rover unit for use during the duration of the contract. The rover will be loaded with the same model that is used with the AMG and have the same capability as rover units used by the Contractor. The rover will be kept in the possession of the Engineer and will be returned to the Contractor upon completion of the contract. Any maintenance or repairs required for the rover will be the responsibility of the Contractor. Formal training of at least 8 hours shall be provided to the Engineer by the Contractor on the use of the proposed AMG system.

Subgrade and Base Controls

If the Contractor elects to use AMG for fine grading and placement of base or other roadway materials, the GPS shall be supplemented with a laser or robotic total station. Include details of the proposed system in the AMG work plan. In addition, the following requirements apply for the use of AMG for subgrade and base construction.

Provide control points at intervals along the project not to exceed 1,000 feet. The horizontal position of these points shall be determined by static GPS sessions or by traverse connection from the original base line control points. The elevation of these control points shall be established using differential leveling from project benchmarks, forming closed loops where practical. A copy of all new control point information shall be provided to the Engineer prior to construction activities.

Provide control points and conventional survey grade stakes at 500 foot intervals and at critical points such as, but not limited to, PCs, PTs, superelevation transition points, and other critical points as requested by the Engineer.

Provide hubs at the top of the finished subgrade at all hinge points on the cross section at 500 foot intervals. These hubs shall be established using conventional survey methods for use by the Engineer to check the accuracy of construction.

Measurement and Payment

No direct payment will be made for work required to utilize this provision. All work will be considered incidental to various grading operations.

SUPPLEMENTAL SURVEYING:

(4-20-21)

801

SP8 R03

Revise the *2018 Standard Specifications* as follows:

Page 8-7, Article 801-3 MEASUREMENT AND PAYMENT, lines 10-11, replace with the following:

Supplemental Surveying Office Calculations will be paid at the stated price of \$85.00 per hour. *Supplemental Field Surveying* will be paid at the stated price of \$145.00 per hour. The

GUARDRAIL END UNITS, TYPE - TL-3:

(4-20-04) (Rev. 7-1-17)

862

SP8 R65

Description

Furnish and install guardrail end units in accordance with the details in the plans, the applicable requirements of Section 862 of the *2018 Standard Specifications*, and at locations shown in the plans.

Materials

Furnish guardrail end units listed on the NCDOT [Approved Products List](https://apps.dot.state.nc.us/vendor/approvedproducts/) at <https://apps.dot.state.nc.us/vendor/approvedproducts/> or approved equal.

Prior to installation the Contractor shall submit to the Engineer:

- (A) FHWA acceptance letter for each guardrail end unit certifying it meets the requirements of the AASHTO Manual for Assessing Safety Hardware, Test Level 3, in accordance with Article 106-2 of the *2018 Standard Specifications*.
- (B) Certified working drawings and assembling instructions from the manufacturer for each guardrail end unit in accordance with Article 105-2 of the *2018 Standard Specifications*.

No modifications shall be made to the guardrail end unit without the express written permission from the manufacturer. Perform installation in accordance with the details in the plans, and details and assembling instructions furnished by the manufacturer.

Construction Methods

Guardrail end delineation is required on all approach and trailing end sections for both temporary and permanent installations. Guardrail end delineation consists of yellow reflective sheeting applied to the entire end section of the guardrail in accordance with Article 1088-3 of the *2018 Standard Specifications* and is incidental to the cost of the guardrail end unit.

Measurement and Payment

Measurement and payment will be made in accordance with Article 862-6 of the *2018 Standard Specifications*.

Payment will be made under:

Pay Item

Guardrail End Units, Type TL-3

Pay Unit

Each

TREE PROTECTION FENCE:

General: “Tree Protection Fence” consists of furnishing, installing, maintaining, and removing wood or steel post, yellow poly-barricade fence fabric and signs at locations directed by the Engineer in the field and in accordance with the special provisions included herein. **Tree protection fence will be installed after the slope-stake line is staked and prior to all other work.**

Materials: Use *wood posts* that are nominal 4" x 4", length as required, structural light framing, grade No. 2, Southern Pine or *steel posts* that are a minimum of 1 3/8" wide measured parallel to the fence, with a weight of 1.25 lb./ft. of length. Post must have a means for retaining wire in desired position without displacement. Use of steel posts will be required in any area where the tree protection fence is in close proximity to the tree's trunk or any major roots.

Use neon lime/yellow polyethylene or polypropylene prefabricated safety/barricade type fence fabric that is a minimum of 48 inches high and approved by the Engineer.

Treat wood posts if used, with a preservative in accordance with Section 1082 of the *Standard Specifications*.

Use a durable, weatherproof lightweight material to fabricate ‘Tree Protection Area’ signs. Signs will be a minimum of five square feet and lettering will be a minimum of two inches tall and text will be clearly legible. Each sign will contain the following wording in both English and Spanish on the same sign:

**TREE PROTECTION AREA
DO NOT ENTER**

Use a red background with white lettering. **Submit sample sign to the Engineer for approval prior to installation.**

Installation: Erect fence to conform to the general contour of the ground. Do not remove existing plant material or perform any grading unless indicated on the plans or directed by the Engineer. Avoid soil compaction within tree protection area; do not use heavy equipment and stay outside the perimeter of the tree protection area where possible.

Install posts and maintain in a vertical position. Post may be hand set or set with a post driver. If hand set tamp backfill material thoroughly. Power driven wood posts may be sharpened to a dull point. Remove and replace posts damaged by power driving prior to final acceptance. At the direction of the Engineer use steel post instead of wood post when installing fence in close proximity to a tree's trunk or any major roots.

Stretch neon lime/yellow safety/barricade fence fabric taut and attach to post with appropriate means according to post type used. In sections where signs will be located, reinforce top of fabric by weaving a 12 gauge galvanized wire in the fabric and firmly attach to a post at each end of the section. Attach signs to fence fabric at all four corners. Locate signs every one hundred feet, at all corners, changes in direction and as directed by the Engineer.

Maintenance: Maintain tree protection fence with required signs in good condition, fully upright with no loose attachments or missing links for the duration of the project. Signs must be visible and legible throughout the duration of the contract. *The Engineer must approve in writing, prior to entering the tree protection area, access for the contractor and subcontractor for anything other than routine vegetation maintenance and litter pick-up.* Approval must be made for each access occurrence.

Removal: As a last item of work after construction and all related work is complete, and at the direction of the Engineer, remove the tree protection fence, backfill post holes and remove, and properly dispose of fence materials off the construction site. While performing this work do not use heavy equipment and stay on the outside perimeter of the tree protection area where possible to avoid soil compaction within root zone.

Method of Measurement: Tree protection fence to be paid for will be the actual number of linear feet installed in place and accepted.

Basis of Payment: The quantity of tree protection fence will be paid for at the contract unit price per linear foot. Such payment will be full compensation for the work as described above, including but not limited to furnishing, installing, maintaining and removing the tree protection fence and signs.

Payment will be made under

Tree Protection Fence.....LF

FOUNDATIONS AND ANCHOR ROD ASSEMBLIES FOR METAL POLES:

(1-17-12) (Rev. 1-16-18)

9, 14, 17

SP9 R05

Description

Foundations for metal poles include foundations for signals, cameras, overhead and dynamic message signs (DMS) and high mount and light standards supported by metal poles or upright trusses. Foundations consist of footings with pedestals and drilled piers with or without grade beams or wings. Anchor rod assemblies consist of anchor rods (also called anchor bolts) with nuts and washers on the exposed ends of rods and nuts and a plate or washers on the other ends of rods embedded in the foundation.

Construct concrete foundations with the required resistances and dimensions and install anchor rod assemblies in accordance with the contract and accepted submittals. Construct drilled piers consisting of cast-in-place reinforced concrete cylindrical sections in excavated holes. Provide temporary casings or polymer slurry as needed to stabilize drilled pier excavations. Use a prequalified Drilled Pier Contractor to construct drilled piers for metal poles. Define “excavation” and “hole” as a drilled pier excavation and “pier” as a drilled pier.

This provision does not apply to foundations for signal pedestals; see Section 1743 of the 2018 Standard Specifications and 2018 Roadway Standard Drawing No. 1743.01.

Materials

Refer to the *2018 Standard Specifications*.

Item	Section
Conduit	1091-3
Grout, Type 2	1003
Polymer Slurry	411-2(B)(2)
Portland Cement Concrete	1000
Reinforcing Steel	1070
Rollers and Chairs	411-2(C)
Temporary Casings	411-2(A)

Provide Type 3 material certifications in accordance with Article 106-3 of the *2018 Standard Specifications* for conduit, rollers, chairs and anchor rod assemblies. Store steel materials on blocking at least 12" above the ground and protect it at all times from damage; and when placing in the work make sure it is free from dirt, dust, loose mill scale, loose rust, paint, oil or other foreign materials. Load, transport, unload and store foundation and anchor rod assembly materials so materials are kept clean and free of damage. Bent, damaged or defective materials will be rejected.

Use conduit type in accordance with the contract. Use Class A concrete for footings and pedestals, Class Drilled Pier concrete for drilled piers and Class AA concrete for grade beams and wings including portions of drilled piers above bottom of wings elevations. Corrugated temporary casings may be accepted at the discretion of the Engineer. A list of approved polymer slurry products is available from:

connect.ncdot.gov/resources/Geological/Pages/Products.aspx

Provide anchor rod assemblies in accordance with the contract consisting of the following:

- (A) Straight anchor rods,
- (B) Heavy hex top and leveling nuts and flat washers on exposed ends of rods, and
- (C) Nuts and either flat plates or washers on the other ends of anchor rods embedded in foundations.

Do not use lock washers. Use steel anchor rods, nuts and washers that meet ASTM F1554 for Grade 55 rods and Grade A nuts. Use steel plates and washers embedded in concrete with a thickness of at least 1/4". Galvanize anchor rods and exposed nuts and washers in accordance with Article 1076-4 of the *2018 Standard Specifications*. It is not necessary to galvanize nuts, plates and washers embedded in concrete.

Construction Methods

Install the required size and number of conduits in foundations in accordance with the plans and accepted submittals. Construct top of piers, footings, pedestals, grade beams and wings flat, level and within 1" of elevations shown in the plans or approved by the Engineer. Provide an Ordinary Surface finish in accordance with Subarticle 825-6(B) of the *2018 Standard Specifications* for

portions of foundations exposed above finished grade. Do not remove anchor bolt templates or pedestal or grade beam forms or erect metal poles or upright trusses onto foundations until concrete attains a compressive strength of at least 3,000 psi.

(A) Drilled Piers

Before starting drilled pier construction, hold a predrill meeting to discuss the installation, monitoring and inspection of the drilled piers. Schedule this meeting after the Drilled Pier Contractor has mobilized to the site. The Resident or Division Traffic Engineer, Contractor and Drilled Pier Contractor Superintendent will attend this predrill meeting.

Do not excavate holes, install piles or allow equipment wheel loads or vibrations within 20 ft of completed piers until 16 hours after Drilled Pier concrete reaches initial set.

Check for correct drilled pier alignment and location before beginning drilling. Check plumbness of holes frequently during drilling.

Construct drilled piers with the minimum required diameters shown in the plans. Install piers with tip elevations no higher than shown in the plans or approved by the Engineer.

Excavate holes with equipment of the sizes required to construct drilled piers. Depending on the subsurface conditions encountered, drilling through rock and boulders may be required. Do not use blasting for drilled pier excavations.

Contain and dispose of drilling spoils and waste concrete as directed and in accordance with Section 802 of the *2018 Standard Specifications*. Drilling spoils consist of all materials and fluids removed from excavations.

If unstable, caving or sloughing materials are anticipated or encountered, stabilize holes with temporary casings and/or polymer slurry. Do not use telescoping temporary casings. If it becomes necessary to replace a temporary casing during drilling, backfill the excavation, insert a larger casing around the casing to be replaced or stabilize the excavation with polymer slurry before removing the temporary casing.

If temporary casings become stuck or the Contractor proposes leaving casings in place, temporary casings should be installed against undisturbed material. Unless otherwise approved, do not leave temporary casings in place for mast arm poles and cantilever signs. The Engineer will determine if casings may remain in place. If the Contractor proposes leaving temporary casings in place, do not begin drilling until a casing installation method is approved.

Use polymer slurry and additives to stabilize holes in accordance with the slurry manufacturer's recommendations. Provide mixing water and equipment suitable for polymer slurry. Maintain the required slurry properties at all times except for sand content.

Define a "sample set" as slurry samples collected from mid-height and within 2 ft of the bottom of holes. Take sample sets from excavations to test polymer slurry immediately after filling holes with slurry, at least every 4 hours thereafter and immediately before

placing concrete. Do not place Drilled Pier concrete until both slurry samples from an excavation meet the required polymer slurry properties. If any slurry test results do not meet the requirements, the Engineer may suspend drilling until both samples from a sample set meet the required polymer slurry properties.

Remove soft and loose material from bottom of holes using augers to the satisfaction of the Engineer. Assemble rebar cages and place cages and Drilled Pier concrete in accordance with Subarticle 411-4(E) of the *2018 Standard Specifications* except for the following:

- (1) Inspections for tip resistance and bottom cleanliness are not required,
- (2) Temporary casings may remain in place if approved, and
- (3) Concrete placement may be paused near the top of pier elevations for anchor rod assembly installation and conduit placement or
- (4) If applicable, concrete placement may be stopped at bottom of grade beam or wings elevations for grade beam or wing construction.

If wet placement of concrete is anticipated or encountered, do not place Drilled Pier concrete until a concrete placement procedure is approved. If applicable, temporary casings and fluids may be removed when concrete placement is paused or stopped in accordance with the exceptions above provided holes are stable. Remove contaminated concrete from exposed Drilled Pier concrete after removing casings and fluids. If holes are unstable, do not remove temporary casings until a procedure for placing anchor rod assemblies and conduit or constructing grade beams or wings is approved.

Use collars to extend drilled piers above finished grade. Remove collars after Drilled Pier concrete sets and round top edges of piers.

If drilled piers are questionable, pile integrity testing (PIT) and further investigation may be required in accordance with Article 411-5 of the *2018 Standard Specifications*. A drilled pier will be considered defective in accordance with Subarticle 411-5(D) of the *2018 Standard Specifications* and drilled pier acceptance is based in part on the criteria in Article 411-6 of the *2018 Standard Specifications* except for the top of pier tolerances in Subarticle 411-6(C) of the *2018 Standard Specifications*.

If a drilled pier is under further investigation, do not grout core holes, backfill around the pier or perform any work on the drilled pier until the Engineer accepts the pier. If the drilled pier is accepted, dewater and grout core holes and backfill around the pier with approved material to finished grade. If the Engineer determines a pier is unacceptable, remediation is required in accordance with Article 411-6 of the *2018 Standard Specifications*. No extension of completion date or time will be allowed for remediation of unacceptable drilled piers or post repair testing.

Permanently embed a plate in or mark top of piers with the pier diameter and depth, size and number of vertical reinforcing bars and the minimum compressive strength of the concrete mix at 28 days.

(B) Footings, Pedestals, Grade Beams and Wings

Excavate as necessary for footings, grade beams and wings in accordance with the plans, accepted submittals and Section 410 of the *2018 Standard Specifications*. If unstable, caving or sloughing materials are anticipated or encountered, shore foundation excavations as needed with an approved method. Notify the Engineer when foundation excavation is complete. Do not place concrete or reinforcing steel until excavation dimensions and foundation material are approved.

Construct cast-in-place reinforced concrete footings, pedestals, grade beams and wings with the dimensions shown in the plans and in accordance with Section 825 of the *2018 Standard Specifications*. Use forms to construct portions of pedestals and grade beams protruding above finished grade. Provide a chamfer with a 3/4" horizontal width for pedestal and grade beam edges exposed above finished grade. Place concrete against undisturbed soil or backfill and fill in accordance with Article 410-8 of the *2018 Standard Specifications*. Proper compaction around footings and wings is critical for foundations to resist uplift and torsion forces.

(C) Anchor Rod Assemblies

Size anchor rods for design and the required projection above top of foundations. Determine required anchor rod projections from nut, washer and base plate thicknesses, the protrusion of 3 to 5 anchor rod threads above top nuts after tightening and the distance of one nut thickness between top of foundations and bottom of leveling nuts.

Protect anchor rod threads from damage during storage and installation of anchor rod assemblies. Before placing anchor rods in foundations, turn nuts onto and off rods past leveling nut locations. Turn nuts with the effort of one workman using an ordinary wrench without a cheater bar. Report any thread damage to the Engineer that requires extra effort to turn nuts.

Arrange anchor rods symmetrically about center of base plate locations as shown in the plans. Set anchor rod elevations based on required projections above top of foundations. Securely brace and hold rods in the correct position, orientation and alignment with a steel template. Do not weld to reinforcing steel, temporary casings or anchor rods.

Install top and leveling (bottom) nuts, washers and the base plate for each anchor rod assembly in accordance with the following procedure:

- (1) Turn leveling nuts onto anchor rods to a distance of one nut thickness between the top of foundation and bottom of leveling nuts. Place washers over anchor rods on top of leveling nuts.
- (2) Determine if nuts are level using a flat rigid template on top of washers. If necessary, lower leveling nuts to level the template in all directions or if applicable, lower nuts to tilt the template so the metal pole or upright truss will lean as shown in the plans. If leveling nuts and washers are not in full contact with the template, replace washers with galvanized beveled washers.

- (3) Verify the distance between the foundation and leveling nuts is no more than one nut thickness.
- (4) Place base plate with metal pole or upright truss over anchor rods on top of washers. High mount luminaires may be attached before erecting metal poles but do not attach cables, mast arms or trusses to metal poles or upright trusses at this time.
- (5) Place washers over anchor rods on top of base plate. Lubricate top nut bearing surfaces and exposed anchor rod threads above washers with beeswax, paraffin or other approved lubricant.
- (6) Turn top nuts onto anchor rods. If nuts are not in full contact with washers or washers are not in full contact with the base plate, replace washers with galvanized beveled washers.
- (7) Tighten top nuts to snug-tight with the full effort of one workman using a 12" wrench. Do not tighten any nut all at once. Turn top nuts in increments. Follow a star pattern cycling through each nut at least twice.
- (8) Repeat (7) for leveling nuts.
- (9) Replace washers above and below the base plate with galvanized beveled washers if the slope of any base plate face exceeds 1:20 (5%), any washer is not in firm contact with the base plate or any nut is not in firm contact with a washer. If any washers are replaced, repeat (7) and (8).
- (10) With top and leveling nuts snug-tight, mark each top nut on a corner at the intersection of 2 flats and a corresponding reference mark on the base plate. Mark top nuts and base plate with ink or paint that is not water-soluble. Use the turn-of-nut method for pretensioning. Do not pretension any nut all at once. Turn top nuts in increments for a total turn that meets the following nut rotation requirements:

NUT ROTATION REQUIREMENTS (Turn-of-Nut Pretensioning Method)	
Anchor Rod Diameter, inch	Requirement
$\leq 1 \frac{1}{2}$	1/3 turn (2 flats)
$> 1 \frac{1}{2}$	1/6 turn (1 flat)

Follow a star pattern cycling through each top nut at least twice.

- (11) Ensure nuts, washers and base plate are in firm contact with each other for each anchor rod. Cables, mast arms and trusses may now be attached to metal poles and upright trusses.
- (12) Between 4 and 14 days after pretensioning top nuts, use a torque wrench calibrated within the last 12 months to check nuts in the presence of the Engineer. Completely erect mast arm poles and cantilever signs and attach any hardware before checking top nuts for these structures. Check that top nuts meet the following torque requirements:

TORQUE REQUIREMENTS	
Anchor Rod Diameter, inch	Requirement, ft-lb
7/8	180
1	270
1 1/8	380
1 1/4	420
$\geq 1 \frac{1}{2}$	600

If necessary, retighten top nuts in the presence of the Engineer with a calibrated torque wrench to within ± 10 ft-lb of the required torque. Do not overtighten top nuts.

- (13) Do not grout under base plate.

Measurement and Payment

Foundations and anchor rod assemblies for metal poles and upright trusses will be measured and paid for elsewhere in the contract.

No payment will be made for temporary casings that remain in drilled pier excavations. No payment will be made for PIT. No payment will be made for further investigation of defective piers. Further investigation of piers that are not defective will be paid as extra work in accordance with Article 104-7 of the *2018 Standard Specifications*. No payment will be made for remediation of unacceptable drilled piers or post repair testing.

PORTLAND CEMENT CONCRETE PRODUCTION AND DELIVERY:

(9-15-20)

1000, 1014, 1024

SP10 R01

Revise the *2018 Standard Specifications* as follows:

Page 10-6, Table 1000-1, REQUIREMENTS FOR CONCRETE, replace with the following:

Class of Concrete	Min. Compressive Strength at 28 days	Maximum Water-Cement Ratio				Consistency Maximum Slump		Cement Content			
		Air-Entrained Concrete		Non-Air-Entrained Concrete		Vibrated	Non-Vibrated	Vibrated		Non-Vibrated	
		Rounded Aggregate	Angular Aggregate	Rounded Aggregate	Angular Aggregate			Min.	Max.	Min.	Max.
		Units	psi					inch	inch	lb/cy	lb/cy
AA	4500	0.381	0.426	---	---	3.5 ^A	---	639	715	---	---
AA Slip Form	4500	0.381	0.426	---	---	1.5	---	639	715	---	---
Drilled Pier	4500	---	---	0.450	0.450	---	5 - 7 dry 7 - 9 wet	---	---	640	800
A	3000	0.488	0.532	0.550	0.594	3.5 ^A	4.0	564	---	602	---
B	2500	0.488	0.567	0.559	0.630	1.5 machine placed 2.5 ^A hand placed	4.0	508	---	545	---
Sand Light-weight	4500	---	0.420	---	---	4.0 ^A	---	715	---	---	---

Latex Modified	3000 (at 7 days)	0.400	0.400	---	---	6.0	---	658	---	---	---
Flowable Fill excavatable	150 max. (at 56 days)	as needed	as needed	as needed	as needed	---	Flowable	---	---	40	100
Flowable Fill non-excavatable	125	as needed	as needed	as needed	as needed	---	Flowable	---	---	100	as needed
Pavement	4500 Design, field 650 flexural, design only	0.559	0.559	---	---	1.5 slip form 3.0 hand placed	---	526	---	---	---
Precast	See Table 1077-1	as needed	as needed	---	---	6.0	as needed	as needed	as needed	as needed	as needed
Prestressed	per contract	See Table 1078-1	See Table 1078-1	---	---	8.0	---	564	as needed	---	---

- A. The slump may be increased to 6 inches, provided the increase in slump is achieved by adding a chemical admixture conforming to Section 1024-3. In no case shall the water-cement ratio on the approved design be exceeded. Concrete exhibiting segregation and/or excessive bleeding will be rejected. Utilizing an Admixture to modify slump does not relinquish the contractor's responsibility to ensure the final product quality and overall configuration meets design specifications. Caution should be taken when placing these modified mixes on steep grades to prevent unintended changes to the set slope.

HIGH STRENGTH CONCRETE FOR DRIVEWAYS:

(11-21-00) (Rev. 1-17-12)

848

SP10 R02

Use high early strength concrete for all driveways shown in the plans and as directed by the Engineer. Provide high early strength concrete that meets the requirements of Article 1000-5 of the *2018 Standard Specifications*.

Measurement and payment will be in accordance with Section 848 of the *2018 Standard Specifications*.

THERMOPLASTIC PAVEMENT MARKING MATERIAL – COLOR TESTING:

3-19-19

1087

SP10 R05

Revise the *2018 Standard Specifications* as follows:

Pages 10-183 and 10-184, Subarticle 1087-7(D)(1)(b) Yellow, lines 9-11, delete and replace with the following:

Obtain Color Values Y,x,y per ASTM E1349 using C/2° illuminant/observer. Results shall be $Y \geq 45\%$, and x,y shall fall within PR#1 chart chromaticity limits.

MATERIALS FOR PORTLAND CEMENT CONCRETE:

(9-15-20)

1000, 1024

SP10 R24

Revise the *2018 Standard Specifications* as follows:

Page 10-52, Article 1024-4, WATER, lines 3-6, delete and replace with the following:

Test water from wells at all locations. Test public water supplies from all out of state locations and in the following counties: Beaufort, Bertie, Brunswick, Camden, Carteret, Chowan, Craven, Currituck, Dare, Gates, Hyde, New Hanover, Onslow, Pamlico, Pasquotank, Pender, Perquimans, Tyrell and Washington unless the Engineer waives the testing requirements.

Page 10-52, Table 1024-2, PHYSICAL PROPERTIES OF WATER, replace with the following:

Property	Requirement	Test Method
Compression Strength, minimum percent of control at 3 and 7 days	90%	ASTM C1602
Time of set, deviation from control	From 1:00 hr. earlier to 1:30 hr. later	ASTM C1602
pH	4.5 to 8.5	ASTM D1293 *
Chloride Ion Content, Max.	250 ppm	ASTM D512 *
Total Solids Content (Residue), Max.	1,000 ppm	SM 2540B *
Resistivity, Min.	0.500 kohm-cm	ASTM D1125 *

*Denotes an alternate method is acceptable. Test method used shall be referenced in the test report.

TEMPORARY SHORING:

(2-20-07) (Rev. 10-19-21)

SP11 R02

Description

Temporary shoring includes cantilever, braced and anchored shoring and temporary mechanically stabilized earth (MSE) walls. Temporary shoring does not include trench boxes. At the Contractor's option, use any type of temporary shoring unless noted otherwise in the plans or as directed. Design and construct temporary shoring based on actual elevations and shoring dimensions in accordance with the contract and accepted submittals. Construct temporary shoring at locations shown in the plans and as directed. Temporary shoring is required to maintain traffic when a 2:1 (H:V) slope from the top of an embankment or bottom of an excavation will intersect the existing ground line less than 5 feet from the edge of pavement of an open travelway. This provision does not apply to pipe, inlet or utility installation unless noted otherwise in the plans.

Positive protection includes concrete barrier and temporary guardrail. Provide positive protection for temporary shoring at locations shown in the plans and as directed. Positive protection is required if temporary shoring is located in the clear zone in accordance with the *AASHTO Roadside Design Guide*.

(A) Cantilever and Braced Shoring

Cantilever shoring consists of steel sheet piles or H-piles with timber lagging. Braced

shoring consists of sheet piles or H-piles with timber lagging and bracing such as beams, plates, walers, struts, rakers, etc. Define “piles” as sheet piles or H-piles.

(B) Anchored Shoring

Anchored shoring consists of sheet piles with walers or H-piles with timber lagging anchored with ground or helical anchors. Driven anchors may be accepted at the discretion of the Engineer. A ground anchor consists of a grouted steel bar or multi-strand tendon with an anchorage. A helical anchor consists of a lead section with a central steel shaft and at least one helix steel plate followed by extensions with only central shafts (no helixes) and an anchorage. Anchorages consist of steel bearing plates with washers and hex nuts for bars or steel wedge plates and wedges for strands. Use a prequalified Anchored Wall Contractor to install ground anchors. Define “anchors” as ground, helical or driven anchors.

(C) Temporary MSE Walls

Temporary MSE walls include temporary geosynthetic and wire walls. Define “temporary wall” as a temporary MSE wall and “Temporary Wall Vendor” as the vendor supplying the temporary MSE wall. Define “reinforcement” as geotextile, geogrid, geostrip, welded wire grid or metallic strip reinforcement.

Temporary geosynthetic walls consist of geotextiles or geogrids wrapped behind welded wire facing or geostrips connected to welded wire facing. Define “temporary geotextile wall” as a temporary geosynthetic wall with geotextile reinforcement, “temporary geogrid wall” as a temporary geosynthetic wall with geogrid reinforcement and “temporary geostrip wall” as a temporary geosynthetic wall with geostrip reinforcement.

Temporary wire walls consist of welded wire grid or metallic strip reinforcement connected to welded wire facing. Define “Wire Wall Vendor” as the vendor supplying the temporary wire wall.

(D) Embedment

Define “embedment” for cantilever, braced and anchored shoring as the pile depth below the grade in front of shoring. Define “embedment” for temporary walls as the wall embedment below the grade at the wall face.

(E) Positive Protection

Define “unanchored or anchored portable concrete barrier” as portable concrete barrier (PCB) that meets 2018 Roadway Standard Drawing No. 1170.01. Define “concrete barrier” as unanchored or anchored PCB or an approved equal. Define “temporary guardrail” as temporary steel beam guardrail that meets 2018 Roadway Standard Drawing No. 862.02.

Materials

Refer to the *2018 Standard Specifications*.

Item	Section
Concrete Barrier Materials	1170-2
Flowable Fill, Excavatable	1000-6
Geosynthetics	1056
Grout, Type 1	1003
Portland Cement	1024-1
Portland Cement Concrete	1000
Select Materials	1016
Steel Beam Guardrail Materials	862-2
Steel Plates	1072-2
Steel Sheet Piles and H-Piles	1084
Untreated Timber	1082-2
Water	1024-4
Welded Wire Reinforcement	1070-3

Provide Type 6 material certifications for shoring materials in accordance with Article 106-3 of the *2018 Standard Specifications*. Use Class IV select material for temporary guardrail and Class A concrete that meets Article 450-2 of the *2018 Standard Specifications* or Type 1 grout for drilled-in piles. Provide untreated timber with a thickness of at least 3 inches and a bending stress of at least 1,000 pounds per square inch for timber lagging. Provide steel bracing that meets ASTM A36.

(A) Shoring Backfill

Use Class II, Type 1, Class III, Class V or Class VI select material or material that meets AASHTO M 145 for soil classification A-2-4 with a maximum PI of 6 for shoring backfill except do not use A-2-4 soil for backfill around culverts.

(B) Anchors

Store anchor materials on blocking a minimum of 12 inches above the ground and protect it at all times from damage; and when placing in the work make sure it is free from dirt, dust, loose mill scale, loose rust, paint, oil or other foreign materials. Load, transport, unload and store anchor materials so materials are kept clean and free of damage. Bent, damaged or defective materials will be rejected.

(1) Ground Anchors

Use high-strength deformed steel bars that meet AASHTO M 275 or seven-wire strands that meet ASTM A886 or Article 1070-5 of the *2018 Standard Specifications*. Splice bars in accordance with Article 1070-9 of the *2018 Standard Specifications*. Do not splice strands. Use bondbreakers, spacers and centralizers that meet Article 6.3.5 of the *AASHTO LRFD Bridge Construction Specifications*.

Use neat cement grout that only contains cement and water with a water cement ratio of 0.4 to 0.5 which is approximately 5.5 gallons of water per 94 pounds of

Portland cement. Provide grout with a compressive strength at 3 and 28 days of at least 1,500 and 4,000 psi, respectively.

(2) Helical Anchors

Use helical anchors with an ICC Evaluation Service, Inc. (ICC-ES) report. Provide couplers, thread bar adapters and bolts recommended by the Anchor Manufacturer to connect helical anchors together and to piles.

(3) Anchorages

Provide steel plates for bearing plates and steel washers, hex nuts, wedge plates and wedges recommended by the Anchor Manufacturer.

(C) Temporary Walls

(1) Welded Wire Facing

Use welded wire reinforcement for welded wire facing, struts and wires. For temporary wire walls, provide welded wire facing supplied by the Wire Wall Vendor or a manufacturer approved or licensed by the vendor. For temporary wire walls with separate reinforcement and facing components, provide connectors (e.g., bars, clamps, plates, etc.) and fasteners (e.g., bolts, nuts, washers, etc.) required by the Wire Wall Vendor.

(2) Geotextiles

Provide Type 2 geotextile for separation and retention geotextiles. Provide Type 5 geotextile for geotextile reinforcement with ultimate tensile strengths in accordance with the accepted submittals.

(3) Geogrid and Geostrip Reinforcement

Use geogrids with a roll width of at least 4 feet. Use geogrids for geogrid reinforcement and geostrips for geostrip reinforcement with an “approved” status code in accordance with the NCDOT Geosynthetic Reinforcement Evaluation Program. The list of approved geogrids and geostrips is available from: connect.ncdot.gov/resources/Geological/Pages/Products.aspx

Provide geogrids and geostrips with design strengths in accordance with the accepted submittals. Geogrids and geostrips are approved for short-term design strengths (3-year design life) in the machine direction (MD) and cross-machine direction (CD) based on material type. Define material type from the website above for shoring backfill as follows:

Material Type	Shoring Backfill
Borrow	A-2-4 Soil
Fine Aggregate	Class II, Type 1 or Class III Select Material

Coarse Aggregate

Class V or VI Select Material

(4) Welded Wire Grid and Metallic Strip Reinforcement

Provide welded wire grid and metallic strip reinforcement supplied by the Wire Wall Vendor or a manufacturer approved or licensed by the vendor. Use welded wire grid reinforcement (“mesh”, “mats” and “ladders”) that meet Article 1070-3 of the *2018 Standard Specifications* and metallic strip reinforcement (“straps”) that meet ASTM A572 or A1011.

Preconstruction Requirements

(A) Concrete Barrier

Define “clear distance” behind concrete barrier as the horizontal distance between the barrier and edge of pavement. The minimum required clear distance for concrete barrier is shown in the plans. At the Contractor’s option or if the minimum required clear distance is not available, set concrete barrier next to and up against traffic side of temporary shoring except for barrier above temporary walls. Concrete barrier with the minimum required clear distance is required above temporary walls.

(B) Temporary Guardrail

Define “clear distance” behind temporary guardrail as the horizontal distance between guardrail posts and temporary shoring. At the Contractor’s option or if clear distance for cantilever, braced and anchored shoring is less than 4 feet, attach guardrail to traffic side of shoring as shown in the plans. Place ABC in clear distance and around guardrail posts instead of pavement. Do not use temporary guardrail above temporary walls.

(C) Temporary Shoring Designs

Before beginning temporary shoring design, survey existing ground elevations in the vicinity of shoring locations to determine actual design heights (H). Submit PDF files of working drawings and design calculations for temporary shoring designs in accordance with Article 105-2 of the *2018 Standard Specifications*. Submit working drawings showing plan views, shoring profiles, typical sections and details of temporary shoring design and construction sequence. Do not begin shoring construction until a design submittal is accepted.

Have cantilever and braced shoring designed, detailed and sealed by an engineer licensed in the state of North Carolina. Use a prequalified Anchored Wall Design Consultant to design anchored shoring. Provide anchored shoring designs sealed by a Design Engineer approved as a Geotechnical Engineer (key person) for an Anchored Wall Design Consultant. Include details in anchored shoring working drawings of anchor locations and lock-off loads, unit grout/ground bond strengths for ground anchors or minimum installation torque and torsional strength rating for helical anchors and if necessary, obstructions extending through shoring or interfering with anchors. Include details in the anchored shoring construction sequence of pile and anchor installation, excavation and

anchor testing.

Provide temporary wall designs sealed by a Design Engineer licensed in the state of North Carolina and employed or contracted by the Temporary Wall Vendor. Include details in temporary wall working drawings of geotextile and reinforcement types, locations and directions and obstructions extending through walls or interfering with reinforcement.

(1) Soil Parameters

Design temporary shoring for the assumed soil parameters and groundwater or flood elevations shown in the plans. Assume the following soil parameters for shoring backfill:

(a) Unit weight (γ) = 120 pcf,

(b)	Friction Angle (ϕ)	Shoring Backfill
	30°	A-2-4 Soil
	34°	Class II, Type 1 or Class III Select Material
	38°	Class V or VI Select Material

(c) Cohesion (c) = 0 psf.

(2) Traffic Surcharge

Design temporary shoring for a traffic surcharge of 250 pounds per square foot if traffic will be above and within H of shoring. This traffic surcharge does not apply to construction traffic. Design temporary shoring for any construction surcharge if construction traffic will be above and within H of shoring. Design temporary shoring for a traffic (live load) surcharge in accordance with Article 11.5.6 of the *AASHTO LRFD Bridge Design Specifications*.

(3) Cantilever, Braced and Anchored Shoring Designs

Use shoring backfill for fill sections and voids between cantilever, braced and anchored shoring and the critical failure surface. Use concrete or Type 1 grout for embedded portions of drilled-in H-piles. Do not use drilled-in sheet piles.

Define “top of shoring” for cantilever, braced and anchored shoring as where the grade intersects the back of sheet piles or H-piles and timber lagging. Design cantilever, braced and anchored shoring for a traffic impact load of 2,000 pounds per foot applied 18 inches above top of shoring if concrete barrier is above and next to shoring or temporary guardrail is above and attached to shoring. Extend cantilever, braced and anchored shoring at least 32 inches above top of shoring if shoring is designed for traffic impact. Otherwise, extend shoring at least 6 inches above top of shoring.

Design cantilever, braced and anchored shoring for a maximum deflection of 3 inches if the horizontal distance to the closest edge of pavement or structure is less

than H. Otherwise, design shoring for a maximum deflection of 6 inches. Design cantilever and braced shoring in accordance with the plans and *AASHTO Guide Design Specifications for Bridge Temporary Works*.

Design anchored shoring in accordance with the plans and Article 11.9 of the *AASHTO LRFD Bridge Design Specifications*. Use a resistance factor of 0.80 for tensile resistance of anchors with bars, strands or shafts. Extend the unbonded length for ground anchors and the shallowest helix for helical anchors at least 5 feet behind the critical failure surface. Do not extend anchors beyond right-of-way or easement limits. If existing or future obstructions such as foundations, guardrail posts, pavements, pipes, inlets or utilities will interfere with anchors, maintain a clearance of at least 6 inches between obstructions and anchors.

(4) Temporary Wall Designs

Use shoring backfill in the reinforced zone of temporary walls. Separation geotextiles are required between shoring backfill and backfill, natural ground or culverts along the sides of the reinforced zone perpendicular to the wall face. For Class V or VI select material in the reinforced zone, separation geotextiles are also required between shoring backfill and backfill or natural ground on top of and at the back of the reinforced zone.

Design temporary walls in accordance with the plans and Article 11.10 of the *AASHTO LRFD Bridge Design Specifications*. Embed temporary walls at least 18 inches except for walls on structures or rock as determined by the Engineer. Use a uniform reinforcement length throughout the wall height of at least 0.7H or 6 feet, whichever is longer. Extend the reinforced zone at least 6 inches beyond end of reinforcement. Do not locate the reinforced zone outside right-of-way or easement limits.

Use the simplified method for determining maximum reinforcement loads in accordance with the AASHTO LRFD specifications. For geotextile reinforcement, use geotextile properties approved by the Department or default values in accordance with the AASHTO LRFD specifications. For geogrid and geostrip reinforcement, use approved geosynthetic reinforcement properties available from the website shown elsewhere in this provision. Use geosynthetic properties for the direction reinforcement will be installed, a 3-year design life and shoring backfill to be used in the reinforced zone.

Do not use more than 4 different reinforcement strengths for each temporary geosynthetic wall. Design temporary geotextile walls for a reinforcement coverage ratio (R_c) of 1.0. For temporary geogrid walls with an R_c of less than 1.0, use a maximum horizontal clearance between geogrids of 3 feet and stagger reinforcement so geogrids are centered over gaps in the reinforcement layer below.

For temporary geosynthetic walls, use “L” shaped welded wire facing with 18 to 24 inch long legs. Locate geosynthetic reinforcement so reinforcement layers are at the same level as the horizontal legs of welded wire facing. Use vertical

reinforcement spacing equal to facing height. Wrap geotextile or geogrid reinforcement behind welded wire facing and extend reinforcement at least 3 feet back behind facing into shoring backfill. Attach geostrip reinforcement to welded wire facing with a connection approved by the Department.

For temporary wire walls with separate reinforcement and facing components, attach welded wire grid or metallic strip reinforcement to welded wire facing with a connection approved by the Department. For temporary geogrid, geostrip and wire walls, retain shoring backfill at welded wire facing with retention geotextiles and extend geotextiles at least 3 feet back behind facing into backfill.

(D) Preconstruction Meeting

The Engineer may require a shoring preconstruction meeting to discuss the construction, inspection and testing of the temporary shoring. If required and if this meeting occurs before all shoring submittals have been accepted, additional preconstruction meetings may be required before beginning construction of temporary shoring without accepted submittals. The Resident, District or Bridge Maintenance Engineer, Area Construction Engineer, Geotechnical Operations Engineer, Contractor and Shoring Contractor Superintendent will attend preconstruction meetings.

Construction Methods

Control drainage during construction in the vicinity of shoring. Direct run off away from shoring and shoring backfill. Contain and maintain backfill and protect material from erosion.

Install positive protection in accordance with the contract and accepted submittals. Use PCB in accordance with Section 1170 of the *2018 Standard Specifications* and 2018 Roadway Standard Drawing No. 1170.01. Use temporary guardrail in accordance with Section 862 of the *2018 Standard Specifications* and 2018 Roadway Standard Drawing Nos. 862.01, 862.02 and 862.03.

(A) Tolerances

Construct shoring with the following tolerances:

- (1) Horizontal wires of welded wire facing are level in all directions,
- (2) Shoring location is within 6 inches of horizontal and vertical alignment shown in the accepted submittals, and
- (3) Shoring plumbness (batter) is not negative and within 2 degrees of vertical.

(B) Cantilever, Braced and Anchored Shoring Installation

If overexcavation behind cantilever, braced or anchored shoring is shown in the accepted submittals, excavate before installing piles. Otherwise, install piles before excavating for shoring. Install cantilever, braced or anchored shoring in accordance with the construction

sequence shown in the accepted submittals. Remove piles and if applicable, timber lagging when shoring is no longer needed.

(1) Pile Installation

Install piles with the minimum required embedment and extension in accordance with Subarticles 450-3(D) and 450-3(E) of the *2018 Standard Specifications* except that a pile driving equipment data form is not required. Piles may be installed with a vibratory hammer as approved by the Engineer.

Do not splice sheet piles. Use pile excavation to install drilled-in H-piles. After filling holes with concrete or Type 1 grout to the elevations shown in the accepted submittals, remove any fluids and fill remaining portions of holes with flowable fill. Cure concrete or grout at least 7 days before excavating.

Notify the Engineer if refusal is reached before pile excavation or driven piles attain the minimum required embedment. When this occurs, a revised design submittal may be required.

(2) Excavation

Excavate in front of piles from the top down in accordance with the accepted submittals. For H-piles with timber lagging and braced and anchored shoring, excavate in staged horizontal lifts with a maximum height of 5 feet. Remove flowable fill and material in between H-piles as needed to install timber lagging. Position lagging with at least 3 inches of contact in the horizontal direction between the lagging and pile flanges. Do not excavate the next lift until timber lagging for the current lift is installed and if applicable, bracing and anchors for the current lift are accepted. Backfill behind cantilever, braced or anchored shoring with shoring backfill.

(3) Anchor Installation

If applicable, install foundations located behind anchored shoring before installing anchors. Fabricate and install ground anchors in accordance with the accepted submittals, Articles 6.4 and 6.5 of the *AASHTO LRFD Bridge Construction Specifications* and the following unless otherwise approved:

- (a) Materials in accordance with this provision are required instead of materials conforming to Articles 6.4 and 6.5.3 of the AASHTO LRFD Specifications,
- (b) Encapsulation-protected ground anchors in accordance with Article 6.4.1.2 of the AASHTO LRFD specifications are not required, and
- (c) Corrosion protection for unbonded lengths of ground anchors and anchorage covers are not required.
- (d) Mix and place neat cement grout in accordance with Subarticles 1003-5,

1003-6 and 1003-7 of the *2018 Standard Specifications*. Measure grout temperature, density and flow during grouting with at least the same frequency grout cubes are made for compressive strength. Perform density and flow field tests in the presence of the Engineer in accordance with American National Standards Institute/American Petroleum Institute Recommended Practice 13B-1 (Section 4, Mud Balance) and ASTM C939 (Flow Cone), respectively.

Install helical anchors in accordance with the accepted submittals and Anchor Manufacturer's instructions. Measure torque during installation and do not exceed the torsional strength rating of the helical anchor. Attain the minimum required installation torque and penetration before terminating anchor installation. When replacing a helical anchor, embed last helix of the replacement anchor at least 3 helix plate diameters past the location of the first helix of the previous anchor.

(4) Anchor Testing

Proof test and lock-off anchors in accordance with the accepted submittals and Article 6.5.5 of the *AASHTO LRFD Bridge Construction Specifications* except for the acceptance criteria in Article 6.5.5.5. For the AASHTO LRFD specifications, "ground anchor" refers to a ground or helical anchor and "tendon" refers to a bar, strand or shaft.

(a) Anchor Acceptance

Anchor acceptance is based in part on the following criteria.

- (i) For ground and helical anchors, total movement is less than 0.04 inches between the 1 and 10 minute readings or less than 0.08 inches between the 6 and 60 minute readings.
- (ii) For ground anchors, total movement at maximum test load exceeds 80% of the theoretical elastic elongation of the unbonded length.

(b) Anchor Test Results

Submit PDF files of anchor test records including movement versus load plots for each load increment within 24 hours of completing each row of anchors. The Engineer will review the test records to determine if the anchors are acceptable.

If the Engineer determines an anchor is unacceptable, revise the anchor design or installation methods. Submit a revised anchored shoring design for acceptance and provide an acceptable anchor with the revised design or installation methods. If required, replace the anchor or provide additional anchors with the revised design or installation methods.

(C) Temporary Wall Installation

Excavate as necessary for temporary walls in accordance with the plans and accepted submittals. If applicable, install foundations located in the reinforced zone before placing shoring backfill or reinforcement unless otherwise approved. Notify the Engineer when foundation excavation is complete. Do not place shoring backfill or reinforcement until excavation dimensions and foundation material are approved.

Erect welded wire facing so the wall position is as shown in the plans and accepted submittals. Set welded wire facing adjacent to each other in the horizontal and vertical direction to completely cover the wall face with facing. Stagger welded wire facing to create a running bond by centering facing over joints in the row below.

Attach geostrip reinforcement to welded wire facing and wrap geotextile reinforcement and retention geotextiles behind welded wire facing as shown in the plans and accepted submittals. Cover geotextiles with at least 3" of shoring backfill. Overlap adjacent geotextile reinforcement and retention and separation geotextiles at least 18 inches with seams oriented perpendicular to the wall face. Hold geotextiles in place with wire staples or anchor pins as needed.

Place reinforcement within 3 inches of locations shown in the plans and accepted submittals. Before placing shoring backfill, pull geosynthetic reinforcement taut so it is in tension and free of kinks, folds, wrinkles or creases. Install reinforcement with the direction shown in the plans and accepted submittals. For temporary wire walls with separate reinforcement and facing components, attach welded wire grid or metallic strip reinforcement to welded wire facing as shown in the accepted submittals. Do not splice or overlap reinforcement so seams are parallel to the wall face. Contact the Engineer when unanticipated existing or future obstructions such as foundations, pavements, pipes, inlets or utilities will interfere with reinforcement.

Place shoring backfill in the reinforced zone in 8 to 10 inch thick lifts. Compact A-2-4 soil and Class II, Type 1 and Class III select material in accordance with Subarticle 235-3(C) of the *2018 Standard Specifications*. Use only hand operated compaction equipment to compact backfill within 3 feet of welded wire facing. At a distance greater than 3 feet, compact shoring backfill with at least 4 passes of an 8 to 10 ton vibratory roller in a direction parallel to the wall face. Smooth wheeled or rubber tired rollers are also acceptable for compacting backfill. Do not use sheepsfoot, grid rollers or other types of compaction equipment with feet. Do not displace or damage reinforcement when placing and compacting shoring backfill. End dumping directly on geosynthetics is not permitted. Do not operate heavy equipment on reinforcement until it is covered with at least 8 inches of shoring backfill. Replace any damaged reinforcement to the satisfaction of the Engineer.

Backfill for temporary walls outside the reinforced zone in accordance with Article 410-8 of the *2018 Standard Specifications*. Bench temporary walls into the sides of excavations where applicable. For temporary geosynthetic walls with top of wall within 5 feet of finished grade, remove top facing and incorporate top reinforcement layer into fill when placing fill in front of wall. Temporary walls remain in place permanently unless otherwise required.

Measurement and Payment

Temporary Shoring will be measured and paid in square feet. Temporary walls will be measured as the square feet of exposed wall face area. Cantilever, braced or anchored shoring will be measured as the square feet of exposed shoring face area with the shoring height equal to the difference between the top and bottom of shoring elevations. Define “top of shoring” as where the grade intersects the back of sheet piles or H-piles and timber lagging. Define “bottom of shoring” as where the grade intersects front of sheet piles or H-piles and timber lagging. No measurement will be made for any embedment, shoring extension above top of shoring or pavement thickness above temporary walls.

The contract unit price for *Temporary Shoring* will be full compensation for providing shoring designs, submittals and materials, excavating, backfilling, hauling and removing excavated materials and supplying all labor, tools, equipment and incidentals necessary to construct temporary shoring.

No payment will be made for temporary shoring not shown in the plans or required by the Engineer including shoring for OSHA reasons or the Contractor’s convenience. No value engineering proposals will be accepted based solely on revising or eliminating shoring locations shown in the plans or estimated quantities shown in the bid item sheets as a result of actual field measurements or site conditions.

PCB will be measured and paid in accordance with Section 1170 of the *2018 Standard Specifications*. No additional payment will be made for anchoring PCB for temporary shoring. Costs for anchoring PCB will be incidental to temporary shoring.

Temporary guardrail will be measured and paid for in accordance with Section 862 of the *2018 Standard Specifications*.

Payment will be made under:

Pay Item	Pay Unit
Temporary Shoring	Square Foot

WORK ZONE INSTALLER:

(7-20-21)

1101, 1150

SP11 R04

Provide the service of at least one qualified work zone installer during the setup, installation, and removal of temporary traffic control within the highway right of way. The qualified work zone installer shall serve as crew leader and shall be on site and directing the installation and removal of temporary traffic control. If multiple temporary traffic control installations or removals are occurring simultaneously, then each shall have a qualified work zone installer.

The work zone installer shall be qualified by an NCDOT approved training agency in the safe and competent set up of temporary traffic control. For a complete listing of approved training agencies, see the Work Zone Safety Training webpage.

A work zone supervisor, in accordance with Article 1101-13 of the *Standard Specifications*, may fulfill the role of the work zone installer during the setup, installation, and removal of temporary

traffic control within the highway right of way provided they are on site and directing the installation and removal of temporary traffic control.

All other individuals participating in the setup, installation, and removal of temporary traffic control within the highway right of way shall be certified as a qualified flagger in accordance with Article 1150-3 of the *Standard Specifications*, even if flagging is not being performed as part of the traffic control.

Provide the name and contact information of all qualified work zone installers to the Engineer prior to or at the preconstruction conference. Additionally, provide a qualification statement that all other individuals participating in the setup, installation, and removal of temporary traffic control are qualified flaggers that have been properly trained through an NCDOT approved training agency.

EXTRUDED THERMOPLASTIC PAVEMENT MARKING THICKNESS:

3-19-19

1205

SP12 R05

Revise the *2018 Standard Specifications* as follows:

Page 12-6, Subarticle 1205-4(A)(1) General, lines 5-8, delete the second sentence and replace with the following:

Use application equipment that provides multiple width settings ranging from 4 inches to 12 inches and multiple thickness settings to achieve a minimum pavement marking thickness of 0.090 inch above the surface of the pavement.

Page 12-7, Table 1205-3, THICKNESS REQUIREMENTS FOR THERMOPLASTIC, replace with the following:

TABLE 1205-3 MINIMUM THICKNESS REQUIREMENTS FOR THERMOPLASTIC	
Thickness	Location
240 mils	In-lane and shoulder-transverse pavement markings (rumble strips). May be placed in 2 passes.
90 mils	Center lines, skip lines, transverse bands, mini-skip lines, characters, bike lane symbols, crosswalk lines, edge lines, gore lines, diagonals, and arrow symbols

PERMANENT SEEDING AND MULCHING:

(7-1-95)

1660

SP16 R02

The Department desires that permanent seeding and mulching be established on this project as soon as practical after slopes or portions of slopes have been graded. As an incentive to obtain an early stand of vegetation on this project, the Contractor's attention is called to the following:

For all permanent seeding and mulching that is satisfactorily completed in accordance with the requirements of Section 1660 in the *2018 Standard Specifications* and within the following percentages of elapsed contract times, an additional payment will be made to the Contractor as an incentive additive. The incentive additive will be determined by multiplying the number of acres

of seeding and mulching satisfactorily completed times the contract unit bid price per acre for Seeding and Mulching times the appropriate percentage additive.

Percentage of Elapsed Contract Time	Percentage Additive
0% - 30%	30%
30.01% - 50%	15%

Percentage of elapsed contract time is defined as the number of calendar days from the date of availability of the contract to the date the permanent seeding and mulching is acceptably completed divided by the total original contract time.

STANDARD SPECIAL PROVISION
AVAILABILITY OF FUNDS – TERMINATION OF CONTRACTS

(5-20-08)

Z-2

General Statute 143C-6-11. (h) Highway Appropriation is hereby incorporated verbatim in this contract as follows:

(h) Amounts Encumbered. – Transportation project appropriations may be encumbered in the amount of allotments made to the Department of Transportation by the Director for the estimated payments for transportation project contract work to be performed in the appropriation fiscal year. The allotments shall be multiyear allotments and shall be based on estimated revenues and shall be subject to the maximum contract authority contained in *General Statute 143C-6-11(c)*. Payment for transportation project work performed pursuant to contract in any fiscal year other than the current fiscal year is subject to appropriations by the General Assembly. Transportation project contracts shall contain a schedule of estimated completion progress, and any acceleration of this progress shall be subject to the approval of the Department of Transportation provided funds are available. The State reserves the right to terminate or suspend any transportation project contract, and any transportation project contract shall be so terminated or suspended if funds will not be available for payment of the work to be performed during that fiscal year pursuant to the contract. In the event of termination of any contract, the contractor shall be given a written notice of termination at least 60 days before completion of scheduled work for which funds are available. In the event of termination, the contractor shall be paid for the work already performed in accordance with the contract specifications.

Payment will be made on any contract terminated pursuant to the special provision in accordance with Subarticle 108-13(D) of the *2018 Standard Specifications*.

STANDARD SPECIAL PROVISION
NCDOT GENERAL SEED SPECIFICATION FOR SEED QUALITY

(5-17-11)

Z-3

Seed shall be sampled and tested by the North Carolina Department of Agriculture and Consumer Services, Seed Testing Laboratory. When said samples are collected, the vendor shall supply an independent laboratory report for each lot to be tested. Results from seed so sampled shall be final. Seed not meeting the specifications shall be rejected by the Department of Transportation and shall not be delivered to North Carolina Department of Transportation warehouses. If seed has been delivered it shall be available for pickup and replacement at the supplier's expense.

Any re-labeling required by the North Carolina Department of Agriculture and Consumer Services, Seed Testing Laboratory, that would cause the label to reflect as otherwise specified herein shall be rejected by the North Carolina Department of Transportation.

Seed shall be free from seeds of the noxious weeds Johnsongrass, Balloonvine, Jimsonweed, Witchweed, Itchgrass, Serrated Tussock, Showy Crotalaria, Smooth Crotalaria, Sicklepod, Sandbur, Wild Onion, and Wild Garlic. Seed shall not be labeled with the above weed species on the seed analysis label. Tolerances as applied by the Association of Official Seed Analysts will NOT be allowed for the above noxious weeds except for Wild Onion and Wild Garlic.

Tolerances established by the Association of Official Seed Analysts will generally be recognized. However, for the purpose of figuring pure live seed, the found pure seed and found germination percentages as reported by the North Carolina Department of Agriculture and Consumer Services, Seed Testing Laboratory will be used. Allowances, as established by the NCDOT, will be recognized for minimum pure live seed as listed on the following pages.

The specifications for restricted noxious weed seed refers to the number per pound as follows:

<u>Restricted Noxious Weed</u>	<u>Limitations per Lb. Of Seed</u>	<u>Restricted Noxious Weed</u>	<u>Limitations per Lb. of Seed</u>
Blessed Thistle	4 seeds	Cornflower (Ragged Robin)	27 seeds
Cocklebur	4 seeds	Texas Panicum	27 seeds
Spurred Anoda	4 seeds	Bracted Plantain	54 seeds
Velvetleaf	4 seeds	Buckhorn Plantain	54 seeds
Morning-glory	8 seeds	Broadleaf Dock	54 seeds
Corn Cockle	10 seeds	Curly Dock	54 seeds
Wild Radish	12 seeds	Dodder	54 seeds
Purple Nutsedge	27 seeds	Giant Foxtail	54 seeds
Yellow Nutsedge	27 seeds	Horsenettle	54 seeds
Canada Thistle	27 seeds	Quackgrass	54 seeds
Field Bindweed	27 seeds	Wild Mustard	54 seeds
Hedge Bindweed	27 seeds		

Seed of Pensacola Bahiagrass shall not contain more than 7% inert matter, Kentucky Bluegrass, Centipede and Fine or Hard Fescue shall not contain more than 5% inert matter whereas a maximum of 2% inert matter will be allowed on all other kinds of seed. In addition, all seed shall

not contain more than 2% other crop seed nor more than 1% total weed seed. The germination rate as tested by the North Carolina Department of Agriculture shall not fall below 70%, which includes both dormant and hard seed. Seed shall be labeled with not more than 7%, 5% or 2% inert matter (according to above specifications), 2% other crop seed and 1% total weed seed.

Exceptions may be made for minimum pure live seed allowances when cases of seed variety shortages are verified. Pure live seed percentages will be applied in a verified shortage situation. Those purchase orders of deficient seed lots will be credited with the percentage that the seed is deficient.

FURTHER SPECIFICATIONS FOR EACH SEED GROUP ARE GIVEN BELOW:

Minimum 85% pure live seed; maximum 1% total weed seed; maximum 2% total other crop seed; maximum 144 restricted noxious weed seed per pound. Seed less than 83% pure live seed will not be approved.

Sericea Lespedeza
Oats (seeds)

Minimum 80% pure live seed; maximum 1% total weed seed; maximum 2% total other crop; maximum 144 restricted noxious weed seed per pound. Seed less than 78% pure live seed will not be approved.

Tall Fescue (all approved varieties)	Bermudagrass
Kobe Lespedeza	Browntop Millet
Korean Lespedeza	German Millet – Strain R
Weeping Lovegrass	Clover – Red/White/Crimson
Carpetgrass	

Minimum 78% pure live seed; maximum 1% total weed seed; maximum 2% total other crop seed; maximum 144 restricted noxious weed seed per pound. Seed less than 76% pure live seed will not be approved.

Common or Sweet Sundangrass

Minimum 76% pure live seed; maximum 1% total weed seed; maximum 2% total other crop seed; maximum 144 restricted noxious weed seed per pound. Seed less than 74% pure live seed will not be approved.

Rye (grain; all varieties)
Kentucky Bluegrass (all approved varieties)
Hard Fescue (all approved varieties)
Shrub (bicolor) Lespedeza

Minimum 70% pure live seed; maximum 1% total weed seed; maximum 2% total other crop seed; maximum 144 noxious weed seed per pound. Seed less than 70% pure live seed will not be approved.

Centipedegrass	Japanese Millet
Crownvetch	Reed Canary Grass
Pensacola Bahiagrass	Zoysia
Creeping Red Fescue	

Minimum 70% pure live seed; maximum 1% total weed seed; maximum 2% total other crop seed; maximum 5% inert matter; maximum 144 restricted noxious weed seed per pound.

Barnyard Grass
Big Bluestem
Little Bluestem
Bristly Locust
Birdsfoot Trefoil
Indiangrass
Orchardgrass
Switchgrass
Yellow Blossom Sweet Clover

STANDARD SPECIAL PROVISION**ERRATA**

(10-16-18) (Rev.2-16-21)

Z-4

Revise the *2018 Standard Specifications* as follows:

Division 6

Page 6-7, Article 609-1 DESCRIPTION, line 29, replace article number “609-10” with “609-9”.

Division 7

Page 7-27, Article 725-1 MEASUREMENT AND PAYMENT, line 4, replace article number “725-1” with “724-4”.

Page 7-28, Article 725-1 MEASUREMENT AND PAYMENT, line 10, replace article number “725-1” with “725-3”.

Division 10

Page 10-78, Article 1056-4 GEOTEXTILES, TABLE 1056-1, Permittivity, Type 2, replace “Table 6^D” with “Table 7^D” and **Permittivity, Type 3^B,** replace “Table 7^D” with “Table 8^D”.

Page 10-121, Article 1076-7, REPAIR OF GALVANIZING, line 8, replace article number “1080-9” with “1080-7”.

Page 10-162, Article 1080-50 PAINT FOR VERTICAL MARKERS, line 1, replace article number “1080-50” with “1080-10”.

Page 10-162, Article 1080-61 EPOXY RESIN FOR REINFORCING STEEL, line 5, replace article number “1080-61” with “1080-11”.

Page 10-162, Article 1080-72 ABRASIVE MATERIALS FOR BLAST CLEANING STEEL, line 22, replace article number “1080-72” with “1080-12”.

Page 10-163, Article 1080-83 FIELD PERFORMANCE AND SERVICES, line 25, replace article number “1080-83” with “1080-13”.

Division 17

Page 17-15, Article 1715-4 MEASUREMENT AND PAYMENT, lines 42-44, replace the second sentence with the following:

An example is an installation of a single 1.25 inch HDPE conduit would be paid as:

Directional Drill (1)(1.25”) Linear Foot

STANDARD SPECIAL PROVISION**PLANT AND PEST QUARANTINES****(Imported Fire Ant, Gypsy Moth, Witchweed, Emerald Ash Borer, Guava Root Knot Nematode, And Other Noxious Weeds)**

(3-18-03) (Rev. 5-21-19)

Z-04a

Within Quarantined Area

This project may be within a county regulated for plant and/or pests. If the project or any part of the Contractor's operations is located within a quarantined area, thoroughly clean all equipment prior to moving out of the quarantined area. Comply with federal/state regulations by obtaining a certificate or limited permit for any regulated article moving from the quarantined area.

Originating in a Quarantined County

Obtain a certificate or limited permit issued by the N.C. Department of Agriculture/United States Department of Agriculture. Have the certificate or limited permit accompany the article when it arrives at the project site.

Contact

Contact the N.C. Department of Agriculture/United States Department of Agriculture at 1-800-206-9333, 919-707-3730, or <https://www.ncagr.gov/plantindustry/Plant/quaran/table2.htm> to determine those specific project sites located in the quarantined area or for any regulated article used on this project originating in a quarantined county.

Regulated Articles Include

1. Soil, sand, gravel, compost, peat, humus, muck, and decomposed manure, separately or with other articles. This includes movement of articles listed above that may be associated with cut/waste, ditch pulling, and shoulder cutting.
2. Plants with roots including grass sod.
3. Plant crowns and roots.
4. Bulbs, corms, rhizomes, and tubers of ornamental plants.
5. Hay, straw, fodder, and plant litter of any kind.
6. Clearing and grubbing debris.
7. Used agricultural cultivating and harvesting equipment.
8. Used earth-moving equipment.
9. Any other products, articles, or means of conveyance, of any character, if determined by an inspector to present a hazard of spreading imported fire ant, gypsy moth, witchweed, emerald ash borer, guava root knot nematode, or other noxious weeds.

STANDARD SPECIAL PROVISION**TITLE VI AND NONDISCRIMINATION:**

(6-28-77)(Rev 6/19/2018)

Z-6

Revise the *2018 Standard Specifications* as follows:

Replace Article 103-4(B) with the following:

The North Carolina Department of Transportation is committed to carrying out the U.S. Department of Transportation's policy of ensuring nondiscrimination in the award and administration of contracts.

The provisions of this section related to United States Department of Transportation (US DOT) Order 1050.2A, Title 49 Code of Federal Regulations (CFR) part 21, 23 United States Code (U.S.C.) 140 and 23 CFR part 200 (or 49 CFR 303, 49 U.S.C. 5332 or 49 U.S.C. 47123) are applicable to all North Carolina Department of Transportation (NCDOT) contracts and to all related subcontracts, material supply, engineering, architectural and other service contracts, regardless of dollar amount. Any Federal provision that is specifically required not specifically set forth is hereby incorporated by reference.

(1) **Title VI Assurances (USDOT Order 1050.2A, Appendix A)**

During the performance of this contract, the contractor, for itself, its assignees, and successors in interest (hereinafter referred to as the "contractor") agrees as follows:

(a) Compliance with Regulations

The contractor (hereinafter includes consultants) shall comply with the Acts and the Regulations relative to Nondiscrimination in Federally-assisted programs of the U.S. Department of Transportation, Federal Highway Administration (FHWA), as they may be amended from time to time, which are herein incorporated by reference and made a part of this contract.

(b) Nondiscrimination

The contractor, with regard to the work performed by it during the contract, shall not discriminate on the grounds of race, color, or national origin in the selection and retention of subcontractors, including procurements of materials and leases of equipment. The contractor shall not participate directly or indirectly in the discrimination prohibited by the Acts and the Regulations, including employment practices when the contract covers any activity, project, or program set forth in Appendix B of 49 CFR Part 21.

(c) Solicitations for Subcontractors, Including Procurements of Materials and Equipment

In all solicitations, either by competitive bidding, or negotiation made by the contractor for work to be performed under a subcontract, including procurements of materials, or leases of equipment, each potential subcontractor or supplier shall be notified by the contractor of the contractor's obligations under this contract and the Acts and the Regulations relative to Nondiscrimination on the grounds of race, color, or national origin.

(d) Information and Reports

The contractor shall provide all information and reports required by the Acts, the Regulations, and directives issued pursuant thereto and shall permit access to its books, records, accounts, other sources of information, and its facilities as may be determined by the Recipient or the FHWA to be pertinent to ascertain compliance with such Acts,

Regulations, and instructions. Where any information required of a contractor is in the exclusive possession of another who fails or refuses to furnish the information, the contractor shall so certify to the Recipient or the FHWA, as appropriate, and shall set forth what efforts it has made to obtain the information.

(e) Sanctions for Noncompliance:

In the event of a contractor's noncompliance with the Non-discrimination provisions of this contract, the Recipient will impose such contract sanctions as it and/or the FHWA may determine to be appropriate, including, but not limited to:

- (i) Withholding payments to the contractor under the contract until the contractor complies; and/or
- (ii) Cancelling, terminating, or suspending a contract, in whole or in part.

(f) Incorporation of Provisions

The contractor shall include the provisions of paragraphs (a) through (f) in every subcontract, including procurements of materials and leases of equipment, unless exempt by the Acts, the Regulations and directives issued pursuant thereto. The contractor shall take action with respect to any subcontract or procurement as the Recipient or the FHWA may direct as a means of enforcing such provisions including sanctions for noncompliance. Provided, that if the contractor becomes involved in, or is threatened with litigation by a subcontractor, or supplier because of such direction, the contractor may request the Recipient to enter into any litigation to protect the interests of the Recipient. In addition, the contractor may request the United States to enter into the litigation to protect the interests of the United States.

(2) **Title VI Nondiscrimination Program (23 CFR 200.5(p))**

The North Carolina Department of Transportation (NCDOT) has assured the USDOT that, as a condition to receiving federal financial assistance, NCDOT will comply with Title VI of the Civil Rights Act of 1964 and all requirements imposed by Title 49 CFR part 21 and related nondiscrimination authorities to ensure that no person shall, on the ground of race, color, national origin, limited English proficiency, sex, age, or disability (including religion/creed or income-level, where applicable), be excluded from participation in, be denied the benefits of, or be subjected to discrimination under any programs, activities, or services conducted or funded by NCDOT. Contractors and other organizations under contract or agreement with NCDOT must also comply with Title VI and related authorities, therefore:

(a) During the performance of this contract or agreement, contractors (e.g., subcontractors, consultants, vendors, prime contractors) are responsible for complying with NCDOT's Title VI Program. Contractors are not required to prepare or submit Title VI Programs. To comply with this section, the prime contractor shall:

1. Post NCDOT's Notice of Nondiscrimination and the Contractor's own Equal Employment Opportunity (EEO) Policy in conspicuous locations accessible to all employees, applicants and subcontractors on the jobsite.
2. Physically incorporate the required Title VI clauses into all subcontracts on federally-assisted and state-funded NCDOT projects, and ensure inclusion by subcontractors into all lower-tier subcontracts.
3. Required Solicitation Language. The Contractor shall include the following notification in all solicitations for bids and requests for work or material, regardless of funding source:

“The North Carolina Department of Transportation, in accordance with the provisions of Title VI of the Civil Rights Act of 1964 (78 Stat. 252, 42 U.S.C. §§

2000d to 2000d-4) and the Regulations, hereby notifies all bidders that it will affirmatively ensure that any contract entered into pursuant to this advertisement, disadvantaged business enterprises will be afforded full and fair opportunity to submit bids in response to this invitation and will not be discriminated against on the grounds of race, color, or national origin in consideration for an award. In accordance with other related nondiscrimination authorities, bidders and contractors will also not be discriminated against on the grounds of sex, age, disability, low-income level, creed/religion, or limited English proficiency in consideration for an award.”

4. Physically incorporate the FHWA-1273, in its entirety, into all subcontracts and subsequent lower tier subcontracts on Federal-aid highway construction contracts only.
 5. Provide language assistance services (i.e., written translation and oral interpretation), free of charge, to LEP employees and applicants. Contact NCDOT OCR for further assistance, if needed.
 6. For assistance with these Title VI requirements, contact the NCDOT Title VI Nondiscrimination Program at 1-800-522-0453.
- (b) Subrecipients (e.g. cities, counties, LGAs, planning organizations) may be required to prepare and submit a Title VI Plan to NCDOT, including Title VI Assurances and/or agreements. Subrecipients must also ensure compliance by their contractors and subrecipients with Title VI. (23 CFR 200.9(b)(7))
- (c) If reviewed or investigated by NCDOT, the contractor or subrecipient agrees to take affirmative action to correct any deficiencies found within a reasonable time period, not to exceed 90 calendar days, unless additional time is granted by NCDOT. (23 CFR 200.9(b)(15))
- (d) The Contractor is responsible for notifying subcontractors of NCDOT’s External Discrimination Complaints Process.
1. Applicability
Title VI and related laws protect participants and beneficiaries (e.g., members of the public and contractors) from discrimination by NCDOT employees, subrecipients and contractors, regardless of funding source.
 2. Eligibility
Any person—or class of persons—who believes he/she has been subjected to discrimination based on race, color, national origin, Limited English Proficiency (LEP), sex, age, or disability (and religion in the context of employment, aviation, or transit) may file a written complaint. The law also prohibits intimidation or retaliation of any sort.
 3. Time Limits and Filing Options
Complaints may be filed by the affected individual(s) or a representative and must be filed no later than 180 calendar days after the following:
 - (i) The date of the alleged act of discrimination; or
 - (ii) The date when the person(s) became aware of the alleged discrimination; or
 - (iii) Where there has been a continuing course of conduct, the date on which that conduct was discontinued or the latest instance of the conduct.Title VI and related discrimination complaints may be submitted to the following entities:

- North Carolina Department of Transportation, Office of Civil Rights, Title VI Program, 1511 Mail Service Center, Raleigh, NC 27699-1511; toll free 1-800-522-0453
 - Federal Highway Administration, North Carolina Division Office, 310 New Bern Avenue, Suite 410, Raleigh, NC 27601, 919-747-7010
 - US Department of Transportation, Departmental Office of Civil Rights, External Civil Rights Programs Division, 1200 New Jersey Avenue, SE, Washington, DC 20590; 202-366-4070
4. Format for Complaints
Complaints must be in writing and signed by the complainant(s) or a representative, and include the complainant's name, address, and telephone number. Complaints received by fax or e-mail will be acknowledged and processed. Allegations received by telephone will be reduced to writing and provided to the complainant for confirmation or revision before processing. Complaints will be accepted in other languages, including Braille.
5. Discrimination Complaint Form
Contact NCDOT Civil Rights to receive a full copy of the Discrimination Complaint Form and procedures.
6. Complaint Basis
Allegations must be based on issues involving race, color, national origin (LEP), sex, age, disability, or religion (in the context of employment, aviation or transit). "Basis" refers to the complainant's membership in a protected group category.

**TABLE 103-1
COMPLAINT BASIS**

Protected Categories	Definition	Examples	Applicable Nondiscrimination Authorities
Race and Ethnicity	An individual belonging to one of the accepted racial groups; or the perception, based usually on physical characteristics that a person is a member of a racial group	Black/African American, Hispanic/Latino, Asian, American Indian/Alaska Native, Native Hawaiian/Pacific Islander, White	Title VI of the Civil Rights Act of 1964; 49 CFR Part 21; 23 CFR 200; 49 U.S.C. 5332(b); 49 U.S.C. 47123. <i>(Executive Order 13166)</i>
Color	Color of skin, including shade of skin within a racial group	Black, White, brown, yellow, etc.	
National Origin <i>(Limited English Proficiency)</i>	Place of birth. Citizenship is not a factor. <i>(Discrimination based on language or a person's accent is also covered)</i>	Mexican, Cuban, Japanese, Vietnamese, Chinese	
Sex	Gender. The sex of an individual. <i>Note: Sex under this program does not include sexual orientation.</i>	Women and Men	1973 Federal-Aid Highway Act; 49 U.S.C. 5332(b); 49 U.S.C. 47123.
Age	Persons of any age	21-year-old person	Age Discrimination Act of 1975 49 U.S.C. 5332(b); 49 U.S.C. 47123.
Disability	Physical or mental impairment, permanent or temporary, or perceived.	Blind, alcoholic, para-amputee, epileptic, diabetic, arthritic	Section 504 of the Rehabilitation Act of 1973; Americans with Disabilities Act of 1990

<p>Religion (in the context of employment) <i>(Religion/ Creed in all aspects of any aviation or transit-related construction)</i></p>	<p>An individual belonging to a religious group; or the perception, based on distinguishable characteristics that a person is a member of a religious group. In practice, actions taken as a result of the moral and ethical beliefs as to what is right and wrong, which are sincerely held with the strength of traditional religious views. Note: Does not have to be associated with a recognized religious group or church; if an individual sincerely holds to the belief, it is a protected religious practice.</p>	<p>Muslim, Christian, Sikh, Hindu, etc.</p>	<p>Title VII of the Civil Rights Act of 1964; 23 CFR 230; FHWA-1273 Required Contract Provisions. <i>(49 U.S.C. 5332(b); 49 U.S.C. 47123)</i></p>
--	---	---	---

(3) Pertinent Nondiscrimination Authorities

During the performance of this contract, the contractor, for itself, its assignees, and successors in interest agrees to comply with the following non-discrimination statutes and authorities, including, but not limited to:

- (a) Title VI of the Civil Rights Act of 1964 (42 U.S.C. § 2000d et seq., 78 stat. 252), (prohibits discrimination on the basis of race, color, national origin); and 49 CFR Part 21.
- (b) The Uniform Relocation Assistance and Real Property Acquisition Policies Act of 1970, (42 U.S.C. § 4601), (prohibits unfair treatment of persons displaced or whose property has been acquired because of Federal or Federal-aid programs and projects);
- (c) Federal-Aid Highway Act of 1973, (23 U.S.C. § 324 et seq.), (prohibits discrimination on the basis of sex);
- (d) Section 504 of the Rehabilitation Act of 1973, (29 U.S.C. § 794 et seq.), as amended, (prohibits discrimination on the basis of disability) and 49 CFR Part 27;
- (e) The Age Discrimination Act of 1975, as amended, (42 U.S.C. § 6101 et seq.), (prohibits discrimination on the basis of age);
- (f) Airport and Airway Improvement Act of 1982, (49 USC § 471, Section 47123), as amended, (prohibits discrimination based on race, creed, color, national origin, or sex);
- (g) The Civil Rights Restoration Act of 1987, (PL 100-209), (Broadened the scope, coverage and applicability of Title VI of the Civil Rights Act of 1964, The Age Discrimination Act of 1975 and Section 504 of the Rehabilitation Act of 1973, by expanding the definition of the terms "programs or activities" to include all of the programs or activities of the Federal-aid recipients, sub-recipients and contractors, whether such programs or activities are Federally funded or not);
- (h) Titles II and III of the Americans with Disabilities Act, which prohibit discrimination on the basis of disability in the operation of public entities, public and private transportation systems, places of public accommodation, and certain testing entities (42 U.S.C. §§ 12131-12189) as implemented by Department of Transportation regulations at 49 C.F.R. parts 37 and 38;
- (i) The Federal Aviation Administration's Nondiscrimination statute (49 U.S.C. § 47123) (prohibits discrimination on the basis of race, color, national origin, and sex);
- (j) Executive Order 12898, Federal Actions to Address Environmental Justice in Minority Populations and Low-Income Populations, which ensures Nondiscrimination against minority populations by discouraging programs, policies, and activities with

disproportionately high and adverse human health or environmental effects on minority and low-income populations;

- (k) Executive Order 13166, Improving Access to Services for Persons with Limited English Proficiency, and resulting agency guidance, national origin discrimination includes discrimination because of Limited English proficiency (LEP). To ensure compliance with Title VI, you must take reasonable steps to ensure that LEP persons have meaningful access to your programs (70 Fed. Reg. at 74087 to 74100);
- (l) Title IX of the Education Amendments of 1972, as amended, which prohibits you from discriminating because of sex in education programs or activities (20 U.S.C. 1681 et seq).
- (m) Title VII of the Civil Rights Act of 1964 (42 U.S.C. § 2000e et seq., Pub. L. 88-352), (prohibits employment discrimination on the basis of race, color, religion, sex, or national origin).

(4) Additional Title VI Assurances

***The following Title VI Assurances (Appendices B, C and D) shall apply, as applicable*

- (a) Clauses for Deeds Transferring United States Property (1050.2A, Appendix B)
The following clauses will be included in deeds effecting or recording the transfer of real property, structures, or improvements thereon, or granting interest therein from the United States pursuant to the provisions of Assurance 4.

NOW, THEREFORE, the U.S. Department of Transportation as authorized by law and upon the condition that the North Carolina Department of Transportation (NCDOT) will accept title to the lands and maintain the project constructed thereon in accordance with the North Carolina General Assembly, the Regulations for the Administration of the Federal-Aid Highway Program, and the policies and procedures prescribed by the Federal Highway Administration of the U.S. Department of Transportation in accordance and in compliance with all requirements imposed by Title 49, Code of Federal Regulations, U.S. Department of Transportation, Subtitle A, Office of the Secretary, Part 21, Nondiscrimination in Federally-assisted programs of the U.S. Department of Transportation pertaining to and effectuating the provisions of Title VI of the Civil Rights Act of 1964 (78 Stat. 252; 42 U.S.C. § 2000d to 2000d-4), does hereby remise, release, quitclaim and convey unto the NCDOT all the right, title and interest of the U.S. Department of Transportation in and to said lands described in Exhibit A attached hereto and made a part hereof.

(HABENDUM CLAUSE)

TO HAVE AND TO HOLD said lands and interests therein unto the North Carolina Department of Transportation (NCDOT) and its successors forever, subject, however, to the covenants, conditions, restrictions and reservations herein contained as follows, which will remain in effect for the period during which the real property or structures are used for a purpose for which Federal financial assistance is extended or for another purpose involving the provision of similar services or benefits and will be binding on the NCDOT, its successors and assigns.

The NCDOT, in consideration of the conveyance of said lands and interests in lands, does hereby covenant and agree as a covenant running with the land for itself, its successors and assigns, that (1) no person will on the grounds of race, color, or national origin, be excluded from participation in, be denied the benefits of, or be otherwise subjected to discrimination with regard to any facility located wholly or in part on, over, or under such lands hereby conveyed [,] [and]* (2) that the NCDOT will use the lands and interests in lands and interests in lands so conveyed, in compliance with all requirements imposed by or pursuant to Title 49, Code of Federal Regulations, U.S. Department of Transportation, Subtitle A, Office of the Secretary, Part 21, Non-discrimination in Federally-assisted programs of the U.S. Department of Transportation, Effectuation of Title VI of the Civil Rights Act of 1964, and as said Regulations and Acts may be amended [, and (3) that in the event of breach of any of the above-mentioned nondiscrimination conditions, the Department will have a right to enter or re-enter said lands and facilities on said land, and that above described land and facilities will thereon revert to and vest in and become the absolute property of the U.S. Department of Transportation and its assigns as such interest existed prior to this instruction].*

(*Reverter clause and related language to be used only when it is determined that such a clause is necessary in order to make clear the purpose of Title VI.)

(b) Clauses for Transfer of Real Property Acquired or Improved Under the Activity, Facility, or Program (1050.2A, Appendix C)

The following clauses will be included in deeds, licenses, leases, permits, or similar instruments entered into by the North Carolina Department of Transportation (NCDOT) pursuant to the provisions of Assurance 7(a):

1. The (grantee, lessee, permittee, etc. as appropriate) for himself/herself, his/her heirs, personal representatives, successors in interest, and assigns, as a part of the consideration hereof, does hereby covenant and agree [in the case of deeds and leases add "as a covenant running with the land"] that:
 - (i.) In the event facilities are constructed, maintained, or otherwise operated on the property described in this (deed, license, lease, permit, etc.) for a purpose for which a U.S. Department of Transportation activity, facility, or program is extended or for another purpose involving the provision of similar services or benefits, the (grantee, licensee, lessee, permittee, etc.) will maintain and operate such facilities and services in compliance with all requirements imposed by the Acts and Regulations (as may be amended) such that no person on the grounds of race, color, or national origin, will be excluded from participation in, denied the benefits of, or be otherwise subjected to discrimination in the use of said facilities.
2. With respect to licenses, leases, permits, etc., in the event of breach of any of the above Nondiscrimination covenants, the NCDOT will have the right to terminate the (lease, license, permit, etc.) and to enter, re-enter, and repossess said lands and facilities thereon, and hold the same as if the (lease, license, permit, etc.) had never been made or issued. *
3. With respect to a deed, in the event of breach of any of the above Nondiscrimination covenants, the NCDOT will have the right to enter or re-enter the lands and facilities thereon, and the above described lands and facilities will there upon revert to and vest in and become the absolute property of the NCDOT and its assigns. *

- (*Reverter clause and related language to be used only when it is determined that such a clause is necessary to make clear the purpose of Title VI.)
- (c) Clauses for Construction/Use/Access to Real Property Acquired Under the Activity, Facility or Program (1050.2A, Appendix D)

The following clauses will be included in deeds, licenses, permits, or similar instruments/ agreements entered into by the North Carolina Department of Transportation (NCDOT) pursuant to the provisions of Assurance 7(b):

1. The (grantee, licensee, permittee, etc., as appropriate) for himself/herself, his/her heirs, personal representatives, successors in interest, and assigns, as a part of the consideration hereof, does hereby covenant and agree (in the case of deeds and leases add, "as a covenant running with the land") that (1) no person on the ground of race, color, or national origin, will be excluded from participation in, denied the benefits of, or be otherwise subjected to discrimination in the use of said facilities, (2) that in the construction of any improvements on, over, or under such land, and the furnishing of services thereon, no person on the ground of race, color, or national origin, will be excluded from participation in, denied the benefits of, or otherwise be subjected to discrimination, (3) that the (grantee, licensee, lessee, permittee, etc.) will use the premises in compliance with all other requirements imposed by or pursuant to the Acts and Regulations, as amended, set forth in this Assurance.
2. With respect to (licenses, leases, permits, etc.), in the event of breach of any of the above Non-discrimination covenants, the NCDOT will have the right to terminate the (license, permit, etc., as appropriate) and to enter or re-enter and repossess said land and the facilities thereon, and hold the same as if said (license, permit, etc., as appropriate) had never been made or issued. *
3. With respect to deeds, in the event of breach of any of the above Nondiscrimination covenants, the NCDOT will there upon revert to and vest in and become the absolute property of the NCDOT and its assigns. *

(*Reverter clause and related language to be used only when it is determined that such a clause is necessary to make clear the purpose of Title VI.)

STANDARD SPECIAL PROVISION**MINORITY AND FEMALE EMPLOYMENT REQUIREMENTS**

Z-7

NOTICE OF REQUIREMENTS FOR AFFIRMATIVE ACTION TO ENSURE EQUAL EMPLOYMENT OPPORTUNITY (*EXECUTIVE NUMBER 11246*)

1. The goals and timetables for minority and female participation, expressed in percentage terms for the Contractor's aggregate workforce in each trade on all construction work in the covered area, see as shown on the attached sheet entitled "Employment Goals for Minority and Female participation".

These goals are applicable to all the Contractor's construction work (whether or not it is Federal or federally assisted) performed in the covered area. If the Contractor performs construction work in a geographical area located outside of the covered area, it shall apply the goals established for such geographical area where the work is actually performed. With regard to this second area, the Contractor also is subject to the goals for both its federally involved and nonfederally involved construction.

The Contractor's compliance with the Executive Order and the regulations in *41 CFR Part 60-4* shall be based on its implementation of the Equal Opportunity Clause, specific affirmative action obligations required by the specifications set forth in *41 CFR 60-4.3(a)*, and its effort to meet the goals. The hours of minority and female employment and training must be substantially uniform throughout the length of the contract, and in each trade and the Contractor shall make a good faith effort to employ minorities and women evenly on each of its projects. The transfer of minority or female employees or trainees from Contractor to Contractor or from project to project for the sole purpose of meeting the Contractor's goals shall be a violation of the contract, the executive Order and the regulations in *41 CFR Part 60-4*. Compliance with the goals will be measured against the total work hours performed.

2. As used in this Notice and in the contract resulting from this solicitation, the "covered area" is the county or counties shown on the cover sheet of the proposal form and contract.

**EMPLOYMENT GOALS FOR MINORITY
AND FEMALE PARTICIPATION**

Economic Areas

Area 023 29.7%

Bertie County
Camden County
Chowan County
Gates County
Hertford County
Pasquotank County
Perquimans County

Area 024 31.7%

Beaufort County
Carteret County
Craven County
Dare County
Edgecombe County
Green County
Halifax County
Hyde County
Jones County
Lenoir County
Martin County
Nash County
Northampton County
Pamlico County
Pitt County
Tyrrell County
Washington County
Wayne County
Wilson County

Area 025 23.5%

Columbus County
Duplin County
Onslow County
Pender County

Area 026 33.5%

Bladen County
Hoke County
Richmond County
Robeson County
Sampson County
Scotland County

Area 027 24.7%

Chatham County
Franklin County
Granville County
Harnett County
Johnston County
Lee County
Person County
Vance County
Warren County

Area 028 15.5%

Alleghany County
Ashe County
Caswell County
Davie County
Montgomery County
Moore County
Rockingham County
Surry County
Watauga County
Wilkes County

Area 029 15.7%

Alexander County
Anson County
Burke County
Cabarrus County
Caldwell County
Catawba County
Cleveland County
Iredell County
Lincoln County
Polk County
Rowan County
Rutherford County
Stanly County

Area 0480 8.5%

Buncombe County
Madison County

Area 030 6.3%

Avery County
Cherokee County
Clay County
Graham County
Haywood County
Henderson County
Jackson County
McDowell County
Macon County
Mitchell County
Swain County
Transylvania County
Yancey County

SMSA Areas

Area 5720 26.6%

Currituck County

Area 9200 20.7%

Brunswick County

New Hanover County

Area 2560 24.2%

Cumberland County

Area 6640 22.8%

Durham County

Orange County

Wake County

Area 1300 16.2%

Alamance County

Area 3120 16.4%

Davidson County

Forsyth County

Guilford County

Randolph County

Stokes County

Yadkin County

Area 1520 18.3%

Gaston County

Mecklenburg County

Union County

Goals for Female

Participation in Each Trade

(Statewide) 6.9%

STANDARD SPECIAL PROVISION**REQUIRED CONTRACT PROVISIONS FEDERAL - AID CONSTRUCTION CONTRACTS**

FHWA - 1273 Electronic Version - May 1, 2012

Z-8

- I. General
- II. Nondiscrimination
- III. Nonsegregated Facilities
- IV. Davis-Bacon and Related Act Provisions
- V. Contract Work Hours and Safety Standards Act Provisions
- VI. Subletting or Assigning the Contract
- VII. Safety: Accident Prevention
- VIII. False Statements Concerning Highway Projects
- IX. Implementation of Clean Air Act and Federal Water Pollution Control Act
- X. Compliance with Governmentwide Suspension and Debarment Requirements
- XI. Certification Regarding Use of Contract Funds for Lobbying

ATTACHMENTS

- A. Employment and Materials Preference for Appalachian Development Highway System or Appalachian Local Access Road Contracts (included in Appalachian contracts only)

I. GENERAL

1. Form FHWA-1273 must be physically incorporated in each construction contract funded under Title 23 (excluding emergency contracts solely intended for debris removal). The contractor (or subcontractor) must insert this form in each subcontract and further require its inclusion in all lower tier subcontracts (excluding purchase orders, rental agreements and other agreements for supplies or services).
The applicable requirements of Form FHWA-1273 are incorporated by reference for work done under any purchase order, rental agreement or agreement for other services. The prime contractor shall be responsible for compliance by any subcontractor, lower-tier subcontractor or service provider.
Form FHWA-1273 must be included in all Federal-aid design-build contracts, in all subcontracts and in lower tier subcontracts (excluding subcontracts for design services, purchase orders, rental agreements and other agreements for supplies or services). The design-builder shall be responsible for compliance by any subcontractor, lower-tier subcontractor or service provider.
Contracting agencies may reference Form FHWA-1273 in bid proposal or request for proposal documents, however, the Form FHWA-1273 must be physically incorporated (not referenced) in all contracts, subcontracts and lower-tier subcontracts (excluding purchase orders, rental agreements and other agreements for supplies or services related to a construction contract).
2. Subject to the applicability criteria noted in the following sections, these contract provisions shall apply to all work performed on the contract by the contractor's own organization and with the assistance of workers under the contractor's immediate superintendence and to all work performed on the contract by piecework, station work, or by subcontract.
3. A breach of any of the stipulations contained in these Required Contract Provisions may be sufficient grounds for withholding of progress payments, withholding of final payment, termination of the contract, suspension / debarment or any other action determined to be appropriate by the contracting agency and FHWA.
4. Selection of Labor: During the performance of this contract, the contractor shall not use convict labor for any purpose within the limits of a construction project on a Federal-aid highway unless it is labor performed by convicts who are on parole, supervised release, or probation. The term Federal-aid highway does not include roadways functionally classified as local roads or rural minor collectors.

II. NONDISCRIMINATION

The provisions of this section related to 23 CFR Part 230 are applicable to all Federal-aid construction contracts and to all related construction subcontracts of \$10,000 or more. The provisions of 23 CFR Part 230 are not applicable to material supply, engineering, or architectural service contracts.

In addition, the contractor and all subcontractors must comply with the following policies: Executive Order 11246, 41 CFR 60, 29 CFR 1625-1627, Title 23 USC Section 140, the Rehabilitation Act of 1973, as amended (29 USC 794), Title VI of the Civil Rights Act of 1964, as amended, and related regulations including 49 CFR Parts 21, 26 and 27; and 23 CFR Parts 200, 230, and 633.

The contractor and all subcontractors must comply with: the requirements of the Equal Opportunity Clause in 41 CFR 60-1.4(b) and, for all construction contracts exceeding \$10,000, the Standard Federal Equal Employment Opportunity Construction Contract Specifications in 41 CFR 60-4.3.

Note: The U.S. Department of Labor has exclusive authority to determine compliance with Executive Order 11246 and the policies of the Secretary of Labor including 41 CFR 60, and 29 CFR 1625-1627. The contracting agency and the FHWA have the authority and the responsibility to ensure compliance with Title 23 USC Section 140, the Rehabilitation Act of 1973, as amended (29 USC 794), and Title VI of the Civil Rights Act of 1964, as amended, and related regulations including 49 CFR Parts 21, 26 and 27; and 23 CFR Parts 200, 230, and 633.

The following provision is adopted from 23 CFR 230, Appendix A, with appropriate revisions to conform to the U.S. Department of Labor (US DOL) and FHWA requirements.

1. **Equal Employment Opportunity:** Equal employment opportunity (EEO) requirements not to discriminate and to take affirmative action to assure equal opportunity as set forth under laws, executive orders, rules, regulations (28 CFR 35, 29 CFR 1630, 29 CFR 1625-1627, 41 CFR 60 and 49 CFR 27) and orders of the Secretary of Labor as modified by the provisions prescribed herein, and imposed pursuant to 23 U.S.C. 140 shall constitute the EEO and specific affirmative action standards for the contractor's project activities under this contract. The provisions of the Americans with Disabilities Act of 1990 (42 U.S.C. 12101 et seq.) set forth under 28 CFR 35 and 29 CFR 1630 are incorporated by reference in this contract. In the execution of this contract, the contractor agrees to comply with the following minimum specific requirement activities of EEO:
 - a. The contractor will work with the contracting agency and the Federal Government to ensure that it has made every good faith effort to provide equal opportunity with respect to all of its terms and conditions of employment and in their review of activities under the contract.
 - b. The contractor will accept as its operating policy the following statement:

"It is the policy of this Company to assure that applicants are employed, and that employees are treated during employment, without regard to their race, religion, sex, color, national origin, age or disability. Such action shall include: employment, upgrading, demotion, or transfer; recruitment or recruitment advertising; layoff or termination; rates of pay or other forms of compensation; and selection for training, including apprenticeship, pre-apprenticeship, and/or on-the-job training."

2. **EEO Officer:** The contractor will designate and make known to the contracting officers an EEO Officer who will have the responsibility for and must be capable of effectively administering and promoting an active EEO program and who must be assigned adequate authority and responsibility to do so.
3. **Dissemination of Policy:** All members of the contractor's staff who are authorized to hire, supervise, promote, and discharge employees, or who recommend such action, or who are substantially involved in such action, will be made fully cognizant of, and will implement, the contractor's EEO policy and contractual responsibilities to provide EEO in each grade and classification of employment. To ensure that the above agreement will be met, the following actions will be taken as a minimum:
 - a. Periodic meetings of supervisory and personnel office employees will be conducted before the start of work and then not less often than once every six months, at which time the contractor's EEO policy and its implementation will be reviewed and explained. The meetings will be conducted by the EEO Officer.
 - b. All new supervisory or personnel office employees will be given a thorough indoctrination by the EEO Officer, covering all major aspects of the contractor's EEO obligations within thirty days following their reporting for duty with the contractor.
 - c. All personnel who are engaged in direct recruitment for the project will be instructed by the EEO Officer in the contractor's procedures for locating and hiring minorities and women.
 - d. Notices and posters setting forth the contractor's EEO policy will be placed in areas readily accessible to employees, applicants for employment and potential employees.
 - e. The contractor's EEO policy and the procedures to implement such policy will be brought to the attention of employees by means of meetings, employee handbooks, or other appropriate means.
4. **Recruitment:** When advertising for employees, the contractor will include in all advertisements for employees the notation: "An Equal Opportunity Employer." All such advertisements will be placed in publications having a large circulation among minorities and women in the area from which the project work force would normally be derived.
 - a. The contractor will, unless precluded by a valid bargaining agreement, conduct systematic and direct recruitment through public and private employee referral sources likely to yield qualified minorities and women. To meet this requirement, the contractor will identify sources of potential minority group employees, and establish with such identified sources procedures whereby minority and women applicants may be referred to the contractor for employment consideration.
 - b. In the event the contractor has a valid bargaining agreement providing for exclusive hiring hall referrals, the contractor is expected to observe the provisions of that agreement to the extent that the system meets the contractor's compliance with EEO contract provisions. Where implementation of such an agreement has the effect of discriminating against minorities or women, or obligates the contractor to do the same, such implementation violates Federal nondiscrimination provisions.
 - c. The contractor will encourage its present employees to refer minorities and women as applicants for employment. Information and procedures with regard to referring such applicants will be discussed with employees.
5. **Personnel Actions:** Wages, working conditions, and employee benefits shall be established and administered, and personnel actions of every type, including hiring, upgrading, promotion, transfer, demotion, layoff, and termination, shall be taken without regard to race, color, religion, sex, national origin, age or disability. The following procedures shall be followed:
 - a. The contractor will conduct periodic inspections of project sites to insure that working conditions and employee facilities do not indicate discriminatory treatment of project site personnel.
 - b. The contractor will periodically evaluate the spread of wages paid within each classification to determine any evidence of discriminatory wage practices.
 - c. The contractor will periodically review selected personnel actions in depth to determine whether there is evidence of discrimination. Where evidence is found, the contractor will promptly take corrective action. If the review indicates that the discrimination may extend beyond the actions reviewed, such corrective action shall include all affected persons.
 - d. The contractor will promptly investigate all complaints of alleged discrimination made to the contractor in connection with its obligations under this contract, will attempt to resolve such complaints, and will take appropriate corrective action within a reasonable time. If the investigation indicates that the discrimination may affect persons other than the complainant, such corrective action shall include such other persons. Upon completion of each investigation, the contractor will inform every complainant of all of their avenues of appeal.
6. **Training and Promotion:**
 - a. The contractor will assist in locating, qualifying, and increasing the skills of minorities and women who are applicants for employment or current employees. Such efforts should be aimed at developing full journey level status employees in the type of trade or job classification involved.
 - b. Consistent with the contractor's work force requirements and as permissible under Federal and State regulations, the contractor shall make full use of training programs, i.e., apprenticeship, and on-the-job training programs for the geographical area of contract performance. In the event a special provision for training is provided under this contract, this subparagraph will be superseded as indicated in the special provision. The contracting agency may reserve training positions for persons who receive welfare assistance in accordance with 23 U.S.C. 140(a).
 - c. The contractor will advise employees and applicants for employment of available training programs and entrance requirements for each.
 - d. The contractor will periodically review the training and promotion potential of employees who are minorities and women and will encourage eligible employees to apply for such training and promotion.
7. **Unions:** If the contractor relies in whole or in part upon unions as a source of employees, the contractor will use good faith efforts to obtain the cooperation of such unions to increase opportunities for minorities and women. Actions by the contractor, either directly or through a contractor's association acting as agent, will include the procedures set forth below:
 - a. The contractor will use good faith efforts to develop, in cooperation with the unions, joint training programs aimed toward qualifying more minorities and women for membership in the unions and increasing the skills of minorities and women so that they may qualify for higher paying employment.
 - b. The contractor will use good faith efforts to incorporate an EEO clause into each union agreement to the end that such union will be contractually bound to refer applicants without regard to their race, color, religion, sex, national origin, age or disability.
 - c. The contractor is to obtain information as to the referral practices and policies of the labor union except that to the extent such information is within the exclusive possession of the labor union and such labor union refuses to furnish such information to the contractor, the contractor shall so certify to the contracting agency and shall set forth what efforts have been made to obtain such information.

- d. In the event the union is unable to provide the contractor with a reasonable flow of referrals within the time limit set forth in the collective bargaining agreement, the contractor will, through independent recruitment efforts, fill the employment vacancies without regard to race, color, religion, sex, national origin, age or disability; making full efforts to obtain qualified and/or qualifiable minorities and women. The failure of a union to provide sufficient referrals (even though it is obligated to provide exclusive referrals under the terms of a collective bargaining agreement) does not relieve the contractor from the requirements of this paragraph. In the event the union referral practice prevents the contractor from meeting the obligations pursuant to Executive Order 11246, as amended, and these special provisions, such contractor shall immediately notify the contracting agency.
8. **Reasonable Accommodation for Applicants / Employees with Disabilities:** The contractor must be familiar with the requirements for and comply with the Americans with Disabilities Act and all rules and regulations established there under. Employers must provide reasonable accommodation in all employment activities unless to do so would cause an undue hardship.
9. **Selection of Subcontractors, Procurement of Materials and Leasing of Equipment:** The contractor shall not discriminate on the grounds of race, color, religion, sex, national origin, age or disability in the selection and retention of subcontractors, including procurement of materials and leases of equipment. The contractor shall take all necessary and reasonable steps to ensure nondiscrimination in the administration of this contract.
- a. The contractor shall notify all potential subcontractors and suppliers and lessors of their EEO obligations under this contract.
- b. The contractor will use good faith efforts to ensure subcontractor compliance with their EEO obligations.
10. **Assurance Required by 49 CFR 26.13(b):**
- a. The requirements of 49 CFR Part 26 and the State DOT's U.S. DOT-approved DBE program are incorporated by reference.
- b. The contractor or subcontractor shall not discriminate on the basis of race, color, national origin, or sex in the performance of this contract. The contractor shall carry out applicable requirements of 49 CFR Part 26 in the award and administration of DOT-assisted contracts. Failure by the contractor to carry out these requirements is a material breach of this contract, which may result in the termination of this contract or such other remedy as the contracting agency deems appropriate.
11. **Records and Reports:** The contractor shall keep such records as necessary to document compliance with the EEO requirements. Such records shall be retained for a period of three years following the date of the final payment to the contractor for all contract work and shall be available at reasonable times and places for inspection by authorized representatives of the contracting agency and the FHWA.
- a. The records kept by the contractor shall document the following:
- (1) The number and work hours of minority and non-minority group members and women employed in each work classification on the project;
- (2) The progress and efforts being made in cooperation with unions, when applicable, to increase employment opportunities for minorities and women; and
- (3) The progress and efforts being made in locating, hiring, training, qualifying, and upgrading minorities and women;
- b. The contractors and subcontractors will submit an annual report to the contracting agency each July for the duration of the project, indicating the number of minority, women, and non-minority group employees currently engaged in each work classification required by the contract work. This information is to be reported on Form FHWA-1391. The staffing data should represent the project work force on board in all or any part of the last payroll period preceding the end of July. If on-the-job training is being required by special provision, the contractor will be required to collect and report training data. The employment data should reflect the work force on board during all or any part of the last payroll period preceding the end of July.

III. NONSEGREGATED FACILITIES

This provision is applicable to all Federal-aid construction contracts and to all related construction subcontracts of \$10,000 or more.

The contractor must ensure that facilities provided for employees are provided in such a manner that segregation on the basis of race, color, religion, sex, or national origin cannot result. The contractor may neither require such segregated use by written or oral policies nor tolerate such use by employee custom. The contractor's obligation extends further to ensure that its employees are not assigned to perform their services at any location, under the contractor's control, where the facilities are segregated. The term "facilities" includes waiting rooms, work areas, restaurants and other eating areas, time clocks, restrooms, washrooms, locker rooms, and other storage or dressing areas, parking lots, drinking fountains, recreation or entertainment areas, transportation, and housing provided for employees. The contractor shall provide separate or single-user restrooms and necessary dressing or sleeping areas to assure privacy between sexes.

IV. DAVIS-BACON AND RELATED ACT PROVISIONS

This section is applicable to all Federal-aid construction projects exceeding \$2,000 and to all related subcontracts and lower-tier subcontracts (regardless of subcontract size). The requirements apply to all projects located within the right-of-way of a roadway that is functionally classified as Federal-aid highway. This excludes roadways functionally classified as local roads or rural minor collectors, which are exempt. Contracting agencies may elect to apply these requirements to other projects.

The following provisions are from the U.S. Department of Labor regulations in 29 CFR 5.5 "Contract provisions and related matters" with minor revisions to conform to the FHWA-1273 format and FHWA program requirements.

1. Minimum wages

- a. All laborers and mechanics employed or working upon the site of the work, will be paid unconditionally and not less often than once a week, and without subsequent deduction or rebate on any account (except such payroll deductions as are permitted by regulations issued by the Secretary of Labor under the Copeland Act (29 CFR part 3)), the full amount of wages and bona fide fringe benefits (or cash equivalents thereof) due at time of payment computed at rates not less than those contained in the wage determination of the Secretary of Labor which is attached hereto and made a part hereof, regardless of any contractual relationship which may be alleged to exist between the contractor and such laborers and mechanics.

Contributions made or costs reasonably anticipated for bona fide fringe benefits under section 1(b)(2) of the Davis-Bacon Act on behalf of laborers or mechanics are considered wages paid to such laborers or mechanics, subject to the provisions of paragraph 1.d. of this section; also, regular contributions made or costs incurred for more than a weekly period (but not less often than quarterly) under plans, funds, or programs which cover the particular weekly period, are deemed to be constructively made or incurred during such weekly period. Such laborers and mechanics shall be paid the appropriate wage rate and fringe benefits on the wage determination for the classification of work actually performed, without regard to skill, except as provided in 29 CFR 5.5(a)(4). Laborers or mechanics performing work in more than one classification may be compensated at the rate specified for each classification for the time actually worked therein: Provided, That the employer's payroll records accurately set forth the time spent in each classification in which work is performed. The wage determination (including any additional classification and wage rates conformed under paragraph 1.b. of this section) and the Davis-Bacon poster (WH-1321) shall be posted at all times by the contractor and its subcontractors at the site of the work in a prominent and accessible place where it can be easily seen by the workers.

- b. (1) The contracting officer shall require that any class of laborers or mechanics, including helpers, which is not listed in the wage determination and which is to be employed under the contract shall be classified in conformance with the wage determination. The contracting officer shall approve an additional classification and wage rate and fringe benefits therefore only when the following criteria have been met:
 - (i) The work to be performed by the classification requested is not performed by a classification in the wage determination; and
 - (ii) The classification is utilized in the area by the construction industry; and
 - (iii) The proposed wage rate, including any bona fide fringe benefits, bears a reasonable relationship to the wage rates contained in the wage determination.
- (2) If the contractor and the laborers and mechanics to be employed in the classification (if known), or their representatives, and the contracting officer agree on the classification and wage rate (including the amount designated for fringe benefits where appropriate), a report of the action taken shall be sent by the contracting officer to the Administrator of the Wage and Hour Division, Employment Standards Administration, U.S. Department of Labor, Washington, DC 20210. The Administrator, or an authorized representative, will approve, modify, or disapprove every additional classification action within 30 days of receipt and so advise the contracting officer or will notify the contracting officer within the 30-day period that additional time is necessary.
- (3) In the event the contractor, the laborers or mechanics to be employed in the classification or their representatives, and the contracting officer do not agree on the proposed classification and wage rate (including the amount designated for fringe benefits, where appropriate), the contracting officer shall refer the questions, including the views of all interested parties and the recommendation of the contracting officer, to the Wage and Hour Administrator for determination. The Wage and Hour Administrator, or an authorized representative, will issue a determination within 30 days of receipt and so advise the contracting officer or will notify the contracting officer within the 30-day period that additional time is necessary.
- (4) The wage rate (including fringe benefits where appropriate) determined pursuant to paragraphs 1.b.(2) or 1.b.(3) of this section, shall be paid to all workers performing work in the classification under this contract from the first day on which work is performed in the classification.
- c. Whenever the minimum wage rate prescribed in the contract for a class of laborers or mechanics includes a fringe benefit which is not expressed as an hourly rate, the contractor shall either pay the benefit as stated in the wage determination or shall pay another bona fide fringe benefit or an hourly cash equivalent thereof.
- d. If the contractor does not make payments to a trustee or other third person, the contractor may consider as part of the wages of any laborer or mechanic the amount of any costs reasonably anticipated in providing bona fide fringe benefits under a plan or program. Provided, That the Secretary of Labor has found, upon the written request of the contractor, that the applicable standards of the Davis-Bacon Act have been met. The Secretary of Labor may require the contractor to set aside in a separate account assets for the meeting of obligations under the plan or program.
2. **Withholding.** The contracting agency shall upon its own action or upon written request of an authorized representative of the Department of Labor, withhold or cause to be withheld from the contractor under this contract, or any other Federal contract with the same prime contractor, or any other federally-assisted contract subject to Davis-Bacon prevailing wage requirements, which is held by the same prime contractor, so much of the accrued payments or advances as may be considered necessary to pay laborers and mechanics, including apprentices, trainees, and helpers, employed by the contractor or any subcontractor the full amount of wages required by the contract. In the event of failure to pay any laborer or mechanic, including any apprentice, trainee, or helper, employed or working on the site of the work, all or part of the wages required by the contract, the contracting agency may, after written notice to the contractor, take such action as may be necessary to cause the suspension of any further payment, advance, or guarantee of funds until such violations have ceased.
3. **Payrolls and basic records**
 - a. Payrolls and basic records relating thereto shall be maintained by the contractor during the course of the work and preserved for a period of three years thereafter for all laborers and mechanics working at the site of the work. Such records shall contain the name, address, and social security number of each such worker, his or her correct classification, hourly rates of wages paid (including rates of contributions or costs anticipated for bona fide fringe benefits or cash equivalents thereof of the types described in section 1(b)(2)(B) of the Davis-Bacon Act), daily and weekly number of hours worked, deductions made and actual wages paid. Whenever the Secretary of Labor has found under 29 CFR 5.5(a)(1)(iv) that the wages of any laborer or mechanic include the amount of any costs reasonably anticipated in providing benefits under a plan or program described in section 1(b)(2)(B) of the Davis-Bacon Act, the contractor shall maintain records which show that the commitment to provide such benefits is enforceable, that the plan or program is financially responsible, and that the plan or program has been communicated in writing to the laborers or mechanics affected, and records which show the costs anticipated or the actual cost incurred in providing such benefits. Contractors employing apprentices or trainees under approved programs shall maintain written evidence of the registration of apprenticeship programs and certification of trainee programs, the registration of the apprentices and trainees, and the ratios and wage rates prescribed in the applicable programs.
 - b. (1) The contractor shall submit weekly for each week in which any contract work is performed a copy of all payrolls to the contracting agency. The payrolls submitted shall set out accurately and completely all of the information required to be maintained under 29 CFR 5.5(a)(3)(i), except that full social security numbers and home addresses shall not be included on weekly transmittals. Instead the payrolls shall only need to include an individually identifying number for each employee (e.g. , the last four digits of the employee's social security number). The required weekly payroll information may be submitted in any form desired. Optional Form WH-347 is available for this purpose from the Wage and Hour Division Web site at <http://www.dol.gov/esa/whd/forms/wh347instr.htm> or its successor site. The prime contractor is responsible for the submission of copies of payrolls by all subcontractors. Contractors and subcontractors shall maintain the full social security number and current address of each covered worker, and shall provide them upon request to the contracting agency for transmission to the State DOT, the FHWA or the Wage and Hour Division of the Department of Labor for purposes of an investigation or audit of compliance with prevailing wage requirements. It is not a violation of this section for a prime contractor to require a subcontractor to provide addresses and social security numbers to the prime contractor for its own records, without weekly submission to the contracting agency.
 - (2) Each payroll submitted shall be accompanied by a "Statement of Compliance," signed by the contractor or subcontractor or his or her agent who pays or supervises the payment of the persons employed under the contract and shall certify the following:
 - (i) That the payroll for the payroll period contains the information required to be provided under §5.5 (a)(3)(ii) of Regulations, 29 CFR part 5, the appropriate information is being maintained under §5.5 (a)(3)(i) of Regulations, 29 CFR part 5, and that such information is correct and complete;
 - (ii) That each laborer or mechanic (including each helper, apprentice, and trainee) employed on the contract during the payroll period has been paid the full weekly wages earned, without rebate, either directly or indirectly, and that no deductions have been made either directly or indirectly from the full wages earned, other than permissible deductions as set forth in Regulations, 29 CFR part 3;
 - (iii) That each laborer or mechanic has been paid not less than the applicable wage rates and fringe benefits or cash equivalents for the classification of work performed, as specified in the applicable wage determination incorporated into the contract.

- (3) The weekly submission of a properly executed certification set forth on the reverse side of Optional Form WH-347 shall satisfy the requirement for submission of the "Statement of Compliance" required by paragraph 3.b.(2) of this section.
 - (4) The falsification of any of the above certifications may subject the contractor or subcontractor to civil or criminal prosecution under section 1001 of title 18 and section 231 of title 31 of the United States Code.
 - c. The contractor or subcontractor shall make the records required under paragraph 3.a. of this section available for inspection, copying, or transcription by authorized representatives of the contracting agency, the State DOT, the FHWA, or the Department of Labor, and shall permit such representatives to interview employees during working hours on the job. If the contractor or subcontractor fails to submit the required records or to make them available, the FHWA may, after written notice to the contractor, the contracting agency or the State DOT, take such action as may be necessary to cause the suspension of any further payment, advance, or guarantee of funds. Furthermore, failure to submit the required records upon request or to make such records available may be grounds for debarment action pursuant to 29 CFR 5.12.
- 4. Apprentices and trainees**
- a. Apprentices (programs of the USDOL). Apprentices will be permitted to work at less than the predetermined rate for the work they performed when they are employed pursuant to and individually registered in a bona fide apprenticeship program registered with the U.S. Department of Labor, Employment and Training Administration, Office of Apprenticeship Training, Employer and Labor Services, or with a State Apprenticeship Agency recognized by the Office, or if a person is employed in his or her first 90 days of probationary employment as an apprentice in such an apprenticeship program, who is not individually registered in the program, but who has been certified by the Office of Apprenticeship Training, Employer and Labor Services or a State Apprenticeship Agency (where appropriate) to be eligible for probationary employment as an apprentice.

The allowable ratio of apprentices to journeymen on the job site in any craft classification shall not be greater than the ratio permitted to the contractor as to the entire work force under the registered program. Any worker listed on a payroll at an apprentice wage rate, who is not registered or otherwise employed as stated above, shall be paid not less than the applicable wage rate on the wage determination for the classification of work actually performed. In addition, any apprentice performing work on the job site in excess of the ratio permitted under the registered program shall be paid not less than the applicable wage rate on the wage determination for the work actually performed. Where a contractor is performing construction on a project in a locality other than that in which its program is registered, the ratios and wage rates (expressed in percentages of the journeyman's hourly rate) specified in the contractor's or subcontractor's registered program shall be observed.

Every apprentice must be paid at not less than the rate specified in the registered program for the apprentice's level of progress, expressed as a percentage of the journeymen hourly rate specified in the applicable wage determination. Apprentices shall be paid fringe benefits in accordance with the provisions of the apprenticeship program. If the apprenticeship program does not specify fringe benefits, apprentices must be paid the full amount of fringe benefits listed on the wage determination for the applicable classification. If the Administrator determines that a different practice prevails for the applicable apprentice classification, fringes shall be paid in accordance with that determination.

In the event the Office of Apprenticeship Training, Employer and Labor Services, or a State Apprenticeship Agency recognized by the Office, withdraws approval of an apprenticeship program, the contractor will no longer be permitted to utilize apprentices at less than the applicable predetermined rate for the work performed until an acceptable program is approved.
 - b. Trainees (programs of the USDOL). Except as provided in 29 CFR 5.16, trainees will not be permitted to work at less than the predetermined rate for the work performed unless they are employed pursuant to and individually registered in a program which has received prior approval, evidenced by formal certification by the U.S. Department of Labor, Employment and Training Administration.

The ratio of trainees to journeymen on the job site shall not be greater than permitted under the plan approved by the Employment and Training Administration.

Every trainee must be paid at not less than the rate specified in the approved program for the trainee's level of progress, expressed as a percentage of the journeyman hourly rate specified in the applicable wage determination. Trainees shall be paid fringe benefits in accordance with the provisions of the trainee program. If the trainee program does not mention fringe benefits, trainees shall be paid the full amount of fringe benefits listed on the wage determination unless the Administrator of the Wage and Hour Division determines that there is an apprenticeship program associated with the corresponding journeyman wage rate on the wage determination which provides for less than full fringe benefits for apprentices. Any employee listed on the payroll at a trainee rate who is not registered and participating in a training plan approved by the Employment and Training Administration shall be paid not less than the applicable wage rate on the wage determination for the classification of work actually performed. In addition, any trainee performing work on the job site in excess of the ratio permitted under the registered program shall be paid not less than the applicable wage rate on the wage determination for the work actually performed.

In the event the Employment and Training Administration withdraws approval of a training program, the contractor will no longer be permitted to utilize trainees at less than the applicable predetermined rate for the work performed until an acceptable program is approved.
 - c. Equal employment opportunity. The utilization of apprentices, trainees and journeymen under this part shall be in conformity with the equal employment opportunity requirements of Executive Order 11246, as amended, and 29 CFR part 30.
 - d. Apprentices and Trainees (programs of the U.S. DOT). Apprentices and trainees working under apprenticeship and skill training programs which have been certified by the Secretary of Transportation as promoting EEO in connection with Federal-aid highway construction programs are not subject to the requirements of paragraph 4 of this Section IV. The straight time hourly wage rates for apprentices and trainees under such programs will be established by the particular programs. The ratio of apprentices and trainees to journeymen shall not be greater than permitted by the terms of the particular program.
5. **Compliance with Copeland Act requirements.** The contractor shall comply with the requirements of 29 CFR part 3, which are incorporated by reference in this contract.
 6. **Subcontracts.** The contractor or subcontractor shall insert Form FHWA-1273 in any subcontracts and also require the subcontractors to include Form FHWA-1273 in any lower tier subcontracts. The prime contractor shall be responsible for the compliance by any subcontractor or lower tier subcontractor with all the contract clauses in 29 CFR 5.5.
 7. **Contract termination:** debarment. A breach of the contract clauses in 29 CFR 5.5 may be grounds for termination of the contract, and for debarment as a contractor and a subcontractor as provided in 29 CFR 5.12.
 8. **Compliance with Davis-Bacon and Related Act requirements.** All rulings and interpretations of the Davis-Bacon and Related Acts contained in 29 CFR parts 1, 3, and 5 are herein incorporated by reference in this contract.
 9. **Disputes concerning labor standards.** Disputes arising out of the labor standards provisions of this contract shall not be subject to the general disputes clause of this contract. Such disputes shall be resolved in accordance with the procedures of the Department of Labor set forth in 29 CFR parts 5, 6, and 7. Disputes within the meaning of this clause include disputes between the contractor (or any of its subcontractors) and the contracting agency, the U.S. Department of Labor, or the employees or their representatives.
 10. **Certification of eligibility.**
 - a. By entering into this contract, the contractor certifies that neither it (nor he or she) nor any person or firm who has an interest in the contractor's firm is a person or firm ineligible to be awarded Government contracts by virtue of section 3(a) of the Davis-Bacon Act or 29 CFR 5.12(a)(1).

- b. No part of this contract shall be subcontracted to any person or firm ineligible for award of a Government contract by virtue of section 3(a) of the Davis-Bacon Act or 29 CFR 5.12(a)(1).
- c. The penalty for making false statements is prescribed in the U.S. Criminal Code, 18 U.S.C. 1001.

V. CONTRACT WORK HOURS AND SAFETY STANDARDS ACT

The following clauses apply to any Federal-aid construction contract in an amount in excess of \$100,000 and subject to the overtime provisions of the Contract Work Hours and Safety Standards Act. These clauses shall be inserted in addition to the clauses required by 29 CFR 5.5(a) or 29 CFR 4.6. As used in this paragraph, the terms laborers and mechanics include watchmen and guards.

1. **Overtime requirements.** No contractor or subcontractor contracting for any part of the contract work which may require or involve the employment of laborers or mechanics shall require or permit any such laborer or mechanic in any workweek in which he or she is employed on such work to work in excess of forty hours in such workweek unless such laborer or mechanic receives compensation at a rate not less than one and one-half times the basic rate of pay for all hours worked in excess of forty hours in such workweek.
2. **Violation; liability for unpaid wages; liquidated damages.** In the event of any violation of the clause set forth in paragraph (1.) of this section, the contractor and any subcontractor responsible therefor shall be liable for the unpaid wages. In addition, such contractor and subcontractor shall be liable to the United States (in the case of work done under contract for the District of Columbia or a territory, to such District or to such territory), for liquidated damages. Such liquidated damages shall be computed with respect to each individual laborer or mechanic, including watchmen and guards, employed in violation of the clause set forth in paragraph (1.) of this section, in the sum of \$10 for each calendar day on which such individual was required or permitted to work in excess of the standard workweek of forty hours without payment of the overtime wages required by the clause set forth in paragraph (1.) of this section.
3. **Withholding for unpaid wages and liquidated damages.** The FHWA or the contacting agency shall upon its own action or upon written request of an authorized representative of the Department of Labor withhold or cause to be withheld, from any moneys payable on account of work performed by the contractor or subcontractor under any such contract or any other Federal contract with the same prime contractor, or any other federally-assisted contract subject to the Contract Work Hours and Safety Standards Act, which is held by the same prime contractor, such sums as may be determined to be necessary to satisfy any liabilities of such contractor or subcontractor for unpaid wages and liquidated damages as provided in the clause set forth in paragraph (2.) of this section.
4. **Subcontracts.** The contractor or subcontractor shall insert in any subcontracts the clauses set forth in paragraph (1.) through (4.) of this section and also a clause requiring the subcontractors to include these clauses in any lower tier subcontracts. The prime contractor shall be responsible for compliance by any subcontractor or lower tier subcontractor with the clauses set forth in paragraphs (1.) through (4.) of this section.

VI. SUBLETTING OR ASSIGNING THE CONTRACT

This provision is applicable to all Federal-aid construction contracts on the National Highway System.

1. The contractor shall perform with its own organization contract work amounting to not less than 30 percent (or a greater percentage if specified elsewhere in the contract) of the total original contract price, excluding any specialty items designated by the contracting agency. Specialty items may be performed by subcontract and the amount of any such specialty items performed may be deducted from the total original contract price before computing the amount of work required to be performed by the contractor's own organization (23 CFR 635.116).
 - a. The term "perform work with its own organization" refers to workers employed or leased by the prime contractor, and equipment owned or rented by the prime contractor, with or without operators. Such term does not include employees or equipment of a subcontractor or lower tier subcontractor, agents of the prime contractor, or any other assignees. The term may include payments for the costs of hiring leased employees

from an employee leasing firm meeting all relevant Federal and State regulatory requirements. Leased employees may only be included in this term if the prime contractor meets all of the following conditions:

- (1) the prime contractor maintains control over the supervision of the day-to-day activities of the leased employees;
 - (2) the prime contractor remains responsible for the quality of the work of the leased employees;
 - (3) the prime contractor retains all power to accept or exclude individual employees from work on the project; and
 - (4) the prime contractor remains ultimately responsible for the payment of predetermined minimum wages, the submission of payrolls, statements of compliance and all other Federal regulatory requirements.
- b. "Specialty Items" shall be construed to be limited to work that requires highly specialized knowledge, abilities, or equipment not ordinarily available in the type of contracting organizations qualified and expected to bid or propose on the contract as a whole and in general are to be limited to minor components of the overall contract.
2. The contract amount upon which the requirements set forth in paragraph (1) of Section VI is computed includes the cost of material and manufactured products which are to be purchased or produced by the contractor under the contract provisions.
 3. The contractor shall furnish (a) a competent superintendent or supervisor who is employed by the firm, has full authority to direct performance of the work in accordance with the contract requirements, and is in charge of all construction operations (regardless of who performs the work) and (b) such other of its own organizational resources (supervision, management, and engineering services) as the contracting officer determines is necessary to assure the performance of the contract.
 4. No portion of the contract shall be sublet, assigned or otherwise disposed of except with the written consent of the contracting officer, or authorized representative, and such consent when given shall not be construed to relieve the contractor of any responsibility for the fulfillment of the contract. Written consent will be given only after the contracting agency has assured that each subcontract is evidenced in writing and that it contains all pertinent provisions and requirements of the prime contract.
 5. The 30% self-performance requirement of paragraph (1) is not applicable to design-build contracts; however, contracting agencies may establish their own self-performance requirements.

VII. SAFETY: ACCIDENT PREVENTION

This provision is applicable to all Federal-aid construction contracts and to all related subcontracts.

1. In the performance of this contract the contractor shall comply with all applicable Federal, State, and local laws governing safety, health, and sanitation (23 CFR 635). The contractor shall provide all safeguards, safety devices and protective equipment and take any other needed actions as it determines, or as the contracting officer may determine, to be reasonably necessary to protect the life and health of employees on the job and the safety of the public and to protect property in connection with the performance of the work covered by the contract.
2. It is a condition of this contract, and shall be made a condition of each subcontract, which the contractor enters into pursuant to this contract, that the contractor and any subcontractor shall not permit any employee, in performance of the contract, to work in surroundings or under conditions which are unsanitary, hazardous or dangerous to his/her health or safety, as determined under construction safety and health standards (29 CFR 1926) promulgated by the Secretary of Labor, in accordance with Section 107 of the Contract Work Hours and Safety Standards Act (40 U.S.C. 3704).
3. Pursuant to 29 CFR 1926.3, it is a condition of this contract that the Secretary of Labor or authorized representative thereof, shall have right of entry to any site of contract performance to inspect or investigate the matter of compliance with the construction safety and health standards and to carry out the duties of the Secretary under Section 107 of the Contract Work Hours and Safety Standards Act (40 U.S.C.3704).

VIII. FALSE STATEMENTS CONCERNING HIGHWAY PROJECTS

This provision is applicable to all Federal-aid construction contracts and to all related subcontracts.

In order to assure high quality and durable construction in conformity with approved plans and specifications and a high degree of reliability on statements and representations made by engineers, contractors, suppliers, and workers on Federal-aid highway projects, it is essential that all persons concerned with the project perform their functions as carefully, thoroughly, and honestly as possible. Willful falsification, distortion, or misrepresentation with respect to any facts related to the project is a violation of Federal law. To prevent any misunderstanding regarding the seriousness of these and similar acts, Form FHWA-1022 shall be posted on each Federal-aid highway project (23 CFR 635) in one or more places where it is readily available to all persons concerned with the project:

18 U.S.C. 1020 reads as follows:

"Whoever, being an officer, agent, or employee of the United States, or of any State or Territory, or whoever, whether a person, association, firm, or corporation, knowingly makes any false statement, false representation, or false report as to the character, quality, quantity, or cost of the material used or to be used, or the quantity or quality of the work performed or to be performed, or the cost thereof in connection with the submission of plans, maps, specifications, contracts, or costs of construction on any highway or related project submitted for approval to the Secretary of Transportation; or

Whoever knowingly makes any false statement, false representation, false report or false claim with respect to the character, quality, quantity, or cost of any work performed or to be performed, or materials furnished or to be furnished, in connection with the construction of any highway or related project approved by the Secretary of Transportation; or

Whoever knowingly makes any false statement or false representation as to material fact in any statement, certificate, or report submitted pursuant to provisions of the Federal-aid Roads Act approved July 1, 1916, (39 Stat. 355), as amended and supplemented;

Shall be fined under this title or imprisoned not more than 5 years or both."

IX. IMPLEMENTATION OF CLEAN AIR ACT AND FEDERAL WATER POLLUTION CONTROL ACT

This provision is applicable to all Federal-aid construction contracts and to all related subcontracts.

By submission of this bid/proposal or the execution of this contract, or subcontract, as appropriate, the bidder, proposer, Federal-aid construction contractor, or subcontractor, as appropriate, will be deemed to have stipulated as follows:

1. That any person who is or will be utilized in the performance of this contract is not prohibited from receiving an award due to a violation of Section 508 of the Clean Water Act or Section 306 of the Clean Air Act.
2. That the contractor agrees to include or cause to be included the requirements of paragraph (1) of this Section X in every subcontract, and further agrees to take such action as the contracting agency may direct as a means of enforcing such requirements.

X. CERTIFICATION REGARDING DEBARMENT, SUSPENSION, INELIGIBILITY AND VOLUNTARY EXCLUSION

This provision is applicable to all Federal-aid construction contracts, design-build contracts, subcontracts, lower-tier subcontracts, purchase orders, lease agreements, consultant contracts or any other covered transaction requiring FHWA approval or that is estimated to cost \$25,000 or more – as defined in 2 CFR Parts 180 and 1200.

1. Instructions for Certification – First Tier Participants:

- a. By signing and submitting this proposal, the prospective first tier participant is providing the certification set out below.
- b. The inability of a person to provide the certification set out below will not necessarily result in denial of participation in this covered transaction. The prospective first tier participant shall submit an explanation of why it cannot provide the certification set out below. The certification or explanation will be considered in connection with the department or agency's determination whether to enter into this transaction. However, failure of the prospective first tier participant to furnish a certification or an explanation shall disqualify such a person from participation in this transaction.
- c. The certification in this clause is a material representation of fact upon which reliance was placed when the contracting agency determined to enter into this transaction. If it is later determined that the prospective participant knowingly rendered an erroneous certification, in addition to other remedies available to the Federal Government, the contracting agency may terminate this transaction for cause of default.
- d. The prospective first tier participant shall provide immediate written notice to the contracting agency to whom this proposal is submitted if any time the prospective first tier participant learns that its certification was erroneous when submitted or has become erroneous by reason of changed circumstances.
- e. The terms "covered transaction," "debarred," "suspended," "ineligible," "participant," "person," "principal," and "voluntarily excluded," as used in this clause, are defined in 2 CFR Parts 180 and 1200. "First Tier Covered Transactions" refers to any covered transaction between a grantee or subgrantee of Federal funds and a participant (such as the prime or general contract). "Lower Tier Covered Transactions" refers to any covered transaction under a First Tier Covered Transaction (such as subcontracts). "First Tier Participant" refers to the participant who has entered into a covered transaction with a grantee or subgrantee of Federal funds (such as the prime or general contractor). "Lower Tier Participant" refers any participant who has entered into a covered transaction with a First Tier Participant or other Lower Tier Participants (such as subcontractors and suppliers).
- f. The prospective first tier participant agrees by submitting this proposal that, should the proposed covered transaction be entered into, it shall not knowingly enter into any lower tier covered transaction with a person who is debarred, suspended, declared ineligible, or voluntarily excluded from participation in this covered transaction, unless authorized by the department or agency entering into this transaction.
- g. The prospective first tier participant further agrees by submitting this proposal that it will include the clause titled "Certification Regarding Debarment, Suspension, Ineligibility and Voluntary Exclusion-Lower Tier Covered Transactions," provided by the department or contracting agency, entering into this covered transaction, without modification, in all lower tier covered transactions and in all solicitations for lower tier covered transactions exceeding the \$25,000 threshold.
- h. A participant in a covered transaction may rely upon a certification of a prospective participant in a lower tier covered transaction that is not debarred, suspended, ineligible, or voluntarily excluded from the covered transaction, unless it knows that the certification is erroneous. A participant is responsible for ensuring that its principals are not suspended, debarred, or otherwise ineligible to participate in covered transactions. To verify the eligibility of its principals, as well as the eligibility of any lower tier prospective participants, each participant may, but is not required to, check the Excluded Parties List System website (<https://www.epls.gov/>), which is compiled by the General Services Administration.
- i. Nothing contained in the foregoing shall be construed to require the establishment of a system of records in order to render in good faith the certification required by this clause. The knowledge and information of the prospective participant is not required to exceed that which is normally possessed by a prudent person in the ordinary course of business dealings.
- j. Except for transactions authorized under paragraph (f) of these instructions, if a participant in a covered transaction knowingly enters into a lower tier covered transaction with a person who is suspended, debarred, ineligible, or voluntarily excluded from participation in this transaction, in addition to other remedies available to the Federal Government, the department or agency may terminate this transaction for cause or default.

* * * * *

2. Certification Regarding Debarment, Suspension, Ineligibility and Voluntary Exclusion – First Tier Participants:

- a. The prospective first tier participant certifies to the best of its knowledge and belief, that it and its principals:
 - (1) Are not presently debarred, suspended, proposed for debarment, declared ineligible, or voluntarily excluded from participating in covered transactions by any Federal department or agency;
 - (2) Have not within a three-year period preceding this proposal been convicted of or had a civil judgment rendered against them for commission of fraud or a criminal offense in connection with obtaining, attempting to obtain, or performing a public (Federal, State or local) transaction or contract under a public transaction; violation of Federal or State antitrust statutes or commission of embezzlement, theft, forgery, bribery, falsification or destruction of records, making false statements, or receiving stolen property;
 - (3) Are not presently indicted for or otherwise criminally or civilly charged by a governmental entity (Federal, State or local) with commission of any of the offenses enumerated in paragraph (a)(2) of this certification; and
 - (4) Have not within a three-year period preceding this application/proposal had one or more public transactions (Federal, State or local) terminated for cause or default.
- b. Where the prospective participant is unable to certify to any of the statements in this certification, such prospective participant shall attach an explanation to this proposal.

2. Instructions for Certification - Lower Tier Participants:

(Applicable to all subcontracts, purchase orders and other lower tier transactions requiring prior FHWA approval or estimated to cost \$25,000 or more - 2 CFR Parts 180 and 1200)

- a. By signing and submitting this proposal, the prospective lower tier is providing the certification set out below.
- b. The certification in this clause is a material representation of fact upon which reliance was placed when this transaction was entered into. If it is later determined that the prospective lower tier participant knowingly rendered an erroneous certification, in addition to other remedies available to the Federal Government, the department, or agency with which this transaction originated may pursue available remedies, including suspension and/or debarment.
- c. The prospective lower tier participant shall provide immediate written notice to the person to which this proposal is submitted if at any time the prospective lower tier participant learns that its certification was erroneous by reason of changed circumstances.
- d. The terms "covered transaction," "debarred," "suspended," "ineligible," "participant," "person," "principal," and "voluntarily excluded," as used in this clause, are defined in 2 CFR Parts 180 and 1200. You may contact the person to which this proposal is submitted for assistance in obtaining a copy of those regulations. "First Tier Covered Transactions" refers to any covered transaction between a grantee or subgrantee of

Federal funds and a participant (such as the prime or general contract). "Lower Tier Covered Transactions" refers to any covered transaction under a First Tier Covered Transaction (such as subcontracts). "First Tier Participant" refers to the participant who has entered into a covered transaction with a grantee or subgrantee of Federal funds (such as the prime or general contractor). "Lower Tier Participant" refers to any participant who has entered into a covered transaction with a First Tier Participant or other Lower Tier Participants (such as subcontractors and suppliers).

- e. The prospective lower tier participant agrees by submitting this proposal that, should the proposed covered transaction be entered into, it shall not knowingly enter into any lower tier covered transaction with a person who is debarred, suspended, declared ineligible, or voluntarily excluded from participation in this covered transaction, unless authorized by the department or agency with which this transaction originated.
- f. The prospective lower tier participant further agrees by submitting this proposal that it will include this clause titled "Certification Regarding Debarment, Suspension, Ineligibility and Voluntary Exclusion-Lower Tier Covered Transaction," without modification, in all lower tier covered transactions and in all solicitations for lower tier covered transactions exceeding the \$25,000 threshold.
- g. A participant in a covered transaction may rely upon a certification of a prospective participant in a lower tier covered transaction that is not debarred, suspended, ineligible, or voluntarily excluded from the covered transaction, unless it knows that the certification is erroneous. A participant is responsible for ensuring that its principals are not suspended, debarred, or otherwise ineligible to participate in covered transactions. To verify the eligibility of its principals, as well as the eligibility of any lower tier prospective participants, each participant may, but is not required to, check the Excluded Parties List System website (<https://www.epls.gov/>), which is compiled by the General Services Administration.
- h. Nothing contained in the foregoing shall be construed to require establishment of a system of records in order to render in good faith the certification required by this clause. The knowledge and information of participant is not required to exceed that which is normally possessed by a prudent person in the ordinary course of business dealings.
- i. Except for transactions authorized under paragraph e of these instructions, if a participant in a covered transaction knowingly enters into a lower tier covered transaction with a person who is suspended, debarred, ineligible, or voluntarily excluded from participation in this transaction, in addition to other remedies available to the Federal Government, the department or agency with which this transaction originated may pursue available remedies, including suspension and/or debarment.

* * * * *

Certification Regarding Debarment, Suspension, Ineligibility and Voluntary Exclusion--Lower Tier Participants:

1. The prospective lower tier participant certifies, by submission of this proposal, that neither it nor its principals is presently debarred, suspended, proposed for debarment, declared ineligible, or voluntarily excluded from participating in covered transactions by any Federal department or agency.
2. Where the prospective lower tier participant is unable to certify to any of the statements in this certification, such prospective participant shall attach an explanation to this proposal.

* * * * *

XI. CERTIFICATION REGARDING USE OF CONTRACT FUNDS FOR LOBBYING

This provision is applicable to all Federal-aid construction contracts and to all related subcontracts which exceed \$100,000 (49 CFR 20).

1. The prospective participant certifies, by signing and submitting this bid or proposal, to the best of his or her knowledge and belief, that:
 - a. No Federal appropriated funds have been paid or will be paid, by or on behalf of the undersigned, to any person for influencing or attempting to influence an officer or employee of any Federal agency, a Member of Congress, an officer or employee of Congress, or an employee of a Member of Congress in connection with the awarding of any Federal contract, the making of any Federal grant, the making of any Federal loan, the entering into of any cooperative agreement, and the extension, continuation, renewal, amendment, or modification of any Federal contract, grant, loan, or cooperative agreement.
 - b. If any funds other than Federal appropriated funds have been paid or will be paid to any person for influencing or attempting to influence an officer or employee of any Federal agency, a Member of Congress, an officer or employee of Congress, or an employee of a Member of Congress in connection with this Federal contract, grant, loan, or cooperative agreement, the undersigned shall complete and submit Standard Form-LLL, "Disclosure Form to Report Lobbying," in accordance with its instructions.
2. This certification is a material representation of fact upon which reliance was placed when this transaction was made or entered into. Submission of this certification is a prerequisite for making or entering into this transaction imposed by 31 U.S.C. 1352. Any person who fails to file the required certification shall be subject to a civil penalty of not less than \$10,000 and not more than \$100,000 for each such failure.
3. The prospective participant also agrees by submitting its bid or proposal that the participant shall require that the language of this certification be included in all lower tier subcontracts, which exceed \$100,000 and that all such recipients shall certify and disclose accordingly.

STANDARD SPECIAL PROVISION**ON-THE-JOB TRAINING**

(10-16-07) (Rev. 4-21-15)

Z-10

Description

The North Carolina Department of Transportation will administer a custom version of the Federal On-the-Job Training (OJT) Program, commonly referred to as the Alternate OJT Program. All contractors (existing and newcomers) will be automatically placed in the Alternate Program. Standard OJT requirements typically associated with individual projects will no longer be applied at the project level. Instead, these requirements will be applicable on an annual basis for each contractor administered by the OJT Program Manager.

On the Job Training shall meet the requirements of 23 CFR 230.107 (b), 23 USC – Section 140, this provision and the On-the-Job Training Program Manual.

The Alternate OJT Program will allow a contractor to train employees on Federal, State and privately funded projects located in North Carolina. However, priority shall be given to training employees on NCDOT Federal-Aid funded projects.

Minorities and Women

Developing, training and upgrading of minorities and women toward journeyman level status is a primary objective of this special training provision. Accordingly, the Contractor shall make every effort to enroll minority and women as trainees to the extent that such persons are available within a reasonable area of recruitment. This training commitment is not intended, and shall not be used, to discriminate against any applicant for training, whether a member of a minority group or not.

Assigning Training Goals

The Department, through the OJT Program Manager, will assign training goals for a calendar year based on the contractors' past three years' activity and the contractors' anticipated upcoming year's activity with the Department. At the beginning of each year, all contractors eligible will be contacted by the Department to determine the number of trainees that will be assigned for the upcoming calendar year. At that time the Contractor shall enter into an agreement with the Department to provide a self-imposed on-the-job training program for the calendar year. This agreement will include a specific number of annual training goals agreed to by both parties. The number of training assignments may range from 1 to 15 per contractor per calendar year. The Contractor shall sign an agreement to fulfill their annual goal for the year.\

Training Classifications

The Contractor shall provide on-the-job training aimed at developing full journeyman level workers in the construction craft/operator positions. Preference shall be given to providing training in the following skilled work classifications:

Equipment Operators	Office Engineers
Truck Drivers	Estimators
Carpenters	Iron / Reinforcing Steel Workers
Concrete Finishers	Mechanics
Pipe Layers	Welders

The Department has established common training classifications and their respective training requirements that may be used by the contractors. However, the classifications established are not all-inclusive. Where the training is oriented toward construction applications, training will be allowed in lower-level management positions such as office engineers and estimators. Contractors shall submit new classifications for specific job functions that their employees are performing. The Department will review and recommend for acceptance to FHWA the new classifications proposed by contractors, if applicable. New classifications shall meet the following requirements:

Proposed training classifications are reasonable and realistic based on the job skill classification needs, and

The number of training hours specified in the training classification is consistent with common practices and provides enough time for the trainee to obtain journeyman level status.

The Contractor may allow trainees to be trained by a subcontractor provided that the Contractor retains primary responsibility for meeting the training and this provision is made applicable to the subcontract. However, only the Contractor will receive credit towards the annual goal for the trainee.

Where feasible, 25 percent of apprentices or trainees in each occupation shall be in their first year of apprenticeship or training. The number of trainees shall be distributed among the work classifications on the basis of the contractor's needs and the availability of journeymen in the various classifications within a reasonable area of recruitment.

No employee shall be employed as a trainee in any classification in which they have successfully completed a training course leading to journeyman level status or in which they have been employed as a journeyman.

Records and Reports

The Contractor shall maintain enrollment, monthly and completion reports documenting company compliance under these contract documents. These documents and any other information as requested shall be submitted to the OJT Program Manager.

Upon completion and graduation of the program, the Contractor shall provide each trainee with a certification Certificate showing the type and length of training satisfactorily completed.

Trainee Interviews

All trainees enrolled in the program will receive an initial and Trainee/Post graduate interview conducted by the OJT program staff.

Trainee Wages

Contractors shall compensate trainees on a graduating pay scale based upon a percentage of the prevailing minimum journeyman wages (Davis-Bacon Act). Minimum pay shall be as follows:

60 percent	of the journeyman wage for the first half of the training period
75 percent	of the journeyman wage for the third quarter of the training period
90 percent	of the journeyman wage for the last quarter of the training period

In no instance shall a trainee be paid less than the local minimum wage. The Contractor shall adhere to the minimum hourly wage rate that will satisfy both the NC Department of Labor (NCDOL) and the Department.

Achieving or Failing to Meet Training Goals

The Contractor will be credited for each trainee employed by him on the contract work who is currently enrolled or becomes enrolled in an approved program and who receives training for at least 50 percent of the specific program requirement. Trainees will be allowed to be transferred between projects if required by the Contractor's scheduled workload to meet training goals.

If a contractor fails to attain their training assignments for the calendar year, they may be taken off the NCDOT's Bidders List.

Measurement and Payment

No compensation will be made for providing required training in accordance with these contract documents.

STANDARD SPECIAL PROVISION
MINIMUM WAGES
GENERAL DECISION NC20210090 01/01/2021 NC90

Z-090

Date: January 1, 2021

General Decision Number: NC20210090 01/01/2021 NC90

Superseded General Decision Numbers: NC20200090

State: North Carolina

Construction Type: HIGHWAY

COUNTIES:

Brunswick	Greene	Onslow
Cumberland	Hoke	Pender
Currituck	Johnston	Pitt
Edgecombe	Nash	Wake
Franklin	New Hanover	Wayne

HIGHWAY CONSTRUCTION PROJECTS (excluding tunnels, building structures in rest area projects & railroad construction; bascule, suspension & spandrel arch bridges designed for commercial navigation, bridges involving marine construction; and other major bridges).

Note: Under Executive Order (EO) 13658, an hourly minimum wage of \$10.95 for calendar year 2021 applies to all contracts subject to the Davis-Bacon Act for which the contract is awarded (and any solicitation was issued) on or after January 1, 2015. If this contract is covered by the EO, the contractor must pay all workers in any classification listed on this wage determination at least \$10.95 per hour (or the applicable wage rate listed on this wage determination, if it is higher) for all hours spent performing on the contract for calendar year 2021. If this contract is covered by the EO and a classification considered necessary for performance of work on the contract does not appear on this wage determination, the contractor must pay workers in that classification at least the wage rate determined through the conformance process set forth in 29 CFR.5.5(a)(1)(ii) (or the EO minimum wage rate, if it is higher than the conformed wage rate). The EO minimum wage rate will be adjusted annually. Please note that this EO applies to the above-mentioned types of contracts entered into by the federal government that are subject to the Davis-Bacon Act itself, but it does not apply to contracts subject only to the Davis-Bacon Related Acts, including those set forth at 29 CFR 5.1(a)(2) – (60). Additional information on contractor requirements and worker protections under the EO is available at www.dol.gov/whd/govcontracts.

Modification Number
0

Publication Date
01/01/2021

SUNC2014-005 11/17/2014

	Rates	Fringes
BLASTER	21.04	
CARPENTER	13.72	
CEMENT MASON/CONCRETE FINISHER	14.48	
ELECTRICIAN		
Electrician	17.97	
Telecommunications Technician	16.79	.63

	Rates	Fringes
IRONWORKER	16.02	
LABORER		
Asphalt Raker and Spreader	12.46	
Asphalt Screed/Jackman	14.33	
Carpenter Tender	12.88	
Cement Mason/Concrete Finisher Tender	12.54	
Common or General	10.20	
Guardrail/Fence Installer	12.87	
Pipelayer	12.17	
Traffic Signal/Lighting Installer	14.89	
PAINTER		
Bridge	24.57	
POWER EQUIPMENT OPERATORS		
Asphalt Broom Tractor	11.85	
Bulldozer Fine	17.04	
Bulldozer Rough	14.34	
Concrete Grinder/Groover	20.34	2.30
Crane Boom Trucks	20.54	
Crane Other	20.08	
Crane Rough/All-Terrain	20.67	
Drill Operator Rock	14.38	
Drill Operator Structure	21.14	
Excavator Fine	16.60	
Excavator Rough	14.00	
Grader/Blade Fine	18.47	
Grader/Blade Rough	14.62	
Loader 2 Cubic Yards or Less	13.76	
Loader Greater Than 2 Cubic Yards	14.14	
Material Transfer Vehicle (Shuttle Buggy)	15.18	
Mechanic	17.55	
Milling Machine	15.36	
Off-Road Hauler/Water Tanker	11.36	
Oiler/Greaser	13.55	
Pavement Marking Equipment	12.11	
Paver Asphalt	15.59	
Paver Concrete	18.20	
Roller Asphalt Breakdown	12.45	
Roller Asphalt Finish	13.85	
Roller Other	11.36	
Scraper Finish	12.71	
Scraper Rough	11.35	
Slip Form Machine	16.50	
Tack Truck/Distributor Operator	14.52	
TRUCK DRIVER		
GVWR of 26,000 Lbs or Less	11.12	
GVWR of 26,001 Lbs or Greater	12.37	

Welders – Receive rate prescribed for craft performing operation to which welding is incidental.
Note: Executive Order (EO) 13706, Establishing Paid Sick Leave for Federal Contractors applies to all contracts subject to the Davis-Bacon Act for which the contract is awarded (and any solicitation was issued) on or after January 1, 2017. If this contract is covered by the EO, the contractor must provide employees with 1 hour of paid sick leave for every 30 hours they work,

up to 56 hours of paid sick leave each year. Employees must be permitted to use paid sick leave for their own illness, injury or other health-related needs, including preventive care; to assist a family member (or person who is like family to the employee) who is ill, injured, or has other health-related needs, including preventive care; or for reasons resulting from, or to assist a family member (or person who is like family to the employee) who is a victim of, domestic violence, sexual assault, or stalking. Additional information on contractor requirements and worker protections under the EO is available at www.dol.gov/whd/govcontracts.

Unlisted classifications needed for work not included within the scope of the classifications listed may be added after award only as provided in the labor standards contract clauses (29 CFR 5.5(a)(1)(ii)).

The body of each wage determination lists the classification and wage rates that have been found to be prevailing for the cited type(s) of construction in the area covered by the wage determination. The classifications are listed in alphabetical order of "identifiers" that indicate whether the particular rate is a union rate (current union negotiated rate for local), a survey rate (weighted average rate) or a union average rate (weighted union average rate).

Union Rate Identifiers

A four letter classification abbreviation identifier enclosed in dotted lines beginning with characters other than "SU" or "UAVG" denotes that the union classification and rate were prevailing for that classification in the survey. Example: PLUM0198-005 07/01/2014. PLUM is an abbreviation identifier of the union which prevailed in the survey for this classification, which in this example would be Plumbers. 0198 indicates the local union number or district council number where applicable, i.e., Plumbers Local 0198. The next number, 005 in the example, is an internal number used in processing the wage determination. 07/01/2014 is the effective date of the most current negotiated rate, which in this example is July 1, 2014.

Union prevailing wage rates are updated to reflect all rate changes in the collective bargaining agreement (CBA) governing this classification and rate.

Survey Rate Identifiers

Classifications listed under the "SU" identifier indicate that no one rate prevailed for this classification in the survey and the published rate is derived by computing a weighted average rate based on all the rates reported in the survey for that classification. As this weighted average rate includes all rates reported in the survey, it may include both union and non-union rates. Example: SULA2012-007 5/13/2014. SU indicates the rates are survey rates based on a weighted average calculation of rates and are not majority rates. LA indicates the State of Louisiana. 2012 is the year of survey on which these classifications and rates are based. The next number, 007 in the example, is an internal number used in producing the wage determination. 5/13/2014 indicates the survey completion date for the classifications and rates under that identifier.

Survey wage rates are not updated and remain in effect until a new survey is conducted.

Union Average Rate Identifiers

Classification(s) listed under the UAVG identifier indicate that no single majority rate prevailed for those classifications; however, 100% of the data reported for the classifications was union data. EXAMPLE: UAVG-OH-0010 08/29/2014. UAVG indicates that the rate is a weighted union average rate. OH indicates the state. The next number, 0010 in the example, is an internal number used in producing the wage determination. 08/29/2014 indicates the survey completion date for the classifications and rates under that identifier.

A UAVG rate will be updated once a year, usually in January of each year, to reflect a weighted average of the current negotiated/CBA rate of the union locals from which the rate is based.

WAGE DETERMINATION APPEALS PROCESS

1.) Has there been an initial decision in the matter? This can be:

- * an existing published wage determination
- * a survey underlying a wage determination
- * a Wage and Hour Division letter setting forth a position on a wage determination matter
- * a conformance (additional classification and rate) ruling

On survey related matters, initial contact, including requests for summaries of surveys, should be with the Wage and Hour Regional Office for the area in which the survey was conducted because those Regional Offices have responsibility for the Davis-Bacon survey program. If the response from this initial contact is not satisfactory, then the process described in 2.) and 3.) should be followed.

With regard to any other matter not yet ripe for the formal process described here, initial contact should be with the Branch of Construction Wage Determinations. Write to:

Branch of Construction Wage Determinations
Wage and Hour Division
U. S. Department of Labor
200 Constitution Avenue, N.W.
Washington, D.C. 20210

2.) If the answer to the question in 1.) is yes, then an interested party (those affected by the action) can request review and reconsideration from the Wage and Hour Administrator (See 29 CFR Part 1.8 and 29 CFR Part 7). Write to:

Wage and Hour Administrator
U.S. Department of Labor
200 Constitution Avenue, N.W.
Washington, D.C. 20210

The request should be accompanied by a full statement of the interested party's position and by any information (wage payment data, project description, area practice material, etc.) that the requestor considers relevant to the issue.

3.) If the decision of the Administrator is not favorable, an interested party may appeal directly to the Administrative Review Board (formerly the Wage Appeals Board). Write to:

Administrative Review Board
U.S. Department of Labor

200 Constitution Avenue, N.W.
Washington, D.C. 20210

- 4.) All decisions by the Administrative Review Board are final.
END OF GENERAL DECISION

U-4405A

GT-0.1

Cumberland County

PROJECT SPECIAL PROVISIONS

GEOTECHNICAL

STANDARD SHORING (10/19/2021)

GT-1.1 - GT-1.4

DocuSigned by:

Geotechnical Engineering Unit

E06538624A11498...
7/30/2021

STANDARD SHORING:**(10-19-21)****Description**

Standard shoring includes standard temporary shoring and standard temporary mechanically stabilized earth (MSE) walls. At the Contractor's option, use standard shoring as noted in the plans or as directed. When using standard shoring, a temporary shoring design submittal is not required. Construct standard shoring based on actual elevations and shoring dimensions in accordance with the contract and Geotechnical Standard Detail No. 1801.01 or 1801.02.

Define "standard temporary shoring" as cantilever shoring that meets the standard temporary shoring detail (Geotechnical Standard Detail No. 1801.01). Define "standard temporary wall" as a temporary MSE wall with geotextile or geogrid reinforcement that meets the standard temporary wall detail (Geotechnical Standard Detail No. 1801.02). Define "standard temporary geotextile wall" as a standard temporary wall with geotextile reinforcement and "standard temporary geogrid wall" as a standard temporary wall with geogrid reinforcement.

Provide positive protection for standard shoring at locations shown in the plans and as directed. See *Temporary Shoring* provision for positive protection types and definitions.

Materials

Refer to the *Standard Specifications*.

Item	Section
Concrete Barrier Materials	1170-2
Flowable Fill, Excavatable	1000-6
Geosynthetics	1056
Grout, Type 1	1003
Portland Cement Concrete, Class A	1000
Select Materials	1016
Steel Beam Guardrail Materials	862-2
Steel Sheet Piles and H-Piles	1084
Untreated Timber	1082-2
Welded Wire Reinforcement	1070-3

Provide Type 6 material certifications for shoring materials. Use Class IV select material for temporary guardrail. Use Class A concrete that meets Article 450-2 of the *Standard Specifications* or Type 1 grout for drilled-in piles.

Based on actual shoring height, positive protection, groundwater elevation, slope or surcharge case and traffic impact at each standard temporary shoring location, use sheet piles with the minimum required section modulus or H-piles with the sizes shown in Geotechnical Standard Detail No. 1801.01. Use untreated timber with a thickness of at least 3" and a bending stress of at least 1,000 psi for timber lagging.

(A) Shoring Backfill

Use Class II, Type 1, Class III, Class V or Class VI select material or material that meets AASHTO M 145 for soil classification A-2-4 with a maximum PI of 6 for shoring backfill except do not use the following:

- (1) A-2-4 soil for backfill around culverts,

- (2) A-2-4 soil in the reinforced zone of standard temporary walls with a back slope and
- (3) Class VI select material in the reinforced zone of standard temporary geotextile walls.

(B) Standard Temporary Walls

Use welded wire reinforcement for welded wire facing, struts and wires with the dimensions and minimum wire sizes shown in Geotechnical Standard Detail No. 1801.02. Provide Type 2 geotextile for separation and retention geotextiles. Do not use more than 4 different reinforcement strengths for each standard temporary wall.

(1) Geotextile Reinforcement

Provide Type 5 geotextile for geotextile reinforcement with a mass per unit area of at least 8 oz/sy in accordance with ASTM D5261. Based on actual wall height, groundwater elevation, slope or surcharge case and shoring backfill to be used in the reinforced zone at each standard temporary geotextile wall location, provide geotextiles with ultimate tensile strengths as shown in Geotechnical Standard Detail No. 1801.02.

(2) Geogrid Reinforcement

Use geogrids for geogrid reinforcement with a roll width of at least 4 ft and an “approved” status code in accordance with the NCDOT Geosynthetic Reinforcement Evaluation Program. The list of approved geogrids is available from:

connect.ncdot.gov/resources/Geological/Pages/Products.aspx

Based on actual wall height, groundwater or flood elevation, slope or surcharge case and shoring backfill to be used in the reinforced zone at each standard temporary geogrid wall location, provide geogrids for geogrid reinforcement with short-term design strengths as shown in Geotechnical Standard Detail No. 1801.02. Geogrids are approved for short-term design strengths (3-year design life) in the machine direction (MD) and cross-machine direction (CD) based on material type. Define material type from the website above for shoring backfill as follows:

Material Type	Shoring Backfill
Borrow	A-2-4 Soil
Fine Aggregate	Class II, Type 1 or Class III Select Material
Coarse Aggregate	Class V or VI Select Material

Preconstruction Requirements

(A) Concrete Barrier

Define “clear distance” behind concrete barrier as the horizontal distance between the barrier and edge of pavement. The minimum required clear distance for concrete barrier is shown in the plans. At the Contractor’s option or if the minimum required clear distance is not available, set concrete barrier next to and up against traffic side of standard shoring except for barrier above standard temporary walls. Concrete barrier with the minimum required clear distance is required above standard temporary walls.

(B) Temporary Guardrail

Define “clear distance” behind temporary guardrail as the horizontal distance between guardrail posts and standard shoring. At the Contractor’s option or if clear distance for standard temporary shoring is less than 4 ft, attach guardrail to traffic side of shoring as shown in the plans. Place ABC in clear distance and around guardrail posts instead of pavement. Do not use temporary guardrail above standard temporary walls.

(C) Standard Shoring Selection Forms

Before beginning standard shoring construction, survey existing ground elevations in the vicinity of standard shoring locations to determine actual shoring or wall heights (H). Submit a standard shoring selection form for each location at least 7 days before starting standard shoring construction. Standard shoring selection forms are available from: connect.ncdot.gov/resources/Geological/Pages/Geotech_Forms_Details.aspx

Construction Methods

Construct standard shoring in accordance with the *Temporary Shoring* provision.

(A) Standard Temporary Shoring Installation

Based on actual shoring height, positive protection, groundwater elevation, slope or surcharge case and traffic impact at each standard temporary shoring location, install piles with the minimum required embedment and extension for each shoring section in accordance with Geotechnical Standard Detail No. 1801.01. For concrete barrier above and next to standard temporary shoring and temporary guardrail above and attached to standard temporary shoring, use “surcharge case with traffic impact” in accordance with Geotechnical Standard Detail No. 1801.01. Otherwise, use “slope or surcharge case with no traffic impact” in accordance with Geotechnical Standard Detail No. 1801.01. If refusal is reached before driven piles attain the minimum required embedment, use drilled-in H-piles with timber lagging for standard temporary shoring.

(B) Standard Temporary Walls Installation

Based on actual wall height, groundwater elevation, slope or surcharge case, geotextile or geogrid reinforcement and shoring backfill in the reinforced zone at each standard temporary wall location, construct walls with the minimum required reinforcement length and number of reinforcement layers for each wall section in accordance with Geotechnical Standard Detail No. 1801.02. For standard temporary walls with pile foundations in the reinforced zone, drive piles through reinforcement after constructing temporary walls.

For standard temporary walls with interior angles less than 90°, wrap geosynthetics at acute corners as directed by the Engineer. Place geosynthetics as shown in Geotechnical Standard Detail No. 1801.02. Place separation geotextiles between shoring backfill and backfill, natural ground or culverts along the sides of the reinforced zone perpendicular to the wall face. For Class V or VI select material in the reinforced zone, place separation geotextiles between shoring backfill and backfill or natural ground on top of and at the back of the reinforced zone.

Measurement and Payment

Standard shoring will be measured and paid in accordance with the *Temporary Shoring* provision.



DocuSigned by:
Scott A. Hidden
F760CAEB96FC4D3...
7/30/2021

**PROJECT SPECIAL PROVISIONS
GEOENVIRONMENTAL**

CONTAMINATED SOIL (6/14/2021)

The Contractor’s attention is directed to the fact that soil contaminated with petroleum hydrocarbon compounds may exist within the project area. The known areas of contamination are indicated on corresponding plans sheets. Information relating to these contaminated areas, sample locations, and investigation reports will be available at the following web address by navigating to the correct letting year and month then selecting, “Plans and Proposals”, “U-4405A”, “Individual Sheets/520 GeoEnvironmental”:

<http://dotw-xfer01.dot.state.nc.us/dsplan/>

Petroleum contaminated soil may be encountered during any earthwork activities on the project. The Contractor shall only excavate those soils that the Engineer designates necessary to complete a particular task. The Engineer shall determine if soil is contaminated based on areas shown on the plans, petroleum odors, and unusual soil staining. Contaminated soil not required to be excavated is to remain in place and undisturbed. Undisturbed soil shall remain in place, whether contaminated or not. The Contractor shall transport all contaminated soil excavated from the project to a facility licensed to accept contaminated soil.

In the event that a stockpile is needed, the stockpile shall be created within the property boundaries of the source material and in accordance with the Diagram for Temporary Containment and Treatment of Petroleum-Contaminated Soil per North Carolina Department of Environmental Quality’s (NCDEQ) Division of Waste Management UST Section GUIDELINES FOR EX SITU PETROLEUM CONTAMINATED SOIL REMEDIATION. If the volume of contaminated material exceeds available space on site, the Contractor shall obtain a permit from the NCDEQ UST Section’s Regional Office for off-site temporary storage. The Contractor shall provide copies of disposal manifests completed per the disposal facilities requirements and weigh tickets to the Engineer.

Measurement and Payment:

The quantity of contaminated soil hauled and disposed of shall be the actual number of tons of material, which has been acceptably transported and weighed with certified scales as documented by disposal manifests and weigh tickets. The quantity of contaminated soil, measured as provided above, shall be paid for at the contract unit price per ton for “Hauling and Disposal of Petroleum Contaminated Soil”.

The above price and payment shall be full compensation for all work covered by this section, including, but not limited to stockpiling, loading, transportation, weighing, laboratory testing, disposal, equipment, decontamination of equipment, labor, and personal protective equipment.

Payment shall be made under:

Pay Item

Hauling and Disposal of Petroleum Contaminated Soil

Pay Unit

Ton

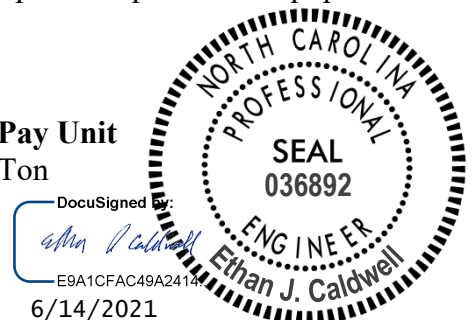

TC-1

U-4405A

Cumberland County

WORK ZONE TRAFFIC CONTROL Project Special Provisions Table of Contents

Special Provision	Page
ADA Compliant Pedestrian Traffic Control Devices	TC-2

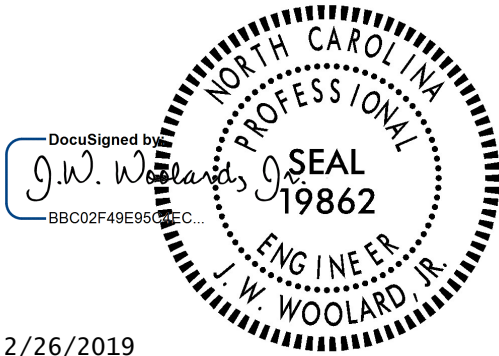

TC-2

U-4405A

Cumberland County

ADA COMPLIANT PEDESTRIAN TRAFFIC CONTROL DEVICES:

(10/31/2017)

Description

Furnish, install, and maintain all ADA compliant pedestrian traffic control devices for existing sidewalks that are disrupted, closed, or relocated by planned work activities.

The ADA compliant pedestrian traffic control devices used to either close, redirect, divert or detour pedestrian traffic are Pedestrian Channelizing Devices, Audible Warning Devices and Temporary Curb Ramps.

Construction Methods

The ADA compliant pedestrian traffic control devices involved in the closing or redirecting of pedestrians as designated on the Transportation Management Plan (TMP) shall be manufactured and assembled in accordance with the requirements of the Americans with Disabilities Act (ADA) and be on the NCDOT approved products list.

Pedestrian Channelizing Devices shall be manufactured and assembled to be connected as to eliminate any gaps that allow pedestrians to stray from the channelizing path. Any Pedestrian Channelizing Devices used to close or block a sidewalk shall have a "SIDEWALK CLOSED" sign affixed to it and any audible warning devices, if designated on the TMP.

Audible Warning Devices shall be manufactured to include a locator tone activated by a motion sensor and have the ability to program a message for a duration of at least 1 minute. The motion sensor shall have the ability to detect pedestrians a minimum of 10' away. The voice module may be automatic or it may be push button activated. If push button activated, it shall be at the appropriate height to meet the ADA regulations.

Temporary Curb Ramps shall be manufactured and assembled to meet all of the requirements for persons with walking disabilities, including wheelchair confinement, according to the ADA regulations and Roadway Standard Drawing 848.05. All detectable warning features are to be included with these installations.

Measurement and Payment

The measurement and payment for the ADA Compliant Pedestrian Traffic Control Devices shall be measured and paid on a per each basis for the Audible Warning Devices and Temporary Curb Ramps. Payment for Temporary Curb Ramps includes all necessary detectable warning features.

TC-3

U-4405A

Cumberland County

The measurement and payment for the Pedestrian Channelizing Devices will be by the linear foot.

Payment for each of these devices is dependent upon satisfactory installation and acceptance by the Engineer. The unit prices include any costs associated with installation, maintenance and removal of the devices from the project.

Payment will be made under:

Pay Item

Pay Unit

Pedestrian Channelizing Devices.....Linear Foot

PROJECT SPECIAL PROVISIONS

Utility Construction

DocuSigned by:

WK DICKSON
 community infrastructure consultants
 720 Corporate Center Drive
 Raleigh, NC 27607
 Tel. 919.782.0495
 Fax 919.782.9672
www.wkdickson.com
 NC License No. F-0374



10/4/2021

(Seal)

**DOCUMENT NOT
 CONSIDERED FINAL
 UNLESS ALL SIGNATURES
 COMPLETED**

Revise the 2018 Standard Specifications as follows:

Division 8, Incidentals

Division 8, Section 858, Adjustment of Catch Basins, Manholes, Drop Inlets, Meter Boxes and Valve Boxes

Page 8-37, Section 858-3, Construction Methods:

Add the following provisions to the second paragraph:

Adjustment of Valve Boxes:

The top section of the valve box shall be raised or lowered as required to meet the final grade. If the height of the final grade exceeds the length of the existing top section, remove the existing valve box and install a new one at final grade. New valve boxes shall be installed in accordance with the utility owner's standards.

Adjustment of Brick/Mortar Sanitary Sewer Manholes shall be performed as follows:

1. Measure the inside diameter of existing manhole to select appropriate diameter of new precast risers.
2. Remove existing walls to solid structure (to at least below the cone or chimney section) or to specified elevation. The limits of removal shall be approved by the Engineer in the field. Remove existing frame and cover, vent pipe and other appurtenances and dispose of materials that are not retainable. Return existing frames and covers to the Utility Owner.
3. Install new riser and cone sections as necessary to adjust the manhole to specified/approved elevation. Determine the required riser and cone height to meet the specified elevation. Provide bottom riser with a flat joint unless otherwise approved.

4. Install new riser section/existing wall joint to provide a leak-tight joint. Perform all work necessary to provide a leak-tight seal. Butyl rubber sealant shall be provided under the new riser section. In all cases, a concrete collar shall be poured around the joint. Collar to be minimum 6 inches wide and 12-inches high centered on joint all around. On the inside, seal joint with non-shrink grout. Grout to completely fill joint and extend at least 6 inches each side of joint all around. Grout to be tapered to existing wall section below the joint. Grout shall be resistant to hydrogen sulfide attack.
5. Install ring and cover consistent with these Special Provisions (Reference SP-1525).
6. Visually inspect joints and frame to cone seal to ensure water-tightness.

Adjustment of precast concrete manholes shall be in accordance with the following requirements:

1. Inspect existing manhole to determine if grade rings are already in use.
2. Measure the inside diameter of existing manhole to select appropriate diameter of new precast risers and or cone, if needed.
3. Concrete grade rings shall not be used for above grade adjustment for outfall precast concrete manholes. Use of grade rings are allowable in precast concrete manholes in manicured areas and pavement, where the ring and cover are at ground level. Concrete grade ring maximum adjustment includes three (3) 4-inch rings, two (2) 6-inch rings or one (1) 2-inchring (for a 12-inch maximum adjustment).
4. The Contractor shall remove all concrete grade rings to the top of the cone section. All loose material shall be removed and properly disposed of. The Contractor shall utilize new concrete grade rings to ensure that the new manhole ring and cover will be at final grade. If no concrete grade rings are required to adjust the structure to final grade, the Contractor shall set the ring and cover in a bed of clean fresh mortar.
5. If the manhole needs to be lowered, and there are no existing concrete grade rings, then the Contractor shall tear down the existing manhole and rebuild it, utilizing new riser and cone sections, to ensure that the installed ring and cover will be at final grade. The Contractor shall remove all necessary sections of the existing manhole to make the adjustment.
6. If the manhole needs to be raised, and there are 12-inches of concrete grade rings already in place, the Contractor shall tear down the existing manhole and re-build it. The Contractor shall utilize new riser and cone sections, as required, to ensure that the installed ring and cover will be at final grade. The Contractor shall remove all necessary sections of the existing manhole to make the adjustment.
7. Visually inspect joints and frame to cone seal to ensure water-tightness.
8. All work shall be in accordance with PWC requirements.

Page 8-38, Section 858-4, Measurement and Payment:

Replace the adjustment of manholes pay item language with the following pay items:

- Adjustment of Precast Manholes will be measured and paid in units of each for precast manholes satisfactorily adjusted.
- Major Drainage Structures and Precast Manholes will be measured and paid in units of linear foot when adjustment is raised more than two (2) feet.

- Adjustment of Brick and Mortar Manholes will be measured and paid in units of each for precast manholes satisfactorily adjusted.
- Major Drainage Structures and Brick and Mortar Manholes will be measured and paid in units of linear foot when adjustment is raised more than two (2) feet.

Where any precast manhole and major drainage brick and mortar manhole is adjusted more than once because of milling operations, multiple adjustments will be counted as one adjustment.

Where a drainage structure, precast manhole or brick and mortar manhole is raised more than 2 feet, the number of linear feet exceeding two (2) feet that such structure has been raised will be measured and paid per linear foot as provided in Article 840-4 for Masonry Drainage Structure. Measurement will be made by subtracting the elevation at the highest point of the original structure from the elevation at the highest point of the adjusted structure and then subtracting 2 feet from the results.

Such price includes, but is not limited to, excavation and backfilling, removal of a portion of the existing structure, brick masonry, mortar, grout, concrete, reinforcing steel, fittings, furnishing and hauling asphalt plant mix and any other materials and placing, maintaining, removing and disposing of traffic ramps.

Payment will be made under:

Pay Item	Pay Unit
Adjustment of Precast Manholes	Each
Major Drainage Structures and Precast Manholes	Linear Foot
Adjustment of Brick and Mortar Manholes	Each
Major Drainage Structures and Brick and Mortar Manholes	Linear Foot

Division 10-Materials

Division 10, Section 1034, Sanitary Sewer Pipe and Fittings

Page 10-61, Add Sub-article 1034-General

Add the following sentences:

All materials for the sewer system shall be in accordance with these Special Provisions.

Page 10-61, Sub-article 1034-1 Clay Pipe

Add the following sentences:

Clay pipe shall not be used for sewer pipe unless approved in writing by the utility owner. All sewer pipes shall be PVC or Ductile Iron as specified herein.

Page 10-61, Sub-article 1034-2 (A), PVC Gravity Flow Sewer Pipe:

Replace the paragraph with the following:

Unless otherwise noted on the plans, horizontal or vertical separation necessitates the use of ductile iron or the application entails an aerial crossing, all gravity sewer pipe shall be constructed of PVC. PVC sewer pipe and fittings 4 inches thru 12 inches shall be in accordance with ASTM D-3034 with a standard dimension ratio (SDR) of 26 for sewer mains and laterals. Both pipe and fittings shall be made of PVC plastic having a cell classification of 12454 as specified in ASTM D-1784. Larger diameter pipe (16 inches and larger) shall be in accordance with C900, with a SDR of 18.

Pipe joining shall be push on elastomeric gasket joints only and the joints shall be manufactured and assembled in accordance with ASTM D-3212. Elastomeric seals shall meet the requirements of ASTM F-477. The pipe shall be furnished with integral bells and with gaskets that are permanently installed at the factory and in accordance with ASTM D-3212 and contain a steel reinforcing ring. PVC sewer pipe shall be made by continuous extrusion of prime green unplasticized PVC and contain identification markings as required by the applicable ASTM standard.

The use of restrained joint C900 PVC (DR 18) shall be used for all gravity sewer mains installations (4 inches through 24 inches) within encasements. The restraint system shall provide uniform circumferential contact thereby eliminating any concerns over point loading. It shall be manufactured with compounds meeting a 12454 designation according to ASTM D1784 and shall have Rieber style joints meeting the requirements of ASTM D3139 with gaskets meeting the requirements of ASTM F477. The PVC restrained joint shall utilize a Rieber gasket per ASTM F477 to seal the integral bell socket to the spigot of the next joint (which conforms to the requirements of ASTM D3139). Each male end is beveled to facilitate joint assembly, and the spigot is reference marked to ensure proper insertion depth.

Ductile Iron Push-on Fittings:

Ductile iron sewer fittings on PVC mains shall be deep bell, gasketed joint, and air test rated. Gasket grooves shall be machined in the factory. Material shall be ductile iron, in accordance with ASTM A536, Grade 65-45-12 and ASTM F1336. Wall thickness shall meet the requirements of AWWA C153. Gaskets shall have a minimum cross sectional area of 0.20 square inches, and conform to ASTM F477. All ductile iron fittings shall have an interior coating of Protecto 401, or approved equal. All ductile iron fittings on PVC pipe shall provide a flow line that provides a smooth transition between the materials. Ductile iron fittings shall be as manufactured by the Harrington Corporation (Harco), or approved equal.

Mechanical Joint Fittings:

Joints shall be installed in accordance with AWWA C-600 and shall conform to AWWA Standard C-111. Mechanical joints shall be of the stuffing box type and shall conform to ANSI A21.11 for four inch (4") pipe and larger. Fittings and specials shall be ductile iron and shall be

manufactured in accordance with AWWA Standard C-110 (ANSI A21.11). Compact fittings shall be ductile iron in accordance with ANSI A 21.53 (AWWA C-153) for 4" thru 24" sizes only. Note: mechanical joint wyes are not included in the AWWA C-153 specification. Pressure rating shall be not less than 200 psi unless otherwise specified. All ductile iron fittings shall have an interior coating of Protecto 401, or approved equal. Mechanical joint fittings shall be utilized on ductile iron mains and ductile iron laterals. Mechanical joint fittings shall not be utilized on PVC mains, unless otherwise approved by the Public Works Commission.

PVC Fittings:

PVC fittings shall be manufactured in accordance with ASTM D-3034, F-1336, and F-679. Molded fittings shall be utilized in sizes from 4" to 8" (or larger, if available). Fabricated fittings shall only be utilized with prior approval from the Public Works Commission. Fabricated fittings are defined as those fittings that are made from pipe or a combination of pipe and molded components. All PVC fittings shall contain identification markings as required by the applicable ASTM standard. All PVC fittings shall be gasketed joint, except as indicated for interior drop structures. Plastic fittings shall be as manufactured by GPK Products, Inc., Plasti-Trends, the Harrington Corporation (Harco), or approved equal.

Page 10-61, Sub-article 1034-2 Plastic Pipe (B) PVC Force Main Sewer Pipe

Replace with the following:

In order to prevent the sanitary sewer force main from being mistaken for a water main, all force main PVC pipe shall be green in color.

Two (2) inch PVC pipe shall be manufactured using Grade 1 PVC compound material as defined in ASTM D-1784 and shall be SDR21, pressure class 200 in accordance with ASTM D 2241 or SDR-17 with a pressure rating of 250 psi, in accordance with ASTM D-2241. Fittings for two (2) inch PVC shall be solvent welded Schedule 80 PVC. The pipe shall be plainly marked with the manufacturer's name, size, material (PVC) type and grade or compound, NSF seal, pressure rating and reference to appropriate product standards.

All PVC pipe four (4) inches through 12-inches and couplings shall be manufactured using virgin compounds as defined in ASTM D-1784, with a 4000 psi HDB rating and designated as PVC 1120 to be in strict accordance with AWWA C900. The pipe shall be Class 150 and conform to the thickness requirements of DR18. The pipe and fittings shall be manufactured to withstand 755 psi quick burst pressure tested in accordance with ASTM D-1599 and withstand 500 psi for a minimum of 1,000 hours tested in accordance with ASTM D-1598. Couplings shall be compression, twin gasket type in accordance with ASTM D-3139 for push-on joints and ASTM F-477 for elastomeric seals (gaskets). PVC fittings are not acceptable for mains other than two (2) inch. The pipe joints shall be of the integral bell type with rubber gaskets conforming to the requirements of ASTM D-3139 or ASTM F-477. Fittings and specials for mains four (4) inches and larger shall be ductile iron, bell end in accordance with AWWA C110, 200-psi pressure rating unless otherwise shown or specified, except that profile of bell may have specials of the same material as the pipe with elastomeric-gaskets, all in conformance with the requirements of AWWA C900. Ductile iron fittings to PVC pipe shall be adequately supported

on a firm trench foundation. Fittings shall be for bell and spigot pipe or plain end pipe, or as applicable.

Mechanical restraining systems shall not be used on PVC pipe.

Page 10-61, Sub-article 1034-2 Plastic Pipe (C) Polyethylene (PE) Pipe Force Main Sewer Pipe

Replace with the following:

PE pipe shall not be used for force main sewer pipe unless approved in writing by the utility owner. All sewer pipes shall be PVC or Ductile Iron as specified herein.

Page 10-61, Sub-article 1034-2 Plastic Pipe (C) Polyethylene (PE) Pipe Force Main Sewer Pipe

Add the following paragraph after 1034-2 (C):

(D) High Density Polyethylene (HDPE) Pipe Force Main Sewer Pipe

The diameter and wall thickness of all high-density polyethylene (HDPE) pipe and fittings shall comply with the appropriate ASTM Specification and the class of pipe designated on the Drawings.

Page 10-61, Sub-article 1034-3 Concrete Sewer Pipe

Add the following sentences:

Concrete pipe shall not be used for sewer pipe unless approved in writing by the utility owner. All sewer pipes shall be PVC or Ductile Iron as specified herein.

Page 10-61, Sub-article 1034-4 (A), Gravity Flow Sewer Pipe, second paragraph:

Add the following paragraphs:

All ductile iron pipe and fittings shall be in strict accordance with ANSI A21.51 and AWWA C151, Class 50 or Class 51, as applicable, in every respect. The working pressure shall be a minimum of 200 psi. Pipe shall be furnished in 18 or 20-foot lengths. All pipe joints used in open trench construction shall be furnished with "push-on" joints, unless otherwise indicated on the drawings or specified. All joints and fittings shall be in accordance with ANSI A21.11 and AWWA C111. All ductile iron interior surfaces shall be lined with two (2) coats of ceramic epoxy to produce a total minimum dry film thickness of 40 mils. The exterior pipe surfaces shall be protected with asphaltic coating as specified in AWWA C151 and C110.

For aerial crossings which are 4 inches through 12 inches in diameter, manufactured restrained joint ductile iron pipe Class 53, or Class 53 flanged ductile iron pipe shall be used in accordance with the standard PWC detail for aerial crossings. Iron MJ restraint retaining glands are not an allowable means of restraint for aerial crossings. For aerial crossings larger than 12 inches, or as noted specifically on the plans, flange joint ductile iron pipe, Class 53, shall be used in accordance with the standard PWC details. The location of flanges shall be specifically designed for each application. The flange pipe shall be in accordance with ANSI/AWWA C115/A21.15. Threads

for threaded flange pipe shall be in accordance with ANSI B2.1, shop fabricated as outlined by AWWA C115 with serrated faces furnished on the pipe, completely factory installed. Welding of flanges to the body of the pipe will not be acceptable. Ductile iron fittings and flanges shall be in accordance with ANSI/AWWA C110/A21.10 with a minimum working pressure of 250 psi. Gaskets shall be full faced SBR rubber per ANSI/AWWA C111/A21.11 with a minimum 1/8" thickness. Linings and coatings shall be as outlined for ductile iron pipe.

For ductile iron mains that are open cut or installed in encasements within Aberdeen & Rockfish Railroad right of way, minimum thickness class shall be Class 56.

Mechanical Joint Fittings: Joints shall be installed in accordance with AWWA C600 and shall conform to AWWA C111. Mechanical joints shall be of the stuffing box type and shall conform to ANSI A21.11 for four-inch (4") pipe and larger. Fittings and specials shall be ductile iron and shall be manufactured in accordance with AWWA C110 (ANSI A21.11). Compact fittings shall be ductile iron in accordance with ANSI A 21.53 (AWWA C153) for 4" thru 24" sizes only. Note: mechanical joint wyes are not included in the AWWA C153 specification. Pressure rating shall be not less than 200 psi unless otherwise specified. All ductile iron fittings shall be lined with two (2) coats of ceramic epoxy to produce a total minimum dry film thickness of 40 mils. Mechanical joint fittings shall be used on ductile iron mains and ductile iron laterals. Mechanical joint fittings shall not be used on PVC mains, unless otherwise approved by the utility owner.

The interior of pipe and fittings shall be lined with two (2) coats of ceramic epoxy to produce a minimum dry film thickness of 40 mils.

Page 10-61, Sub-article 1034-4 Ductile Iron Pipe (A) Force Main Sewer Pipe

Add the following sentences:

All ductile iron pipe and fittings (six (6) inches and above) shall be in strict accordance with ANSI/AWWA C150/A21.50 and ANSI/AWWA C151/A21.51, Class 50 in every respect. Four (4) inch ductile iron pipe shall be Class 51. Joints shall be mechanical joint or push on joint as specified and installed in accordance with AWWA C600 and shall conform to AWWA C111. Mechanical joints shall be of the stuffing box type and shall conform to ANSI A21.11 for four (4) inch pipe through 12-inch pipe. Push on joints, rubber gaskets and lubricant shall conform to ANSI A21.11. Fittings and specials shall be ductile iron and shall be manufactured in accordance with AWWA C110 (ANSI A21.11).

Compact fittings shall be mechanically restrained, ductile iron in accordance with ANSI A 21.53 (AWWA C153) for four (4) inch through 12-inch sizes only. Where thrust blocking is used, fittings shall be full body ductile iron in accordance with ANSI A 21.53 (AWWA C110). Pressure rating shall be not less than 200 psi unless otherwise specified. All ductile iron interior surfaces shall be lined with two (2) coats of ceramic epoxy to produce a total minimum dry film thickness of 40 mils. The exterior pipe surfaces shall be protected with asphaltic coating as specified in AWWA C151 and C110.

For aerial crossings which are four (4) inches through 12 inches in diameter, manufactured restrained joint ductile iron pipe Class 53, or Class 53 flanged ductile iron pipe shall be used in accordance with the standard PWC detail for aerial crossings. Iron MJ restraint retaining glands

are not an allowable means of restraint for aerial crossings. For aerial crossings larger than 12 inches, or as noted specifically on the plans, flange joint ductile iron pipe, Class 53, shall be used in accordance with the standard PWC details. The location of flanges shall be specifically designed for each application. The flange pipe shall be in accordance with ANSI/AWWA C115/A21.15. Threads for threaded flange pipe shall be in accordance with ANSI B2.1, shop fabricated as outlined by AWWA 115 with serrated faces furnished on the pipe, completely factory installed. Welding of flanges to the body of the pipe will not be acceptable. Ductile iron fittings and flanges shall be in accordance with ANSI/AWWA C110/A21.10 with a minimum working pressure of 250 psi. Gaskets shall be full faced SBR rubber per ANSI/AWWA C111/A21.11 with a minimum 1/8" thickness. Linings and coatings shall be as outlined for ductile iron pipe.

Sanitary Sewer Transition Adapters:

Add the following provision for sleeves, couplings and miscellaneous:

(A) Ductile Iron Pipe Size x SDR26 Transition Adapter

All ductile iron x PVC transition adapters shall be one (1) piece, bell x bell (gasket x gasket). Transition adapters shall range in size from four (4) inches through 12 inches. Transition adapters for pipe larger than 12-inches shall be as specified by the Public Works Commission. All transition adapters shall have a flow way tapered to allow a smooth transition between the ductile iron and PVC. Transition adapters shall be either PVC or ductile iron, in accordance with the following:

PVC – All PVC transition fittings shall be made from DR 18 C900 pipe stock. The C900 pipe stock shall meet the requirements of AWWA C900/C905, and have a minimum cell classification of 12454 as defined in ASTM D1784. The wall thickness shall meet or exceed DR 18. PVC transition fittings shall have SBR gaskets in accordance with ASTM F477. All six (6) inch and eight (8) inch adapters shall be molded. Molded fitting joints shall be 235 psi rated, in accordance with ASTM D3139, and shall have SBR rubber gaskets. Four (4) inch, ten (10) inch and 12 inch transition adapters shall have SBR Rieber style gaskets meeting ASTM F477. Joints shall be 235 psi rated, in accordance with ASTM D3139 for the C900 (ductile iron) bell, and in accordance with ASTM D3212 for the sewer (SRD26) bell. Molded C900 bell depths shall comply with AWWA C907. Fabricated (4-inch, 10-inch and 12-inch) bell depths and molded sewer (SDR26) bell depths shall be in accordance with ASTM F1336. PVC transition adapters shall be manufactured by the Harrington Corporation (Harco), GPK Products, or approved equal.

Ductile iron – Ductile iron transition fittings shall be deep bell, push-on joint, and air test rated. The ductile iron material shall comply with ASTM A536, Grade 65-45-12 or 80-55-06. The bell depth shall be in accordance with ASTM F1336. Gaskets shall be of SBR rubber, in accordance with ASTM F477. Transition gaskets are not allowed. All ductile iron transition fittings shall have an interior coating of Protecto401 or approved equal. Ductile iron transition fittings shall be manufactured by the Harrington Corporation (Harco) or approved equal.

Sanitary Sewer Saddles:

All sewer service saddles shall be ductile iron with stainless steel straps, bolts, nuts, and washers. The nuts shall be coated to prevent galling. The saddle body shall be ductile iron, in accordance

with ASTM A536, Grade 65-45-12. The gasket material shall be SBR, in accordance with ASTM D2000. Saddles for PVC or DI laterals shall have an alignment flange. All stainless-steel straps shall be pre-formed at the factory, to the specified outside diameters of the pipe.

Sanitary Sewer Laterals:

Use fittings meeting the requirements of the following provisions and table:

Ductile iron laterals – For ductile iron mains, using mechanical joint fittings or an approved saddle with an alignment flange. For PVC mains, use an approved saddle with an alignment flange or ductile iron fittings as specified above.

PVC laterals – use a saddle with an alignment flange on PVC or ductile iron mains; use a mechanical joint tee with SDR 35 transition gaskets on ductile iron mains; or use PVC fittings as specified within these Special Provisions on sewer PVC mains.

The following table summarizes the materials to be use for sewer main to lateral connections:

	PVC Main	DI Main
DI Lateral	DI fitting or approved saddle	MJ fitting or approved saddle
PVC Lateral	PVC fitting or approved saddle	MJ fitting with transition gasket or approved saddle

Special Coatings:

Add material specifications for ceramic epoxy as follows:

Where ceramic epoxy linings are required, provide lining meeting the requirements contained within these special provisions.

The lining material shall be an amine cured novalac epoxy containing at least 20% by volume of ceramic quarts pigment.

The epoxy material shall meet the following minimum performance requirements:

Permeability Rating: 0.00 perms when tested according to ASTM E-96 Procedure A with a test duration of 30 days.

ASTM 6-95 Cathodic Disbandment: 1.5 volts at 77° F.

ASTM B-117 Salt Spray: 0.00 undercutting after one year.

Immersion Testing ASTM D-714

Duration

20% Sulfuric Acid

1 Year

25% Sodium Hydroxide at 140° F

1 Year

160□ F Distilled Water

1 Year

120□ F Tap Water

1 Year

Section 1036, Water Pipe and Fittings**Page 10-62, Sub-article 1036-1 General**

Add the following sentences:

Unless otherwise designated on Drawings or permitted by the Engineer, all water mains larger than four (4) inches in diameter shall be ductile iron as specified herein. Main sizes between two (2) and four (4) inches in diameter shall be PVC conforming to specifications contained herein.

Page 10-62, Sub-article 1036-2, Copper Pipe:

Replace paragraph with the following:

For buried service, use copper water pipe and tube conforming to ASTM B88 soft annealed Type K. The minimum pressure rating for the copper water pipe shall be 655 psi. Use cast brass flared or compression type fittings manufactured for use with copper water pipe and conforming to ANSI/AWWA C800 and local plumbing codes. All brass fittings shall have a 300 psi minimum pressure rating. All services installed in new construction shall be one continuous run of pipe with no splices from the corporation stop to the meter.

Page 10-62, Sub-article 1036-3 (A) (1) Pressure Rated Pipe

Replace with the following:

Pressure rated pipe shall not be used as water pipe.

Page 10-62, Sub-article 1036-3 (A) (2) Pressure Class Pipe

Replace with the following:

Two-inch (2") PVC pipe shall be manufactured using Grade 1 PVC compound material as defined in ASTM D-1784 and shall be SDR-21, pressure class 200 in accordance with ASTM D 2241 or SDR-17 with a pressure rating of 250 psi, in accordance with ASTM D-2241. Fittings for 2" PVC pipe shall be solvent weld Schedule 80 PVC and brass FIP x pack joint for PVC fittings shall be used to transition from PVC to brass. The pipe shall be plainly marked with the manufacturer's name, size, material (PVC) type and grade or compound, NSF seal, pressure rating and reference to appropriate product standards.

All PVC pipe (4" thru 12" diameter) shall be manufactured using virgin compounds as defined in ASTM D-1784, with a 4000 psi HDB rating and designated as PVC 1120 to be in strict accordance with AWWA C900. The pipe shall be Class 150 and conform to the thickness requirements of DR18. The pipe shall be manufactured to withstand 755 psi quick burst pressure tested in accordance with ASTM D-1599 and withstand 500 psi for a minimum of 1,000 hours tested in accordance with ASTM D-1598. PVC fittings are not acceptable for water mains four inches (4") or greater. The pipe joints shall be of the integral bell type with rubber gaskets and shall conform to the requirements of ASTM D 3139 or ASTM F-477.

Mechanical restraining systems shall not be used on PVC pipe.

Fittings and specials shall be ductile iron, bell end in accordance with AWWA C110, 150 psi pressure rating unless otherwise shown or specified. Ductile iron fittings to PVC pipe shall be adequately supported on a firm trench foundation. Ductile iron fittings and specials shall be cement mortar lined (standard thickness) in accordance with ANSI A21.4.

DI/HDPE Transition Fitting:

The D.I./HDPE mechanical joint adaptor shall consist of a molded or fabricated HDPE mechanical joint transition fitting, rubber gasket, a mechanical joint backup drive ring and mechanical joint tee bolts. Pipe stiffeners shall be employed to support the interior wall of the HDPE. The stiffeners shall support the pipe's end and control the "necking down" reaction to the pressure applied during normal installation. The pipe stiffeners shall be formed of 304 or 316 stainless steel, with a wedged style design to fit the HDPE manufacturers published average inside diameter of the specific size and DR of the HDPE.

Page 10-62, Sub-article 1036-4 Steel Pipe

Add the following sentence:

Steel pipe shall not be used without prior approval by Utility Owner or as indicated on the drawings.

Page 10-63, Sub-article 1036-5, Ductile Iron Pipe and Fittings:

Replace with the following:

(A) Pressure Class Pipe

All ductile iron pipe shall be four inches (4") and larger. All ductile iron pipe shall be designated as "Pressure Class", unless otherwise specified. The pipe furnished shall have a minimum thickness calculated in accordance with ANSI A 21.50(AWWA C150), with a factor of safety of two (2); a working pressure of 150 psi to 350 psi, plus 100 psi water hammer allowance; and AASHTO H-20 live truck load with 2.5 feet of cover. In no case shall "Pressure Class" pipe's nominal thickness be less than the following:

SIZE (In.)	PRESSURE CLASS	NOMINAL THICKNESS (In.)
4	350	0.25
6	350	0.25
8	350	0.25
10	350	0.26
12	350	0.28
16	250	0.30

24	250	0.37
----	-----	------

(B) Joint Types

Joints shall be mechanical joint or push on joint, unless otherwise indicated, conforming to AWWA C600 and AWWA C111. Mechanical joints shall be of the stuffing box type and shall conform to ANSI A21.11 for four inch (4") pipe through 12-inch pipe. Push on joints, rubber gaskets and lubricant shall conform to ANSI A21.11.

Factory Restrained Joints

Factory restrained joint pipe shall be utilized for all pipe greater than 12-inches in diameter, unless otherwise approved by the Fayetteville Public Works Commission. Factory restrained joint pipe shall be furnished for the locations shown on the approved Contract Drawings. The pipe, joints, and gaskets shall be in accordance with ANSI/AWWA Standards as specified for ductile iron pipe. Factory restrained joints shall be rated for a working pressure of 350 psi for sizes up to 12-inches and 250 psi for larger sizes.

All factory restrained joint pipe shall have the restraints internal to the pipe (i.e., "boltless"). All restrained joint ductile iron pipe and fittings larger than 12-inches shall be as manufactured by U.S. Pipe's TR-Flex, Griffin Pipe Products SNAP-LOK, American Cast Iron Pipe Company's Flex-Ring Joint, or approved equal. The method of restraining the valves to the factory restrained ductile iron pipe shall be reviewed and approved by PWC on a case by case basis. The valves shall have the same working pressure as the pipe.

(C) Fittings

Fittings and specials shall be ductile iron and shall be manufactured in accordance with AWWA C110 (ANSI A21.11). Compact fittings shall be mechanically restrained, ductile iron in accordance with AWWA C153 (ANSI A 21.53) for four (4) inch through 12-inch sizes only. Where thrust blocking is used, fittings shall be full body ductile iron in accordance with ANSI A 21.53 (AWWA C110). Pressure rating shall be not less than 200 psi unless otherwise specified. Where bosses are used, the pipe shall be a minimum Pressure Class 250 for sizes exceeding 24 inches and larger.

(D) Linings and Coatings

All ductile iron pipe and ductile iron-cast iron fittings and specials shall be lined with standard thickness cement mortar lining and asphaltic seal coat in accordance with ANSI A21.4 (AWWA C104). Pipe and fittings shall have an outside asphaltic coating as specified in AWWA C151 and C110, respectively. The coating shall be strongly adherent to the pipe at all temperatures.

(E) Quality Assurance

When requested by the utility owner each joint of pipe and each fitting shall be inspected by an independent domestic testing laboratory, approved by the utility owner, and certification shall be supplied to the the utility owner that all pipe and fittings meet project specifications. In addition, upon request, the Contractor shall furnish to the utility owner a six-inch (6") test section from each lot of water pipe as per AWWA Specification ASA 21.4 to be used for additional test of the pipe lining by the utility owner. Satisfactory results of this test must be obtained before acceptance of the pipe.

Page 10-63, Sub-article 1036-6, Fire Hydrants:

Replace with the following:

All fire hydrants shall be dry barrel, traffic type and conform to the latest revision of AWWA C502 except as listed below or as otherwise directed by the utility owner. All working parts shall be bronzed. The size of the fire hydrants (designated by the nominal diameter of the valve opening) shall not be less than four and one-half inches (4 1/2"). All hydrants shall be able to deliver 1,000 gallons per minute with a friction loss of not more than five (5) pounds per square inch total head loss through the hydrant. Hydrants shall be of compression type (opening shall be of such design that when the barrel is broken off the hydrant valve will remain closed and reasonably tight against leakage). All hydrants shall be mechanical joint to accommodate the spigot end of six (6) inch Class 150, AWWA Standard, ductile iron pipe. Bosses (six {6} inches and larger) may be substituted for tees in pipe sizes exceeding 24 inches in diameter. The boss shall be welded to the bottom of the main to provide effective flushing of the system.

All hydrants shall be furnished with two (2) two and one-half inch (2 1/2") nozzles and one (1) four and one-half inch (4 1/2") pumper nozzle. Outlets shall have American National Standard fire hose coupling thread, in accordance with the City of Fayetteville standard, and shall be provided with nozzle caps securely chained to the body of the hydrant. The base of the hydrant shall have two (2) cast lugs suitable for use in strapping the hydrant to the connecting pipe. The operating nut shall be pentagonal in shape, finished with a slight taper to one and one-half inches (1 1/2") from point to flat to conform to the standard now in use. All hydrants shall open left or counter-clockwise. Hydrants shall be suitable for working pressure of one hundred and fifty (150) pounds per square inch and test pressure of twice the working pressure. Fire hydrants shall be specific models manufactured by Mueller Company (Model Centurian 200), Clow Corporation (Medallion), American Darling (Model Mark 73-1) or approved equal. The interior of the hydrant shoe shall be coated with a four (4) mil thickness FDA approved epoxy coating. Paint hydrants with one coat of primer paint and two coats of an approved paint of the standard color. Apply the final coat after hydrant installation.

Page 10-63, Sub-article 1036-7 (A), Gate Valves:

Replace with the following:

All manually operated valves four (4) inches and larger shall be ductile iron or cast iron body resilient wedge type gate valves conforming to ANSI/AWWA C509 for resilient seat-type valves or to ANSI/AWWA C515 for reduced-wall, resilient seat gate valves. Valve connections shall be

as required for the piping in which they are installed and shall conform to ANSI/AWWA C111/A21.11. Gate valves shall have a design working water pressure of 250 psi.

All valves shall have triple "O" ring stem seals. The design and machining of valves shall be such as to permit the replacement of the upper two (2) "O" rings without undue leakage while the valve is wide open and in service. The wedge shall be ductile iron encapsulated in nitrile rubber (4-inch through 12-inch) sizes and SBR rubber (14-inch through 24-inch) sizes. All internal and external surfaces of the valve body and bonnet shall have a fusion bonded epoxy coating complying with ANSI/AWWA C550 applied electrostatically prior to assembly, conforming to ANSI/AWWA C550. Valves shall have a clear waterway equal to the full nominal diameter of the valve. All valves shall be tested for leakage and distortion in strict accordance with the latest revision of ANSI/AWWA C500.

For buried service, gate valves shall have non-rising stems, 2-inch square operating nuts and shall open by turning counter clockwise. The operating nut shall have an arrow cut in the metal, indicating the direction of opening. Where the valve operating nut is more than 3 feet below the valve box cover, provide an extension stem to bring the operating nut to a point 36 to 42 inches below the surface of the cover. Construct stem of steel using pipe, bar stock, and plates. Field verify required stem length prior to fabrication. Hot dip galvanize completed stem after fabrication.

Gate valves installed in meter vaults shall have a wheel in lieu of a square operating nut and shall also have a non-rising stem. The wheel shall have an arrow cut in the metal indicating the direction of opening. Flanges shall not be buried. An approved pit shall be provided for all flange connections.

All valves shall be manufactured in strict accordance with the latest specifications of the ANSI/AWWA. Valves shall be manufactured by: Mueller Company, Clow Corporation, American Darling Company, or approved equal. Certification shall be furnished to the utility owner by the manufacturer that all valves are in accordance with these standards.

Where specified on the plans and approved by the Utility Owner, resilient valves shall be supplied with gearing. Spur gearing for valves installed in a vertical position and bevel gearing for valves installed in a horizontal position. In cases where valve locations on plans fail to designate valve gearing and the proposed depth of water main is not adequate to achieve normal depth above valve bonnet of at least two (2) feet in cover, provide bevel gearing for all large diameter valves (16-inches and larger) upon approval by the utility owner.

Page 10-63, Sub-article 1036-7 (B) Bronze Gate Valves

Replace with the following:

Bronze gate valves shall not be used. All valves smaller than four (4) inches shall be ball valves.

Page 10-63, Sub-article 1036-7 (C), Tapping Valves:

Replace with the following:

Use tapping valves conforming to Sub-article 1036-7(A) with appropriately sized openings, with flanged by mechanical joint ends and pressure rated at 250 psi.

Resilient seated tapping valves shall be furnished with the tapping flange having a raised face or lip designed to engage the corresponding recess in the tapping sleeve flange in accordance with MSS-SP60. Tapping valves without the raised face on the tapping flange are not permitted since they do not assure the proper alignment required to prevent damage by a misaligned shell cutter. The interior of the waterway in the body shall be a full opening and capable of passing a full-sized shell cutter equal to the nominal diameter of the valve.

Page 10-63, Add Sub-article 1036-7 (D), Ball Valves:

Add the following provisions:

For all valves smaller than four inches (4"), ball valves shall be used. Ball valves shall be installed in accordance with these provisions.

Ball valves shall be all bronze construction, with tee head operator and having a removable disc. Ball valves shall have threaded connections, in accordance with the standard details. Ball valves shall be manufactured and tested in accordance with AWWA/ANSI C800. The valve shall be equipped with packing nut, gland, and packing material. Ball valves shall be of an approved type made from approved materials conforming to ASTM Specifications and shall also meet the approval of the Utility Owner. The turn required to travel from fully closed to fully open on the ball valve shall be 90 degrees.

Page 10-63, Sub-article 1036-8 (A), Tapping Sleeves:

Add the following provisions:

Water tapping sleeves shall be ductile iron mechanical joint or stainless steel full gasket and have a minimum working pressure of 150 psi for all tapping of mains up to and including 24 inch diameter with a branch less than or equal to 12 inch diameter. Branch diameter greater than 12 inches on 16-inch diameter pipe and larger shall require full body ductile iron mechanical joint tapping sleeve.

Ductile iron mechanical joint tapping sleeves shall be as manufactured by Clow, M&H, Mueller, American, or an approved equal and shall be furnished with complete joint accessories. The mechanical joint sleeve shall be compatible with type and class of pipe being tapped. The outlet flange shall be class 125 per ANSI B16.1 compatible with approved tapping valves. The sleeve shall have a mechanical joint body with side flange gaskets. Secure side flange gaskets to existing main using restraining glands acceptable to material of existing main.

Stainless steel tapping sleeves shall only be used upon authorization by Engineer. Stainless steel tapping sleeves shall be furnished with all accessories. The sleeve, lugs, bolts and nuts shall be 18-8 type 304 stainless steel, as provided by the manufacturer. The outlet flange shall be ductile iron or stainless steel. The gasket shall be a grid pattern design and shall provide full circumferential sealing around pipe to be tapped. The sleeve shall include a 3/4 NPT test plug. All welds shall be passivated. The outlet flange shall be class case D per AWWA C-207-ANSI 150 lb. drilling compatible with approved tapping sleeves.

The tapping sleeve and valve shall be in accordance with the standard details.

Page 10-63, Sub-article 1036-8 (B), Transition Sleeves and Couplings:

Add the following material to this sub-article:

Use mechanical joint full body solid sleeves conforming to MJ fittings of this special provision of 1036-5. Sleeve shall be rated for 250 psi working pressure.

Page 10-64, Sub-article 1036-9, Service Line Valves and Fittings:

Add the following provisions to the second paragraph:

All water service saddles for use on 2-inch PVC shall be one (1) inch brass saddles as manufactured by Ford, McDonald, Mueller or approved equal

Water service saddles for 1 and 2-inch taps on 4, 6, 8, 12-inch and larger size PVC and asbestos-cement (AC) and also 4-inch and larger size iron pipe shall be ductile iron with stainless steel strap(s), bolts, nuts and washers. Ford Models FS 101, FS 202; Romac Models 101S, 202S; Smith-Blair Model 315/317; or approved equal shall be used. Stainless steel straps must be pre-formed at the factory to the specified outside diameters of the pipe.

Water service saddles with 2-inch outlet shall be double strap.

Water service saddles for pipe sizes 12-inch through 30-inch shall be double strap.

Use cast brass compression type fittings manufactured for use with copper or PE water pipe, as applicable, and conforming to ANSI/AWWA C800 and local plumbing codes. All brass fittings shall have a 300 psi minimum pressure rating.

Page 10-64, Add Sub-article 1036-10, Combination Air Valves Assembly:

Add material specification for air valve assembly as follows:

Combination air valves shall be of the single housing style that combines the operation features of both an air/vacuum and air release valve. The combination air valve shall have a two (2) inch inlet and one (1) inch outlet connections and an orifice diameter as designated on the Drawings for a maximum working pressure of 300 psi. The assembly shall be equipped with a two (2) inch cut-off valve as shown on the standard detail. The combination air valve body shall be constructed of 316 stainless steel or reinforced nylon with the only exception being the Buna-N Rubber seat and gasket. Valves shall be provided to the Contractor. Contractor shall provide a minimum of 90 day notification prior to Contractor's established installation date.

Page 10-64, Add Sub-article 1036-11, Identification of Plastic or Non-metallic Pipes:

Add the following provisions:

For the purpose of identification of plastic or non-metallic pipes during future trenching or location, a continuous "detectable" identification wire shall be installed. The wire shall be a minimum 12-gauge, single strand, coated copper or copper clad steel wire that is suitable for underground use. Splices shall be accomplished utilizing a corrosion proof wire connector. The connectors shall "lock" the wires in place and contain a dielectric sealant to prevent corrosion.

Page 10-64, Add Sub-article 1036-12, Valve Box:

Add the following material specifications for valve box:

Valve boxes shall be "slip-type" made of close-grained, gray cast iron metal painted with a protective asphaltic coating. Construction shall be in three pieces as follows: The lower of base pieces, which shall be flanged at the bottom, the upper part which shall be flanged on the lower end, and of such size as to telescope over the lower part, the upper end being constructed in the form of a socket to receive the cap or cover; and the cover or cap shall have cast on the upper surface, in raised letters, the word "WATER". All valve boxes shall be equal in quality and workmanship to those manufactured by Sigma Corporation (VB-462), Tyler Union (6855 Series), Star Pipe Products (VB-0004), or an approved equal. Valve box shall have a 3/8-inch hole drilled in the upper part four (4) inches to six (6) inches from the top of the box to accommodate 1/4-inch x 1-1/2-inch galvanized bolt for securing tracer wire. The valve box shall be in accordance with the standard details.

Valve box protector rings shall be installed to protect valve boxes located outside pavements (i.e. roadway shoulders). The ring shall be constructed in accordance with the standard details.

Valve Box and Stem Extension for Buried Applications: For all buried valves greater than three (3) to four (4) feet in depth, provide as necessary an extension system to raise 2-inch operating nut to within three (3) feet of the finished grade. Stem diameter according to valve manufacturer's recommendations, but not less than one (1) inch. Extension stem shall be provided spacer and stop to reinforce point of applied torque and keep assembly from separating at full extended length

Division 15, Section 1500-General Utility Requirements

Page 15-1, Sub-article 1500-2 Cooperation with the Utility Owner, paragraph 2:

Add the following sentences for utility owner contact information:

The utility owner is the Fayetteville Public Works Commission (PWC). The contact person is John Allen, PE, of PWC's Water Resources Engineering Department. He can be reached by phone at (910) 223-4734.

Add the following provision for fire hydrant accessibility:

Existing fire hydrants shall be accessible to the Fire Department at all times. Fire hydrants shall not be taken out of service without the utility owner's written approval. The Fire Department shall be notified of any fire hydrant taken out of service.

If the fire hydrants are in need of replacement, relocation, or connected to a new water main, the Utility Owner, the Design Engineer, and the appropriate Fire Department shall be notified and coordinated with prior to commencing work. Fire hydrants shall not be removed from service without prior approval of the Utility Owner. The existing fire hydrants shall be returned to the Utility Owner.

Contractor shall notify the applicable Fire Department of when and what area they will be working. Contractor shall notify the Fire Department a minimum of 48 hours prior to commencing work. The Contractor shall coordinate with the appropriate Fire Department regarding the placement of the temporary fire hydrants.

Add the following provision for construction around utility poles and guy wires

The Contractor will be required to perform construction work around utility poles and guy wires which may be left in place within the construction limits of the project. The Contractor shall contact the owner of the utility to coordinate securing the poles during construction. It may be necessary for the Contractor to hire an electrical utility contractor to secure poles. All work outlined in this paragraph shall be at no additional cost to the Department and/or Utility Owner.

Page 15-1, Sub-article 1500-3, Utility Locations and Contractor's Responsibility:

Add the following paragraphs that supplement mapping of existing water and sewer lateral facilities:

Exhibit 2-Table 1 of these Utility Construction Special Provisions shall supplement existing water and sewer lateral facilities on the plans. Unless otherwise directed by the Utility Owner, Table 1 shall supersede any plan discrepancy regarding size, number and/or material.

Add the following paragraphs that designate site layout and staking responsibilities for the proposed water and sewer utility work:

Construction staking will be performed by the Department (NCDOT's Division Office), who will also prepare and furnish construction cut sheets to the Design Engineer, Utility Owner and Contractor. The Contractor shall not install any utilities without a cut sheet. All requests for staking will be made not less than 96 hours in advance. Engineer.

Utilities shall be installed at the locations and elevations indicated on the cut sheets unless otherwise approved by the Utility Owner. Should a conflict arise between the Contract Drawings and the cut sheets, the cut sheets shall take precedence. Contractor shall make the Utility Owner and Design Engineer aware of any conflict between the Contract Drawings and the cut sheets as soon as it is discovered. The Contractor shall verify invert elevations of all water mains, sewer mains, water laterals, sewer laterals, and manholes by instrument.

Add the following paragraphs for repair of any damage to existing water services by contractor caused damage:

PWC

The Contractor shall replace the existing water services that are damaged as a result of their operations in accordance with these Special Provisions. Damaged water services shall be replaced from the meter to the existing main utilizing copper tubing and all new fittings. The Contractor shall properly abandon the existing tap, and install a new tap, utilizing a new tapping saddle and corporation in accordance with these Special Provisions.

The Contractor shall be responsible for connecting the new tailpiece to the customer's existing service utilizing brass fittings. The Contractor is responsible for all necessary fittings in order to connect the copper tubing to the existing meter.

The existing meter boxes shall be replaced as part of the renewal of the water services. A composite, H-20 rated meter box shall be used if the meter is to be located in asphalt or concrete. The Contractor shall be responsible for furnishing and installing the meter boxes. All work shall be approved by PWC..

Aqua

The Contractor shall replace the existing water services that are damaged as a result of their operations, with 1-inch polyethylene CTS, 200 PSI pipe for doubled services. Should the service encountered be a single service it shall be replaced with ¾-inch CTS 200 PSI pipe. The services shall be replaced main to meter. In accordance with AQUA America requirements, no couplings shall be used on service lines. Single strap saddles made of brass shall be used with brass compression corporation stops. All water laterals shall have at least three (3) feet of cover. Should the Contractor's operations damage properly marked services they shall be replaced at no cost to AQUA America or the Department. If services are not properly marked the Contractor will need to seek reimbursement through AQUA America. The Contractor shall properly abandon the existing tap, and install a new tap, utilizing a new tapping saddle and corporation. The Contractor is responsible for all necessary fittings in order to connect the new service to the existing meter. The Contractor shall be responsible for furnishing and installing meter boxes. All work shall be approved by AQUA America.

Page 15-1, Sub-article 1500-4, Weekend, Night and Holiday Work:

Add the following paragraphs:

During the course of construction, it may be necessary to complete portions of the Work outside of the normal working hours, to accommodate the utility owner's operations, traffic, and/or public convenience. The Department, Contractor, and the utility owner will determine an acceptable schedule required for Work during such hours. The costs for such Work shall be considered incidental to the Project and no additional payment will be made.

Legal holidays observed by the Fayetteville Public Works Commission include New Year's Day, Martin Luther King's Birthday, Good Friday, Memorial Day, Independence Day, Labor Day, Thanksgiving (2 days), and Christmas (2 days).

Page 15-1, Sub-article 1500-5, Relation of Water Mains to Sewers:

Add the following paragraph:

Relation of water mains to sewers shall also apply to all sewer lateral crossings (four (4) inches and six (6) inches).

Page 15-1, Add Sub-article 1500-5-A, Crossing Existing or Proposed Utilities:

Add the following sub-article:

The Contractor shall conduct their operations so that the following requirements are adhered to:

1. Underground telephone, cable TV, and gas utilities or conduit banks shall be crossed maintaining a minimum of 12-inch separation or clearance.
2. Electrical crossings shall be performed while the conductor is de-energized and at all times in the presence of the utility owner. Electrical crossings shall be in accordance with NESC requirements. Electrical primary conductor crossings shall be as follows:
 - a. Crossing over a conductor, maintain a minimum of 12-inches of undisturbed soil encasing the conductor.
 - b. Crossing under a conductor shall be accomplished by boring, maintaining 12-inches of undisturbed soil encasing the conductor.

Page 15-2, Sub-article 1500-7, Submittals and Records:

Revise the number of water and sewer submittals to the utility owner from two (2) paper copies to two (2) paper copies and one (1) copy in electronic (Adobe Acrobat pdf) format.

Add the following paragraphs:

The Contractor shall not perform any portion of the water and sewer work requiring submittal and review until the respective submittal has been approved by the utility owner. Water and sewer work performed prior to review and acceptance shall be at the Contractor's risk.

The Contractor shall provide submittals on the following:

- A sample door hanger, notifying the residents of the project and those times that the resident may not have water and sewer service
- Contractor's safety plan, including confined space program
- Identification of the proposed project superintendent and representative authorized to act on behalf of the Contractor.
- Proposed project schedule. The schedule shall include the sequencing and coordination of connections to existing water mains and sewers, pipeline inspections, trenchless crossings, temporary water main set up and removal, sewer bypass pumping set up and tear down, and final restoration.
- All piping, fittings and structures including that to furnish temporary water during extended service interruptions
- Sewer Bypass pumping – as outlined in these Special Provisions
- Contractor personnel emergency contact information

Upon completion of the project, prior to the Contractor de-mobilizing and before payment for associated items, the Contractor shall provide the following:

PWC Sewer Work:

- Manholes located outside of pavement must have a PWC issued marker.
- All manholes having cam-lock ring and covers shall be locked.
- Install a PWC issued marker at all valve and air release valves at manholes outside of pavement as directed by PWC.
- Verify all plugs have been removed.

Water Work:

- Verify all valves are fully open.
- Verify all valves are accessible and can be operated.

Page 15-2, Sub-article 1500-8, Locating and Marking:

Add the following requirements:

For identification of plastic water services, the wire shall be buried along the water service lateral from the main to the meter box. The wire shall extend a minimum of 12 inches into the meter boxes.

For identification of plastic or non-metallic pipes, the wire shall be continuously along the pipe. The wire shall be "stubbed" into valve boxes and secured such that a direct/conductive metal detector may be used to trace the pipe location. Bolts shall be used to secure the detectable wire

and the attachment location shall be readily available from finished grade without special equipment. The wire shall be installed above all non-metallic pipelines.

Page 15-2, Sub-article 1500-9 Placing Pipelines into Service:

Replace last two sentences with the following:

Obtain approval from the utility owner prior to placing a new water line into service. Use backflow prevention assemblies for temporary connections to isolate new water lines from existing water line. A representative from the utility owner shall witness all tests performed on their water and sewer facilities.

Page 15-2, Sub-article 1500-9 Placing Pipelines into Service:

Add the following sentences:

Prior to final inspection, all sanitary sewer laterals, mains, and manholes newly installed on the collection system shall be flushed and cleaned. During the flushing operation, the downstream manhole shall be closed with a watertight plug to protect the existing sewer main. All water and debris shall be removed and properly disposed of by the Contractor. This condition shall be maintained until the utility owner issues acceptance of the work.

Page 15-2, Sub-article 1500-9 Placing Pipelines into Service:

Add the following provisions related to planned service interruptions on PWC-owned lines:

Coordination of temporary interruptions to water and/or sewer services shall be the responsibility of the Contractor. The Contractor shall schedule a coordination meeting with the Department, Design Engineer, Public Works Commission's Project Coordinator, and utility owner a minimum of three (3) business days prior to any planned service interruption and prior to any notices being issued. The purpose of this coordination meeting is to ensure that the Contractor has a good understanding of the requirements related to the proposed outage, verify that there are no utility conflicts, discuss any necessary contingency plans, and all equipment, materials, tools, and all other incidentals necessary to complete the work are on the project site in good working order. Should, for any reason, the Department and/or PWC deem that the Contractor is not prepared for the proposed outage, the outage notifications will not be distributed and the outage shall be postponed a minimum of two (2) weeks. The Department will provide written notification to the Contractor of this decision. No additional contract time will be granted for this delay.

The duration of the service interruption shall be coordinated with PWC, the Department, the utility owner and the Design Engineer. Service interruptions to residents shall be limited to no more than eight (8) hours at any given time. If the service interruption is anticipated to exceed eight (8) hours, temporary service shall be provided. The Contractor shall provide all the necessary equipment and materials for temporary service. The notifications shall describe the work to be undertaken and approximate dates of the work. The text of the notifications shall be approved by the Department and PWC in advance. The Contractor shall furnish a copy of the notification to the PWC Project Coordinator each time such notification is issued to the residents.

Whenever the property owner's use of the water and/or sanitary sewer must be interrupted by the Work, the Contractor shall notify the residents a minimum of 48 hours prior to service interruption. This notification shall be accomplished with door hanger notification cards placed at the addresses of the affected residents. Property owners shall be informed when service interruption takes place and the expected duration. The Contractor shall make every effort to minimize inconvenience to the public and property owners.

The Contractor shall complete the required work and restore water service within the given time period for the outage. PWC reserves the right to cancel or postpone the outage at any time, for any reason.

Add the following provisions for furnishing pressurized, temporary water service:

Provide and maintain pressurized, temporary water supply to all services connected to water mains that must be depressurized and/or interrupted for any reason related to the Work including cut in construction and ties in. The only exception to this requirement is the performance of emergency repair and if the planned interruption of service is expected to last less than eight (8) consecutive hours. Provide temporary water supply if the interruption extends past eight (8) consecutive hours.

Maintain and operate temporary water supply until completion of required disinfection and flushing procedures and, receipt of confirmation of acceptable bacteriological test results for the section of water main that was interrupted or as otherwise directed by the utility owner.

The Contractor shall submit a detailed temporary water layout plan to the utility owner prior to the planned outage. The Contractor will be responsible for furnishing, installing, maintaining and removing all temporary water lines during the course of the work. All costs associated this item shall be incidental for the work that is needed for.

The temporary lines shall be leak free and installed in a neat and orderly fashion. The Contractor shall be responsible for protection of the temporary line and shall provide the personnel necessary to immediately respond to all water line breaks, leaks, and outages associated with the project. A 24-hour "hotline" shall be established for the utility owner to call when a problem arises with the temporary water system. Any leaks on the temporary water service lines shall be repaired immediately. The Contractor shall also take all necessary precautions to protect the temporary water system from freezing and shall include freezing protection procedures in the temporary water layout plan.

The Contractor shall connect the temporary water system directly to the customer's meter, utilizing all appropriate fittings. This may necessitate the meter being placed outside of the meter box. During weather that may result in the meter and/or temporary service lines freezing, the Contractor shall take all reasonable precautions (i.e, covering the meter with dirt) to prevent the meter and/or temporary bypass lines from freezing.

Fire protection must be maintained at all times during construction. Temporary fire hydrants must meet the approval of the applicable Fire Department, prior to their use.

Prior to installing any temporary service lines, the Contractor shall verify the need for such lines, especially on streets with multiple water mains. Any costs incurred by installing temporary water lines that are not needed shall be at the Contractor's expense.

Backflow prevention measures will be required when the temporary water system is serving any commercial businesses. Backflow prevention measures will not be necessary when the temporary water system is only serving residential homes. Where backflow prevention is required, a reduced pressure device shall be utilized in accordance with PWC standards and the City of Fayetteville's Cross-Connection Control Ordinance. The Contractor shall call PWC's Environmental System Protection Department (910-223-4699) for additional information and requirements.

Restrained joint PVC piping will be allowed if properly placed so as to prevent its damage by traffic. All temporary service pipe crossing streets and/or commercial driveways must cross in a fashion that will not create a traffic hazard. Boring or punching may be required when crossing streets with high traffic volume or higher speeds. Temporary piping crossing sidewalks or wheel chair access ramps must be ramped or buried. Any temporary water lines crossing a driveway shall be covered with a rubber ramp or bituminous cold patch provided by the Contractor. When temporary paving is used to ramp temporary services lines, it must be compacted by a roller or compaction device to minimize tracking. The Contractor is to maintain ramps and patches to ensure access by public. Piping must be buried when so directed by the Department and/or the utility owner. All temporary water piping connected to fire hydrants shall be constructed in such a manner that if necessary, can be easily removed so the fire hydrant can be used for firefighting purposes with minimal effort. All such connections to the fire hydrants must be compatible with applicable Fire Department requirements for each fire hydrant outlet used. Where fire hydrants cannot be used or are not available, the Contractor shall make below ground taps for bypass connections.

Direct connections to the existing water system will not be allowed until chlorination is complete and each section of temporary line, including service lines, has passed bacteriological and turbidity testing. All dead end temporary services lines shall be equipped with a temporary blow-off.

Temporary service lines longer than 750 linear feet must have a supply at each end. Temporary service lines must have a main line shut off valve at least every 500 feet. Fire protection must be maintained at all times during construction.

Upon activation of the newly relocated or installed pipe, the Contractor shall remove all temporary service lines and shall leave all streets, sidewalks, and adjacent properties in a condition of equal or better than original. Prior to installing the meter and connecting the customer to the new main, the existing service line shall be thoroughly flushed to remove any deposits collected during the work.

The pipe, hoses, and other materials which are to be furnished by the Contractor for use as temporary service pipe shall be clean, water tight and fully adequate to withstand the existing pressure and all other conditions of use and shall be approved by the utility owner. Care shall be exercised throughout the installation of all temporary pipe and service fittings to avoid any possible contaminations of any mains or services.

All piping utilized in the temporary water system shall be NSF Standard 61 certified for use in potable water applications or FDA CFR 177.2600 approved, for use in contact with food articles, if such use is approved by NCDEQ. The Contractor may utilize PVC pipe only if the pipe is equipped with restrained joints.

Testing and Disinfection

The Contractor shall coordinate and fully cooperate with the Utility Owner when scheduling testing. The Contractor shall provide a minimum of two (2) business days notice when scheduling testing with the Utility Owner. All testing shall be in accordance with these special provisions.

All temporary water piping, newly lined mains, and newly installed mains shall be flushed and disinfected prior to placing into service. For water samples on PWC-owned water mains, the PWC Project Coordinator shall take the appropriate sample(s) to the PWC lab for analysis. Upon successful completion of the disinfection process, the water lines can be placed into service. Disinfection shall be in accordance with these Special Provisions. All water samples from PWC-owned mains shall be taken to the PWC Lab by the PWC Project Coordinator.

The Contractor shall provide all equipment, materials, personnel, traffic control and all means necessary to perform all testing and inspection at no additional cost to the Department. If the same line segment fails the required testing more than two (2) times, PWC will charge a fee of \$100.00 per test, beginning with the third attempt, until a passing test achieved.

All environmental regulations governing the release and/or disposal of chlorinated testing water shall be met by the Contractor. AWWA C655 defines "highly chlorinated" water as water having more than four (4) ppm. Any water with a chlorine level greater than four (4) ppm shall be de-chlorinated by the Contractor prior to being released to the environment.

The Contractor will be required to flush and remove the chlorine from the main 24 hours after initial chlorination. The cost of main disinfection and disposal of the chlorinated water shall be included in the appropriate measurement and payment item.

Page 15-2, Sub-article 1500-9 Add Pipe Laying Schedule and Marking Diagram:

Pipe Laying Schedule and Marking Diagram

Contractor shall provide a laying schedule and marking diagram for all mains 16-inches and larger and for all mains that are factory restrained or flanged.

Laying schedule shall indicate by consecutive number the order and direction of installation of each pipe section or segment, length of restraint, special fitting, valves, tees, temporary taps or flushing points, and other appurtenances. In addition, the laying schedule shall include:

- A. The station and elevation to which the bell end of each pipe shall be laid and all changes in gradient or horizontal alignment.
- B. All elements of curves and bends, both in horizontal and vertical alignment.
- C. Length of restraint

Contractor shall not start production of pipe and fittings prior to review and approval by the Utility Owner. Contractor shall provide final approved lay schedule on CD-ROM in Adobe portable document format (*.PDF).

Division 15, Section 1505-Excavation, Trenching, Pipe Laying and Backfilling for Utilities

Page 15-3, Sub-article 1505-2 Materials:

Add the following paragraph for pipe protection in contaminated conditions:

Where shown on the Drawings or where contaminant petroleum (i.e., diesel, gasoline, etc.) is encountered, use contaminant gasket material. Contaminant gasket material shall be nitrile rubber in accordance with ASTM 1418. Gaskets shall be consistent with pipe manufacturer and Design Engineer's recommendation for any other contaminants encountered.

Page 15-3, Sub-article 1505-2 Materials:

Add the following paragraph for pipe protection in contaminated and corrosive conditions:

Where shown on the Drawings or where contaminant petroleum (i.e., diesel, gasoline, etc.) and/or corrosive and highly organic soils are encountered, provide polyethylene encasement in underground installations of ductile iron piping for water and sewer. Polyethylene wrap in tube or sheet form for piping encasement shall be manufactured of virgin polyethylene material conforming to the requirements of ANSI/ASTM Standard Specification D1248. The specified nominal thickness for low-density polyethylene film is 0.008 inches (8 mils). The specified nominal thickness for high-density cross-laminated polyethylene film is 0.004 inches (4 mils). The minus thickness tolerance shall not exceed 10 percent of the nominal thickness on both material types.

Page 15-4, Sub-article 1505-3 (C) Bedding:

Add the following sentence:

Sewer and water main bedding shall also conform to the requirements of the standard detail for sewer bedding and water main bedding.

Page 15-4, Sub-article 1505-3 (C) Bedding:

Add the following sentences:

- (1) Gravity Flow Sewer Pipe

The bottom of the trench shall be excavated to a minimum of four (4) inches below the outside bottom of the pipe being installed to allow adequate placement and compaction of bedding material prior to installation.

Select bedding material shall be placed a minimum of four (4) inches and a maximum of six (6) inches under the pipe for full width of the trench and halfway up the pipe on the sides. Bedding material shall be placed in layers not exceeding six (6) inches loose thickness for compacting by vibratory mechanical tamps under the haunches and concurrently on each side of the pipe for the full width of the trench. The final result shall be "Class B" bedding for rigid pipe. If the existing material under the pipe bedding material is unsuitable, the unsuitable material shall be removed and replaced with select bedding material (No. 57 or No. 5 stone), as authorized and approved by the Utility Owner.

Page 15-4, Sub-article 1505-3 (D) Pipe Laying

Add the following sentences:

All pipes and fittings shall be carefully lowered into the trench in such a manner to prevent damage to the protective coatings and linings. Under no circumstances shall pipe materials be dropped or dumped into the trench. Pipe shall be carried into position and not dragged.

All dust, dirt, oil, tar (other than standard coating), or other foreign matter shall be cleaned from the jointing surfaces, and the gasket, bell, and spigot shall be lubricated with lubricant recommended by the manufacturer.

All pipe shall be installed in accordance with the approved plans and cut sheets, unless otherwise directed by the Utility Owner.

For water pipe and sewer force main pipes sizes up to 12-inches, mechanical equipment shall not be used to assemble the pipe. For water pipe and sewer force main pipes sizes over 12-inches, mechanical equipment may be used, in accordance with the pipe manufacturer's instructions. Any damage resulting from the use of mechanical equipment shall be replaced as directed by and at no additional cost to the Department.

Gravity flow sewer pipe shall be laid upgrade, beginning at the lower end with the tongue or spigot ends pointing in the direction of the flow to the correct line and grade, unless otherwise approved by the Utility Owner. The sewer pipe section to be installed shall be aligned by batter board or laser beam with the last installed pipe section. Mechanical equipment should not be used to assemble the pipe. Pipe shall be assembled in accordance with the pipe manufacturer's instructions. Any damage resulting from the use of mechanical equipment shall be replaced as directed by and at no additional cost to Department.

Adjustments in grade by exerting force on the barrel of the pipe with excavating equipment shall not be allowed. The Contractor shall verify line and grade after assembling each joint.

No pipe shall be laid in water or where in the Utility Owner's opinion trench conditions are unsuitable. Every precaution shall be taken to prevent material from entering the pipe while it is being installed.

Page 15-4, Sub-article 1505-3(E), Thrust Restraint, third paragraph:

Replace with the following:

At locations where restrained joints are shown on the plans, use ductile iron pipe and fittings with push-on restrained joints. The pipe, joints, and gaskets shall be in accordance with ANSI/AWWA Standards as previously specified for ductile iron pipe in Sub-article 1036-5. Restrained joints, fittings and valves shall be rated for a working pressure of 350 psi for sizes four (4) inches through 24-inches and 250 psi for larger sizes. All factory restrained joint pipe, valves, and fittings shall have the restraints internal to the pipe (i.e., "boltless"). The use of mechanical restraints are not allowed, unless otherwise specifically directed in writing by the Utility Owner. All valves, pipe, and fittings shall be compatible with the factory restraint system. All push-on restrained joint ductile iron pipe and fittings shall be as manufactured by U.S. Pipe's TR-Flex, Griffin Pipe Products SNAP-LOK, American Cast Iron Pipe Company's Flex-Ring Joint, or approved equal.

Special accessories such as mechanical joint retainer glands or field locking gaskets are acceptable on pipe 12-inches and less in diameter, upon approval from the Engineer. Use concrete reaction blacking and thrust collars only where joint restraint is impractical with the approval of the Design Engineer and Utility Owner.

Page 15-4, Sub-article 1505-3, Add Polyethylene Encasement:

Add requirements for Installation of Polyethylene Encasement:

The polyethylene encasement shall prevent contact between the pipe and the surrounding backfill and bedding material but is not intended to be a completely air and watertight enclosure. Overlaps shall be secured by the use of polyethylene adhesive tape, plastic string or other nondegradable material approved by the Design Engineer and capable of holding the encasement in place until backfilling operations are completed. Pipe and fittings shall be wrapped with polyethylene prior to pouring concrete thrust blocks.

Method A - For use with Polyethylene Tubes:

1. Cut polyethylene tube to a length approximately two (2) feet longer than the pipe section.
2. Slip the tube around the pipe, centering it to provide a one (1) foot overlap on each adjacent pipe section, and bunching it accordion-fashion lengthwise until it clears the pipe ends.
3. Lower the pipe into the trench and make up the pipe joint with the preceding section of pipe. A shallow bell hole must be made at joints to facilitate installation of the polyethylene tube.
4. After assembling the pipe joint, make the overlap of the polyethylene tube. Pull the bunched polyethylene from the preceding length of pipe, slip it over the end of the new length of pipe, and secure it in place. Then slip the end of the polyethylene from the new pipe section over the end of the first wrap until it overlaps the joint at the end of the preceding length of pipe. Secure the overlap in place. Take up the slack width at the top of the pipe to make a snug, but not tight, fit along the barrel of the pipe, securing the fold at quarter points.
5. Any cuts, tears, punctures, or other damage to the polyethylene shall be repaired in accordance with Repairs.

Method B - For use with Polyethylene Tubes:

1. Cut polyethylene tube to a length approximately one (1) foot shorter than that of the pipe section. Slip the tube around the pipe, centering it to provide six (6) inches of bare pipe at each end. Take up the slack at the top of the pipe to make a snug, but not tight, fit along the barrel of the pipe, securing the fold at quarter points; secure the ends as described herein under Method A.
2. Before making a joint, slip a three (3) foot length of polyethylene tube over the end of the preceding pipe section, bunching it accordion-fashion lengthwise. After completing the joint, pull the three (3) foot length of polyethylene over the joint, overlapping the polyethylene
3. previously installed on each adjacent section of pipe by at least one (1) foot.
4. Any cuts, tears, punctures, or other damage to the polyethylene shall be repaired in accordance with Repairs.

Method C - For use with Polyethylene Sheets:

1. Cut polyethylene sheet to a length approximately two (2) feet longer than that of the pipe section. Center the cut length to provide a one (1) foot overlap on each adjacent pipe section, bunching it until it clears the pipe ends. Wrap the polyethylene around the pipe so that it circumferentially overlaps the top quadrant of the pipe. Secure the cut edge of polyethylene sheet at intervals of approximately three (3) feet.
2. Lower the wrapped pipe into the trench and make up the pipe joint with the preceding section of pipe. A shallow bell hole must be made at joints to facilitate installation of the polyethylene. After completing the joint, make the overlap and secure the ends as described herein under Method A.
3. Any cuts, tears, punctures, or other damage to the polyethylene shall be repaired in accordance with Repairs.

Appurtenances:

Pipe-Shaped Appurtenances:

1. Cover bends, reducers, offsets, and other pipe-shaped appurtenances with polyethylene in the same manner as the pipe.

Odd-Shaped Appurtenances:

2. When it is not practical to wrap valves, tees, crosses and other odd-shaped pieces in a tube, wrap with a flat sheet or split length of polyethylene tube by passing the sheet under the appurtenance and bringing it up around the body. Make seams by bringing the edges together, folding over twice, and taping down.
3. Tape polyethylene securely in place at valve stem and other penetrations.

Repairs:

Repair any cuts, tears, punctures, or damage to polyethylene with polyethylene adhesive tape or with a short length of polyethylene sheet or a tube cut open, wrapped around the pipe to cover the damaged area, and secured in place.

Openings:

Openings in the encasement shall provide for branches, blowoffs, air valves, and similar appurtenances by making an X-shaped cut in the polyethylene and temporarily folding back the film. After the appurtenance is installed, tape the slack securely to the appurtenance and repair the cut with tape. Service taps and other taps without tapping sleeves should be made directly

through the polyethylene after wrapping the pipe with two (2) to three (3) layers of polyethylene tape, with any resulting damaged areas being repaired as described herein.

Terminations:

Where polyethylene-wrapped pipe joins an adjacent pipe that is not wrapped, extend the polyethylene wrap to cover the adjacent pipe for a distance of at least three (3) feet. Secure the end with circumferential turns of tape. Service lines and other attached lines of dissimilar metals shall be wrapped with polyethylene or a suitable dielectric tape for a minimum clear distance of three (3) feet away from the ductile-iron pipe.

Backfilling for Polyethylene-Wrapped Pipe:

1. Use the same backfill material as specified for pipe without polyethylene wrap, exercising care to prevent damage to the polyethylene wrapping when placing backfill material.
2. Backfill material shall be free from cinders, refuse, boulders, rocks, stones, or other material that could damage the polyethylene. Backfill shall be as specified for the pipe without polyethylene encasement.

Page 15-5, Sub-article 1505-5 Concrete Encasement of Utility Lines

Replace the paragraph with the following:

Water and/or sewer utility lines are not to be encased in concrete unless approved in writing by the utility owner.

Page 15-5, Sub-article 1505-6, Measurement and Payment:

Nitrile Pipe Gaskets

Proposed water or sewer mains to be installed in the vicinity of contaminated soil identified on the plans shall use nitrile pipe gaskets in lieu of standard gaskets. Install nitrile (petroleum resistant) gaskets at the locations shown on the plans or as directed by the Design Engineer.

Nitrile Pipe Gaskets will be measured and paid per each and by pipe diameter.

Payment will be made under:

Pay Item	Pay Unit
__” Nitrile Pipe Gasket	Each

Polyethylene Encasement

Proposed water or sewer main to be installed in the vicinity of contaminated and or corrosive or highly organic soil identified on the plans shall be provided polyethylene encasement at the locations shown on the plans or as directed by the Design Engineer.

Polyethylene encasement will be measured and paid per lineal foot and by pipe diameter.

Payment will be made under:

Pay Item

Polyethylene Encasement on _" Dia. Main

Pay Unit

LF

Division 15, Section 1510-Water Lines**Page 15-5, Sub-article 1510-2 Materials, Paragraph 5**

Add the following sentences:

Splices shall be accomplished using a corrosion proof wire connector. The connectors shall "lock" the wires in place and contain a dielectric sealant to prevent corrosion. The attachment location shall be readily available from finished grade without special equipment.

Page 15-6, Sub-article 1510-3 (A), General:

In the sixth paragraph, replace the words "36" to 42" of cover" with "a minimum of 42" of cover:"

Add the following construction method where concrete thrust blocking is required:

When thrust blocking is to be utilized, backfilling shall not occur until the concrete has time to set. No hydrostatic pressure testing shall occur until the concrete thrust blocking has cured for a minimum of five (5) calendar days.

Add the following construction methods for service interruptions and cut ins:

1. Coordinate all service interruptions with Utility Owner and submit a shut down or service interruption work plan for review and approval by the Utility Owner a minimum of 30 calendar days prior to service interruption. Service interruption shall address all facets of the planned outage and how the Contractor will adhere to service interruption policies and critical items defined herein. The Utility Owner will schedule a test shut down to ensure existing valves are in proper working order. Where existing valves are determined to be non-functional or unable to isolate the work area, a field directive will be issued to insert a valve, or cut in a valve, if other existing valves will not accommodate a service interruption that does not disrupt significant number of customers. A cut in valve installation shall follow these same measures.
2. Perform customer notification adhering to customer notification procedures as contained in these Special Provisions.
3. Provide sufficient construction staff or crews, certified site superintendent present, pumps of sufficient size to quickly dewater and ensure all equipment is present and functional.
4. Provide sufficient lighting for night operations.
5. Provide dual purpose sleeves, retainers glands, fittings, etc. to complete the tie in expeditiously.
6. Perform the following tasks in advance of the shutdown:

- A. Evaluate vertical depth of existing main and any conflicting utilities.
- B. Provide detailed layout plan with dimensions and fittings as part of the shutdown plan.
- C. Complete excavation to pipe.
- D. Preassemble fittings above ground when possible.
- E. Place crushed rock in excavation to provide footing and minimize contamination.
- F. Verify notification of customers has been completed.
- G. Perform the following tasks after shutdown:
 - a. Relieve pressure off existing main through use of existing hydrants or blow-offs which are within the isolated part of the system
 - b. Cut pipe on bottom and sides in manner to dewater pipe quickly and to avoid water spray
 - c. Use cut out section for measurement when possible
 - d. Disinfect fittings and pipe with chlorine solution adhering to Cut in Construction requirements of AWWA C651-14, Section 4.11

Page 15-6, Sub-article 1510-3 (B), Testing and Sterilization:

Replace the third paragraph with:

Perform tests using clean water and provide certified results demonstrating no loss of pressure when pressurized at 200 psi (plus or minus five (5) psi) for two (2) hours.

Page 15-6, Sub-article 1510-3 (B), Testing and Sterilization:

Revise the flushing velocity in the fifth paragraph from 2.5 feet per second to 3.0 feet per second.

Page 15-6, Sub-article 1510-3 (B), Testing and Sterilization:

Replace the sixth paragraph (beginning at line 39) with the following:

Sterilize water lines in accordance with Section 1003 of The Rules Governing Public Water supply and AWWA C651 Section 4.4.3, the Continuous Feed Method. Provide a chlorine solution with between 50 parts per million and 100 parts per million in the initial feed. Solid sterilization agent is not allowed. In no case shall the chlorine level exceed 300 ppm. If the chlorine level is over 300 ppm, the system shall be completely flushed and re-chlorinated. The chlorine solution must remain in contact with all interior surfaces for 24 hours. If the chlorine level drops below 10 parts per million during a 24-hour period, then flush, refill with fresh chlorine solution, and repeat for 24 hours. Once the 24-hour period has passed with the chlorine level at least 10 ppm, thoroughly flush the system until the chlorine solution is dispelled. Coordinate flushing and operation of the valves with the Utility Owner. Provide certified bacteriological and contaminant test results from a state-approved or state-certified laboratory. The Fayetteville Public Works Commission has its own laboratory for conducting bacteriological and contaminant testing on PWC-owned water mains. All samples from PWC-owned water mains shall be taken to the PWC laboratory by the PWC Project Coordinator. Operate all valves and controls to assure thorough sterilization. During the flushing period, open and close each fire hydrant several times to flush the hydrant. Provide all chlorinating equipment, sterilization solution, taps, corporation stops, and blow offs necessary to complete

testing and sterilization. If any disruption to the disinfection process occurs, or if any repair procedure is necessary then the disinfection process shall start over.

The Contractor shall take all necessary measures to prevent downstream erosion caused by flushing the lines. All erosion/damages shall be repaired at no additional expense to the Utility Owner. All environmental regulations governing the release and/or disposal of chlorinated testing water shall be met by the Contractor. AWWA C655 defines "highly chlorinated" water as water having more than four (4) ppm. Any water with a chlorine level greater than four (4) ppm shall be de-chlorinated by the Contractor prior to being released to the environment.

Each valved section shall be tested individually. Where any section of a water line is installed with concrete thrust blocking for fittings or hydrants, the hydrostatic test shall not be made until at least five (5) days after installation of the blocking.

Each valved section of pipe shall be slowly filled with water and the specified test pressure based on the elevation of the lowest point of the line or section under test and corrected to the elevation of the test gauge, shall be applied by means of a pump connected to the pipe in a manner satisfactory to the utility owner's representative. Before applying the specified test pressure, all air shall be expelled from the pipe. If hydrants or blow offs are not available at the high places, taps shall be made to provide blow offs.

Any taps which are not to be used in the final build out (i.e., testing and/or blow off taps) shall be killed out at the main. If these taps are converted to irrigation taps they must be installed according to the standard details and be witnessed by the utility owner. The utility owner shall be present and observe all valve operation by the Contractor. Under no circumstances shall a Contractor tamper with any valves not installed by him unless it is an emergency.

Damaged or defective materials discovered as a result of the pressure test shall be removed and replaced with new material, and the test shall be repeated until the test results are satisfactory to utility owner.

All replacement, repair or retesting shall be accomplished by the Contractor at no additional cost to the Department. All repairs shall be reviewed and approved by the utility owner prior to backfill. The use of couplings, fittings, sleeves, etc. shall be reviewed and approved by utility owner prior to use. The main must successfully pass the hydrostatic test prior to sterilization.

Page 15-6, Sub-article 1510-3 (B), Testing and Sterilization:

Add the following paragraph for water sample analysis:

After disinfection, the water supply shall not be accepted or placed into service until bacteriological tests results or representative water samples analyzed in the State-approved or State-certified laboratory are found to be satisfactory (all samples from PWC-owned mains shall be analyzed in PWC's laboratory). The disinfection shall be repeated until tests indicate the absence of pollution for at least two (2) full days. The utility owner shall be responsible for taking the sample(s), and transporting them to the laboratory.

Page 15-6, Sub-article 1510-3 (B), Testing and Sterilization:

Add the following paragraph for disinfecting cut in points of construction:

Use the procedures for disinfecting of the new installation and the existing main at the cut-in point in accordance with AWWA C651-14, Section 4.11.

Page 15-6, Sub-article 1510-3 Construction Methods

Add the following sentences:

(C) Alignment and Grade

All pipe shall be installed to the required lines and grades. Structures shall be installed at the required locations. The lines and grades of the pipe will generally be indicated by stakes parallel to the line of the pipe. The Contractor shall be responsible for installing the pipe to proper line and grade.

All ductile iron pipe and fittings shall be installed in accordance with ANSI/AWWA C110/A21.10 respectively. All C900 PVC pipe shall be installed in accordance with ASTM D-2321. The PVC pipe shall be installed in a manner that will ensure that external loads will not subsequently cause a decrease of more than five percent (5%) in the vertical cross section dimension (deflection). Whenever it is necessary to deflect pipe, the amount of deflection allowable shall not exceed the values represented in the AWWA standards and the manufacturer's recommendations.

If alignment requires deflection in excess of the specified limitations or as determined by Utility Owner, bends shall be used. Joint deflection shall not exceed 80% of the limits recommended by the pipe manufacturer.

Pipe passing through walls of NCDOT bridges, retaining walls, and other concrete structures shall be factory restrained push-on joint ductile iron and be installed in casings/sleeves in accordance with NCDOT specifications. Annular space between walls and sleeves shall be filled with an approved cement mortar that meets NCDOT specifications. The annular space between the sleeve and the pipe shall be filled with an approved mastic.

Pipe passing through the walls of meter vaults, valve pits, and storm drainage structures shall be restrained joint ductile iron. Pipe shall be installed in a casing/sleeve if determined to be necessary. Annular space between walls and sleeves shall be filled with an approved cement mortar. Annular space between pipe and sleeves shall be filled with mastic. Proposed conflict boxes with storm and water shall be reviewed by the utility owner and approved on a case by case basis.

All ductile iron pipe (regardless of diameter) within casings shall be factory restrained, in accordance with these Special Provisions and the applicable standard details. The use of mechanical restraints shall not be used on pipe within casings.

All ductile iron pipe (regardless of diameter) used for trenchless installations (i.e., horizontal directional drilling, pipe-bursting, etc.) shall be factory restrained, in accordance with these special provisions and the applicable section for the trenchless technology. The use of mechanical restraints shall not be used.

When pipe is field cut, the cut end shall be smooth and at right angles to the axis of the pipe. All sharp edges shall be removed. All field cut pipe shall be beveled. The beveled end of PVC pipe shall be removed, when installing into mechanical joint ductile iron fittings.

When connecting unlike (class, material, etc.) pipe, an approved fitting shall be used. All pipe shall be installed in accordance with AWWA C600 for buried lines and the manufacturer's recommendations. For mechanical joint pipe and fittings, all nuts shall be tightened with a suitable (preferable torque-limiting) wrench. The nuts shall be tightened in accordance with the manufacturer's directions.

Concrete thrust blocking shall be used on all PVC water mains. The concrete thrust blocking shall be in accordance with the standard details. When thrust blocking is to be used, backfilling shall not occur until the concrete has time to set. No hydrostatic pressure testing shall occur until the concrete thrust blocking has cured for a minimum of five (5) calendar days.

Division 15, Section 1515-Utility Controls

Page 15-7, Sub-article 1515-2, Materials:

Add additional sentence to Line 39 as follows:

Refer to Special Provisions for Section 1034 for combination air release valve requirements.

Page 15-8, sub-article 1515-2 Materials:

Add the following paragraph:

(A) Combination Air Relief and Vacuum Valve Assemblies

The automatic air release valve shall be a combination air release valve. Combination air release valves shall be heavy duty "universal" style, single body units, incorporating the functions of an air and vacuum valve within a single housing.

The tap size shall be a minimum of two (2) inches, however if a larger tap is needed it shall be sized accordingly. The valve body, cover flange, and all internal parts shall be 316 stainless steel. The air release orifice shall be as specified by the Design Engineer. The air release valve shall have a maximum working pressure of 200 psi.

All air release valves shall be installed in accordance with the manufacturer's recommendations.

Air relief and vacuum valve manholes shall be 60-inch diameter precast concrete units conforming to ASTM C-478. The combination air relief vacuum valve manhole shall be cast with an anti-microbial admixture, in accordance with manufacturer's instructions. The manholes and valves shall be installed in accordance with the standard detail. The force main shall consist of one full joint of C-900 DR-18 PVC pipe centered at the air relief valve and a minimum of four (4) feet deep.

Combination air relief and vacuum valves shall be installed using stainless steel double strap service saddles, a two (2) inch ball valve, and a two (2) inch x one (1) inch brass tee with a quick connect attachment as shown in the standard detail.

Service saddles for two (2) inch taps on four (4) inch and larger size iron pipe shall be ductile iron with stainless steel double straps, bolts, nuts and washers

Ball valves shall be all bronze construction, with a handle operator. Ball valves shall be manufactured and tested in accordance with AWWA/ANSI C800. The valve shall be equipped with packing nut, gland, and packing material. Ball valves shall be of an approved type made from approved materials conforming to ASTM specifications and shall also meet the approval of Utility Owner. The turn required to travel from fully closed to fully open on a ball valve shall be 90 degrees.

Page 15-8, sub-article 1515-2 Materials:

Replace paragraph beginning “Double check valves...” with the following:

Double Check valves (DCV) and Reduced Pressure Zone principal (RPZ) backflow prevention assemblies shall be on the utility owner’s list of approved backflow devices.

Page 15-8, sub-article 1515-2 Materials:

Revise valve box type in Line 11 as follows: Remove “screw or”. Only slip type valve boxes are permissible.

Page 15-8, sub-article 1515-2 Materials:

Add the following paragraph:

Use Type K copper tubing for all one (1) inch water services installed or relocated. Use a continuous run, without splices, from the corporation stop to the meter for all water services installed or relocated.

If a two (2) inch meter box is located less than five (5) feet away from the main or as directed by the Utility Owner, the two (2) inch pipe and fittings shall be brass from the tap to the meter. Otherwise, use two (2) inch PVC SDR 21 pipe.

Page 15-8, sub-article 1515-3, Construction Methods:

Add the following to the second paragraph:

Provide four (4) NCDOT concrete block at each valve box section and two (2) inch meter box, in accordance with the standard details. Provide NCDOT concrete brick as a meter base for one (1) inch services, in accordance with the standard details.

Page 15-8, sub-article 1515-3(A), Construction Methods, Valves:

Revise the first paragraph as follows:

Install all valves with an approved valve box set flush with the finished ground or finished pavement elevation. Place a 24-inch diameter 2,500 psi precast concrete ring flush with the finished ground around all valve boxes not in pavement. Place a 24-inch diameter 3,000 psi poured in place concrete collar flush with the finished pavement around all valve boxes in a traffic area.

Add the following construction method for valve installation:

Stuffing boxes shall be tightened, and the valve shall be fully opened and fully closed to ensure that all parts are in working condition. A valve box shall be provided for every valve. The valve box shall be centered and plumb over the operating nut of the valve. It shall not transmit shock or stress to the valve. Valves shall be installed in accordance with the standard details.

All tapping sleeves shall be hydrostatically pressure tested prior to the tap being accomplished. **Use of air to complete the pressure test is not acceptable.** The tapping sleeve shall be tested to 200 psi. The utility owner shall witness and approve the testing.

Add the following requirement for dead ends on new mains:

All dead ends on new mains shall have a two (2) inch blow-off assembly installed as indicated on the drawings. The blow-off assembly shall be in accordance with the standard details.

Page 15-8, Sub-article 1515-3(B) Meters:

Add the following paragraphs:

Connect or reconnect meter to the customer's plumbing using brass fittings. A composite, H-20 rated meter box shall be used if the meter is to be located in asphalt or concrete pavement or a traffic area. The meter boxes shall be in accordance with the standard details.

Page 15-8, Sub-article 1515-3(C) Backflow Prevention Assembly:

Add the following paragraph:

Provide a minimum of five (5) feet between the meter and the backflow preventer.

Page 15-8, Sub-article 1515-3 (D) Fire Hydrants:

Add the following sentences:

Fire hydrants shall be located and installed as shown on the approved drawings. Each fire hydrant shall have a minimum of 42-inches of cover. Fittings between the valve and fire hydrant may be used with prior approval from utility owner. The valve shall be located at the main unless otherwise approved by utility owner. Each fire hydrant shall be restrained to the pipe with suitable mechanical joint restraint, in accordance with the standard details. Concrete thrust blocking shall be placed in accordance with the standard details. The hydrant branch shall not be backfilled until

inspected and approved by the utility owner. Fire hydrants shall be installed in accordance with the standard details.

Page 15-9, Sub-article 1515-3(E) Line Stops:

Add the following paragraph:

Unless otherwise indicated on the Drawings, do not use line stops without the authorization of the Design Engineer and utility owner.

Page 15-9, Sub-article 1515-3 (F) Air Release Valves:

Add the following sentences:

Combination Air Release Vacuum Valves shall be installed in accordance with the standard details.

Page 15-9, Sub-Article 1515-4, Measurement and Payment:

Remove “transfer or” from Reconnect Water Meter. New lateral shall be provided from new water main to existing and/or relocated water meter.

Add the following sentence to Line 31 for the definition of Relocate. Relocate all existing automated meter (AMI) assemblies to new location. Where existing meters to be relocated are non-AMIs, Contractor shall install new AMIs as furnished by the Utility Owner. Installation of new AMI shall be incidental to cost of water service lateral installation.

Page 15-9, Section 1515-3(F). The Contractor’s attention is directed to this section.

Add payment item for combination air release valve:

Payment for “_” combination air release valve shall be per each valve, and paid for under the contract price for “_” Combination Air Release Valve”. Such price and payments will be full compensation for all labor, materials, excavation, backfilling and any incidentals necessary to complete the work, as required. The Utility Owner shall furnish the ARV assembly. Contractor shall furnish all other accessories and fittings for a complete installation.

Pay Item:

“_” Combination Air Release Valve

Pay Unit

Each

Page 15-10, Sub-Article 1515-4, Measurement and Payment:

Add the following sentence to Line 2:

Meter box, meter setter, connection of new lateral to meter setter and reconnection of existing plumbing to tailpiece utilizing brass fittings are incidental items.

Division 15, Section 1520-Sanitary Sewer

Page 15-10, Sub-article 1520-2 Materials:

Add the following sentences to Paragraph 5:

For force main sewer pipes, the wire shall be "stubbed" into marker posts and air release valve manholes and secured such that a "direct"/conductive metal detector may be used to trace the pipe location. The marker posts shall be green with a "Sewer Force Main" warning and have internal terminals. The marker posts shall use an anchor system for direct bury installations. The identification wire shall be attached to the marker posts in accordance these Special Provisions. Tracing wire marker posts shall be located no more than 500 feet apart.

When the force main is located in unpaved areas such as easements the marker posts shall be installed along the centerline of the force main. When the force main is located in paved areas the marker posts may be offset from the centerline of the force main in a uniform manner, as directed by the Utility Owner.

Page 15-10, Sub-article 1520-2 Materials

Add the following sentences:

If the Design Engineer determines that an expansion coupling is required, it shall be installed as indicated on the Drawings. The expansion coupling shall not be buried.

All pipe joints within an encasement shall be furnished with manufactured restrained joints, and as specified in the Utility Owner's standard detail for encasements.

For subsurface water crossings (i.e., streams, wetlands), restrained joint ductile iron pipe shall be used. No mechanical restraint systems shall be used. The pipe shall be installed in a casing, in accordance with the approved the detail, unless otherwise specifically approved by Utility Owner.

Transition between ductile iron pipe and HDPE shall be accomplished using mechanical restraints as approved by the Utility Owner.

The same material pipe shall be use from manhole to manhole, unless otherwise approved by the Utility Owner. If the section of pipe between manholes is 250 feet or less, no transitions will be allowed (either all PVC or all ductile iron). Should the length between manholes exceed 250 feet, only one transition will be allowed. Use of a C900 x SDR 26 adaptor shall be used to accomplish the transition. A transition is defined as the use of one C900 x SDR26 adaptor. No more than one (1) adaptor shall be use in any given manhole to manhole segment.

Page 15-11, Sub-Article 1520-3, Construction Method:

Add the following bedding requirements to Line 1:

The bottom of the trench shall be excavated to a minimum of four (4) inches below the outside bottom of the pipe being installed to allow adequate placement and compaction of bedding material prior to installation.

Select bedding material shall be placed a minimum of four (4) inches and a maximum of six (6) inches under the pipe for full width of the trench and halfway up the pipe on the sides. Bedding material shall be placed in layers not exceeding six (6) inches loose thickness for compacting by vibratory mechanical tamps under the haunches and concurrently on each side of the pipe for the full width of the trench. The final result shall be "Class B" bedding for rigid pipe. If the existing material under the pipe bedding material is unsuitable, the unsuitable material shall be removed and replaced with select bedding material (No. 57 or No. 5 stone), as authorized and approved by the Utility Owner.

Delete Line 7 and replace with the following:

Maximum grade for sanitary sewers is 9% unless otherwise approved by the Utility Owner on a case by case basis. Use ductile iron where sewer is required to be installed on maximum grade. Use ductile iron where indicated on Drawings and where the following "protected" conditions are encountered:

1. Sewers entering or crossing streams
2. Sewers located less than 100 feet from any public or private water supply source
3. Where the minimum 18-inch vertical and 10 feet horizontal separation cannot be maintained between sewers (main and laterals) and water mains.

Page 15-11, Sub-article 1520-3(A)(1) Installation:

Add additional bypass pumping requirements as follows:

General

The Contractor shall be prepared to bypass full pipe flows during wet weather in the 15-inch Beaver Creek Outfall and cross-lines that are intercepted by this 15-inch outfall and as where else existing sewers are replaced or connected to. The temporary sewer bypass system shall be capable of pumping the following flows with a suction lift of 20 feet:

- A. Eight (8) inch cross line that comes from the west along Raeford Road and into the Beaver Creek Outfall and all other eight (8) inch sewers that are part of the sewer relocation/replacement work – 370 gpm

Typical dry weather daily flows are anticipated to be lower and may vary considerably throughout the day.

Requirements

The Contractor shall provide all pumps, piping, and other equipment to accomplish this task; perform all construction; obtain all permits; pay all costs; and perform complete restoration of all existing facilities to equal or better condition to the satisfaction of the Department. The Contractor shall be responsible for the design, installation, operation, and maintenance of the temporary bypass pumping system. The Contractor shall provide sufficient documentation to the Utility Owner to demonstrate that he, or his designated subcontractor, have the experience in the design, installation, and maintenance of temporary bypass pumping systems.

The Contractor shall be responsible for all aspects of the bypass operation, including but not limited to: providing access to install, move, and maintain the pumps in the proper position, traffic control, installation and removal of bypass equipment, pump monitoring, testing of the bypass system, re-fueling, maintenance, notification of property owners (should access to private property be necessary), wastewater and fuel spill containment, and removal and replacement of manhole cones (if necessary). The bypass system (pumps and piping) shall be monitored by Contractor personnel at all times, when the bypass operation is in effect.

The Contractor shall have all materials and equipment on site to immediately respond to any emergencies or other event that could impact the bypass system (i.e., leak in the discharge piping, pump failure, flooding, etc.). The Contractor shall have sufficient staff and equipment to mobilize to repair and/or service any equipment within one (1) hour of notification, 24 hours a day, seven (7) days a week. In the event of an emergency, the Contractor shall provide an immediate response and fully cooperate with the Design Engineer, Department, and the Utility Owner.

The Contractor shall install the bypass pumps, equipment, and discharge lines to minimize impacts to the property owners, residents, and environment. The Contractor shall be responsible for determining the best location for the bypass equipment, and the need for any special provisions to ensure access for the customers. Such special provisions include, but are not limited to: installation of ramps, excavation and burial of the bypass lines, temporary fencing, etc. The Contractor bears all responsibility for the maintenance and restoration of any trenches, ramps, access, etc. necessary for the temporary bypass pumping operation.

The Contractor shall take appropriate steps to ensure that all pumps, piping and hoses that carry raw sewage are protected from traffic and the public. The Contractor shall identify the proposed methods to protect the temporary bypass pumping system from traffic and the public as part of the detailed temporary bypass pumping plan. Traffic control shall be performed in accordance with the Department's traffic control plan and measures.

The bypass pumping system shall be monitored by Contractor personnel at all times (24 hours a day, 7 days a week), when the bypass operation is in effect. The Contractor's personnel shall be on-site at all times (24 hours a day, 7 days a week), and stationed at the primary bypass pumps. Depending on the location and system set-up, it may be necessary for the Contractor to station personnel at each of the various bypass pump locations. Unless otherwise approved by the Fayetteville Public Works Commission, one (1) person cannot monitor multiple bypass pump

locations. All bypass pumps, regardless of their location (primary or on secondary lines), shall be equipped with an automatic dialer (or other similar device). The Contractor personnel shall immediately respond to any issue regarding the temporary bypass pumping system. All temporary bypass piping shall be periodically monitored (patrolled from pumps to discharge), but no less frequently than once every 12 hours. The bypass pumping equipment shall be automated and capable of functioning without the assistance of an operator.

Submittals

In the event that it is needed, the Contractor shall submit a detailed bypass pumping plan to the Utility Owner for approval, prior to initiating the bypass operation.

The detailed temporary bypass pumping plan shall include the following information:

- Method of monitoring the pumps to ensure proper operation, to include method of notifying personnel (Utility Owner and Contractor) in the event of an emergency, activation of back-up pumps, etc.
- Method of monitoring upstream system levels to ensure surcharging does not result in back-ups into buildings, overflows, etc.
- The amount, if any, of any required surcharging.
- Method to initiate back-up pumps.
- Map showing general location of the pumps and bypass lines. This shall include means to maintain access to driveways, etc.
- Measures to secure the bypass system (lines, pumps, etc.) from traffic, vandalism, high stream flows, etc.
- Method of plugging (and securing the plug(s)) and type of plugs.
- Size and location of manholes or other access points for suction and discharge piping.
- Size of pipeline(s) or conveyance system(s) to be bypassed.
- Number, size, material, location, and method of installation of suction piping.
- Number, size, material, location, and method of installation of discharge piping.
- Bypass pump sizes, capacities, and number of each size to be provided on-site, including all primary, secondary, and spare pumping units.
- Calculations of static lift, friction losses, and flow velocity (pump curves showing pump operating range shall be submitted). Calculations shall be signed and sealed by a licensed Professional Engineer registered in the State of North Carolina.
- Measures to protect discharge manhole(s) or structure(s) from erosion and damage due to the bypass operation.
- Erosion control measures.
- Emergency contact information for the personnel responsible for the pump operation.
- Emergency contact information for Contractor personnel to respond in the event of an emergency.
- List of available resources (equipment, materials, personnel) and contact information for emergency response.
- Method to contain potential releases of sewer flow from air release valves.

- Contingency plan for responding to potential sewer spills caused by weather, vandalism, acts of God, etc. The plan shall include communication protocols, available resources, and the steps to be taken in the event of an emergency.

Coordination

The Contractor shall fully coordinate their temporary bypass pumping operations with the Utility Owner. It is the Contractor's responsibility to fully determine the scope and location of the temporary bypass pumping system. All coordination (to include location of the pumps and discharge lines) shall be fully discussed and agreed to prior to commencement of bypass operations.

The Contractor shall schedule a coordination meeting with the Design Engineer, Utility Owner and other personnel (Department, Contractor, bypass sub-contractor, etc.) a minimum of three (3) business days prior to starting the temporary bypass pumping system. The purpose of this coordination meeting is to ensure that the Contractor and their sub-contractors have a good understanding of the requirements and expectations of operating the temporary bypass pumping system, discuss contingency plans (to include protocols for emergency contacts), identify location(s) of pumps, verify necessary materials (repair sleeves, containment devices, etc.) are on-site and available, and any other items necessary to ensure that the Utility Owner has confidence that the appropriate personnel can operate and maintain the temporary bypass pumping system. Should, for any reason, the Department and/or Utility Owner deem that the Contractor and/or their sub-contractor is not prepared to operate and maintain the temporary bypass pumping system, the temporary bypass pumping system shall not be started. The Contractor shall take all necessary steps to address any concerns to the satisfaction of the Utility Owner. Upon completion of those actions, another coordination meeting shall be held, in order for the Utility Owner to confirm that the Contractor and their sub-contractor is prepared to operate and maintain the temporary bypass pumping system. This process will be repeated until the Department and Utility Owner are satisfied that the Contractor and their sub-contractor are prepared to operate and maintain the temporary bypass pumping system. No additional contract time will be granted for this delay.

The temporary bypass pumping system shall run for a minimum of 24 hours, or longer as deemed by the Utility Owner, prior to any activity occurring within the main(s) being bypassed.

Flow Control Processes

Where the raw sewage flow will be blocked during the Work as a result of the temporary bypass pumping operation, the Contractor shall take all necessary precautions to protect the public health. No septic conditions shall be allowed due to Contractor's operations. The sewer system (mains, manholes, laterals, etc.) shall also be protected from damage. The following occurrences shall not be allowed:

1. No sewage shall be allowed to back up into any homes or buildings.
2. No sewage shall overflow any manholes, cleanouts or any other access to the sewers.
3. Users upstream of the project area shall be able to use all their water and sewer utilities without interruption or limitations.

If any of the above occur or are expected to occur, the Contractor shall take immediate action to alleviate one or all of the conditions. Additionally, the Contractor is required to observe the conditions upstream of the plug and be prepared to immediately increase bypass pumping or release the flows, as required. Any damage claims resulting from the Contractor's failure to properly maintain sewer flows shall be the Contractor's responsibility.

All sump pumps, bypass pumps, trash pumps or any other type pump which pulls sewage or any type of material out of the sanitary sewer system shall discharge into another sanitary sewer manhole, or appropriate vehicle or container acceptable to the Utility Owner. Under no circumstances shall untreated sanitary sewer be discharged, stored or deposited on the ground, swale, road or open environment. The Contractor shall not allow any flow of sewage onto private property, streets, or into creeks and drainage systems. Damage due to negligence of the Contractor, including, but not limited to, flooded dwellings, damaged property, damaged driveways, etc., shall be corrected immediately by the Contractor at no additional cost to the Department or Utility Owner.

Plugging and Blocking

In some applications, the wastewater flow may be plugged and contained within the capacity of the collection system. This shall only be done when it has been determined the system can accommodate the surcharging without any adverse impact. The Contractor has the sole responsibility for determining whether the system can accommodate surcharging. If this option is selected, the Contractor shall be responsible for continuously monitoring the system to ensure no sewer spills or overflows occur.

A sewer line plug shall be inserted into the line at a manhole upstream from the section being surveyed or repaired. The plug shall be so designed that all or any portion of the operation flows can be released. The Contractor shall secure the plug, to prevent it from being dislodged and moving downstream. Flows shall be bypassed throughout the duration of the work. Flows shall be bypassed in accordance with the approved temporary bypass pumping plan. Upon acceptance of the work by the Utility Owner, the temporary bypass pumping system shall be removed and flows restored.

Pumping and Bypassing

The Contractor, when and where required, shall divert sewer flows for the sewer pipe rehabilitation process, cleaning, television inspection, pipe repairs, manhole replacement and/or rehabilitation, obstruction removals, or other related as required to complete the Work. The pumps and bypass lines shall be of adequate capacity and size to handle and prevent backup or overflow for all flows. The temporary bypass pumping system shall be designed to maintain the flows necessary to meet the requirements of each particular site. The Contractor shall be responsible for furnishing the necessary labor and supervision to set up, operate, and maintain the temporary bypass pumping system. A "set up" consists of the necessary pumps, conduits and other equipment to divert the flow of sewage, from the start to finish of work performed. The temporary bypass pumping system shall include:

- A minimum of one (1) redundant pump so that the temporary bypass pumping system is capable of transmitting the peak flow with the largest duty pump out of service.
- Pumps shall be provided with a means of automatic control via floats or level sensing. Systems requiring manual starting and/or stopping shall not be allowed.
- All equipment (primary and secondary pumps) shall be equipped in a manner to keep noise to a maximum of 65 dBA at 30 feet.
- An automatic dialer (or similar) to immediately notify (in a sequential operation) Contractor and Utility Owner personnel in the event of equipment failure. The automatic dialer shall be set to issue notifications prior to flow level reaching critical elevations and having a spill occur. All bypass pumps (regardless of location) shall be equipped with an automatic dialer (or similar).

The temporary bypass pumping system shall be provided in such a way as to maintain access for businesses and residences. The Contractor shall be responsible for determining the best location for the bypass equipment, and the need for any special provisions to ensure access for the residents and businesses. Such special provisions include, but are not limited to: installation of ramps, excavation and burial of the bypass lines, etc. The Contractor shall use bridges over the bypass lines, temporary lines under driveways, alternate routes, or other means to accomplish this item. The bypass plan submittal shall indicate the means of maintaining access. The Contractor bears all responsibility for the maintenance of any trenches, ramps, etc. necessary for the bypass operation.

Pumps, equipment, and bypass lines shall be continuously (24 hours a day, 7 days a week) monitored by on site Contractor personnel capable of starting, stopping, refueling and maintaining these pumps during the Work. The temporary bypass pumping system shall be provided with an automatic dialer (or other similar device) that will immediately notify (in a sequential operation) the Contractor, Design Engineer and the Utility Owner in the event of equipment failure. All bypass pumps (regardless of location) shall be equipped with an automatic dialer. This automatic dialer (or similar) shall be set to issue notifications prior to flow levels reaching critical elevations and having a spill occur.

The automatic dialer shall be set to issue notifications through a sequential operation. Automatic dialers that are not set up for sequential notifications shall not be acceptable. The Contractor's personnel shall be the first to receive any notifications from the automatic dialer. The automatic dialer shall only notify the PWC personnel after all Contractor notifications have been ignored and/or not responded to. The Contractor shall properly adjust the level at which the automatic dialer initiates notification to provide adequate time for the sequential notification to occur. If the PWC personnel are notified by the automatic dialer, the PWC personnel shall assume that a spill is occurring or is imminent and respond accordingly. The Contractor shall be responsible for all costs for the PWC to mobilize and respond to the notification, regardless if a spill occurred or not.

In some applications, it may be necessary to surcharge the system in order to ensure proper pump operation. This shall only be done when it has been determined the system can accommodate the surcharging without any adverse impact. The Contractor has the sole responsibility for determining whether the system can accommodate surcharging. In the event surcharging is

necessary, the Contractor shall be responsible for continuously monitoring the system to ensure no sewer spills occur.

All bypass piping shall successfully pass a hydrostatic test prior to bypassing the sewer flows. The hydrostatic test pressure shall be no less than the expected discharge pressures and shall be held for a minimum of one (1) hour. All testing shall be observed by the Utility Owner. Testing shall be coordinated with the Utility Owner a minimum of 24 hours in advance.

Spill Response

The Contractor shall not discharge or pump any sewage, solids, or debris on the ground, streets, storm water system, ditches, or streams. Any sewage spills shall be immediately reported to the Department, Design Engineer and Fayetteville Public Works Commission Water Resources Construction Department, (910) 223-4716. After normal business hours, the Contractor shall contact the Fayetteville Public Works Commission Dispatch Center, (910) 678-7400 or (910) 323-0178. The Contractor shall take complete responsibility for all costs related to the clean-up of the spill, including any fines issued by the North Carolina Department of Environmental Quality (NC DEQ).

In the event that raw sewage (in any quantity) is spilled, discharged, leaked or otherwise deposited in the open environment, due to the Contractor's work, the Contractor is responsible for any cleanup of solids and disinfection of the area affected. This work will be performed at the Contractor's expense with no additional cost to the Department and/or Fayetteville Public Works Commission. The Contractor is also responsible for complying with any and all regulatory requirements in regards to the size spill with no additional cost to the Department and/or Fayetteville Public Works Commission. The Contractor shall cooperate fully with the Fayetteville Public Works Commission and the applicable State agencies in responding to and cleaning up the spill. Any work completed by the Fayetteville Public Works Commission in responding to a spill caused by the Contractor's operations shall be billed to the Contractor.

Where sewage has backed up into a property due to any aspect of the Contractor's operation, the Contractor shall immediately notify the Department and Utility Owner, inspect the property with the Department and Utility Owner and agree on remedial measures. The Contractor shall be responsible for all cleaning, repair and/or replacement of damaged property, temporary relocation of all occupants of the affected properties, if required, all to the satisfaction of the property owner. These actions shall be undertaken immediately upon learning of the backup. Cleaning shall be performed by firms specializing in this type of work. All costs associated with the cleaning, repair, replacement of damages, occupant accommodations, insurance and spill remediation shall be borne by the Contractor. All remediation measures required as part of a spill response are part of acceptance of the project, and final payment shall not be made until such time all required measures are addressed and approved by the appropriate regulatory agency.

Page 15-11, Sub-article 1520-3(A)(2) Testing:

Replace the second paragraph with the following:

Test all gravity sewer lines for leakage using the air test. Perform visual inspection on all installed gravity sewer lines and the gravity sewer lines repaired or reconnected to existing and or new manholes. Perform line and grade testing and deflection testing on all gravity sewer lines.

Page 15-12, Sub-article 1520-3(A)(2)(c) Air Test:

Replace Table 1520-1 with:

AIR TEST TIME			
Pipe Dia (in)	Minimum time (minutes)	Length for Min Time (ft)	Time for Longer Length (sec)
4	3:46	597	0.380L
6	5:40	398	0.854L
8	7:34	298	1.520L
10	9:26	239	2.374L
12	11:20	199	3.418L
15	14:10	159	5.342L
16	15:06	149	6.078L
18	17:00	133	7.692L
21	19:50	114	10.470L
24	22:40	99	13.674L
27	25:30	88	17.306L
30	28:20	80	21.366L
33	31:10	72	25.852L
36	34:00	66	30.768L

Page 15-12, Sub-article 1520-3(A)(2)(d) Visual Inspection:

Replace first sentence with the following:

Visually inspect all installed gravity sewer lines and the gravity sewer lines repaired or reconnected to existing and or new manholes from the inside using approved cameras.

Page 15-12, Add Sub-article 1520-3(A)(2)(g) Hydrostatic Test:

Add Hydrostatic Test provisions for gravity sewers as defined as follows:

All sewers within protected conditions (See this Special Provision 1520-3, Line 7) require hydrostatic testing. The Contractor will furnish all labor and material, including test pumps, plugs, and all other incidentals for making hydrostatic tests. Hydrostatic pressure testing shall be conducted on the completed main, including the laterals.

The duration of the pressure test shall be at least one hour or longer, as directed by the Utility Owner. The hydrostatic pressure shall be 150 psi. Each section of pipe shall be slowly filled with water and the specified test pressure based on the elevation of the lowest point of the line or section under test and corrected to the elevation of the test gauge, shall be applied by means of a pump connected to the pipe in a manner satisfactory to the Utility Owner. Before applying the specified test pressure, all air shall be expelled from the pipe.

Page 15-12, Sub-article 1520-3 (B) (1) Installation:

Replace Paragraph 2 with the following:

All sewer force mains shall have automatic air release valves installed at all high points, as indicated on the plans, and in accordance with these special provisions.

Page 15-12, Sub-article 1520-3 (B) (1) Installation

Add the following sentences:

Maintain sewer flow at all times. Use temporary diversions or pumping to maintain flow when connecting proposed sewers to existing sewers. Use engineered temporary pumping systems capable of handling full pipe flow. Use pumping systems with automatic reliable operation or constantly tended manual operation. By-pass pumping assemblies shall be installed in accordance with these Special Provisions.

Page 15-12, Sub-article 1520-3 (B) (1) Installation

Add the following sentences:

(a) Alignment and Grade

All pipe shall be installed to the required lines and grades. Structures shall be installed at the required locations. The lines and grades of the pipe will generally be indicated by stakes parallel to the line of the pipe. The Contractor shall be responsible for installing the pipe to proper line and grade.

Threaded PVC and cemented joints will not be permitted. The ends of push on joints shall be beveled to facilitate assembly. Pipe shall be marked to indicate when the pipe is fully seated and the gasket lubricated to prevent displacement. Care shall be exercised to ensure that the gasket remains in proper position in the bell or coupling while marking the joint.

All pipe installations shall be properly restrained, using either thrust blocks or approved restraint systems. The thrust blocking shall be in accordance with these Special Provisions, and as designed by the Design Engineer. The approved restraint system shall be installed in accordance with the manufacturer's instructions.

Page 15-12, Sub-article 1520-3 (B) (2) Testing, paragraph 1

Add the following sentences:

Where any section of a force main is provided with concrete thrust blocking for fittings, the hydrostatic test shall not be made until at least five (5) days after installation of the blocking unless otherwise approved. The Utility Owner shall be present for all testing. Coordinate with the Utility

Owner for disposing of the test water from the system. If blow offs are not available at the high places, taps shall be made to provide blow offs.

Page 15-13, Sub-article 1520-4, Measurement and Payment

Add the following paragraphs to each respective item:

For Sanitary Gravity Sewer, removal and disposal of existing main shall be incidental to the installation of the new pipe and no separate payment will be made.

Sewer Service Line will be paid per linear foot and by size (four (4) inch or six (6) inch). All fittings will be incidental to Sewer Service Line. Removal and disposal of existing sewer service lateral shall be incidental to the installation of the new sewer service lateral and no separate payment will be made.

Section 1525-Utility Manholes

Page 15-14, Sub-article 1525-2 Materials:

Add the following sentences to Paragraph 3:

The frame and cover shall be manufactured by the same manufacturer. All castings shall be in accordance with the Utility Owner's standard details. Any defective castings shall be removed and replaced. In unpaved areas a cam-lock ring and cover shall be used. Camlock ring and covers shall be in accordance with the Utility Owner's standard details. Camlock bolt head shall be compatible with the standard tool for turning camlock mechanism. Camlock ring and covers shall be installed as indicated on the drawings, in accordance with the Utility Owner's standard details.

Page 15-14, Sub-article 1525-2, Materials:

Add the following provisions for precast concrete sanitary sewer manholes:

All manholes shall be constructed to these Special Provisions. Installation shall be in accordance with ASTM C-891 and these Special Provisions.

An eccentric cone shall be utilized on all manholes, unless otherwise approved by the Utility Owner.

Manhole steps shall be placed in all manholes and shall be steel reinforced (½" grade 60) copolymer polypropylene plastic steps in accordance with ASTM C-478 for material and design. The steps shall be made with serrated treads and wide enough to stand on with both feet.

All reinforced concrete precast manholes shall include a liquid anti-microbial admixture to render the concrete uninhabitable for bacterial growth. The admixture shall be included in the fabrication of the manhole by an approved concrete precast manhole manufacturer. Coatings applied to the interior walls of the manhole shall not be acceptable. The anti-microbial admixture shall be approved by the Utility Owner. A color identifier shall be applied to the interior of each concrete

piece fabricated with the anti-microbial admixture. Each piece shall also be plainly stenciled with the name of the anti-microbial admixture on the exterior of each.

Further, all field mixed mortar, utilized in concrete precast manholes, shall include the anti-microbial admixture. The intent and purpose of this specification is to render all concrete and mortar within sanitary sewer service uninhabitable for bacterial growth. Any defects shall be cause for the replacement and correction of such defect as directed by the Utility Owner, at no additional expense.

Any special linings and coatings that are specified for a manhole and installed at the production facility, in the field, or during repairs, shall be applied in accordance with the applicable special coatings specification and the manufacturer's specifications for that material.

Page 15-14, Sub-article 1525-2, Materials:

Add material specifications for Special Coatings, anti-microbial admixture, as follows:

The liquid anti-microbial admixture shall be used in accordance with the manufacturer's recommendations. The amount of the admixture shall be included in the total water content of the concrete or mortar mix design. The admixture shall be added to the concrete or mortar mix water, to ensure even distribution of the admixture throughout the concrete or mortar mix. When properly prepared, the anti-microbial admixture shall render the concrete or mortar uninhabitable for bacterial growth.

The anti-microbial admixture shall be approved by the Utility Owner. The cost of the admixture shall be included in the fabrication of all sewer manholes and manhole wall sections.

Page 15-14, Sub-article 1525-2, Materials:

Add the following material specification for pipe connections and resilient connector hardware:

Pipe connections to a manhole shall be by gasketed flexible watertight connections or as approved by the Utility Owner.

A watertight, flexible pipe-to-manhole connector shall be used on all pipe to manhole connections, for both new and existing manholes and pipes, unless otherwise specifically authorized in writing by the Utility Owner.

Installation of the connector shall be performed using a calibrated installation tool furnished by the connector manufacturer. Installation shall require no re-tightening after the initial installation. Installation shall be done in accordance with the manufacturer's instructions.

The external compression take-up clamps shall be installed in accordance with the manufacturer's instructions.

The Contractor shall use the proper size connector in accordance with the connector manufacturer's recommendations. All dead-end pipe stubs shall be restrained in accordance with ASTM C-923.

The internal expansion sleeve shall be comprised of Series 300 non-magnetic stainless steel. The external compression take-up clamps shall also be Series 300 non-magnetic stainless steel. No welds shall be utilized in the sleeve and clamp construction.

Page 15-14, Article 1525-3 Construction Methods:

Replace the third paragraph with:

Provide an inside drop assembly on manholes for sewer pipes entering with two and a half (2.5) feet or more vertical drop. Inside drop assemblies shall be used for connections to existing manholes when the drop exceeds two and a half (2.5) feet and the manhole diameter is five (5) feet or larger. Provide a pipe slide where vertical separation between inverts is less than two and a half (2.5) feet.

Replace the fourth paragraph with:

In all sewer manholes, provide steps spaced 16 inches on center. Install steps in line with the effluent opening unless otherwise specified.

Replace the fifth paragraph with:

The invert channel shall be constructed of brick and mortar, in accordance with the manhole details in the plans. Precast inverts are not allowed. The invert channel shall be smooth and semicircular in shape conforming to the inside of the connecting sewer section. Changes in direction of flow shall be made with a smooth curve as large as a radius as the size of the manhole will permit without a decrease in flow velocity. Changes in size and grade of the channel shall be made gradually and evenly. The invert channel walls shall be constructed to three quarters (3/4) of the height of the crown of the outlet sewer and in such a manner not to obstruct maintenance, inspection or flow in the sewers. The inverts shall have a minimum slope of one (1) percent across the bottom of the manhole. A shelf shall be provided on each side of any manhole invert channel. Inverts in manholes with standing water will not be acceptable. The shelf shall be sloped not less than 1:12 (min) and no more than 2:12 (max). The bottom of the boot for the new sewer main or lateral shall be set one (1) inch above existing shelf unless otherwise indicated.

Page 15-15, Article 1525-3 Construction Methods:

Replace Table 1525-1 with:

TABLE 1525-1 MANHOLE CONSTRUCTION
--

Location	Top height above finished grade	Ring and Cover Type
Roadway pavement, Driveways, Sidewalks, Parking lots	Flush \pm 1/4" with concrete collar	Standard Traffic Area Manhole Ring and Cover (H-20 Rated)
Vehicle Recovery Area	Flush \pm 3"	Standard Traffic Area Manhole Ring and Cover with Wiper Gasket and Cam Lock
Manicured Areas	Flush to +2"	Standard non-Traffic Area Manhole Ring and Cover with Wiper Gasket and Cam Lock
Flood Zones less than 3 ft above finished grade	Minimum 18" Above Ground with Vent Extending to 2 feet above 100-year Flood Elevation	Standard non-Traffic Area Manhole Ring and Cover with Wiper Gasket and Cam Lock
Flood Zones greater than 3 ft above finished grade	Minimum 18" Above Ground with Vent Extending to 2 feet above 100-year Flood Elevation	Standard non-Traffic Area Manhole Ring and Cover with Wiper Gasket and Cam Lock
Outfall Areas outside of Flood Zones	Minimum 18" Above Ground	Standard non-Traffic Area Manhole Ring and Cover with Wiper Gasket and Cam Lock

Add additional provisions:

The manhole size shall be in accordance with the following table, unless otherwise specified:

<u>Pipe Size (inches)</u>	<u>Manhole Diameter (inches) **</u>
24 and less	48
27 to 36	60*
42	72

* Where interior drop structures are required, use 60-inch diameter as required in the Utility Owner's standard details.

** Where multiple connections or acute angles are required, larger diameter manhole may be required as indicated on the Drawings.

Page 15-15, Article 1525-3 (B) Construction Methods, Precast Units:

Add the following paragraph:

All exterior manhole riser joints, including the joint at the cone, shall be sealed with an external rubber sleeve. The sleeve shall be made of stretchable, self-shrinking rubber, with a minimum thickness of 30 mils. The back side of each wrap shall be coated with a cross-linked reinforced butyl adhesive. The butyl adhesive shall be a non-hardening sealant, with a minimum thickness of 30 mils.

Page 15-15, Sub-article 1525-3 (D) Testing:

Add the following sentence:

(1) Vacuum Testing Sewer Manholes:

All precast sanitary sewer manholes installed by the Contractor shall be vacuum tested for leakage. This test shall be done in accordance with ASTM C-1244 and in the presence of the Utility Owner. Provide all the necessary labor, materials, equipment, testing apparatus, and all other incidentals necessary to complete the vacuum test. All testing equipment used shall be approved for use in vacuum testing manholes.

Each manhole shall be tested after assembly. All lift holes shall be plugged with an approved non-shrink grout. All lines, including laterals, entering the manhole shall be temporarily plugged. Ensure that the pipes and plugs are secure in place to prevent them being drawn into the manhole. The test head shall be placed directly on top of the concrete surface of the manhole following the manufacturer's recommendations, rather than to the cast iron seating ring.

Manholes may be tested either prior to backfill or post backfill at the contractor's option. For pre-backfill testing, a vacuum of 10 inches of Mercury (inches Hg) shall be drawn on the manhole, the valve on the vacuum line of the test head closed, and the vacuum pump shut off. The time shall be measured for the vacuum to drop to nine (9) inches of Mercury (inches Hg). The manhole is acceptable if the time for the vacuum reading to drop from 10 inches of Mercury to nine (9) inches of Mercury meets or exceeds the values indicated below:

Manhole Depth	Diameter of Manhole		
	4' Diameter	5' Diameter	6' Diameter
10' or less	25 sec	33 sec	41 sec
11' to 15'	38 sec	49 sec	62 sec
16' to 20'	50 sec	65 sec	81 sec
21' to 25'	62 sec	82 sec	101 sec
25' to 30'	74 sec	98 sec	121 sec

Vacuum testing backfilled manholes is not recommended in the presence of groundwater. Vacuum testing a backfilled manhole that is subjected to hydrostatic pressure may exceed the design limits

of the flexible connectors and could lead to failure of the structure, joints, and/or connectors. Where groundwater is present a reduction in the vacuum pressure applied to the manhole will be required. The vacuum shall be reduced by one (1) inch of Mercury for every one (1) foot of hydrostatic head between 12 feet and 21 feet. A vacuum test should not be performed when the hydrostatic head exceeds 22 feet. See the chart below:

Hydrostatic Head (ft)*	12	13	14	15	16	17	18	19	20	21	22
Vacuum Pressure (in Hg)	10	9	8	7	6	5	4	3	2	1	**

*Hydrostatic head above the critical connector (critical connector is bottom most flexible connector)

**Do not perform vacuum test

If the manhole fails the initial test, the manhole shall be repaired by an approved method until a satisfactory test is obtained. All repair methods shall be approved by the Utility Owner prior to being used. Retesting shall be performed until a satisfactory test is accomplished.

Section 1530-Abandon or Remove Utilities

Page 15-16, Sub-article 1530-3(A) Abandoning Pipe:

Add the following paragraphs:

Perform kill-outs of existing mains to be abandoned as designated on the Drawings. Kill-outs shall consist of the following requirements:

1. Kill out shall be done a minimum of five (5) feet from any fitting on the existing water main that is to remain in service.
2. Ductile iron pipe stiff knee shall be four (4) inch diameter for mains 12-inches or less. Utilize eight (8) inch ductile iron pipe or larger for mains larger than 12-inches. Minimum length of five (5) feet of stiff knee shall be provided. Stiff knee shall be encased in concrete. Concrete shall cover the abandoned pipe but it shall not come in contact with the active water main or any fittings on the active water main. Place blocks rated as the same compressive strength as the concrete under the stiff knee to provide support during concrete placement.
3. On the active water main side of the stiff knee, provide full body mechanical joint sleeve with restraining gland and restraining plug or cap.
4. On the abandoned water main side, provide minimum one-quarter (¼) inch steel plate or ductile iron cap or plug.
5. Coordinate outages with Utility Owner and other work to minimize number of planned outages.
6. Abandoned pipe shall be grout filled or removed in accordance with Section 1530.

Remove valves, or close valves and remove the top of the valve box to an elevation two (2) feet below the roadway subgrade or finished grade, and backfill.

Page 15-17, Sub-article 1530-4 Measurement and Payment:

Add the following sentence to the first paragraph:

Kill out of existing water mains to be abandoned shall be incidental to the other work and will not be measured and paid.

Section 1540-Encasement**Page 15-18, Sub-article 1540-2, Materials:**

Add the following paragraphs:

Encasement wall thickness for the railroad crossing shall comply with the following chart unless indicated otherwise on the Drawings or defined by the Department or Railroad.

CARRIER PIPE (dia, in inches)	MIN CASING SIZE (inches)	WALL THICKNESS (inches)	RAILROAD WALL THICKNESS (inches)
4	10	0.188	0.188
6	12	0.250	0.281
8	16	0.250	0.281
12	24	0.250	0.375
16	30	0.312	0.469
18	30	0.312	0.469
24	36	0.375	0.532
30	42	0.500	0.625
36	48	0.500	0.688

The Contractor may substitute larger size casing pipe (particularly for sewer mains where grade and alignment are critical) with the proper wall thickness. All additional costs shall be included in the cost of the encasement. Furthermore, the Contractor will be responsible for all engineering costs to update the 100-year design service life for the larger encasement at their expense.

Page 15-18, Sub-article 1540-2, Materials:

Add the following paragraphs for specifying carrier pipe:

The carrier pipe installed for water or force main applications, within the casing pipe shall be CL 50 ductile iron restrained joint pipe. Use of pressure class ductile iron pipe for water mains is acceptable, in accordance with these Special Provisions for Section 1036. Mechanical joint restraint systems are not an acceptable means of restraint within the casing pipe for water mains or force mains.

The material for the gravity sanitary sewer carrier pipe shall be C900 PVC (DR 18) unless noted on the Drawings to be ductile iron. Where ductile iron is called out, gravity sewer pipe shall be CL 50 ductile iron restrained joint pipe. All ductile iron carrier pipes in sewer service shall have the appropriate lining and coating. Use of restraining gaskets (i.e., field-lock gaskets) is an acceptable means of restraint for gravity sewer mains. Use of iron MJ restraint retaining glands are not approved for restraint within casings.

Add the following paragraphs for specifying the carrier pipe brace or spider assembly:

Provide carbon steel carrier pipe brace with the band being made from 12-gauge minimum thickness and riser being made from eight (8) gauge minimum thickness. Runners shall be minimum two (2) inches wide.

Page 15-18, Sub-article 1540-3 (C), Construction Methods:

Add the following paragraph for Encasements for Future Use:

Mark encasements for future use with a manufactured three (3) sided fiberglass utility marker (color green for sewer and blue for water). Marker shall be anchored in the ground using U-channel Post minimum of two (2) feet in depth. Place marker at the right of way or at the ends of the encasements if encasements extend beyond the right of way. One (1) inch locating rod shall be buried just above ends of encasement and extended into valve box located above ends of encasement for additional means of locating. Install minimum length of three (3) feet of ductile iron main plugged on both ends and supported with one pipe brace. Extend minimum of six (6) inches from encasement and center one (1) inch locating rod above pipe end. Seal annular space with water-tight end seal.

Page 15-18, Sub-article 1540-3 (D), Construction Methods:

Add the following sentences to the first paragraph:

Minimum spacing for carrier pipe brace or spider assemblies shall be at three (3) feet prior to and three (3) feet after each joint of ductile iron carrier pipe. Fasten brace or spider to pipe with heavy duty studs, nuts and washers.

Section 1550-Trenchless Installation of Utilities

Page 15-20, Sub-article 1550-3 (B), Construction Methods:

Add the following sentences to the last paragraph:

For boring and tunneling operations, the certified calculations shall include a geotechnical analysis to confirm the selected method will not result in road settlement or upheaval, a road movement monitoring plan and remediation plan should the work result in settlement or upheaval. For drilling operations, appropriate calculations shall be provided to evaluate hydraulic fracturing and to develop a Fraction Mitigation Contingency Plan.

Page 15-20, Sub-article 1550-4 (A), Trenchless Methods:

Add the following paragraphs for Guided Auger Bore and Jack:

The Contractor shall locate all existing utilities in the proposed location of the jack and bore.

Pilot Tube Guided Auger Bore and Jack

The Pilot Tube Guided Auger Bore and Jack system shall utilize a two or three phase system as described below:

1. Three Pass System

- A. Phase 1 – A rigid steel pilot tube in approximately one-meter lengths shall be installed through the ground from the drive shaft to the receiver shaft by earth displacement with the jacking frame. The alignment of the pilot tube shall be established with a theodolite mounted at the rear of the drive shaft and accurately set to the desired line and grade. The theodolite shall view a lighted target in the lead or steering pilot tube. A camera shall be fitted to the theodolite and shall transmit the image of the crosshair and the target onto a monitor screen to be viewed in the drive shaft by the operator. As the operator advances the pilot tube through the earth the center of the target will drift from the crosshair as a result of the biased or slanted leading tip of the pilot tube. The operator shall rotate the pilot tube as required to orient the slanted steering tip toward the crosshair and continue to advance the pilot tube until it reaches the receiver shaft.
- B. Phase 2 – An enlargement casing with an outside diameter up to one and a half (1 ½) inches larger than the product pipe shall be rigidly connected to the final pilot tube and advanced into the earth behind the pilot tube. An auger shall be used inside the enlargement casing to remove the material being excavated. The auger shall be contained inside the limits of the enlargement casing as it progresses along the proposed alignment. A train of temporary steel casings with an outside diameter very similar to the enlargement casing and used to move the enlargement casing from the drive shaft to the receiver shaft. The enlargement casing will cut a bore hole from the drive shaft to the receiver shaft and the temporary casings will case the hole as it is cut. Each temporary casing shall be fitted with an internal auger to transport the excavated material to the drive shaft where it shall be removed from the shaft and disposed of at an approved location. The pilot tubes shall be recovered in the receiver shaft as the temporary casings are installed.

- C. Phase 3 – The product pipe shall then be installed directly behind the final temporary casing pipe with the jacking frame. The casing pipes and augers shall be recovered in the receiver shaft as the product pipe is installed.

2. Two Pass System

- A. Phase 1 – The pilot tube shall be installed in the same manner described Phase 1 of the Three Pass System.
- B. Phase 2 – The enlargement casing shall be installed in the same manner described in Phase 2 of the Three-Phase System. Each product pipe shall be fitted with an internal protective-casing pipe to house the auger and prevent damage to product pipe. The product pipe shall be installed directly behind the enlargement casing with the internal casing rigidly connected to the auger chamber of the enlargement casing. The internal casing shall be manufactured such that the excavated material does not leak excessively into the product pipe. The internal casing shall be fitted with a protective shoe to protect the product pipe from damage and to support the casing and auger at the centerline of the pipe.

The product pipe shall be advanced along the proposed alignment with the jacking frame thus progressing the enlargement casing from the drive shaft to the receiver shaft with the pilot tubes being recovered in the receiver shaft. The excavated material shall be funneled into and conveyed through the internal casing to the drive shaft where it shall be removed from the shaft and disposed of at an approved location. Upon reaching the receiver shaft the enlargement casing shall be removed and the internal casings and augers retracted and recovered at the drive shaft.

Page 15-20, Sub-article 1550-4 (C), Trenchless Methods:

Add the following paragraph:

The Contractor shall locate all existing utilities in the proposed location of the jack and bore.

Page 15-20, Sub-article 1550-4 (D), Trenchless Methods:

Add the following paragraph:

The Contractor shall locate all existing utilities in the proposed location of the jack and bore.

PROJECT SPECIAL PROVISIONS

Utilities by Others

	1223 Jones Franklin Road Raleigh, NC 27606 Phone: 919.851.8077 Fax: 919.851.8107 wei@wetherilleng.com
---	--

General:

- A) Fayetteville PWC (Power Distribution)**
- B) Fayetteville PWC (Power Transmission)**
- C) Fayetteville PWC (Communication)**
- D) Aqua NC (Water)**
- E) CenturyLink (Communication)**
- F) Level 3 (Communication)**
- G) Spectrum (Communication)**
- H) Piedmont Natural Gas (Gas)**

The conflicting facilities of these concerns will be adjusted prior to the date of availability, unless otherwise noted and are therefore listed in these special provisions for the benefit of the Contractor. All utility work listed herein will be done by the utility owner. All utilities are shown on the plans from the best available information.

The Contractor's attention is directed to Article 105.8 of the Standard Specifications.

Utilities Requiring Adjustment:

Utility relocations are shown on the Utilities by Others Plans.

A) Fayetteville PWC (Power Distribution)

- 1) Relocation work on the power distribution is complete.
- 2) Temporary poles will be set at \pm STA 82+00 and \pm STA 84+80 to move the overhead lines across Raeford Road to allow the installation of new drainage at the creeks. The contractor shall notify Fayetteville PWC 8 weeks in advance of the date temporary relocation must be completed.
- 3) Contact person for Fayetteville PWC: Harry Buckner, RGrid Power
919-606-9208
hbuckner@rgridpower.com

PROJECT SPECIAL PROVISIONS

Utilities by Others

B) Fayetteville PWC (Power Transmission)

- 1) Relocation work on the power Transmission is complete.
- 2) Contact person for Fayetteville PWC: Harry Buckner, RGrid Power
919-606-9208
hbuckner@rgridpower.com

C) Fayetteville PWC (Communication)

- 1) Relocation work on the Communication is complete.
- 2) PWC and NCDOT overhead lines will be moved to the temporary power poles at ±STA 82+00 and ±STA 84+80 to allow the installation of new drainage at the creeks. The contractor shall notify Fayetteville PWC 8 weeks in advance of the date temporary relocation must be completed.
- 3) Contact person for Fayetteville PWC: Harry Buckner, Power Services
919-256-5908
hbuckner@powerservices.com

D) Aqua NC (Water)

- 1) All proposed water relocation work is complete.
- 2) Contact person for Aqua NC: Larry Mitchell, Dewberry
919-424-3741
lmitchell@dewberry.com

E) CenturyLink (Communication)

- 1) Centurylink's relocation is complete.
- 2) The duct bank and manholes in the travel lanes of Raeford Road will be abandoned unless otherwise noted.
- 3) Centurylink's overhead lines will be moved to the temporary power poles at ±STA 82+00 and ±STA 84+80 to allow the installation of new drainage at the creeks. The contractor shall notify Centurylink 8 weeks in advance of the date temporary relocation must be completed.
- 4) Contact person for CenturyLink: Kevin Godwin, 910-366-2142
Kevin.godwin@centurylink.com

PROJECT SPECIAL PROVISIONS

Utilities by Others

F) Level 3 (Communication)

- 1) Relocation of Level 3 's facilities will be complete by November 5, 2021
- 2) Level 3 's overhead lines will be moved to the temporary power poles at ±STA 82+00 and ±STA 84+80 to allow the installation of new drainage at the creeks. The contractor shall notify Level 3 8 weeks in advance of the date temporary relocation must be completed.
- 3) Contact person for Level 3: Brian Walker, 919-710-8893
brian2.walker@centurylink.com

G) Spectrum (Communication)

- 1) Spectrum 's relocation work is complete.
- 2) Spectrum 's overhead lines will be moved to the temporary power poles at ±STA 82+00 and ±STA 84+80 to allow the installation of new drainage at the creeks. The contractor shall notify Spectrum 8 weeks in advance of the date temporary relocation must be completed.
- 3) Contact person for Spectrum: Thomas Roberts, Telecs
919-920-7409
troberts@telecs.com

H) Piedmont Natural Gas (Gas)

- 1) Piedmont Natural Gas ' relocation work is complete.
- 2) The contractor shall notify Piedmont Natural Gas 2 weeks prior to conducting any excavation work over the transmission mains. A Piedmont Natural Gas representative must be on site during any excavation work over the transmission mains that cross Raeford Road at ±STA 26+36.
- 3) Contact person for Piedmont Natural Gas: Robert Memory, Maser Consulting
919-805-1095
rmemory@maserconsulting.com

**Project Special Provisions
Erosion Control**

STABILIZATION REQUIREMENTS:
(4-30-2019)

Stabilization for this project shall comply with the time frame guidelines as specified by the NCG-010000 general construction permit effective April 1, 2019 issued by the North Carolina Department of Environmental Quality Division of Water Resources. Temporary or permanent ground cover stabilization shall occur within 7 calendar days from the last land-disturbing activity, with the following exceptions in which temporary or permanent ground cover shall be provided in 14 calendar days from the last land-disturbing activity:

- Slopes between 2:1 and 3:1, with a slope length of 10 ft. or less
- Slopes 3:1 or flatter, with a slope of length of 50 ft. or less
- Slopes 4:1 or flatter

The stabilization timeframe for High Quality Water (HQW) Zones shall be 7 calendar days with no exceptions for slope grades or lengths. High Quality Water Zones (HQW) Zones are defined by North Carolina Administrative Code 15A NCAC 04A.0105 (25). Temporary and permanent ground cover stabilization shall be achieved in accordance with the provisions in this contract and as directed.

SEEDING AND MULCHING:

(East)

The kinds of seed and fertilizer, and the rates of application of seed, fertilizer, and limestone, shall be as stated below. During periods of overlapping dates, the kind of seed to be used shall be determined. All rates are in pounds per acre.

All Roadway Areas

March 1 - August 31		September 1 - February 28	
50#	Tall Fescue	50#	Tall Fescue
10#	Centipede	10#	Centipede
25#	Bermudagrass (hulled)	35#	Bermudagrass (unhulled)
500#	Fertilizer	500#	Fertilizer
4000#	Limestone	4000#	Limestone

Waste and Borrow Locations

March 1 - August 31		September 1 - February 28	
75#	Tall Fescue	75#	Tall Fescue
25#	Bermudagrass (hulled)	35#	Bermudagrass (unhulled)
500#	Fertilizer	500#	Fertilizer
4000#	Limestone	4000#	Limestone

Note: 50# of Bahiagrass may be substituted for either Centipede or Bermudagrass only upon Engineer's request.

Approved Tall Fescue Cultivars

06 Dust	Escalade	Justice	Serengeti
2 nd Millennium	Essential	Kalahari	Shelby
3 rd Millennium	Evergreen 2	Kitty Hawk 2000	Sheridan
Apache III	Falcon IV	Legitimate	Signia
Avenger	Falcon NG	Lexington	Silver Hawk
Barlexas	Falcon V	LSD	Sliverstar
Barlexas II	Faith	Magellan	Shenandoah Elite
Bar Fa	Fat Cat	Matador	Sidewinder
Barrera	Festnova	Millennium SRP	Skyline
Barrington	Fidelity	Monet	Solara
Barrobusto	Finelawn Elite	Mustang 4	Southern Choice II
Barvado	Finelawn Xpress	Ninja 2	Speedway
Biltmore	Finesse II	Ol' Glory	Spyder LS
Bingo	Firebird	Olympic Gold	Sunset Gold
Bizem	Firecracker LS	Padre	Taccoa
Blackwatch	Firenza	Patagonia	Tanzania
Blade Runner II	Five Point	Pedigree	Trio
Bonsai	Focus	Picasso	Tahoe II
Braveheart	Forte	Piedmont	Talladega
Bravo	Garrison	Plantation	Tarheel
Bullseye	Gazelle II	Proseeds 5301	Terrano
Cannavaro	Gold Medallion	Prospect	Titan ltd
Catalyst	Grande 3	Pure Gold	Titanium LS
Cayenne	Greenbrooks	Quest	Tracer
Cessane Rz	Greenkeeper	Raptor II	Traverse SRP
Chipper	Gremlin	Rebel Exeda	Tulsa Time
Cochise IV	Greystone	Rebel Sentry	Turbo
Constitution	Guardian 21	Rebel IV	Turbo RZ
Corgi	Guardian 41	Regiment II	Tuxedo RZ
Corona	Hemi	Regenerate	Ultimate
Coyote	Honky Tonk	Rendition	Venture
Darlington	Hot Rod	Rhambler 2 SRP	Umbrella
Davinci	Hunter	Rembrandt	Van Gogh
Desire	Inferno	Reunion	Watchdog
Dominion	Innovator	Riverside	Wolfpack II
Dynamic	Integrity	RNP	Xtremegreen
Dynasty	Jaguar 3	Rocket	
Endeavor	Jamboree	Scorpion	

On cut and fill slopes 2:1 or steeper Centipede shall be applied at the rate of 5 pounds per acre and add 20# of Sericea Lespedeza from January 1 - December 31.

Fertilizer shall be 10-20-20 analysis. A different analysis of fertilizer may be used provided the 1-2-2 ratio is maintained and the rate of application adjusted to provide the same amount of plant food as a 10-20-20 analysis and as directed.

Native Grass Seeding and Mulching (East)

Native Grass Seeding and Mulching shall be performed on the disturbed areas of wetlands and riparian areas, and adjacent to Stream Relocation construction within a 50 foot zone on both sides of the stream or depression, measured from top of stream bank or center of depression. The stream bank of the stream relocation shall be seeded by a method that does not alter the typical cross section of the stream bank. Native Grass Seeding and Mulching shall also be performed in the permanent soil reinforcement mat section of preformed scour holes, and in other areas as directed.

The kinds of seed and fertilizer, and the rates of application of seed, fertilizer, and limestone, shall be as stated below. During periods of overlapping dates, the kind of seed to be used shall be determined. All rates are in pounds per acre.

March 1 - August 31		September 1 - February 28	
18#	Creeping Red Fescue	18#	Creeping Red Fescue
6#	Indiangrass	6#	Indiangrass
8#	Little Bluestem	8#	Little Bluestem
4#	Switchgrass	4#	Switchgrass
25#	Browntop Millet	35#	Rye Grain
500#	Fertilizer	500#	Fertilizer
4000#	Limestone	4000#	Limestone

Approved Creeping Red Fescue Cultivars:

- | | | | |
|----------|--------|------|-----------|
| Aberdeen | Boreal | Epic | Cindy Lou |
|----------|--------|------|-----------|

Fertilizer shall be 10-20-20 analysis. A different analysis of fertilizer may be used provided the 1-2-2 ratio is maintained and the rate of application adjusted to provide the same amount of plant food as a 10-20-20 analysis and as directed.

Native Grass Seeding and Mulching shall be performed in accordance with Section 1660 of the *Standard Specifications* and vegetative cover sufficient to restrain erosion shall be installed immediately following grade establishment.

Measurement and Payment

Native Grass *Seeding and Mulching* will be measured and paid for in accordance with Article 1660-8 of the *Standard Specifications*.

All areas seeded and mulched shall be tacked with asphalt. Crimping of straw in lieu of asphalt tack shall not be allowed on this project.

CRIMPING STRAW MULCH:

Crimping shall be required on this project adjacent to any section of roadway where traffic is to be maintained or allowed during construction. In areas within six feet of the edge of pavement, straw is to be applied and then crimped. After the crimping operation is complete, an additional application of straw shall be applied and immediately tacked with a sufficient amount of undiluted emulsified asphalt.

Straw mulch shall be of sufficient length and quality to withstand the crimping operation.

Crimping equipment including power source shall be subject to the approval of the Engineer providing that maximum spacing of crimper blades shall not exceed 8".

TEMPORARY SEEDING:

Fertilizer shall be the same analysis as specified for *Seeding and Mulching* and applied at the rate of 400 pounds and seeded at the rate of 50 pounds per acre. Sweet Sudan Grass, German Millet or Browntop Millet shall be used in summer months and Rye Grain during the remainder of the year. The Engineer will determine the exact dates for using each kind of seed.

FERTILIZER TOPDRESSING:

Fertilizer used for topdressing on all roadway areas except slopes 2:1 and steeper shall be 10-20-20 grade and shall be applied at the rate of 500 pounds per acre. A different analysis of fertilizer may be used provided the 1-2-2 ratio is maintained and the rate of application adjusted to provide the same amount of plant food as 10-20-20 analysis and as directed.

Fertilizer used for topdressing on slopes 2:1 and steeper and waste and borrow areas shall be 16-8-8 grade and shall be applied at the rate of 500 pounds per acre. A different analysis of fertilizer may be used provided the 2-1-1 ratio is maintained and the rate of application adjusted to provide the same amount of plant food as 16-8-8 analysis and as directed.

SUPPLEMENTAL SEEDING:

The kinds of seed and proportions shall be the same as specified for *Seeding and Mulching*, with the exception that no centipede seed will be used in the seed mix for supplemental seeding. The rate of application for supplemental seeding may vary from 25# to 75# per acre. The actual rate per acre will be determined prior to the time of topdressing and the Contractor will be notified in writing of the rate per acre, total quantity needed, and areas on which to apply the supplemental seed. Minimum tillage equipment, consisting of a sod seeder shall be used for incorporating seed into the soil as to prevent disturbance of existing vegetation. A clodbuster (ball and chain) may be used where degree of slope prevents the use of a sod seeder.

MOWING:

The minimum mowing height on this project shall be 4 inches.

LAWN TYPE APPEARANCE:

All areas adjacent to lawns must be hand finished as directed to give a lawn type appearance. Remove all trash, debris, and stones $\frac{3}{4}$ " and larger in diameter or other obstructions that could interfere with providing a smooth lawn type appearance. These areas shall be reseeded to match their original vegetative conditions, unless directed otherwise by the Field Operations Engineer.

RESPONSE FOR EROSION CONTROL:**Description**

Furnish the labor, materials, tools and equipment necessary to move personnel, equipment, and supplies to the project necessary for the pursuit of any or all of the following work as shown herein, by an approved subcontractor.

Section	Erosion Control Item	Unit
1605	Temporary Silt Fence	LF
1606	Special Sediment Control Fence	LF/TON
1615	Temporary Mulching	ACR
1620	Seed - Temporary Seeding	LB
1620	Fertilizer - Temporary Seeding	TN
1631	Matting for Erosion Control	SY
SP	Coir Fiber Mat	SY
1640	Coir Fiber Baffles	LF
SP	Permanent Soil Reinforcement Mat	SY
1660	Seeding and Mulching	ACR
1661	Seed - Repair Seeding	LB
1661	Fertilizer - Repair Seeding	TON
1662	Seed - Supplemental Seeding	LB
1665	Fertilizer Topdressing	TON
SP	Safety/Highly Visible Fencing	LF
SP	Response for Erosion Control	EA

Construction Methods

Provide an approved subcontractor who performs an erosion control action as described in the NPDES Inspection Form SPPP30. Each erosion control action may include one or more of the above work items.

Measurement and Payment

Response for Erosion Control will be measured and paid for by counting the actual number of times the subcontractor moves onto the project, including borrow and waste sites, and satisfactorily completes an erosion control action described in Form 1675. The provisions of Article 104-5 of the *Standard Specifications* will not apply to this item of work.

Payment will be made under:

Pay Item	Pay Unit
Response for Erosion Control	Each

MINIMIZE REMOVAL OF VEGETATION:

The Contractor shall minimize removal of vegetation within project limits to the maximum extent practicable. Vegetation along stream banks and adjacent to other jurisdictional resources outside the construction limits shall only be removed upon approval of Engineer. No additional payment will be made for this minimization work.

STOCKPILE AREAS:

The Contractor shall install and maintain erosion control devices sufficient to contain sediment around any erodible material stockpile areas as directed.

ACCESS AND HAUL ROADS:

At the end of each working day, the Contractor shall install or re-establish temporary diversions or earth berms across access/haul roads to direct runoff into sediment devices. Silt fence sections that are temporarily removed shall be reinstalled across access/haul roads at the end of each working day.

CONSTRUCTION MATERIALS MANAGEMENT

(3-19-19) (rev. 04-27-19)

Description

The requirements set forth shall be adhered to in order to meet the applicable materials handling requirements of the NCG010000 permit. Structural controls installed to manage construction materials stored or used on site shall be shown on the E&SC Plan. Requirements for handling materials on construction sites shall be as follows:

Polyacrylamides (PAMS) and Flocculants

Polyacrylamides (PAMS) and flocculants shall be stored in leak-proof containers that are kept under storm-resistant cover or surrounded by secondary containment structures designed to protect adjacent surface waters. PAMS or other flocculants used shall be selected from the NC DWR List of Approved PAMS/Flocculants. The concentration of PAMS and other flocculants used shall not exceed those specified in the NC DWR List of Approved PAMS/Flocculants and in accordance with the manufacturer's instructions. The NC DWR List of Approved PAMS/Flocculants is available at:

https://files.nc.gov/ncdeq/Water%20Quality/Environmental%20Sciences/ATU/ApprovedPAMS_4_1_2017.pdf

Equipment Fluids

Fuels, lubricants, coolants, and hydraulic fluids, and other petroleum products shall be handled and disposed of in a manner so as not to enter surface or ground waters and in accordance with applicable state and federal regulations. Equipment used on the site must be operated and maintained properly to prevent discharge of fluids. Equipment, vehicle, and other wash waters shall not be discharged into E&SC basins or other E&SC devices. Alternative controls should be provided such that there is no discharge of soaps, solvents, or detergents.

Waste Materials

Construction materials and land clearing waste shall be disposed of in accordance with North Carolina General Statutes, Chapter 130A, Article 9 - Solid Waste Management, and rules governing the disposal of solid waste (15A NCAC 13B). Areas dedicated for managing construction material and land clearing waste shall be at least 50 feet away from storm drain inlets and surface waters unless it can be shown that no other alternatives are reasonably available. Paint and other liquid construction material waste shall not be dumped into storm drains. Paint and other liquid construction waste washouts should be located at least 50 feet away from storm drain inlets unless there is no alternative. Other options are to install lined washouts or use portable, removable bags or bins. Hazardous or toxic waste shall be managed in accordance with the federal Resource Conservation and Recovery Act (RCRA) and NC Hazardous Waste Rules at 15A NCAC, Subchapter 13A. Litter and sanitary waste shall be managed in a manner to prevent it from entering jurisdictional waters and shall be disposed of offsite.

Herbicide, Pesticide, and Rodenticides

Herbicide, pesticide, and rodenticides shall be stored and applied in accordance with the Federal Insecticide, Fungicide, and Rodenticide Act, North Carolina Pesticide Law of 1971 and labeling restrictions.

Concrete Materials

Concrete materials onsite, including excess concrete, must be controlled and managed to avoid contact with surface waters, wetlands or buffers. No concrete or cement slurry shall be discharged from the site. (Note that discharges from onsite concrete plants require coverage under a separate NPDES permit – NCG140000.) Concrete wash water shall be managed in accordance with the *Concrete Washout Structure* provision. Concrete slurry shall be managed and disposed of in accordance with *NCDOT DGS and HOS DCAR Distribution of Class A Residuals Statewide* (Permit No. WQ0035749). Any hardened concrete residue will be disposed of, or recycled on site, in accordance with state solid waste regulations.

Earthen Material Stock Piles

Earthen material stock piles shall be located at least 50 feet away from storm drain inlets and surface waters unless it can be shown that no other alternatives are reasonably available.

Measurement and Payment

Conditions set within the *Construction Materials Management* provision are incidental to the project for which no direct compensation will be made.

WASTE AND BORROW SOURCES:

Payment for temporary erosion control measures, except those made necessary by the Contractor's own negligence or for his own convenience, will be paid for at the appropriate contract unit price for the devices or measures utilized in borrow sources and waste areas.

No additional payment will be made for erosion control devices or permanent seeding and mulching in any commercial borrow or waste pit. All erosion and sediment control practices that may be required on a commercial borrow or waste site will be done at the Contractor's expense.

All offsite Staging Areas, Borrow and Waste sites shall be in accordance with "Borrow and Waste Site Reclamation Procedures for Contracted Projects" located at:

<https://connect.ncdot.gov/resources/roadside/FieldOperationsDocuments/ContractedReclamationProcedures.pdf>

All forms and documents referenced in the "Borrow and Waste Site Reclamation Procedures for Contracted Projects" shall be included with the reclamation plans for offsite staging areas, and borrow and waste sites.

CLEAN WATER DIVERSION:**Description**

This work consists of installing, maintaining, and removing any and all material required for the construction of clean water diversions. The clean water diversions shall be used to direct water flowing from offsite around/away from specific area(s) of construction.

Materials

Refer to Division 10

Item	Section
Geotextile for Soil Stabilization, Type 4	1056

Construction Methods

The Contractor shall install the clean water diversions in accordance with the details in the plans and at locations indicated in the plans, and as directed. Upon installation, the excavated material shall be immediately stabilized as provided in Section 1620 of the *Standard Specifications*. Other stabilization methods may be utilized with prior approval from the Engineer.

Line clean water diversion with geotextile unrolled in the direction of flow and lay smoothly but loosely on soil surface without creases. Bury top of slope geotextile edge in a trench at least 5" deep and tamp securely. Make vertical overlaps a minimum of 18" with upstream geotextile overlapping the downstream geotextile.

Secure geotextile with eleven gauge wire staples shaped into a *u* shape with a length of not less than 6" and a throat not less than 1" in width. Place staples along outer edges and throughout the geotextile a maximum of 3 ft. horizontally and vertically.

Measurement and Payment

Silt Excavation will be measured and paid for in accordance with Article 1630-4 of the *Standard Specifications*.

Geotextile for Soil Stabilization will be measured and paid for in accordance with Article 270-4 of the *Standard Specifications*.

Stabilization of the excavated material will be paid for as *Temporary Seeding* as provided in Section 1620 of the *Standard Specifications*.

Such price and payment shall be considered full compensation for all work covered by this section including all materials, construction, maintenance, and removal of the clean water diversions.

SAFETY FENCE AND JURISDICTIONAL FLAGGING:**Description**

Safety Fence shall consist of furnishing materials, installing and maintaining polyethylene or polypropylene fence along the outside riparian buffer, wetland, or water boundary, or other boundaries located within the construction corridor to mark the areas that have been approved to infringe within the buffer, wetland, endangered vegetation, culturally sensitive areas or water. The fence shall be installed prior to any land disturbing activities.

Interior boundaries for jurisdictional areas noted above shall be delineated by stakes and highly visible flagging.

Jurisdictional boundaries at staging areas, waste sites, or borrow pits, whether considered outside or interior boundaries shall be delineated by stakes and highly visible flagging.

Materials**(A) Safety Fencing**

Polyethylene or polypropylene fence shall be a highly visible preconstructed safety fence approved by the Engineer. The fence material shall have an ultraviolet coating.

Either wood posts or steel posts may be used. Wood posts shall be hardwood with a wedge or pencil tip at one end, and shall be at least 5 ft. in length with a minimum nominal 2" x 2" cross section. Steel posts shall be at least 5 ft. in length, and have a minimum weight of 0.85 lb/ft of length.

(B) Boundary Flagging

Wooden stakes shall be 4 feet in length with a minimum nominal 3/4" x 1-3/4" cross section. The flagging shall be at least 1" in width. The flagging material shall be vinyl and shall be orange in color and highly visible.

Construction Methods

No additional clearing and grubbing is anticipated for the installation of this fence. The fence shall be erected to conform to the general contour of the ground.

(A) Safety Fencing

Posts shall be set at a maximum spacing of 10 ft., maintained in a vertical position and hand set or set with a post driver. Posts shall be installed a minimum of 2 ft. into the ground. If hand set, all backfill material shall be thoroughly tamped. Wood posts may be sharpened to a dull point if power driven. Posts damaged by power driving shall be removed and replaced prior to final

acceptance. The tops of all wood posts shall be cut at a 30-degree angle. The wood posts may, at the option of the Contractor, be cut at this angle either before or after the posts are erected.

The fence geotextile shall be attached to the wood posts with one 2" galvanized wire staple across each cable or to the steel posts with wire or other acceptable means.

Place construction stakes to establish the location of the safety fence in accordance with Article 105-9 or Article 801-1 of the *Standard Specifications*. No direct pay will be made for the staking of the safety fence. All stakeouts for safety fence shall be considered incidental to the work being paid for as "Construction Surveying", except that where there is no pay item for construction surveying, all safety fence stakeout will be performed by state forces.

The Contractor shall be required to maintain the safety fence in a satisfactory condition for the duration of the project as determined by the Engineer.

(B) Boundary Flagging

Boundary flagging delineation of interior boundaries shall consist of wooden stakes on 25 feet maximum intervals with highly visible orange flagging attached. Stakes shall be installed a minimum of 6" into the ground. Interior boundaries may be staked on a tangent that runs parallel to buffer but must not encroach on the buffer at any location. Interior boundaries of hand clearing shall be identified with a different colored flagging to distinguish it from mechanized clearing.

Boundary flagging delineation of interior boundaries will be placed in accordance with Article 105-9 or Article 801-1 of the *Standard Specifications*. No direct pay will be made for delineation of the interior boundaries. This delineation will be considered incidental to the work being paid for as *Construction Surveying*, except that where there is no pay item or construction surveying the cost of boundary flagging delineation shall be included in the unit prices bid for the various items in the contract. Installation for delineation of all jurisdictional boundaries at staging areas, waste sites, or borrow pits shall consist of wooden stakes on 25 feet maximum intervals with highly visible orange flagging attached. Stakes shall be installed a minimum of 6" into the ground. Additional flagging may be placed on overhanging vegetation to enhance visibility but does not substitute for installation of stakes.

Installation of boundary flagging for delineation of all jurisdictional boundaries at staging areas, waste sites, or borrow pits shall be performed in accordance with Subarticle 230-4(B)(5) or Subarticle 802-2(F) of the *Standard Specifications*. No direct pay will be made for this delineation, as the cost of same shall be included in the unit prices bid for the various items in the contract.

The Contractor shall be required to maintain alternative stakes and highly visible flagging in a satisfactory condition for the duration of the project as determined by the Engineer.

Measurement and Payment

Safety Fence will be measured and paid as the actual number of linear feet of polyethylene or polypropylene fence installed in place and accepted. Such payment will be full compensation

including but not limited to furnishing and installing fence geotextile with necessary posts and post bracing, staples, tie wires, tools, equipment and incidentals necessary to complete this work.

Payment will be made under:

Pay Item	Pay Unit
Safety Fence	Linear Foot

SKIMMER BASIN WITH BAFFLES: (East)

Description

Provide a skimmer basin to remove sediment from construction site runoff at locations shown in the erosion control plans. See the Skimmer Basin with Baffles Detail sheet provided in the erosion control plans. Work includes constructing sediment basin, installation of temporary slope drain pipe and coir fiber baffles, furnishing, installation and cleanout of skimmer, providing and placing stone pad on bottom of basin underneath skimmer device, providing and placing a geotextile spillway liner, providing coir fiber mat stabilization for the skimmer outlet, disposing of excess materials, removing temporary slope drain, coir fiber baffles, geotextile liner and skimmer device, backfilling basin area with suitable material and providing proper drainage when basin area is abandoned.

Materials

Item	Section
Stone for Erosion Control, Class B	1042
Geotextile for Soil Stabilization, Type 4	1056
Fertilizer for Temporary Seeding	1060-2
Seed for Temporary Seeding	1060-4
Seeding and Mulching	1060-4
Matting for Erosion Control	1060-8
Staples	1060-8
Coir Fiber Mat	1060-14
Temporary Slope Drain	1622-2
Coir Fiber Baffle	1640

Provide appropriately sized and approved skimmer device.

Provide Schedule 40 PVC pipe with a length of 6 ft. to attach to the skimmer and the coupling connection to serve as the arm pipe. For skimmer sizes of 2.5 in. and smaller, the arm pipe diameter shall be 1.5 inches. For skimmer sizes of 3 in. and larger, refer to manufacturer recommendation.

Provide 4" diameter Schedule 40 PVC pipe to attach to coupling connection of skimmer to serve as the barrel pipe through the earthen dam.

The geotextile for the spillway liner shall meet the following minimum physical properties for low permeability, woven polypropylene geotextiles:

Property	Test Method	Value	Unit
Tensile Strength	ASTM D-4632	315	lb.
Tensile Elongation (Maximum)	ASTM D-4632	15	%
Trapezoidal Tear	ASTM D-4533	120	lbs.
CBR Puncture	ASTM D-6241	900	lbs.
UV Resistance (% retained at 500 hrs.)	ASTM D-4355	70	%
Apparent Opening Size (AOS)	ASTM D-4751	40	US Std. Sieve
Permittivity	ASTM D-4491	0.05	sec ⁻¹
Water Flow Rate	ASTM D-4491	4	gal/min/ft ²

Anchors: Staples, stakes, or reinforcement bars shall be used as anchors.

Wooden Stakes:

Provide hardwood stakes 12"- 24" long with a 2" x 2" nominal square cross section. One end of the stake must be sharpened or beveled to facilitate driving through the coir fiber mat and down into the underlying soil. The other end of the stake needs to have a 1"- 2" long head at the top with a 1"- 2" notch following to catch and secure the coir fiber mat.

Steel Reinforcement Bars:

Provide uncoated #10 steel reinforcement bars 24" nominal length. The bars shall have a 4" diameter bend at one end with a 4" straight section at the tip to catch and secure the coir fiber mat.

Staples:

Provide staples made of 0.125" diameter new steel wire formed into a *u* shape not less than 12" in length with a throat of 1" in width.

Construction Methods

Excavate basin according to the erosion control plans with basin surface free of obstructions, debris, and pockets of low-density material. Install temporary slope drain pipe and construct the primary spillway according to the Skimmer Basin with Baffles Detail sheet in the erosion control plans. Temporary slope drain pipe at inlet of basin may be replaced by Type 4 geotextile as directed. Construct the coir fiber baffles according to *Roadway Standard Drawings* No. 1640.01 and Section 1640 of the *Standard Specifications*.

Install skimmer device according to manufacturer recommendations. Install 4" Schedule 40 PVC pipe into dam on the lower side of basin 1 ft. from the bottom of the basin and according to the detail, and extend the pipe so the basin will drain. Attach a 6 ft. arm pipe to the coupling connection

and skimmer according to manufacturer recommendations. The coupling shall be rigid and non-buoyant and not exceed a diameter of 4" and 12" in length. Attach the rope included with the skimmer to the tee between the vent socket and the tube inlet, and the other end to a wooden stake or metal post. Clean out skimmer device when it becomes clogged with sediment and/or debris and is unable to float at the top of water in skimmer basin. Take appropriate measures to avoid ice accumulation in the skimmer device. Construct a stone pad of Class B stone directly underneath the skimmer device at bottom of basin. The pad shall be a minimum of 12" in height, and shall have a minimum cross sectional area of 4 ft. by 4 ft.

Line primary spillway with low permeability polypropylene geotextile unrolled in the direction of flow and lay smoothly but loosely on soil surface without creases. Bury edges of geotextile in a trench at least 5" deep and tamp firmly. If geotextile for the primary spillway is not one continuous piece of material, make horizontal overlaps a minimum of 18" with upstream geotextile overlapping the downstream geotextile. Secure geotextile with eleven gauge wire staples shaped into a *u* shape with a length of not less than 12" and a throat not less than 1" in width. Place staples along outer edges and throughout the geotextile a maximum of 3 ft. horizontally and vertically. Geotextile shall be placed to the bottom and across the entire width of the basin according to the Skimmer Basin with Baffles detail. Place sealant inside basin around barrel pipe on top of geotextile with a minimum width of 6 in.

At the skimmer outlet, provide a smooth soil surface free from stones, clods, or debris that will prevent contact of the coir fiber matting with the soil. Unroll the matting and apply without stretching such that it will lie smoothly but loosely on the soil surface. Wooden stakes, reinforcement bars, or staples may be used as anchors in accordance with the details in the plans and as directed. Place anchors across the matting at the ends approximately 1 ft. apart. Place anchors along the outer edges and down the center of the matting 3 ft. apart.

All bare side slope sections of the skimmer basin shall be seeded with a temporary or permanent seed mix as directed and in accordance with Articles 1620-3, 1620-4, 1620-5, 1660-4, 1660-5 and 1660-7 of the *Standard Specifications*. Straw or excelsior matting shall be installed on all bare side slope sections immediately upon the completion of seeding and in accordance with Article 1631-3 of the *Standard Specifications*.

Measurement and Payment

Silt Excavation will be measured and paid for in accordance with Article 1630-4 of the *Standard Specifications*, as calculated from the typical section throughout the length of the basin as shown on the final approved plans.

Geotextile for Soil Stabilization will be measured and paid for in accordance with Article 270-4 of the *Standard Specifications*.

Low Permeability Geotextile will be measured and paid for as the actual number of square yards measured along the surface of the spillway over which the geotextile is installed and accepted.

Coir Fiber Baffles will be measured and paid for in accordance with Article 1640-4 of the *Standard Specifications*.

___" *Skimmer* will be measured in units of each. ___" *Skimmer* will be measured and paid for as the maximum number of each size skimmer acceptably installed and in use at any one time during the life of the project. Barrel and arm pipe, cleanout, relocation and reinstallation of ___" *Skimmer* is considered incidental to the measurement of the quantity of ___" *Skimmer* and no separate payment will be made. No separate payment shall be made if ___" *Skimmer*, barrel and/or arm pipe(s) are damaged by ice accumulation.

Coir Fiber Mat will be measured and paid for as the actual number of square yards measured along the surface of the ground over which coir fiber mat is installed and accepted.

Temporary Slope Drain will be measured and paid for in accordance with Article 1622-4 of the *Standard Specifications*.

Stone for Erosion Control, Class ___ will be measured and paid for in accordance with Article 1610-4 of the *Standard Specifications*.

Seeding and Mulching will be measured and paid for in accordance with Article 1660-8 of the *Standard Specifications*.

Seed for Temporary Seeding will be measured and paid for in accordance with Article 1620-6 of the *Standard Specifications*.

Fertilizer for Temporary Seeding will be measured and paid for in accordance with Article 1620-6 of the *Standard Specifications*.

Matting for Erosion Control will be measured and paid for in accordance with Article 1631-4 of the *Standard Specifications*.

No measurement will be made for other items or for over excavation or stockpiling.

Payment will be made under:

Pay Item	Pay Unit
___" Skimmer	Each
Coir Fiber Mat	Square Yard
Low Permeability Geotextile	Square Yard

COIR FIBER WATTLES WITH POLYACRYLAMIDE (PAM):

Description

Coir Fiber Wattles are tubular products consisting of coir fibers (coconut fibers) encased in coir fiber netting. Coir Fiber Wattles are used on slopes or channels to intercept runoff and act as a

velocity break. Coir Fiber Wattles are to be placed at locations shown on the plans or as directed. Installation shall follow the detail provided in the plans and as directed. Work includes furnishing materials, installation of coir fiber wattles, matting installation, PAM application, and removing wattles.

Materials

Coir Fiber Wattle shall meet the following specifications:

100% Coir (Coconut) Fibers	
Minimum Diameter	12 in.
Minimum Density	3.5 lb/ft ³ +/- 10%
Net Material	Coir Fiber
Net Openings	2 in. x 2 in.
Net Strength	90 lbs.
Minimum Weight	2.6 lbs./ft. +/- 10%

Anchors: Stakes shall be used as anchors.

Wooden Stakes:

Provide hardwood stakes a minimum of 2-ft. long with a 2 in. x 2 in. nominal square cross section. One end of the stake must be sharpened or beveled to facilitate driving down into the underlying soil.

Matting shall meet the requirements of Article 1060-8 of the *Standard Specifications*, or shall meet specifications provided elsewhere in this contract.

Provide staples made of 0.125" diameter new steel wire formed into a *u* shape not less than 12" in length with a throat of 1" in width.

Polyacrylamide (PAM) shall be applied in powder form and shall be anionic or neutrally charged. Soil samples shall be obtained in areas where the wattles will be placed, and from offsite material used to construct the roadway, and analyzed for the appropriate PAM flocculant to be utilized with each wattle. The PAM product used shall be listed on the North Carolina Department of Environmental Quality Division of Water Resources web site as an approved PAM product for use in North Carolina.

Construction Methods

Coir Fiber Wattles shall be secured to the soil by wire staples approximately every 1 linear foot and at the end of each section of wattle. A minimum of 4 stakes shall be installed on the downstream side of the wattle with a maximum spacing of 2 linear feet along the wattle, and according to the detail. Install a minimum of 2 stakes on the upstream side of the wattle according to the detail provided in the plans. Stakes shall be driven into the ground a minimum of 10 in.

with no more than 2 in. projecting from the top of the wattle. Drive stakes at an angle according to the detail provided in the plans.

Only install coir fiber wattle(s) to a height in ditch so flow will not wash around wattle and scour ditch slopes and according to the detail provided in the plans and as directed. Overlap adjoining sections of wattles a minimum of 6 in.

Installation of matting shall be in accordance with the detail provided in the plans, and in accordance with Article 1631-3 of the *Standard Specifications*, or in accordance with specifications provided elsewhere in this contract.

Apply PAM over the lower center portion of the coir fiber wattle where the water is going to flow over at a rate of 2 ounces per wattle, and 1 ounce of PAM on matting on each side of the wattle. PAM applications shall be done during construction activities after every rainfall event that is equal to or exceeds 0.50 in.

The Contractor shall maintain the coir fiber wattles until the project is accepted or until the wattles are removed, and shall remove and dispose of silt accumulations at the wattles when so directed in accordance with the requirements of Section 1630 of the *Standard Specifications*.

Measurement and Payment

Coir Fiber Wattles will be measured and paid for by the actual number of linear feet of wattles which are installed and accepted. Such price and payment will be full compensation for all work covered by this section, including, but not limited to, furnishing all materials, labor, equipment and incidentals necessary to install the *Coir Fiber Wattles*.

Matting will be measured and paid for in accordance with Article 1631-4 of the *Standard Specifications*, or in accordance with specifications provided elsewhere in this contract.

Polyacrylamide(PAM) will be measured and paid for by the actual weight in pounds of PAM applied to the coir fiber wattles. Such price and payment will be full compensation for all work covered by this section, including, but not limited to, furnishing all materials, labor, equipment and incidentals necessary to apply the *Polyacrylamide(PAM)*.

Payment will be made under:

Pay Item	Pay Unit
Polyacrylamide(PAM)	Pound
Coir Fiber Wattle	Linear Foot

SILT FENCE COIR FIBER WATTLE BREAK:

(8-21-12)

1605,1630

Description

Silt fence coir fiber wattle breaks are tubular products consisting of coir fibers (coconut fibers) encased in coir fiber netting and used in conjunction with temporary silt fence at the toe of fills to intercept runoff. Silt fence coir fiber wattle breaks are to be placed at locations shown on the plans or as directed. Installation shall follow the detail provided in the plans and as directed. Work includes furnishing materials, installation, maintenance and removing Silt fence coir fiber wattle breaks.

Materials

Coir fiber wattle shall meet the following specifications:

100% Coir (Coconut) Fibers	
Minimum Diameter	12"
Minimum Length	10 ft
Minimum Density	3.5 lb/cf \pm 10%
Net Material	Coir Fiber
Net Openings	2" x 2"
Net Strength	90 lb.
Minimum Weight	2.6 lb/ft \pm 10%

Stakes shall be used as anchors. Provide hardwood stakes a minimum of 2-ft long with a 2" x 2" nominal square cross section. One end of the stake shall be sharpened or beveled to facilitate driving down into the underlying soil.

Provide staples made of 0.125" diameter new steel wire formed into a U-shape not less than 12" in length with a throat of 1" in width.

Construction Methods

Excavate a trench the entire length of each wattle with a depth of 1" to 2" for the wattle to be placed. Secure silt fence coir fiber wattle breaks to the soil by wire staples approximately every linear foot and at the end of each wattle. Install at least 4 stakes on the downslope side of the wattle with a maximum spacing of 2 linear feet and according to the detail. Install at least 2 stakes on the upslope side of the silt fence coir fiber wattle break according to the detail provided in the plans. Drive stakes into the ground at least 10" with no more than 2" projecting from the top of the wattle. Drive stakes at an angle according to the detail provided in the plans.

Install temporary silt fence in accordance with Section 1605 of the *Standard Specifications* and overlap each downslope side of silt fence wattle break by 6".

Maintain the silt fence coir fiber wattle breaks until the project is accepted or until the silt fence coir fiber wattle breaks are removed, and remove and dispose of silt accumulations at the silt fence coir fiber wattle breaks when so directed in accordance with Section 1630 of the *Standard Specifications*.

Measurement and Payment

Coir Fiber Wattle will be measured and paid as the actual number of linear feet of wattles installed and accepted. Such price and payment will be full compensation for all work covered by this provision, including, but not limited to, furnishing all materials, labor, equipment and incidentals necessary to install the silt fence coir fiber wattle break.

Payment will be made under:

Pay Item	Pay Unit
Coir Fiber Wattle	Linear Foot

TEMPORARY ROCK SILT CHECK TYPE A WITH EXCELSIOR MATTING AND POLYACRYLAMIDE (PAM):

Description

Temporary Rock Silt Checks Type A with Excelsior Matting and Polyacrylamide (PAM) are devices utilized in temporary and permanent ditches to reduce runoff velocity and incorporate PAM into the construction runoff to increase settling of sediment particles and reduce turbidity of runoff. Temporary Rock Silt Checks Type A with Excelsior Matting and PAM are to be placed at locations shown on the plans or as directed. Installation shall follow the detail provided in the plans and as directed. Work includes furnishing materials, installation of Temporary Rock Silt Checks Type A, matting installation, PAM application, and removing Temporary Rock Silt Checks Type A with Excelsior Matting and PAM.

Materials

Structural stone shall be class B stone that meets the requirements of Section 1042 of the *Standard Specifications* for Stone for Erosion Control, Class B.

Sediment control stone shall be #5 or #57 stone, which meets the requirements of Section 1005 of the *Standard Specifications* for these stone sizes.

Matting shall meet the requirements of Excelsior Matting in Subarticle 1060-8(B) of the *Standard Specifications*, or shall meet specifications provided elsewhere in this contract.

Polyacrylamide (PAM) shall be applied in powder form and shall be anionic or neutrally charged. Soil samples shall be obtained in areas where the Temporary Rock Silt Checks Type A with Excelsior Matting and PAM will be placed, and from offsite material used to construct the roadway, and analyzed for the appropriate PAM flocculant to be utilized with each Temporary

Rock Silt Check Type A. The PAM product used shall be listed on the North Carolina Department of Environmental Quality Division of Water Resources web site as an approved PAM product for use in North Carolina.

Construction Methods

Temporary Rock Silt Checks Type A shall be installed in accordance with Subarticle 1633-3(A) of the *Standard Specifications*, Roadway Standard Drawing No. 1633.01 and the detail provided in the plans.

Installation of matting shall be in accordance with the detail provided in the plans, and anchored by placing Class B stone on top of the matting at the upper and lower ends.

Apply PAM at a rate of 4 ounces over the center portion of the Temporary Rock Silt Checks Type A and matting where the water is going to flow over. PAM applications shall be done during construction activities and after every rainfall event that is equal to or exceeds 0.50 in.

The Contractor shall maintain the Temporary Rock Silt Checks Type A with Excelsior Matting and PAM until the project is accepted or until the Temporary Rock Silt Checks Type A with Excelsior Matting and PAM are removed, and shall remove and dispose of silt accumulations at the Temporary Rock Silt Checks Type A with Excelsior Matting and PAM when so directed in accordance with the requirements of Section 1630 of the *Standard Specifications*.

Measurement and Payment

Temporary Rock Silt Checks Type A will be measured and paid for in accordance with Article 1633-5 of the *Standard Specifications*, or in accordance with specifications provided elsewhere in this contract.

Matting will be measured and paid for in accordance with Article 1631-4 of the *Standard Specifications*, or in accordance with specifications provided elsewhere in this contract.

Polyacrylamide(PAM) will be measured and paid for by the actual weight in pounds of PAM applied to the Temporary Rock Silt Checks Type A. Such price and payment will be full compensation for all work covered by this section, including, but not limited to, furnishing all materials, labor, equipment and incidentals necessary to apply the *Polyacrylamide(PAM)*.

Payment will be made under:

Pay Item	Pay Unit
Polyacrylamide(PAM)	Pound

BORROW PIT DEWATERING BASIN:

(3-17-09) (Rev 3-2-11)

Description

Water discharge from borrow pit sites shall not cause surface waters to exceed 50 NTUs (nephelometric turbidity unit) in streams not designated as trout waters and 10 NTUs in streams, lakes or reservoirs designated as trout waters. For lakes and reservoirs not designated as trout waters, the turbidity shall not exceed 25 NTUs. If the turbidity exceeds these levels due to natural background conditions, the existing turbidity level shall not be increased.

Construct, maintain and remove earth embankments used to reduce turbidity from dewatering borrow sites. Work includes providing porous coir fiber baffle, filtration geotextile, stone and outlet structures; cleaning out, maintaining, removing and disposing of the borrow pit dewatering basin and all components; and reshaping, dressing, seeding and mulching the area.

Materials

Refer to Division 10

Item	Section
Riprap, Class A, B, 1, and 2	1042
Geotextile for Drainage, Type 2	1056
Coir Fiber Baffle	1640-2

Use suitable excavated materials, as specified in Sections 225, 230 and 240 of the *Standard Specifications* in the construction of earth embankments for borrow pit dewatering basins, except where otherwise specified.

Construction Methods

Construct borrow pit dewatering basins according to the detail in the erosion control plans, and at locations shown on Reclamation Plans or in areas as directed.

The volume of the borrow pit dewatering basin will be based on a 2 hour retention time. The pump rate shall not exceed 1,000 GPM. The Contractor, at his option, may use a greater retention time for managing turbidity.

The straight line distance between the inlet and outlet shall be divided to include a forebay chamber in the upper quarter cell. Install one porous coir fiber baffle across the full width of the basin to delineate the forebay chamber. Do not use earthen or rock baffle. Install filtration geotextile on the interior side slopes and the floor of the forebay.

The water pumped from the borrow pit into the dewatering basin shall be obtained from the top of the water column and shall be discharged into the forebay in a non-erodible manner.

The borrow pit dewatering basin outlet shall be a vertical non-perforated riser pipe or flash board riser attached with a watertight connection to a barrel that carries the water through the embankment.

Maintenance and Removal

Maintain the borrow pit dewatering basin, coir fiber baffle, and remove and dispose of silt accumulations in accordance with Article 1630-3 of the *Standard Specifications*. The Contractor may include a drain device for maintenance and removal at his discretion.

Remove the borrow pit dewatering basin once dewatering operations are completed. Grade, seed, and mulch the area after removal of the borrow pit dewatering basin in accordance with Section 1660 of the *Standard Specifications*. The area shall be stabilized with an approved groundcover before final acceptance of the site.

Measurement and Payment

No direct payment will be made for borrow pit dewatering basins with the exception of the work of silt removal during dewatering basin operation and the work of seeding and mulching after removal of the dewatering basin. All other work and materials required for installation, maintenance and removal of borrow pit dewatering basins shall be incidental to *Borrow Excavation*. Such price and payments will be full compensation for the work of constructing, maintaining and removing the borrow pit dewatering basin including, but not limited to, the construction and removal of the borrow pit dewatering basin; furnishing of the outlet structure, baffle, filtration geotextile, stone and optional drain devices; and removal of all such items once dewatering operations are completed.

Removal and disposal of silt accumulations during dewatering operations will be measured and paid at the contract unit price per cubic yard for *Silt Excavation* in accordance with Article 1630-4 of the *Standard Specifications*.

Grading, seeding, and mulching the area after removal of the borrow pit dewatering basin will be measured and paid at the contract unit price per acre for *Seeding and Mulching* in accordance with Section 1660-8 of the *Standard Specifications*.

CULVERT DIVERSION CHANNEL:

Description

This work consists of providing a *Culvert Diversion Channel* to detour the existing stream around the culvert construction site at locations shown on the plans. Work includes constructing the diversion channel, disposing of excess materials, providing and placing geotextile liner, maintaining the diversion area in an acceptable condition, removing geotextile liner, backfilling diversion channel area with suitable material, and providing proper drainage when diversion channel area is abandoned.

Materials

Refer to Division 10

Item	Section
Geotextile for Soil Stabilization, Type 4	1056

Construction Methods

Grade channel according to the plans with channel surface free of obstructions, debris, and pockets of low-density material. Utilize suitable material and provide disposal area for unsuitable material.

Line channel with geotextile unrolled in the direction of flow and lay smoothly but loosely on soil surface without creases. Bury top of slope geotextile edge in a trench at least 5" deep and tamp securely. Make vertical overlaps a minimum of 18" with upstream geotextile overlapping the downstream geotextile.

Secure geotextile with eleven gauge wire staples shaped into a *u* shape with a length of not less than 6" and a throat not less than 1" in width. Place staples along outer edges and throughout the geotextile a maximum of 3 ft. horizontally and vertically.

Measurement and Payment

Culvert Diversion Channel will be measured and paid for as the actual number of cubic yards excavated, as calculated from the typical section throughout the length of the diversion channel as shown on the final approved plans.

Geotextile for Soil Stabilization will be measured and paid for in accordance with Article 270-4 of the *Standard Specifications*.

Such price and payment shall be considered full compensation for all work covered by this section including all materials, construction, maintenance, and removal of *Culvert Diversion Channel*.

Payment will be made under:

Pay Item	Pay Unit
Culvert Diversion Channel	Cubic Yard

IMPERVIOUS DIKE:**Description**

This work consists of furnishing, installing, maintaining, and removing an *Impervious Dike* for the purpose of diverting normal stream flow around the construction site. The Contractor shall construct an impervious dike in such a manner approved by the Engineer. The impervious dike shall not permit seepage of water into the construction site or contribute to siltation of the stream.

The impervious dike shall be constructed of an acceptable material in the locations noted on the plans or as directed.

Materials

Acceptable materials shall include but not be limited to sheet piles, sandbags, and/or the placement of an acceptable size stone lined with polypropylene or other impervious geotextile.

Earth material shall not be used to construct an impervious dike when it is in direct contact with the stream unless vegetation can be established before contact with the stream takes place.

Measurement and Payment

Impervious Dike will be measured and paid as the actual number of linear feet of impervious dike(s) constructed, measured in place from end to end of each separate installation that has been completed and accepted. Such price and payment will be full compensation for all work including but not limited to furnishing materials, construction, maintenance, and removal of the impervious dike.

Payment will be made under:

Pay Item	Pay Unit
Impervious Dike	Linear Foot

COIR FIBER MAT:

Description

Furnish material, install and maintain coir fiber mat in locations shown on the plans or in locations as directed. Work includes providing all materials, excavating and backfilling, and placing and securing coir fiber mat with stakes, steel reinforcement bars or staples as directed.

Materials

Item	Section
Coir Fiber Mat	1060-14

Anchors: Stakes, reinforcement bars, or staples shall be used as anchors.

Wooden Stakes:

Provide hardwood stakes 12"- 24" long with a 2" x 2" nominal square cross section. One end of the stake must be sharpened or beveled to facilitate driving through the coir fiber mat and down into the underlying soil. The other end of the stake needs to have a 1"- 2" long head at the top with a 1"- 2" notch following to catch and secure the coir fiber mat.

Steel Reinforcement Bars:

Provide uncoated #10 steel reinforcement bars 24" nominal length. The bars shall have a 4" diameter bend at one end with a 4" straight section at the tip to catch and secure the coir fiber mat.

Staples:

Provide staples made of 0.125" diameter new steel wire formed into a *u* shape not less than 12" in length with a throat of 1" in width.

Construction Methods

Place the coir fiber mat immediately upon final grading. Provide a smooth soil surface free from stones, clods, or debris that will prevent the contact of the mat with the soil. Unroll the mat and apply without stretching such that it will lie smoothly but loosely on the soil surface.

For stream relocation applications, take care to preserve the required line, grade, and cross section of the area covered. Bury the top slope end of each piece of mat in a narrow trench at least 6 in. deep and tamp firmly. Where one roll of matting ends and a second roll begins, overlap the end of the upper roll over the buried end of the second roll so there is a 6 in. overlap. Construct check trenches at least 12 in. deep every 50 ft. longitudinally along the edges of the mat or as directed. Fold over and bury mat to the full depth of the trench, close and tamp firmly. Overlap mat at least 6 in. where 2 or more widths of mat are installed side by side.

Place anchors across the mat at the ends approximately 1 ft. apart. Place anchors along the outer edges and down the center of the mat 3 ft. apart.

Adjustments in the trenching or anchoring requirements to fit individual site conditions may be required.

Measurement and Payment

Coir Fiber Mat will be measured and paid for as the actual number of square yards measured along the surface of the ground over which coir fiber mat is installed and accepted.

No measurement will be made for anchor items.

Payment will be made under:

Pay Item

Coir Fiber Mat

Pay Unit

Square Yard

CONCRETE WASHOUT STRUCTURE:

(12-10-20)

Description

Concrete washout structures are enclosures above or below grade to contain concrete waste water and associated concrete mix from washing out ready-mix trucks, drums, pumps, or other equipment. Concrete washouts must collect and retain all the concrete washout water and solids, so that this material does not migrate to surface waters or into the ground water. These enclosures are not intended for concrete waste not associated with wash out operations.

The concrete washout structure may include constructed devices above or below ground and or commercially available devices designed specifically to capture concrete wash water.

Materials

Item	Section
Temporary Silt Fence	1605

Safety Fence shall meet the specifications as provided elsewhere in this contract.

Geomembrane basin liner shall meet the following minimum physical properties for low permeability; it shall consist of a polypropylene or polyethylene 10 mil thick geomembrane. If the minimum setback dimensions can be achieved the liner is not required. (5 feet above groundwater, 50 feet from top of bank of perennial stream, other surface water body, or wetland.)

Construction Methods

Build an enclosed earthen berm or excavate to form an enclosure in accordance with the details and as directed.

Install temporary silt fence around the perimeter of the enclosure in accordance with the details and as directed if structure is not located in an area where existing erosion and sedimentation control devices are capable to containing any loss of sediment.

Post a sign with the words "Concrete Washout" in close proximity of the concrete washout area, so it is clearly visible to site personnel. Install safety fence as directed for visibility to construction traffic.

The construction details for the above grade and below grade concrete washout structures can be found on the following web page link:

<https://connect.ncdot.gov/resources/roadside/SoilWaterDocuments/ConcreteWashoutStructureDetail.pdf>

Alternate details for accommodating concrete washout may be submitted for review and approval.

The alternate details shall include the method used to retain and dispose of the concrete waste water within the project limits and in accordance with the minimum setback requirements. (5 feet above groundwater, 50 feet from top of bank of perennial stream, other surface water body, or wetland.)

Maintenance and Removal

Maintain the concrete washout structure(s) to provide adequate holding capacity plus a minimum freeboard of 12 inches. Remove and dispose of hardened concrete and return the structure to a functional condition after reaching 75% capacity.

Inspect concrete washout structures for damage and maintain for effectiveness.

Remove the concrete washout structures and sign upon project completion. Grade the earth material to match the existing contours and permanently seed and mulch area.

Measurement and Payment

Concrete Washout Structure will be paid for per each enclosure installed in accordance with the details. If alternate details or commercially available devices are approved, then those devices will also be paid for per each approved and installed device.

Temporary Silt Fence will be measured and paid for in accordance with Article 1605-5 of the *Standard Specifications*.

Safety Fence shall be measured and paid for as provided elsewhere in this contract.

No measurement will be made for other items or for over excavation or stockpiling.

Payment will be made under:

Pay Item

Concrete Washout Structure

Pay Unit

Each

FABRIC INSERT INLET PROTECTION DEVICE (HIGH FLOW)**Description**

This work shall consist of installing, maintaining, and removing *Fabric Insert Inlet Protection Device*, of the type specified, in inlet structures (catch basins, drop inlets, etc) in areas where asphalt or concrete may prevent the proper installation of a Rock Inlet Sediment Traps Type C, or as directed.

Materials

The product shall be a fabric inlet protection device composed of a fitted woven polypropylene geotextile double sewn with nylon thread. The *Fabric Insert Inlet Protection Device* shall be manufactured to fit the opening of the catch basin or drop inlet and will have two dump straps attached at the bottom to facilitate the emptying of the device and shall have lifting loops for lifting the device from the basin. The *Fabric Insert Inlet Protection Device* shall have a restraint cord approximately halfway up the bag to keep the sides away from the catch basin walls.

The stitching shall meet the following physical properties:

Physical	Test Method	English
Average Wide Width Strength	ASTM D-4884	165 lb/in

The fitted filter assembly shall have the following physical properties:

Physical	Test Method	English
Grab Tensile	ASTM D-4632	255 x 275 lbs
Minimum Puncture Strength	ASTM D-4833	125 lbs
Mullen Burst	ASTM D-3786	420 PSI
Minimum UV Resistance	ASTM D-4355	70 %.
Flow Rate	ASTM D-4491	200 gal/min/ft ²
Apparent Opening	ASTM D-4751	20 US Sieve
Permittivity	ASTM D-4491	1.5 sec ⁻¹

Construction Methods

Strictly comply with manufacturer's installation instructions and recommendations. Maintenance shall include regular daily inspections and after each qualifying rain event. The *Fabric Insert Inlet Protection Device* shall be emptied, cleaned and placed back into the basin when it reaches 50% capacity or as directed.

Measurement and Payment

This work will be paid for at the contract unit price per *Fabric Insert Inlet Protection Device* of the type specified, complete in place and accepted. Such payment shall be full compensation for furnishing and installing the *Fabric Insert Inlet Protection Device* in accordance with this specification and for all required maintenance.

Maintenance of the device, cleanout and disposal of accumulated sediments shall be paid for by *Fabric Insert Inlet Protection Device Cleanout*.

Payment will be made under:

Pay Item	Pay Unit
Fabric Insert Inlet Protection Device	Each
Fabric Insert Inlet Protection Device Cleanout	Each

10/28/2021

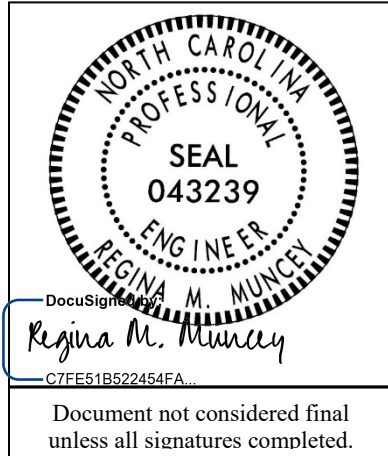

**Signals and Intelligent Transportation Systems
Project Special Provisions
(Version 18.2)**

Prepared By: RMM
28-Oct-21

Contents

1. 2018 STANDARD SPECIFICATIONS FOR ROADS & STRUCTURES.....4

1.1. GENERAL REQUIREMENTS – CONSTRUCTION METHODS (1700-3(K))4

1.2. WOOD POLES – CONSTRUCTION METHODS (1720-3)4

1.3. REQUIREMENTS FOR CABLES CROSSING RAILROADS.....4

1.4. MEASUREMENT AND PAYMENT7

2. SIGNAL HEADS.....7

2.1. MATERIALS7

A. General:.....7

B. Vehicle Signal Heads:.....9

C. Pedestrian Signal Heads:11

D. Signal Cable:13

3. CONTROLLERS WITH CABINETS14

3.1. MATERIALS – GENERAL CABINETS14

3.2. MATERIALS – TYPE 170E CABINETS15

A. Type 170 E Cabinets General:.....15

B. Type 170 E Cabinet Electrical Requirements:.....15

C. Type 170 E Cabinet Physical Requirements:.....23

D. Model 2018 Enhanced Conflict Monitor:25

E. Preemption and Sign Control Box35

3.3. MATERIALS – TYPE 2070LX CONTROLLERS38

4. VIDEO IMAGING LOOP EMULATOR DETECTOR SYSTEMS38

4.1. DESCRIPTION38

4.2. MATERIALS38

A. General:.....38

B. Loop Emulator System:.....40

C. Video Imaging Loop Emulator System Support:.....41

4.3. CONSTRUCTION METHODS42

4.4. MEASUREMENT AND PAYMENT42

5. TRAFFIC SIGNAL SUPPORTS.....43

5.1. METAL TRAFFIC SIGNAL SUPPORTS – ALL POLES43

A. General:.....43

B. Materials:45

C. Construction Methods:46

5.2. METAL POLE UPRIGHTS (VERTICAL MEMBERS)47

A. Materials:47

B. Construction Methods:48

- 5.3. DRILLED PIER FOUNDATIONS FOR METAL TRAFFIC SIGNAL POLES 48
 - A. Description: 49
 - B. Soil Test and Foundation Determination: 49
 - C. Drilled Pier Construction: 52
- 5.4. METAL SIGNAL POLE REMOVALS 52
 - A. Description: 52
 - B. Construction Methods: 52
- 5.5. POLE NUMBERING SYSTEM 52
 - A. New Poles 52
- 5.6. MEASUREMENT AND PAYMENT 52
- 6. ETHERNET EDGE SWITCH 53**
 - 6.1. DESCRIPTION 53
 - A. Ethernet Edge Switch: 53
 - B. Network Management: 53
 - 6.2. MATERIALS 53
 - A. General: 53
 - B. Compatibility Acceptance 53
 - C. Standards: 54
 - D. Functional: 54
 - E. Physical Features: 55
 - F. Management Capabilities: 56
 - G. Electrical Specifications: 57
 - H. Environmental Specifications: 57
 - I. Ethernet Patch Cable: 58
 - 6.3. CONSTRUCTION METHODS 58
 - A. General: 58
 - B. Edge Switch: 59
 - 6.4. MEASUREMENT AND PAYMENT 59
- 7. DMS ELECTRICAL SERVICE 59**
 - 7.1. DESCRIPTION 59
 - 7.2. MATERIALS 59
 - A. Electrical Service 59
 - B. Supplemental Equipment Cabinet Disconnect 60
 - C. Grounding Electrodes (Ground Rods) 61
 - 7.3. CONSTRUCTION METHODS 61
 - A. General 61
 - B. New Electrical Service for DMS 62
 - C. Grounding of Electrical Services 62
 - 7.4. MEASUREMENT AND PAYMENT 62
- 8. DIGITAL CCTV FIELD EQUIPMENT 63**
 - 8.1. DESCRIPTION 63
 - 8.2. MATERIAL 63
 - A. General 63
 - B. Camera and Lens 64
 - C. Camera Housing 65
 - D. Pan and Tilt Unit 65
 - E. Video Ethernet Encoder 65
 - F. Ethernet Cable 66
 - G. Control Receiver/Driver 66
 - H. CCTV Camera Attachment to Pole 66
 - I. Surge Suppression 67
 - 8.3. CONSTRUCTION METHOD 67
 - A. General 67
 - B. Electrical and Mechanical Requirements 67

8.4. MEASUREMENT AND PAYMENT 67

9. DYNAMIC MESSAGE SIGN (DMS) 68

9.1. DESCRIPTION 68

9.2. MATERIALS 68

 C. Environmental Requirements 68

 D. Full Matrix Led Dynamic Message Sign (DMS) 69

 E. DMS Enclosure Structure Mounting 74

 F. DMS / DMS Controller Interconnect 75

 G. DMS Controller and Cabinet 75

 H. Photo-Electric Sensors 82

 I. Equipment List 82

 J. Physical Description 83

 K. Parts List 83

 L. Character Set Submittal 83

 M. Wiring Diagrams 83

 N. Routine Of Operation 83

 O. Maintenance Procedures 83

 P. Repair Procedures 84

 Q. Field Trial 84

9.3. CONSTRUCTION METHODS 84

 R. Description 84

 S. Layout 84

 T. Construction Submittal 85

 U. Conduit 85

 V. Wiring Methods 85

 W. Equipment and Cabinet Mounting 85

 X. Work Site Clean-Up 86

9.4. MEASUREMENT AND PAYMENT 86

10. NTCIP Requirements 86

10.1. REFERENCES 86

 A. General Requirements 88

 B. NTCIP Acceptance Testing 95

10.2. MEASUREMENT AND PAYMENT 96

11. DMS ASSEMBLIES 96

11.1. DESCRIPTION 96

11.2. MATERIAL 96

11.3. CONSTRUCTION METHODS 97

 A. General 97

 B. Shop Drawing 97

 C. Design and Fabrication 98

11.4. MEASUREMENT AND PAYMENT 100

12. SOIL TEST FOR DMS FOUNDATION 100

12.1. DESCRIPTION 100

12.2. SOIL TEST 101

 A. General 101

 B. Soil Test 101

12.3. MEASUREMENT AND PAYMENT 102

13. DYNAMIC MESSAGE SIGN FOUNDATIONS 102

13.1. DESCRIPTION 102

13.2. MATERIALS 102

 A. Assumed Subsurface Conditions 102

 B. Subsurface Investigations 102

 C. Sign Foundation Designs 103

13.3. CONSTRUCTION METHODS103
 13.4. MEASUREMENT AND PAYMENT103
14. BACK PULL FIBER OPTIC CABLE104
 14.1. DESCRIPTION104
 14.1. CONSTRUCTION104
 14.2. MEASUREMENT AND PAYMENT104

1. 2018 STANDARD SPECIFICATIONS FOR ROADS & STRUCTURES

The 2018 Standard Specifications are revised as follows:

1.1. GENERAL REQUIREMENTS – Construction Methods (1700-3(K))

Page 17-4, revise sentence starting on line 14 to read “Modify existing electrical services, as necessary, to meet the grounding requirements of the NEC, these *Standard Specifications*, *Standard Drawings*, and the project plans.”

Page 17-4, revise sentence beginning on line 21 to read “Furnish and install additional ground rods to grounding electrode system as necessary to meet the *Standard Specifications*, *Standard Drawings*, and test requirements.”

1.2. WOOD POLES – Construction Methods (1720-3)

Page 17-18, revise sentence starting on line 13 to read “On new Department-owned poles, install a grounding system consisting of #6 AWG solid bare copper wire that is mechanically crimped using an irreversible compression tool with die to a single ground rod installed at base of pole or to the electrical service grounding electrode system located within 10 feet of the pole.”

1.3. REQUIREMENTS FOR CABLES CROSSING RAILROADS

Copies of all executed railroad agreements and related correspondence may be obtained from the Engineer upon request.

1. Railroad Crossings

Application has been made with Aberdeen & Rockfish herein called the Railroad Company, for the encroachment agreements necessary under this Contract. Do not commence cable routing work over or under railroad-owned facilities until notification and coordination with Engineer and the appropriate Railroad Company has occurred. Install fiber-optic communications cable as shown on the Plans. All work associated with the crossing is to conform to the Railroad Company’s specifications.

For work within Aberdeen & Rockfish’s rights of way, comply with the latest approved edition of Railroad Specification CE-4, “Specifications for Wire, Conduit and Cable Occupations of Railroad Property” and Railroad Specification CE-8 “Specifications for Pipeline Occupancy of Railroad Property.”

Cable crossings include the following location(s):

Plan Sheet	Location	Railroad Company
SCP-17	At-Grade Crossing across US 401 (Raeford Road) at Twin Acres Drive near Owen Drive/ Crossing AAR# 847-200B	Aberdeen & Rockfish

2. Insurance Requirements

The Department has provided Railroad Protective Liability Insurance to the railroad company as part of the Department's encroachment agreements with the railroad companies for each of location listed in the table above.

If required by the railroad, pay for railroad personnel to be present when work is performed.

In addition to any other forms of insurance or bonds required under the terms of the Contract and the *Standard Specifications*, take out and keep in force from the commencement of all construction on railroad right-of-way until the final inspection and acceptance of the project by the Engineer, insurance of the following kinds and amount. It is understood that the amounts specified are minimum amounts and that larger amounts may be carried if so desired. Any insurance taken out due to these requirements shall be subject to the approval of the Engineer, and the Railroad Company as to form and amount. Furnish satisfactory policies for approval prior to beginning of any work on railroad right-of-way.

Refer to the below verbiage for more specific insurance requirements and requirements for working on the rights-of-way of the railroad company. In the event of a conflict between the requirements of the railroad company and the requirements contained in the Plans or these Project Special Provisions, the requirements of the railroad company shall govern.

- (a) Statutory Workers' Compensation and Employer's Liability insurance.
- (b) An Occurrence Form Railroad Protective Policy with limits of not less than Two Million (\$2,000,000.00) Dollars per occurrence for Bodily Injury Liability, Property Damage Liability and Physical Damage to Property, with Six Million (\$6,000,000.00) Dollars aggregate for the term of the policy with respect to Bodily Injury, Liability, Property Damage Liability and Physical Damage to Property. The Policy must name

**ABERDEEN & ROCKFISH RAILROAD COMPANY
101 E. MAIN ST.
P.O. BOX 917
ABERDEEN, NC 28315**

as the insured, and shall provide for not less than ten (10) days' prior written notice to Railroad of cancellation of, or any material change, in the policy.

Keep such insurance in force until final inspection of the project, or that portion or portions within the railroad right-of-way, by the Engineer or, in the case of Subcontractors, until the Contractor furnishes a letter to the Engineer stating that the Subcontractor has completed his/her subcontracted work within the railroad right-of-way to Contractor's satisfaction, and that the Contractor will accomplish any additional work necessary on the railroad right-of-way with the Contractor's own forces.

Termination of Insurance and Policies to be Submitted

Any insurance policies given hereunder shall cover all Contractor-performed work within railroad right-of-way, but shall not be liable for accidents occurring after acceptance of the completed project by the Department. Such policies shall contain a clause requiring 30 days written notice be given to the Engineer and to the appropriate Railroad Company, prior to cancellation or change.

Submit to the Engineer the original and one copy of the Commercial General Liability Policy, one certified duplicate copy of all other policies, and certificates of insurance in an original and two copies as required by these Project Special Provisions.

No extra allowance will be made for the insurance required hereunder. The entire cost shall be included in the contract unit price bids for other pay items.

The named insured under the commercial General Liability Insurance Policy is the respective Railroad Company, and the designation of the job site description of work is as follows: All construction on the Aberdeen & Rockfish right-of-way on NCDOT Project No. U-4405 in the City of Fayetteville, Cumberland County, North Carolina.

3. Flagging Protection or Watchman Service

Provide a minimum of 7 days advance notice to Aberdeen & Rockfish in order that flagging service can be arranged and provided. Do not undertake any work within the Aberdeen & Rockfish right-of-way until the flagman is at the job site.

4. Delays Caused by Operations of Others

Neither the Department nor the Railroad Company assumes any responsibility for any work performed by others in connection with the construction of the project, and the Contractor shall have no claim whatsoever against the Department or the Railroad Company for any inconvenience, delay, or additional cost incurred by the Contractor on account of such operations by others.

5. Time Extensions

No time extensions related to railroad encroachments will be allowed until the related work becomes the controlling factor relative to overall project completion.

6. Cooperation with Others

Cooperate with others participating in the construction of the project to the end that all work may be carried on to the best advantage.

7. Authority of Railroad Engineer

The authorized representative of the Railroad Company, hereinafter referred to as the Railroad Engineer, will have the final authority in all matters affecting the safe maintenance of railroad traffic of his company.

8. Interference with Railroad Operations

Arrange and conduct work so that there will be no interference with railroad operations, including train, signal, telephone and telegraphic services, or damage to the property of the Railroad Company or to the poles, wire, and other facilities of tenants on the rights-of-way of the Railroad Company. Wherever work is liable to affect the operations or safety of trains, first submit the method of doing such work to the Railroad Engineer for approval. However, such approval will not relieve the Contractor from liability.

Should conditions arising from or in connection with the work, require that immediate and unusual provisions be made to protect train operations and property of the Railroad Company, it shall be a part of the required services by the Contractor to make such provisions and if, in the judgment of the Railroad Engineer such provisions are insufficient, the Railroad Engineer or the Department may, at the expense of the Contractor, require or provide such provisions as may be deemed necessary.

9. Storage of Materials

Do not store materials and equipment where they will interfere with railroad operations, nor on the rights-of-way of the Railroad Company without first having obtained permission from the Railroad Engineer. Such permission will be with the understanding that the Railroad Company will not be liable or damage to such material and equipment from any cause, and that the Railroad Engineer may move or require the Contractor to move, at the Contractor's expense, such material and equipment.

10. Completion and Acceptance of Work

Upon completion of the work, remove from within the limits of the railroad right-of-way all machinery, equipment, surplus materials, or rubbish and leave said rights-of-way in a neat and orderly condition. Acceptance of the work will be contingent upon final inspection by the Department and by the Railroad Company (if required by the Railroad Company) to determine if the work was completed satisfactorily in a manner acceptable to the Department and the Railroad Company.

1.4. MEASUREMENT AND PAYMENT

There will be no direct payment for work covered in this section. Include the costs for obtaining and furnishing Railroad insurance whose measurement and payment is not specifically stated under any of the contract pay items, into the unit cost(s) for the various contract pay items associated with performing this work.

2. SIGNAL HEADS

2.1. MATERIALS

A. General:

Fabricate vehicle signal head housings, 16-inch pedestrian signal head housings, and end caps from die-cast aluminum. Provide visor mounting screws, door latches, and hinge pins fabricated from stainless steel. Provide interior screws, fasteners, and metal parts fabricated from stainless steel.

Fabricate tunnel and traditional visors from sheet aluminum.

Paint all surfaces inside and outside of signal housings and doors. Paint outside surfaces of tunnel and traditional visors, wire outlet bodies, wire entrance fitting brackets and end caps when supplied as components of messenger cable mounting assemblies, pole and pedestal mounting assemblies, and pedestrian pushbutton housings. Have electrostatically-applied, fused-polyester paint in highway yellow (Federal Standard 595C, Color Chip Number 13538) a minimum of 2.5 to 3.5 mils thick. Do not apply paint to the latching hardware, rigid vehicle signal head mounting brackets for mast-arm attachments, messenger cable hanger components or balance adjuster components.

Have the interior surfaces of tunnel and traditional visors painted an alkyd urea black synthetic baking enamel with a minimum gloss reflectance and meeting the requirements of MIL-E-10169, "Enamel Heat Resisting, Instrument Black."

Where required, provide polycarbonate signal heads and visors that comply with the provisions pertaining to the aluminum signal heads listed on the QPL with the following exceptions:

Fabricate signal head housings, end caps, and visors from virgin polycarbonate material. Provide UV stabilized polycarbonate plastic with a minimum thickness of 0.1 ± 0.01 inches that is highway yellow (Federal Standard 595C, Color Chip 13538). Ensure the color is incorporated into the plastic material before molding the signal head housings and end caps. Ensure the plastic formulation provides the following physical properties in the assembly (tests may be performed on separately molded specimens):

Test	Required	Method
Specific Gravity	1.17 minimum	ASTM D 792
Flammability	Self-extinguishing	ASTM D 635
Tensile Strength, yield, PSI	8500 minimum	ASTM D 638
Izod impact strength, ft-lb/in [notched, 1/8 inch]	12 minimum	ASTM D 256

For pedestal mounting, provide a post-top slipfitter mounting assembly that matches the positive locking device on the signal head with serrations integrally cast into the slipfitter. Provide stainless steel hardware, screws, washers, etc. Provide a minimum of six 3/8 X 3/4-inch long square head bolts for attachment to pedestal. Provide a center post for multi-way slipfitters.

For light emitting diode (LED) traffic signal modules, provide the following requirements for inclusion on the Department's Qualified Products List for traffic signal equipment.

1. Sample submittal,
2. Third-party independent laboratory testing results for each submitted module with evidence of testing and conformance with all of the Design Qualification Testing specified in section 6.4 of each of the following Institute of Transportation Engineers (ITE) specifications:
 - Vehicle Traffic Control Signal Heads – Light Emitting Diode (LED) Circular Signal Supplement
 - Vehicle Traffic Control Signal Heads – Light Emitting Diode (LED) Vehicle Arrow Traffic Signal Supplement
 - Pedestrian Traffic Control Signal Indications –Light Emitting Diode (LED) Signal Modules.

(Note: The Department currently recognizes two approved independent testing laboratories. They are Intertek ETL Semko and Light Metrics, Incorporated with Garwood Laboratories. Independent laboratory tests from other laboratories may be considered as part of the QPL submittal at the discretion of the Department,

3. Evidence of conformance with the requirements of these specifications,
4. A manufacturer's warranty statement in accordance with the required warranty, and

5. Submittal of manufacturer's design and production documentation for the model, including but not limited to, electrical schematics, electronic component values, proprietary part numbers, bill of materials, and production electrical and photometric test parameters.
6. Evidence of approval of the product to bear the Intertek ETL Verified product label for LED traffic signal modules.

In addition to meeting the performance requirements for the minimum period of 60 months, provide a written warranty against defects in materials and workmanship for the modules for a period of 60 months after installation of the modules. During the warranty period, the manufacturer must provide new replacement modules within 45 days of receipt of modules that have failed at no cost to the State. Repaired or refurbished modules may not be used to fulfill the manufacturer's warranty obligations. Provide manufacturer's warranty documentation to the Department during evaluation of product for inclusion on Qualified Products List (QPL).

B. Vehicle Signal Heads:

Comply with the ITE standard "Vehicle Traffic Control Signal Heads". Provide housings with provisions for attaching backplates.

Provide visors that are 8 inches in length for 8-inch vehicle signal head sections. Provide visors that are 10 inches in length for 12-inch vehicle signal heads.

Provide a termination block with one empty terminal for field wiring for each indication plus one empty terminal for the neutral conductor. Have all signal sections wired to the termination block. Provide barriers between the terminals that have terminal screws with a minimum Number 8 thread size and that will accommodate, and secure spade lugs sized for a Number 10 terminal screw.

Mount termination blocks in the yellow signal head sections on all in-line vehicle signal heads. Mount the termination block in the red section on five-section vehicle signal heads.

Furnish vehicle signal head interconnecting brackets. Provide one-piece aluminum brackets less than 4.5 inches in height and with no threaded pipe connections. Provide hand holes on the bottom of the brackets to aid in installing wires to the signal heads. Lower brackets that carry no wires and are used only for connecting the bottom signal sections together may be flat in construction.

For messenger cable mounting, provide messenger cable hangers, wire outlet bodies, balance adjusters, bottom caps, wire entrance fitting brackets, and all other hardware necessary to make complete, watertight connections of the vehicle signal heads to the messenger cable. Fabricate messenger cable hanger components, wire outlet bodies and balance adjuster components from stainless steel or malleable iron galvanized in accordance with ASTM A153 (Class A) or ASTM A123. Provide serrated rings made of aluminum. Provide messenger cable hangers with U-bolt clamps. Fabricate washers, screws, hex-head bolts and associated nuts, clevis pins, cotter pins, U-bolt clamps and nuts from stainless steel.

Provide LED vehicular traffic signal modules (hereafter referred to as modules) that consist of an assembly that uses LEDs as the light source in lieu of an incandescent lamp for use in traffic signal sections. Use LEDs that are aluminum indium gallium phosphorus (AlInGaP) technology for red and yellow indications and indium gallium nitride (InGaN) for green indications. Install the ultra-bright type LEDs that are rated for 100,000 hours of continuous operation from -40°F to +165°F. Design modules to have a minimum useful life of 60 months and to meet all parameters of this specification during this period of useful life.

For the modules, provide spade terminals crimped to the lead wires and sized for a #10 screw connection to the existing terminal block in a standard signal head. Do not provide other types of crimped terminals with a spade adapter.

Ensure the power supply is integral to the module assembly. On the back of the module, permanently mark the date of manufacture (month & year) or some other method of identifying date of manufacture.

Tint the red, yellow, and green lenses to correspond with the wavelength (chromaticity) of the LED. Transparent tinting films are unacceptable. Provide a lens that is integral to the unit with a smooth outer surface.

1. LED Circular Signal Modules:

Provide modules in the following configurations: 12-inch circular sections, and 8-inch circular sections. All makes, and models of LED modules purchased for use on the State Highway System shall appear on the current NCDOT Traffic Signal Qualified Products List (QPL).

Provide the manufacturer's model number and the product number (assigned by the Department) for each module that appears on the 2018 or most recent Qualified Products List. In addition, provide manufacturer's certification in accordance with Article 106-3 of the *Standard Specifications*, that each module meets or exceeds the ITE "Vehicle Traffic Control Signal Heads – Light Emitting Diode (LED) Circular Signal Supplement" dated June 27, 2005 (hereafter referred to as VTCSH Circular Supplement) and other requirements stated in this specification.

Provide modules that meet the following requirements when tested under the procedures outlined in the VTCSH Circular Supplement:

Module Type	Max. Wattage at 165° F	Nominal Wattage at 77° F
12-inch red circular	17	11
8-inch red circular	13	8
12-inch green circular	15	15
8-inch green circular	12	12

For yellow circular signal modules, provide modules tested under the procedures outlined in the VTCSH Circular Supplement to insure power required at 77° F is 22 Watts or less for the 12-inch circular module.

Note: Use a wattmeter having an accuracy of $\pm 1\%$ to measure the nominal wattage and maximum wattage of a circular traffic signal module. Power may also be derived from voltage, current and power factor measurements.

2. LED Arrow Signal Modules

Provide 12-inch omnidirectional arrow signal modules. All makes, and models of LED modules purchased for use on the State Highway System shall appear on the current NCDOT Traffic Signal Qualified Products List (QPL).

Provide the manufacturer's model number and the product number (assigned by the Department) for each module that appears on the 2018 or most recent Qualified Products List. In addition, provide manufacturer's certification in accordance with Article 106-3 of the *Standard Specifications*, that each module meets or exceeds the requirements for 12-inch omnidirectional modules specified in the

ITE “Vehicle Traffic Control Signal Heads – Light Emitting Diode (LED) Vehicle Arrow Traffic Signal Supplement” dated July 1, 2007 (hereafter referred to as VTCSH Arrow Supplement) and other requirements stated in this specification.

Provide modules that meet the following requirements when tested under the procedures outlined in the VTCSH Arrow Supplement:

Module Type	Max. Wattage at 165° F	Nominal Wattage at 77° F
12-inch red arrow	12	9
12-inch green arrow	11	11

For yellow arrow signal modules, provide modules tested under the procedures outlined in the VTCSH Arrow Supplement to insure power required at 77° F is 12 Watts or less.

Note: Use a wattmeter having an accuracy of $\pm 1\%$ to measure the nominal wattage and maximum wattage of an arrow traffic signal module. Power may also be derived from voltage, current and power factor measurements.

3. LED U-Turn Arrow Signal Modules:

Provide modules in the following configurations: 12-inch left u-turn arrow signal modules and 12-inch right u-turn arrow signal modules.

Modules are not required to be listed on the ITS and Signals Qualified Products List. Provide manufacturer’s certification in accordance with Article 106-3 of the *Standard Specifications*, that each module meets or exceeds the ITE “Vehicle Traffic Control Signal Heads – Light Emitting Diode (LED) Circular Signal Supplement” dated June 27, 2005 (hereafter referred to as VTCSH Circular Supplement) and other requirements stated in this specification.

Provide modules that have minimum maintained luminous intensity values that are not less than 16% of the values calculated using the method described in section 4.1 of the VTCSH Circular Supplement.

Provide modules that meet the following requirements when tested under the procedures outlined in the VTCSH Circular Supplement:

Module Type	Max. Wattage at 165° F	Nominal Wattage at 77° F
12-inch red u-turn arrow	17	11
12-inch green u-turn arrow	15	15

For yellow u-turn arrow signal modules, provide modules tested under the procedures outlined in the VTCSH Circular Supplement to ensure power required at 77° F is 22 Watts or less.

Note: Use a wattmeter having an accuracy of $\pm 1\%$ to measure the nominal wattage and maximum wattage of a circular traffic signal module. Power may also be derived from voltage, current and power factor measurements.

C. Pedestrian Signal Heads:

Provide pedestrian signal heads with international symbols that meet the MUTCD. Do not provide letter indications.

Comply with the ITE standard for “Pedestrian Traffic Control Signal Indications” and the following sections of the ITE standard for “Vehicle Traffic Control Signal Heads” in effect on the date of advertisement:

- Section 3.00 - “Physical and Mechanical Requirements”
- Section 4.01 - “Housing, Door, and Visor: General”
- Section 4.04 - “Housing, Door, and Visor: Materials and Fabrication”
- Section 7.00 - “Exterior Finish”

Provide a double-row termination block with three empty terminals and number 10 screws for field wiring. Provide barriers between the terminals that accommodate a spade lug sized for number 10 terminal screws. Mount the termination block in the hand section. Wire all signal sections to the terminal block.

Where required by the plans, provide 16-inch pedestrian signal heads with traditional three-sided, rectangular visors, 6 inches long. Where required by the plans, provide 12-inch pedestrian signal heads with traditional three-sided, rectangular visors, 8 inches long.

Provide 2-inch diameter pedestrian push-buttons with weather-tight housings fabricated from die-cast aluminum and threading in compliance with the NEC for rigid metal conduit. Provide a weep hole in the housing bottom and ensure that the unit is vandal resistant.

Provide push-button housings that are suitable for mounting on flat or curved surfaces and that will accept 1/2-inch conduit installed in the top. Provide units that have a heavy duty push-button assembly with a sturdy, momentary, normally-open switch. Have contacts that are electrically insulated from the housing and push-button. Ensure that the push-buttons are rated for a minimum of 5 mA at 24 volts DC and 250 mA at 12 volts AC.

Provide standard R10-3 signs with mounting hardware that comply with the MUTCD in effect on the date of advertisement. Provide R10-3E signs for countdown pedestrian heads and R10-3B for non-countdown pedestrian heads.

Design the LED pedestrian traffic signal modules (hereafter referred to as modules) for installation into standard pedestrian traffic signal sections that do not contain the incandescent signal section reflector, lens, eggcrate visor, gasket, or socket. Provide modules that consist of an assembly that uses LEDs as the light source in lieu of an incandescent lamp. Use LEDs that are of the latest aluminum indium gallium phosphorus (AlInGaP) technology for the Portland Orange hand and countdown displays. Use LEDs that are of the latest indium gallium nitride (InGaN) technology for the Lunar White walking man displays. Install the ultra-bright type LEDs that are rated for 100,000 hours of continuous operation from -40°F to +165°F. Design modules to have a minimum useful life of 60 months and to meet all parameters of this specification during this period of useful life.

Design all modules to operate using a standard 3 - wire field installation. Provide spade terminals crimped to the lead wires and sized for a #10 screw connection to the existing terminal block in a standard pedestrian signal housing. Do not provide other types of crimped terminals with a spade adapter.

Ensure the power supply is integral to the module assembly. On the back of the module, permanently mark the date of manufacture (month & year) or some other method of identifying date of manufacture.

Provide modules in the following configuration: 16-inch displays which have the solid hand/walking man overlay on the left and the countdown on the right, and 12-inch displays which have the solid hand/walking man module as an overlay. All makes, and models of LED modules purchased for use on the State Highway System shall appear on the current NCDOT Traffic Signal Qualified Products List (QPL).

Provide the manufacturer's model number and the product number (assigned by the Department) for each module that appears on the 2018 or most recent Qualified Products List. In addition, provide manufacturer's certification in accordance with Article 106-3 of the *Standard Specifications*, that each module meets or exceeds the ITE "Pedestrian Traffic Control Signal Indicators - Light Emitting Diode (LED) Signal Modules" dated August 04, 2010 (hereafter referred to as PTCSI Pedestrian Standard) and other requirements stated in this specification.

Provide modules that meet the following requirements when tested under the procedures outlined in the PTCSI Pedestrian Standard:

Module Type	Max. Wattage at 165° F	Nominal Wattage at 77° F
Hand Indication	16	13
Walking Man Indication	12	9
Countdown Indication	16	13

Note: Use a wattmeter having an accuracy of $\pm 1\%$ to measure the nominal wattage and maximum wattage of a circular traffic signal module. Power may also be derived from voltage, current and power factor measurements.

Provide module lens that is hard coated or otherwise made to comply with the material exposure and weathering effects requirements of the Society of Automotive Engineers (SAE) J576. Ensure all exposed components of the module are suitable for prolonged exposure to the environment, without appreciable degradation that would interfere with function or appearance.

Ensure the countdown display continuously monitors the traffic controller to automatically learn the pedestrian phase time and update for subsequent changes to the pedestrian phase time.

Ensure the countdown display begins normal operation upon the completion of the preemption sequence and no more than one pedestrian clearance cycle.

D. Signal Cable:

Furnish 16-4 and 16-7 signal cable that complies with IMSA specification 20-1 except provide the following conductor insulation colors:

- For 16-4 cable: white, yellow, red, and green
- For 16-7 cable: white, yellow, red, green, yellow with black stripe tracer, red with black stripe tracer, and green with black stripe tracer. Apply continuous stripe tracer on conductor insulation with a longitudinal or spiral pattern.

Provide a ripcord to allow the cable jacket to be opened without using a cutter. IMSA specification 19-1 will not be acceptable. Provide a cable jacket labeled with the IMSA specification number and provide conductors constructed of stranded copper.

3. CONTROLLERS WITH CABINETS

3.1. MATERIALS – GENERAL CABINETS

Install an Ethernet edge switch in all new cabinets and furnish an Ethernet edge switch for each spare cabinet. See Section 9 - ETHERNET EDGE SWITCH.

Provide a moisture resistant coating on all circuit boards.

Provide one 20 mm diameter radial lead UL-recognized metal oxide varistor (MOV) between each load switch field terminal and equipment ground. Electrical performance is outlined below.

PROPERTIES OF MOV SURGE PROTECTOR	
Maximum Continuous Applied Voltage at 185° F	150 VAC (RMS) 200 VDC
Maximum Peak 8x20µs Current at 185° F	6500 A
Maximum Energy Rating at 185° F	80 J
Voltage Range 1 mA DC Test at 77° F	212-268 V
Max. Clamping Voltage 8x20µs, 100A at 77° F	395 V
Typical Capacitance (1 MHz) at 77° F	1600 pF

Provide a power line surge protector that is a two-stage device that will allow connection of the radio frequency interference filter between the stages of the device. Ensure that a maximum continuous current is at least 10A at 120V. Ensure that the device can withstand a minimum of 20 peak surge current occurrences at 20,000A for an 8x20 microsecond waveform. Provide a maximum clamp voltage of 395V at 20,000A with a nominal series inductance of 200µh. Ensure that the voltage does not exceed 395V. Provide devices that comply with the following:

Frequency (Hz)	Minimum Insertion Loss (dB)
60	0
10,000	30
50,000	55
100,000	50
500,000	50
2,000,000	60
5,000,000	40
10,000,000	20
20,000,000	25

3.2. MATERIALS – TYPE 170E CABINETS

A. Type 170 E Cabinets General:

Conform to the city of Los Angeles' Specification No. 54-053-08, *Traffic Signal Cabinet Assembly Specification* (dated July 2008), except as required herein.

Furnish model 336S pole mounted cabinets configured for 8 vehicle phases, 4 pedestrian phases, and 6 overlaps. Do not reassign load switches to accommodate overlaps unless shown on electrical details. Provide 336S pole mounted cabinets that are 46" high with 40" high internal rack assemblies.

Furnish model 332 base mounted cabinets configured for 8 vehicle phases, 4 pedestrian phases, and 6 overlaps. When overlaps are required, provide auxiliary output files for the overlaps. Do not reassign load switches to accommodate overlaps unless shown on electrical details.

Provide model 200 load switches, model 222 loop detector sensors, model 252 AC isolators, and model 242 DC isolators according to the electrical details. As a minimum, provide one (1) model 2018 conflict monitor, one (1) model 206L power supply unit, two (2) model 204 flashers, one (1) DC isolator (located in slot I14), and four (4) model 430 flash transfer relays (provide seven (7) model 430 flash transfer relays if auxiliary output file is installed) with each cabinet.

B. Type 170 E Cabinet Electrical Requirements:

Provide a cabinet assembly designed to ensure that upon leaving any cabinet switch or conflict monitor initiated flashing operation, the controller starts up in the programmed start up phases and start up interval.

Furnish two sets of non-fading cabinet wiring diagrams and schematics in a paper envelope or container and placed in the cabinet drawer.

All AC+ power is subject to radio frequency signal suppression.

Provide surge suppression in the cabinet for each type of cabinet device. Provide surge protection for the full capacity of the cabinet input file. Provide surge suppression devices that

operate properly over a temperature range of -40° F to +185° F. Ensure the surge suppression devices provide both common and differential modes of protection.

Provide a pluggable power line surge protector that is installed on the back of the PDA (power distribution assembly) chassis to filter and absorb power line noise and switching transients. Ensure the device incorporates LEDs for failure indication and provides a dry relay contact closure for the purpose of remote sensing. Ensure the device meets the following specifications:

- Peak Surge Current (Single pulse, 8x20µs).....20,000A
- Occurrences (8x20µs waveform).....10 minimum @ 20,000A
- Maximum Clamp Voltage.....395VAC
- Operating Current.....15 amps
- Response Time.....< 5 nanoseconds

Provide a loop surge suppressor for each set of loop terminals in the cabinet. Ensure the device meets the following specifications:

- Peak Surge Current (6 times, 8x20µs)
 - (Differential Mode).....400A
 - (Common Mode).....1,000A
- Occurrences (8x20µs waveform).....500 min @ 200A
- Maximum Clamp Voltage
 - (Differential Mode @400A).....35V
 - (Common Mode @1,000A).....35V
- Response Time.....< 5 nanoseconds
- Maximum Capacitance.....35 pF

Provide a data communications surge suppressor for each communications line entering or leaving the cabinet. Ensure the device meets the following specifications:

- Peak Surge Current (Single pulse, 8x20µs).....10,000A
- Occurrences (8x20µs waveform).....100 min @ 2,000A
- Maximum Clamp Voltage.....Rated for equipment protected
- Response Time.....< 1 nanosecond
- Maximum Capacitance.....1,500 pF
- Maximum Series Resistance.....15Ω

Provide a DC signal surge suppressor for each DC input channel in the cabinet. Ensure the device meets the following specifications:

Peak Surge Current (Single pulse, 8x20 μ s).....10,000A
 Occurrences (8x20 μ s waveform).....100 @ 2,000A
 Maximum Clamp Voltage.....30V
 Response Time.....< 1 nanosecond

Provide a 120 VAC signal surge suppressor for each AC+ interconnect signal input. Ensure the device meets the following specifications:

Peak Surge Current (Single pulse, 8x20 μ s).....20,000A
 Maximum Clamp Voltage.....350VAC
 Response Time.....< 200 nanoseconds
 Discharge Voltage.....<200 Volts @ 1,000A
 Insulation Resistance..... \geq 100 M Ω

Provide conductors for surge protection wiring that are of sufficient size (ampacity) to withstand maximum overcurrents which could occur before protective device thresholds are attained and current flow is interrupted.

If additional surge protected power outlets are needed to accommodate fiber transceivers, modems, etc., install a UL listed, industrial, heavy-duty type power outlet strip with a minimum rating of 15 A / 125 VAC, 60 Hz. Provide a strip that has a minimum of 3 grounded outlets. Ensure the power outlet strip plugs into one of the controller unit receptacles located on the rear of the PDA. Ensure power outlet strip is mounted securely; provide strain relief if necessary.

Provide a door switch in the front and a door switch in the rear of the cabinet that will provide the controller unit with a Door Ajar alarm when either the front or the rear door is open. Ensure the door switches apply DC ground to the Input File when either the front door or the rear door is open.

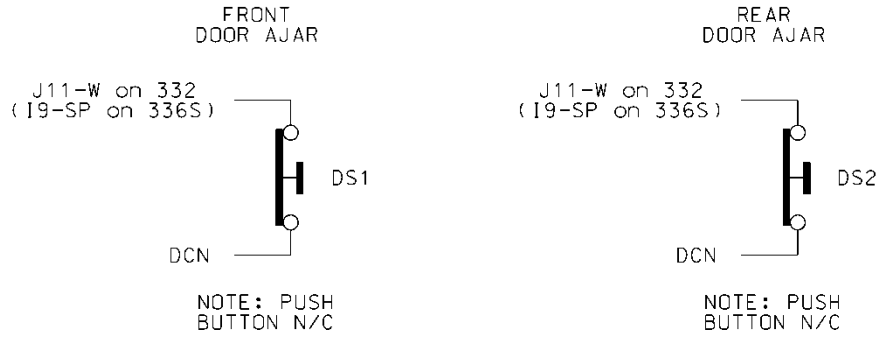

Furnish a fluorescent fixture in the rear across the top of the cabinet and another fluorescent fixture in the front across the top of the cabinet at a minimum. Ensure that the fixtures provide sufficient light to illuminate all terminals, labels, switches, and devices in the cabinet. Conveniently locate the fixtures so as not to interfere with a technician’s ability to perform work on any devices or terminals in the cabinet. Provide a protective diffuser to cover exposed bulbs. Install 16-watt T-4 lamps in the fluorescent fixtures. Provide a door switch to provide power to each fixture when the respective door is open. Wire the fluorescent fixtures to the 15-amp ECB (equipment circuit breaker).

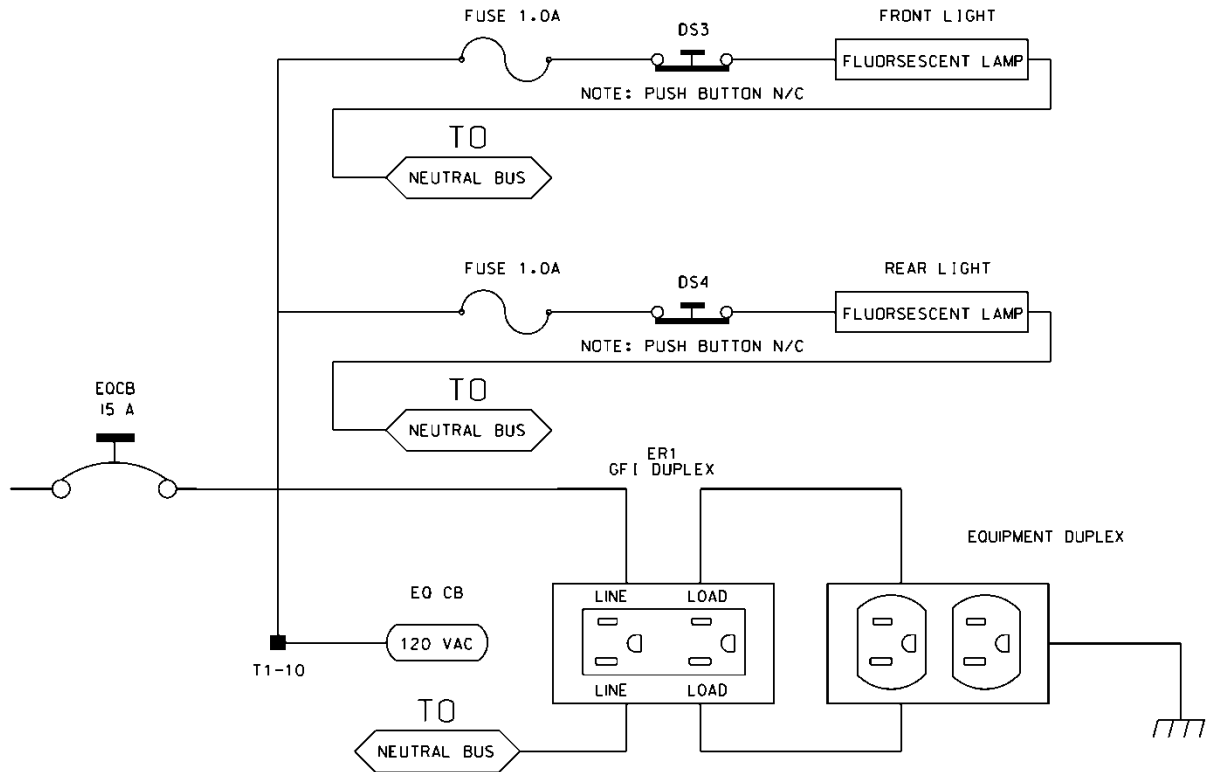

Furnish a police panel with a police panel door. For model 336S cabinets, mount the police panel on the rear door. Ensure that the police panel door permits access to the police panel when the main door is closed. Ensure that no rainwater can enter the cabinet even with the police panel door open. Provide a police panel door hinged on the right side as viewed from the front. Provide a police panel

door lock that is keyed to a standard police/fire call box key. In addition to the requirements of LA Specification No. 54-053-08, provide the police panel with a toggle switch connected to switch the intersection operation between normal stop-and-go operation (AUTO) and manual operation (MANUAL). Ensure that manual control can be implemented using inputs and software such that the controller provides full programmed clearance times for the yellow clearance and red clearance for each phase while under manual control.

Provide a 1/4-inch locking phone jack in the police panel for a hand control to manually control the intersection. Provide sufficient room in the police panel for storage of a hand control and cord.

Ensure the 336S cabinet Input File is wired as follows:

336S Cabinet														
Port-Bit/C-1 Pin Assignment														
Slot #	1	2	3	4	5	6	7	8	9	10	11	12	13	14
C-1 (Spares)	59	60	61	62	63	64	65	66	75	76	77	78	79	80
Port	3-2	1-1	3-4	1-3	3-1	1-2	3-3	1-4	2-5	5-5	5-6	5-1	5-2	6-7
C-1	56	39	58	41	55	40	57	42	51	71	72	67	68	81
Port	2-1	1-5	2-3	1-7	2-2	1-6	2-4	1-8	2-6	5-7	5-8	5-3	5-4	6-8
C-1	47	43	49	45	48	44	50	46	52	73	74	69	70	82

For model 332 base mounted cabinets, ensure terminals J14-E and J14-K are wired together on the rear of the Input File. Connect TB9-12 (J14 Common) on the Input Panel to T1-2 (AC-) on the rear of the PDA.

Provide detector test switches mounted at the top of the cabinet rack or other convenient location which may be used to place a call on each of eight phases based on the chart below. Provide three positions for each switch: On (place call), Off (normal detector operation), and Momentary On (place momentary call and return to normal detector operation after switch is released). Ensure that the switches are located such that the technician can read the controller display and observe the intersection.

Connect detector test switches for cabinets as follows:

336S Cabinet		332 Cabinet	
Detector Call Switches	Terminals	Detector Call Switches	Terminals
Phase 1	I1-F	Phase 1	I1-W
Phase 2	I2-F	Phase 2	I4-W
Phase 3	I3-F	Phase 3	I5-W
Phase 4	I4-F	Phase 4	I8-W
Phase 5	I5-F	Phase 5	J1-W
Phase 6	I6-F	Phase 6	J4-W
Phase 7	I7-F	Phase 7	J5-W
Phase 8	I8-F	Phase 8	J8-W

Provide the PCB 28/56 connector for the conflict monitor unit (CMU) with 28 independent contacts per side, dual-sided with 0.156-inch contact centers. Provide the PCB 28/56 connector contacts with solder eyelet terminations. Ensure all connections to the PCB 28/56 connector are soldered to the solder eyelet terminations.

Ensure that all cabinets have the CMU connector wired according to the 332 cabinet connector pin assignments (include all wires for auxiliary output file connection). Wire pins 13, 16, R, and U of the CMU connector to a separate 4 pin plug, P1, as shown below. Provide a second plug, P2, which will mate with P1 and is wired to the auxiliary output file as shown below. Provide an additional plug, P3, which will mate with P1 and is wired to the pedestrian yellow circuits as shown below. When no auxiliary output file is installed in the cabinet, provide wires for the green and yellow inputs for channels 11, 12, 17, and 18, the red inputs for channels 17 and 18, and the wires for the P2 plug. Terminate the two-foot wires with ring type lugs, insulated, and bundled for optional use.

PIN	P1		P2		P3	
	FUNCTION	CONN TO	FUNCTION	CONN TO	FUNCTION	CONN TO
1	CH-9G	CMU-13	OLA-GRN	A123	2P-YEL	114
2	CH-9Y	CMU-16	OLA-YEL	A122	4P-YEL	105
3	CH-10G	CMU-R	OLB-GRN	A126	6P-YEL	120
4	CH-10Y	CMU-U	OLB-YEL	A125	8P-YEL	111

Do not provide the P20 terminal assembly (red monitor board) or red interface ribbon cable as specified in LA Specification No. 54-053-08.

Provide a P20 connector that mates with and is compatible with the red interface connector mounted on the front of the conflict monitor. Ensure that the P20 connector and the red interface

connector on the conflict monitor are center polarized to ensure proper connection. Ensure that removal of the P20 connector will cause the conflict monitor to recognize a latching fault condition and place the cabinet into flashing operation.

Wire the P20 connector to the output file and auxiliary output file using 22 AWG stranded wires. Ensure the length of these wires is a minimum of 42 inches in length. Provide a durable braided sleeve around the wires to organize and protect the wires.

Wire the P20 connector to the traffic signal red displays to provide inputs to the conflict monitor as shown below. Ensure the pedestrian Don't Walk circuits are wired to channels 13 through 16 of the P20 connector. When no auxiliary output file is installed in the cabinet, provide wires for channels 9 through 12 reds. Provide a wire for special function 1. Terminate the unused wires with ring type lugs, insulated, and bundled for optional use.

P20 Connector					
PIN	FUNCTION	CONN TO	PIN	FUNCTION	CONN TO
1	Channel 15 Red	119	2	Channel 16 Red	110
3	Channel 14 Red	104	4	Chassis GND	01-9
5	Channel 13 Red	113	6	N/C	
7	Channel 12 Red	AUX 101	8	Spec Function 1	
9	Channel 10 Red	AUX 124	10	Channel 11 Red	AUX 114
11	Channel 9 Red	AUX 121	12	Channel 8 Red	107
13	Channel 7 Red	122	14	Channel 6 Red	134
15	Channel 5 Red	131	16	Channel 4 Red	101
17	Channel 3 Red	116	18	Channel 2 Red	128
19	Channel 1 Red	125	20	Red Enable	01-14

Ensure controller outputs to auxiliary are pre-the C5 When no output file

the unit the output file wired to connector. auxiliary is installed

in the cabinet, connect the C5 connector to a storage socket located on the Input Panel or on the rear of the PDA.

Do not wire pin 12 of the load switch sockets.

In addition to the requirements of LA Specification No. 54-053-08, ensure relay K1 on the Power Distribution Assembly (PDA) is a four-pole relay and K2 on the PDA is a two-pole relay.

Provide a two pole, ganged circuit breaker for the flash bus circuit. Ensure the flash bus circuit breaker is an inverse time circuit breaker rated for 10 amps at 120 VAC with a minimum of 10,000 RMS symmetrical amperes short circuit current rating. Do not provide the auxiliary switch feature on the flash bus circuit breaker. Ensure the ganged flash bus circuit breaker is certified by the circuit breaker manufacturer to provide gang tripping operation.

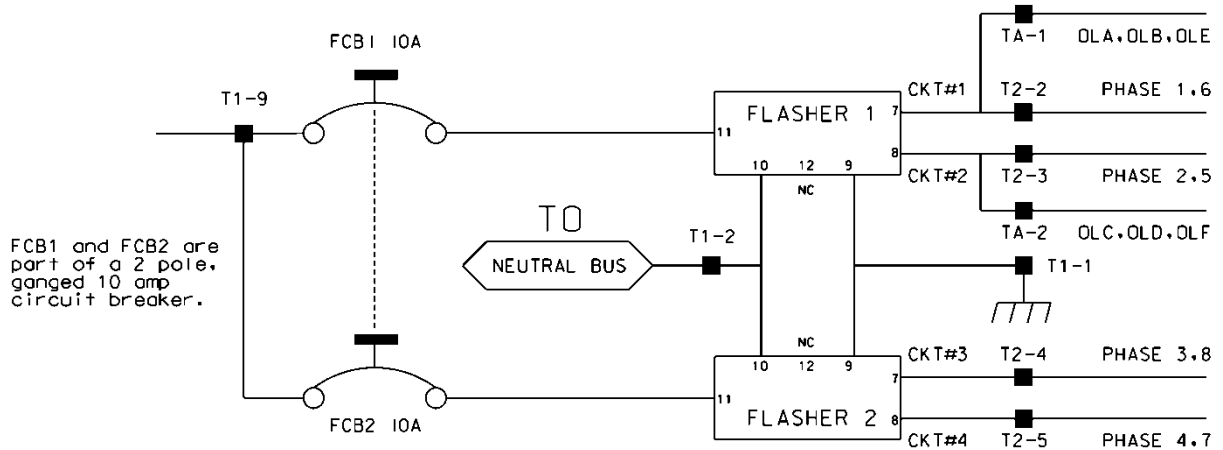

Ensure auxiliary output files are wired as follows:

AUXILIARY OUTPUT FILE	
TERMINAL BLOCK TA ASSIGNMENTS	
POSITION	FUNCTION
1	Flasher Unit #1, Circuit 1/FTR1 (OLA, OLB)/FTR3 (OLE)
2	Flasher Unit #1, Circuit 2/FTR2 (OLC, OLD)/FTR3 (OLF)
3	Flash Transfer Relay Coils
4	AC -
5	Power Circuit 5
6	Power Circuit 5
7	Equipment Ground Bus
8	NC

Provide four spare load resistors mounted in each cabinet. Ensure each load resistor is rated as shown in the table below. Wire one side of each load resistor to AC-. Connect the other side of each resistor to a separate terminal on a four (4) position terminal block. Mount the load resistors and terminal block either inside the back of Output File No. 1 or on the upper area of the Service Panel.

ACCEPTABLE LOAD RESISTOR VALUES	
VALUE (ohms)	WATTAGE
1.5K – 1.9 K	25W (min)
2.0K – 3.0K	10W (min)

Provide Model 200 load switches, Model 204 flashers, Model 242 DC isolators, Model 252 AC isolators, and Model 206L power supply units that conform to CALTRANS' *Transportation Electrical Equipment Specifications* dated March 12, 2009 with Erratum 1.

C. Type 170 E Cabinet Physical Requirements:

Do not mold, cast, or scribe the name "City of Los Angeles" on the outside of the cabinet door as specified in LA Specification No. 54-053-08. Do not provide a Communications Terminal Panel as specified in LA Specification No. 54-053-08. Do not provide terminal block TBB on the Service Panel. Do not provide Cabinet Verification Test Program software or associated test jigs as specified in LA Specification No. 54-053-08.

Furnish unpainted, natural, aluminum cabinet shells. Ensure that all non-aluminum hardware on the cabinet is stainless steel or a Department approved non-corrosive alternate.

Ensure the lifting eyes, gasket channels, police panel, and all supports welded to the enclosure and doors are fabricated from 0.125-inch minimum thickness aluminum sheet and meet the same standards as the cabinet and doors.

Provide front and rear doors with latching handles that allow padlocking in the closed position. Furnish 0.75-inch minimum diameter stainless steel handles with a minimum 0.5-inch shank. Place the padlocking attachment at 4.0 inches from the handle shank center to clear the lock and key. Provide an additional 4.0 inches minimum gripping length.

Provide Corbin #2 locks on the front and rear doors. Provide one (1) Corbin #2 and one (1) police master key with each cabinet. Ensure main door locks allow removal of keys in the locked position only.

Provide a surge protection panel with 16 loop surge protection devices and designed to allow sufficient free space for wire connection/disconnection and surge protection device replacement. For model 332 cabinets, provide an additional 20 loop surge protection devices. Provide an additional two AC+ interconnect surge devices to protect one slot and eight DC surge protection devices to protect four slots. Provide no protection devices on slot I14.

For pole mounted cabinets, mount surge protection devices for the AC+ interconnect inputs, inductive loop detector inputs, and low voltage DC inputs on a swing down panel assembly fabricated from sturdy aluminum. Attach the swing down panel to the bottom rear cabinet rack assembly using thumb screws. Ensure the swing down panel allows for easy removal of the input file without removing the surge protection panel assembly or its parts. Have the surge protection devices mounted horizontally on the panel and soldered to the feed through terminals of four 14 position terminal blocks with #8 screws mounted on the other side. Ensure the top row of terminals is connected to the upper slots and the bottom row of terminals is connected to the bottom slots. Provide a 15-position copper equipment ground bus attached to the field terminal side (outside) of

the swing down panel for termination of loop lead-in shield grounds. Ensure that a Number 4 AWG green wire connects the surge protection panel assembly ground bus to the main cabinet equipment ground.

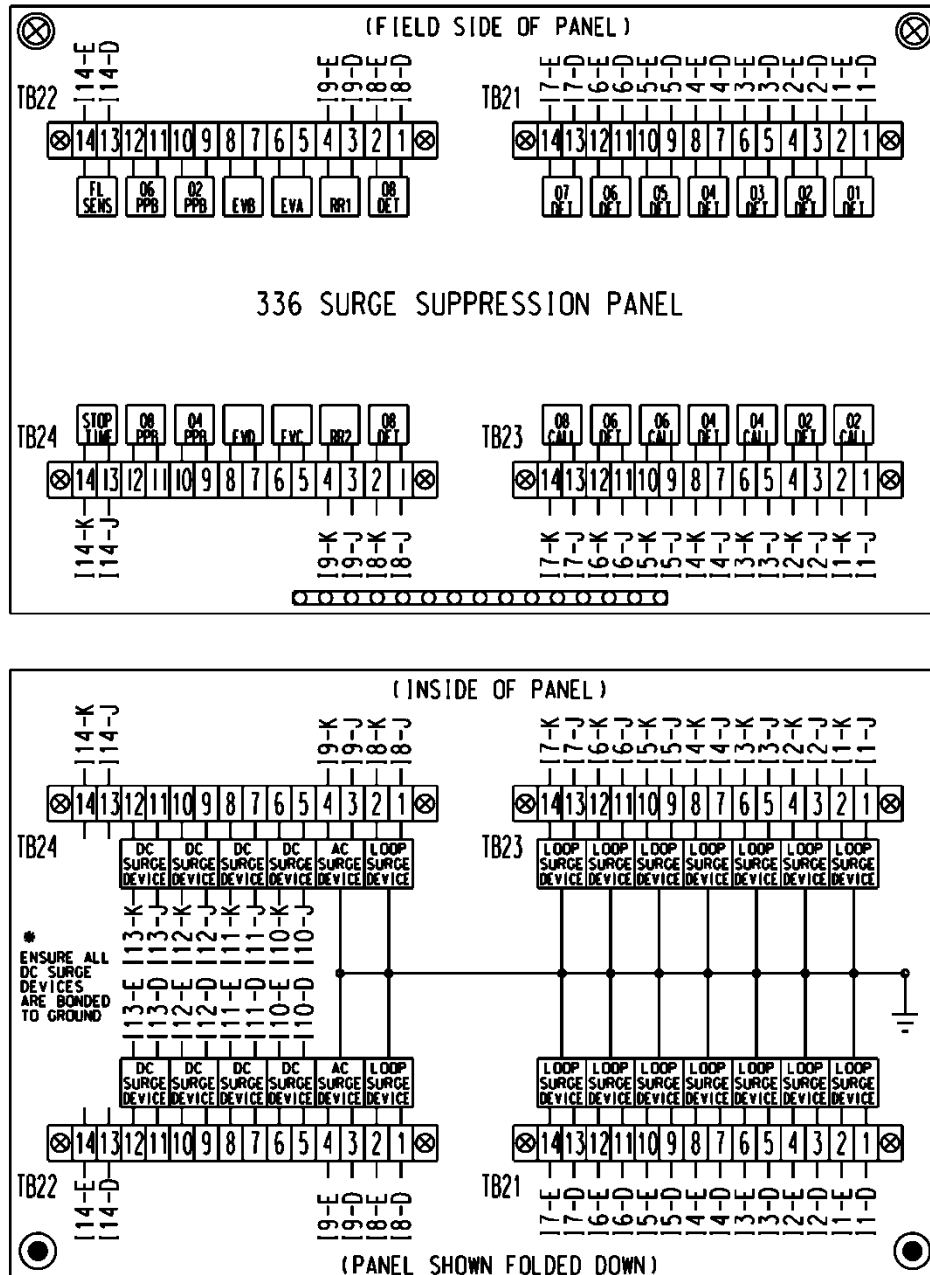

For base mounted cabinets, mount surge protection panels on the left side of the cabinet as viewed from the rear. Attach each panel to the cabinet rack assembly using bolts and make it easily removable. Mount the surge protection devices in vertical rows on each panel and connect the

devices to one side of 12 position, double row terminal blocks with #8 screws. For each surge protection panel, terminate all grounds from the surge protection devices on a copper equipment ground bus attached to the surge protection panel. Wire the terminals to the rear of a standard input file using spade lugs for input file protection.

Provide permanent labels that indicate the slot and the pins connected to each terminal that may be viewed from the rear cabinet door. Label and orient terminals so that each pair of inputs is next to each other. Indicate on the labeling the input file (I or J), the slot number (1-14) and the terminal pins of the input slots (either D & E for upper or J & K for lower).

Provide a minimum 14 x 16 inch pull out, hinged top shelf located immediately below controller mounting section of the cabinet. Ensure the shelf is designed to fully expose the table surface outside the controller at a height approximately even with the bottom of the controller. Ensure the shelf has a storage bin interior which is a minimum of 1 inch deep and approximately the same dimensions as the shelf. Provide an access to the storage area by lifting the hinged top of the shelf. Fabricate the shelf and slide from aluminum or stainless steel and ensure the assembly can support the 2070L controller plus 15 pounds of additional weight. Ensure shelf has a locking mechanism to secure it in the fully extended position and does not inhibit the removal of the 2070L controller or removal of cards inside the controller when fully extended. Provide a locking mechanism that is easily released when the shelf is to be returned to its non-use position directly under the controller.

D. Model 2018 Enhanced Conflict Monitor:

Furnish Model 2018 Enhanced Conflict Monitors that provide monitoring of 18 channels. Ensure each channel consists of a green, yellow, and red field signal input. Ensure that the conflict monitor meets or exceeds CALTRANS' Transportation Electrical Equipment Specifications dated March 12, 2009, with Erratum 1 (hereafter referred to as CALTRANS' 2009 TEES) for a model 210 monitor unit and other requirements stated in this specification.

Ensure the conflict monitor is provided with an 18-channel conflict programming card. Pin EE and Pin T of the conflict programming card shall be connected together. Pin 16 of the conflict programming card shall be floating. Ensure that the absence of the conflict programming card will cause the conflict monitor to trigger (enter fault mode), and remain in the triggered state until the programming card is properly inserted, and the conflict monitor is reset.

Provide a conflict monitor that incorporates LED indicators into the front panel to dynamically display the status of the monitor under normal conditions and to provide a comprehensive review of field inputs with monitor status under fault conditions. Ensure that the monitor indicates the channels that were active during a conflict condition and the channels that experienced a failure for all other per channel fault conditions detected. Ensure that these indications and the status of each channel are retained until the Conflict Monitor is reset. Furnish LED indicators for the following:

- AC Power (Green LED indicator)
- VDC Failed (Red LED indicator)
- WDT Error (Red LED indicator)
- Conflict (Red LED indicator)
- Red Fail (Red LED indicator)
- Dual Indication (Red LED indicator)

- Yellow/Clearance Failure (Red LED indicator)
- PCA/PC Ajar (Red LED indicator)
- Monitor Fail/Diagnostic Failure (Red LED indicator)
- 54 Channel Status Indicators (1 Red, 1 Yellow, and 1 Green LED indicator for each of the 18 channels)

Provide a switch to set the Red Fail fault timing. Ensure that when the switch is in the ON position the Red Fail fault timing value is set to 1350 +/- 150 ms (2018 mode). Ensure that when the switch is in the OFF position the Red Fail fault timing value is set to 850 +/- 150 ms (210 mode).

Provide a switch to set the Watchdog fault timing. Ensure that when the switch is in the ON position the Watchdog fault timing value is set to 1.0 +/- 0.1 s (2018 mode). Ensure that when the switch is in the OFF position the Watchdog fault timing value is set to 1.5 +/- 0.1 s (210 mode).

Provide a jumper or switch to set the AC line brown-out levels. Ensure that when the jumper is present, or the switch is in the ON position the AC line dropout voltage threshold is 98 +/- 2 Vrms, the AC line restore voltage threshold is 103 +/- 2 Vrms, and the AC line brown-out timing value is set to 400 +/- 50ms (2018 mode). Ensure that when the jumper is not present, or the switch is in the OFF position the AC line dropout voltage threshold is 92 +/- 2 Vrms, the AC line restore voltage threshold is 98 +/- 2 Vrms, and the AC line brown-out timing value is set to 80 +/- 17 ms (210 mode).

Provide a jumper or switch that will enable and disable the Watchdog Latch function. Ensure that when the jumper is not present, or the switch is in the OFF position the Watchdog Latch function is disabled. In this mode of operation, a Watchdog fault will be reset following a power loss, brownout, or power interruption. Ensure that when the jumper is present, or the switch is in the ON position the Watchdog Latch function is enabled. In this mode of operation, a Watchdog fault will be retained until a Reset command is issued.

Provide a jumper that will reverse the active polarity for pin #EE (output relay common). Ensure that when the jumper is not present pin #EE (output relay common) will be considered 'Active' at a voltage greater than 70 Vrms and 'Not Active' at a voltage less than 50 Vrms (Caltrans mode). Ensure that when the jumper is present pin #EE (output relay common) will be considered 'Active' at a voltage less than 50 Vrms and 'Not Active' at a voltage greater than 70 Vrms (Failsafe mode).

In addition to the connectors required by CALTRANS' 2009 TEES, provide the conflict monitor with a red interface connector mounted on the front of the monitor. Ensure the connector is a 20 pin, right angle, center polarized, male connector with latching clip locks and polarizing keys. Ensure the right-angle solder tails are designed for a 0.062" thick printed circuit board. Keying of the connector shall be between pins 3 and 5, and between 17 and 19. Ensure the connector has two rows of pins with the odd numbered pins on one row and the even pins on the other row. Ensure the connector pin row spacing is 0.10" and pitch is 0.10". Ensure the mating length of the connector pins is 0.24". Ensure the pins are finished with gold plating 30μ" thick.

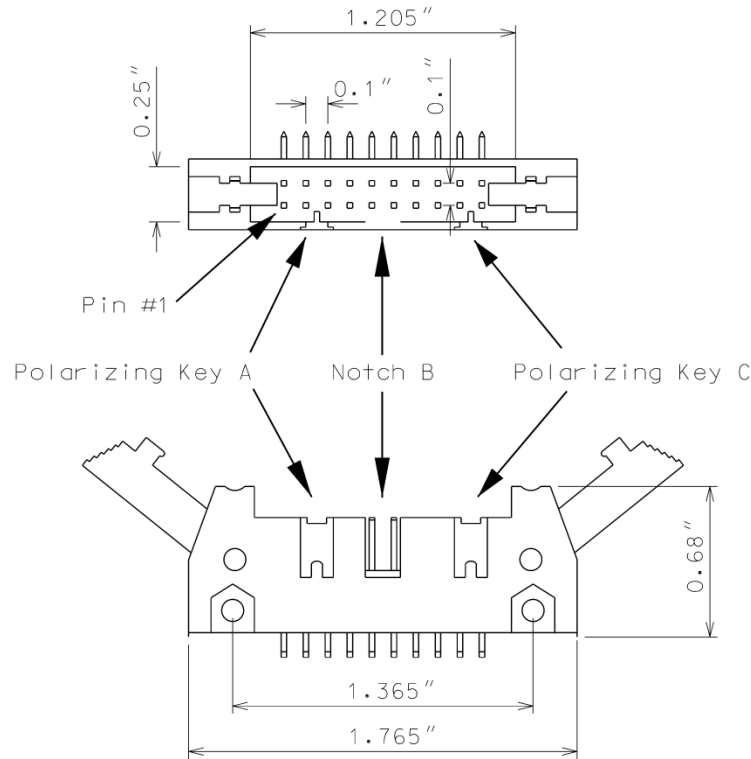

Ensure the red interface connector pins on the monitor have the following functions:

Pin #	Function	Pin #	Function
1	Channel 15 Red	2	Channel 16 Red
3	Channel 14 Red	4	Chassis Ground
5	Channel 13 Red	6	Special Function 2
7	Channel 12 Red	8	Special Function 1
9	Channel 10 Red	10	Channel 11 Red
11	Channel 9 Red	12	Channel 8 Red
13	Channel 7 Red	14	Channel 6 Red
15	Channel 5 Red	16	Channel 4 Red
17	Channel 3 Red	18	Channel 2 Red
19	Channel 1 Red	20	Red Enable

Ensure that removal of the P20 cable connector will cause the conflict monitor to recognize a latching fault condition and place the cabinet into flashing operation.

Provide Special Function 1 and Special Function 2 inputs to the unit which shall disable only Red Fail Monitoring when either input is sensed active. A Special Function input shall be sensed active when the input voltage exceeds 70 Vrms with a minimum duration of 550 ms. A Special Function input shall be sensed not active when the input voltage is less than 50 Vrms or the duration is less than 250 ms. A Special Function input is undefined by these specifications and may or may not be sensed active when the input voltage is between 50 Vrms and 70 Vrms or the duration is between 250 ms and 550 ms.

Ensure the conflict monitor recognizes field signal inputs for each channel that meet the following requirements:

- consider a Red input greater than 70 Vrms and with a duration of at least 500 ms as an “on” condition;
- consider a Red input less than 50 Vrms or with a duration of less than 200 ms as an “off” condition (no valid signal);
- consider a Red input between 50 Vrms and 70 Vrms or with a duration between 200 ms and 500 ms to be undefined by these specifications;
- consider a Green or Yellow input greater than 25 Vrms and with a duration of at least 500 ms as an “on” condition;
- consider a Green or Yellow input less than 15 Vrms or with a duration of less than 200 ms as an “off” condition; and
- consider a Green or Yellow input between 15 Vrms and 25 Vrms or with a duration between 200 ms and 500 ms to be undefined by these specifications.

Provide a conflict monitor that recognizes the faults specified by CALTRANS’ 2009 TEES and the following additional faults. Ensure the conflict monitor will trigger upon detection of a fault and will remain in the triggered (in fault mode) state until the unit is reset at the front panel or through the external remote reset input for the following failures:

1. **Red Monitoring or Absence of Any Indication (Red Failure):** A condition in which no “on” voltage signal is detected on any of the green, yellow, or red inputs to a given monitor channel. If a signal is not detected on at least one input (R, Y, or G) of a conflict monitor channel for a period greater than 1000 ms when used with a 170 controller and 1500 ms when used with a 2070 controller, ensure monitor will trigger and put the intersection into flash. If the absence of any indication condition lasts less than 700 ms when used with a 170 controller and 1200 ms when used with a 2070 controller, ensure conflict monitor will not trigger. Red fail monitoring shall be enabled on a per channel basis by the use of switches located on the conflict monitor. Have red monitoring occur when all of the following input conditions are in effect:
 - a) Red Enable input to monitor is active (Red Enable voltages are “on” at greater than 70 Vrms, off at less than 50 Vrms, undefined between 50 and 70 Vrms), and
 - b) Neither Special Function 1 nor Special Function 2 inputs are active.
 - c) Pin #EE (output relay common) is not active

2. **Short/Missing Yellow Indication Fault (Clearance Error):** Yellow indication following a green is missing or shorter than 2.7 seconds (with ± 0.1 -second accuracy). If a channel fails to detect an “on” signal at the Yellow input for a minimum of 2.7 seconds (± 0.1 second) following the detection of an “on” signal at a Green input for that channel, ensure that the monitor triggers and generates a clearance/short yellow error fault indication. Short/missing yellow (clearance) monitoring shall be enabled on a per channel basis by the use of switches located on the conflict monitor. This fault shall not occur when the channel is programmed for Yellow Inhibit, when the Red Enable signal is inactive or pin #EE (output relay common) is active.
3. **Dual Indications on the Same Channel:** In this condition, more than one indication (R,Y,G) is detected as “on” at the same time on the same channel. If dual indications are detected for a period greater than 500 ms, ensure that the conflict monitor triggers and displays the proper failure indication (Dual Ind fault). If this condition is detected for less than 200 ms, ensure that the monitor does not trigger. G-Y-R dual indication monitoring shall be enabled on a per channel basis by the use of switches located on the conflict monitor. G-Y dual indication monitoring shall be enabled for all channels by use of a switch located on the conflict monitor. This fault shall not occur when the Red Enable signal is inactive or pin #EE (output relay common) is active.
4. **Configuration Settings Change:** The configuration settings are comprised of (as a minimum) the permissive diode matrix, dual indication switches, yellow disable jumpers, any option switches, any option jumpers, and the Watchdog Enable switch. Ensure the conflict monitor compares the current configuration settings with the previous stored configuration settings on power-up, on reset, and periodically during operation. If any of the configuration settings are changed, ensure that the conflict monitor triggers and causes the program card indicator to flash. Ensure that configuration change faults are only reset by depressing and holding the front panel reset button for a minimum of three seconds. Ensure the external remote reset input does not reset configuration change faults.

Ensure the conflict monitor will trigger and the AC Power indicator will flash at a rate of $2 \text{ Hz} \pm 20\%$ with a 50% duty cycle when the AC Line voltage falls below the “drop-out” level. Ensure the conflict monitor will resume normal operation when the AC Line voltage returns above the “restore” level. Ensure the AC Power indicator will remain illuminated when the AC voltage returns above the “restore” level. Should an AC Line power interruption occur while the monitor is in the fault mode, then upon restoration of AC Line power, the monitor will remain in the fault mode and the correct fault and channel indicators will be displayed.

Provide a flash interval of at least 6 seconds and at most 10 seconds in duration following a power-up, an AC Line interruption, or a brownout restore. Ensure the conflict monitor will suspend all fault monitoring functions, close the Output relay contacts, and flash the AC indicator at a rate of $4 \text{ Hz} \pm 20\%$ with a 50% duty cycle during this interval. Ensure the termination of the flash interval after at least 6 seconds if the Watchdog input has made 5 transitions between the True and False state and the AC Line voltage is greater than the “restore” level. If the watchdog input has not made 5 transitions between the True and False state within 10 ± 0.5 seconds, the monitor shall enter a WDT error fault condition.

Ensure the conflict monitor will monitor an intersection with a minimum of four approaches using the four-section Flashing Yellow Arrow (FYA) vehicle traffic signal as outlined by the NCHRP 3-54 research project for protected-permissive left turn signal displays. Ensure the conflict monitor will operate in the FYA mode and FYAc (Compact) mode as specified below to monitor each channel pair for the following fault conditions: Conflict, Flash Rate Detection, Red Fail, Dual Indication, and Clearance. Provide a switch to select between the FYA mode and FYAc mode. Provide a switch to select each FYA phase movement for monitoring.

FYA mode

FYA Signal Head	Phase 1	Phase 3	Phase 5	Phase 7
Red Arrow	Channel 9 Red	Channel 10 Red	Channel 11 Red	Channel 12 Red
Yellow Arrow	Channel 9 Yellow	Channel 10 Yellow	Channel 11 Yellow	Channel 12 Yellow
Flashing Yellow Arrow	Channel 9 Green	Channel 10 Green	Channel 11 Green	Channel 12 Green
Green Arrow	Channel 1 Green	Channel 3 Green	Channel 5 Green	Channel 7 Green

FYAc mode

FYA Signal Head	Phase 1	Phase 3	Phase 5	Phase 7
Red Arrow	Channel 1 Red	Channel 3 Red	Channel 5 Red	Channel 7 Red
Yellow Arrow	Channel 1 Yellow	Channel 3 Yellow	Channel 5 Yellow	Channel 7 Yellow
Flashing Yellow Arrow	Channel 1 Green	Channel 3 Green	Channel 5 Green	Channel 7 Green
Green Arrow	Channel 9 Green	Channel 9 Yellow	Channel 10 Green	Channel 10 Yellow

If a FYA channel pair is enabled for FYA operation, the conflict monitor will monitor the FYA logical channel pair for the additional following conditions:

1. **Conflict:** Channel conflicts are detected based on the permissive programming jumpers on the program card. This operation remains unchanged from normal operation except for the solid Yellow arrow (FYA clearance) signal.
2. **Yellow Change Interval Conflict:** During the Yellow change interval of the Permissive Turn channel (flashing Yellow arrow) the conflict monitor shall verify that no conflicting channels to the solid Yellow arrow channel (clearance) are active. These conflicting channels shall be determined by the program card compatibility programming of the Permissive Turn channel (flashing Yellow arrow). During the Yellow change interval of the Protected Turn channel (solid Green arrow) the conflict monitor shall verify that no conflicting channels to the solid Yellow arrow channel (clearance) are active as determined by the program card compatibility programming of the Protected Turn channel (solid Green arrow).
3. **Flash Rate Detection:** The conflict monitor unit shall monitor for the absence of a valid flash rate for the Permissive turn channel (flashing Yellow arrow). If the Permissive turn channel (flashing Yellow arrow) is active for a period greater than 1600 milliseconds, ensure the conflict monitor triggers and puts the intersection into flash. If the Permissive turn channel (flashing Yellow arrow) is active for a period less than 1400 milliseconds, ensure the conflict monitor does not trigger. Ensure the conflict monitor will remain in the triggered (in fault mode) state until the unit is reset at the front panel or through the external remote reset input. Provide a jumper or switch that will enable and disable the Flash Rate Detection function. Ensure that when the jumper is not present, or the switch is in the OFF position the Flash Rate Detection function is enabled. Ensure that when the jumper is present, or the switch is in the ON position the Flash Rate Detection function is disabled.
4. **Red Monitoring or Absence of Any Indication (Red Failure):** The conflict monitor unit shall detect a red failure if there is an absence of voltage on all four of the inputs of a FYA channel pair (RA, YA, FYA, GA).
5. **Dual Indications on the Same Channel:** The conflict monitor unit shall detect a dual indication if two or more inputs of a FYA channel pair (RA, YA, FYA, GA) are “on” at the same time.
6. **Short/Missing Yellow Indication Fault (Clearance Error):** The conflict monitor unit shall monitor the solid Yellow arrow for a clearance fault when terminating both the Protected Turn channel (solid Green arrow) interval and the Permissive Turn channel (flashing Yellow arrow) interval.

Ensure that the conflict monitor will log at least nine of the most recent events detected by the monitor in non-volatile EEPROM memory (or equivalent). For each event, record at a minimum the time, date, type of event, status of each field signal indication with RMS voltage, and specific channels involved with the event. Ensure the conflict monitor will log the following events: monitor reset, configuration, previous fault, and AC line. Furnish the signal sequence log that shows all channel states (Greens, Yellows, and Reds) and the Red Enable State for a minimum of 2 seconds prior to the current fault trigger point. Ensure the display resolution of the inputs for the signal sequence log is not greater than 50 ms.

For conflict monitors used within an Ethernet communications system, provide a conflict monitor with an Ethernet 10/100 Mbps, RJ-45 port for data communication access to the monitor by

a local notebook computer and remotely via a workstation or notebook computer device connected to the signal system local area network. The Ethernet port shall be electrically isolated from the conflict monitor's electronics and shall provide a minimum of 1500 Vrms isolation. Integrate monitor with Ethernet network in cabinet. Provide software to retrieve the time and date from a network server in order to synchronize the on-board times between the conflict monitor and the controller. Furnish and install the following Windows based, graphic user interface software on workstations and notebook computers where the signal system client software is installed: 1) software to view and retrieve all event log information, 2) software that will search and display a list of conflict monitor IP addresses and IDs on the network, and 3) software to change the conflict monitor's network parameters such as IP address and subnet mask.

For non-Ethernet connected monitors, provide a RS-232C/D compliant port (DB-9 female connector) on the front panel of the conflict monitor in order to provide communications from the conflict monitor to the 170/2070 controller or to a Department-furnished laptop computer. Electrically isolate the port interface electronics from all monitor electronics, excluding Chassis Ground. Ensure that the controller can receive all event log information through a controller Asynchronous Communications Interface Adapter (Type 170E) or Async Serial Comm Module (2070). Furnish and connect a serial cable from the conflict monitor's DB-9 connector to Comm Port 1 of the 2070 controller. Ensure conflict monitor communicates with the controller. Provide a Windows based graphic user interface software to communicate directly through the same monitor RS-232C/D compliant port to retrieve and view all event log information to a Department-furnished laptop computer. The RS-232C/D compliant port on the monitor shall allow the monitor to function as a DCE device with pin connections as follows:

Conflict Monitor RS-232C/D (DB-9 Female) Pinout		
Pin Number	Function	I/O
1	DCD	O
2	TX Data	O
3	RX Data	I
4	DTR	I
5	Ground	-
6	DSR	O
7	CTS	I
8	RTS	O
9	NC	-

MONITOR BOARD EDGE CONNECTOR

Pin #	Function (Back Side)	Pin #	Function (Component Side)
1	Channel 2 Green	A	Channel 2 Yellow
2	Channel 13 Green	B	Channel 6 Green
3	Channel 6 Yellow	C	Channel 15 Green
4	Channel 4 Green	D	Channel 4 Yellow
5	Channel 14 Green	E	Channel 8 Green
6	Channel 8 Yellow	F	Channel 16 Green
7	Channel 5 Green	H	Channel 5 Yellow
8	Channel 13 Yellow	J	Channel 1 Green
9	Channel 1 Yellow	K	Channel 15 Yellow
10	Channel 7 Green	L	Channel 7 Yellow
11	Channel 14 Yellow	M	Channel 3 Green
12	Channel 3 Yellow	N	Channel 16 Yellow
13	Channel 9 Green	P	Channel 17 Yellow
14	Channel 17 Green	R	Channel 10 Green
15	Channel 11 Yellow	S	Channel 11 Green
16	Channel 9 Yellow	T	Channel 18 Yellow
17	Channel 18 Green	U	Channel 10 Yellow
--		--	
18	Channel 12 Yellow	V	Channel 12 Green
19	Channel 17 Red	W	Channel 18 Red
20	Chassis Ground	X	Not Assigned
21	AC-	Y	DC Common
22	Watchdog Timer	Z	External Test Reset
23	+24VDC	AA	+24VDC
24	Tied to Pin 25	BB	Stop Time (Output)
25	Tied to Pin 24	CC	Not Assigned
26	Not Assigned	DD	Not Assigned
27	Relay Output, Side #3, N.O.	EE	Relay Output, Side #2, Common
28	Relay Output, Side #1, N.C.	FF	AC+

-- Slotted for keying between Pins 17/U and 18/V

CONFLICT PROGRAM CARD PIN ASSIGNMENTS

Pin #	Function (Back Side)	Pin #	Function (Component Side)
1	Channel 2 Green	A	Channel 1 Green
2	Channel 3 Green	B	Channel 2 Green
3	Channel 4 Green	C	Channel 3 Green
4	Channel 5 Green	D	Channel 4 Green
5	Channel 6 Green	E	Channel 5 Green
6	Channel 7 Green	F	Channel 6 Green
7	Channel 8 Green	H	Channel 7 Green
8	Channel 9 Green	J	Channel 8 Green
9	Channel 10 Green	K	Channel 9 Green
10	Channel 11 Green	L	Channel 10 Green
11	Channel 12 Green	M	Channel 11 Green
12	Channel 13 Green	N	Channel 12 Green
13	Channel 14 Green	P	Channel 13 Green
14	Channel 15 Green	R	Channel 14 Green
15	Channel 16 Green	S	Channel 15 Green
16	N/C	T	PC AJAR
17	Channel 1 Yellow	U	Channel 9 Yellow
18	Channel 2 Yellow	V	Channel 10 Yellow
19	Channel 3 Yellow	W	Channel 11 Yellow
20	Channel 4 Yellow	X	Channel 12 Yellow
21	Channel 5 Yellow	Y	Channel 13 Yellow
22	Channel 6 Yellow	Z	Channel 14 Yellow
23	Channel 7 Yellow	AA	Channel 15 Yellow
24	Channel 8 Yellow	BB	Channel 16 Yellow
--		--	
25	Channel 17 Green	CC	Channel 17 Yellow
26	Channel 18 Green	DD	Channel 18 Yellow
27	Channel 16 Green	EE	PC AJAR (Program Card)
28	Yellow Inhibit Common	FF	Channel 17 Green

-- Slotted for keying between Pins 24/BB and 25/CC

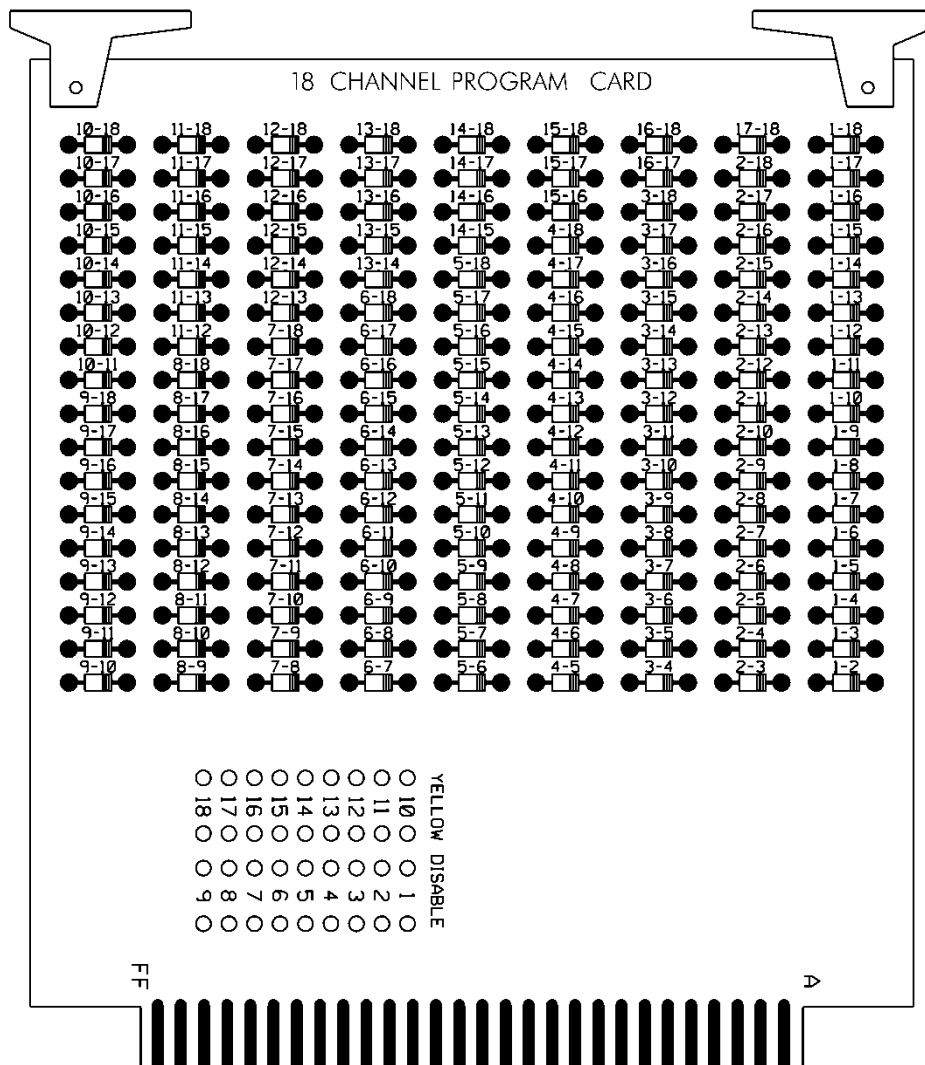

E. Preemption and Sign Control Box

Provide preemption and sign control box to operate in a Model 332 and Model 336S cabinet. Provide hardware to mount the box to the cage of the cabinet to ensure the front side is facing the opposite side of the cabinet. Furnish the material of the box from a durable finished metallic or thermoplastic case. Ensure the size of the box is not greater than 7(l) x 5(w) x 5(d) inches. Ensure that no modification is necessary to mount the box on the cabinet cage.

Provide the following components in the preemption and sign control box: relays, fuses, terminal blocks, MOVs, resistor, RC network, lamp, and push button switch.

Provide UL Listed or Recognized relay K1 as a DPDT enclosed relay (120 VAC, 60 Hz coil) with an 8-pin octal-style plug and associated octal base. Provide contact material made of AgCdO with a 10 amp, 240 VAC rating. Ensure the relay has a specified pickup voltage of 102 VAC.

Provide relay SSR1 as a Triac SPST normally open solid-state relay that is rated for 120 VAC input and zero-crossing (resistive load) 25 amp @ 120 VAC output. Ensure the relay turns on at 90 Vrms within 10 ms and turns off at 10 Vrms within 40 ms. Ensure the relay has physical

characteristics as shown in the wiring detail in Figure 1. Provide 4 terminal screws with saddle clamps.

Provide fuses F1 and F2 as a UL Listed ¼" x 1-1/4" glass tube rated at 250 volts with a 10kA interrupting rating. Ensure F1 non-delay (fast-acting) and F2 slow-blow (time-delay) fuses have a maximum opening times of 60 minutes and 120 seconds for currents of 135 and 200 percent of the ampere rating, respectively. Ensure F2 slow-blow (time-delay) fuses have a minimum opening times of 12 seconds at 200 percent of the ampere rating. Provide fuse holders that are UL Recognized panel-mounted holders rated 250V, 15 ampere minimum with bayonet-type knobs which accept ¼" x 1-1/4" glass tube fuses.

Provide terminal blocks that are rated for 300V and are made of electrical grade thermoplastic or thermosetting plastic. Ensure each terminal block is of closed back design and has recessed-screw terminals with molded barriers between terminals. Ensure each terminal block is labeled with a block designation. Ensure each terminal is labeled with the function and a number.

Provide 3/4-inch diameter radial lead UL-recognized metal oxide varistors (MOVs) that have electrical performance as outlined below.

PROPERTIES OF MOV SURGE PROTECTOR	
Maximum Continuous Applied Voltage at 185° F	150 VAC (RMS) 200 VDC
Maximum Peak 8x20µs Current at 185° F	6500 A
Maximum Energy Rating at 185° F	80 J
Voltage Range 1 mA DC Test at 77° F	212-268 V
Max. Clamping Voltage 8x20µs, 100A at 77° F	395 V
Typical Capacitance (1 MHz) at 77° F	1600 pF

Provide resistor R1 as a 2K ohm, 12 watt, wirewound resistor with tinned terminals and attaching leads. Ensure the resistor is spaced apart from surrounding wires.

Provide a LED or incandescent lamp that has a voltage rating of 120 VAC with a minimum life rating at 50,000 hours.

Wire the preemption and sign control box as shown in Figure 1.

RAILROAD PREEMPTION WIRING DETAIL
(wire as shown below)

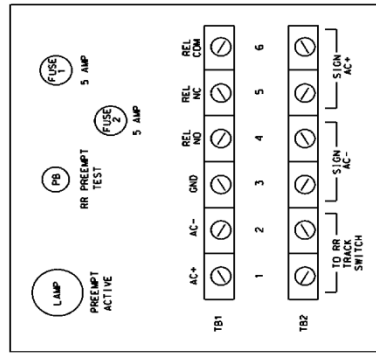
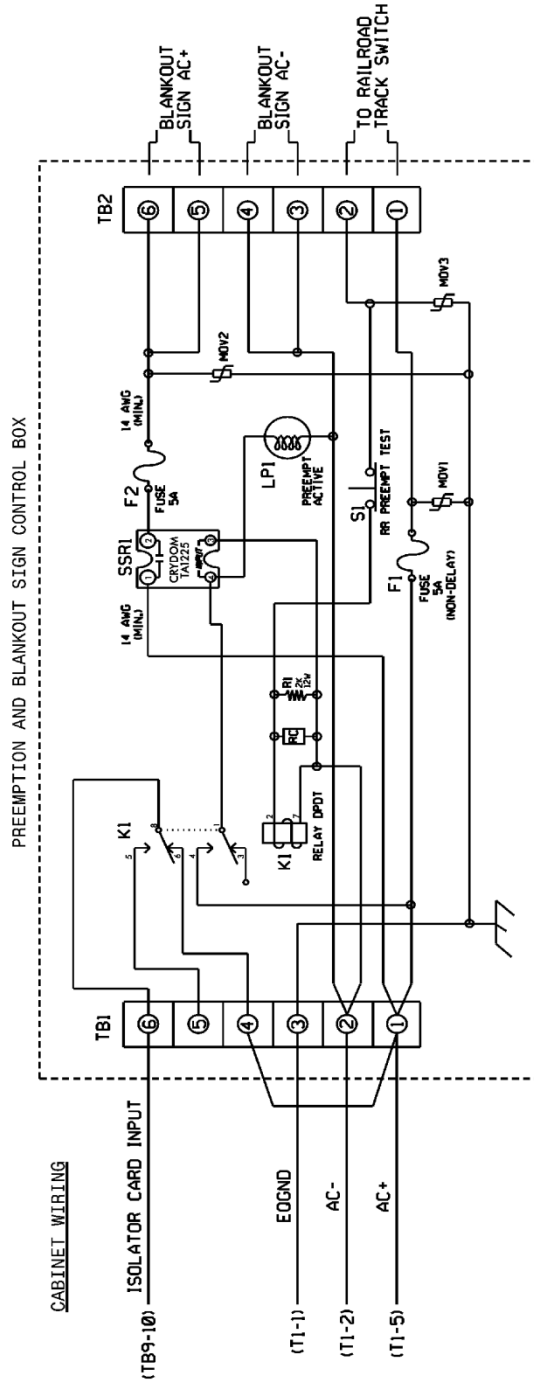

NOTES

1. RELAY K1 IS SHOWN IN THE ENERGIZED (PREEMPT NO1 ACTIVE) NORMAL OPERATION STATE.
2. AC ISOLATOR CARD SHALL ACTIVATE PREEMPTION UPON REMOVAL OF AC+ FROM INPUT (AS SHOWN ABOVE). THIS IS ACCOMPLISHED BY SETTING TYPE 252 AC ISOLATOR CARD TO INVERTED OPERATION.

Figure 1

3.3. MATERIALS – TYPE 2070LX CONTROLLERS

Furnish model 2070LX controller units that conform to CALTRANS *Transportation Electrical Equipment Specifications* (TEES) (dated March 12, 2009, plus Errata 1 dated January 21, 2010 and Errata 2 dated December 5, 2014) except as required herein.

The Department will provide software at the beginning of the burning-in period. Contractor shall give 5 working days notice before needing software. Program software provided by the Department.

Provide model 2070LX controllers with Linux kernel 2.6.18 or higher and device drivers, composed of the unit chassis and at a minimum the following modules and assemblies:

- MODEL 2070-1C, CPU Module, Single Board, with 8Mb Datakey (blue in color)
- MODEL 2070-2E+, Field I/O Module (FI/O)
 - Note: Configure the Field I/O Module to disable both the External WDT Shunt/Toggle Switch and SP3 (SP3 active indicator is “off”)
- MODEL 2070-3B, Front Panel Module (FP), Display B (8x40)
- MODEL 2070-4A, Power Supply Module, 10 AMP

Provide a Board Support Package (BSP) to the state and to any specified applications software manufacturer when requested by the state to facilitate the porting of application software.

Improvements to the NCDOT project U-4405 require the use of proprietary equipment to remain compatible with the Fayetteville Computerized Signal System. The City of Fayetteville currently operates Econolite 1C CPU modules in all controllers. In accordance with 23 CFR 634.411(a)(2), we are certifying that the following proprietary items are required for “synchronization” with the City’s signal system:

7 - Econolite 1C CPU modules

4. VIDEO IMAGING LOOP EMULATOR DETECTOR SYSTEMS

4.1. DESCRIPTION

Design, furnish, provide training, and install video imaging loop emulator detection systems with all necessary hardware in accordance with the plans and specifications.

Unless otherwise specified in the contract, all loop emulator detection equipment will remain the property of the contractor.

4.2. MATERIALS

A. General:

Material and equipment furnished under this section must be pre-approved on the Department’s QPL by the date of installation except miscellaneous hardware such as cables and mounting hardware do not need to be pre-approved.

Used equipment will be acceptable provided the following conditions have been met:

- Equipment is listed on the current QPL.
- Equipment is in good working condition.
- Equipment is to remain the property of the contractor.

Ensure that software is licensed for use by the Department and by any other agency responsible for maintaining or operating the loop emulation system. Provide the Department with a license to duplicate and distribute the software as necessary for design and maintenance support.

Design and furnish video imaging loop emulator detection systems that detect vehicles at signalized intersections by processing video images and providing detection outputs to the signal controller in real time (within 112 milliseconds of vehicle arrival).

Furnish all required camera sensor units, loop emulator processor units, hardware and software packages, cabling, poles, mast arms, harnesses, camera mounting assemblies, surge protection panels, grounding systems, messenger cable and all necessary hardware. Furnish systems that allow the display of detection zones superimposed on an image of the roadway on a Department-furnished monitor or laptop computer screen. Ensure detection zones can be defined and data entered using a simple keyboard or mouse and monitor, or using a laptop PC with software.

Provide design drawings showing design details and camera sensor unit locations for review and acceptance before installation. Provide mounting height and location requirements for camera sensor units on the design based on site survey. Design video imaging loop emulator detection systems with all necessary hardware. Indicate all necessary poles, spans, mast arms, luminaire arms, cables, camera mounting assemblies and hardware to achieve the required detection zones where Department owned poles are not adequate to locate the camera sensor units. Do not design for the installation of poles in medians.

Obtain the Engineer's approval before furnishing video imaging loop emulator detection systems. The contractor is responsible for the final design of video imaging loop emulator detection systems. Review and acceptance of the designs by the Department does not relieve the contractor from the responsibility to provide fully functional systems and to ensure that the required detection zones can be provided.

Provide the ability to program each detection call (input to the controller) with the following functions:

- Full Time Delay – Delay timer is active continuously,
- Normal Delay – Delay timer is inhibited when assigned phase is green (except when used with TS 2 and 170/2070L controllers),
- Extend – Call is extended for this amount of time after vehicle leaves detection area,
- Delay Call/Extend Call – This feature uses a combination of full time delay and extend time on the same detection call. Ensure operation is as follows: Vehicle calls are received after the delay timer times out. When a call is detected, it is held until the detection area is empty and the programmed extend time expires. If another vehicle enters the detection area before the extend timer times out, the call is held and the extend time is reset. When the extend timer times out, the delay timer has to expire before another vehicle call can be received.

Provide the ability to program each detection zone as one of the following functions:

- Presence detector,
- Directional presence detector,
- Pulse detector,

- Directional pulse detector.

Ensure previously defined detector zones and configurations can be edited.

Provide each individual system with all the necessary equipment to focus and zoom the camera lenses without the need to enter the camera enclosure.

Provide systems that allow for the placement of at least 8 detection zones within the combined field of view of a single camera sensor unit. Provide a minimum of 8 detection outputs per camera.

Provide detection zones that can be overlapped. Ensure systems reliably detect vehicles when the horizontal distance from the camera sensor unit to the detection zone area is less than ten times the mounting height of the sensor. Ensure systems detect vehicles in multiple travel lanes.

Ensure systems can detect vehicle presence within a 98 to 102 percent accuracy (up to 2 percent of the vehicles missed and up to 2 percent of false detection) for clear, dry, daylight conditions, a 96 to 105 percent accuracy (up to 4 percent of the vehicles missed and up to 5 percent false detection) for dawn and dusk conditions, and a 96 percent accuracy (up to 4 percent of the vehicles missed) for night and adverse conditions (fog, snow, rain, etc.) using standard sensor optics and in the absence of occlusion.

Repair and replace all failed components within 72 hours.

The Department may conduct field-testing to ensure the accuracy of completed video imaging loop emulator detection systems.

B. Loop Emulator System:

Furnish loop emulator systems that receive and simultaneously process information from camera sensor units, and provides detector outputs to signal controllers.

Ensure systems provide the following:

- Operate in a typical roadside environment and meet the environmental specifications and are fully compatible with NEMA TS 1, NEMA TS 2, or Type 170/2070L controllers and cabinets,
- provide a “fail-safe” mode whereby failure of one or more of the camera sensor units or power failure of the loop emulator system will cause constant calls to be placed on the affected vehicle detection outputs to the signal controller,
- provide compensation for minor camera movement of up to 2 percent of the field of view at 400 feet without falsely detecting vehicles,
- process the video at a minimum rate of 30 times per second,
- provide separate wired connectors inside the controller cabinet for video recording each camera,
- provide remote video monitoring with a minimum refresh rate at 1 frame per second over a standard dial-up telephone line,
- provide remote video detection monitoring.
- Furnish camera sensor units that comply with the following:
- have an output signal conforming to EIA RS-170 standard,

- have a nominal output impedance of 75 ohms,
- be immune to bright light sources, or have built in circuitry or protective devices to prevent damage to the sensor when pointed directly at strong light sources,
- be housed in a light colored environmental enclosure that is water proof and dust tight, and that conforms to NEMA-4 specifications or better,
- simultaneously monitor at least five travel lanes when placed at the proper mounting location with a zoom lens,
- have a sunshield attached to the environmental enclosure to minimize solar heating,
- meet FCC class B requirements for electromagnetic interference emissions,
- have a heater attached to the viewing window of the environmental enclosure to prevent ice and condensation in cold weather.

Where coaxial video cables and other cables are required between the camera sensor and other components located in the controller cabinet, furnish surge protection in the controller cabinet.

If furnishing coaxial communications cable comply with the following, as recommended by the approved loop emulator manufacturer:

- Number 20 AWG, solid bare copper conductor terminated with crimped-on BNC connectors (do not use BNC adapters) from the camera sensor to the signal controller cabinet.
- Number 22 AWG, stranded bare copper conductor terminated with crimped-on BNC connectors (do not use BNC adapters) from the camera sensor unit to the junction box, and within the signal controller cabinet.

Furnish power cable appropriately sized to meet the power requirements of the sensors. At a minimum, provide three conductor 120 VAC field power cable.

As determined during the site survey, furnish sensor junction boxes with nominal 6 x 10 x 6 inches dimensions at each sensor location. Provide terminal blocks and tie points for coaxial cable.

C. Video Imaging Loop Emulator System Support:

Furnish video imaging loop emulator systems with either a simple keyboard or a mouse with monitor and appropriate software, or with system software for use on department-owned laptop PCs. Ensure the system is Windows 2000 and Windows XP compatible.

Provide Windows 2000 and Windows XP compatible personal computer software, if needed, to provide remote video and video detection monitoring.

Ensure systems allow the user to edit previously defined detector configurations. When a vehicle is within a detection zone, provide for a change in color or intensity of the detection zone perimeter or other appropriate display changes on the Department-furnished monitor or laptop computer screen.

Provide cabling and interconnection hardware with 6-foot minimum length interconnection cable to interface with the system.

Provide all associated equipment manuals and documentation.

4.3. CONSTRUCTION METHODS

Arrange and conduct site surveys with the system manufacturer's representative and Department personnel to determine proper camera sensor unit selection and placement. Provide the Department at least 3 working days notice before conducting site surveys. Upon completion of the site surveys the Department will provide revised plans reflecting the findings of the site survey.

Before beginning work at locations requiring video imaging loop emulator detection systems, furnish system software. Upon activation of detection zones, provide detector configuration files. Ensure that up-to-date detection configuration files are furnished for various detection zone configurations that may be required for construction phasing.

Place into operation loop emulator detection systems. Configure loop emulator detection systems to achieve required detection in designated zones. Have a certified manufacturer's representative on site to supervise and assist with installation, set up, and testing of the system.

Install the necessary processing and communications equipment in the signal controller cabinet. Make all necessary modifications to install equipment, cabling harnesses, and camera sensor interface panels with surge suppression.

Perform modifications to camera sensor unit gain, sensitivity, and iris limits necessary to complete the installation.

Do not install camera sensor units on signal poles unless approved by the Engineer.

Install the necessary cables from each sensor to the signal controller cabinet along signal cabling routes. Install surge protection and terminate all cable conductors.

Relocate camera sensor units and reconfigure detection zones as necessary according to the plans for construction phases.

Provide at least 8 hours of training on the set up, operation, troubleshooting, and maintenance of the loop emulator detection system to a maximum of ten Department personnel. Arrange for training to be conducted by the manufacturer's representative at an approved site within the Division responsible for administration of the project. Thirty days before conducting training submit a detailed course curriculum, draft manuals and materials, and resumes. Obtain approval of the submittal before conducting the training. At least one week before beginning training, provide three sets of complete documentation necessary to maintain and operate the system. Do not perform training until installation of loop emulator detection systems is complete.

4.4. MEASUREMENT AND PAYMENT

Actual number of site surveys, arranged, conducted, and accepted.

Actual number of luminaire arms for video systems furnished, installed, and accepted.

Actual number of cameras without internal loop emulator processing units furnished, installed, and accepted.

Actual number of external loop emulator processing units furnished, installed, and accepted.

Actual number of camera sensor units relocated with detection zones reconfigured installed, and accepted.

No measurement will be made of video imaging loop emulator system support or training, power, and video cables, and trenching as these items will be considered incidental to furnishing and installing video imaging loop emulator detection systems.

Payment will be made under:

Site Survey	Each
Luminaire Arm for Video System	Each
Camera without Internal Loop Emulator Processing Unit.....	Each
External Loop Emulator Processing Unit	Each
Relocate Camera Sensor Unit	Each

5. TRAFFIC SIGNAL SUPPORTS

5.1. METAL TRAFFIC SIGNAL SUPPORTS – ALL POLES

A. General:

Furnish and install metal strain poles, grounding systems, and all necessary hardware. The work covered by this special provision includes requirements for the design, fabrication, and installation of both standard and custom/site specifically designed metal traffic signal supports and associated foundations.

Provide metal traffic signal support systems that contain no guy assemblies, struts, or stay braces. Provide designs of completed assemblies with hardware that equals or exceeds AASHTO *Standard Specifications for Structural Supports for Highway Signs, Luminaires and Traffic Signals* 6th Edition, 2013 (hereafter called 6th Edition AASHTO), including the latest interim specifications. Provide assemblies with a round or near-round (18 sides or more) cross-section, or a multi sided cross section with no less than six sides. The sides may be straight, convex, or concave.

Pole heights shown on signal plans are estimated from available data for bid purposes. Prior to furnishing metal signal poles, use field measurements and adjusted cross-sections to determine whether pole heights are sufficient to obtain required clearances. If pole heights are not sufficient, the Contractor should immediately notify the Engineer of the required revised pole heights.

Ensure that metal signal poles permit cables to be installed inside poles and any required mast arms. For holes in the poles and arms used to accommodate cables, provide full-circumference grommets. Arm flange plate wire access holes should be deburred, non grommeted, and oversized to fit around the 2” diameter grommeted shaft flange plate wire access hole.

After fabrication, have steel poles, required mast arms, and all parts used in the assembly hot-dip galvanized per section 1076. Design structural assemblies with weep holes large enough and properly located to drain molten zinc during the galvanization process. Provide hot-dip galvanizing on structures that meets or exceeds ASTM Standard A-123. Provide galvanizing on hardware that meets or exceeds ASTM Standard A-153. Ensure that threaded material is brushed and retapped as necessary after galvanizing. Perform repair of damaged galvanizing that complies with the following:

Repair of GalvanizingArticle 1076-7

Standard Drawings for Metal Poles are available that supplement these project special provisions. These drawings are located on the Department’s website:

<https://connect.ncdot.gov/resources/safety/pages/ITS-Design-Resources.aspx>

Comply with article 1098-1B of the *2018 STANDARD SPECIFICATIONS FOR ROADS & STRUCTURES*, hereinafter referred to as the *Standard Specifications* for submittal requirements. Furnish shop drawings for approval. Provide the copies of detailed shop drawings for each type of structure as summarized below. Ensure that shop drawings include material specifications for each component and identify welds by type and size on the detail drawing only, not in table format. **Do not release structures for fabrication until shop drawings have been approved by NCDOT.** Provide an itemized bill of materials for all structural components and associated connecting hardware on the drawings.

Comply with article 1098-1A of the *Standard Specifications* for Qualified Products List (QPL) submittals. All shop drawings must include project location description, signal inventory number(s) and a project number or work order number on the drawings.

Summary of information required for metal pole review submittal:

Item	Hardcopy Submittal	Electronic Submittal	Comments / Special Instructions
Sealed, Approved Signal Plan/Loading Diagram	1	1	All structure design information needs to reflect the latest approved signal plans
Custom Pole Shop Drawings	4 sets	1 set	Show NCDOT inventory number(s), contractor's name and relevant revision number in the title block. All drawings must have a unique <u>drawing</u> number for each project and identified for multiple pages.
Standard Pole Shop Drawings (from the QPL)	4 sets	1 set	Submit drawings on 11" x 17" format media. Show NCDOT inventory number(s), contractor's name and relevant revision number in the title block. All drawings must have a <u>unique drawing</u> number for each project and identified for multiple pages.
Structure Calculations	1 set	1 set	Not required for Standard QPL Poles
Standard Pole Foundation Drawings	1 set	1 set	Submit drawings on 11" x 17" format media. Submit a completed Standard Foundation Selection form for each pole using foundation table on Metal Pole Drawing M-8.
Custom Foundation Drawings	4 sets	1 set	Submit drawings on 11" x 17" format media. Show NCDOT inventory number(s), contractor's name and relevant revision number in the title block. All drawings must have a <u>unique drawing</u> number for each project and identified for multiple pages. If QPL Poles are used, include the corresponding QPL pole shop drawings with this submittal.

Foundation Calculations	1	1	<p>Submit copies of LPILE input, output, and pile tip deflection graph per Section 11.4 of this specification for each foundation.</p> <p>Not required for Standard QPL Poles</p>
Soil Boring Logs and Report	1	1	Report should include a location plan and a soil classification report including soil capacity, water level, hammer efficiency, soil bearing pressure, soil density, etc. for each pole.

NOTE – All shop drawings and custom foundation design drawings must be sealed by a Professional Engineer licensed in the state of North Carolina. All geotechnical information must be sealed by either a Professional Engineer or geologist licensed in the state of North Carolina. Include a title block and revision block on the shop drawings and foundation drawings showing the NCDOT inventory number.

Shop drawings and foundation drawings may be submitted together or separately for approval. However, shop drawings must be approved before foundations can be reviewed. Foundation designs will be returned without review if the associated shop drawing has not been approved. Boring reports should include the following: Engineer’s summary, boring location maps, soil classification per AASHTO Classification System, hammer efficiency, and Metal Pole Standard Foundation Selection Form. Incomplete submittals will be returned without review. The Reviewer has the right to request additional analysis and copies of the calculations to expedite the approval process.

B. Materials:

Fabricate metal pole and arm shaft from coil or plate steel to meet the requirements of ASTM A 595 Grade A tubes. For structural steel shapes, plates and bars use A572 Gr 50 min or ASTM A709 Gr 50 min. Provide pole and arm shafts that are round in cross section or multisided tubular shapes and have a uniform linear taper of 0.14 in/ft. Construct shafts from one piece of single ply plate or coil so there are no circumferential weld splices. Galvanize in accordance with AASHTO M 111 or an approved equivalent.

Use the submerged arc process or other NCDOT previously approved process suitable for pole shaft and arms to continuously weld pole shafts and arm shafts along their entire length. The longitudinal seam weld will be finished flush to the outside contour of the base metal. Ensure shafts have no circumferential welds except at the lower end joining the shaft to the pole base and arm base. Use full penetration groove welds with backing ring for all tube-to-transverse-plate connections in accordance with 6th Edition AASHTO. Provide welding that conforms to Article 1072-18 of the *Standard Specifications*, except that no field welding on any part of the pole will be permitted unless approved by a qualified engineer.

Refer to Metal Pole Standard Drawing Sheets M2 through M5 for fabrication details. Fabricate anchor bases and mast arm connecting plates from plate steel meeting, as a minimum, the requirements of ASTM A572 Gr 50, AASHTO M270 Gr 50, ASTM A709 Gr50, or an approved equivalent. Conform to the applicable bolt pattern and orientation as shown on Metal Pole Standard Drawing Sheet M2.

Ensure all hardware is galvanized steel or stainless steel. The Contractor is responsible for ensuring that the designer/fabricator specifies connecting hardware and/or materials that do not create a dissimilar metal corrosive reaction.

Provide a minimum of four (4) 1-1/2" diameter high strength bolts for connection between arm plate and pole plate. Increase number of bolts to six (6) 1-1/2" diameter high strength bolts when arm lengths are greater than 50'-0" long.

Unless otherwise required by the design, ensure each anchor rod is 2" diameter and 60" length. Provide 10" minimum thread projection at the top of the rod, and 8" minimum at the bottom of the rod. Use anchor rod assembly and drilled pier foundation materials that meet the *Foundations and Anchor Rod Assemblies for Metal Poles* provision.

For each structural bolt and other steel hardware, hot dip galvanizing shall conform to the requirements of AASHTO M 232 (ASTM A 153). Ensure end caps for poles or mast arms are constructed of cast aluminum conforming to Aluminum Alloy 356.0F.

Provide a circular anchor bolt lock plate that will be secured to the anchor bolts at the embedded end with 2 washers and 2 nuts. Provide a base plate template that matches the bolt circle diameter of the anchor bolt lock plate. Construct plates and templates from 1/4" minimum thick steel with a minimum width of 4". Galvanizing is not required for both plates.

Provide 4 heavy hex nuts and 4 flat washers for each anchor bolt. For nuts, use AASHTO M291 grade 2H, DH, or DH3 or equivalent material. For flat washers, use AASHTO M293 or equivalent material.

C. Construction Methods:

Erect signal support poles only after concrete has attained a minimum allowable compressive strength of 3000 psi. Install anchor rod assemblies in accordance with the *Foundations and Anchor Rod Assemblies for Metal Poles* provision.

For further construction methods, see construction methods for Metal Strain Pole, or Metal Pole with Mast Arm.

Connect poles to grounding electrodes and bond them to the electrical service grounding electrodes.

For holes in the poles used to accommodate cables, install grommets before wiring pole or arm. Do not cut or split grommets.

Attach the terminal compartment cover to the pole by a sturdy chain or cable. Ensure the chain or cable is long enough to permit the cover to hang clear of the compartment opening when the cover is removed, and is strong enough to prevent vandalism. Ensure the chain or cable will not interfere with service to the cables in the pole base.

Attach cap to pole with a sturdy chain or cable. Ensure the chain or cable is long enough to permit the cap to hang clear of the opening when the cap is removed.

Perform repair of damaged galvanizing that complies with the *Standard Specifications*, Article 1076-7 "Repair of Galvanizing."

Install galvanized wire mesh around the perimeter of the base plate to cover the gap between the base plate and top of foundation for debris and pest control.

Install a 1/4" thick plate for concrete foundation tag to include: concrete grade, depth, diameter, and reinforcement sizes of the installed foundation.

5.2. METAL POLE UPRIGHTS (VERTICAL MEMBERS)

A. Materials:

- Provide tapered tubular shafts and fabricated of steel conforming to ASTM A-595 Grade A or an approved equivalent.
- Hot-dip galvanize poles in accordance with AASHTO M 111 or an approved equivalent.
- Have shafts that are continuously welded for the entire length by the submerged arc process, and with exposed welds ground or rolled smooth and flush with the base metal. Provide welding that conforms to Article 1072-18 of the *Standard Specification* except that no field welding on any part of the pole will be permitted.
- Have Shafts with no circumferential welds except at the lower end joining the shaft to the base.
- Have anchor bases for steel poles fabricated from plate steel meeting as a minimum the requirements of ASTM A572 Gr 50, AASHTO M270 Gr 50, ASTM A709 Gr 50, or an approved equivalent.

Provide a grounding lug(s) in the approximate vicinity of the messenger cable clamp for bonding and grounding messenger cable. Lugs must accept #4 or #6 AWG wire to bond messenger cables to the pole in order to provide an effective ground fault circuit path. Refer to Metal Pole Standard Drawing Sheet M6 for construction details.

Have poles permanently stamped above the hand holes with the identification tag details as shown on Metal Pole Standard Drawing Sheet M2.

Provide liquid tight flexible metal conduit (Type LFMC), liquid tight flexible nonmetallic conduit (Type LFNC), high density polyethylene conduit (Type HDPE), or approved equivalent to isolate conductors feeding luminaires.

Fabricate poles from a single piece of steel or aluminum with single line seam weld with no transverse butt welds. Fabrication of two ply pole shafts is unacceptable with the exception of fluted shafts. Provide tapers for all shafts that begin at base and that have diameters which decrease uniformly at the rate of not more than 0.14 inch per foot (11.7 millimeters per meter) of length.

Provide four anchor nuts and four washers for each anchor bolt. Ensure that anchor bolts have required diameters, lengths, and positions, and will develop strengths comparable to their respective poles.

Provide a terminal compartment with cover and screws in each pole that encompasses the hand hole and contains a 12-terminal barrier type terminal block. Provide two terminal screws with a removable shorting bar between them for each termination. Furnish terminal compartment covers attached to the pole by a sturdy chain or cable approved by the Engineer. Ensure that the chain or cable is long enough to permit the cover to hang clear of the compartment opening when the cover is removed, and is strong enough to prevent vandals from being able to disconnect the cover from the pole. Ensure that the chain or cable will not interfere with service to the cables in the pole base.

Install grounding lugs that will accept #4 or #6 AWG wire to electrically bond messenger cables to the pole. Refer to Metal Pole Standard Drawing Sheet M6 for construction details.

For each pole, provide a 1/2-inch minimum thread diameter, coarse thread stud and nut for grounding which will accommodate #6 AWG ground wire. Ensure that the lug is electrically bonded to the pole and is conveniently located inside the pole at the hand hole.

Provide a removable pole cap with stainless steel attachment screws for the top of each pole. Ensure that the cap is cast aluminum conforming to Aluminum Association Alloy 356.0F. Furnish cap attached to the pole with a sturdy chain or cable approved by the Engineer. Ensure that the chain or cable is long enough to permit the cap to hang clear of the pole-top opening when the cap is removed.

When required by the plans, furnish couplings 42 inches above the bottom of the base for mounting of pedestrian pushbuttons. Provide mounting points consisting of 1-1/2 inch internally threaded half-couplings that comply with the NEC and that are mounted within the poles. Ensure that couplings are essentially flush with the outside surfaces of the poles and are installed before any required galvanizing. Provide a threaded plug in each mounting point. Ensure that the surface of the plug is essentially flush with the outer end of the mounting point when installed and has a recessed hole to accommodate a standard wrench.

1. Strain Pole Shafts

Provide 2 messenger cable (span wire) clamps and associated hardware for attachment of messenger cable. Ensure that diameter of the clamp is appropriate to its location on the pole and is appropriately designed to be adjustable from 1'-6" below the top, down to 6'-6" below the top of the pole. Do not attach more than one support cable to a messenger cable clamp.

Provide a minimum of three (3) 2-inch (50 mm) holes equipped with an associated coupling and weatherhead on the messenger cable load side of the pole to accommodate passage of signal cables from inside the pole. Provide galvanized threaded plugs for all unused couplings at pole entrance points. Refer to Metal Pole Standard Drawing Sheet M3 for fabrication details.

Ensure that allowable pole deflection does not exceed that allowed per 6th Edition AASHTO. Ensure maximum deflection at the top of the pole does not exceed 2.5 percent of the pole height.

B. Construction Methods:

Install metal poles, hardware, and fittings as shown on the manufacturer's installation drawings. Install metal poles so that when the pole is fully loaded it is within 1 degree 40 minutes (1°40') of vertical. Install poles with the manufacturer's recommended "rake." Use threaded leveling nuts to establish rake if required.

5.3.DRILLED PIER FOUNDATIONS FOR METAL TRAFFIC SIGNAL POLES

Analysis procedures and formulas shall be based on AASHTO 6th Edition, latest ACI code and the *Drilled Shafts: Construction Procedures and Design Methods* FHWA-NHI-10-016 manual. Design methods based on engineering publications or research papers needs to have prior approval from NCDOT. The Department reserves the right to accept or disapprove any method used for the analysis.

Use a Factor of Safety of 1.33 for torsion and 2.0 for bending for the foundation design.

Foundation design for lateral load shall not exceed 1" lateral deflection at top of foundation.

For lateral analysis, use LPILE Plus V6.0 or later. Inputs, results, and corresponding graphs are to be submitted with the design calculations.

Skin Friction is to be calculated using the α -method for cohesive soils and the β -method for cohesion-less soils (**Broms method will not be accepted**). Detailed descriptions of the “ α ” and “ β ” methods can be found in *FHWA-NHI-10-016*.

Omit first 2.5ft for cohesive soils when calculating skin friction.

When hammer efficiency is not provided, assume a value of 0.70.

Design all custom foundations to carry the maximum capacity of each metal pole. For standard case strain poles only, if a custom foundation is designed, use the actual shear, axial and moment reactions from the Standard Foundation Selection Table shown on Standard Drawing No. M8.

When poor soil conditions are encountered which could create an excessively large foundation design, consideration may be given to allowing an exemption to the maximum capacity design. The contractor must gain approval from the engineer before reducing a foundation’s capacity. On projects where poor soil is known to be present, it is advisable that the contractor consider getting foundations approved before releasing poles for fabrication.

Have the contractor notify the engineer if the proposed foundation is to be installed on a slope other than 8H: 1V or flatter.

A. Description:

Furnish and install foundations for NCDOT metal poles with all necessary hardware in accordance with the plans and specifications.

Metal Pole Standards have been developed and implemented by NCDOT for use at signalized intersections in North Carolina. If the plans call for a standard pole, then a standard foundation may be selected from the plans. However, the Contractor is not required to use a standard foundation. If the Contractor chooses to design a non-standard site-specific foundation for a standard pole or if the plans call for a non-standard site-specific pole, design the foundation to conform to the applicable provisions in the NCDOT Metal Pole Standard Drawings and Section B7 (Non-Standard Foundation Design) below. If non-standard site-specific foundations are designed for standard QPL approved strain poles, the foundation designer must use the design moment specified by load case on Metal Pole Standard Drawing Sheet M8. Failure to conform to this requirement will be grounds for rejection of the design.

If the Contractor chooses to design a non-standard foundation for a standard pole and the soil test results indicate a standard foundation is feasible for the site, the Contractor will be paid the cost of the standard foundation (drilled pier and wing wall, if applicable). Any additional costs associated with a non-standard site-specific foundation including additional materials, labor and equipment will be considered incidental to the cost of the standard foundation. All costs for the non-standard foundation design will also be considered incidental to the cost of the standard foundation.

B. Soil Test and Foundation Determination:

1. General:

Drilled piers are reinforced concrete sections, cast-in-place against in situ, undisturbed material. Drilled piers are of straight shaft type and vertical.

Some standard drilled piers for supporting poles with mast arms may require wing walls to resist torsional rotation. Based upon this provision and the results of the required soil test, a drilled pier length and wing wall requirement may be determined and constructed in accordance with the plans.

For non-standard site-specific poles, the contractor-selected pole fabricator will determine if the addition of wing walls is necessary for the supporting foundations.

2. Soil Test:

Perform a soil test at each proposed metal pole location. Complete all required fill placement and excavation at each signal pole location to finished grade before drilling each boring. Soil tests performed that are not in compliance with this requirement may be rejected and will not be paid. Drill one boring to a depth of 26 feet within a 25-foot radius of each proposed foundation.

Perform standard penetration tests (SPT) in accordance with ASTM D 1586 at depths of 1, 2.5, 5, 7.5, 10, 15, 20 and 26 feet. Discontinue the boring if one of the following occurs:

- A total of 100 blows have been applied in any 2 consecutive 6-in. intervals.
- A total of 50 blows have been applied with < 3-in. penetration.

Describe each intersection as the “Intersection of (Route or SR #), (Street Name) and (Route or SR #), (Street Name), _____ County, Signal Inventory No. _____”. Label borings with “B- N, S, E, W, NE, NW, SE or SW” corresponding to the quadrant location within the intersection. Pole numbers should be made available to the Drill Contractor. Include pole numbers in the boring label if they are available. If they are not available, ensure the boring labels can be cross-referenced to corresponding pole numbers. For each boring, submit a legible (hand written or typed) boring log signed and sealed by a licensed Geologist or Professional Engineer registered in North Carolina. Include on each boring the SPT blow counts and N-values at each depth, depth of the boring, hammer efficiency, depth of water table and a general description of the soil types encountered using the AASHTO Classification System.

3. Standard Foundation Determination:

Use the following method for determining the Design N-value:

$$N_{AVG} = \frac{(N@1' + N@2.5' + \dots + N@Deepest\ Boring\ Depth)}{\text{Total Number of N-values}}$$

$$Y = (N@1')^2 + (N@2.5')^2 + \dots + (N@Deepest\ Boring\ Depth)^2$$

$$Z = (N@1' + N@2.5' + \dots + N@Deepest\ Boring\ Depth)$$

$$N_{STD\ DEV} = \left[\frac{(\text{Total Number of N-values} \times Y) - Z^2}{(\text{Total Number of N-values}) \times (\text{Total Number of N-values} - 1)} \right]^{0.5}$$

Design N-value equals lesser of the following two conditions:

$$N_{AVG} - (N_{STD\ DEV} \times 0.45)$$

Or

$$\text{Average of First Four N-Values} = \frac{(N@1' + N@2.5' + N@5' + N@7.5')}{4}$$

Note: If less than 4 N-values are obtained because of criteria listed in Section 2 above, use average of N-values collected for second condition. Do not include the N-value at the deepest boring depth for above calculations if the boring is discontinued at or before the required boring depth because of criteria listed in Section 2 above. Use N-value of zero for weight of hammer or weight of rod. If N-value is greater than 50, reduce N-value to 50 for calculations.

If standard NCDOT strain poles are shown on the plans and the Contractor chooses to use standard foundations, determine a drilled pier length, "L," for each signal pole from the Standard Foundations Chart (sheet M 8) based on the Design N-value and the predominant soil type. For each standard pole location, submit a completed "Metal Pole Standard Foundation Selection Form" signed by the Contractor's representative. Signature on form is for verification purposes only. Include the Design N-value calculation and resulting drilled pier length, "L," on each form.

If non-standard site-specific poles are shown on the plans, submit completed boring logs collected in accordance with Section 2 (Soil Test) above along with pole loading diagrams from the plans to the contractor-selected pole fabricator to assist in the pole and foundation design.

If one of the following occurs, the Standard Foundations Chart shown on the plans may not be used and a non-standard foundation may be required. In such case, contact the Engineer.

- The Design N-value is less than 4.
- The drilled pier length, "L", determined from the Standard Foundations Chart, is greater than the depth of the corresponding boring.

In the case where a standard foundation cannot be used, the Department will be responsible for the additional cost of the non-standard foundation.

Foundation designs are based on level ground around the traffic signal pole. If the slope around the edge of the drilled pier is steeper than 8:1 (H:V) or the proposed foundation will be less than 10 feet from the top of an embankment slope, the Contractor is responsible for providing slope information to the foundation designer and to the Engineer, so it can be considered in the design.

The "Metal Pole Standard Foundation Selection Form" may be found at:

<http://www.ncdot.gov/doh/preconstruct/highway/geotech/formdet/misc/MetalPole.pdf>

If assistance is needed, contact the Engineer.

4. Non-Standard Foundation Design:

Design non-standard foundations based upon site-specific soil test information collected in accordance with Section 2 (Soil Test) above. Design drilled piers for side resistance only in accordance with Section 4.6 of the *AASHTO Standard Specifications for Highway Bridges*. Use the computer software LPILE version-6.0 or later manufactured by Ensoft, Inc. to analyze drilled piers. Use the computer software gINT V8i or later manufactured by Bentley Systems, Inc. with the current NCDOT gINT library and data template to produce SPT boring logs. Provide a drilled pier foundation for each pole with a length and diameter that result in a horizontal lateral movement of less than 1 inch at the top of the pier and a horizontal rotational movement of less than 1 inch at the edge of the pier. Contact the Engineer for pole loading diagrams for standard poles to be used for non-standard foundation designs. Submit any non-standard foundation designs including drawings, calculations, and soil boring logs to the Engineer for review and approval before construction.

C. Drilled Pier Construction:

Construct drilled pier foundations in accordance with the *Foundations and Anchor Rod Assemblies for Metal Poles* provision.

5.4. METAL SIGNAL POLE REMOVALS**A. Description:**

Remove and dispose of existing metal signal poles, and remove and dispose of existing foundations, associated anchor bolts, electrical wires, and connections.

B. Construction Methods:**1. Foundations:**

Remove and promptly dispose of the metal signal pole foundations including reinforcing steel, electrical wires, and anchor bolts to a minimum depth of two feet below the finished ground elevation. At the Contractor's option, remove the complete foundation.

2. Metal Poles:

Assume ownership of the metal signal poles, remove the metal signal poles, and promptly transport the metal signal poles from the project. Use methods to remove the metal signal poles and attached traffic signal equipment that will not result in damage to other portions of the project or facility. Repair damages that are a result of the Contractor's actions at no additional cost to the Department.

Transport and properly dispose of the materials.

Backfill and compact disturbed areas to match the finished ground elevation. Seed unpaved areas.

Use methods to remove the foundations that will not result in damage to other portions of the project or facility. Repair damages that are a result of the Contractor's actions at no cost to the Department.

5.5. POLE NUMBERING SYSTEM**A. New Poles**

Attach an identification tag to each pole shaft and mast arm section as shown on Metal Pole Standard Drawing Sheet M2 "Typical Fabrication Details Common To All Metal Poles".

5.6. MEASUREMENT AND PAYMENT

Actual number of metal strain signal poles (without regard to height or load capacity) furnished, installed, and accepted.

Actual number of soil tests with SPT borings drilled furnished and accepted.

Actual volume of concrete poured in cubic yards of drilled pier foundation furnished, installed, and accepted.

Actual number of metal signal pole foundations removed and disposed.

Actual number of metal signal poles removed and disposed.

No measurement will be made for foundation designs prepared with metal pole designs, as these will be considered incidental to designing signal support structures.

Payment will be made under:

Metal Strain Signal Pole	Each
Soil Test	Each
Drilled Pier Foundation.....	Cubic Yard
Metal Pole Foundation Removal	Each
Metal Pole Removal.....	Each

6. ETHERNET EDGE SWITCH

Furnish and install a managed Ethernet edge switch as specified below that is fully compatible, interoperable, and completely interchangeable and functional within the existing City or Division traffic signal system communications network.

6.1. DESCRIPTION

A. Ethernet Edge Switch:

Furnish and install a hardened, field Ethernet edge switch (hereafter “edge switch”) for traffic signal controllers as specified below. Install an Ethernet edge switch in all new cabinets and furnish an Ethernet edge switch for each spare cabinet. Ensure that the edge switch provides wire-speed, fast Ethernet connectivity at transmission rates of 100 megabits per second from each remote ITS device location to the routing switches.

Contact the City or Division to arrange for the programming of the new Field Ethernet Switches with the necessary network configuration data, including but not limited to, the Project IP Address, Default Gateway, Subnet Mask and VLAN ID information. Provide a minimum five (5) days working notice to allow the City or Division to program the new devices.

B. Network Management:

Ensure that the edge switch is fully compatible with the City’s or Division’s existing Network Management Software.

6.2. MATERIALS

A. General:

Ensure that the edge switch is fully compatible and interoperable with the trunk Ethernet network interface and that the edge switch supports half and full duplex Ethernet communications.

Furnish an edge switch that provide 99.999% error-free operation, and that complies with the Electronic Industries Alliance (EIA) Ethernet data communication requirements using single-mode fiber-optic transmission medium and copper transmission medium. Ensure that the edge switch has a minimum mean time between failures (MTBF) of 10 years, or 87,600 hours, as calculated using the Bellcore/Telcordia SR-332 standard for reliability prediction.

B. Compatibility Acceptance

The Engineer has the authority to require the Contractor to submit a sample Field Ethernet Switch and Field Ethernet Transceiver along with all supporting documentation, software, and testing procedures to allow a compatibility acceptance test to be performed prior to approving the

proposed Field Ethernet Switch and Field Ethernet Transceiver for deployment. **The Compatibility Acceptance testing will ensure that the proposed device is 100% compatible and interoperable with the existing City Signal System network, monitoring software and Traffic Operations Center network hardware.** Allow fifteen (15) working days for the Compatibility Acceptance Testing to be performed

C. Standards:

Ensure that the edge switch complies with all applicable IEEE networking standards for Ethernet communications, including but not limited to:

- IEEE 802.1D standard for media access control (MAC) bridges used with the Spanning Tree Protocol (STP);
- IEEE 802.1Q standard for port-based virtual local area networks (VLANs);
- IEEE 802.1P standard for Quality of Service (QoS);
- IEEE 802.1w standard for MAC bridges used with the Rapid Spanning Tree Protocol (RSTP);
- IEEE 802.1s standard for MAC bridges used with the Multiple Spanning Tree Protocol;
- IEEE 802.1x standard for port based network access control, including RADIUS;
- IEEE 802.3 standard for local area network (LAN) and metropolitan area network (MAN) access and physical layer specifications;
- IEEE 802.3u supplement standard regarding 100 Base TX/100 Base FX;
- IEEE 802.3x standard regarding flow control with full duplex operation; and
- IFC 2236 regarding IGMP v2 compliance.
- IEEE 802.1AB Link Layer Discovery Protocol (LLDP)
- IEEE 802.3ad Ethernet Link Aggregation
- IEEE 802.3i for 10BASE-T (10 Mbit/s over Fiber-Optic)
- IEEE 802.3ab for 1000BASE-T (1Gbit/s over Ethernet)
- IEEE 802.3z for 1000BASE-X (1 Gbit/s Ethernet over Fiber-Optic)

D. Functional:

Ensure that the edge switch supports all Layer 2 management features and certain Layer 3 features related to multicast data transmission and routing. These features shall include, but not be limited to:

- An STP healing/convergence rate that meets or exceeds specifications published in the IEEE 802.1D standard.
- An RSTP healing/convergence rate that meets or exceeds specifications published in the IEEE 802.1w standard.

- An Ethernet edge switch that is a port-based VLAN and supports VLAN tagging that meets or exceeds specifications as published in the IEEE 802.1Q standard, and has a minimum 4-kilobit VLAN address table (254 simultaneous).
- A forwarding/filtering rate that is a minimum of 14,880 packets per second for 10 megabits per second and 148,800 packets per second for 100 megabits per second.
- A minimum 4-kilobit MAC address table.
- Support of Traffic Class Expediting and Dynamic Multicast Filtering.
- Support of, at a minimum, snooping of Version 2 & 3 of the Internet Group Management Protocol (IGMP).
- Support of remote and local setup and management via telnet or secure Web-based GUI and command line interfaces.
- Support of the Simple Network Management Protocol version 3 (SNMPv3). Verify that the Ethernet edge switch can be accessed using the resident EIA-232 management port, a telecommunication network, or the Trivial File Transfer Protocol (TFTP).
- Port security through controlling access by the users. Ensure that the Ethernet edge switch has the capability to generate an alarm and shut down ports when an unauthorized user accesses the network.
- Support of remote monitoring (RMON-1 & RMON-2) of the Ethernet agent.
- Support of the TFTP and SNTP. Ensure that the Ethernet edge switch supports port mirroring for troubleshooting purposes when combined with a network analyzer.

E. Physical Features:

Ports: Provide 10/100/1000 Mbps auto-negotiating ports (RJ-45) copper Fast Ethernet ports for all edge switches. Provide auto-negotiation circuitry that will automatically negotiate the highest possible data rate and duplex operation possible with attached devices supporting the IEEE 802.3 Clause 28 auto-negotiation standard.

Optical Ports: Ensure that all fiber-optic link ports operate at 1310 or 1550 nanometers in single mode. Provide Type LC connectors for the optical ports, as specified in the Plans or by the Engineer. Do not use mechanical transfer registered jack (MTRJ) type connectors.

Provide an edge switch having a minimum of two optical 100/1000 Base X ports capable of transmitting data at 100/1000 megabits per second. Ensure that each optical port consists of a pair of fibers; one fiber will transmit (TX) data and one fiber will receive (RX) data. Ensure that the optical ports have an optical power budget of at least 15 dB.

Copper Ports: Provide an edge switch that includes a minimum of four copper ports. Provide Type RJ-45 copper ports and that auto-negotiate speed (i.e., 10/100/1000 Base) and duplex (i.e., full or half). Ensure that all 10/100/1000 Base TX ports meet the specifications detailed in this section and are compliant with the IEEE 802.3 standard pinouts. Ensure that all Category 5E unshielded twisted pair/shielded twisted pair network cables are compliant with the EIA/TIA-568-B standard.

Port Security: Ensure that the edge switch supports/complies with the following (remotely) minimum requirements:

- Ability to configure static MAC addresses access;
- Ability to disable automatic address learning per ports; know hereafter as Secure Port. Secure Ports only forward; and
- Trap and alarm upon any unauthorized MAC address and shutdown for programmable duration. Port shutdown requires administrator to manually reset the port before communications are allowed.

F. Management Capabilities:

Ensure that the edge switch supports all Layer 2 management features and certain Layer 3 features related to multicast data transmission and routing. These features shall include, but not be limited to:

- An STP healing/convergence rate that meets or exceeds specifications published in the IEEE 802.1 D standards;
- An RSTP healing/convergence rate that meets or exceeds specifications published in the IEEE 802.1w standard;
- An Ethernet edge switch that is a port-based VLAN and supports VLAN tagging that meets or exceeds specifications as published in the IEEE 802.1Q standard, and has a minimum 4-kilobit VLAN address table (254 simultaneous);
- A forwarding/filtering rate that is a minimum of 14,880 packets per second for 10 megabits per second, 148,800 packets per second for 100 megabits per second and 1,488,000 packets per second for 1000 megabits per second;
- A minimum 4-kilobit MAC address table;
- Support of Traffic Class Expediting and Dynamic Multicast Filtering.
- Support of, at a minimum, snooping of Version 2 & 3 of the Internet Group Management Protocol (IGMP);
- Support of remote and local setup and management via telnet or secure Web-based GUI and command line interfaces; and
- Support of the Simple Network Management Protocol (SNMP). Verify that the Ethernet edge switch can be accessed using the resident EIA-232 management port, a telecommunication network, or the Trivial File Transfer Protocol (TFTP).

Network Capabilities: Provide an edge switch that supports/complies with the following minimum requirements:

- Provide full implementation of IGMPv2 snooping (RFC 2236);
- Provide full implementation of SNMPv1, SNMPv2c, and/or SNMPv3;
- Provide support for the following RMON-I groups, at a minimum:
 - Part 1: Statistics
 - Part 2: History
 - Part 3: Alarm
 - Part 9: Event
- Provide support for the following RMON-2 groups, at a minimum:
 - Part 13: Address Map
 - Part 17: Layer Matrix

- Part 16: Layer Host - Part 18:User History
- Capable of mirroring any port to any other port within the switch;
- Meet the IEEE 802.1Q (VLAN) standard per port for up to four VLANs;
- Meet the IEEE 802.3ad (Port Trunking) standard for a minimum of two groups of four ports;
- Password manageable;
- Telnet/CLI;
- HTTP (Embedded Web Server) with Secure Sockets Layer (SSL); and
- Full implementation of RFC 783 (TFTP) to allow remote firmware upgrades.

Network Security: Provide an edge switch that supports/complies with the following (remotely) minimum network security requirements:

- Multi-level user passwords;
- RADIUS centralized password management (IEEE 802.1X);
- SNMPv3 encrypted authentication and access security;
- Port security through controlling access by the users: ensure that the Ethernet edge switch has the capability to generate an alarm and shut down ports when an unauthorized user accesses the network;
- Support of remote monitoring (RMON-1&2) of the Ethernet agent; and
- Support of the TFTP and SNTP. Ensure that the Ethernet edge switch supports port mirroring for troubleshooting purposes when combined with a network analyzer.

G. Electrical Specifications:

Ensure that the edge switch operates, and power is supplied with 115 volts of alternating current (VAC). Ensure that the edge switch has a minimum operating input of 110 VAC and a maximum operating input of 130 VAC. Ensure that if the device requires operating voltages other than 120 VAC, supply the required voltage converter. Ensure that the maximum power consumption does not exceed 50 watts. Ensure that the edge switch has diagnostic light emitting diodes (LEDs), including link, TX, RX, speed (for Category 5E ports only), and power LEDs.

H. Environmental Specifications:

Ensure that the edge switch performs all of the required functions during and after being subjected to an ambient operating temperature range of -30 degrees to 165 degrees Fahrenheit as defined in the environmental requirements section of the NEMA TS 2 standard, with a noncondensing humidity of 0 to 95%.

Provide certification that the device has successfully completed environmental testing as defined in the environmental requirements section of the NEMA TS 2 standard. Provide certification that the device meets the vibration and shock resistance requirements of Sections 2.1.9 and 2.1.10, respectively, of the NEMA TS 2 standard. Ensure that the edge switch is protected from rain, dust, corrosive elements, and typical conditions found in a roadside environment.

The edge switch shall meet or exceed the following environmental standards:

- IEEE 1613 (electric utility substations)
- IEC 61850-3 (electric utility substations)
- IEEE 61800-3 (variable speed drive systems)
- IEC 61000-6-2 (generic industrial)
- EMF – FCC Part 15 CISPR (EN5502) Class A

I. Ethernet Patch Cable:

Furnish a factory pre-terminated/pre-connectorized Ethernet patch cable with each edge switch. Furnish Ethernet patch cables meeting the following physical requirements:

- Five (5)-foot length
- Category 5e or better
- Factory-installed RJ-45 connectors on both ends
- Molded anti-snag hoods over connectors
- Gold plated connectors

Furnish Fast Ethernet patch cords meeting the following minimum performance requirements:

- TIA/EIA-568-B-5, Additional Transmission Performance Specifications for 4-pair 100 Ω Enhanced Category 5 Cabling
- Frequency Range: 1-100 MHz
- Near-End Crosstalk (NEXT): 30.1 dB
- Power-sum NEXT: 27.1 dB
- Attenuation to Crosstalk Ratio (ACR): 6.1 dB
- Power-sum ACR: 3.1 dB
- Return Loss: 10dB
- Propagation Delay: 548 nsec

6.3. CONSTRUCTION METHODS

A. General:

Ensure that the edge switch is UL listed.

Verify that network/field/data patch cords meet all ANSI/EIA/TIA requirements for Category 5E and Category 6 four-pair unshielded twisted pair cabling with stranded conductors and RJ45 connectors.

Contact the Signal Shop a minimum of 5 days prior to installation for the most current edge switch IP Address, VLAN, subnet mask, default gateway and configuration files.

B. Edge Switch:

Mount the edge switch inside each field cabinet by securely fastening the edge switch to the upper end of the right rear vertical rail of the equipment rack using manufacturer-recommended or Engineer-approved attachment methods, attachment hardware and fasteners.

Ensure that the edge switch is mounted securely in the cabinet and is fully accessible by field technicians without blocking access to other equipment. Verify that fiber-optic jumpers consist of a length of cable that has connectors on both ends, primarily used for interconnecting termination or patching facilities and/or equipment.

6.4. MEASUREMENT AND PAYMENT

Ethernet edge switch will be measured and paid as the actual number of Ethernet edge switches furnished, installed, and accepted.

No separate measurement will be made for Ethernet patch cable, power cord, mounting hardware, nuts, bolts, brackets, or edge switch programming as these will be considered incidental to furnishing and installing the edge switch.

Payment will be made under:

Ethernet Edge Switch.....Each

7. DMS ELECTRICAL SERVICE

7.1. DESCRIPTION

At locations called out in the Plans, install a new electrical service for the new DMS installation, consisting of a new meter base combination panel with main disconnect and separate disconnects for the equipment feeder conductors.

Comply with the National Electrical Code (NEC), the National Electrical Safety Code (NESC), the *Standard Specifications*, these Project Special Provisions, and all local ordinances. Coordinate all work involving electrical service with the appropriate utility company and the Engineer.

7.2. MATERIALS

A. Electrical Service

Provide material, equipment and hardware under this section that is pre-approved on the 2018 ITS and Signals QPL by the date of equipment installation.

Provide all materials necessary to form a complete electrical service assembly as shown in the Plans. Furnish new electrical service disconnects, meter bases, and required grounding. Install new feeder conductors in conduits between the meter service and equipment cabinets as required.

Furnish a NEMA 3R combination panel rated for a minimum of 200 Ampere minimum for underground service entrances that meets the requirements of the local utility. Provide meter base with ampere rating of meter sockets based on sockets being wired with insulated wire rated at least 167°F. Ensure the assembly is marked as being suitable for use as service equipment. Ensure combination meter and disconnect mounted in a pedestal for underground service is listed as meeting UL Standard UL-231. Otherwise, ensure combination meter and disconnect is listed as meeting UL Standard UL-67.

Furnish 4 terminal, 600 volt, single phase, 3 wire meter base that complies with the following:

- Line, Load, and Neutral Terminals accept #8 to 4/0 AWG copper/aluminum wire;
- Ringed or Ringless Type, with or without bypass;
- Made of galvanized steel;
- Listed as meeting UL Standard UL-414; and
- Overhead or underground service entrance as specified.

Provide electrical service enclosures, meter bases, disconnect panels, combination panel enclosures and pedestals with electrostatically applied dry powder paint finish with minimum thickness of 2.4 mils and that is light gray in color. All exterior surfaces must be powder coated steel. Provide combination panels with pedestals of sufficient length to attain a minimum embedment depth of 24 inches below grade when installed per the manufacturer's instructions. With each meter base, provide a blank meter socket cover made from UV stabilized polycarbonate or metal and that is either clear or gray in color to prevent access to interior of meter base until meter is installed by the local power company.

Ensure all circuits breakers are rated for at least 10,000 RMS symmetrical amperes short circuit current rating in a lockable NEMA 3R enclosure. Obtain a calculated Arc-Fault current rating value from the electrical company and ensure the supplied breakers comply with the calculated Arc-Fault current rating per the National Electrical Code. Provide new meter base/disconnect combination panels that have a minimum of eight (8) spaces in the disconnect.

Provide a main circuit breaker rated for a minimum of 150 Amperes and for the circuit breaker servicing the DMS Structure provide a 50 Ampere Double Pole Breaker. Ensure equipment cabinet disconnects are listed as meeting UL Standard UL-489 and marked as being suitable for use as service disconnects.

For the DMS, furnish 4-wire stranded copper #8 AWG feeder conductors with THWN rating for supplying power to the DMS equipment cabinet. Provide conductor with the following:

- Listed as meeting UL Standard UL-83
- Meets ASTM B-3 and B-8 or B-787 standards.

Furnish 1" rigid galvanized conduit between the Service Disconnect and the collocated junction box. Transition to 2" HDPE conduit between junction boxes where the conduit will be installed under the roadway to a 2nd junction box. The the 2nd junction box transition back to 1" rigid galvanized conduit to the Supplemental Equipment Cabinet Disconnect.

Provide a grounding electrode system at all new electrical services. Provide underground marker tape above ground grounding electrodes and buried ground wire. Provide all grounding electrodes and ground wire necessary to ensure that grounding system, whether existing or new, complies with all grounding requirements of these Project Special Provisions.

B. Supplemental Equipment Cabinet Disconnect

Furnish a Supplemental Equipment Cabinet Disconnect for the DMS installation since the service and cabinet are separated by a roadway. Furnish a Supplemental Equipment Cabinet Disconnect that will accommodate a minimum of 8 breakers in a lockable NEMA 3R enclosure. Fabricate enclosure from galvanized steel and electrostatically apply dry powder paint finish, light gray in color, to yield a minimum thickness of 2.4 mils. All exterior surfaces must be powder coated

steel. Provide ground bus and neutral bus with a minimum of four terminals and a minimum wire capacity range of number 8 through number 2 AWG.

Install a 50 Ampere Double Pole circuit breaker rated for the calculated Arc-Fault Current. Mount the Supplemental Equipment Cabinet Disconnect on the pedestal close to the equipment cabinet. Ensure equipment cabinet disconnects are listed as meeting UL Standard UL-489 and marked as being suitable for use as service disconnects.

C. Grounding Electrodes (Ground Rods)

Furnish 5/8"x10' copper clad steel grounding electrodes (ground rods), #4 AWG solid bare copper conductors, to make the grounding system installations. Secure the Copper conductor to the ground rod using an irreversible compression coupling using a ratcheting compression tool. Comply with the NEC, the *Standard Specifications*, these Project Special Provisions, and the Plans.

7.3. CONSTRUCTION METHODS

A. General

All work involving electrical service shall be coordinated with the appropriate electric utility company. Coordinate with the utility company to ascertain the feasibility of installing electrical service at each location before performing any work. Obtain all required local permits before beginning work.

Run feeder conductors separately from all other conductors in a 1-inch rigid galvanized conduit. Do not allow feeder conductors to share conduits with any other conductors or cables. Do not route unfused electrical feeder conductors inside of metal poles. Permanently label conductors at all access points using nylon tags labeled with permanent ink. Ensure each conductor has a unique identifier. Label conductors immediately upon installation. Use component name and labeling scheme approved by the Engineer.

Use rigid galvanized conduit for all underground conduit runs 10 feet or less in length. For underground runs greater than 10 feet in length, the Contractor may transition from 1" rigid galvanized conduit to 2" HDPE conduit for the remainder of the run.

Direct bury pedestals that support combination panel at a minimum embedment depth of 24 inches below grade.

Upon completion of electrical service installation and backfilling of all excavations, restore the disturbed ground to its original condition as determined and approved by the Engineer. For paved areas, replace removed or damaged pavement with in kind materials, matching the elevation, color, texture/finish, and general appearance of the surrounding pavement in accordance with the "Equipment Cabinet Foundation" section of these Project Special Provisions. For unpaved areas, backfill excavations with removed material, tamp the backfilled material and rake smooth the top 1½ inches. Finish unpaved areas flush with surrounding natural ground and to match the original contour of the ground. Seed with same type of grass as surrounding area and mulch the newly seeded area. If unpaved area was not grassed, replace the original ground cover in kind as directed by the Engineer.

Complete repairs to and restoration of all ground (paved and unpaved) disturbed for construction within five consecutive calendar days following initial removal. If the Contractor fails to repair and restore the ground in accordance with these Project Special Provisions within the time frame specified, the Department reserves the right to make the necessary repairs, and all

expenses incurred by the Department in making the repairs and restoring the ground will be deducted from payment due the Contractor.

Install meter socket covers on new meter bases to block access to the wiring inside until the meter is attached to the meter base by the power company. Use only approved meter socket covers that comply with these Project Special Provisions; do not use cardboard, paper, plywood, sheet plastic, tape, etc. to cover the meter socket opening. Do not leave a meter socket uncovered.

Provide all necessary stainless-steel banding hardware and clamps for securely attaching service disconnects, meter bases, combination panels and service conduits and risers to metal poles.

B. New Electrical Service for DMS

At locations identified in the Plans, install new electrical service for the DMS cabinet in accordance with the details shown in the Plans. Install a new electrical service comprised of an external service disconnect and a meter base with meter socket cover housed in a combination panel. After installation of the meter base with meter socket cover, the local power company will remove the socket cover and install a new meter and make any necessary connections to the power lines.

Unless the Plans indicate otherwise, have the power company route the service drop underground to combination panel, even where source power lines are overhead.

C. Grounding of Electrical Services

In addition to NEC requirements, test grounding electrode resistance for a maximum of 20 ohms. Furnish and install additional ground rods to grounding electrode system as necessary to meet test requirements. Furnish 5/8" x 10' copper clad steel grounding electrode system (ground rods), #4 AWG solid bare copper conductors, and an irreversible compression coupling for grounding system installations. Comply with NEC, the *Standard Specifications*, these Project Special Provisions, and the Plans.

Follow test equipment's procedures for measuring grounding electrode resistance. When using clamp-type ground resistance meters, readings of less than 1 ohm typically indicate a ground loop. Rework bonding and grounding circuits as necessary to remove ground loop circuits and retest. If a ground loop cannot be identified and removed to allow the proper use of a clamp-type ground resistance meter, use the three-point test method.

Submit a completed Inductive Loop & Grounding Test Form available on the Department's website at:

<https://connect.ncdot.gov/resources/safety/Pages/ITS-and-Signals.aspx>

Install a length of marker tape 6 to 12 inches below finished grade directly over grounding electrodes and conductors.

7.4. MEASUREMENT AND PAYMENT

DMS Electrical Service will be measured and paid for as the actual number of complete, functional DMS electrical service locations furnished, installed, and tested.

No measurement will be made of risers with weatherheads as they will be considered incidental to furnishing and installing a new DMS electrical service.

No measurement will be made of short risers (i.e., from disconnect to underground conduit and from underground conduit to bottom of cabinet), meter bases, meter socket covers, service

disconnects, additional circuit breakers in new service disconnects, underground conduit between service risers and disconnects/meters, conduit for feeder conductors between the service disconnect and the equipment cabinet, acquisition of service fees, feeder conductors, ground wire, grounding electrodes rods and any remaining hardware and conduit to connect the electrical service to the equipment cabinet as they will be considered incidental to furnishing and installing new electrical service.

No measurement will be made of restoration of unpaved ground surfaces with like materials, including but not limited to backfill, graded stone, seeding and mulching, as this work will be considered incidental to installation of a new electrical service.

Payment will be made under:

Pay Item	Pay Unit
DMS Electrical Service	Each
Equipment Cabinet Disconnect	Each

8. DIGITAL CCTV FIELD EQUIPMENT

8.1. DESCRIPTION

Furnish and install High Definition (1080p) CCTV field equipment described in these Project Special Provisions. Furnish equipment that is compatible, interoperable, and completely interchangeable with existing equipment currently in use by the Division. Ensure that the equipment is fully compatible with all features of the existing video management software currently in use by the Division.

8.2. MATERIAL

A. General

Furnish and install a new CCTV camera assembly at the location shown on the Plans. This assembly consists of the following:

1. Dome CCTV camera that contains in a single enclosed unit the following:

CCTV color digital signal processing camera unit with zoom lens, filter, control circuit, and accessories

2. Motorized pan, tilt, and zoom

All necessary cable, connectors, and incidental hardware to make a complete and operable system

Built-in video encoder capable of H.264/MPEG-4 compression for video-over-IP transmission.

Lightning arrestors installed in-line between the CCTV camera and the equipment cabinet components.

A NEMA Type 4 enclosure constructed of aluminum with a clear acrylic dome or approved equal Camera Unit housing.

B. Camera and Lens

Cameras

Furnish new Complementary Metal-Oxide-Semiconductor (CMOS) sensor-equipped color cameras. Furnish cameras that meet the following minimum requirements:

- Video format:NTSC compatible resolution, user selectable up to a maximum of 1920x1080 (1080p),
- Focus:Automatic with manual override, Electronic Image Stabilization (EIS),
- White balance:Automatic through the lens with manual override,
- Shutter:Electronic shutter with manual control from 1/2 of a second to 1/30,000th of a second,
- Overexposure protection:The camera must have built-in circuitry or a protection device to prevent any damage to the camera when pointed at strong light sources, including the sun,
- Sensitivity:0.6 lux at 90% scene reflectance
- Input/Output Connection:Single 10BASE-T/100BASE-T compatible outdoor-rated Cat5e cable for video, control, and Power over Ethernet; IP66-rated RJ45 connector,
- Power:High Power over Ethernet (High PoE), 74W max

Zoom Lens

Furnish each camera with a motorized zoom lens that is integrated in a high-performance dome system, or approved equivalent, with automatic iris control and manual override. Furnish lenses that meet the following optical specifications:

- Aperturef/1.6 – f/2.9,
- Focal length:.....4.45 mm (wide) and 89 mm (tele.), minimum,
- Horizontal viewing angle:.....55.4° (wide) and 2.9° (tele), minimum,
- Zoom.....30X optical, 12X digital, minimum
- Preset positioning:.....64 Presets, minimum.

The lens must be capable of both automatic and remote manual control iris and focus override operation. The lens must be equipped for remote control of zoom and focus, including automatic movement to any of the preset zoom and focus positions. Mechanical or electrical means must be provided to protect the motors from overrunning in extreme positions. The operating voltages of the lens must be compatible with the outputs of the camera control.

C. Camera Housing

Furnish new dome style enclosure for the CCTV assemblies. The enclosures must be equipped with a sunshield and a strip heater, and be fabricated from corrosion resistant aluminum and finished in a neutral color of weather resistant enamel. The enclosure must meet or exceed NEMA 4X and IP66 ratings. The viewing area of the enclosure must be constructed of clear acrylic, polycarbonate, or an approved equivalent.

Furnish removable dome enclosures that are secured to the camera housing using stainless steel set screws. Ensure that camera housing assembly is completely sealed with a rubber O-ring gasket to prevent dust and moisture intrusion.

Environmental Operating Conditions: -50°F to 122°F, 10-100% RH (condensing) humidity

D. Pan and Tilt Unit

Equip each new dome style assembly with a pan and tilt unit. The pan and tilt unit must be integral to the high performance integrated dome system. The pan and tilt unit must be rated for outdoor operation, provide dynamic braking for instantaneous stopping, prevent drift, and have minimum backlash. The pan and tilt units must meet or exceed the following specifications:

- Pan:Continuous 360 Degrees,
- Tilt:.....Up/down 180 degrees minimum,
- Motors:.....Two-phase induction type,
continuous duty, instantaneous
reversing,
- Preset Positioning:64 PTZ presets per camera.

E. Video Ethernet Encoder

Furnish cameras with a built-in digital video Ethernet encoder to allow video-over-IP transmission. The encoder units must be built into the camera housing and require no additional equipment to transmit encoded video over IP networks.

Encoders must have the following minimum features:

- Network Interface: Ethernet 10/100Base-T (RJ-45 connector)
- Protocols: IPv4, IPv6, HTTP, HTTPS, SSL, QoS, FTP, SMTP, UPnP, SNMP v2c/v3, DNS, NTP, RTSP, RTP, TCP, UDP, IGMP, and DHCP,
- Security: SSL, SSH, 802.1x, HTTPS encryption with password controlled browser interface
- Video Streams: 2 simultaneous streams, user configurable
- Compression: H.264 (MPEG-4 Part 10/AVC)

- Resolution Scalable; NTSC-compatible 320x176 to 1920x1080 (HDTV 1080p, 16:9 aspect ratio)
- Frame Rate: 1-30 FPS programmable (full motion)
- Bandwidth 30 kbps – 6 Mbps, configurable depending on resolution
- Edge Storage: SD/SDHC/SDXC slot supporting up to 64GB memory card

F. Ethernet Cable

Provide, at a minimum, Category 5 Enhanced (5e) Ethernet cable that complies with ANSI/TIA-568-B-5 standards for four-pair shielded twisted copper for Ethernet communications. The cable shall meet all of the mechanical requirements of ANSI/ECEA S-80-576. The Ethernet cable must be rated for medium-power, network-powered broadband communications circuits and must be Type BMU network-powered broadband communications medium-power cable.

Provide 4-pair twisted copper Ethernet cable and connectors rated for an ambient operating temperature range of -30° F to 165° F. The cable shall be shielded, outdoor-rated, and have a UV-resistant jacket. The void between the insulated copper pairs and the polyethylene outer jacket shall be injected with a water-resistant flooding compound.

G. Control Receiver/Driver

Provide each new camera unit with a control receiver/driver that is integral to the CCTV dome assembly. The control receiver/driver will receive serial asynchronous data initiated from a camera control unit, decode the command data, perform error checking, and drive the pan/tilt unit, camera controls, and motorized lens. As a minimum, the control receiver/drivers must provide the following functions:

- Zoom in/out
- Automatic focus with manual override
- Tilt up/down
- Automatic iris with manual override
- Pan right/left
- Minimum 64 preset positions for pan, tilt, and zoom

In addition, each control receiver/driver must accept status information from the pan/tilt unit and motorized lens for preset positioning of those components. The control receiver/driver will relay pan, tilt, zoom, and focus positions from the field to the remote camera control unit. The control receiver/driver must accept “goto” preset commands from the camera control unit, decode the command data, perform error checking, and drive the pan/tilt and motorized zoom lens to the correct preset position. The preset commands from the camera control unit will consist of unique values for the desired pan, tilt, zoom, and focus positions.

H. CCTV Camera Attachment to Pole

At locations shown in the Plans where new CCTV cameras are to be installed on a new pole, furnish an attachment assembly for the CCTV camera unit. Submit shop drawings for review and approval by the Engineer prior to installation.

Furnish CCTV attachments that allow for the removal and replacement of the CCTV enclosure as well as providing a weatherproof, weather tight, seal that does not allow moisture to enter the enclosure.

Furnish a CCTV Camera Attachment Assembly that is able to withstand wind loading at the maximum wind speed and gust factor called for in these Special Provisions and can support a minimum camera unit dead load of 45 pounds (20.4 kg).

I. Surge Suppression

Protect all equipment at the top of the pole with grounded metal oxide varistors connecting each power conductor to ground.

8.3. CONSTRUCTION METHOD

A. General

Mount the digital CCTV camera unit at 35 feet above ground level on the new CCTV metal poles (40'). Position the camera to enable viewing traffic in all directions and as approved by the Engineer.

Mount the CCTV camera unit such that a minimum 5 feet of clearance is maintained between the camera and the top of the pole.

Mount CCTV camera on the side of pole nearest intended field of view. Avoid occluding the view with the pole.

B. Electrical and Mechanical Requirements

Install Power over Ethernet (PoE) injector in existing equipment cabinet, and run an outdoor-rated Cat5e Ethernet cable through the existing conduit and up the pole to the CCTV assembly as shown in the Signal Communications Plans. Take all precautions necessary to ensure the Ethernet cable is not damaged during storage and installation. Do not step on the cable nor run over the cable with vehicles or equipment. Do not pull the cable over or around obstructions or along the ground. Install the cables according to the latest version of the manufacturer's cable installation procedures and the industry-accepted installation standards, codes, and practices, or as directed by the Engineer.

Ground all equipment as called for in the Standard Specifications, these Special Provisions, and the Plans.

Install surge protectors on all ungrounded conductors entering the CCTV enclosure. House the protectors in a small, ventilated weatherproof cabinet attached near the CCTV attachment point in a manner approved by the Engineer.

Furnish all tools, equipment, materials, supplies, and hardware necessary to install a fully operational CCTV camera system as depicted in the plans.

8.4. MEASUREMENT AND PAYMENT

Digital CCTV Camera Assembly will be measured and paid as the actual number of Digital CCTV Camera Assemblies furnished, installed, integrated, and accepted. No separate measurement will be made for necessary cabling, PoE cable, connectors, CCTV camera attachment assemblies, conduit, condulets, grounding equipment, surge protectors, CCTV control software, or any other equipment or labor required to install the CCTV assembly.

Payment will be made under:

Digital CCTV Camera AssemblyEach

9. DYNAMIC MESSAGE SIGN (DMS)

9.1. DESCRIPTION

For this project furnish two (2) DMS’s mounted back to back on a single support structure.

DMSs used on the State Highway System shall be preapproved on the current NCDOT ITS & Signals 2012 Qualified Products List (QPL) by the date of installation. DMSs not reapproved will not be allowed for use on the project. To ensure compatibility with the existing DMS Control Software deployed in the State, furnish NTCIP compliant DMSs that are fully compatible with Daktronics, Inc. Vanguard Version 4 software (also referred to hereinafter as the “Control Software”). The QPL is available on the Department’s website. The QPL website is:

<https://connect.ncdot.gov/resources/safety/Pages/ITS-and-Signals-Qualified-Products.aspx>

Furnish and install DMSs compliant with UL standards 48, 50, and 879.

Add and configure the new DMSs in the system using the Control Software and computer system. Furnish, install, test, integrate and make fully operational the new DMSs at locations shown in the plans.

Contact the Engineer to confirm all DMS locations prior to beginning construction. Furnish operating DMS systems consisting of, but not limited to, the following:

- Front Access DMS
 - Full Matrix, Full Color 20mm, 96 pixels high by 208 pixels wide front access LED DMS
 - Pedestal type DMS support structures and mounting hardware
- DMS controllers, Uninterruptible Power Supplies (UPS), cabinets and accessories with interconnect and power cabling and conduit
- Branch circuit conductors and related equipment
- All other equipment and incidentals required for furnishing, installing, and testing the DMS system and system components

Use only UL listed and approved electronic and electrical components in the DMS system.

9.2. MATERIALS

C. Environmental Requirements

Construct the DMS and DMS controller-cabinet so the equipment within shall be protected against moisture, dust, corrosion, and vandalism.

Design the DMS system to comply with the requirements of Section 2.1 (Environmental and Operating Standards) of NEMA TS 4-2016.

D. Full Matrix Led Dynamic Message Sign (DMS)

Construct the DMS to display at least three lines of text that, when installed, are clearly visible and legible to a person with 20 / 20 corrected vision from a distance of 900 feet in advance of the DMS at an eye height of 3.5 feet along the axis.

When displaying three lines, each line must display at least 8 equally spaced and equally sized alphanumeric individual characters. Each character must be at least 18 inches in height and composed from a luminous dot matrix. Provide an entire LED matrix that is a minimum of 98 pixels high and 208 pixels wide.

3. DMS Enclosure

Comply with the requirements of Section 3 (Sign Mechanical Construction) of NEMA TS 4-2005 as it applies to Walk-in enclosures. The following requirements complement TS 4-2005:

- Construct the DMS with a metal front-access enclosure excluding the face. Construct the enclosure of welded aluminum type 6061-T6, 5052-H38, 5052-H34, or of an Engineer approved alternate at least 1/8-inch thick. Perform all welding of aluminum and aluminum alloys in accordance with the latest edition of AWS D1.2, Structural Welding Code - Aluminum. Continuously weld the seams using Gas Metal Arc Welding (GMAW).
- Provide all exterior and interior DMS enclosure surfaces with natural, mill-finish aluminum. Remove all grind marks and discoloration from the surfaces.
- Provide corrosion resistant nuts, bolts, washers, and other mounting and bonding parts and components used on the exterior of the DMS enclosure and ensure they are sealed against water intrusion.
- Provide one access door for each 10 to 15 pixel wide section of the sign enclosure. Vertically hinge the doors and design to swing out from the face to provide access to the enclosure interior. Extend each door the full height of the display matrix.
- Provide a retaining latch mechanism for each door to hold the door open at a 90-degree angle.
- Each door will form the face panel for a section of the sign. Mount the LED modules to the door such that they can be removed from the door when in the open position. Other sign components can be located inside the sign enclosure and be accessible through the door opening.
- Provide for each door a minimum of two (2) screw-type captive latches to lock them in the closed position and pull the door tight and compress a gasket located around the perimeter of each door. Install the gasket around the doors to prevent water from entering the cabinet.
- Do not place a manufacturer name, logo, or other information on the front face of the DMS or shield visible to the motorist.
- Provide power supply monitoring circuitry to detect power failure in the DMS and to automatically report this fault to the Control Software. This requirement shall be in addition to reporting power failure at the controller cabinet.

- Do not paint the stainless-steel bolts on the Z-bar assembly used for mounting the enclosure.

4. DMS Interior Environment Control

Design the local field controller to monitor and control the interior DMS environment. Design environmental control to maintain the internal DMS temperature within +/- 10° F of the outdoor ambient temperature. Provide the DMS environmental control system with four primary subsystems as follows:

a. Internal Temperature Sensors – Provide the DMS with two internally mounted temperature sensors that are equipped with external thermocouples and which the Field Controller continuously monitors. Design the Field Controller to use this temperature information to determine when to activate and deactivate the environmental control systems described herein. Locate sensors on opposite ends of the upper 1/3 of the LED display matrix with their external thermocouples attached to and making contact with an LED pixel circuit board. Design the thermocouple and LED board to be easily detachable, in the event that one of the units requires removal and replacement. Provide sensors capable of measuring temperatures from -40° F to +185° F. Design the Field Controller to automatically shut down the LED display whenever one or both sensors indicates that LED board temperature has exceeded +140° F, and to automatically restart the LED display whenever the suspect temperature falls below +130° F. Design both shutdown and re-start temperature thresholds to be user-programmable. Design the field controller to report sensor temperatures and DMS shutdown/re-start events to the DMS Control Software.

b. Housing Cooling System – Provide the DMS housing with a cooling system that circulates outside air into the DMS housing whenever the LED board temperature exceeds a user-programmable threshold. Provide this system with enough ventilation fans to exchange the internal DMS housing air volume at a minimum rate of two times per minute. Provide steel ball bearing type fans. Mount fans in a line across the upper rear wall of the DMS housing to direct air out of the cabinet. Provide one filtered air intake port for each exhaust fan. Locate intake ports in a line across the lower rear wall of the DMS housing. Provide intake ports with a removable filter that will remove airborne particles measuring 500 microns in diameter and larger. Provide a filter that is of a size and style that is commercially readily available. Program the field controller to activate the DMS housing cooling system whenever the LED board temperature exceeds +90° F and to turn the cooling system off whenever LED board temperature falls below +85° F. On the DMS housing rear exterior wall, cover all air intake and exhaust ports on their top, front, and sides by an aluminum shroud fabricated from 0.090-inch aluminum sheeting. Taper the shrouds at the top. Securely fasten shrouds to the DMS housing, and provide gaskets at the interface to prevent water from entering the DMS. Design all air filters and fans to be removable from inside the DMS housing. Provide the DMS housing cooling system with an adjustable timer that will turn fans off after the set time has expired. Provide a timer that is adjustable to at least 4 hours, and locate it just inside the DMS housing door, within easy reach of a maintenance technician standing outside the DMS doorway.

c. LED Display Cooling System – Provide the DMS with an LED display cooling system which directs air across the LED display modules whenever LED board temperature exceeds a user-programmable threshold. Direct fan-forced air vertically across the backside of the entire LED display matrix using multiple ball-bearing fans. Program the field controller to activate the LED cooling fan system whenever LED board temperature exceeds +90° F and to

deactivate the system whenever LED board temperature falls to +85° F. Locate cooling fans so as not to hinder removal of LED display modules and driver boards.

d. Front Face Panel Defog / Defrost System – Provide the DMS with a defog / defrost system which circulates warm, fan-forced air across the inside of the polycarbonate front face whenever LED board temperature falls below a user-programmable threshold. Provide multiple steel ball-bearing fans that provide uniform airflow across the face panel. Program the field controller to activate the defog / defrost system whenever LED board temperature falls below +40° F and to deactivate the defog / defrost system whenever LED board temperature exceeds +106° F. Mount a 100-watt pencil-style heating element in front of each defog / defrost fan to warm the air directed across the DMS face. Design heating elements to be on only when the defog /defrost fans are on.

Install additional fans and / or heaters as needed to maintain the temperature inside the DMS enclosure within the operating temperature range of the equipment within the DMS enclosure as recommended by the equipment manufacturer(s).

5. Front Panel

Protect the DMS face with contiguous, weather-tight, removable panels. These panels shall be a polycarbonate material that are ultraviolet protected, have an antireflection coating, and are a minimum of 1/8- inch thick.

Furnish polycarbonate panels with the following characteristics:

- Tensile Strength, Ultimate: 10,000 PSI
- Tensile Strength, Yield: 9,300 PSI
- Tensile Strain at Break: 125%
- Tensile Modulus: 330,000 PSI
- Flexural Modulus: 330,000 PSI
- Impact Strength, Izod (1/8", notched): 17 ft-lbs/inch of notch
- Rockwell Hardness: M75, R118
- Heat Deflection Temperature Under Load: 264 PSI at 270° F and 66 PSI at 288° F
- Coefficient of Thermal Expansion: 3.9X10-5 in/in/F
- Specific Heat: 0.30 BTU/lb/F
- Initial Light Transmittance: 85% minimum
- Change in Light Transmittance, 3 years exposure in a Southern latitude: 3%
- Change in Yellowness Index, 3 years exposure in a Southern latitude: less than 5%

For substitutes, submit one 12" x 12" sample of the proposed material together with a description of the material attributes to the Engineer for review and approval. Install a .09" aluminum mask on the front of the panel (facing the motorists) that contains a circular opening for each LED pixel. Prime and coat the front side of the aluminum mask, which faces the viewing

motorists, with automotive-grade flat black acrylic enamel paint or an approved equivalent. Guarantee all painted surfaces provide a minimum outdoor service life of 20 years.

Design the panels so they will not warp nor reduce the legibility of the characters. Differential expansion of the DMS housing and the front panel must not cause damage to any DMS component or allow openings for moisture or dust. Glare from sunlight, roadway lighting, commercial lighting, or vehicle headlights must not reduce the legibility or visibility of the DMS. Install the panels so that a maintenance person can easily remove or open them for cleaning.

6. Display Modules

Manufacture each display module with a standard number of pixels, not to exceed an array of 9 x 5, which can be easily removed. Assemble the modules onto the DMS assemblies contiguously to form a continuous matrix to display the required number of lines, characters, and character height.

Design display modules that are interchangeable and replaceable without using special tools. Provide plug-in type power and communication cables to connect to a display module. Construct each display module as a rectangular array of 5 horizontal pixels by 7 to 9 vertical pixels. Provide the module with an equal vertical and horizontal pitch between pixels, and columns that are perpendicular to the rows (i.e., no slant).

Design each module to display:

- All upper and lower-case letters
- All punctuation marks
- All numerals 0 to 9
- Special user-created characters

Display upper-case letters and numerals over the complete height of the module. Optimize the LED grouping and mounting angle within a pixel for maximum readability.

Furnish two (2) spare display modules per each DMS installed for emergency restoration.

7. Discrete LEDs

Provide discrete LEDs with a nominal viewing cone of **30 degrees** with a half power angle of 15 degrees measured from the longitudinal axis of the LED. Viewing cone tolerances shall be as specified in the LED manufacturer's product specifications and shall not exceed +/- 3 degrees half-power viewing angle of 30 degrees.

Provide LEDs that are untinted, non-diffused, high output solid state lamps utilizing indium gallium aluminum phosphide (InGaAlP) technology. Provide T1 ³/₄, 0.2-inch size LEDs that emit a true amber color at a wavelength of 590 ± 5 nm.

Provide LEDs with a MTBF (Mean Time Before Failure) of at least 100,000 hours of permanent use at an operating point of 140° F or below at a specific forward current of 20mA. Discrete LED failure is defined as the point at which the LED's luminous intensity has degraded to 50% or less of its original level. Obtain the LEDs used in the display from a single LED manufacturer that have a single part number. Obtain them from batches sorted for luminous output, where the highest luminosity LED is not more than fifty percent more luminous than the lowest luminosity LED when the LEDs are driven at the same forward current. Do not use more than two successive and

overlapping batches in the LED display. Document the procedure to be used to comply with this requirement as part of the material submittal.

Individually mount the LEDs on circuit boards that are at least 1/16" thick FR-4 fiberglass, flat black printed circuit board in a manner that promotes cooling. Protect all exposed metal on both sides of the LED pixel board (except the power connector) from water and humidity exposure by a thorough application of acrylic conformal coating. Design the boards so bench level repairs to individual pixels, including discrete LED replacement and conformal coating repair is possible.

Operate the LED display at a low internal DC voltage not to exceed 24 Volts.

Design the LED display operating range to be -20° F to $+14^{\circ}$ F at 95% relative humidity, non-condensing.

Supply the LED manufacturer's technical specification sheet with the material submittals.

8. LED Power Supplies

Power the LED Display by means of multiple regulated switching DC power supplies that operate from 120 volts AC input power and have an output of 48 volts DC or less. Wire the supplies in a redundant parallel configuration that uses multiple power supplies per display. Provide the supplies with current sharing capability that allows equal amounts of current to their portion of the LED display. Provide power supplies rated such that if one supply fails the remaining supplies will be able to operate their portion of the display under full load conditions (i.e. all pixels on at maximum brightness) and at a temperature of 140° F.

Provide power supplies to operate within a minimum input voltage range of +90 to +135 volts AC and within a temperature range of -22° F to 140° F. Power supply output at 140° F must not deteriorate to less than 65% of its specified output at 70° F. Provide power supplies that are overload protected by means of circuit breakers, that have an efficiency rating of at least 75%, a power factor rating of at least .95, and are UL listed. Provide all power supplies from the same manufacturer and with the same model number. Design the power driver circuitry to minimize power consumption.

Design the field controller to monitor the operational status (normal or failed) of each individual power supply and be able to display this information on the Client Computer screen.

9. LED Pixels

A pixel is defined as the smallest programmable portion of a display module that consists of a cluster of closely spaced discrete LEDs. Design each pixel to be a maximum of two inches in diameter.

Construct the pixels with two strings of LEDs. It is the manufacturer's responsibility to determine the number of LEDs in each string to produce the candela requirement as stated herein.

Ensure each pixel produces a luminous intensity of 40 Cd when driven with an LED drive current of 20 mA per string.

Power the LEDs in each pixel in strings. Use a redundant design so that the failure of an LED in one string does not affect the operation of any other string within the pixel. Provide the sign controller with the ability to detect the failure of any LED string and identify which LED string has failed. Submit a complete schematic of the LED power and driver circuits with the material submittals.

10. Character Display

Design display modules to be easily removable without the use of tools. Position cooling fans so they do not prevent removal of an LED pixel board or driver board.

Use continuous current to drive the LEDs at the maximum brightness level. Design the light levels to be adjustable for each DMS / controller so the Engineer may set levels to match the luminance requirements at each installation site.

Design the controller to automatically detect failed LED strings or drivers and initiate a report of the event to the Control Software. Design the controller to be able to read the internal temperature of the DMS enclosure and the ambient temperature outside the DMS enclosure and report these to the Control Software.

11. Display Capabilities

Design the DMS with at least the following message displays:

- Static display
- Flashing display with Dynamic flash rates
- At least two alternating Static and / or Flashing sequences (multi-page messages)

12. DMS Mini Controller

Furnish and install a mini controller inside the DMS that is interconnected with the main controller using a fiber optic cable, CAT-5 cable, or an approved alternate. The mini controller will enable a technician to perform all functions available from the main controller. Provide the mini controller with an LCD /keypad interface. Size the LCD display screen to allow preview of an entire one-page message on one screen. Provide a 4 X 4 keypad.

Alternatively, install an EIA/TIA-232E port inside the DMS enclosure to enable a maintenance technician to communicate with the DMS main controller and obtain access to and perform all functions of the main controller using a laptop computer.

E. DMS Enclosure Structure Mounting

Mount the DMS enclosure and interconnect system securely to the support structures. Design the DMS enclosure supports to allow full access to the DMS enclosure inspection door.

Furnish and install U-bolt connections of hanger beams to overhead assembly truss chords with a double nut at each end of the U-bolt. Bring the double nuts tight against each other by the use of two wrenches.

Submit plans for the DMS enclosure, mounting description, and calculations to the Engineer for approval. Have such calculations and drawings approved by a Professional Engineer registered in the state of North Carolina, and bear his signature, seal, and date of acceptance.

Provide removable lifting eyes or the equivalent on the DMS enclosure rated for its total weight to facilitate handling and mounting the DMS enclosure.

Design the DMS structure to conform to the applicable requirements of the 2013 AASHTO *Standard Specifications for Structural Supports for Highway Signs, Luminaries, and Traffic Signals*, 6th Edition, and the 2013 and 2015 Interim Revisions, and the section titled *DMS Pedestal Structure* of this Project Special Provision.

F. DMS / DMS Controller Interconnect

Furnish and install all necessary cabling, conduit, and terminal blocks to connect the DMS and the DMS controller. Use approved manufacturer's specifications and the plans developed by the Design-Build Team for cable and conduit types and sizes. Use fiber optic cable to interconnect sign and controller. Install fiber optic interconnect centers in the sign enclosure and cabinet to securely install and terminate the fiber optic cable. Submit material submittal cut sheets for the interconnect center.

G. DMS Controller and Cabinet

Furnish and install one DMS controller with accessories per DMS in a new equipment cabinet. Mount the controller cabinet on the DMS support structure. Install cabinet so that the height from the ground to the middle of the cabinet is four feet. Ensure a minimum of three-foot level working surface under each cabinet that provides maintenance technicians with a safe working environment.

Provide the DMS controller as a software oriented microprocessor and with resident software stored in non-volatile memory. The Control Software, controller and communications must comply with the NTCIP Standards identified in these Project Special Provisions. Provide sufficient non-volatile memory to allow storage of at least 500 multi-page messages and a test pattern program.

Furnish the controller cabinet with, but not limited to, the following:

- Power supply and distribution assembly
- Power line filtering hybrid surge protectors
- Radio Interference Suppressor
- Communications surge protection devices
- Industrial-Grade UPS system and local disconnect
- Microprocessor-based controller
- Display driver and control system (unless integral to the DMS)
- Serial interface port for local laptop computer
- Local user interface
- Interior lighting and duplex receptacle
- Adjustable shelves as required for components
- Temperature control system
- All interconnect harnesses, connectors, and terminal blocks
- All necessary installation and mounting hardware

Furnish the DMS controller and associated equipment completely housed in a NEMA 3R cabinet made from 5052 H32 sheet aluminum at least 1/8" thick. Use natural aluminum cabinets. Perform all welding of aluminum and aluminum alloys in accordance with the latest edition of AWS D1.2, Structural Welding Code - Aluminum. Continuously weld the seams using Gas Metal Arc Welding (GMAW).

Slant the cabinet roof away from the front of the cabinet to prevent water from collecting on it.

Do not place a manufacturer name, logo, or other information on the faces of the controller cabinet visible to the motorist.

Provide cabinets capable of housing the components and sized to fit space requirement. Design the cabinet layout for ease of maintenance and operation, with all components easily accessible. Submit a cabinet layout plan for approval by the Engineer.

Locate louvered vents with filters in the cabinet to direct airflow over the controller and auxiliary equipment, and in a manner, that prevents rain from entering the cabinet. Fit the inside of the cabinet, directly behind the vents, with a replaceable, standard size, commercially available air filter of sufficient size to cover the entire vented area.

Provide a torsionally rigid door with a continuous stainless-steel hinge on the side that permits complete access to the cabinet interior. Provide a gasket as a permanent and weather resistant seal at the cabinet door and at the edges of the fan / exhaust openings. Use a non-absorbent gasket material that will maintain its resiliency after long term exposure to the outdoor environment. Construct the doors so that they fit firmly and evenly against the gasket material when closed. Provide the cabinet door with louvered vents and air filters near the bottom as described in the paragraph above.

The cabinet shall contain a full-height standard EIA 19-inch rack. The rack shall be secured within the cabinet by mounts at the top and bottom.

The rack shall contain a minimum of one (1) pullout drawer. The drawer shall be suitable for storing manuals and small tools, such as screwdrivers. The drawer shall be able to latch in the out position to function as a laptop / utility shelf.

Provide a convenient location on the inside of the door to store the cabinet wiring diagrams and other related cabinet drawings. Provide a Corbin #2 main door lock made of non-ferrous or stainless-steel material. Key all locks on the project alike, and provide ten keys to the Engineer. In addition, design the handle to permit pad-locking.

Provide the interior of the cabinet with ample space for housing the controller and all associated equipment and wiring; use no more than 75% of the useable space in the cabinet. Provide ample space in the bottom of the cabinet for the entrance and exit of all power, communications, and grounding conductors and conduit.

Arrange the equipment so as to permit easy installation of the cabling through the conduit so that they will not interfere with the operation, inspection, or maintenance of the unit. Provide adjustable metal shelves, brackets, or other support for the controller unit and auxiliary equipment. Leave a three-inch minimum clearance from the bottom of the cabinet to all equipment, terminals, and bus bars.

Provide power supply monitoring circuitry to detect power failure and to automatically report the occurrence to the Control Software.

Install two 15-watt fluorescent light strips with shields, one in the top of the cabinet and the other under the bottom shelf. Design both lights to automatically turn on when the cabinet door is opened and turn off when the door closes.

Mount and wire a 120V (+10%) GFCI duplex receptacle of the 3-wire grounding type in the cabinet in a location that presents no electrical hazard when used by service personnel for the operation of power tools and work lights.

No cabinet resident equipment shall utilize the GFCI receptacle. Furnish one spare non-GFCI receptacle for future equipment.

Mount a bug-proof and weatherproof thermostatically controlled fan and safety shield in the top of the cabinet. Size the fan to provide at least for two air exchanges per minute. Fuse the fan at 125% of the capacity of the motor. The magnetic field of the fan motor must not affect the performance of the control equipment. Use a fan thermostat that is manually adjustable to turn on between 80° F and 160° F with a differential of not more than 10° F between automatic turn-on and turn-off. Mount it in an easily accessible location, but not within six inches of the fan.

Install additional fans and / or heaters as needed to maintain the temperature inside the cabinet within the operating temperature range of the equipment within the cabinet as recommended by equipment manufacturer(s).

13. Wiring

The requirements stated herein apply wherever electrical wiring is needed for any DMS system assemblies and subassemblies such as controller cabinet, DMS enclosure, electrical panel boards etc.

Neatly arrange and secure the wiring inside the cabinet. Where cable wires are clamped to the walls of the control cabinet, provide clamps made of nylon, metal, plastic with rubber or neoprene protectors, or similar. Lace and jacket all harnesses, or tie them with nylon tie wraps spaced at six inches maximum to prevent separation of the individual conductors.

Individually and uniquely label all conductors. Ensure all conductor labels are clearly visible without moving the conductor. Connect all terminal conductors to the terminal strip in right angles. Remove excess conductor before termination of the conductor. Mold the conductor in such a fashion as to retain its relative position to the terminal strip if removed from the strip. Do not run a conductor across a work surface with the exception of connecting to that work surface. No conductor bundles can be support by fasteners that support work surfaces. Install all connectors, devices, and conductors in accordance to manufactures guidelines. Comply with the latest NEC guideline in effect during installation. No conductor or conductor bundle may hang loose or create a snag hazard. Protect all conductors from damage. Ensure all solder joints are completed using industry accepted practices and will not fail due to vibration or movement. Protect lamps and control boards from damage.

No splicing will be allowed for feeder conductors and communication cables from the equipment cabinet to the DMS enclosure.

Insulate all conductors and live terminals so they are not hazardous to maintenance personnel.

Route and bundle all wiring containing line voltage AC and / or shield it from all low voltage control circuits. Install safety covers to prevent accidental contact with all live AC terminals located inside the cabinet.

Use industry standard, keyed-type connectors with a retaining feature for connections to the controller.

Label all equipment and equipment controls clearly.

Supply each cabinet with one complete set of wiring diagrams that identify the color-coding or wire tagging used in all connections. Furnish a water-resistant packet adequate for storing wiring diagrams, operating instructions, and maintenance manuals with each cabinet.

14. Power Supply and Circuit Protection

Design the DMS and controller for use on a system with a line voltage of 120V + 10% at a frequency of 60 Hz + 3 Hz. Under normal operation, do not allow the voltage drop between no load and full load of the DMS and its controller to exceed 3% of the nominal voltage.

Blackout, brownout, line noise, chronic over-voltage, sag, spike, surge, and transient effects are considered typical AC voltage defects. Protect the DMS system equipment so that these defects do not damage the DMS equipment or interrupt their operation. Equip all cabinets with devices to protect the equipment in the cabinet from damage due to lightning and external circuit power and current surges.

15. Power Supply and Circuit Protections

Protect the DMS controller, accessories, and cabinet utilities with thermal magnetic circuit breakers. Provide the controller cabinet with a main circuit breaker sized according to the NEC. Use appropriately sized branch circuit breakers to protect the controller and accessories and for servicing DMS equipment and cabinet utilities.

16. Surge Suppressor

Install and clearly label filtering hybrid power line surge protectors on the load side of the branch circuit breakers in a manner that permits easy servicing. Ground and electrically bond the surge protector to the cabinet within two inches.

Provide power line surge protector that meets the following requirements:

Peak surge current occurrences	20 minimum
Peak surge current for an 8 x 20 microsecond wave-shape	50,000 amperes
Energy Absorption	> 500 Joules
Clamp voltage	240 volts
Response time	<1 nanosecond
Minimum current for filtered output	15 amperes for 120VAC *
Temperature range	-40° F to +158° F

*Capable of handling the continuous current to the equipment

17. Radio Interference Suppressor

Provide each controller cabinet with sufficient electrical and electronic noise suppression to enable all equipment in it to function properly. Provide one or more radio interference suppressors (RIS) connected between the stages of the power line surge suppressor that minimize interference generated in the cabinet in both the broadcast and the aircraft frequencies. Each RIS must provide a minimum attenuation of 50 decibels over a frequency range of 200 KHz to 75 MHz. Clearly label

the suppressor(s) and size them at least at the rated current of the main circuit breaker but not less than 50 amperes.

Provide RIS that are hermetically sealed in a substantial metal case which is filled with a suitable insulating compound and have nickel-plated 10/24 brass stud terminals of sufficient external length to provide space to connect #8 AWG wires. Mount them so that the studs cannot be turned in the case. Properly insulate ungrounded terminals from each other, and maintain a surface linkage distance of not less than 1/4" between any exposed current conductor and any other metallic parts. The terminals must have an insulation factor of 100-200 MΩ, dependent on external circuit conditions. Use RIS designed for 120 VAC + 10%, 60Hz, and which meet the standards of UL and the Radio Manufacturers Association.

18. Communications Surge Protector

Equip the cabinet with properly labeled hybrid data line surge protectors that meet the following general requirements:

Surge current occurrences at 2000 ampere, 8 x 20 microsecond	> 80
Surge current occurrences at 400 ampere, 10x700 microsecond	> 80
Peak surge current for 8 x 20 microsecond waveform	10,000 A (2500 A/line)
Peak surge current for 10x700 microsecond	500 A/line
Response time	< 1 nanosecond
Series resistance	< 15 W
Average capacitance	1500 pF
Temperature range	-10°F to 150°F
Clamp Voltage	As required to match equipment in

19. Lightning Arrester

Protect the system with an UL-approved lightning arrester installed at the main service disconnect. It shall meet the following requirements:

Type of design	Silicon Oxide Varistor
Voltage	120 / 240 Single phase, 3 wires
Maximum current	100,000 amps
Maximum energy	3000 joules per pole
Maximum number of surges	Unlimited
Response time one milliamp test	5 nanoseconds
Response time to clamp 10,000 amps	10 nanoseconds
Response time to clamp 50,000 amps	25 nanoseconds

Leak current at double the rated voltage	None
Ground Wire	Separate

20. Uninterruptible Power Supply (UPS)

Provide the cabinet with an industrial grade power conditioning UPS unit to supply continuous power to operate the equipment connected to it if the primary power fails. The UPS must detect a power failure and provide backup power within 20 milliseconds. Transition to the UPS source from primary power must not cause loss of data or damage to the equipment being supplied with backup power. Provide an UPS with at least three outlets for supplying conditioned AC voltage to the DMS controller. Provide a unit to meet the following requirements:

- Input Voltage Range: 120VAC +12%, -25%
- Power Rating: 1000 VA, 700 Watts
- Input Frequency: 45 to 65 Hz
- Input Current: 7.2A
- Output Voltage: 120VAC +/- 3%
- Output Frequency: 50/60 +/-1 Hz
- Output Current: 8.3A
- Output Crest Factor Ration: @50% Load Up to 4.8:1
@75% Load Up to 3.2:1
@100% Load Up to 2.4:1
- Output THD: 3% Max. (Linear)
5% Max. (Non-Linear)
- Output Overload: 110% for 10 min; 200% for 0.05 sec.

- Output Dynamic Response: +/- 4% for 100% Step Load Change
0.5 ms Recovery Time.
- Output Efficiency @ 100% Load: 90% (Normal Mode)
- Operating Temperature: -40° F to +165° F
- Humidity: 0% to 95% Non-condensing
- Remote Monitoring Interface: RS-232
- Protection: Input / Output Short Circuit
Input / Output Overload
Excessive Battery Discharge
- Specifications: UL1778, FCC Class A, IEEE 587

Provide the UPS unit capable of supplying 30 minutes of continuous backup power to the equipment connected to it when this equipment is operating at full load.

21. Controller Communications Interface

Provide the controller with the following interface ports:

- An EIA/TIA-232E port for remote communication using NTCIP
- An 10/100 Ethernet port for remote communication using NTCIP
- An EIA/TIA-232E port for onsite access using a laptop
- An EIA/TIA-232E auxiliary port for communication with a field device such as a UPS
- Fiber Optic ports for communication with the sign
- RJ45 ports for communication with the sign using CAT-5 cable
- RJ45 ports for communication with mini-controller located inside the sign enclosure

22. Controller Local User Interface

Provide the controller with a Local User Interface (LUI) for at least the following functions:

- On / Off Switch: controls power to the controller.
- Control Mode Switch: for setting the controller operation mode to either remote or local mode.

- LCD Display and Keypad: Allow user to navigate through the controller menu for configuration (display, communications parameter, etc.) running diagnostics, viewing peripherals status, message creation, message preview, message activation, etc. Furnish a LCD display with a minimum size of 240x64 dots with LED back light.

23. Controller Address

Assign each DMS controller a unique address. Preface all commands from the Control Software with a particular DMS controller address. The DMS controller compares its address with the address transmitted; if the addresses match, then the controller processes the accompanying data.

24. Controller Functions

Design the DMS controller to continuously control and monitor the DMS independent of the Control Software. Design the controller to display a message on the sign sent by the Control Software, a message stored in the sign controller memory, or a message created on-site by an operator using the controller keypad. Provide the DMS controller with a watchdog timer to detect controller failures and to reset the microprocessor, and with a battery backed-up clock to maintain an accurate time and date reference. Set the clock through an external command from the Control Software or the Local User Interface.

25. DMS Controller Memory

Furnish each DMS controller with non-volatile memory. Use the non-volatile memory to store and reprogram at least one test pattern sequence and 500 messages containing a minimum of two pages of 45 characters per page. The Control Software can upload messages into and download messages from each controller's non-volatile memory remotely.

Messages uploaded and stored in the controller's non-volatile memory may be erased and edited using the Control Software and the controller. New messages may be uploaded to and stored in the controller's non-volatile memory using the Control Software and the controller.

H. Photo-Electric Sensors

Install three photoelectric sensors with ½-inch minimum diameter photosensitive lens inside the DMS enclosure. Use sensors that will operate normally despite continual exposure to direct sunlight. Place the sensors so they are accessible and field adjustable.

Point one sensor north or bottom of the sign. Place the other two, one on the back wall and one on the front wall of the sign enclosure. Alternate designs maybe accepted, provided the sensor assemblies are accessible and serviceable from inside the sign enclosure.

Provide controls so that the Engineer can field adjust the following:

- The light level emitted by the pixels elements in each Light Level Mode.
- The ambient light level at which each Light Level Mode is activated.

I. Equipment List

Provide a general description of all equipment and all information necessary to describe the basic use or function of the major system components. Include a general "block diagram" presentation. Include tabular charts listing auxiliary equipment, if any is required. Include the nomenclature, physical and electrical characteristics, and functions of the auxiliary equipment unless such

information is contained in an associated manual; in this case include a reference to the location of the information. Include an itemized list of equipment costs.

Include a table itemizing the estimated average and maximum power consumption for each major piece of equipment.

J. Physical Description

Provide a detailed physical description of size, weight, center of gravity, special mounting requirements, electrical connections, and all other pertinent information necessary for proper installation and operation of the equipment.

K. Parts List

Provide a parts list that contains all information needed to describe the characteristics of the individual parts, as required for identification. Include a list of all equipment within a group and a list of all assemblies, sub-assemblies, and replacement parts of all units.

Arrange this data in a table, in alpha-numerical order of the schematic reference symbols, which gives the associated description, manufacturer's name, and part number, as well as alternate manufacturers and part numbers. Provide a table of contents or other appropriate grouping to identify major components, assemblies, etc.

L. Character Set Submittal

Submit an engineering drawing of the DMS character set including 26 upper case and lower-case letters, 10 numerals, an asterisk (*), a dash, a plus sign (+), a designated lane diamond, a slash, an ampersand, and arrows at 0, 45, 90, 135, 180, 225, 270, and 315 degrees.

M. Wiring Diagrams

Provide a wiring diagram for each DMS and each controller cabinet, as well as interconnection wiring diagrams for the system as a whole.

Provide complete and detailed schematic diagrams to component level for all DMS assemblies and subassemblies such as driver boards, control boards, DMS controller, power supplies, etc. Ensure that each schematic enables an electronics technician to successfully identify any component on a board or assemblies and trace its incoming and outgoing signals.

N. Routine Of Operation

Describe the operational routine, from necessary preparations for placing the equipment into operation to securing the equipment after operation. Show appropriate illustrations with the sequence of operations presented in tabular form wherever applicable. Include in this section a total list of the test instruments, aids and tools required to perform necessary measurements and measurement techniques for each component, as well as set-up, test, and calibration procedures.

O. Maintenance Procedures

Specify the recommended preventative maintenance procedures and checks at pre-operation, monthly, quarterly, semi-annual, annual, and "as required" periods to assure equipment operates reliably. List specifications (including tolerances) for all electrical, mechanical, and other applicable measurements and / or adjustments.

P. Repair Procedures

Include in this section all data and step-by-step procedures necessary to isolate and repair failures or malfunctions, assuming the maintenance technicians are capable of analytical reasoning using the information provided in the sections titled *Wiring Diagrams* and *Routine of Operation*.

Describe accuracy, limits, and tolerances for all electrical, physical, or other applicable measurements. Include instructions for disassemblies, overhaul, and re-assemblies, with shop specifications and performance requirements.

Give detailed instructions only where failure to follow special procedures would result in damage to equipment, improper operation, danger to operating or maintenance personnel, etc. Include such instructions and specifications only for maintenance that specialized technicians and engineers in a modern electromechanical shop would perform. Describe special test set-up, component fabrication, and the use of special tools, jigs, and test equipment.

Q. Field Trial

At the request of the Engineer, supply a three-character demonstration module with characters of the size and type specified for the project, an appropriate control device and power supply to allow character display within 30 working days of the request. Perform a field trial on this module at a time and location selected by the Engineer.

This trial will allow the Engineer or his selected representatives to test the readability of the DMS at the maximum distance required for specified character size. Test the module with the sun directly above the DMS, and near the horizon in front of and behind the DMS (washout and back-lit conditions).

9.3. CONSTRUCTION METHODS

R. Description

This article establishes practices and procedures and gives minimum standards and requirements for the installation of Dynamic Message Sign systems, auxiliary equipment and the construction of related structures.

Provide electrical equipment described in this specification that conforms to the standards of NEMA, UL, or Electronic Industries Association (EIA), wherever applicable. Provide connections between controllers and electric utilities that conform to NEC standards.

Express wire sizes according to the American Wire Gauge (AWG).

Provide stainless steel screws, nuts, and locking washers in all external locations. Do not use self-tapping screws unless specifically approved by the Engineer. Use parts made of corrosion-resistant materials, such as plastic, stainless steel, brass, or aluminum. Use construction materials that resist fungus growth and moisture deterioration. Separate dissimilar metals by an inert dielectric material.

S. Layout

The Engineer will establish the actual location of each Dynamic Message Sign assembly. It is the Contractors responsibility to ensure proper elevation, offset, and orientation of all DMS assemblies. The location of service poles as well as conduit lengths shown in the project plans, are approximate based on available project data. Make actual field measurements to place conduit and equipment at the required location.

T. Construction Submittal

When the work is complete, submit As Built Plans, inventory sheets, and any other data required by the Engineer to show the details of actual construction and installation and any modifications made during installation.

The As-Built Plans shall show: the DMS, controller, and service pole locations; DMS enclosure and controller cabinet wiring layouts; and wire and conduit routing. Show all underground conduits and cables dimensioned from fixed objects.

Include detailed drawings that identify the routing of all conductors in the system by cable type, color code, and function. Clearly label all equipment in the DMS system, controller cabinet, and DMS enclosure.

U. Conduit

Install the conduit system in accordance with Section 1715 of the 2012 *Standard Specifications for Roads and Structures* and NEC requirements for an approved watertight raceway.

Make bends in the conduit so as not to damage it or change its internal diameter. Install watertight and continuous conduit with as few couplings as standard lengths permit.

Clean conduit before, during, and after installation. Install conduit in such a manner that temperature changes will not cause elongation or contraction that might damage the system.

Attach the conduit system to and install along the structural components of the DMS structure assemblies with beam clamps or stainless-steel strapping. Install strapping according to the strapping manufacturer's recommendations. Do not use welding or drilling to fasten conduit to structural components. Space the fasteners at no more than 4 feet for conduit 1.5 inches and larger or 6 feet for conduit smaller than 1.25 inches. Place fasteners no more than 3 feet from the center of bends, fittings, boxes, switches, and devices.

Locate underground conduit as shown in the plans in a manner consistent with these Project Special Provisions.

Do not exceed the appropriate fill ratio on all cable installed in conduit as specified in the NEC.

V. Wiring Methods

Do not pull permanent wire through a conduit system until the system is complete and has been cleaned.

Color-code all conductors per the NEC. Use approved marking tape, paint, sleeves or continuous colored conductors for No.8 AWG and larger. Do not mark a white conductor in a cable assemblies any other color.

Bury underground circuits at the depth shown in the plans and surround it with at least three inches of sand or earth back-fill free of rocks and debris. Compact backfill in six-inch layers. Do not splice underground circuits unless specifically noted in the project plans and approved by the Department.

W. Equipment and Cabinet Mounting

Mount equipment securely at the locations shown in the plans and, in conformance with the

dimensions shown. Install fasteners as recommended by the manufacturer and space them evenly. Use all mounting holes and attachment points for attaching DMS enclosures and controller cabinets to the structures.

Drill holes for expansion anchors of the size recommended by the manufacturer of the anchors and thoroughly clean them of all debris.

Provide one key-operated, pin tumbler, dead bolt padlock, with brass or bronze shackle and case, conforming to Military Specification MIL-P-17802E (Grade I, Class 2, Size 2, Style A) for each electrical panel and switch on the project. Key all padlocks alike, and provide ten keys to the Engineer.

Provide cabinets with all mounting plates, anchor bolts, and any other necessary mounting hardware in accordance with these Project Special Provisions.

Seal all unused conduit installed in cabinets at both ends to prevent water and dirt from entering the conduit and cabinet with approved sealing material.

Install a ground bushing attached inside the cabinet on all metal conduits entering the cabinet. Connect these ground bushings to the cabinet ground bus.

Install a level concrete technician pad measuring a minimum 4 inches thick, 24 inches wide and 36 inches long at the front door of the DMS equipment cabinet as shown on the Typical Details sheet within the Project Plans.

X. Work Site Clean-Up

Clean the site of all debris, excess excavation, waste packing material, wire, etc. Clean and clear the work site at the end of each workday. Do not throw waste material in storm drains or sewers.

9.4. MEASUREMENT AND PAYMENT

Dual DMS Mounted Back to Back will be measured and paid as the actual number of DMS’s furnished, installed, and accepted. The Dual DMS setup will consist of both LED Dynamic Message Signs, spare display modules, communications equipment, strapping hardware, controller, UPS, controller cabinet, concrete technician pad, conduit, fittings, couplings, sweeps, conduit bodies, wire, flexible conduit, feeder conductors and communications cable between the controller cabinet and the DMS enclosure, connectors, circuit protection equipment, photo-electric sensors, tools, materials, all related testing, cost of labor, cost of transportation, incidentals, and all other equipment necessary to furnish and install the DMS system.

Payment will be made under:

Dual DMS Mounted Back to Back.....Each

10. NTCIP Requirements

This section defines the detailed NTCIP requirements for the DMSs covered by these Project Special Provisions and Plans.

10.1. REFERENCES

This specification references several standards through their NTCIP designated names. The following list provides the full reference to the current version of each of these standards.

Implement the most recent version of the standard including any and all Approved or Recommended Amendments to these standards for each NTCIP Component covered by these project specifications.

Table 1: NTCIP Standards

Abbreviated Number	Full Number	Title
NTCIP 1101	NTCIP 1101:1997	<i>Simple Transportation Management Framework</i>
NTCIP 1201	NTCIP 1201:1997	<i>Global Object Definitions</i>
NTCIP 1203	NTCIP 1203:1997	<i>Object Definitions for Dynamic Message Signs</i>
NTCIP 2001	NTCIP 2001:1997	<i>Class B Profile</i>
NTCIP 2101	NTCIP 2101	<i>SP-PMPP/232 Subnet Profile for PMPP over RS-232</i>
NTCIP 2102	NTCIP 2102	<i>SP-PMPP/FSK Subnet Profile for PMPP over FSK Modem</i>
NTCIP 2103	NTCIP 2103	<i>SP-PPP/232 Subnetwork Profile for PPP over RS232 (Dial Up)</i>
NTCIP 2104	NTCIP 2104	<i>SP-Ethernet Subnet Profile for Ethernet</i>
NTCIP 2201	NTCIP 2201	<i>TP-Null Transport Profile</i>
NTCIP 2202	NTCIP 2202	<i>TP-Internet Internet Transport Profile (TCP/IP and UDP/IP)</i>
NTCIP 2301	NTCIP 2301	AP-STMF

Abbreviated Number	Full Number	Title
		AP for Simple Transportation Management Framework

A. General Requirements

1. Subnet Level

Ensure each serial port on each NTCIP Component supports NTCIP 2103 over a dial-up connection with a contractor provided external modem with data rates of 28.8 kbps, 19.2 kbps, 14.4 kbps, 9600 bps, 4800 bps, 2400 bps, 1200 bps, 600 bps, and 300 bps. Enable the NTCIP Component to make outgoing and receive incoming calls as necessary and support the following modem command sets:

- Hayes AT - Command Set
- MNP5
- MNP10
- V.42bis

Ensure each serial port on each NTCIP Component supports NTCIP 2103 over a null-modem connection with data rates of 19.2 kbps, 14.4 kbps, 9600 bps, 4800 bps, 2400 bps, 1200 bps, 600 bps, and 300 bps.

Ensure each serial port on each NTCIP Component supports NTCIP 2101 with data rates of 9600 bps, 4800 bps, 2400 bps, 1200 bps, 600 bps, and 300 bps.

Ensure NTCIP components support NTCIP 2102 and NTCIP 2104.

NTCIP Components may support additional Subnet Profiles at the manufacturer's option. At any one time, make certain only one Subnet Profile is active on a given serial port of the NTCIP Component. Ensure the NTCIP Component can be configured to allow the field technician to activate the desired Subnet Profile and provide a visual indication of the currently selected Subnet Profile.

2. Transport Level

Ensure each NTCIP Component complies with NTCIP 2201 and 2202.

NTCIP Components may support additional Transport Profiles at the manufacturer's option. Ensure Response datagrams use the same Transport Profile used in the request. Ensure each NTCIP Component supports the receipt of datagrams conforming to any of the identified Transport Profiles at any time.

3. Application Level

Ensure each NTCIP Component complies with NTCIP 1101 and 2301 and meets the requirements for Conformance Level 1 (NOTE - See Amendment to standard).

Ensure each NTCIP Component supports SNMP traps. An NTCIP Component may support additional Application Profiles at the manufacturer's option. Ensure Responses use the same

Application Profile used by the request. Ensure each NTCIP Component supports the receipt of Application data packets at any time allowed by the subject standards.

4. Information Level

Guarantee each NTCIP Component provides Full, Standardized Object Range Support of all objects required by these Special Provisions unless otherwise indicated below. Make certain the maximum Response Time for any object or group of objects is 200 milliseconds.

Design the DMS to support all mandatory objects of all mandatory Conformance Groups as defined in NTCIP 1201 and NTCIP 1203. Table 2 indicates the modified object requirements for these mandatory objects.

Table 2: Modified Object Ranges for Mandatory Objects

Object	Reference	Project Requirement
ModuleTableEntry	NTCIP 1201 Clause 2.2.3	Contains at least one row with moduleType equal to 3 (software). The moduleMake specifies the name of the manufacturer, the moduleModel specifies the manufacturer's name of the component and the modelVersion indicates the model version number of the component.
MaxGroupAddresses	NTCIP 1201 Clause 2.7.1	At least 1
CommunityNamesMax	NTCIP 1201 Clause 2.8.2	At least 3
DmsNumPermanentMsg	NTCIP 1203 Clause 2.6.1.1.1.1	At least 1*
DmsMaxChangeableMsg	NTCIP 1203 Clause 2.6.1.1.1.3	At least 21
DmsFreeChangeableMemory	NTCIP 1203 Clause 2.6.1.1.1.4	At least 20 when no messages are stored.
DmsMessageMultiString	NTCIP 1203 Clause 2.6.1.1.1.8.3	The DMS supports any valid MULTI string containing any subset of those MULTI tags listed in Table 4
DmsControlMode	NTCIP 1203 Clause 2.7.1.1.1.1	Support at least the following modes: Local

Object	Reference	Project Requirement
		External central CentralOverride

* Ensure the Permanent Messages display the content shown in Table 3.

Ensure the sign blanks if a command to display a message contains an invalid Message CRC value for the desired message.

Table 3: Content of Permanent Messages

Perm. Msg. Num.	Description
1	Permanent Message #1 blanks the display (i.e., consist of and empty MULTI string). It has a run-time priority of one (1).

Table 4: Required MULTI Tags

Code	Feature
f1	field 1 - time (12hr)
f2	field 2 - time (24hr)
f8	field 8 – day of month
f9	field 9 – month
f10	field 10 - 2 digit year
f11	field 11 - 4 digit year
fl (and /fl)	flashing text on a line by line basis with flash rates controllable in 0.5 second increments.
fo	Font
jl2	Justification – line – left
jl3	Justification – line – center
jl4	Justification – line – right
jl5	Justification – line – full
jp2	Justification – page – top

Code	Feature
jp3	Justification – page – middle
jp4	Justification – page – bottom
Mv	moving text
Nl	new line
Np	new page, up to 2 instances in a message (i.e., up to 3 pages/frames in a message counting first page)
Pt	page times controllable in 0.5 second increments.

The NTCIP Component implements all mandatory and optional objects of the following optional conformance groups with FSORS.

5. Test Heading

Time Management

As defined in NTCIP 1201

Timebase Event Schedule

As defined in NTCIP 1201. The following list indicates the modified object requirements for this conformance group.

Table 5: Modified Object Ranges for the Timebase Event Schedule Conformance Group

Object	Reference	Project Requirement
MaxTimeBaseScheduleEntries	NTCIP 1201 Clause 2.4.3.1	At least 28
maxDayPlans	NTCIP 1201 Clause 2.4.4.1	At least 14
maxDayPlanEvents	NTCIP 1201 Clause 2.4.4.2	At least 10

Report

As defined in NTCIP 1201. The following list indicates the modified object requirements for this conformance group.

Table 6: Modified Object Ranges for the Report Conformance Group

Object	Reference	Project Requirement
maxEventLogConfigs	NTCIP 1201 Clause 2.5.1	At least 50
eventConfigurationMode	NTCIP 1201 Clause 2.4.3.1	The NTCIP Component supports the following Event

		Configuration Modes: onChange greaterThanValue smallerThanValue
MaxEventLogSize	NTCIP 1201 Clause 2.5.3	At least 200
MaxEventClasses	NTCIP 1201 Clause 2.5.5	At least 16

PMPP

Font Configuration

As defined in NTCIP 1203. The following list indicates the modified object requirements for this conformance group.

Table 7: Modified Object Ranges for the Font Configuration Conformance Group

Object	Reference	Project Requirement
NumFonts	NTCIP 1203 Clause 2.4.1.1.1.1	At least 4*
MaxFontCharacters	NTCIP 1203 Clause 2.4.1.1.1.3	At least 127**

*Upon delivery, the first font is a standard 18” font. The second font is a double-stroke 18” font. The third font is a 28” font. The fourth font is empty.

**Upon delivery, the first three font sets are configured in accordance with the ASCII character set for the following characters:

- “A” thru “Z”- All upper case letters.
- “0” thru “9”- All decimal digits.
- Space (i.e., ASCII code 0x20).
- Punctuation marks shown in brackets [. , ! ? - ‘ ’ “ ” / ()]
- Special characters shown in brackets [# & * +<>]

DMS Configuration

As defined in NTCIP 1203.

MULTI Configuration

As defined in NTCIP 1203. The following list indicates the modified object requirements for this conformance group.

Table 8: Modified Object Ranges for the MULTI Configuration Conformance Group

Object	Reference	Project Requirement
--------	-----------	---------------------

DefaultBackgroundColor	NTCIP 1203 Clause 2.5.1.1.1.1	The DMS supports the following background colors: black
DefaultForegroundColor	NTCIP 1203 Clause 2.5.1.1.1.2	The DMS supports the following foreground colors: amber
DefaultJustificationLine	NTCIP 1203 Clause 2.5.1.1.1.6	The DMS supports the following forms of line justification: left center right full
defaultJustificationPage	NTCIP 1203 Clause 2.5.1.1.1.7	The DMS supports the following forms of page justification: top middle bottom
defaultPageOnTime	NTCIP 1203 Clause 2.5.1.1.1.8	The DMS supports the full range of these objects with step sizes no larger than 0.5 seconds
defaultPageOffTime	NTCIP 1203 Clause 2.5.1.1.1.9	The DMS supports the full range of these objects with step sizes no larger than 0.5 seconds
defaultCharacterSet	NTCIP 1203 Clause 2.5.1.1.1.10	The DMS supports the following character sets: eightBit

Default Message Control as defined in NTCIP 1203

Pixel Service Control as defined in NTCIP 1203

MULTI Error Control as defined in NTCIP 1203

Illumination/Brightness Control

As defined in NTCIP 1203. The following list indicates the modified object requirements for this conformance group.

Table 9: Modified Object Ranges for the Illumination/Brightness Control Conformance Group

Object	Reference	Project Requirement
--------	-----------	---------------------

dmsIllumControl	NTCIP 1203 Clause 2.8.1.1.1.1	The DMS supports the following illumination control modes: photocell timer manual
dmsIllumNumBrightLevels	NTCIP 1203 Clause 2.8.1.1.1.4	At least 16

Auxiliary I/O

Scheduling

As defined in NTCIP 1203. The following list indicates the modified object requirements for this conformance group.

Table 10: Modified Object Ranges for the Scheduling Conformance Group

Object	Reference	Project Requirement
NumActionTableEntries	NTCIP 1203 Clause 2.9.1.1.1.1	At least 21

Sign Status as defined in NTCIP 1203

Status Error as defined in NTCIP 1203

Pixel Error Status as defined in NTCIP 1203

Fan Error Status as defined in NTCIP 1203

Power Status as defined in NTCIP 1203

Temperature Status as defined in NTCIP 1203

Install necessary hardware for the support of items q, r, and s above.

Table 11: Some Optional Object Requirements

Object	Reference	Project Requirement
DefaultFlashOn	NTCIP 1203 Clause 2.5.1.1.1.3	The DMS supports the full range of these objects with step sizes no larger than 0.5 seconds
DefaultFlashOff	NTCIP 1203 Clause 2.5.1.1.1.4	The DMS supports the full range of these objects with step sizes no larger than 0.5 seconds
DmsMultiOtherErrorDescription	NTCIP 1203 Clause 2.7.1.1.1.20	If the vendor implements any vendor-specific MULTI tags, the DMS shall provide meaningful error messages within this object whenever one of these tags generates an error.

6. Documentation

Supply software with full documentation, including a CD-ROM containing ASCII versions of the following MIB files in Abstract Syntax Notation 1 (ASN.1) format:

- The relevant version of each official standard MIB Module referenced by the device functionality.
- If the device does not support the full range of any given object within a Standard MIB Module, a manufacturer specific version of the official Standard MIB Module with the supported range indicated in ASN.1 format in the SYNTAX and/or DESCRIPTION fields of the associated OBJECT TYPE macro. Name this file identical to the standard MIB Module, except that it will have the extension ".man".
- A MIB Module in ASN.1 format containing any and all manufacturer-specific objects supported by the device with accurate and meaningful DESCRIPTION fields and supported ranges indicated in the SYNTAX field of the OBJECT-TYPE macros.
- A MIB containing any other objects supported by the device.

Allow the use of any and all of this documentation by any party authorized by the Department for systems integration purposes at any time initially or in the future, regardless of what parties are involved in the systems integration effort.

B. NTCIP Acceptance Testing

Test the NTCIP requirements outlined above by a third party testing firm. Submit to the Engineer for approval a portfolio of the selected firm. Include the name, address, and a history of the selected firm in performing NTCIP testing along with references. Also provide a contact person's name and phone number. Submit detailed NTCIP testing plans and procedures, including a list of hardware

and software, to the Engineer for review and approval 10 days in advance of a scheduled testing date. Develop test documents based on the NTCIP requirements of these Project Special Provisions. The acceptance test will use the NTCIP Exerciser, and/or other authorized testing tools and will follow the guidelines established in the ENTERPRISE Test Procedures. Conduct the test in North Carolina on the installed system in the presence of the Engineer. Document and certify the results of the test by the firm conducting the test and submit the Engineer for review and approval. In case of failures, remedy the problem and have the firm retest in North Carolina. Continue process until all failures are resolved. The Department reserves the right to enhance these tests as deemed appropriate to ensure device compliance.

10.2. MEASUREMENT AND PAYMENT

There will be no direct payment for the work covered by this section.

Payment for this work will be covered in the applicable sections of these Project Special Provisions at the contract unit price for “Dual DMS Mounted Back to Back” and will be full compensation for all work listed above.

11. DMS ASSEMBLIES

11.1. DESCRIPTION

This section includes all design, fabrication, furnishing, and erection of the DMS assemblies, and attachment of the DMS enclosures to the structures in accordance with the requirements of these Project Special Provisions and the Plans. Fabricate the supporting DMS assemblies from tubular steel. Furnish pedestal type DMS assemblies as shown in the Plans. Cantilevered and monotube (horizontal truss) DMS structures will not be allowed.

For the two (2) DMS's mounted back to back on a single support structure, provide pedestal structures with a minimum of 18 feet clearance from the high point of the road to the bottom of the DMS enclosure. DMS assemblies must allow for field adjustment with shims (horizontal & vertical tilting) +/- 3 degrees of the DMS enclosure to ensure optimum legibility from all travel lanes.

Design the new DMS assemblies (including footings) and submit shop drawings for approval. A Professional Engineer that is registered in the state of North Carolina will prepare such computations and drawings. These must bear his signature, seal, and date of acceptance.

The provisions of Section 900 of the Standard Specifications apply to all work covered by this section.

It is the Contractor's responsibility to provide DMS S-dimension elevation drawings for the DMS locations to the Engineer for approval.

11.2. MATERIAL

Use materials that meet the following requirements of the Standard Specifications:

Structural Steel	Section 1072
Overhead Sign Structures	Section 1096
Signing Materials	Section 1092
Organic-Zinc Repair Paint	Article 1080-9
Reinforcing Steel	Sub-article 1070
Direct Tension Indicators	Sections 440 and 1072

11.3. CONSTRUCTION METHODS

A. General

Fabricate the new DMS assemblies, in accordance with the details shown in the approved shop drawings and the requirements of these Project Special Provisions.

No welding, cutting, or drilling in any manner will be permitted in the field, unless approved by the Engineer.

Drill bolt holes and slots to finished size. Holes may also be punched to finished size, provided the diameter of the punched holes are at least twice the thickness of the metal being punched. Flame cutting of bolt holes and slots is not permitted.

Erect DMS in accordance with the requirements indicated on the Plans and in these Project Special Provisions. Field drill two holes per connection in the Z bars for attaching the DMS to the structure. Use two bolts at each connection. Provide two (2) U-bolts at each U-bolt connection such as 1) each truss chord to sign hanger, or 2) each truss chord to platform support. Provide two (2) U-bolts at each U-bolts connection where ends of truss chords are supported. Minimum diameter of all U-bolts is to be ½ inch.

Use two coats of a zinc-rich paint to touch up minor scars on all galvanized materials. See Standard Specifications for Roads and Structures Section 1076-6.

For high strength bolted connections, provide direct tension indicator washer.

B. Shop Drawing

Submit to the Engineer for approval a complete design for the DMS assemblies (including footings) DMS assembly hardware, brackets for supporting the DMS to the structure. Base the design on the line drawings and correct wind speed in accordance with the latest edition of AASHTO "Standard Specifications for Structural Supports for Highway Signs, Luminaries and Traffic Signals, 5th Edition, 2009" with the latest interim revisions.

The manufacturer of the DMS assembly must ensure that design of the assembly is compatible with the DMSs for mounting and attachment.

Submit six copies of complete detailed shop drawings and one copy of the design computations for the DMS assembly to the Engineer for approval prior to fabrication. Show in the shop drawings complete design and fabrication details including foundations, provisions for attaching the DMS, applicable material specifications, and any other information necessary for procuring and replacing any part of the complete DMS assembly.

Allow a minimum of 40 working days for shop drawing approval after the Engineer receives them. If revised drawings are necessary, allow appropriate additional time for review and approval of final shop drawings.

Approval of shop drawings by the Engineer will not relieve the Contractor of his responsibility for the correctness of drawings, or for the fit of all shop and field connections and anchors.

C. Design and Fabrication

1. Dynamic Message Sign Assembly

- Design must be in accordance with the Standard Specifications for Structural Supports for Highway Signs, Luminaires and Traffic Signals, 5th Edition, 2009, and the latest Interim Revisions.
- The wind pressure map that is developed from the 3-second gust speeds, as provided in Article 3.8, shall be used.
- The natural wind gust speed in North Carolina shall be assumed to be 5 meters per second or 11.6 mph for inland areas, and 7 meters per second or 15.7 mph for coastal areas. The coastal area shall be defined as any area within 2 miles from the waterfront facing the ocean or sound and all area where the design basic wind speed is above 120 mph, as shown in Figure 3-2.
- The fatigue importance category used in the design, for each type of structure, as provided for in Article 11.6, Fatigue Importance Factors, shall be Category II unless otherwise shown on the contract plans.
- Wind drag coefficient for Dynamic Message Sign enclosures shall be 1.7.

The following Specification interpretations or criteria shall be used in the design of overhead sign assemblies:

- For design of supporting upright posts or columns, the effective length factor for columns “K”, as provided for in Appendix B, Section B.5, shall be taken as the following, unless otherwise approved by the Engineer:
 - Case 1 For a single upright post of span type overhead sign structure, the effective column length factor, “K”, shall be taken as 2.0.
 - Case 2 For twin post truss-type upright post with the post connected to one chord of a horizontal truss, the effective column length factor for that column shall be taken as 2.0.
 - Case 3 For twin post truss-type upright post with the post connected to two truss chords of a horizontal tri-chord or box truss, the effective column length factor for that column shall be taken as 1.65.
- For twin post truss-type upright post, the unbraced length shall be from the chord to post connection to the top of base plate.
- For twin post truss-type upright post that is subject to axial compression, bending moment, shear, and torsion the post shall satisfy Standard Specifications for Structural Supports for Highway Signs, Luminaries and Traffic Signals Equations 5-17, 5-18 and 5-19. To reduce the effects of secondary bending, in lieu of Equation 5-18, the following equation may be used:

$$\frac{f_a}{F_a} + \frac{f_b}{\left(1 - \frac{0.6f_a}{F_c}\right)F_b} + \left(\frac{f_v}{F_v}\right)^2 \leq 1.0$$

Where

fa = Computed axial compression stress at base of post

- The base plate thickness for all uprights and poles shall be a minimum of 2” but not less than that determined by the following criteria and design.
 - Case 1 Circular or rectangular solid base plates with the upright pole welded to the top surface of base plate with full penetration butt weld, and where no stiffeners are provided. A base plate with a small center hole, which is less than 1/5 of the upright diameter, and located concentrically with the upright pole, may be considered as a solid base plate.

The magnitude of bending moment in the base plate, induced by the anchoring force of each anchor bolt shall be calculated using equation $M = (P \times D_1) / 2$.
 - Case 2 Circular or rectangular base plate with the upright pole socketed into and attached to the base plate with two lines of fillet weld, and where no stiffeners are provided, or any base plate with a center hole that is larger in diameter than 1/5 of the upright diameter.

The magnitude of bending moment induced by the anchoring force of each anchor bolt shall be calculated using equation $M = P \times D_2$.

 - M, bending moment at the critical section of the base plate induced by one anchor bolt
 - P, anchoring force of each anchor bolt
 - D₁, horizontal distance between the center of the anchor bolt and the outer face of the upright, or the difference between the radius of the bolt circle and the outside radius of the upright
 - D₂, horizontal distance between the face of the upright and the face of the anchor bolt nut
- The critical section shall be located at the face of the anchor bolt and perpendicular to the radius of the bolt circle. The overlapped part of two adjacent critical sections shall be considered ineffective.
- The thickness of base plate of Case 1 shall not be less than that calculated based on formula for Case 2.
- Uprights, foundations, and trusses shall be designed in accordance with the DMS Foundation Special Provision for the effects of torsion. Torsion shall be considered from

dead load eccentricity of these attachments, as well as for attachments such as walkway platforms, supporting brackets, etc., that add to the torsion in the assembly. Truss vertical and horizontal truss diagonals in particular and any other assembly members shall be appropriately sized for these loads.

- Uprights, foundations, and trusses shall be designed for the proposed sign wind area and future wind areas. The design shall consider the effect of torsion induced by the eccentric force location of the center of wind force above (or below) the center of the supporting truss. Truss vertical and horizontal truss diagonals in particular and any other assembly members shall be appropriately sized for these loads.

Fabricate the supporting structures using tubular members of either aluminum or steel, using only one type of material throughout the project.

Horizontal components of the supporting structures for overhead DMS must be of a truss design to support the DMS. Truss centerline must coincide with centerline of the DMS design area shown on the structure line drawing. Provide permanent camber in addition to dead load camber in accordance with the "Standard Specifications for Structural Supports for Highway Signs, Luminaires, and Traffic Signals." Indicate on the shop drawings the amount of camber provided and the method employed in the fabrication of the support to obtain the camber.

For all U-bolt connections of hanger beams to overhead assembly truss chords, provide all U-bolts with a flat washer, a lock washer and double nuts at each end of the U-bolts. All double nuts that are on any U-bolt shall be the same thickness and weight. When assembled, the double nuts shall be brought tight against each other by the use of two wrenches.

Fabricate attachment assemblies for the mounting DMS in a manner that allows easy removal of the sign.

11.4. MEASUREMENT AND PAYMENT

DMS Structure will be measured and paid as the actual number of dynamic message sign assemblies furnished, installed, and accepted. Payment includes all design, fabrication, construction, transportation, and attachment of the complete dynamic message sign assemblies, supporting structure, hardware, direct tension indicators, preparing and furnishing shop drawings, additional documentation, incidentals, and all other equipment and features necessary to furnish the system described above.

Payment will be made under:

Pay Item	Pay Unit
DMS Structure	Each

12. SOIL TEST FOR DMS FOUNDATION

12.1. DESCRIPTION

Perform a soil test for each DMS foundation location according to the requirements described below.

It is assumed that all foundation designs will be drilled pier foundations unless site-specific soil test information does not allow for a drilled pier foundation design. If an alternative foundation

design is required, notify the Engineer immediately. Prior approval from the Engineer is required to receive additional compensation for an alternate foundation design.

Design all custom foundations to carry the maximum capacity of each DMS structure.

When poor soil conditions are encountered, which could create an excessively large foundation design, consideration may be given to allowing an exemption to the maximum capacity design. The contractor must gain approval from the Engineer before reducing a foundation's capacity. Where poor soil is known to be present, it is advisable that the contractor receive approval for foundation designs before releasing poles for fabrication.

12.2. SOIL TEST

A. General

Drilled piers are reinforced concrete sections, cast in place against in situ, undisturbed material. Drilled piers are of straight shaft type and vertical.

The contractor-selected pole fabricator is responsible for determining if the addition of wing walls is necessary for the supporting foundations.

B. Soil Test

Perform a soil test at each proposed DMS pedestal location. Complete all required fill placement and excavation at each pedestal location to finished grade before drilling each boring. Soil tests performed that are not in compliance with this requirement may be rejected and will not be paid. Drill one boring to a depth of 26 feet within a 25-foot radius of each proposed foundation.

Perform standard penetration tests (SPT) in accordance with ASTM D 1586 at depths of 1, 2.5, 5, 7.5, 10, 15, 20 and 26 feet. Discontinue the boring if one of the following occurs:

- A total of 100 blows have been applied in any 2 consecutive 6-in. intervals
- A total of 50 blows have been applied with < 3-in. penetration

Submit completed boring logs collected in accordance with these Project Special Provisions DMS load information to the contractor-selected pedestal fabricator to assist in the pedestal and foundation design.

Describe each DMS pedestal location along the project corridor in a manner that is easily discernible to both the contractor's designer and NCDOT reviewers. If a DMS pedestal is at an intersection, label the boring the "Intersection of (*Route or SR #*), (*Street Name*) and (*Route or SR #*), (*Street Name*), _____ County. Label borings with "B- *N, S, E, W, NE, NW, SE or SW*" corresponding to the quadrant location within the intersection.

Pedestal numbers should be made available to the geotechnical drilling Contractor. Include pedestal numbers in the boring label if they are available. If they are not available, ensure the boring labels can be cross-referenced to corresponding pedestal numbers or pedestal locations.

For each boring, submit a legible (hand written or typed) boring log signed and sealed by a licensed Geologist or Professional Engineer registered in North Carolina. Include on each boring the SPT blow counts and N-values at each depth, depth of the boring, and a general description of the soil types encountered.

Borings that can't be easily related to their specific pedestal location will be returned to the contractor for clarification, or if approved by the Engineer, the foundation may be designed using the worst-case soil condition obtained as part of this project.

12.3. MEASUREMENT AND PAYMENT

Soil test for DMS foundation will be measured and paid as the actual number of Soil Tests with SPT borings drilled, furnished and accepted.

Payment will be made under:

Soil Test for DMS Foundation.....Each

13. DYNAMIC MESSAGE SIGN FOUNDATIONS

13.1. DESCRIPTION

Sign foundations include foundations for overhead and dynamic message signs (DMS) supported by metal poles or upright trusses. Sign foundations consist of footings with pedestals or drilled piers with or without grade beams or wings, conduit and anchor rod assemblies. Construct sign foundations in accordance with the contract and accepted submittals. Define “cantilever sign” as an overhead cantilever sign support in accordance with Figure 1-1 of the *AASHTO Standard Specifications for Structural Supports for Highway Signs, Luminaries, and Traffic Signals*, 5th Edition, 2009, including the latest interim specifications.

13.2. MATERIALS

Use sign foundation materials that meet the Foundations and Anchor Rod Assemblies for Metal Poles provision.

A. Assumed Subsurface Conditions

Assume the following soil parameters and groundwater elevation for sign foundations unless these subsurface conditions are not applicable to sign locations:

- A. Unit weight (γ) = 120 lb/cuff,
- B. Friction angle (c_j) = 30°F,
- C. Cohesion (c) = 0 lb/sf, and
- D. Groundwater 7 ft below finished grade.

A subsurface investigation is required if the Engineer determines these assumed subsurface conditions do not apply to a sign location and the sign cannot be moved. Subsurface conditions requiring a subsurface investigation include but are not limited to weathered or hard rock, boulders, very soft or loose soil, muck or shallow groundwater. No extension of completion date or time will be allowed for subsurface investigations.

B. Subsurface Investigations

Use a prequalified geotechnical consultant to perform one standard penetration test

(SPT) boring in accordance with ASTM D1586 at each sign location requiring a subsurface investigation. Rough grade sign locations to within 2 ft of finished grade before beginning drilling.

Drill borings to 2 drilled pier diameters below anticipated pier tip elevations or refusal, whichever is higher.

Use the computer software gINT version 8.0 or later manufactured by Bentley Systems, Inc. with the current NCDOT gINT library and data template to produce SPT boring logs. Provide boring logs sealed by a geologist or engineer licensed in the state of North Carolina.

C. Sign Foundation Designs

Design sign foundations for the wind zone and clearances shown in the foundation design plans and the slope of finished grade at each sign location. Use the assumed soil parameters and groundwater elevation above for sign foundation designs unless a subsurface investigation is required. For sign locations requiring a subsurface investigation, design sign foundations for the subsurface conditions at each sign location. Design footings, pedestals, drilled piers, grade beams and wings in accordance with the 5th Edition of the *AASHTO Standard Specifications for Structural Supports for Highway Signs, Luminaries, and Traffic Signals*, 5th Edition, 2009, including the latest interim specifications. In some instances, conflicts with drainage structures may dictate sign foundation types.

Design footings in accordance with Section 4.4 of the *AASHTO Standard Specifications for Highway Bridges*. Do not use an allowable bearing pressure of more than 3,000 lb/sf for footings.

Design drilled piers for side resistance only in accordance with Section 4.6 of the *AASHTO Standard Specifications for Highway Bridges* except reduce ultimate side resistance by 25% for uplift. Use the computer software LPILE version 5.0 or later manufactured by Ensoft, Inc. to analyze drilled piers. Provide drilled pier designs with a horizontal deflection of less than 1" at top of piers. For cantilever signs with single drilled pier foundations supporting metal poles, use wings to resist torsion forces. Provide drilled pier designs with a factor of safety of at least 2.0 for torsion.

For drilled pier sign foundations supporting upright trusses, use dual drilled piers connected with a grade beam having a moment of inertia approximately equal to that of either pier. The Broms' method is acceptable to analyze drilled piers with grade beams instead of LPILE. Use a safety factor of at least 3.5 for the Broms' design method in accordance with C13.6.1.1 of the *AASHTO Standard*

Specifications for Structural Supports for Highway Signs, Luminaries, and Traffic Signals, 5th Edition, 2009, including the latest interim specifications.

Submit boring logs, if any, working drawings and design calculations for acceptance in accordance with Article 105-2 of the *2018 Standard Specifications*. Submit working drawings showing plan views, required foundation dimensions and elevations and typical sections with reinforcement, conduit, and anchor rod assembly details. Include all boring logs, design calculations and LPILE output for sign foundation design submittals. Have sign foundations designed, detailed, and sealed by an engineer licensed in the state of North Carolina.

13.3. CONSTRUCTION METHODS

Construct footings, pedestals, drilled piers, grade beams and wings and install anchor rod assemblies for sign foundations in accordance with the Foundations and Anchor Rod Assemblies for Metal Poles provision.

13.4. MEASUREMENT AND PAYMENT

DMS foundation will be measured and paid in cubic yards of concrete for footings, pedestals, drilled piers, grade beams and wings shown on the accepted submittals. The contract unit price for

DMS foundation will be full compensation for providing labor, tools, equipment, and foundation materials, stabilizing, or shoring excavations and supplying concrete, reinforcing steel, conduit, anchor rod assemblies and any incidentals necessary to construct sign foundations. Subsurface investigations required by the Engineer will be paid as extra work in accordance with Article 104-7 of the 2018 Standard Specifications.

Payment will be made under:

Pay Item	Pay Unit
DMS Foundation	Cubic Yards

14. BACK PULL FIBER OPTIC CABLE

14.1. DESCRIPTION

Back pull and store or back pull and reinstall existing communications cable.

14.1. CONSTRUCTION

During project construction where instructed to back pull existing aerial sections of fiber optic communications cable, de-lash the cable from the messenger cable and back pull the cable to a point where it can be stored or re-routed as shown on the plans. If instructed, remove and discard the existing messenger cable and pole mounting hardware once the cable is safely out of harm’s way.

During project construction where instructed to back pull existing underground sections of fiber optic communications cable, back pull the cable to a point where it can be stored or re-routed as shown on the plans. If instructed, remove abandoned junction boxes and backfill with a suitable material to match the existing grade. Leave abandoned conduits in place unless otherwise noted.

Where instructed, re-pull the fiber optic cable back along messenger cable or through conduit systems.

14.2. MEASUREMENT AND PAYMENT

Back Pull Fiber Optic Cable will be paid for as the actual linear feet of fiber optic cable back pulled and either stored or back pulled and rerouted. Payment is for the actual linear feet of cable back pulled.

No payment will be made for removing messenger cable and pole mounting hardware or removing junction boxes and back filling to match the surrounding grade as these items of work will be considered incidental to back pulling the fiber optic cable.

Payment will be made under:

Back Pull Fiber Optic Cable	Linear Feet
-----------------------------------	-------------

ST-1

U-4405A

Cumberland County

PROJECT SPECIAL PROVISION

CULVERT

TABLE OF CONTENTS

Falsework and Formwork	ST – 2
Submittal of Working Drawings.....	ST – 9
Crane Safety	ST – 15
Grout for Structures.....	ST – 16

DocuSigned by:
Samuel Cullum
 19C97095C75A467...
 8/24/2021



FALSEWORK AND FORMWORK**(4-5-12)****1.0 DESCRIPTION**

Use this Special Provision as a guide to develop temporary works submittals required by the Standard Specifications or other provisions; no additional submittals are required herein. Such temporary works include, but are not limited to, falsework and formwork.

Falsework is any temporary construction used to support the permanent structure until it becomes self-supporting. Formwork is the temporary structure or mold used to retain plastic or fluid concrete in its designated shape until it hardens. Access scaffolding is a temporary structure that functions as a work platform that supports construction personnel, materials, and tools, but is not intended to support the structure. Scaffolding systems that are used to temporarily support permanent structures (as opposed to functioning as work platforms) are considered to be falsework under the definitions given. Shoring is a component of falsework such as horizontal, vertical, or inclined support members. Where the term “temporary works” is used, it includes all of the temporary facilities used in bridge construction that do not become part of the permanent structure.

Design and construct safe and adequate temporary works that will support all loads imposed and provide the necessary rigidity to achieve the lines and grades shown on the plans in the final structure.

2.0 MATERIALS

Select materials suitable for temporary works; however, select materials that also ensure the safety and quality required by the design assumptions. The Engineer has authority to reject material on the basis of its condition, inappropriate use, safety, or nonconformance with the plans. Clearly identify allowable loads or stresses for all materials or manufactured devices on the plans. Revise the plan and notify the Engineer if any change to materials or material strengths is required.

3.0 DESIGN REQUIREMENTS**A. Working Drawings**

Provide working drawings for items as specified in the contract, or as required by the Engineer, with design calculations and supporting data in sufficient detail to permit a structural and safety review of the proposed design of the temporary work.

On the drawings, show all information necessary to allow the design of any component to be checked independently as determined by the Engineer.

When concrete placement is involved, include data such as the drawings of proposed sequence, rate of placement, direction of placement, and location of all construction joints. Submit the number of copies as called for by the contract.

ST-3

U-4405A

Cumberland County

When required, have the drawings and calculations prepared under the guidance of, and sealed by, a North Carolina Registered Professional Engineer who is knowledgeable in temporary works design.

If requested by the Engineer, submit with the working drawings manufacturer's catalog data listing the weight of all construction equipment that will be supported on the temporary work. Show anticipated total settlements and/or deflections of falsework and forms on the working drawings. Include falsework footing settlements, joint take-up, and deflection of beams or girders.

As an option for the Contractor, overhang falsework hangers may be uniformly spaced, at a maximum of 36 inches, provided the following conditions are met:

Member Type (PCG)	Member Depth, (inches)	Max. Overhang Width, (inches)	Max. Slab Edge Thickness, (inches)	Max. Screenshot Wheel Weight, (lbs.)	Bracket Min. Vertical Leg Extension, (inches)
II	36	39	14	2000	26
III	45	42	14	2000	35
IV	54	45	14	2000	44
MBT	63	51	12	2000	50
MBT	72	55	12	1700	48

Overhang width is measured from the centerline of the girder to the edge of the deck slab.

For Type II, III & IV prestressed concrete girders (PCG), 45-degree cast-in-place half hangers and rods must have a minimum safe working load of 6,000 lbs.

For MBT prestressed concrete girders, 45-degree angle holes for falsework hanger rods shall be cast through the girder top flange and located, measuring along the top of the member, 1'-2 1/2" from the edge of the top flange. Hanger hardware and rods must have a minimum safe working load of 6,000 lbs.

The overhang bracket provided for the diagonal leg shall have a minimum safe working load of 3,750 lbs. The vertical leg of the bracket shall extend to the point that the heel bears on the girder bottom flange, no closer than 4 inches from the bottom of the member. However, for 72-inch members, the heel of the bracket shall bear on the web, near the bottom flange transition.

Provide adequate overhang falsework and determine the appropriate adjustments for deck geometry, equipment, casting procedures and casting conditions.

If the optional overhang falsework spacing is used, indicate this on the falsework submittal and advise the girder producer of the proposed details. Failure to notify the Engineer of hanger type and hanger spacing on prestressed concrete girder casting drawings may delay the approval of those drawings.

ST-4

U-4405A

Cumberland County

Falsework hangers that support concentrated loads and are installed at the edge of thin top flange concrete girders (such as bulb tee girders) shall be spaced so as not to exceed 75% of the manufacturer's stated safe working load. Use of dual leg hangers (such as Meadow Burke HF-42 and HF-43) are not allowed on concrete girders with thin top flanges. Design the falsework and forms supporting deck slabs and overhangs on girder bridges so that there will be no differential settlement between the girders and the deck forms during placement of deck concrete.

When staged construction of the bridge deck is required, detail falsework and forms for screed and fluid concrete loads to be independent of any previous deck pour components when the mid-span girder deflection due to deck weight is greater than $\frac{3}{4}$ ".

Note on the working drawings any anchorages, connectors, inserts, steel sleeves or other such devices used as part of the falsework or formwork that remains in the permanent structure. If the plan notes indicate that the structure contains the necessary corrosion protection required for a Corrosive Site, epoxy coat, galvanize or metalize these devices. Electroplating will not be allowed. Any coating required by the Engineer will be considered incidental to the various pay items requiring temporary works.

ST-5

U-4405A

Cumberland County

Design falsework and formwork requiring submittals in accordance with the 1995 AASHTO *Guide Design Specifications for Bridge Temporary Works* except as noted herein.

1. Wind Loads

Table 2.2 of Article 2.2.5.1 is modified to include wind velocities up to 110 mph. In addition, Table 2.2A is included to provide the maximum wind speeds by county in North Carolina.

Table 2.2 - Wind Pressure Values

Height Zone feet above ground	Pressure, lb/ft ² for Indicated Wind Velocity, mph				
	70	80	90	100	110
0 to 30	15	20	25	30	35
30 to 50	20	25	30	35	40
50 to 100	25	30	35	40	45
over 100	30	35	40	45	50

2. Time of Removal

The following requirements replace those of Article 3.4.8.2.

Do not remove forms until the concrete has attained strengths required in Article 420-16 of the Standard Specifications and these Special Provisions.

Do not remove forms until the concrete has sufficient strength to prevent damage to the surface.

ST-6

U-4405A

Cumberland County

Table 2.2A - Steady State Maximum Wind Speeds by Counties in North Carolina

COUNTY	25 YR (mph)	COUNTY	25 YR (mph)	COUNTY	25 YR (mph)
Alamance	70	Franklin	70	Pamlico	100
Alexander	70	Gaston	70	Pasquotank	100
Alleghany	70	Gates	90	Pender	100
Anson	70	Graham	80	Perquimans	100
Ashe	70	Granville	70	Person	70
Avery	70	Greene	80	Pitt	90
Beaufort	100	Guilford	70	Polk	80
Bertie	90	Halifax	80	Randolph	70
Bladen	90	Harnett	70	Richmond	70
Brunswick	100	Haywood	80	Robeson	80
Buncombe	80	Henderson	80	Rockingham	70
Burke	70	Hertford	90	Rowan	70
Cabarrus	70	Hoke	70	Rutherford	70
Caldwell	70	Hyde	110	Sampson	90
Camden	100	Iredell	70	Scotland	70
Carteret	110	Jackson	80	Stanley	70
Caswell	70	Johnston	80	Stokes	70
Catawba	70	Jones	100	Surry	70
Cherokee	80	Lee	70	Swain	80
Chatham	70	Lenoir	90	Transylvania	80
Chowan	90	Lincoln	70	Tyrell	100
Clay	80	Macon	80	Union	70
Cleveland	70	Madison	80	Vance	70
Columbus	90	Martin	90	Wake	70
Craven	100	McDowell	70	Warren	70
Cumberland	80	Mecklenburg	70	Washington	100
Currituck	100	Mitchell	70	Watauga	70
Dare	110	Montgomery	70	Wayne	80
Davidson	70	Moore	70	Wilkes	70
Davie	70	Nash	80	Wilson	80
Duplin	90	New Hanover	100	Yadkin	70
Durham	70	Northampton	80	Yancey	70
Edgecombe	80	Onslow	100		
Forsyth	70	Orange	70		

B. Review and Approval

The Engineer is responsible for the review and approval of temporary works' drawings.

Submit the working drawings sufficiently in advance of proposed use to allow for their review, revision (if needed), and approval without delay to the work.

The time period for review of the working drawings does not begin until complete drawings and design calculations, when required, are received by the Engineer.

Do not start construction of any temporary work for which working drawings are required until the drawings have been approved. Such approval does not relieve the Contractor of the responsibility for the accuracy and adequacy of the working drawings.

4.0 CONSTRUCTION REQUIREMENTS

All requirements of Section 420 of the Standard Specifications apply.

Construct temporary works in conformance with the approved working drawings. Ensure that the quality of materials and workmanship employed is consistent with that assumed in the design of the temporary works. Do not weld falsework members to any portion of the permanent structure unless approved. Show any welding to the permanent structure on the approved construction drawings.

Provide tell-tales attached to the forms and extending to the ground, or other means, for accurate measurement of falsework settlement. Make sure that the anticipated compressive settlement and/or deflection of falsework does not exceed 1 inch. For cast-in-place concrete structures, make sure that the calculated deflection of falsework flexural members does not exceed 1/240 of their span regardless of whether or not the deflection is compensated by camber strips.

A. Maintenance and Inspection

Inspect and maintain the temporary work in an acceptable condition throughout the period of its use. Certify that the manufactured devices have been maintained in a condition to allow them to safely carry their rated loads. Clearly mark each piece so that its capacity can be readily determined at the job site.

Perform an in-depth inspection of an applicable portion(s) of the temporary works, in the presence of the Engineer, not more than 24 hours prior to the beginning of each concrete placement. Inspect other temporary works at least once a month to ensure that they are functioning properly. Have a North Carolina Registered Professional Engineer inspect the cofferdams, shoring, sheathing, support of excavation structures, and support systems for load tests prior to loading.

ST-8

U-4405A

Cumberland County

B. Foundations

Determine the safe bearing capacity of the foundation material on which the supports for temporary works rest. If required by the Engineer, conduct load tests to verify proposed bearing capacity values that are marginal or in other high-risk situations.

The use of the foundation support values shown on the contract plans of the permanent structure is permitted if the foundations are on the same level and on the same soil as those of the permanent structure.

Allow for adequate site drainage or soil protection to prevent soil saturation and washout of the soil supporting the temporary works supports.

If piles are used, the estimation of capacities and later confirmation during construction using standard procedures based on the driving characteristics of the pile is permitted. If preferred, use load tests to confirm the estimated capacities; or, if required by the Engineer conduct load tests to verify bearing capacity values that are marginal or in other high risk situations.

The Engineer reviews and approves the proposed pile and soil bearing capacities.

5.0 REMOVAL

Unless otherwise permitted, remove and keep all temporary works upon completion of the work. Do not disturb or otherwise damage the finished work.

Remove temporary works in conformance with the contract documents. Remove them in such a manner as to permit the structure to uniformly and gradually take the stresses due to its own weight.

6.0 METHOD OF MEASUREMENT

Unless otherwise specified, temporary works will not be directly measured.

7.0 BASIS OF PAYMENT

Payment at the contract unit prices for the various pay items requiring temporary works will be full compensation for the above falsework and formwork.

SUBMITTAL OF WORKING DRAWINGS**(1-29-21)****1.0 GENERAL**

Submit working drawings in accordance with Article 105-2 of the *Standard Specifications* and this provision. For this provision, “submittals” refers to only those listed in this provision. The list of submittals contained herein does not represent a list of required submittals for the project. Submittals are only necessary for those items as required by the contract. Make submittals that are not specifically noted in this provision directly to the Engineer. Either the Structures Management Unit or the Geotechnical Engineering Unit or both units will jointly review submittals.

If a submittal contains variations from plan details or specifications or significantly affects project cost, field construction or operations, discuss the submittal with and submit all copies to the Engineer. State the reason for the proposed variation in the submittal. To minimize review time, make sure all submittals are complete when initially submitted. Provide a contact name and information with each submittal. Direct any questions regarding submittal requirements to the Engineer, Structures Management Unit contacts or the Geotechnical Engineering Unit contacts noted below.

In order to facilitate in-plant inspection by NCDOT and approval of working drawings, provide the name, address and telephone number of the facility where fabrication will actually be done if different than shown on the title block of the submitted working drawings. This includes, but is not limited to, precast concrete items, prestressed concrete items and fabricated steel or aluminum items.

2.0 ADDRESSES AND CONTACTS

For submittals to the Structures Management Unit, use the following addresses:

Via US mail:

Mr. B. C. Hanks, P. E.
State Structures Engineer
North Carolina Department
of Transportation
Structures Management Unit
1581 Mail Service Center
Raleigh, NC 27699-1581

Attention: Mr. J. L. Bolden, P. E.

Via other delivery service:

Mr. B. C. Hanks, P. E.
State Structures Engineer
North Carolina Department
of Transportation
Structures Management Unit
1000 Birch Ridge Drive
Raleigh, NC 27610

Attention: Mr. J. L. Bolden, P. E.

Submittals may also be made via email.

Send submittals to:

jlbolden@ncdot.gov (James Bolden)

Send an additional e-copy of the submittal to the following address:

eomile@ncdot.gov (Emmanuel Omile)

ST-10

U-4405A

Cumberland County

mrorie@ncdot.gov (Madonna Rorie)

For submittals to the Geotechnical Engineering Unit, use the following addresses:

For projects in Divisions 1-7, use the following Eastern Regional Office address:

Via US mail:

Mr. David Hering, L. G., P. E.
Eastern Regional Geotechnical
Manager
North Carolina Department
of Transportation
Geotechnical Engineering Unit
Eastern Regional Office
1570 Mail Service Center
Raleigh, NC 27699-1570

Via other delivery service:

Mr. David Hering, L. G., P. E.
Eastern Regional Geotechnical
Manager
North Carolina Department
of Transportation
Geotechnical Engineering Unit
Eastern Regional Office
3301 Jones Sausage Road, Suite 100
Garner, NC 27529

Via Email: EastGeotechnicalSubmittal@ncdot.gov

For projects in Divisions 8-14, use the following Western Regional Office address:

Via US mail or other delivery service:

Mr. Eric Williams, P. E.
Western Regional Geotechnical
Manager
North Carolina Department
of Transportation
Geotechnical Engineering Unit
Western Regional Office
5253 Z Max Boulevard
Harrisburg, NC 28075

Via Email: WestGeotechnicalSubmittal@ncdot.gov

The status of the review of structure-related submittals sent to the Structures Management Unit can be viewed from the Unit's website, via the "Drawing Submittal Status" link.

The status of the review of geotechnical-related submittals sent to the Geotechnical Engineering Unit can be viewed from the Unit's website, via the "Geotechnical Construction Submittals" link.

Direct any questions concerning submittal review status, review comments or drawing markups to the following contacts:

Primary Structures Contact:

James Bolden (919) 707 – 6408
(919) 250 – 4082 facsimile
jlbolden@ncdot.gov

ST-11

U-4405A

Cumberland County

Secondary Structures Contacts: Emmanuel Omile (919) 707 – 6451
 Madonna Rorie (919) 707 – 6508

Eastern Regional Geotechnical Contact (Divisions 1-7):
 David Hering (919) 662 – 4710
dthering@ncdot.gov

Western Regional Geotechnical Contact (Divisions 8-14):
 Eric Williams (704) 455 – 8902
ewilliams3@ncdot.gov

3.0 SUBMITTAL COPIES

Furnish one complete copy of each submittal, including all attachments, to the Engineer. At the same time, submit the number of hard copies shown below of the same complete submittal directly to the Structures Management Unit and/or the Geotechnical Engineering Unit.

The first table below covers “Structure Submittals”. The Engineer will receive review comments and drawing markups for these submittals from the Structures Management Unit. The second table in this section covers “Geotechnical Submittals”. The Engineer will receive review comments and drawing markups for these submittals from the Geotechnical Engineering Unit.

Unless otherwise required, submit one set of supporting calculations to either the Structures Management Unit or the Geotechnical Engineering Unit unless both units require submittal copies in which case submit a set of supporting calculations to each unit. Provide additional copies of any submittal as directed.

STRUCTURE SUBMITTALS

Submittal	Copies Required by Structures Management Unit	Copies Required by Geotechnical Engineering Unit	Contract Reference Requiring Submittal ¹
Arch Culvert Falsework	5	0	Plan Note, SN Sheet & “Falsework and Formwork”
Box Culvert Falsework ⁷	5	0	Plan Note, SN Sheet & “Falsework and Formwork”
Cofferdams	6	2	Article 410-4
Foam Joint Seals ⁶	9	0	“Foam Joint Seals”

ST-12

U-4405A

Cumberland County

Expansion Joint Seals (hold down plate type with base angle)	9	0	“Expansion Joint Seals”
Expansion Joint Seals (modular)	2, then 9	0	“Modular Expansion Joint Seals”
Expansion Joint Seals (strip seals)	9	0	“Strip Seals”
Falsework & Forms ² (substructure)	8	0	Article 420-3 & “Falsework and Formwork”
Falsework & Forms (superstructure)	8	0	Article 420-3 & “Falsework and Formwork”
Girder Erection over Railroad	5	0	Railroad Provisions
Maintenance and Protection of Traffic Beneath Proposed Structure	8	0	“Maintenance and Protection of Traffic Beneath Proposed Structure at Station ____”
Metal Bridge Railing	8	0	Plan Note
Metal Stay-in-Place Forms	8	0	Article 420-3
Metalwork for Elastomeric Bearings ^{4,5}	7	0	Article 1072-8
Miscellaneous Metalwork ^{4,5}	7	0	Article 1072-8
Disc Bearings ⁴	8	0	“Disc Bearings”
Overhead and Digital Message Signs (DMS) (metalwork and foundations)	13	0	Applicable Provisions
Placement of Equipment on Structures (cranes, etc.)	7	0	Article 420-20
Precast Concrete Box Culverts	2, then 1 reproducible	0	“Optional Precast Reinforced Concrete Box Culvert at Station ____”
Prestressed Concrete Cored Slab (detensioning sequences) ³	6	0	Article 1078-11
Prestressed Concrete Deck Panels	6 and 1 reproducible	0	Article 420-3

ST-13

U-4405A

Cumberland County

Prestressed Concrete Girder (strand elongation and detensioning sequences)	6	0	Articles 1078-8 and 1078-11
Removal of Existing Structure over Railroad	5	0	Railroad Provisions
Revised Bridge Deck Plans (adaptation to prestressed deck panels)	2, then 1 reproducible	0	Article 420-3
Revised Bridge Deck Plans (adaptation to modular expansion joint seals)	2, then 1 reproducible	0	“Modular Expansion Joint Seals”
Sound Barrier Wall (precast items)	10	0	Article 1077-2 & “Sound Barrier Wall”
Sound Barrier Wall Steel Fabrication Plans ⁵	7	0	Article 1072-8 & “Sound Barrier Wall”
Structural Steel ⁴	2, then 7	0	Article 1072-8
Temporary Detour Structures	10	2	Article 400-3 & “Construction, Maintenance and Removal of Temporary Structure at Station _____”
TFE Expansion Bearings ⁴	8	0	Article 1072-8

FOOTNOTES

1. References are provided to help locate the part of the contract where the submittals are required. References in quotes refer to the provision by that name. Articles refer to the *Standard Specifications*.
2. Submittals for these items are necessary only when required by a note on plans.
3. Submittals for these items may not be required. A list of pre-approved sequences is available from the producer or the Materials & Tests Unit.
4. The fabricator may submit these items directly to the Structures Management Unit.
5. The two sets of preliminary submittals required by Article 1072-8 of the *Standard Specifications* are not required for these items.
6. Submittals for Fabrication Drawings are not required. Submittals for Catalogue Cuts of Proposed Material are required. See Section 5.A of the referenced provision.
7. Submittals are necessary only when the top slab thickness is 18” or greater.

ST-14

U-4405A

Cumberland County

GEOTECHNICAL SUBMITTALS

Submittal	Copies Required by Geotechnical Engineering Unit	Copies Required by Structures Management Unit	Contract Reference Requiring Submittal ¹
Drilled Pier Construction Plans ²	1	0	Subarticle 411-3(A)
Crosshole Sonic Logging (CSL) Reports ²	1	0	Subarticle 411-5(A)(2)
Pile Driving Equipment Data Forms ^{2,3}	1	0	Subarticle 450-3(D)(2)
Pile Driving Analyzer (PDA) Reports ²	1	0	Subarticle 450-3(F)(3)
Retaining Walls ⁴	1 drawings, 1 calculations	2 drawings	Applicable Provisions
Temporary Shoring ⁴	1 drawings, 1 calculations	2 drawings	“Temporary Shoring” & “Temporary Soil Nail Walls”

FOOTNOTES

- References are provided to help locate the part of the contract where the submittals are required. References in quotes refer to the provision by that name. Subarticles refer to the *Standard Specifications*.
- Submit one hard copy of submittal to the Engineer. Submit a second copy of submittal electronically (PDF via email), US mail or other delivery service to the appropriate Geotechnical Engineering Unit regional office. Electronic submission is preferred.
- The Pile Driving Equipment Data Form is available from:
https://connect.ncdot.gov/resources/Geological/Pages/Geotech_Forms_Details.aspx
See second page of form for submittal instructions.
- Electronic copy of submittal is required. See referenced provision.

ST-15

U-4405A

Cumberland County

CRANE SAFETY

(6-20-19)

Comply with the manufacturer specifications and limitations applicable to the operation of any and all cranes and derricks. Prime contractors, sub-contractors, and fully operated rental companies shall comply with the current Occupational Safety and Health Administration (OSHA) regulations.

Submit all items listed below to the Engineer prior to beginning crane operations. Changes in personnel or equipment must be reported to the Engineer and all applicable items listed below must be updated and submitted prior to continuing with crane operations.

CRANE SAFETY SUBMITTAL LIST

- A. **Competent Person:** Provide the name and qualifications of the “Competent Person” responsible for crane safety and lifting operations. The named competent person will have the responsibility and authority to stop any work activity due to safety concerns.
- B. **Riggers:** Provide the qualifications and experience of the persons responsible for rigging operations. Qualifications and experience should include, but not be limited to, weight calculations, center of gravity determinations, selection and inspection of sling and rigging equipment, and safe rigging practices.
- C. **Crane Inspections:** Inspection records for all cranes shall be current and readily accessible for review upon request.
- D. **Certifications:** Crane operators shall be certified by the National Commission for the Certification of Crane Operators (NCCCO) or the National Center for Construction Education and Research (NCCER). Other approved nationally accredited programs will be considered upon request. In addition, crane operators shall have a current CDL medical card. Submit a list of crane operator(s) and include current certification for each type of crane operated (small hydraulic, large hydraulic, small lattice, large lattice) and medical evaluations for each operator.

ST-16

U-4405A

Cumberland County

GROUT FOR STRUCTURES

(12-1-17)

1.0 DESCRIPTION

This special provision addresses grout for use in pile blockouts, grout pockets, shear keys, dowel holes and recesses for structures. This provision does not apply to grout placed in post-tensioning ducts for bridge beams, girders, decks, end bent caps, or bent caps. Mix and place grout in accordance with the manufacturer's recommendations, the applicable sections of the Standard Specifications and this provision.

2.0 MATERIAL REQUIREMENTS

Unless otherwise noted on the plans, use a Type 3 Grout in accordance with Section 1003 of the Standard Specifications.

Initial setting time shall not be less than 10 minutes when tested in accordance with ASTM C266.

Construction loading and traffic loading shall not be allowed until the 3 day compressive strength is achieved.

3.0 SAMPLING AND PLACEMENT

Place and maintain components in final position until grout placement is complete and accepted. Concrete surfaces to receive grout shall be free of defective concrete, laitance, oil, grease and other foreign matter. Saturate concrete surfaces with clean water and remove excess water prior to placing grout.

4.0 BASIS OF PAYMENT

No separate payment will be made for "Grout for Structures". The cost of the material, equipment, labor, placement, and any incidentals necessary to complete the work shall be considered incidental to the structure item requiring grout.

PROJECT SPECIAL PROVISION

(10-18-95) (Rev. 3-21-17)

Z-1

PERMITS

The Contractor's attention is directed to the following permits, which have been issued to the Department of Transportation by the authority granting the permit.

<u>PERMIT</u>	<u>AUTHORITY GRANTING THE PERMIT</u>
Dredge and Fill and/or Work in Navigable Waters (404)	U. S. Army Corps of Engineers
Water Quality (401)	Division of Environmental Management, DEQ State of North Carolina

The Contractor shall comply with all applicable permit conditions during construction of this project. Those conditions marked by * are the responsibility of the Department and the Contractor has no responsibility in accomplishing those conditions.

Agents of the permitting authority will periodically inspect the project for adherence to the permits.

The Contractor's attention is also directed to Articles 107-10 and 107-13 of the *2018 Standard Specifications* and the following:

Should the Contractor propose to utilize construction methods (such as temporary structures or fill in waters and/or wetlands for haul roads, work platforms, cofferdams, etc.) not specifically identified in the permit (individual, general, or nationwide) authorizing the project it shall be the Contractor's responsibility to coordinate with the Engineer to determine what, if any, additional permit action is required. The Contractor shall also be responsible for initiating the request for the authorization of such construction method by the permitting agency. The request shall be submitted through the Engineer. The Contractor shall not utilize the construction method until it is approved by the permitting agency. The request normally takes approximately 60 days to process; however, no extensions of time or additional compensation will be granted for delays resulting from the Contractor's request for approval of construction methods not specifically identified in the permit.

Where construction moratoriums are contained in a permit condition which restricts the Contractor's activities to certain times of the year, those moratoriums will apply only to the portions of the work taking place in the restricted waters, wetlands or buffer zones, provided that activities outside those areas is done in such a manner as to not affect the restricted waters, wetlands or buffer zones.

DocuSigned by:

 68A7405FFA5F48E...

P-2
U.S. ARMY CORPS OF ENGINEERS
WILMINGTON DISTRICT

Action Id. SAW-2011-01806 County: Cumberland County U.S.G.S. Quad: Fayetteville

GENERAL PERMIT (REGIONAL AND NATIONWIDE) VERIFICATION

Permittee: **Mr. Phillip S. Harris, III, PE, CPM**
NC DOT-PDEA

Address: **1598 Mail Service Center**
Raleigh, NC 27699

Size (acres)	N/A	Nearest Town	<u>Fayetteville</u>
Nearest Waterway	<u>Beaver Creek</u>	River Basin	<u>Cape Fear</u>
USGS HUC	<u>03030004</u>	Coordinates	Latitude: <u>35.0413189656353</u> Longitude: <u>-78.9624331673919</u>

Location description: The project site is located along US 401 from SR 1409 (71st School Road) to US 401 Business (Robeson Street), in Fayetteville, Cumberland County, North Carolina.

Description of projects area and activity: This verification authorizes impacts to waters of the U.S. in association with an NC DOT road improvement project along an approximate 6- mile section of US 401 from SR 1409 (71st School Road) to US 401 Business (Robeson Street). The existing facility is a seven lane roadway with a center turn lane. The proposed facility will be a 6 lane roadway with a raised median. Permanent impacts total 0.21 acre wetlands filled, 840 linear feet of stream channel for and 0.23 acre open waters filled for culvert extensions, bank stabilization and utility line relocations.

Applicable Law: Section 404 (Clean Water Act, 33 USC 1344)
 Sections 10 (Rivers and Harbors Act, 33 USC 403)

Authorization: Regional General Permit Number or Nationwide Permit Number: **NWPs 14 and 12**
SEE ATTACHED RGP or NWP GENERAL, REGIONAL AND SPECIAL CONDITIONS

Your work is authorized by the above referenced permit provided it is accomplished in strict accordance with the attached conditions and your submitted application and attached information dated October 25, 2017. Any violation of the attached conditions or deviation from your submitted plans may subject the permittee to a stop work order, a restoration order, a Class I administrative penalty, and/or appropriate legal action.

This verification will remain valid until the expiration date identified below unless the nationwide authorization is modified, suspended or revoked. If, prior to the expiration date identified below, the nationwide permit authorization is reissued and/or modified, this verification will remain valid until the expiration date identified below, provided it complies with all requirements of the modified nationwide permit. If the nationwide permit authorization expires or is suspended, revoked, or is modified, such that the activity would no longer comply with the terms and conditions of the nationwide permit, activities which have commenced (i.e., are under construction) or are under contract to commence in reliance upon the nationwide permit, will remain authorized provided the activity is completed within twelve months of the date of the nationwide permit's expiration, modification or revocation, unless discretionary authority has been exercised on a case-by-case basis to modify, suspend or revoke the authorization.

Activities subject to Section 404 (as indicated above) may also require an individual Section 401 Water Quality Certification. You should contact the NC Division of Water Resources (telephone 919-807-6300) to determine Section 401 requirements.

For activities occurring within the twenty coastal counties subject to regulation under the Coastal Area Management Act (CAMA), prior to beginning work you must contact the N.C. Division of Coastal Management in Wilmington, NC, at (910) 796-7215.

This Department of the Army verification does not relieve the permittee of the responsibility to obtain any other required Federal, State or local approvals/permits.

If there are any questions regarding this verification, any of the conditions of the Permit, or the Corps of Engineers regulatory program, please contact Sarah Hair at (910) 251-4049 or Sarah.E.Hair@usace.army.mil.

Corps Regulatory Official: Liz Hair Date: December 1, 2017
Expiration Date of Verification: March 18, 2022

Determination of Jurisdiction:

- A. There are waters, including wetlands, on the above described project area that may be subject to Section 404 of the Clean Water Act (CWA) (33 USC § 1344) and/or Section 10 of the Rivers and Harbors Act (RHA) (33 USC § 403). This preliminary determination is not an appealable action under the Regulatory Program Administrative Appeal Process (Reference 33 CFR Part 331). However, you may request an approved JD, which is an appealable action, by contacting the Corps district for further instruction. Please note, if work is authorized by either a general or nationwide permit, and you wish to request an appeal of an approved JD, the appeal must be received by the Corps and the appeal process concluded prior to the commencement of any work in waters of the United States and prior to any work that could alter the hydrology of waters of the United States.
- B. There are Navigable Waters of the United States within the above described project area subject to the permit requirements of Section 10 of the Rivers and Harbors Act (RHA) (33 USC § 403) and Section 404 of the Clean Water Act (CWA) (33 USC § 1344). Unless there is a change in the law or our published regulations, this determination may be relied upon for a period not to exceed five years from the date of this notification.
- C. There are waters, including wetlands, within the above described project area that are subject to the permit requirements of Section 404 of the Clean Water Act (CWA) (33 USC § 1344). Unless there is a change in the law or our published regulations, this determination may be relied upon for a period not to exceed five years from the date of this notification.
- D. The jurisdictional areas within the above described project area have been identified under a previous action. Please reference jurisdictional determination issued August 9, 2012. Action ID: **SAW-2011-01806**.

Basis For Determination: *see previously verified PJD dated August 12, 2012

Remarks:

E. Attention USDA Program Participants

This delineation/determination has been conducted to identify the limits of Corps' Clean Water Act jurisdiction for the particular site identified in this request. The delineation/determination may not be valid for the wetland conservation provisions of the Food Security Act of 1985. If you or your tenant are USDA Program participants, or anticipate participation in USDA programs, you should request a certified wetland determination from the local office of the Natural Resources Conservation Service, prior to starting work.

F. Appeals Information (This information applies only to approved jurisdiction determinations as indicated in B and C above).

This correspondence constitutes an approved jurisdiction determination for the above described site. If you object to this determination, you may request an administrative appeal under Corps regulations at 33 CFR Part 331. Enclosed you will find a Notification of Appeal Process (NAP) fact sheet and request for appeal (RFA) form. If you request to appeal this determination you must submit a completed RFA form to the following address:

US Army Corps of Engineers
South Atlantic Division
Attn: Jason Steele, Review Officer
60 Forsyth Street SW, Room 10M15
Atlanta, Georgia 30303-8801
Phone: (404) 562-5137

In order for an RFA to be accepted by the Corps, the Corps must determine that it is complete, that it meets the criteria for appeal under 33 CFR part 331.5, and that it has been received by the Division Office within 60 days of the date of the NAP. Should you decide to submit an RFA form, it must be received at the above address by N/A.

It is not necessary to submit an RFA form to the Division Office if you do not object to the determination in this correspondence.

Corps Regulatory Official: *Liz Hair*
Sarah Hair

Date of JD: **August 9, 2012**
Expiration Date of JD: N/A

The Wilmington District is committed to providing the highest level of support to the public. To help us ensure we continue to do so, please complete our Customer Satisfaction Survey, located online at http://corpsmapu.usace.army.mil/cm_apex/f?p=136:4:0.

Electronic copies furnished:

Ms. Joanne Steenhuis, NC DWR
Mr. Jim Rerko, NC DOT Division 6 DEO
Mr. Colin Mellor, NC DOT PDEA
Mr. Chris Rivenbark, NC DOT PDEA

SPECIAL CONDITIONS

- 1) In order to compensate for impacts associated with this permit, mitigation shall be provided in accordance with the provisions outlined on the most recent version of the attached Compensatory Mitigation Responsibility Transfer Form. The requirements of this form, including any special conditions listed on this form, are hereby incorporated as special conditions of this permit authorization.

P-6

Action ID Number: SAW-2011-01806

County: Cumberland County

Permittee: NC DOT/ PDEA, Mr. Phillip S. Harris, III, P.E. CPM

Project Name: NCDOT/U-4405/US 401 and US 401 Business/Division 6

Date Verification Issued: December 1, 2017

Project Manager: Sarah Hair

Upon completion of the activity authorized by this permit and any mitigation required by the permit, sign this certification and return it to the following address:

US ARMY CORPS OF ENGINEERS
WILMINGTON DISTRICT
Attn: Sarah Hair
69 Darlington Avenue
Wilmington, North Carolina 28403

Please note that your permitted activity is subject to a compliance inspection by a U. S. Army Corps of Engineers representative. Failure to comply with any terms or conditions of this authorization may result in the Corps suspending, modifying or revoking the authorization and/or issuing a Class I administrative penalty, or initiating other appropriate legal action.

I hereby certify that the work authorized by the above referenced permit has been completed in accordance with the terms and condition of the said permit, and required mitigation was completed in accordance with the permit conditions.

Signature of Permittee

Date

Rivenbark, Chris

From: Hair, Sarah E CIV CESAW CESAD (US) <Sarah.E.Hair@usace.army.mil>
Sent: Thursday, March 22, 2018 3:22 PM
To: Rivenbark, Chris; Cashin, Gordon E
Cc: Rerko, James J; Steenhuis, Joanne
Subject: [External] U-4405 additional temporary impacts
Attachments: U-4405 Modification Cumberland February 16 2018.pdf

CAUTION: External email. Do not click links or open attachments unless verified. Send all suspicious email as an attachment to Report Spam.<mailto:report.spam@nc.gov>

Please reference the attached permit modification request dated February 16, 2018 for the following project:

Corps Action ID: SAW-2011-01806
County: Cumberland
Project TIP: U-4405

The applicant proposes additional temporary impacts associated with impacts sites 2, 3, 4, and 5 as a result of sediment/erosion control requirements.

Additional temporary impacts as proposed are hereby authorized. The original December 1, 2017 verification and all conditions remain applicable for permanent impacts.

The plans dated February 2018 will be added to the administrative record. Please allow this email to serve as official notification.

Thank you,

Liz Hair
Regulatory Project Manager
Wilmington District
US Army Corps of Engineers
69 Darlington Avenue
Wilmington, NC 28403
Sarah.e.hair@usace.army.mil
910-251-4049

**NATIONWIDE PERMIT 12
DEPARTMENT OF THE ARMY
CORPS OF ENGINEERS
FINAL NOTICE OF ISSUANCE AND MODIFICATION OF NATIONWIDE PERMITS
FEDERAL REGISTER
AUTHORIZED MARCH 19, 2017**

Utility Line Activities. Activities required for the construction, maintenance, repair, and removal of utility lines and associated facilities in waters of the United States, provided the activity does not result in the loss of greater than 1/2-acre of waters of the United States for each single and complete project.

Utility lines: This NWP authorizes the construction, maintenance, or repair of utility lines, including outfall and intake structures, and the associated excavation, backfill, or bedding for the utility lines, in all waters of the United States, provided there is no change in pre-construction contours. A “utility line” is defined as any pipe or pipeline for the transportation of any gaseous, liquid, liquescent, or slurry substance, for any purpose, and any cable, line, or wire for the transmission for any purpose of electrical energy, telephone, and telegraph messages, and radio and television communication. The term “utility line” does not include activities that drain a water of the United States, such as drainage tile or french drains, but it does apply to pipes conveying drainage from another area.

Material resulting from trench excavation may be temporarily sidecast into waters of the United States for no more than three months, provided the material is not placed in such a manner that it is dispersed by currents or other forces. The district engineer may extend the period of temporary side casting for no more than a total of 180 days, where appropriate. In wetlands, the top 6 to 12 inches of the trench should normally be backfilled with topsoil from the trench. The trench cannot be constructed or backfilled in such a manner as to drain waters of the United States (e.g., backfilling with extensive gravel layers, creating a french drain effect). Any exposed slopes and stream banks must be stabilized immediately upon completion of the utility line crossing of each waterbody.

Utility line substations: This NWP authorizes the construction, maintenance, or expansion of substation facilities associated with a power line or utility line in non-tidal waters of the United States, provided the activity, in combination with all other activities included in one single and complete project, does not result in the loss of greater than 1/2-acre of waters of the United States. This NWP does not authorize discharges into non-tidal wetlands adjacent to tidal waters of the United States to construct, maintain, or expand substation facilities.

Foundations for overhead utility line towers, poles, and anchors: This NWP authorizes the construction or maintenance of foundations for overhead utility line towers, poles, and anchors in all waters of the United States, provided the foundations are the minimum size necessary and separate footings for each tower leg (rather than a larger single pad) are used where feasible.

Access roads: This NWP authorizes the construction of access roads for the construction and maintenance of utility lines, including overhead power lines and utility line substations, in non-tidal waters of the United States, provided the activity, in combination with all other activities included in one single and complete project, does not cause the loss of greater than 1/2-acre of non-tidal waters of the United States. This NWP does not authorize discharges into non-tidal wetlands adjacent to tidal waters for access roads. Access roads must be the minimum width necessary (see Note 2, below). Access roads must be constructed so that the length of the road minimizes any adverse effects on waters of the United States and must be as near as possible to pre-construction contours and elevations (e.g., at grade corduroy roads or geotextile/gravel roads).

Access roads constructed above pre-construction contours and elevations in waters of the United States must be properly bridged or culverted to maintain surface flows.

This NWP may authorize utility lines in or affecting navigable waters of the United States even if there is no associated discharge of dredged or fill material (See 33 CFR Part 322). Overhead utility lines constructed over section 10 waters and utility lines that are routed in or under section 10 waters without a discharge of dredged or fill material require a section 10 permit.

This NWP also authorizes temporary structures, fills, and work necessary to conduct the utility line activity. Appropriate measures must be taken to maintain normal downstream flows and minimize flooding to the maximum extent practicable, when temporary structures, work, and discharges, including cofferdams, are necessary for construction activities, access fills, or dewatering of construction sites. Temporary fills must consist of materials, and be placed in a manner, that will not be eroded by expected high flows. Temporary fills must be removed in their entirety and the affected areas returned to pre-construction elevations. The areas affected by temporary fills must be revegetated, as appropriate.

- * Notification: The permittee must submit a pre-construction notification to the district engineer prior to commencing the activity if any of the following criteria are met: (1) the activity involves mechanized land clearing in a forested wetland for the utility line right-of-way; (2) a section 10 permit is required; (3) the utility line in waters of the United States, excluding overhead lines, exceeds 500 feet; (4) the utility line is placed within a jurisdictional area (i.e., water of the United States), and it runs parallel to or along a stream bed that is within that jurisdictional area; (5) discharges that result in the loss of greater than 1/10-acre of waters of the United States; (6) permanent access roads are constructed above grade in waters of the United States for a distance of more than 500 feet; or (7) permanent access roads are constructed in waters of the United States with impervious materials. (See general condition 31.) (Sections 10 and 404)

Note 1: Where the proposed utility line is constructed or installed in navigable waters of the United States (i.e., section 10 waters) within the coastal United States, the Great Lakes, and United States territories, copies of the pre-construction notification and NWP verification will be sent by the Corps to the National Oceanic and Atmospheric Administration (NOAA), National Ocean Service (NOS), for charting the utility line to protect navigation.

Note 2: Access roads used for both construction and maintenance may be authorized, provided they meet the terms and conditions of this NWP. Access roads used solely for construction of the utility line must be removed upon completion of the work, in accordance with the requirements for temporary fills.

Note 3: Pipes or pipelines used to transport gaseous, liquid, liquescent, or slurry substances over navigable waters of the United States are considered to be bridges, not utility lines, and may require a permit from the U.S. Coast Guard pursuant to Section 9 of the Rivers and Harbors Act of 1899. However, any discharges of dredged or fill material into waters of the United States associated with such pipelines will require a section 404 permit (see NWP 15).

Note 4: For overhead utility lines authorized by this NWP, a copy of the PCN and NWP verification will be provided to the Department of Defense Siting Clearinghouse, which will evaluate potential effects on military activities.

**NATIONWIDE PERMIT 14
DEPARTMENT OF THE ARMY
CORPS OF ENGINEERS
FINAL NOTICE OF ISSUANCE AND MODIFICATION OF NATIONWIDE PERMITS
FEDERAL REGISTER
AUTHORIZED MARCH 19, 2017**

Linear Transportation Projects. Activities required for crossings of waters of the United States associated with the construction, expansion, modification, or improvement of linear transportation projects (e.g., roads, highways, railways, trails, airport runways, and taxiways) in waters of the United States. For linear transportation projects in non-tidal waters, the discharge cannot cause the loss of greater than 1/2-acre of waters of the United States. For linear transportation projects in tidal waters, the discharge cannot cause the loss of greater than 1/3-acre of waters of the United States. Any stream channel modification, including bank stabilization, is limited to the minimum necessary to construct or protect the linear transportation project; such modifications must be in the immediate vicinity of the project.

This NWP also authorizes temporary structures, fills, and work, including the use of temporary mats, necessary to construct the linear transportation project. Appropriate measures must be taken to maintain normal downstream flows and minimize flooding to the maximum extent practicable, when temporary structures, work, and discharges, including cofferdams, are necessary for construction activities, access fills, or dewatering of construction sites. Temporary fills must consist of materials, and be placed in a manner, that will not be eroded by expected high flows. Temporary fills must be removed in their entirety and the affected areas returned to pre-construction elevations. The areas affected by temporary fills must be revegetated, as appropriate.

This NWP cannot be used to authorize non-linear features commonly associated with transportation projects, such as vehicle maintenance or storage buildings, parking lots, train stations, or aircraft hangars.

- * Notification: The permittee must submit a pre-construction notification to the district engineer prior to commencing the activity if: (1) the loss of waters of the United States exceeds 1/10- acre; or (2) there is a discharge in a special aquatic site, including wetlands. (See general condition 32.) (Authorities: Sections 10 and 404)

Note 1: For linear transportation projects crossing a single waterbody more than one time at separate and distant locations, or multiple waterbodies at separate and distant locations, each crossing is considered a single and complete project for purposes of NWP authorization. Linear transportation projects must comply with 33 CFR 330.6(d).

Note 2: Some discharges for the construction of farm roads or forest roads, or temporary roads for moving mining equipment, may qualify for an exemption under section 404(f) of the Clean Water Act (see 33 CFR 323.4).

Note 3: For NWP 14 activities that require pre-construction notification, the PCN must include any other NWP(s), regional general permit(s), or individual permit(s) used or intended to be used to authorize any part of the proposed project or any related activity, including other separate and distant crossings that require Department of the Army authorization but do not require pre-construction notification (see paragraph (b) of general condition 32). The district engineer will evaluate the PCN in accordance with Section D, "District Engineer's Decision." The district engineer may require mitigation to ensure that the authorized activity results in no more than minimal individual and cumulative adverse environmental effects (see general condition 23).

NATIONWIDE PERMIT GENERAL CONDITIONS

The following General Conditions must be followed in order for any authorization by a NWP to be valid:

1. Navigation. (a) No activity may cause more than a minimal adverse effect on navigation.
(b) Any safety lights and signals prescribed by the U.S. Coast Guard, through regulations or otherwise, must be installed and maintained at the permittee's expense on authorized facilities in navigable waters of the United States.
(c) The permittee understands and agrees that, if future operations by the United States require the removal, relocation, or other alteration, of the structure or work herein authorized, or if, in the opinion of the Secretary of the Army or his authorized representative, said structure or work shall cause unreasonable obstruction to the free navigation of the navigable waters, the permittee will be required, upon due notice from the Corps of Engineers, to remove, relocate, or alter the structural work or obstructions caused thereby, without expense to the United States. No claim shall be made against the United States on account of any such removal or alteration.
2. Aquatic Life Movements. No activity may substantially disrupt the necessary life cycle movements of those species of aquatic life indigenous to the waterbody, including those species that normally migrate through the area, unless the activity's primary purpose is to impound water. All permanent and temporary crossings of waterbodies shall be suitably culverted, bridged, or otherwise designed and constructed to maintain low flows to sustain the movement of those aquatic species. If a bottomless culvert cannot be used, then the crossing should be designed and constructed to minimize adverse effects to aquatic life movements.
3. Spawning Areas. Activities in spawning areas during spawning seasons must be avoided to the maximum extent practicable. Activities that result in the physical destruction (e.g., through excavation, fill, or downstream smothering by substantial turbidity) of an important spawning area are not authorized.
4. Migratory Bird Breeding Areas. Activities in waters of the United States that serve as breeding areas for migratory birds must be avoided to the maximum extent practicable.
6. Suitable Material. No activity may use unsuitable material (e.g., trash, debris, car bodies, asphalt, etc.). Material used for construction or discharged must be free from toxic pollutants in toxic amounts (see section 307 of the Clean Water Act).
7. Water Supply Intakes. No activity may occur in the proximity of a public water supply intake, except where the activity is for the repair or improvement of public water supply intake structures or adjacent bank stabilization.
8. Adverse Effects From Impoundments. If the activity creates an impoundment of water, adverse effects to the aquatic system due to accelerating the passage of water, and/or restricting its flow must be minimized to the maximum extent practicable.

P-12

9. Management of Water Flows. To the maximum extent practicable, the pre- construction course, condition, capacity, and location of open waters must be maintained for each activity, including stream channelization, storm water management activities, and temporary and permanent road crossings, except as provided below. The activity must be constructed to withstand expected high flows. The activity must not restrict or impede the passage of normal or high flows, unless the primary purpose of the activity is to impound water or manage high flows. The activity may alter the pre- construction course, condition, capacity, and location of open waters if it benefits the aquatic environment (e.g., stream restoration or relocation activities).

10. Fills Within 100-Year Floodplains. The activity must comply with applicable FEMA- approved state or local floodplain management requirements.

11. Equipment. Heavy equipment working in wetlands or mudflats must be placed on mats, or other measures must be taken to minimize soil disturbance.

12. Soil Erosion and Sediment Controls. Appropriate soil erosion and sediment controls must be used and maintained in effective operating condition during construction, and all exposed soil and other fills, as well as any work below the ordinary high water mark or high tide line, must be permanently stabilized at the earliest practicable date. Permittees are encouraged to perform work within waters of the United States during periods of low-flow or no-flow, or during low tides.

13. Removal of Temporary Fills. Temporary fills must be removed in their entirety and the affected areas returned to pre-construction elevations. The affected areas must be revegetated, as appropriate.

14. Proper Maintenance. Any authorized structure or fill shall be properly maintained, including maintenance to ensure public safety and compliance with applicable NWP general conditions, as well as any activity-specific conditions added by the district engineer to an NWP authorization.

19. Migratory Birds and Bald and Golden Eagles. The permittee is responsible for ensuring their action complies with the Migratory Bird Treaty Act and the Bald and Golden Eagle Protection Act. The permittee is responsible for contacting appropriate local office of the U.S. Fish and Wildlife Service to determine applicable measures to reduce impacts to migratory birds or eagles, including whether “incidental take” permits are necessary and available under the Migratory Bird Treaty Act or Bald and Golden Eagle Protection Act for a particular activity.

21. Discovery of Previously Unknown Remains and Artifacts. If you discover any previously unknown historic, cultural or archeological remains and artifacts while accomplishing the activity authorized by this permit, you must immediately notify the district engineer of what you have found, and to the maximum extent practicable, avoid construction activities that may affect the remains and artifacts until the required coordination has been completed. The district engineer will initiate the Federal, Tribal, and state coordination required to determine if the items or remains warrant a recovery effort or if the site is eligible for listing in the National Register of Historic Places.

* 30. Compliance Certification. Each permittee who receives an NWP verification letter from the Corps must provide a signed certification documenting completion of the authorized activity and implementation of any required compensatory mitigation. The success of any required permittee- responsible mitigation, including the achievement of ecological performance standards, will be

addressed separately by the district engineer. The Corps will provide the permittee the certification document with the NWP verification letter. The certification document will include:

(a) A statement that the authorized activity was done in accordance with the NWP authorization, including any general, regional, or activity-specific conditions;

(b) A statement that the implementation of any required compensatory mitigation was completed in accordance with the permit conditions. If credits from a mitigation bank or in-lieu fee program are used to satisfy the compensatory mitigation requirements, the certification must include the documentation required by 33 CFR 332.3(l)(3) to confirm that the permittee secured the appropriate number and resource type of credits; and

(c) The signature of the permittee certifying the completion of the activity and mitigation. The completed certification document must be submitted to the district engineer within 30 days of completion of the authorized activity or the implementation of any required compensatory mitigation, whichever occurs later.

FINAL REGIONAL CONDITIONS 2017

Final 2017 Regional Conditions for Nationwide Permits (NWP) in the Wilmington District

1.0 Excluded Waters

The Corps has identified waters that will be excluded from the use of all NWP's during certain timeframes. These waters are:

1.1 Anadromous Fish Spawning Areas

Waters of the United States identified by either the North Carolina Division of Marine Fisheries (NCDMF) or the North Carolina Wildlife Resources Commission (NCWRC) as anadromous fish spawning areas are excluded during the period between February 15 and June 30, without prior written approval from the Corps and either NCDMF or NCWRC.

1.2 Trout Waters Moratorium

Waters of the United States in the designated trout watersheds of North Carolina are excluded during the period between October 15 and April 15 without prior written approval from the NCWRC, or from the Eastern Band of Cherokee Indians (EBCI) Fisheries and Wildlife Management (FWM) office if the project is located on EBCI trust land. (See Section 2.7 for information on the designated trout watersheds).

1.3 Sturgeon Spawning Areas as Designated by the National Marine Fisheries Service (NMFS)

Waters of the United States designated as sturgeon spawning areas are excluded during the period between February 1 and June 30, without prior written approval from the NMFS.

3.0 List of Corps Regional Conditions for All Nationwide Permits

The following conditions apply to all Nationwide Permits in the Wilmington District:

3.1 Limitation of Loss of Stream Bed

NWPs may not be used for activities that may result in the loss or degradation of more than 300 total linear feet of stream bed, unless the District Engineer has waived the 300 linear foot limit for ephemeral and intermittent streams on a case-by-case basis and has determined that the proposed activity will result in minimal individual and cumulative adverse impacts to the aquatic environment. Waivers for the loss of ephemeral and intermittent streams must be in writing and documented by appropriate/accepted stream quality assessments*. This waiver only applies to the 300 linear feet threshold for NWPs.

This Regional Condition does not apply to NWP 23 (Approved Categorical Exclusions).

*NOTE: Permittees should utilize the most current methodology prescribed by Wilmington District to assess stream function and quality. Information can be found at:

https://ribits.usace.army.mil/ribits_apex/f?p=107:27:0::NO

3.2 Mitigation for Loss of Stream Bed

For any NWP that results in a loss of more than 150 linear feet of stream, the permittee shall provide a mitigation proposal to compensate for more than minimal individual and cumulative adverse impacts to the aquatic environment. For stream losses of 150 linear feet or less that require a PCN, the District Engineer may determine, on a case-by-case basis, that compensatory mitigation is required to ensure that the activity results in minimal adverse effect on the aquatic environment.

3.3 Pre-construction Notification for Loss of Streambed Exceeding 150 Feet

Prior to use of any NWP for any activity which impacts more than 150 total linear feet of perennial stream, intermittent or ephemeral stream, the permittee shall submit a PCN to the District Engineer prior to commencing the activity (see General Condition 32). This applies to NWPs that do not have specific notification requirements. If a NWP has specific notification requirements, the requirements of the NWP should be followed.

3.4 Restriction on Use of Live Concrete

For all NWPs which allow the use of concrete as a building material, live or fresh concrete, including bags of uncured concrete, may not come into contact with the water in or entering into waters of the United States. Water inside coffer dams or casings that has been in contact with wet concrete shall only be returned to waters of the United States after the concrete is set and cured and when it no longer poses a threat to aquatic organisms.

3.5 Requirements for Using Riprap for Bank Stabilization

For all NWPs that allow for the use of riprap material for bank stabilization, the following measures shall be applied:

3.5.1. Where bank stabilization is conducted as part of an activity, natural design, bioengineering and/or geoen지니어ing methods that incorporate natural durable materials, native seed mixes, and native plants and shrubs are to be utilized to the maximum extent practicable.

3.5.2. Filter cloth must be placed underneath the riprap as an additional requirement of its use in North Carolina waters. The placement of filter fabric is not required if the riprap will be pushed or “keyed” into the bank of the waterbody. A waiver from the specifications in this Regional Condition may be requested in writing. The waiver will only be issued if it can be demonstrated that the impacts of complying with this Regional Condition would result in greater adverse impacts to the aquatic environment.

3.5.3. The placement of riprap shall be limited to the areas depicted on submitted work plan drawings.

3.5.4. The riprap material shall be clean and free from loose dirt or any pollutant except in trace quantities that would not have an adverse environmental effect.

3.5.5. It shall be of a size sufficient to prevent its movement from the authorized alignment by natural forces under normal conditions.

3.5.6. The riprap material shall consist of clean rock or masonry material such as, but not limited to, granite, marl, or broken concrete.

3.6 Requirements for Culvert Placement

3.6.1 For all NWP's that involve the construction/installation of culverts, measures will be included in the construction/installation that will promote the safe passage of fish and other aquatic organisms. The dimension, pattern, and profile of the stream above and below a pipe or culvert should not be modified by altering the width or depth of the stream profile in connection with the construction activity. The width, height, and gradient of a proposed culvert should be sufficient to pass the average historical low flow and spring flow without adversely altering flow velocity. Spring flow is the seasonal sustained high flow that typically occurs in the spring. Spring flows should be determined from gage data, if available. In the absence of such data, bank-full flow can be used as a comparable indicator.

In Public Trust Areas of Environmental Concern (AEC) and/or the Estuarine Waters AEC as designated by the Coastal Area Management Act (CAMA): All pipes/culverts must be sufficiently sized to allow for the burial of the bottom of the culvert at least one foot below normal bed elevation.

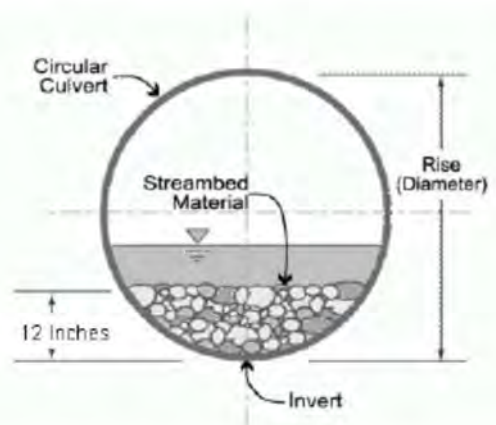

In all other areas: Culverts greater than 48 inches in diameter will be buried at least one foot below the bed of the stream. Culverts 48 inches in diameter or less shall be buried to maintain aquatic passage and to maintain passage during drought or low flow conditions, and every effort shall be made to maintain the existing channel slope.

Culverts must be designed and constructed in a manner that minimizes destabilization and head cutting. Destabilizing the channel and head cutting upstream should be considered and appropriate actions incorporated in the design and placement of the culvert.

A waiver from the depth specifications in this condition may be requested, in writing, by the permittee and issued by the Corp; this request must be specific as to the reasons(s) for the request. The waiver will be issued if it can be demonstrated that the proposed design would result in less impacts to the aquatic environment.

All counties: Culverts placed within riparian and/or riverine wetlands must be installed in a manner that does not restrict the flow and circulation patterns of waters of the United States.

Culverts placed across wetland fills purely for the purposes of equalizing surface water do not have to be buried, but the culverts must be of adequate size and/or number to ensure unrestricted transmission of water.

3.6.2 Bank-full flows (or less) shall be accommodated through maintenance of the existing bank- full channel cross sectional area. Additional culverts or culvert barrels at such crossings shall be allowed only to receive bank-full flows.

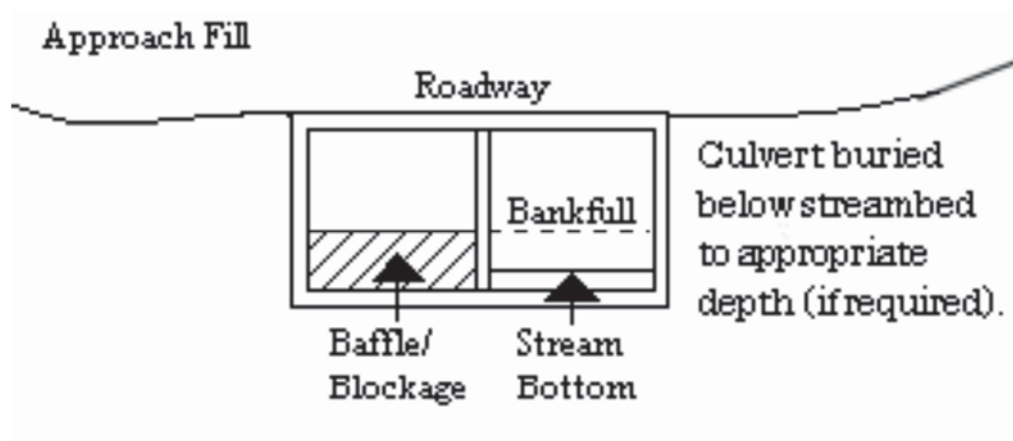

3.6.3 Where adjacent floodplain is available, flows exceeding bank-full should be accommodated by installing culverts at the floodplain elevation. Additional culverts or culvert barrels at such crossings should not be buried, or if buried, must have sills at the inlets to ensure that they only receive flows exceeding bank-full.

3.6.4 Excavation of existing stream channels shall be limited to the minimum necessary to construct or install the proposed culvert. The final width of the impacted stream at the culvert inlet and outlet should be no greater than the original stream width. A waiver from this condition may be requested in writing; this request must be specific as to the reason(s) for the request. The waiver will be issued if the proposed design would result in less impacts to the aquatic environment and/or if it can be demonstrated that it is not practicable to restore the final width of the impacted stream at the culvert inlet and outlet to the width of the original stream channel.

3.6.5 The width of the culvert shall be comparable to the width of the stream channel. If the width of the culvert is wider than the stream channel, the culvert shall include baffles, benches and/or sills to maintain the width of the stream channel. A waiver from this condition may be requested in writing; this request must be specific as to the reason(s) for the request. The waiver will be issued if it can be demonstrated that it is not practicable or necessary to include baffles, benches or sills and the design would result in less impacts to the aquatic environment.

3.7 Notification to NCDEQ Shellfish Sanitation Section

Permittees shall notify the NCDEQ Shellfish Sanitation Section prior to dredging in or removing sediment from an area closed to shell fishing where the effluent may be released to an area open for shell fishing or swimming in order to avoid contamination from the disposal area and cause a temporary shellfish closure to be made. Such notification shall also be provided to the appropriate Corps Regulatory Field Office. Any disposal of sand to the ocean beach should occur between November 1 and April 30 when recreational usage is low. Only clean sand should be used and no dredged sand from closed shell fishing areas may be used. If beach disposal were to occur at times other than stated above or if sand from a closed shell fishing area is to be used, a swimming advisory shall be posted, and a press release shall be issued by the permittee.

3.8 Submerged Aquatic Vegetation

Impacts to Submerged Aquatic Vegetation (SAV) are not authorized by any NWP, except NWP 48, unless EFH Consultation has been completed pursuant to the Magnuson-Stevens Fisheries Conservation and Management Act (Magnuson-Stevens Act). Permittees shall submit a PCN (See NWP General Condition 32) to the District Engineer prior to commencing the activity if the project would affect SAV. The permittee may not begin work until notified by the Corps that the requirements of the Magnuson-Stevens Act have been satisfied and that the activity is authorized.

3.9 Sedimentation and Erosion Control Structures and Measures

All PCNs will identify and describe sedimentation and erosion control structures and measures proposed for placement in waters of the United States. The structures and measures should be depicted on maps, surveys or drawings showing location and impacts to jurisdictional wetlands and streams.

3.10 Restoration of Temporary Impacts to Stream Beds

Upon completion of work that involves temporary stream impacts, streambeds are to be restored to pre-project elevations and widths using natural streambed material such that the impacted stream reach mimics the adjacent upstream and downstream reach. The impacted area shall be backfilled with natural streambed material to a depth of at least 12 inches or to the bottom depth of the impacted area if shallower than 12 inches. An engineered in-stream structure or material can be used to provide protection of a buried structure if it provides benefits to the aquatic environment and can be accomplished by a natural streambed design. A permittee may request a waiver of this condition if it is determined a buried structure needs significant physical protection beyond those provided in this condition. This condition does not apply to NWP 27 – Aquatic Habitat Restoration, Enhancement, and Establishment Activities.

3.11 Restoration of Temporary Impacts to Stream Banks

Upon completion of work involving temporary stream bank impacts, stream banks are to be restored to pre-project grade and contours or beneficial grade and contours if the original bank slope is steep and unstable. Natural durable materials, native seed mixes, and native plants and shrubs are to be utilized in the restoration. Natural designs which use bioengineered and/or geo-engineered methods are to be applied. An engineered structure or material can be used to provide protection of a buried structure if it provides benefits to the stream bank environment, provided it is not in excess of the minimum amount needed for protection and does not exceed an average of one cubic yard per running foot placed along the bank below the plane of the ordinary high water mark. A permittee may request a waiver of this condition if it is determined a buried structure needs significant physical protection beyond those provided in this condition. This condition does not apply to NWP 27 – Aquatic Habitat Restoration, Enhancement, and Establishment Activities.

The following list of General Conditions has been adapted for work in North Carolina for NCDOT projects. Information related to USACE notification requirements has been removed. Therefore, numbering and lettering below may not be consecutive. Please refer to <http://saw-reg.usace.army.mil/NWP2017/2017NWP12.pdf> for the complete reference.

4.0 Additional Regional Conditions for Specific Nationwide Permits

4.1 NWP #12 - Utility Line Activities

4.1.1. Pipeline/utility line construction through jurisdictional waters and wetlands will be accomplished utilizing directional drilling/boring methods to the maximum extent practicable.

4.1.2. Temporary discharge of excavated or fill material into wetlands and waters of the United States will be for the absolute minimum period of time necessary to accomplish the work. Temporary discharges will be fully contained with appropriate erosion control or containment methods or otherwise such fills will consist of non-erodible materials.

4.1.3. The work area authorized by this permit, including temporary and/or permanent fills, will be minimized to the greatest extent practicable. Justification for work corridors exceeding forty (40) feet in width is required and will be based on pipeline diameter and length, size of equipment required to construct the utility line, and other construction information deemed necessary to support the request. The applicant is required to provide this information to the Corps with the initial notification package.

4.1.9. For the purposes of this NWP, any permanently maintained corridor along the utility ROW within forested wetlands shall be considered a permanent impact and a compensatory mitigation plan will be required for all such impacts associated with the requested activity.

4.1.10. Use of rip-rap or any other engineered structures to stabilize a stream bed should be avoided to the maximum extent practicable. If riprap stabilization is needed, it should be placed only on the stream banks, or, if it is necessary to be placed in the stream bed, the finished top elevation of the riprap should not exceed that of the original stream bed.

4.1.11. When directional boring or horizontal directional drilling (HDD) under waters of the U.S., including wetlands, permittees shall closely monitor the project for hydraulic fracturing or “fracking.” Any discharge from hydraulic fracturing or “fracking” into waters of the U.S., including wetlands, shall be reported to the appropriate Corps Regulatory Field Office within 48 hours. Restoration and/or mitigation may be required as a result from any unintended discharges.

The following list of General Conditions has been adapted for work in North Carolina for NCDOT projects. Information related to USACE notification requirements has been removed. Therefore, numbering and lettering below may not be consecutive. Please refer to <http://saw-reg.usace.army.mil/NWP2017/2017NWP14.pdf> for the complete reference.

4.0 Additional Regional Conditions for Specific Nationwide Permits

4.1 NWP #14 - Linear Transportation Projects

4.1.1 If appropriate, permittees shall employ natural channel design (see definition below and NOTE below) to the maximum extent practicable for stream relocations. All stream relocation proposals shall include a Relocation and Monitoring Plan and a functional assessment of baseline conditions (e.g., use of the North Carolina Stream Assessment Methodology). Compensatory mitigation may be required for stream relocations.

Natural Channel Design means a geomorphologic approach to stream restoration based on an understanding of valley type, general watershed conditions, dimension, pattern, profile, hydrology and sediment transport of natural, stable channels (reference condition) and applying this understanding to the reconstruction of a stable channel.

NOTE: For more information on Natural Channel Design, permittees should reference North Carolina Stream Mitigation Guidance on the Corps RIBITS (Regulatory In-lieu Fee and Bank Information Tracking System) website or at the following World Wide Web Page:

https://ribits.usace.army.mil/ribits_apex/f?p=107:27:16705499703550::NO:RP:P27_BUTTON_KEY:0

4.1.2 This NWP authorizes only upland to upland crossings and cannot be used in combination with Nationwide Permit 18 to create an upland within waters of the United States, including wetlands.

4.1.3 This NWP cannot be used for private projects located in tidal waters or tidal wetlands.

4.1.4 In designated trout watersheds, a PCN is not required for impacts to a maximum of 60 linear feet (150 linear feet for temporary dewatering) or 1/10-acre of jurisdictional aquatic resources for proposed structures not adjoining, adjacent to, or connected to existing structures. In designated trout waters, the permittee shall submit a PCN (see Regional Conditions 2.7 and General Condition 32) to the District Engineer prior to commencing the activity if 1) impacts (other than temporary dewatering to work in dry conditions) to jurisdictional aquatic resources exceed 60 linear feet or 1/10-acre; 2) temporary impacts to streams or waterbodies associated with dewatering to work in dry conditions exceed 150 linear feet; 3) the project will involve impacts to wetlands; 4) the primary purpose of the project is for commercial development; 5) the project involves the replacement of a bridge or spanning structure with a culvert or non-spanning structure in waters of the United States; or 6) the activity will be constructed during the trout waters moratorium (October 15 through April 15).

4.1.5 The permittee shall submit a PCN to the District Engineer prior to commencing the activity if the activity will involve the discharge of dredged or fill material into more than 150 linear feet of stream channel for the construction of temporary access fills and/or temporary road crossings. The PCN must include a restoration plan that thoroughly describes how all temporary fills will be removed, describes how pre-project conditions will be restored, and includes a timetable for all restoration activities.



ROY COOPER
Governor

MICHAEL S. REGAN
Secretary

LINDA CULPEPPER
Interim Director

March 15, 2018
Cumberland County
NCDWR Project No.20171365 V2
TIP Project No. U-4405

REVISED APPROVAL of 401 WATER QUALITY CERTIFICATION with ADDITIONAL CONDITIONS

Mr. Philip S. Harris, III, P.E. CPM
Project Development and Environmental Analysis Unit
North Carolina Department of Transportation
1598 Mail Service Center
Raleigh, NC 27699-1598

Dear Mr. Harris:

This certification rescinds and replaces the certification issued on November 17, 2017. You have our approval, in accordance with the conditions listed below, for the following impacts for the purpose of improvements to US Highway 401(Raeford Road) from west of Hampton Oaks Drive to east of Fairway Drive (approximately 6 miles) in Cumberland County:

Stream Impacts in the Cape Fear River Basin

Site	Permanent Fill in Intermittent Stream (linear ft)	Temporary Fill in Intermittent Stream (linear ft)	Permanent Fill in Perennial Stream (linear ft)	Temporary Fill in Perennial Stream (linear ft)	Total stream Impacts (linear ft)	Stream Impacts Requiring Mitigation (linear ft)
1			8	43	51	
2			201	41	242	
3			33		33	
3b (stabilization)			176	171	347	
4			216	20	236	
5			206	27	233	
U5				45	45	
U6				48	48	
TOTAL			840	395	1,235	

Total Stream Impact for Project: 1,235 linear feet.

Wetland Impacts in the Cape Fear River Basin

Site	Fill (ac)	Fill (Temporary)	Excavation (ac)	Mechanized Clearing (ac)	Hand Clearing (ac)	Total Wetland Impacts (ac)	Impacts Requiring Mitigation (ac)
2	0.200					0.200	N/A
U1	0.007					0.007	N/A
U3		0.023				0.023	N/A
U4	0.012					0.012	N/A
U					0.02	0.02	N/A
TOTAL	0.219	0.023				0.262	

Total Wetland Impact for Project: 0.262 acres.

Open Water Impacts in the Cape Fear River Basin

Site	Permanent Fill in Open Waters (ac)	Temporary Fill in Open Waters (ac)	Total Fill in Open Waters (ac)
1	0.01	0.01	0.02
2	0.03	0.04	0.07
3	0.03	0.01	0.04
4	0.07	0.01	0.08
5	0.09	0.03	0.12
U2		0.05	0.05
U5		0.01	0.01
U6		0.02	0.02
TOTAL	0.23	0.18	0.41

Total Open Water Impact for Project: 0.41 acres.

The project shall be constructed in accordance with your application modification request dated received February 16, 2018. After reviewing your application, we have decided that these impacts are covered by General Water Quality Certification Numbers 4088 and 4086. This certification corresponds to the Nationwide Permit 14 and Nationwide Permit 12 issued by the Corps of Engineers. In addition, you should acquire any other federal, state or local permits before you proceed with your project including (but not limited to) Sediment and Erosion Control, Non-Discharge and Water Supply Watershed regulations. This approval will expire with the accompanying 404 permit.

This approval is valid solely for the purpose and design described in your application (unless modified below). Should your project change, you must notify the NCDWR and submit a new application. If the property is sold, the new owner must be given a copy of this Certification and approval letter, and is thereby responsible for complying with all the conditions. If total wetland fills for this project (now or in the future) exceed one acre, or of total impacts to streams (now or in the future) exceed 150 linear feet, compensatory mitigation may be required as described in 15A NCAC 2H .0506 (h) (6) and (7). For this approval to remain valid, you must adhere to the conditions listed in the attached certifications and any additional conditions listed below.

Condition(s) of Certification:

Project Specific Conditions

1. The NCDOT Division Environmental Officer or Environmental Assistant will conduct a pre-construction meeting with all appropriate staff to ensure that the project supervisor and essential staff understand the potential issues with stream and pipe alignment at the permitted site. NCDWR staff shall be invited to the pre-construction meeting. [15A NCAC 02H.0506(b)(2) and (b)(3)]
2. Unless otherwise approved in this certification, placement of culverts and other structures in open waters and streams, shall be placed below the elevation of the streambed by one foot for all culverts with a diameter greater than 48 inches, and 20 percent of the culvert diameter for culverts having a diameter less than 48 inches, to allow low flow passage of water and aquatic life. Design and placement of culverts and other structures including temporary erosion control measures shall not be conducted in a manner that may result in dis-equilibrium of wetlands or streambeds or banks, adjacent to or upstream and down stream of the above structures. The applicant is required to provide evidence that the equilibrium is being maintained if requested in writing by the NCDWR. If this condition is unable to be met due to bedrock or other limiting features encountered during construction, please contact the NCDWR for guidance on how to proceed and to determine whether or not a permit modification will be required. [15A NCAC 02H.0506(b)(2)]
3. If multiple pipes or barrels are required, they shall be designed to mimic natural stream cross section as closely as possible including pipes or barrels at flood plain elevation and/or sills where appropriate. Widening the stream channel should be avoided. Stream channel widening at the inlet or outlet end of structures typically decreases water velocity causing sediment deposition that requires increased maintenance and disrupts aquatic life passage. [15A NCAC 02H.0506(b)(2)]

4. Riprap shall not be placed in the active thalweg channel or placed in the streambed in a manner that precludes aquatic life passage. Bioengineering boulders or structures should be properly designed, sized and installed. [15A NCAC 02H.0506(b)(2)]
5. **For the open cut trenching of the utility lines, the mixing of topsoil and the subsoils within the wetlands shall be minimized to the greatest extent practical. During excavation, the soils shall be placed on fabric to minimize impacts whenever possible. Topsoil excavated from utility trenches in wetlands will be piled separately from the subsoils and will be backfilled into the trench only after the subsoils have been placed in the trench and compacted.**
6. Sediment and Erosion Control 15A NCAC 02H .0506 (b)(3) and (c)(3)
Turbidity curtains shall be used to isolate all work areas from the stream at Beaver Creek, including pile or casement installation, placement of riprap, excavation or filling. Strict adherence to the Construction and Maintenance Best Management Practices will be required.

General Conditions

7. Unless otherwise approved in this certification, placement of culverts and other structures in open waters and streams shall be placed below the elevation of the streambed by one foot for all culverts with a diameter greater than 48 inches, and 20 percent of the culvert diameter for culverts having a diameter less than 48 inches, to allow low flow passage of water and aquatic life. Design and placement of culverts and other structures including temporary erosion control measures shall not be conducted in a manner that may result in dis-equilibrium of wetlands or streambeds or banks, adjacent to or upstream and downstream of the above structures. The applicant is required to provide evidence that the equilibrium is being maintained if requested in writing by NCDWR. If this condition is unable to be met due to bedrock or other limiting features encountered during construction, please contact NCDWR for guidance on how to proceed and to determine whether or not a permit modification will be required. [15A NCAC 02H.0506(b)(2)]
8. If concrete is used during construction, a dry work area shall be maintained to prevent direct contact between curing concrete and stream water. Water that inadvertently contacts uncured concrete shall not be discharged to surface waters due to the potential for elevated pH and possible aquatic life and fish kills. [15A NCAC 02B.0200]
9. During the construction of the project, no staging of equipment of any kind is permitted in waters of the U.S., or protected riparian buffers. [15A NCAC 02H.0506(b)(2)]
10. The dimension, pattern and profile of the stream above and below the crossing shall not be modified. Disturbed floodplains and streams shall be restored to natural geomorphic conditions. [15A NCAC 02H.0506(b)(2)]
11. The use of rip-rap above the Normal High Water Mark shall be minimized. Any rip-rap placed for stream stabilization shall be placed in stream channels in such a manner that it does not impede aquatic life passage. [15A NCAC 02H.0506(b)(2)]
12. The Permittee shall ensure that the final design drawings adhere to the permit and to the permit drawings submitted for approval. [15A NCAC 02H .0507(c) and 15A NCAC 02H .0506 (b)(2) and (c)(2)]
13. All work in or adjacent to stream waters shall be conducted in a dry work area. Approved BMP measures from the most current version of NCDOT Construction and Maintenance Activities manual such as sandbags, rock berms, cofferdams and other diversion structures shall be used to prevent excavation in flowing water. [15A NCAC 02H.0506(b)(3) and (c)(3)]
14. Heavy equipment shall be operated from the banks rather than in the stream channel in order to minimize sedimentation and reduce the introduction of other pollutants into the stream. [15A NCAC 02H.0506(b)(3)]
15. All mechanized equipment operated near surface waters must be regularly inspected and maintained to prevent contamination of stream waters from fuels, lubricants, hydraulic fluids, or other toxic materials. [15A NCAC 02H.0506(b)(3)]

P-24

16. No rock, sand or other materials shall be dredged from the stream channel except where authorized by this certification. [15A NCAC 02H.0506(b)(3)]
17. Discharging hydroseed mixtures and washing out hydroseeders and other equipment in or adjacent to surface waters is prohibited. [15A NCAC 02H.0506(b)(3)]
18. The permittee and its authorized agents shall conduct its activities in a manner consistent with State water quality standards (including any requirements resulting from compliance with §303(d) of the Clean Water Act) and any other appropriate requirements of State and Federal law. If the NCDWR determines that such standards or laws are not being met (including the failure to sustain a designated or achieved use) or that State or federal law is being violated, or that further conditions are necessary to assure compliance, the NCDWR may reevaluate and modify this certification. [15A NCAC 02B.0200]
19. All fill slopes located in jurisdictional wetlands shall be placed at slopes no flatter than 3:1, unless otherwise authorized by this certification. [15A NCAC 02H.0506(b)(2)]
20. A copy of this Water Quality Certification shall be maintained on the construction site at all times. In addition, the Water Quality Certification and all subsequent modifications, if any, shall be maintained with the Division Engineer and the on-site project manager. [15A NCAC 02H .0507(c) and 15A NCAC 02H .0506 (b)(2) and (c)(2)]
21. The outside buffer, wetland or water boundary located within the construction corridor approved by this authorization shall be clearly marked by highly visible fencing prior to any land disturbing activities. Impacts to areas within the fencing are prohibited unless otherwise authorized by this certification. [15A NCAC 02H.0501 and .0502]
22. The issuance of this certification does not exempt the Permittee from complying with any and all statutes, rules, regulations, or ordinances that may be imposed by other government agencies (i.e. local, state, and federal) having jurisdiction, including but not limited to applicable buffer rules, stormwater management rules, soil erosion and sedimentation control requirements, etc.
23. The Permittee shall report any violations of this certification to the Division of Water Resources within 24 hours of discovery. [15A NCAC 02B.0506(b)(2)]
24. Upon completion of the project (including any impacts at associated borrow or waste sites), the NCDOT Division Engineer shall complete and return the enclosed "Certification of Completion Form" to notify the NCDWR when all work included in the 401 Certification has been completed. [15A NCAC 02H.0502(f)]
25. Native riparian vegetation must be reestablished in the riparian areas within the construction limits of the project by the end of the growing season following completion of construction. [15A NCAC 02B.0231(a)(6)]
26. There shall be no excavation from, or waste disposal into, jurisdictional wetlands or waters associated with this permit without appropriate modification. Should waste or borrow sites, or access roads to waste or borrow sites, be located in wetlands or streams, compensatory mitigation will be required since that is a direct impact from road construction activities.[15A NCAC 02H.0506(b)(3) and (c)(3)]
27. Erosion and sediment control practices must be in full compliance with all specifications governing the proper design, installation and operation and maintenance of such Best Management Practices in order to protect surface waters standards [15A NCAC 02H.0506(b)(3) and (c)(3)]:
 - a. The erosion and sediment control measures for the project must be designed, installed, operated, and maintained in accordance with the most recent version of the *North Carolina Sediment and Erosion Control Planning and Design Manual*.
 - b. The design, installation, operation, and maintenance of the sediment and erosion control measures must be such that they equal, or exceed, the requirements specified in the most recent version of the *North Carolina Sediment and Erosion Control Manual*. The devices shall be maintained on all construction sites, borrow sites, and waste pile (spoil) projects, including contractor-owned or leased borrow pits associated with the project.
 - c. For borrow pit sites, the erosion and sediment control measures must be designed, installed, operated, and maintained in accordance with the most recent version of the *North Carolina Surface Mining Manual*.

- d. The reclamation measures and implementation must comply with the reclamation in accordance with the requirements of the Sedimentation Pollution Control Act.

28. Sediment and erosion control measures shall not be placed in wetlands or waters unless otherwise approved by this Certification. [15A NCAC 02H.0506(b)(3) and (c)(3)]

If you wish to contest any statement in the attached Certification you must file a petition for an administrative hearing. You may obtain the petition form from the office of Administrative hearings. You must file the petition with the office of Administrative Hearings within sixty (60) days of receipt of this notice. A petition is considered filed when it is received in the office of Administrative Hearings during normal office hours. The Office of Administrative Hearings accepts filings Monday through Friday between the hours of 8:00am and 5:00pm, except for official state holidays. The original and one (1) copy of the petition must be filed with the Office of Administrative Hearings.

The petition may be faxed-provided the original and one copy of the document is received by the Office of Administrative Hearings within five (5) business days following the faxed transmission.

The mailing address for the Office of Administrative Hearings is:

Office of Administrative Hearings
6714 Mail Service Center
Raleigh, NC 27699-6714
Telephone: (919) 431-3000, Facsimile: (919) 431-3100

A copy of the petition must also be served on DEQ as follows:

Mr. Sam M. Hayes, General Counsel
Department of Environmental Quality
1601 Mail Service Center
Raleigh, NC 27699-1601

This letter completes the review of the Division of Water Resources under Section 401 of the Clean Water Act. If you have any questions, please contact Joanne Steenhuis at (910) 796-7306 or joanne.steenhuis@ncdenr.gov.

Sincerely,



Linda Culpepper, Interim Director
Division of Water Resources

Electronic copy only distribution:

Liz Hair, US Army Corps of Engineers, Wilmington Field Office
Jim Rerko, Division 6 Environmental Officer
Colin Mellor, NC Department of Transportation
Gordon Cashin, NC Department of Transportation
Chris Rivenbark, NC Department of Transportation
Gary Jordan, US Fish and Wildlife Service
Travis Wilson, NC Wildlife Resources Commission
Beth Harmon, Division of Mitigation Services
James Michel, Fayetteville Public Works Commission (james.michel@faypwc.com)
Joanne Steenhuis, NC Division of Water Resources Wilmington Regional Office
File Copy

STATE OF NORTH CAROLINA
DEPARTMENT OF ENVIRONMENTAL QUALITY
DIVISION OF WATER RESOURCES

WATER QUALITY GENERAL CERTIFICATION NO. 4086

GENERAL CERTIFICATION FOR PROJECTS ELIGIBLE FOR US ARMY CORPS OF ENGINEERS

- NATIONWIDE PERMIT 12 (UTILITY LINE ACTIVITIES)

Water Quality Certification Number 4086 is issued in conformity with the requirements of Section 401, Public Laws 92-500 and 95-217 of the United States and subject to the North Carolina Regulations in 15A NCAC 02H .0500 and 15A NCAC 02B .0200 for the discharge of fill material to surface waters and wetland areas as described in 33 CFR 330 Appendix A (B) (12) of the US Army Corps of Engineers regulations.

The State of North Carolina certifies that the specified category of activity will not violate applicable portions of Sections 301, 302, 303, 306 and 307 of the Public Laws 92-500 and 95-217 if conducted in accordance with the conditions hereinafter set forth.

Effective date: March 19, 2017

Signed this day March 3, 2017

By



for S. Jay Zimmerman, P.G.
Director

P-27
GC4086

Activities meeting any one (1) of the following thresholds or circumstances require written approval for a 401 Water Quality Certification from the Division of Water Resources (DWR):

- a) If any of the Conditions of this Certification (listed below) cannot be met; or
- b) Any permanent fill into or modification of wetlands and/or waters; or
- c) Total temporary impacts to streams greater than 500 feet; or
- d) Any stream relocation or stream restoration; or
- e) Any impacts to waters, or to wetlands adjacent to waters, designated as: ORW (including SAV), HQW (including PNA), SA, WS-I, WS-II, Trout, or North Carolina or National Wild and Scenic River; or
- f) Any impacts to coastal wetlands [15A NCAC 07H .0205], or Unique Wetlands (UWL); or
- g) Any impact associated with a Notice of Violation or an enforcement action for violation(s) of NC Wetland Rules (15A NCAC 02H .0500), NC Isolated Wetland Rules (15A NCAC 02H .1300), NC Surface Water or Wetland Standards (15A NCAC 02B .0200), or State Regulated Riparian Buffer Rules (15A NCAC 02B .0200); or
- * h) Any impacts to subject water bodies and/or state regulated riparian buffers along subject water bodies in the Neuse, Tar-Pamlico, or Catawba River Basins or in the Randleman Lake, Jordan Lake or Goose Creek Watersheds (or any other basin or watershed with State Regulated Riparian Area Protection Rules [Buffer Rules] in effect at the time of application) *unless*:
 - i) The activities are listed as "EXEMPT" from these rules; or
 - ii) A Buffer Authorization Certificate is issued by the NC Division of Coastal Management (DCM); or
 - iii) A Buffer Authorization Certificate or a Minor Variance is issued by a delegated or designated local government implementing a state riparian buffer program pursuant to 143-215.23.

Activities included in this General Certification that do not meet one of the thresholds listed above do not require written approval.

I. ACTIVITY SPECIFIC CONDITIONS:

1. All sewer lines shall be designed, constructed and maintained in accordance with Title 15A NCAC Chapter 02T.
2. Any utility construction corridor that is parallel to a stream or open water shall not be closer than 10 feet to the top of bank or ordinary high water mark. Exceptions to this condition require application to and written approval from DWR. [15A NCAC 02H .0506 (b)(4) and (c)(4)]
3. Utility lines shall cross all stream channels at a near-perpendicular direction (i.e., between 75 degrees and 105 degrees to the stream bank). Exceptions to this condition require application to and written approval from DWR. [15A NCAC 02H .0506 (b)(2) and (c)(2)]

P-28
GC4086

4. Construction corridors in wetlands and across stream channels shall be minimized to the maximum extent practicable and shall not exceed 50 feet wide for gas utility lines and 40 feet wide for all other utility lines. Exceptions to this condition require application to and written approval from DWR. [15A NCAC 02H .0506 (b)(2) and (c)(2)]

For construction corridors in wetlands and across stream channels, stumps shall be grubbed only as needed to install the utility and remaining stumps shall be cut off at grade level. The general stripping of topsoil within wetlands along the construction corridor is not permitted.

5. Permanent maintained access corridors in wetlands and across stream channels shall be restricted to the minimum width practicable and shall not exceed 30 feet wide for gas utility lines and 20 feet wide for all other utility lines except at manhole locations. 15-foot by 15-foot perpendicular vehicle turnarounds shall be allowed in access corridors but must be spaced at least 500 feet apart. Exceptions to this condition require application to and written approval from DWR. [15A NCAC 02H .0506 (b)(2) and (c)(2)]
6. For all utility lines constructed within wetlands, an anti-seep collar shall be placed at the downstream (utility line gradient) wetland boundary and every 150 feet up the gradient until the utility exits the wetland. Anti-seep collars may be constructed with class B concrete, compacted clay, PVC pipe, or metal collars. Wetland crossings that are directionally drilled, and perpendicular wetland crossings that are open cut and less than 150 feet long do not require anti-seep collars. The compacted clay shall have a specific infiltration of 1×10^{-5} cm/sec or less. A section and plan view diagram is attached for the anti-seep collars. [15A NCAC 02H .0506 (b)(4) and (c)(4)]

The following specifications shall apply to class B concrete:

- a. Minimum cement content, sacks per cubic yard with rounded course aggregate 5.0
 - b. Minimum cement content, sacks per cubic yard with angular course aggregate 5.5
 - c. Maximum water-cement ratio gallons per sack 6.8
 - d. Slump range 2" to 4"
 - e. Minimum strength - 28 day psi 2,500
7. The applicant shall have a specific plan for restoring wetland contours. Any excess material will be removed to a high ground disposal area. [15A NCAC 02H .0506 (b)(2) and (c)(2)]

The mixing of topsoil and subsoils within the wetlands along utility corridors shall be minimized to the greatest extent practical. During excavation, the soils shall be placed on fabric to minimize impacts whenever possible. Topsoil excavated from utility trenches will be piled separately from subsoils and will be backfilled into the trench only after the subsoils have been placed and compacted.

P-29
GC4086

8. For the North Carolina Department of Transportation, compliance with the NCDOT's individual NPDES permit NCS000250 shall serve to satisfy this condition. For all other utility line and associated facilities projects that disturb one acre or more of land (including a project that disturbs less than one acre of land that is part of a larger common plan of development or sale); have permanent wetland, stream, or open water impacts; and are proposing new built-upon area shall comply with the following requirements: [15A NCAC 02H .0506(b)(5) and (c)(5)]
- a. Stormwater management shall be provided throughout the entire project area in accordance with 15A NCAC 02H .1003. For the purposes of 15A NCAC 02H .1003(2)(a), density thresholds shall be determined in accordance with 15A NCAC 02H .1017.
 - b. Projects that have vested rights, exemptions, or grandfathering from state or locally-implemented stormwater programs do not satisfy this condition. Projects that satisfy state or locally-implemented stormwater programs through use of community in-lieu programs do not satisfy this condition.
 - * c. Projects that require written authorization from DWR shall submit the following with their application for review and approval:
 - i. For projects that have a stormwater management plan (SMP) reviewed under a state stormwater program¹ or a state-approved local government stormwater program² shall submit plans that show the location and approximate size of all proposed stormwater measures;
 - ii. All other low density projects not covered above shall submit a completed low density supplement form with all required items; and
 - iii. All other high density projects not covered above shall submit a completed SMP, including all appropriate stormwater control measure (SCM) supplemental forms and associated items, that complies with the high density development requirements of 15A NCAC 02H .1003.
 - * d. Projects that do not require written approval from DWR shall obtain approval of the SMP, when required, before any impacts authorized by this Certification occur.
 - e. SMPs approved by DWR may be phased on a case-by-case basis. SMPs for each future phase must be approved before construction of that phase commences. Approved SMPs may not be modified without prior written authorization from DWR.

¹ e.g. Coastal Counties, HQW, ORW, or state-implemented Phase II NPDES

² e.g. Delegated Phase II NPDES, Water Supply Watershed, Nutrient-Sensitive Waters, or Universal Stormwater Management Program

P-30
GC4086

II. GENERAL CONDITIONS:

1. When written authorization is required, the plans and specifications for the project are incorporated into the authorization by reference and are an enforceable part of the Certification. Any modifications to the project require notification to DWR and may require an application submittal to DWR with the appropriate fee. [15A NCAC 02H .0501 and .0502]
2. No waste, spoil, solids, or fill of any kind shall occur in wetlands or waters beyond the footprint of the impacts (including temporary impacts) as authorized in the written approval from DWR; or beyond the thresholds established for use of this Certification without written authorization. [15A NCAC 02H .0501 and .0502]

No removal of vegetation or other impacts of any kind shall occur to state regulated riparian buffers beyond the footprint of impacts approved in a Buffer Authorization or Variance or as listed as an exempt activity in the applicable riparian buffer rules. [15A NCAC 02B .0200]

- * 3. In accordance with 15A NCAC 02H .0506(h), compensatory mitigation may be required for losses of greater than 150 linear feet of streams and/or greater than one (1) acre of wetlands. Impacts to isolated and other non-404 jurisdictional wetlands shall not be combined with 404 jurisdictional wetlands for the purpose of determining when impact thresholds trigger a mitigation requirement. For linear publicly owned and maintained transportation projects that are not determined to be part of a larger common plan of development by the US Army Corps of Engineers, compensatory mitigation may be required for losses of greater than 150 linear feet per stream.

Compensatory stream and/or wetland mitigation shall be proposed and completed in compliance with G.S. 143-214.11. For applicants proposing to conduct mitigation within a project site, a complete mitigation proposal developed in accordance with the most recent guidance issued by the US Army Corps of Engineers Wilmington District shall be submitted for review and approval with the application for impacts.

4. All activities shall be in compliance with any applicable State Regulated Riparian Buffer Rules in Chapter 2 of Title 15A.
5. When applicable, all construction activities shall be performed and maintained in full compliance with G.S. Chapter 113A Article 4 (Sediment and Pollution Control Act of 1973). Regardless of applicability of the Sediment and Pollution Control Act, all projects shall incorporate appropriate Best Management Practices for the control of sediment and erosion so that no violations of state water quality standards, statutes, or rules occur. [15A NCAC 02H .0506 (b)(3) and (c)(3) and 15A NCAC 02B .0200]

Design, installation, operation, and maintenance of all sediment and erosion control measures shall be equal to or exceed the requirements specified in the most recent version of the *North Carolina Sediment and Erosion Control Manual*, or for linear transportation projects, the *NCDOT Sediment and Erosion Control Manual*.

P-31 GC4086

All devices shall be maintained on all construction sites, borrow sites, and waste pile (spoil) sites, including contractor-owned or leased borrow pits associated with the project. Sufficient materials required for stabilization and/or repair of erosion control measures and stormwater routing and treatment shall be on site at all times.

For borrow pit sites, the erosion and sediment control measures shall be designed, installed, operated, and maintained in accordance with the most recent version of the *North Carolina Surface Mining Manual*. Reclamation measures and implementation shall comply with the reclamation in accordance with the requirements of the Sedimentation Pollution Control Act and the Mining Act of 1971.

If the project occurs in waters or watersheds classified as Primary Nursery Areas (PNAs), SA, WS-I, WS-II, High Quality Waters (HQW), or Outstanding Resource Waters (ORW), then the sedimentation and erosion control designs shall comply with the requirements set forth in 15A NCAC 04B .0124, *Design Standards in Sensitive Watersheds*.

6. Sediment and erosion control measures shall not be placed in wetlands or waters except within the footprint of temporary or permanent impacts authorized under this Certification. Exceptions to this condition require application to and written approval from DWR. [15A NCAC 02H .0501 and .0502]
7. Erosion control matting that incorporates plastic mesh and/or plastic twine shall not be used along streambanks or within wetlands. Exceptions to this condition require application to and written approval from DWR. [15A NCAC 02B .0201]
8. An NPDES Construction Stormwater Permit (NCG010000) is required for construction projects that disturb one (1) or more acres of land. The NCG010000 Permit allows stormwater to be discharged during land disturbing construction activities as stipulated in the conditions of the permit. If the project is covered by this permit, full compliance with permit conditions including the erosion & sedimentation control plan, inspections and maintenance, self-monitoring, record keeping and reporting requirements is required. [15A NCAC 02H .0506(b)(5) and (c)(5)]

The North Carolina Department of Transportation (NCDOT) shall be required to be in full compliance with the conditions related to construction activities within the most recent version of their individual NPDES (NCS000250) stormwater permit. [15A NCAC 02H .0506(b)(5) and (c)(5)]

9. All work in or adjacent to streams shall be conducted so that the flowing stream does not come in contact with the disturbed area. Approved best management practices from the most current version of the *NC Sediment and Erosion Control Manual*, or the *NC DOT Construction and Maintenance Activities Manual*, such as sandbags, rock berms, cofferdams, and other diversion structures shall be used to minimize excavation in flowing water. Exceptions to this condition require application to and written approval from DWR. [15A NCAC 02H .0506(b)(3) and (c)(3)]

10. If activities must occur during periods of high biological activity (e.g. sea turtle nesting, fish spawning, or bird nesting), then biological monitoring may be required at the request of other state or federal agencies and coordinated with these activities. [15A NCAC 02H .0506 (b)(2) and 15A NCAC 04B .0125]

All moratoriums on construction activities established by the NC Wildlife Resources Commission (WRC), US Fish and Wildlife Service (USFWS), NC Division of Marine Fisheries (DMF), or National Marine Fisheries Service (NMFS) shall be implemented. Exceptions to this condition require written approval by the resource agency responsible for the given moratorium. A copy of the approval from the resource agency shall be forwarded to DWR.

Work within a designated trout watershed of North Carolina (as identified by the Wilmington District of the US Army Corps of Engineers), or identified state or federal endangered or threatened species habitat, shall be coordinated with the appropriate WRC, USFWS, NMFS, and/or DMF personnel.

11. Culverts shall be designed and installed in such a manner that the original stream profiles are not altered and allow for aquatic life movement during low flows. The dimension, pattern, and profile of the stream above and below a pipe or culvert shall not be modified by widening the stream channel or by reducing the depth of the stream in connection with the construction activity. The width, height, and gradient of a proposed culvert shall be such as to pass the average historical low flow and spring flow without adversely altering flow velocity. [15A NCAC 02H .0506(b)(2) and (c)(2)]

Placement of culverts and other structures in streams shall be below the elevation of the streambed by one foot for all culverts with a diameter greater than 48 inches, and 20% of the culvert diameter for culverts having a diameter less than or equal to 48 inches, to allow low flow passage of water and aquatic life.

If multiple pipes or barrels are required, they shall be designed to mimic the existing stream cross section as closely as possible including pipes or barrels at flood plain elevation and/or sills where appropriate. Widening the stream channel shall be avoided.

When topographic constraints indicate culvert slopes of greater than 5%, culvert burial is not required, provided that all alternative options for flattening the slope have been investigated and aquatic life movement/connectivity has been provided when possible (e.g. rock ladders, cross vanes, etc.). Notification, including supporting documentation to include a location map of the culvert, culvert profile drawings, and slope calculations, shall be provided to DWR 60 calendar days prior to the installation of the culvert.

When bedrock is present in culvert locations, culvert burial is not required provided that there is sufficient documentation of the presence of bedrock. Notification, including supporting documentation such as a location map of the culvert, geotechnical reports, photographs, etc. shall be provided to DWR a minimum of 60 calendar days prior to the installation of the culvert. If bedrock is discovered during construction, then DWR shall be notified by phone or email within 24 hours of discovery.

P-33
GC4086

If other site-specific topographic constraints preclude the ability to bury the culverts as described above and/or it can be demonstrated that burying the culvert would result in destabilization of the channel, then exceptions to this condition require application to and written approval from DWR.

Installation of culverts in wetlands shall ensure continuity of water movement and be designed to adequately accommodate high water or flood conditions. When roadways, causeways, or other fill projects are constructed across FEMA-designated floodways or wetlands, openings such as culverts or bridges shall be provided to maintain the natural hydrology of the system as well as prevent constriction of the floodway that may result in destabilization of streams or wetlands.

The establishment of native woody vegetation and other soft stream bank stabilization techniques shall be used where practicable instead of rip-rap or other bank hardening methods.

12. Bridge deck drains shall not discharge directly into the stream. Stormwater shall be directed across the bridge and pre-treated through site-appropriate means to the maximum extent practicable (e.g. grassed swales, pre-formed scour holes, vegetated buffers, etc.) before entering the stream. Exceptions to this condition require application to and written approval from DWR. [15A NCAC 02H .0506(b)(5)]
13. Application of fertilizer to establish planted/seeded vegetation within disturbed riparian areas and/or wetlands shall be conducted at agronomic rates and shall comply with all other Federal, State and Local regulations. Fertilizer application shall be accomplished in a manner that minimizes the risk of contact between the fertilizer and surface waters. [15A NCAC 02B .0200 and 15A NCAC 02B .0231]
14. If concrete is used during construction, then all necessary measures shall be taken to prevent direct contact between uncured or curing concrete and waters of the state. Water that inadvertently contacts uncured concrete shall not be discharged to waters of the state. [15A NCAC 02B .0200]
15. All proposed and approved temporary fill and culverts shall be removed and the impacted area shall be returned to natural conditions within 60 calendar days after the temporary impact is no longer necessary. The impacted areas shall be restored to original grade, including each stream's original cross sectional dimensions, planform pattern, and longitudinal bed profile. For projects that receive written approval, no temporary impacts are allowed beyond those included in the application and authorization. All temporarily impacted sites shall be restored and stabilized with native vegetation. [15A NCAC 02H .0506(b)(2) and (c)(2)]

P-34
GC4086

16. All proposed and approved temporary pipes/culverts/rip-rap pads etc. in streams shall be installed as outlined in the most recent edition of the *North Carolina Sediment and Erosion Control Planning and Design Manual* or the *North Carolina Surface Mining Manual* or the *North Carolina Department of Transportation Best Management Practices for Construction and Maintenance Activities* so as not to restrict stream flow or cause dis-equilibrium during use of this Certification. [15A NCAC 02H .0506(b)(2) and (c)(2)]
17. Any rip-rap required for proper culvert placement, stream stabilization, or restoration of temporarily disturbed areas shall be restricted to the area directly impacted by the approved construction activity. All rip-rap shall be placed such that the original stream elevation and streambank contours are restored and maintained. Placement of rip-rap or other approved materials shall not result in de-stabilization of the stream bed or banks upstream or downstream of the area or in a manner that precludes aquatic life passage. [15A NCAC 02H .0506(b)(2)]
18. Any rip-rap used for stream or shoreline stabilization shall be of a size and density to prevent movement by wave, current action, or stream flows and shall consist of clean rock or masonry material free of debris or toxic pollutants. Rip-rap shall not be installed in the streambed except in specific areas required for velocity control and to ensure structural integrity of bank stabilization measures. [15A NCAC 02H .0506(b)(2)]
19. Applications for rip-rap groins proposed in accordance with 15A NCAC 07H .1401 (NC Division of Coastal Management General Permit for construction of Wooden and Rip-rap Groins in Estuarine and Public Trust Waters) shall meet all the specific conditions for design and construction specified in 15A NCAC 07H .1405.
20. All mechanized equipment operated near surface waters shall be inspected and maintained regularly to prevent contamination of stream waters from fuels, lubricants, hydraulic fluids, or other toxic materials. Construction shall be staged in order to minimize the exposure of equipment to surface waters to the maximum extent practicable. Fueling, lubrication and general equipment maintenance shall not take place within 50 feet of a waterbody or wetlands to prevent contamination by fuels and oils. [15A NCAC 02H .0506(b)(3) and (c)(3) and 15A NCAC 02B .0211 (12)]
21. Heavy equipment working in wetlands shall be placed on mats or other measures shall be taken to minimize soil disturbance. [15A NCAC 02H .0506(b)(3) and (c)(3)]
22. In accordance with 143-215.85(b), the applicant shall report any petroleum spill of 25 gallons or more; any spill regardless of amount that causes a sheen on surface waters; any petroleum spill regardless of amount occurring within 100 feet of surface waters; and any petroleum spill less than 25 gallons that cannot be cleaned up within 24 hours.

P-35
GC4086

- * 23. If an environmental document is required under the State Environmental Policy Act (SEPA), then this General Certification is not valid until a Finding of No Significant Impact (FONSI) or Record of Decision (ROD) is issued by the State Clearinghouse. If an environmental document is required under the National Environmental Policy Act (NEPA), then this General Certification is not valid until a Categorical Exclusion, the Final Environmental Assessment, or Final Environmental Impact Statement is published by the lead agency. [15A NCAC 01C .0107(a)]
- 24. This General Certification does not relieve the applicant of the responsibility to obtain all other required Federal, State, or Local approvals before proceeding with the project, including those required by, but not limited to, Sediment and Erosion Control, Non-Discharge, Water Supply Watershed, and Trout Buffer regulations.
- 25. The applicant and their authorized agents shall conduct all activities in a manner consistent with State water quality standards (including any requirements resulting from compliance with §303(d) of the Clean Water Act), and any other appropriate requirements of State and Federal Law. If DWR determines that such standards or laws are not being met, including failure to sustain a designated or achieved use, or that State or Federal law is being violated, or that further conditions are necessary to assure compliance, then DWR may revoke or modify a written authorization associated with this General Water Quality Certification. [15A NCAC 02H .0507(d)]
- * 26. When written authorization is required for use of this Certification, upon completion of all permitted impacts included within the approval and any subsequent modifications, the applicant shall be required to return a certificate of completion (available on the DWR website: <https://edocs.deq.nc.gov/Forms/Certificate-of-Completion>). [15A NCAC 02H .0502(f)]
- 27. Additional site-specific conditions, including monitoring and/or modeling requirements, may be added to the written approval letter for projects proposed under this Water Quality Certification in order to ensure compliance with all applicable water quality and effluent standards. [15A NCAC 02H .0507(c)]
- 28. If the property or project is sold or transferred, the new Permittee shall be given a copy of this Certification (and written authorization if applicable) and is responsible for complying with all conditions. [15A NCAC 02H .0501 and .0502]

III. GENERAL CERTIFICATION ADMINISTRATION:

- * 1. In accordance with North Carolina General Statute 143-215.3D(e), written approval for a 401 Water Quality General Certification must include the appropriate fee. An applicant for a CAMA permit under Article 7 of Chapter 113A of the General Statutes for which a Water Quality Certification is required shall only make one payment to satisfy both agencies; the fee shall be as established by the Secretary in accordance with 143-215.3D(e)(7).

P-36
GC4086

2. This Certification neither grants nor affirms any property right, license, or privilege in any waters, or any right of use in any waters. This Certification does not authorize any person to interfere with the riparian rights, littoral rights, or water use rights of any other person and this Certification does not create any prescriptive right or any right of priority regarding any usage of water. This Certification shall not be interposed as a defense in any action respecting the determination of riparian or littoral rights or other rights to water use. No consumptive user is deemed by virtue of this Certification to possess any prescriptive or other right of priority with respect to any other consumptive user regardless of the quantity of the withdrawal or the date on which the withdrawal was initiated or expanded.
3. This Certification grants permission to the Director, an authorized representative of the Director, or DWR staff, upon the presentation of proper credentials, to enter the property during normal business hours. [15A NCAC 02H .0502(e)]
4. This General Certification shall expire on the same day as the expiration date of the corresponding Nationwide Permit and/or Regional General Permit. The conditions in effect on the date of issuance of Certification for a specific project shall remain in effect for the life of the project, regardless of the expiration date of this Certification. This General Certification is rescinded when the US Army Corps of Engineers reauthorizes any of the corresponding Nationwide Permits and/or Regional General Permits or when deemed appropriate by the Director of the Division of Water Resources.
5. Non-compliance with or violation of the conditions herein set forth by a specific project may result in revocation of this General Certification for the project and may also result in criminal and/or civil penalties.
- *6. The Director of the North Carolina Division of Water Resources may require submission of a formal application for Individual Certification for any project in this category of activity if it is determined that the project is likely to have a significant adverse effect upon water quality, including state or federally listed endangered or threatened aquatic species, or degrade the waters so that existing uses of the water or downstream waters are precluded.
7. Public hearings may be held prior to a Certification decision if deemed in the public's best interest by the Director of the North Carolina Division of Water Resources.

History Note: Water Quality Certification (WQC) Number 4806 issued March 3, 2017 replaces WQC 3884 issued March 19, 2012; WQC Number 3819 issued March 19, 2010; WQC Number 3699 issued November 1, 2007; WQC Number 3625 issued March 19, 2007; WQC Number 3374 issued March 18, 2002; WQC Number 3288 issued June 1, 2000; WQC Number 3101 issued February 11, 1997; WQC Number 3022 issued September 6, 1995, WQC Number 2664 issued January 21, 1992.

ANTI -SEEP COLLAR

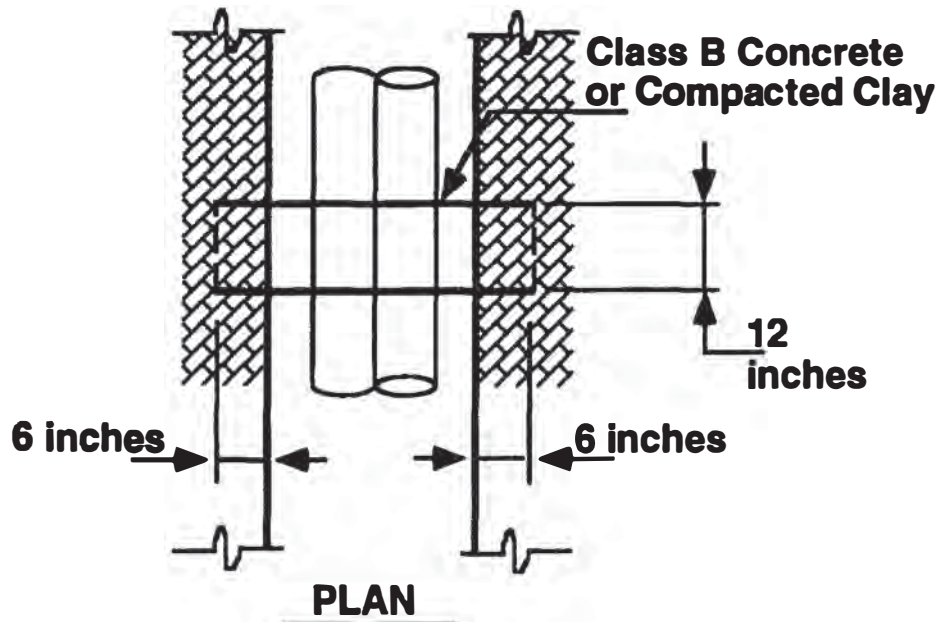
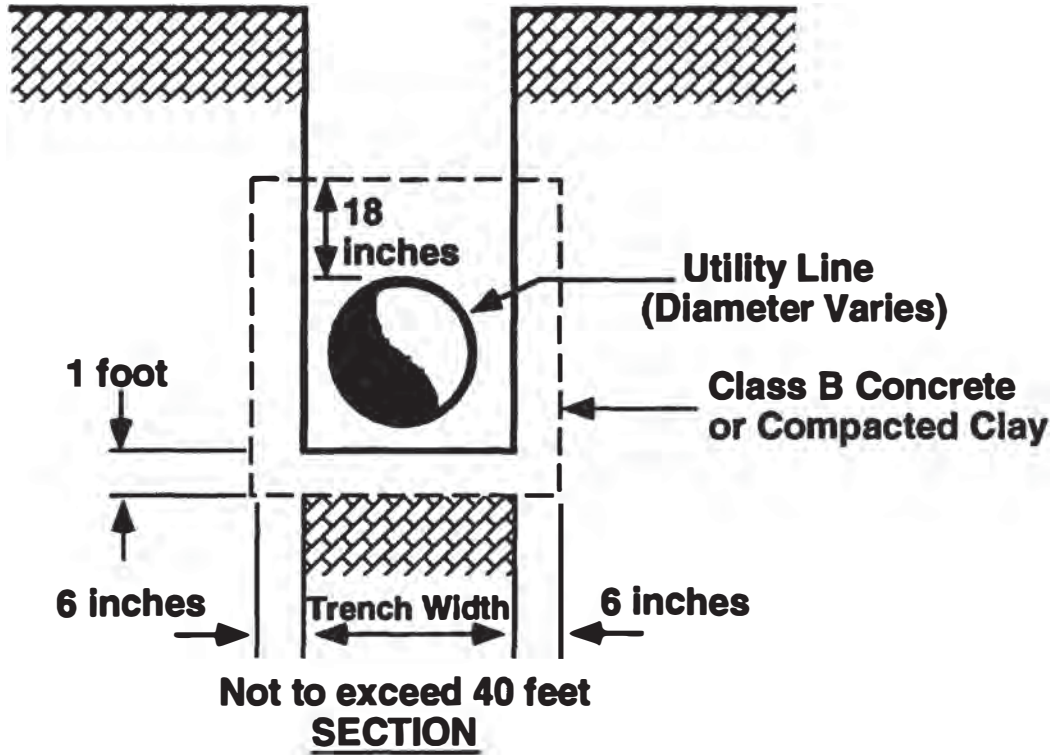

**STATE OF NORTH CAROLINA
DEPARTMENT OF ENVIRONMENTAL QUALITY
DIVISION OF WATER RESOURCES**

WATER QUALITY GENERAL CERTIFICATION NO. 4088

GENERAL CERTIFICATION FOR PROJECTS ELIGIBLE FOR US ARMY CORPS OF ENGINEERS

- **NATIONWIDE PERMIT NUMBER 14 (LINEAR TRANSPORTATION PROJECTS), AND**
- **REGIONAL GENERAL PERMIT 198200031 (NCDOT BRIDGES, WIDENING PROJECTS, INTERCHANGE IMPROVEMENTS)**

Water Quality Certification Number 4088 is issued in conformity with the requirements of Section 401, Public Laws 92-500 and 95-217 of the United States and subject to the North Carolina Regulations in 15A NCAC 02H .0500 and 15A NCAC 02B .0200 for the discharge of fill material to surface waters and wetland areas as described in 33 CFR 330 Appendix A (B) (14) of the US Army Corps of Engineers regulations and Regional General Permit 198200031.

The State of North Carolina certifies that the specified category of activity will not violate applicable portions of Sections 301, 302, 303, 306 and 307 of the Public Laws 92-500 and 95-217 if conducted in accordance with the conditions hereinafter set forth.

Effective date: March 19, 2017

Signed this day March 3, 2017

By

A handwritten signature in black ink, appearing to read 'S. Jay Zimmerman', is written over a horizontal line.

for S. Jay Zimmerman, P.G.
Director

P-39
GC4088

Activities meeting any one (1) of the following thresholds or circumstances require written approval for a 401 Water Quality Certification from the Division of Water Resources (DWR):

- a) If any of the conditions of this Certification (listed below) cannot be met; or
- b) Any temporary or permanent impacts to wetlands, open waters and/or streams, except for construction of a driveway to a single family residential lot that are not determined to be part of a larger common plan of development as long as the driveway involves *less than 25 feet* of total stream impacts, including any in-stream stabilization needed for the crossing; or
- c) Any stream relocation or stream restoration; or
- d) Any high density project, as defined in 15A NCAC 02H .1003(2)(a) and by the density thresholds specified in 15A NCAC 02H .1017, which does not have a stormwater management plan reviewed and approved under a state stormwater program¹ or a state-approved local government stormwater program². Projects that have vested rights, exemptions, or grandfathering from state or locally-implemented stormwater programs and projects that satisfy state or locally-implemented stormwater programs through use of community in-lieu programs **require written approval**; or
- e) Any impacts to waters, or to wetlands adjacent to waters, designated as: ORW (including SAV), HQW (including PNA), SA, WS-I, WS-II, Trout, or North Carolina or National Wild and Scenic River; or
- f) Any impacts to coastal wetlands [15A NCAC 07H .0205], or Unique Wetlands (UWL); or
- g) Any impact associated with a Notice of Violation or an enforcement action for violation(s) of NC Wetland Rules (15A NCAC 02H .0500), NC Isolated Wetland Rules (15A NCAC 02H .1300), NC Surface Water or Wetland Standards (15A NCAC 02B .0200), or State Regulated Riparian Buffer Rules (15A NCAC 02B .0200); or
- * h) Any impacts to subject water bodies and/or state regulated riparian buffers along subject water bodies in the Neuse, Tar-Pamlico, or Catawba River Basins or in the Randleman Lake, Jordan Lake or Goose Creek Watersheds (or any other basin or watershed with State Regulated Riparian Area Protection Rules [Buffer Rules] in effect at the time of application) *unless*:
 - i) The activities are listed as “EXEMPT” from these rules; or
 - ii) A Buffer Authorization Certificate is issued by the NC Division of Coastal Management (DCM); or
 - iii) A Buffer Authorization Certificate or a Minor Variance is issued by a delegated or designated local government implementing a state riparian buffer program pursuant to 143-215.23

Activities included in this General Certification that do not meet one of the thresholds listed above do not require written approval.

¹ e.g. Coastal Counties, HQW, ORW, or state-implemented Phase II NPDES

² e.g. Delegated Phase II NPDES, Water Supply Watershed, Nutrient-Sensitive Waters, or Universal Stormwater Management Program

P-40 GC4088

I. ACTIVITY SPECIFIC CONDITIONS:

- * 1. If this Water Quality Certification is used to access residential, commercial or industrial building sites, then all parcels owned by the applicant that are part of the single and complete project authorized by this Certification must be buildable without additional impacts to streams or wetlands. If required in writing by DWR, the applicant shall provide evidence that the parcels are buildable without requiring additional impacts to wetlands, waters, or state regulated riparian buffers. [15A NCAC 02H .0506(b)(4) and (c)(4)]
2. For road and driveway construction purposes, this Certification shall only be utilized from natural high ground to natural high ground. [15A NCAC 02H .0506(b)(2) and (c)(2)]
- *3. Deed notifications or similar mechanisms shall be placed on all lots with retained jurisdictional wetlands, waters, and state regulated riparian buffers within the project boundaries in order to assure compliance with NC Wetland Rules (15A NCAC 02H .0500), NC Isolated Wetland Rules (15A NCAC 02H .1300), and/or State Regulated Riparian Buffer Rules (15A NCAC 02B .0200). These mechanisms shall be put in place at the time of recording of the property or individual parcels, whichever is appropriate. [15A NCAC 02H .0506(b)(4) and (c)(4)]
4. For the North Carolina Department of Transportation, compliance with the NCDOT's individual NPDES permit NCS000250 shall serve to satisfy this condition. For all other projects that disturb one acre or more of land (including a project that disturbs less than one acre of land that is part of a larger common plan of development or sale); have permanent wetland, stream, or open water impacts; and are proposing new built-upon area shall comply with the following requirements: [15A NCAC 02H .0506(b)(5) and (c)(5)]
 - a. Stormwater management shall be provided throughout the entire project area in accordance with 15A NCAC 02H .1003. For the purposes of 15A NCAC 02H .1003(2)(a), density thresholds shall be determined in accordance with 15A NCAC 02H .1017.
 - b. Projects that have vested rights, exemptions, or grandfathering from state or locally-implemented stormwater programs do not satisfy this condition. Projects that satisfy state or locally-implemented stormwater programs through use of community in-lieu programs do not satisfy this condition.
 - c. Projects that require written authorization from DWR shall submit the following with their application for review and approval:
 - i. For projects that have a stormwater management plan (SMP) reviewed under a state stormwater program¹ or a state-approved local government stormwater program² shall submit plans that show the location and approximate size of all proposed stormwater measures;

¹ e.g. Coastal Counties, HQW, ORW, or state-implemented Phase II NPDES

² e.g. Delegated Phase II NPDES, Water Supply Watershed, Nutrient-Sensitive Waters, or Universal Stormwater Management Program

P-41
GC4088

- ii. All other low density projects not covered above shall submit a completed low density supplement form with all required items; and
- iii. All other high density projects not covered above shall submit a completed SMP, including all appropriate stormwater control measure (SCM) supplemental forms and associated items, that complies with the high density development requirements of 15A NCAC 02H .1003.
- d. Projects that do not require written approval from DWR shall obtain approval of the SMP, when required, before any impacts authorized by this Certification occur.
- e. SMPs approved by DWR may be phased on a case-by-case basis. SMPs for each future phase must be approved before construction of that phase commences. Approved SMPs may not be modified without prior written authorization from DWR.

II. GENERAL CONDITIONS:

- *1. When written authorization is required, the plans and specifications for the project are incorporated into the authorization by reference and are an enforceable part of the Certification. Any modifications to the project require notification to DWR and may require an application submittal to DWR with the appropriate fee. [15A NCAC 02H .0501 and .0502]
- 2. No waste, spoil, solids, or fill of any kind shall occur in wetlands or waters beyond the footprint of the impacts (including temporary impacts) as authorized in the written approval from DWR; or beyond the thresholds established for use of this Certification without written authorization. [15A NCAC 02H .0501 and .0502]

No removal of vegetation or other impacts of any kind shall occur to state regulated riparian buffers beyond the footprint of impacts approved in a Buffer Authorization or Variance or as listed as an exempt activity in the applicable riparian buffer rules. [15A NCAC 02B .0200]

- * 3. In accordance with 15A NCAC 02H .0506(h), compensatory mitigation may be required for losses of greater than 150 linear feet of streams and/or greater than one (1) acre of wetlands. Impacts to isolated and other non-404 jurisdictional wetlands shall not be combined with 404 jurisdictional wetlands for the purpose of determining when impact thresholds trigger a mitigation requirement. For linear publicly owned and maintained transportation projects that are not determined to be part of a larger common plan of development by the US Army Corps of Engineers, compensatory mitigation may be required for losses of greater than 150 linear feet per stream.

Compensatory stream and/or wetland mitigation shall be proposed and completed in compliance with G.S. 143-214.11. For applicants proposing to conduct mitigation within a project site, a complete mitigation proposal developed in accordance with the most recent guidance issued by the US Army Corps of Engineers Wilmington District shall be submitted for review and approval with the application for impacts.

P-42
GC4088

4. All activities shall be in compliance with any applicable State Regulated Riparian Buffer Rules in Chapter 2 of Title 15A.
5. When applicable, all construction activities shall be performed and maintained in full compliance with G.S. Chapter 113A Article 4 (Sediment and Pollution Control Act of 1973). Regardless of applicability of the Sediment and Pollution Control Act, all projects shall incorporate appropriate Best Management Practices for the control of sediment and erosion so that no violations of state water quality standards, statutes, or rules occur. [15A NCAC 02H .0506(b)(3) and (c)(3) and 15A NCAC 02B .0200]

Design, installation, operation, and maintenance of all sediment and erosion control measures shall be equal to or exceed the requirements specified in the most recent version of the *North Carolina Sediment and Erosion Control Manual*, or for linear transportation projects, the *NCDOT Sediment and Erosion Control Manual*.

All devices shall be maintained on all construction sites, borrow sites, and waste pile (spoil) sites, including contractor-owned or leased borrow pits associated with the project. Sufficient materials required for stabilization and/or repair of erosion control measures and stormwater routing and treatment shall be on site at all times.

For borrow pit sites, the erosion and sediment control measures shall be designed, installed, operated, and maintained in accordance with the most recent version of the *North Carolina Surface Mining Manual*. Reclamation measures and implementation shall comply with the reclamation in accordance with the requirements of the Sedimentation Pollution Control Act and the Mining Act of 1971.

If the project occurs in waters or watersheds classified as Primary Nursery Areas (PNAs), SA, WS-I, WS-II, High Quality Waters (HQW), or Outstanding Resource Waters (ORW), then the sedimentation and erosion control designs shall comply with the requirements set forth in 15A NCAC 04B .0124, *Design Standards in Sensitive Watersheds*.

6. Sediment and erosion control measures shall not be placed in wetlands or waters except within the footprint of temporary or permanent impacts authorized under this Certification. Exceptions to this condition require application to and written approval from DWR. [15A NCAC 02H .0501 and .0502]
7. Erosion control matting that incorporates plastic mesh and/or plastic twine shall not be used along streambanks or within wetlands. Exceptions to this condition require application to and written approval from DWR. [15A NCAC 02B .0201]

P-43
GC4088

8. An NPDES Construction Stormwater Permit (NCG010000) is required for construction projects that disturb one (1) or more acres of land. The NCG010000 Permit allows stormwater to be discharged during land disturbing construction activities as stipulated in the conditions of the permit. If the project is covered by this permit, full compliance with permit conditions including the erosion & sedimentation control plan, inspections and maintenance, self-monitoring, record keeping and reporting requirements is required. [15A NCAC 02H .0506(b)(5) and (c)(5)]

The North Carolina Department of Transportation (NCDOT) shall be required to be in full compliance with the conditions related to construction activities within the most recent version of their individual NPDES (NCS000250) stormwater permit. [15A NCAC 02H .0506(b)(5) and (c)(5)]

9. All work in or adjacent to streams shall be conducted so that the flowing stream does not come in contact with the disturbed area. Approved best management practices from the most current version of the *NC Sediment and Erosion Control Manual*, or the *NC DOT Construction and Maintenance Activities Manual*, such as sandbags, rock berms, cofferdams, and other diversion structures shall be used to minimize excavation in flowing water. Exceptions to this condition require application to and written approval from DWR. [15A NCAC 02H .0506(b)(3) and (c)(3)]
10. If activities must occur during periods of high biological activity (e.g. sea turtle nesting, fish spawning, or bird nesting), then biological monitoring may be required at the request of other state or federal agencies and coordinated with these activities. [15A NCAC 02H .0506 (b)(2) and 15A NCAC 04B .0125]

All moratoriums on construction activities established by the NC Wildlife Resources Commission (WRC), US Fish and Wildlife Service (USFWS), NC Division of Marine Fisheries (DMF), or National Marine Fisheries Service (NMFS) shall be implemented. Exceptions to this condition require written approval by the resource agency responsible for the given moratorium. A copy of the approval from the resource agency shall be forwarded to DWR.

Work within a designated trout watershed of North Carolina (as identified by the Wilmington District of the US Army Corps of Engineers), or identified state or federal endangered or threatened species habitat, shall be coordinated with the appropriate WRC, USFWS, NMFS, and/or DMF personnel.

11. Culverts shall be designed and installed in such a manner that the original stream profiles are not altered and allow for aquatic life movement during low flows. The dimension, pattern, and profile of the stream above and below a pipe or culvert shall not be modified by widening the stream channel or by reducing the depth of the stream in connection with the construction activity. The width, height, and gradient of a proposed culvert shall be such as to pass the average historical low flow and spring flow without adversely altering flow velocity. [15A NCAC 02H .0506(b)(2) and (c)(2)]

P-44 GC4088

Placement of culverts and other structures in streams shall be below the elevation of the streambed by one foot for all culverts with a diameter greater than 48 inches, and 20% of the culvert diameter for culverts having a diameter less than or equal to 48 inches, to allow low flow passage of water and aquatic life.

If multiple pipes or barrels are required, they shall be designed to mimic the existing stream cross section as closely as possible including pipes or barrels at flood plain elevation and/or sills where appropriate. Widening the stream channel shall be avoided.

When topographic constraints indicate culvert slopes of greater than 5%, culvert burial is not required, provided that all alternative options for flattening the slope have been investigated and aquatic life movement/connectivity has been provided when possible (e.g. rock ladders, cross vanes, etc.). Notification, including supporting documentation to include a location map of the culvert, culvert profile drawings, and slope calculations, shall be provided to DWR 60 calendar days prior to the installation of the culvert.

When bedrock is present in culvert locations, culvert burial is not required provided that there is sufficient documentation of the presence of bedrock. Notification, including supporting documentation such as, a location map of the culvert, geotechnical reports, photographs, etc. shall be provided to DWR a minimum of 60 calendar days prior to the installation of the culvert. If bedrock is discovered during construction, then DWR shall be notified by phone or email within 24 hours of discovery.

If other site-specific topographic constraints preclude the ability to bury the culverts as described above and/or it can be demonstrated that burying the culvert would result in destabilization of the channel, then exceptions to this condition require application to and written approval from DWR.

Installation of culverts in wetlands shall ensure continuity of water movement and be designed to adequately accommodate high water or flood conditions. When roadways, causeways, or other fill projects are constructed across FEMA-designated floodways or wetlands, openings such as culverts or bridges shall be provided to maintain the natural hydrology of the system as well as prevent constriction of the floodway that may result in destabilization of streams or wetlands.

The establishment of native woody vegetation and other soft stream bank stabilization techniques shall be used where practicable instead of rip-rap or other bank hardening methods.

12. Bridge deck drains shall not discharge directly into the stream. Stormwater shall be directed across the bridge and pre-treated through site-appropriate means to the maximum extent practicable (e.g. grassed swales, pre-formed scour holes, vegetated buffers, etc.) before entering the stream. Exceptions to this condition require application to and written approval from DWR. [15A NCAC 02H .0506(b)(5)]

P-45
GC4088

13. Application of fertilizer to establish planted/seeded vegetation within disturbed riparian areas and/or wetlands shall be conducted at agronomic rates and shall comply with all other Federal, State and Local regulations. Fertilizer application shall be accomplished in a manner that minimizes the risk of contact between the fertilizer and surface waters. [15A NCAC 02B .0200 and 15A NCAC 02B .0231]
14. If concrete is used during construction, then all necessary measures shall be taken to prevent direct contact between uncured or curing concrete and waters of the state. Water that inadvertently contacts uncured concrete shall not be discharged to waters of the state. [15A NCAC 02B .0200]
15. All proposed and approved temporary fill and culverts shall be removed and the impacted area shall be returned to natural conditions within 60 calendar days after the temporary impact is no longer necessary. The impacted areas shall be restored to original grade, including each stream's original cross sectional dimensions, planform pattern, and longitudinal bed profile. For projects that receive written approval, no temporary impacts are allowed beyond those included in the application and authorization. All temporarily impacted sites shall be restored and stabilized with native vegetation. [15A NCAC 02H .0506(b)(2) and (c)(2)]
16. All proposed and approved temporary pipes/culverts/rip-rap pads etc. in streams shall be installed as outlined in the most recent edition of the *North Carolina Sediment and Erosion Control Planning and Design Manual* or the *North Carolina Surface Mining Manual* or the *North Carolina Department of Transportation Best Management Practices for Construction and Maintenance Activities* so as not to restrict stream flow or cause dis-equilibrium during use of this Certification. [15A NCAC 02H .0506(b)(2) and (c)(2)]
17. Any rip-rap required for proper culvert placement, stream stabilization, or restoration of temporarily disturbed areas shall be restricted to the area directly impacted by the approved construction activity. All rip-rap shall be placed such that the original stream elevation and streambank contours are restored and maintained. Placement of rip-rap or other approved materials shall not result in de-stabilization of the stream bed or banks upstream or downstream of the area or in a manner that precludes aquatic life passage. [15A NCAC 02H .0506(b)(2)]
18. Any rip-rap used for stream or shoreline stabilization shall be of a size and density to prevent movement by wave, current action, or stream flows and shall consist of clean rock or masonry material free of debris or toxic pollutants. Rip-rap shall not be installed in the streambed except in specific areas required for velocity control and to ensure structural integrity of bank stabilization measures. [15A NCAC 02H .0506(b)(2)]
19. Applications for rip-rap groins proposed in accordance with 15A NCAC 07H .1401 (NC Division of Coastal Management General Permit for construction of Wooden and Rip-rap Groins in Estuarine and Public Trust Waters) shall meet all the specific conditions for design and construction specified in 15A NCAC 07H .1405.

P-46
GC4088

20. All mechanized equipment operated near surface waters shall be inspected and maintained regularly to prevent contamination of surface waters from fuels, lubricants, hydraulic fluids, or other toxic materials. Construction shall be staged in order to minimize the exposure of equipment to surface waters to the maximum extent practicable. Fueling, lubrication and general equipment maintenance shall not take place within 50 feet of a waterbody or wetlands to prevent contamination by fuels and oils. [15A NCAC 02H .0506(b)(3) and (c)(3) and 15A NCAC 02B .0211 (12)]
21. Heavy equipment working in wetlands shall be placed on mats or other measures shall be taken to minimize soil disturbance. [15A NCAC 02H .0506(b)(3) and (c)(3)]
22. In accordance with 143-215.85(b), the applicant shall report any petroleum spill of 25 gallons or more; any spill regardless of amount that causes a sheen on surface waters; any petroleum spill regardless of amount occurring within 100 feet of surface waters; and any petroleum spill less than 25 gallons that cannot be cleaned up within 24 hours.
- * 23. If an environmental document is required under the State Environmental Policy Act (SEPA), then this General Certification is not valid until a Finding of No Significant Impact (FONSI) or Record of Decision (ROD) is issued by the State Clearinghouse. If an environmental document is required under the National Environmental Policy Act (NEPA), then this General Certification is not valid until a Categorical Exclusion, the Final Environmental Assessment, or Final Environmental Impact Statement is published by the lead agency. [15A NCAC 01C .0107(a)]
24. This General Certification does not relieve the applicant of the responsibility to obtain all other required Federal, State, or Local approvals before proceeding with the project, including those required by, but not limited to, Sediment and Erosion Control, Non-Discharge, Water Supply Watershed, and Trout Buffer regulations.
25. The applicant and their authorized agents shall conduct all activities in a manner consistent with State water quality standards (including any requirements resulting from compliance with §303(d) of the Clean Water Act), and any other appropriate requirements of State and Federal Law. If DWR determines that such standards or laws are not being met, including failure to sustain a designated or achieved use, or that State or Federal law is being violated, or that further conditions are necessary to assure compliance, then DWR may revoke or modify a written authorization associated with this General Water Quality Certification. [15A NCAC 02H .0507(d)]
- * 26. When written authorization is required for use of this Certification, upon completion of all permitted impacts included within the approval and any subsequent modifications, the applicant shall be required to return a certificate of completion (available on the DWR website <https://edocs.deq.nc.gov/Forms/Certificate-of-Completion>). [15A NCAC 02H .0502(f)]

P-47
GC4088

27. Additional site-specific conditions, including monitoring and/or modeling requirements, may be added to the written approval letter for projects proposed under this Water Quality Certification in order to ensure compliance with all applicable water quality and effluent standards. [15A NCAC 02H .0507(c)]
28. If the property or project is sold or transferred, the new Permittee shall be given a copy of this Certification (and written authorization if applicable) and is responsible for complying with all conditions. [15A NCAC 02H .0501 and .0502]

III. GENERAL CERTIFICATION ADMINISTRATION:

- *1. In accordance with North Carolina General Statute 143-215.3D(e), written approval for a 401 Water Quality General Certification must include the appropriate fee. An applicant for a CAMA permit under Article 7 of Chapter 113A of the General Statutes for which a Water Quality Certification is required shall only make one payment to satisfy both agencies; the fee shall be as established by the Secretary in accordance with 143-215.3D(e)(7).
2. This Certification neither grants nor affirms any property right, license, or privilege in any waters, or any right of use in any waters. This Certification does not authorize any person to interfere with the riparian rights, littoral rights, or water use rights of any other person and this Certification does not create any prescriptive right or any right of priority regarding any usage of water. This Certification shall not be interposed as a defense in any action respecting the determination of riparian or littoral rights or other rights to water use. No consumptive user is deemed by virtue of this Certification to possess any prescriptive or other right of priority with respect to any other consumptive user regardless of the quantity of the withdrawal or the date on which the withdrawal was initiated or expanded.
3. This Certification grants permission to the Director, an authorized representative of the Director, or DWR staff, upon the presentation of proper credentials, to enter the property during normal business hours. [15A NCAC 02H .0502(e)]
4. This General Certification shall expire on the same day as the expiration date of the corresponding Nationwide Permit and/or Regional General Permit. The conditions in effect on the date of issuance of Certification for a specific project shall remain in effect for the life of the project, regardless of the expiration date of this Certification. This General Certification is rescinded when the US Army Corps of Engineers reauthorizes any of the corresponding Nationwide Permits and/or Regional General Permits or when deemed appropriate by the Director of the Division of Water Resources.
5. Non-compliance with or violation of the conditions herein set forth by a specific project may result in revocation of this General Certification for the project and may also result in criminal and/or civil penalties.

P-48
GC4088

- ★ 6. The Director of the North Carolina Division of Water Resources may require submission of a formal application for Individual Certification for any project in this category of activity if it is determined that the project is likely to have a significant adverse effect upon water quality, including state or federally listed endangered or threatened aquatic species, or degrade the waters so that existing uses of the water or downstream waters are precluded.
- 7. Public hearings may be held prior to a Certification decision if deemed in the public's best interest by the Director of the North Carolina Division of Water Resources.

History Note: Water Quality Certification (WQC) Number 4088 issued March 3, 2017 replaces WQC 3886 issued March 12, 2012; WQC Number 3820 issued April 6, 2010; WQC Number 3627 issued March 2007; WQC Number 3404 issued March 2003; WQC Number 3375 issued March 18, 2002; WQC Number 3289 issued June 1, 2000; WQC Number 3103 issued February 11, 1997; WQC Number 2732 issued May 1, 1992; WQC Number 2666 issued January 21, 1992; WQC Number 2177 issued November 5, 1987.

See Sheet 1-A For Index of Sheets
See Sheet 1-B For Conventional Symbols

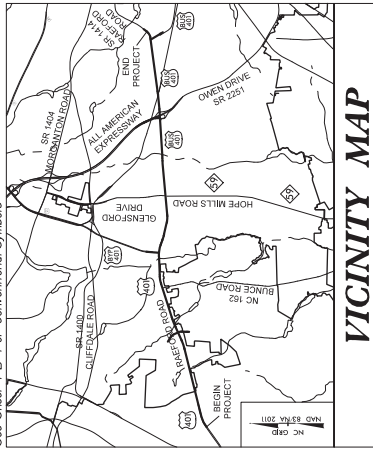

VICINITY MAP

STATE OF NORTH CAROLINA
DIVISION OF HIGHWAYS

CUMBERLAND COUNTY

LOCATION: US 401 FROM WEST OF HAPTON OAKS DRIVE TO EAST OF FAIRWAY DRIVE IN FAYETTEVILLE
TYPE OF WORK: GRADING, DRAINAGE, PAVING, SIGNALS, WIDENING, RESURFACING, STRUCTURE, RETAINING WALLS, AND NOISE WALLS

STATE	N.C.
PRIVATE PROJECT NUMBER	U-4405
DATE	1
PROJECT NUMBER	39049.1.1
DATE	STPDA-0401(230)
DESIGNER	PE

**PERMIT DRAWING
SHEET 1 OF 17**

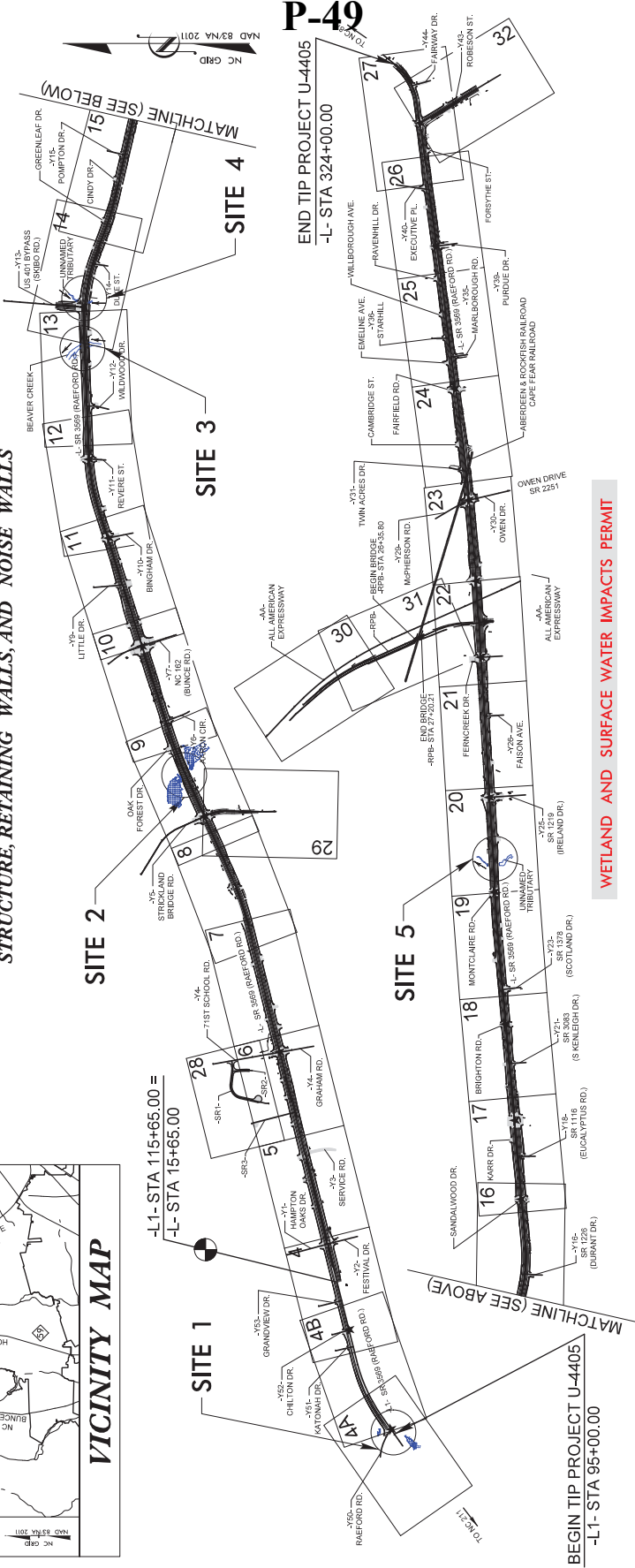

WETLAND AND SURFACE WATER IMPACTS PERMIT

THIS PROJECT IS WITHIN THE MUNICIPAL BOUNDARIES OF THE CITY OF FAYETTEVILLE.
CLEARING ON THIS PROJECT SHALL BE PERFORMED TO THE LIMITS ESTABLISHED BY METHOD II.
** A DESIGN EXCEPTION FOR LANE WIDTH IS REQUIRED

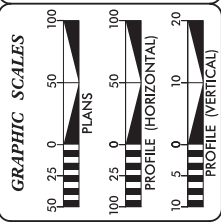

DESIGN DATA

ADT 2018	= 63,150
ADT 2038	= 70,975
K	= 10 %
D	= 60 %
T	= 3 %*
V	= 50 MPH
*TST = 1% DUAL = 2%	
FUNC CLASS = URBAN ARTERIAL REGIONAL TIER	

PROJECT LENGTH
LENGTH ROADWAY TIP PROJECT U-4405 = 6.231 MILES
TOTAL LENGTH TIP PROJECT U-4405 = 6.231 MILES

NGDOT CONTACT: BRENDA MOORE, PE

ATKINS
Prepared in the Office of:
1616 EAST HILLBROOK ROAD, SUITE 310
FAYETTEVILLE, NC 28404
(919) 374-8888 LICENSE #E-0028

201 STANDARD SPECIFICATIONS

RIGHT OF WAY DATE:	JULY 29, 2016
LETTING DATE:	JULY 17, 2018

HYDRAULICS ENGINEER	P.E.
ROADWAY DESIGN ENGINEER	P.E.

CLINTON J. MORGAN, PE
PROJECT ENGINEER

VIRGINIA SCHAAR, PE
PROJECT DESIGN ENGINEER



TIP PROJECT: U-4405

CONTRACT:

P-49

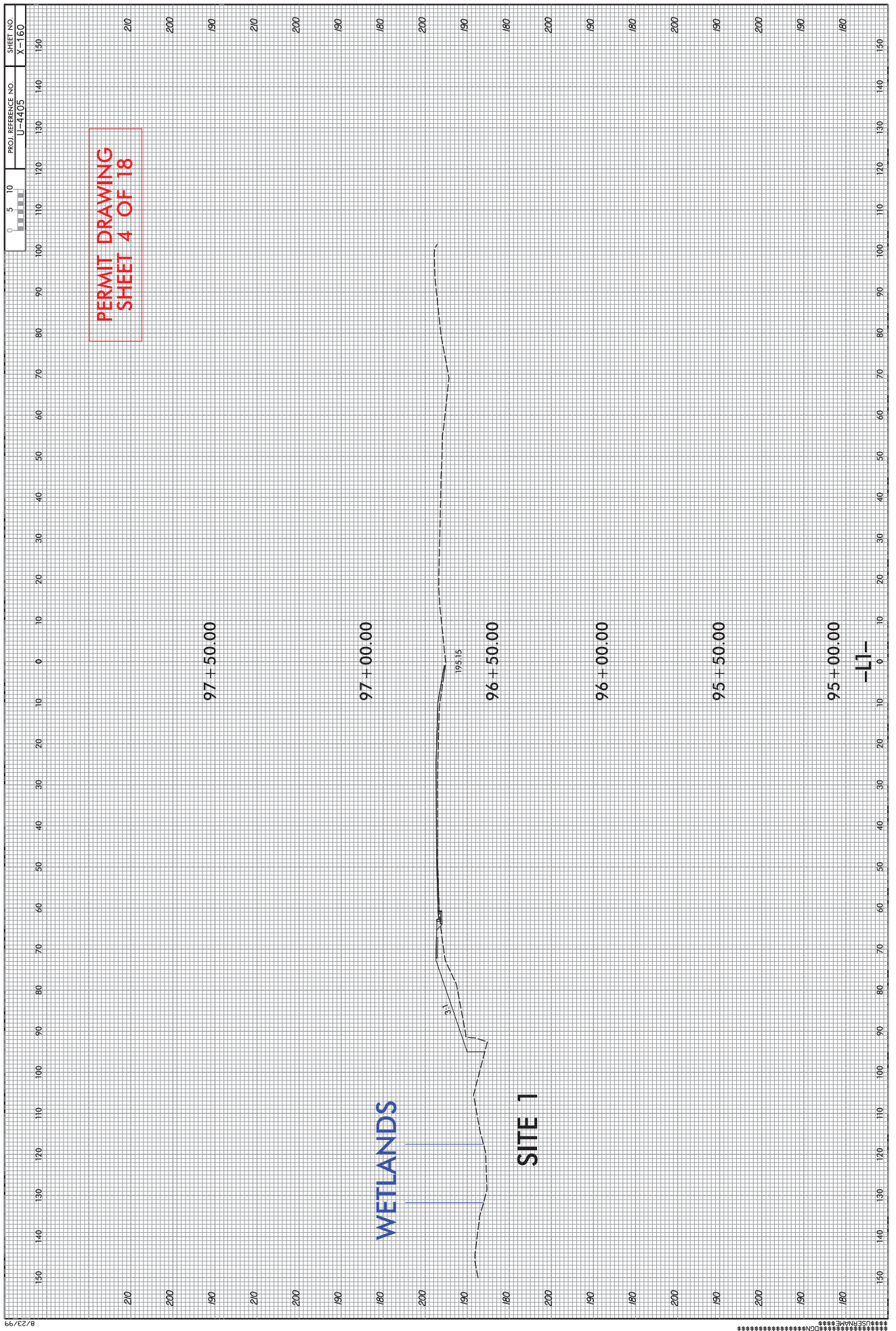

PERMIT DRAWING
SHEET 4 OF 18

WETLANDS

SITE 1

97 + 50.00

97 + 00.00

96 + 50.00

96 + 00.00

95 + 50.00

95 + 00.00

-L1-

PROJECT REFERENCE NO.	U-4405	SHEET NO.	9
ROADWAY DESIGN ENGINEER	HYDRAULICS ENGINEER		
INCOMPLETE PLANS DO NOT USE FOR CONSTRUCTION			

PIS STA 81+21.39
 PIS STA 81+71.94
 PIS STA 88+21.95
 Δ = 5.27' (RT)
 Δ = 5.45' (RT)
 Δ = 0.20' (LT)
 L = 63.99'
 L = 33.40'
 L = 66.67'
 T = 37.22'
 T = 31.22'
 R = 6300.00'
 R = 3333.33'
 SE = 0.025

PERMIT DRAWING
SHEET 6 OF 18
 REVISED: 2/16/2018

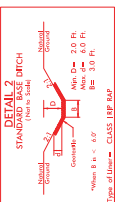
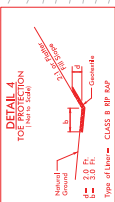

-Y5-
 PIS STA 15+94.46
 Δ = 34' 10" (44.0') (RT)
 Δ = 30' 0" (36.0') (RT)
 L = 37.95'
 L = 163.86'
 R = 5333.00'

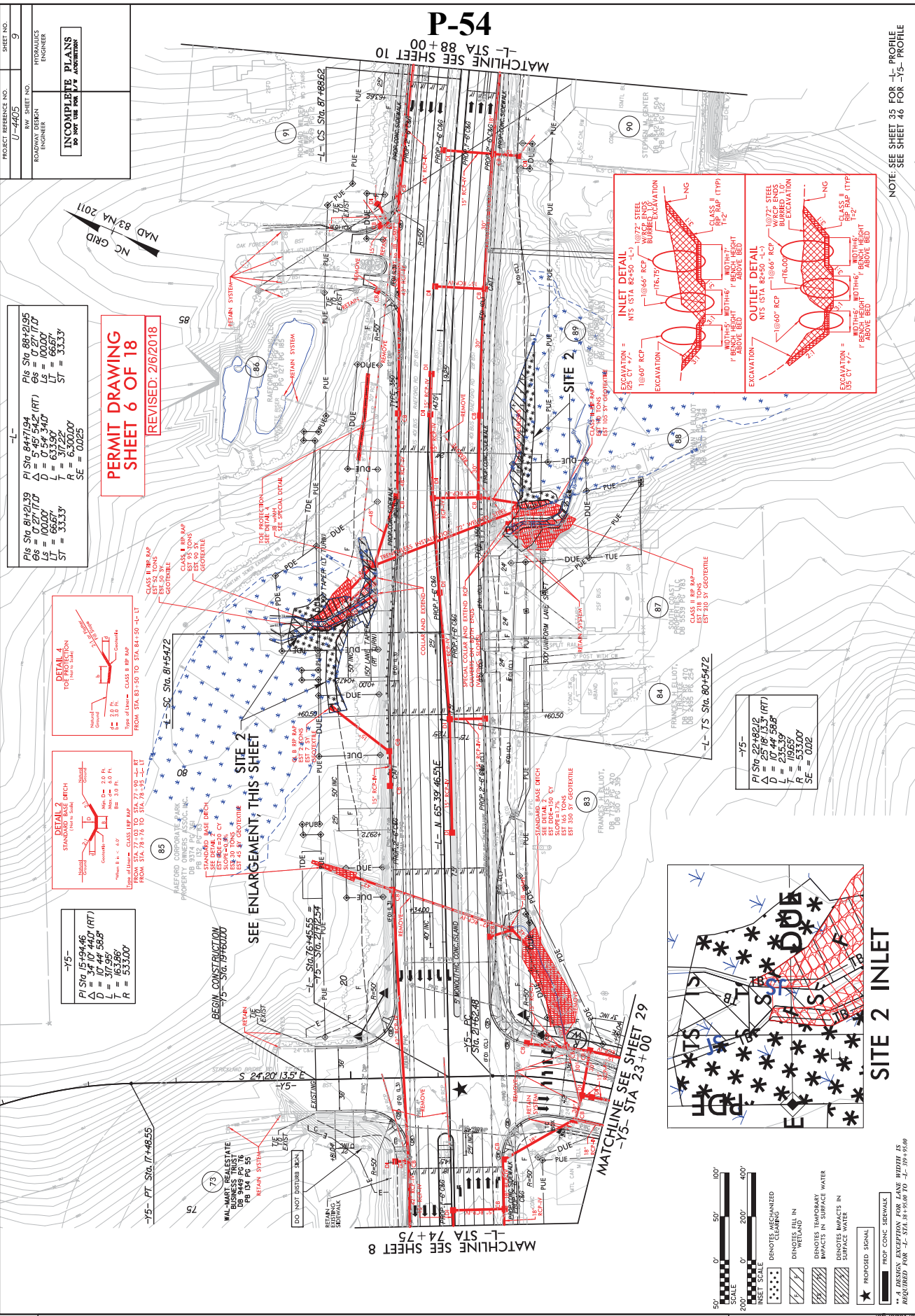

MATCHLINE SEE SHEET 10
 -L- STA 88+00
P-54
 MATCHLINE SEE SHEET 8
 -L- STA 74+75

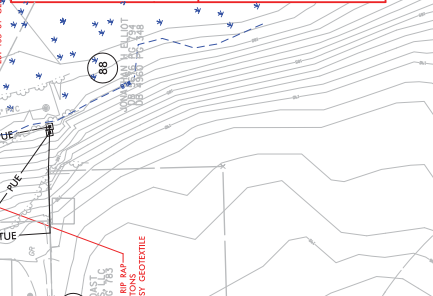
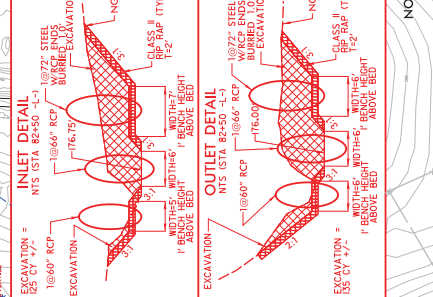

-Y5-
 PIS STA 22+42.12
 Δ = 25' 18" (33.3') (RT)
 Δ = 25' 18" (33.3') (RT)
 L = 294.39'
 L = 719.65'
 R = 5333.00'
 SE = 0.02



MATCHLINE SEE SHEET 29
 -Y5- STA 23+00

MATCHLINE SEE SHEET 10
 -L- STA 88+00

NOTE: SEE SHEET 35 FOR -Y5- PROFILE
 SEE SHEET 46 FOR -Y5- PROFILE

REVISIONS

NO.	DATE	DESCRIPTION

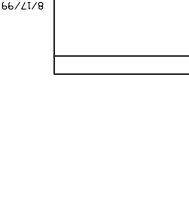

8/17/99

PERMIT DRAWING
SHEET 7 OF 18

P-55

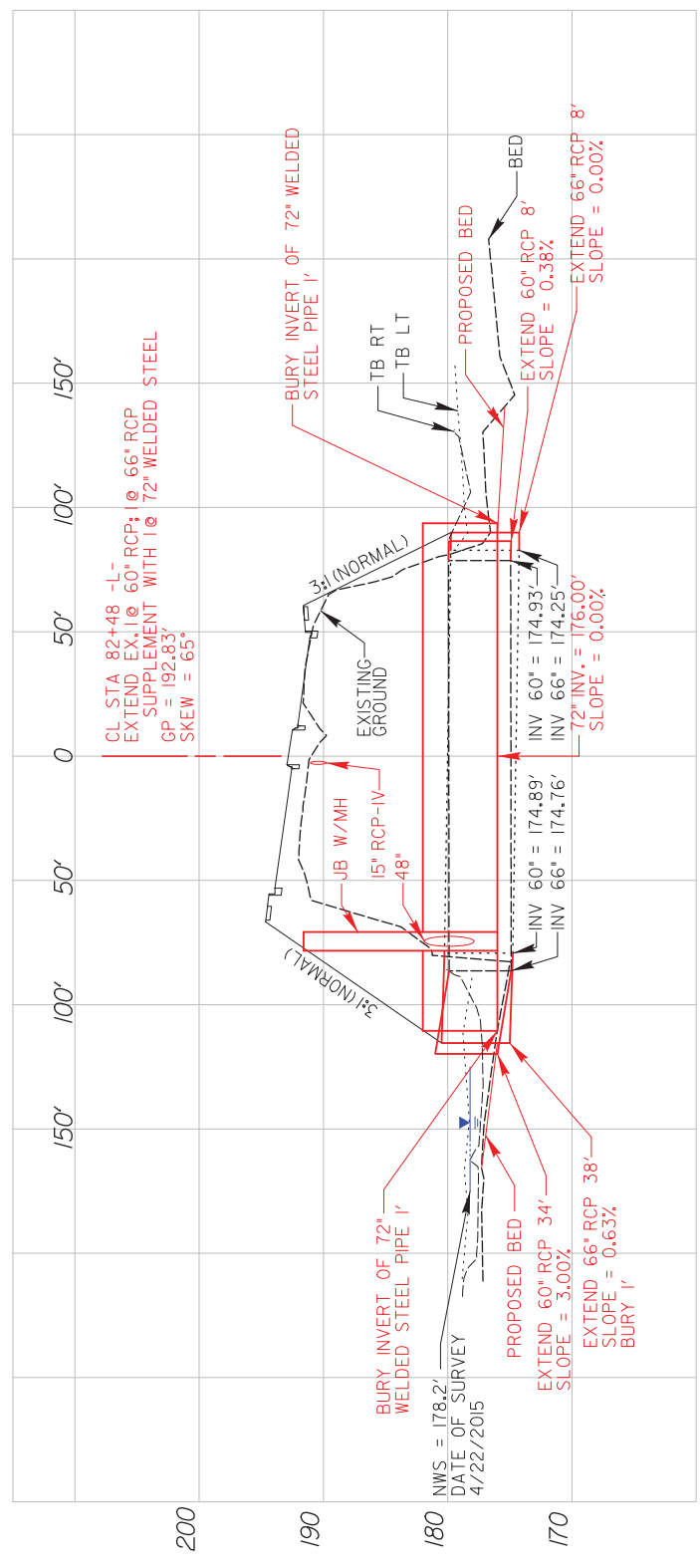

**PERMIT DRAWING
 SHEET 8 OF 18**

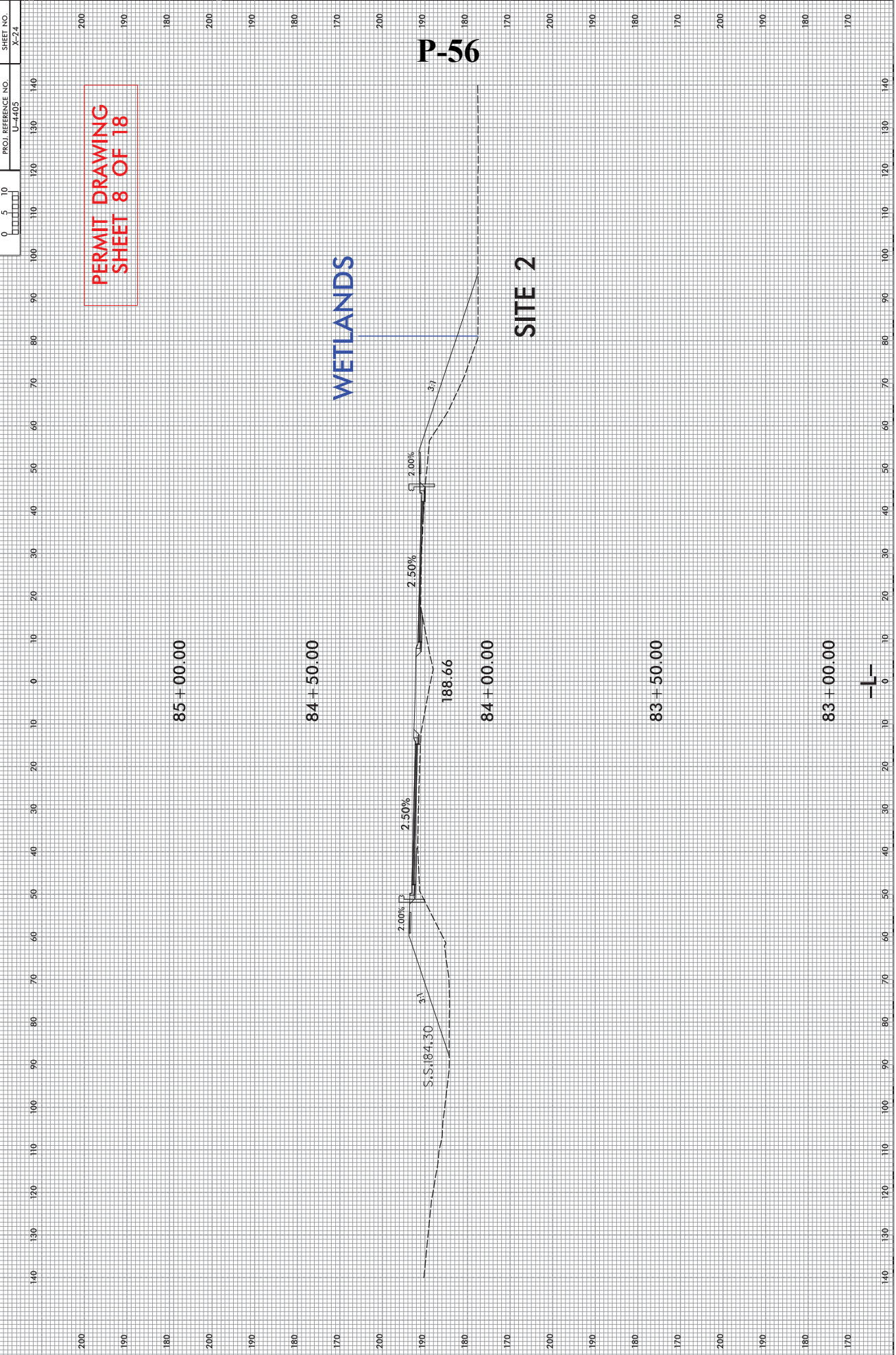

P-56

P-57

PROJECT REFERENCE NO.	U-4405	SHEET NO.	13
ROADWAY DESIGN ENGINEER	HYDRAULICS ENGINEER		
INCOMPLETE PLANS	DO NOT SCALE OR REPRODUCE		

-L- PIS Sta 139+95.56 PI Sta 144+71.01
 Pts = 4.43 (7.9') Δ = 19.18' 58.8" (RT)
 U = 1.0000 D = 842.43'
 L = 100.00 T = 425.45'
 S = 50.00 R = 2500.00'
 SE = 0.03

PERMIT DRAWING SHEET 9 OF 18

REVISED: 2/6/2018

NAD 83/NA 2011
NC GRID

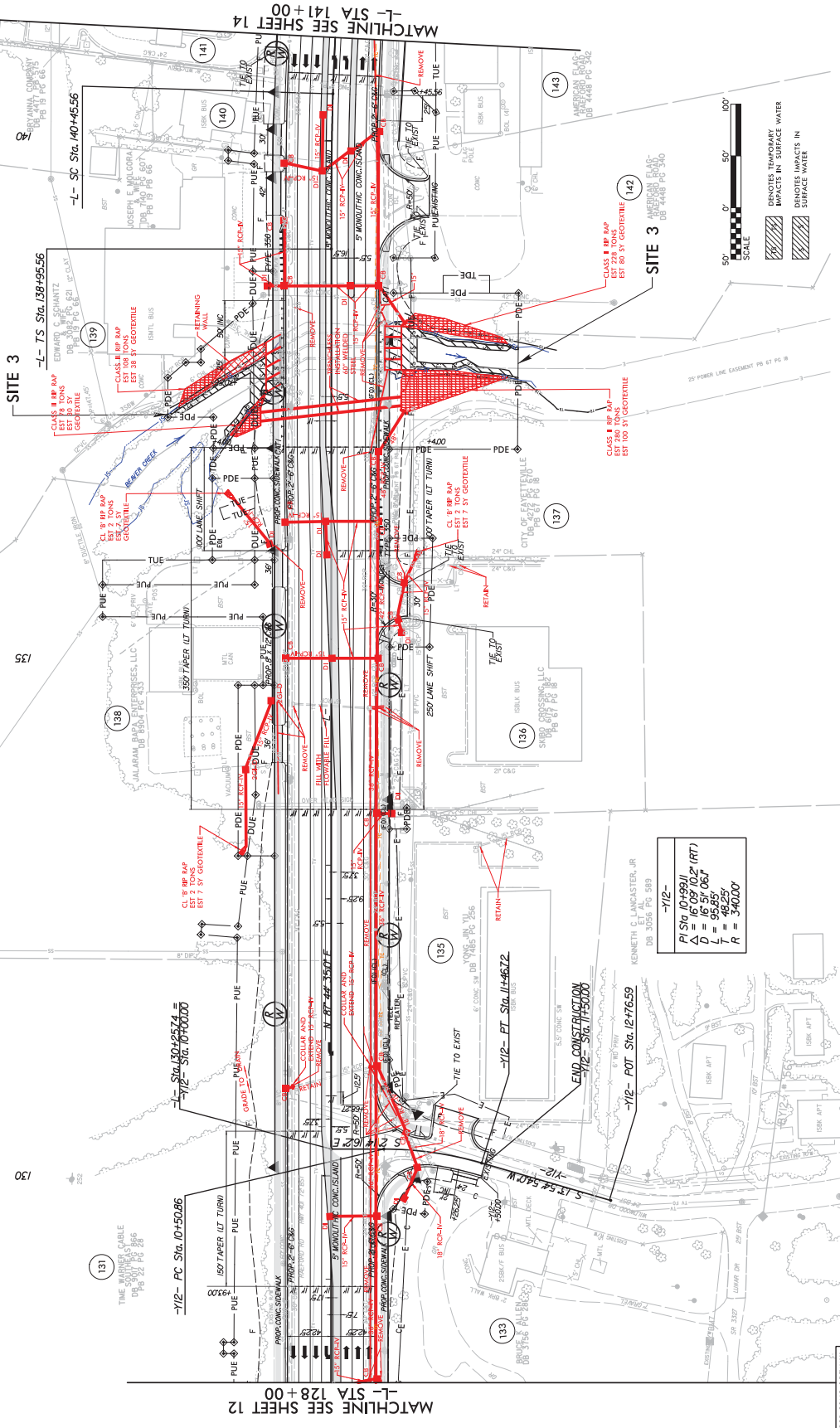
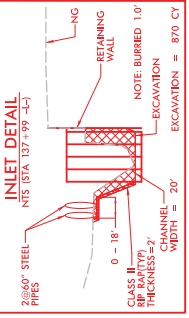
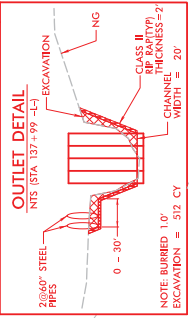

HATCHES TEMPORARY IMPACTS IN SURFACE WATER
 HATCHES IMPACTS IN SURFACE WATER

NOTE: SEE SHEET 37 FOR -L- PROFILE
SEE SHEET 47 FOR -Y12- PROFILE

-Y12- PIS Sta 10+99.01 PI Sta 112+02.17 (RT)
 Pts = 16.09 (102.1') Δ = 95.85' 06.7"
 U = 1.0000 D = 482.25'
 L = 100.00 T = 482.25'
 S = 50.00 R = 340.00'

PROF CONC. SIDEWALKS
 ** A DESIGN EXCEPTION FOR LANE WIDTH IS REQUIRED FOR -L- STA. 134+55.00 TO -L- STA. 135.00

REVISIONS

P-58

PROJECT REFERENCE NO. U-4405
SHEET NO. 13

ROADWAY DESIGN ENGINEER
HYDRAULICS ENGINEER

INCOMPLETE PLANS
DO NOT CONSTRUCT

PERMIT DRAWING SHEET 10 OF 18
REVISED: 2/6/2018

$Pis Sta 139+95.56$
 $\Delta = 191.8'$
 $D = 842.3'$
 $T = 425.45'$
 $R = 2500.00'$
 $SE = 0.03$

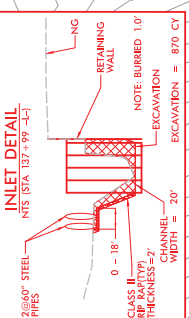
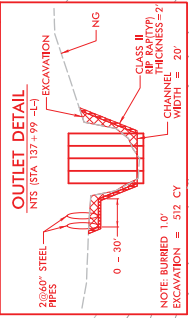

NAD 83/NA 2011
NC GRID

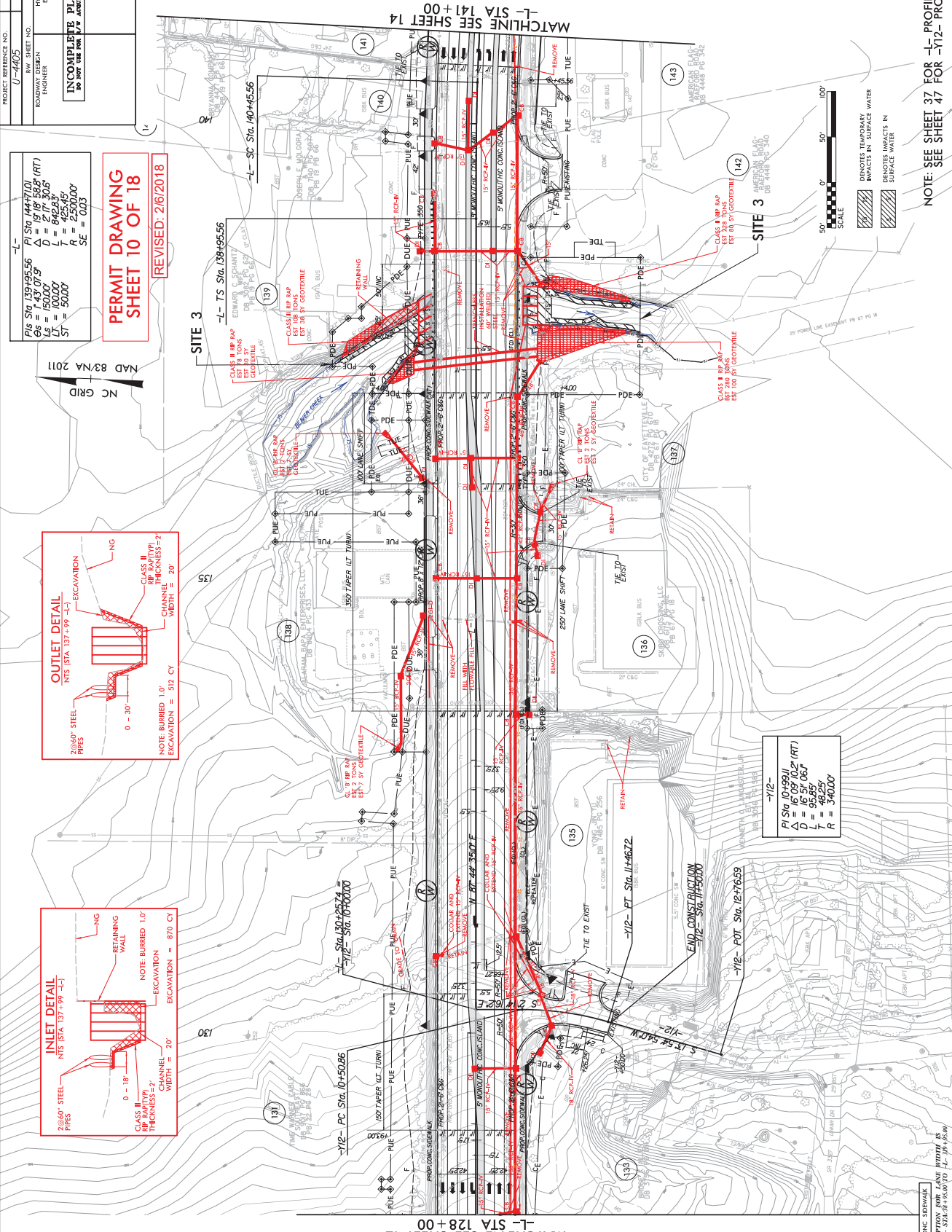

RIP RAP IMPACTS IN SURFACE WATER

 TEMPORARY IMPACTS IN SURFACE WATER

NOTE: SEE SHEET 37 FOR -L- PROFILE
SEE SHEET 47 FOR -Y12- PROFILE

$-Y12-$
 $Pis Sta 10+99.11$
 $\Delta = 16.09'$
 $D = 95.85'$
 $T = 48.25'$
 $R = 340.00'$

$-Y12-$ POT Sta. 127+6.59
 END CONSTRUCTION
 $-Y12-$ PT Sta. 11+46.72

MATCHLINE SEE SHEET 12
-L- STA 128+00

MATCHLINE SEE SHEET 14
-L- STA 141+00

REVISIONS

8/17/99

PROF CONC. SURFVAIK
 ** A DESIGN EXCEPTION FOR LANE WIDTH IS
 REQUIRED FOR -L- STA. 139+95.56 TO -L- 139+95.56

P-60

**PERMIT DRAWING
SHEET 12 OF 18**

REVISED: 2/6/2018

PROJECT REFERENCE NO.	U-4405	SHEET NO.	14
ROADWAY DESIGN ENGINEER	HYDRAULICS ENGINEER		
INCOMPLETE PLANS DO NOT USE FOR CONSTRUCTION			



<p>PI Sta 144+71.01 $\Delta = 19'18" 58.8"$ (RT) $D = 271' 30.6"$ $L_s = 150.00'$ $T = 642.45'$ $R = 2500.00'$ $SE = 0.03$</p>	<p>PI Sta 149+38.40 $\Delta = 1'43" 07.9"$ $D = 150.00'$ $L_s = 50.00'$ $T = 425.45'$ $R = 2500.00'$ $SE = 0.03$</p>	<p>PI Sta 153+04.56 $\Delta = 5'10" 21.2"$ (LT) $D = 319' 47.4"$ $L_s = 150.00'$ $T = 155.61'$ $R = 3445.00'$ $SE = 0.03$</p>
--	--	---

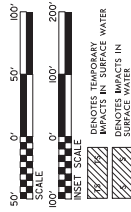
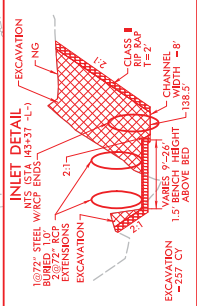
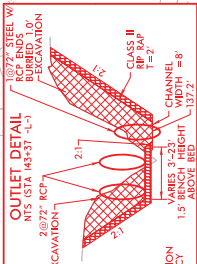
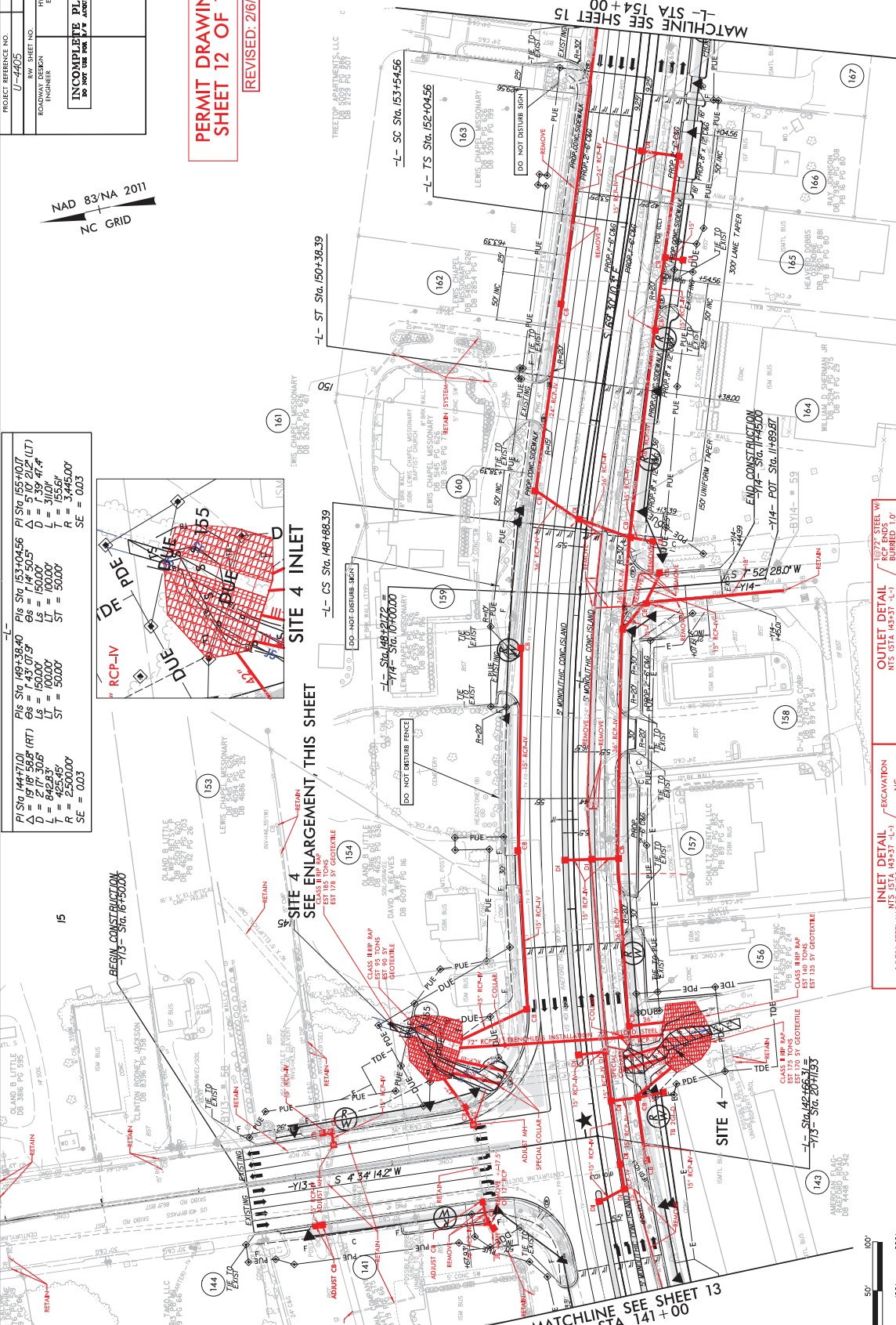
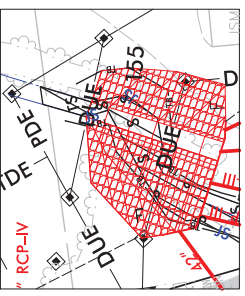

NOTE: SEE SHEET 37 & 38 FOR -L- PROFILE
 SEE SHEET 47 FOR -Y13- PROFILE
 SEE SHEET 48 FOR -Y14- PROFILE

8/17/99

REVISIONS

AMERICAN CLARK DESIGN GROUP, INC. 14105 Hildreth Pk. Raleigh, NC 27615
 PROJECT NO. 14105 Hildreth Pk. Pk. 14.dgn
 DATE: 08/17/99

**PERMIT DRAWING
SHEET 13 OF 18**

REVISED: 2/6/2018

PROJECT REFERENCE NO.	U-4405
SHEET NO.	14
ROADWAY DESIGN ENGINEER	HYDRAULICS ENGINEER
INCOMPLETE PLANS DO NOT BE USED FOR CONSTRUCTION	

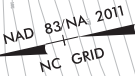

<p>PI Sta 144+71.01 $\Delta = 19'18.585'$ (RT) $D = 2717.306'$ $L_s = 150.00'$ $T = 6425.45'$ $R = 2500.00'$ $SE = 0.03$</p>	<p>PI Sta 149+38.40 $\Delta = 1'43.079'$ $D = 150.00'$ $L_s = 50.00'$ $T = 425.45'$ $R = 3445.00'$ $SE = 0.03$</p>	<p>PI Sta 153+04.56 $\Delta = 5'10.212'$ (LT) $D = 1713.474'$ $L_s = 150.00'$ $T = 1556'$ $R = 3445.00'$ $SE = 0.03$</p>
--	--	--

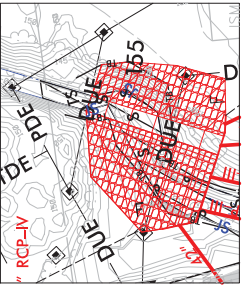

SITE 4 INLET

SITE 4 SEE ENLARGEMENT, THIS SHEET

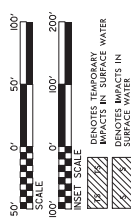
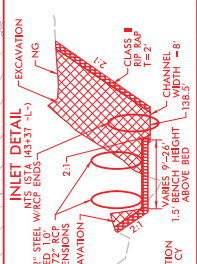
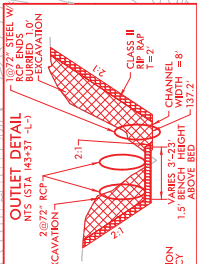
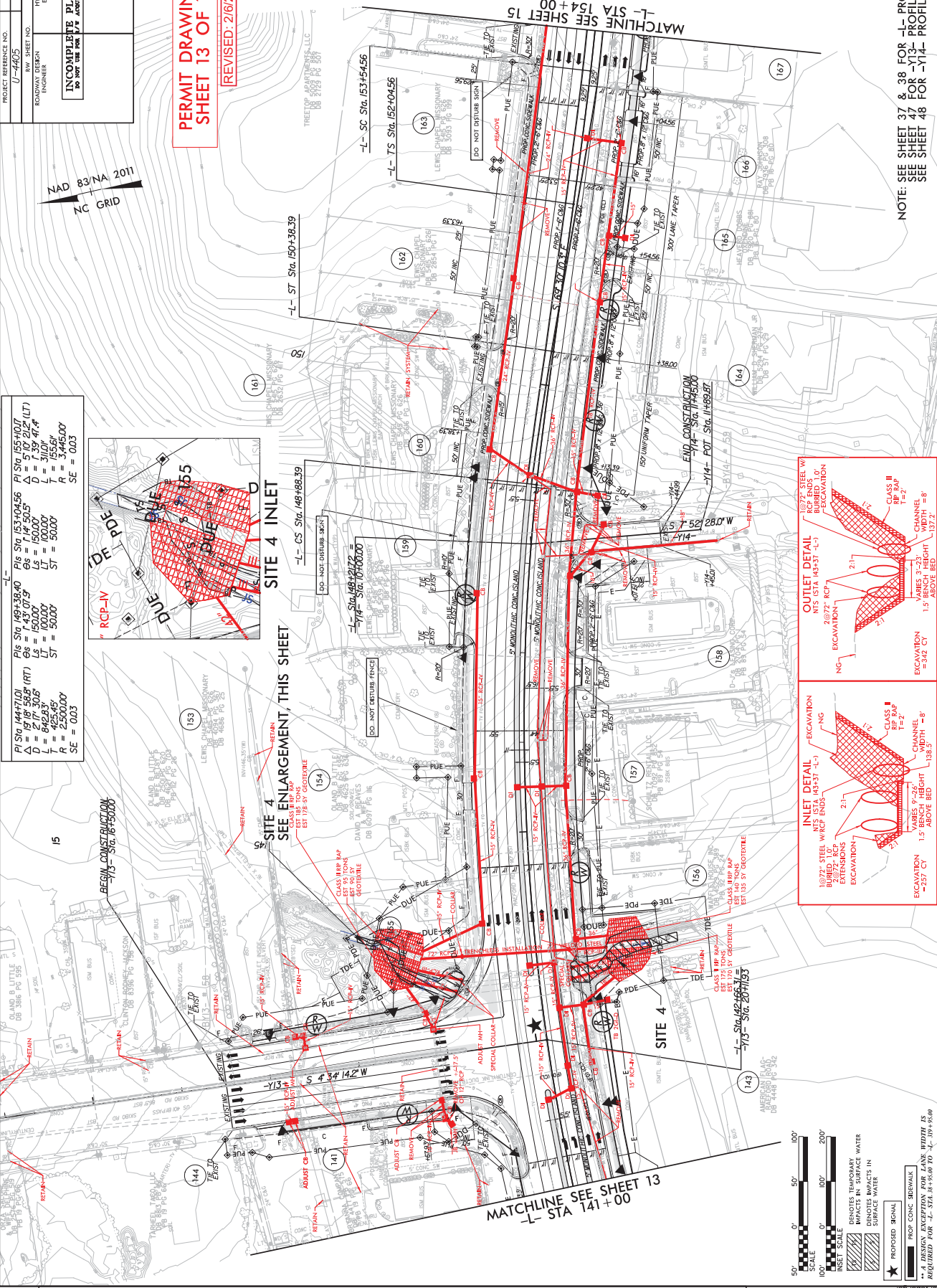

- PROPOSED BENCHMARK
- PROF CONC BIRKAWALK
- DENOTES TEMPORARY BIRKAWALK
- DENOTES IMPACTS IN SURFACE WATER

NOTE: SEE SHEET 37 & 38 FOR -1- PROFILE
 SEE SHEET 47 FOR -Y13- PROFILE
 SEE SHEET 48 FOR -Y14-

PROJECT REFERENCE NO. U-4405
 SHEET NO. 20
 HYDRAULICS ENGINEER
 ROADWAY DESIGN ENGINEER
INCOMPLETE PLANS
 DO NOT CONSIDER FOR CONSTRUCTION

PERMIT DRAWING
SHEET 15 OF 18
 REVISED: 2/16/2018

P-63

NAD 83/NA 2011
 NC GRID

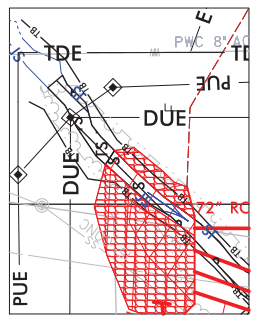

SITE 5 INLET

SITE 5
 SEE ENLARGEMENT, THIS SHEET

PI STA 220+47.31
 $\Delta = 1.04$ 319' (LT)
 $D = 0.34$ 225'
 $L = 187.7'$
 $P = 0.158$
 $SE = NC$

PC STA 219+73.45
 PT STA 221+56.17

MATCHLINE SEE SHEET 19
 L- STA 218 + 50

MATCHLINE SEE SHEET 21
 L- STA 231 + 50

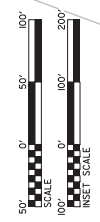
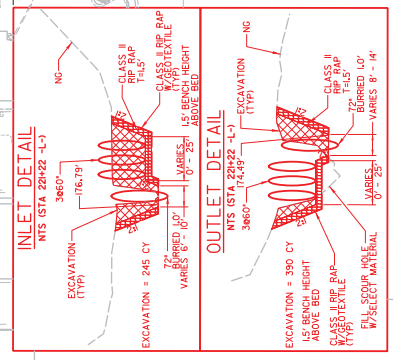
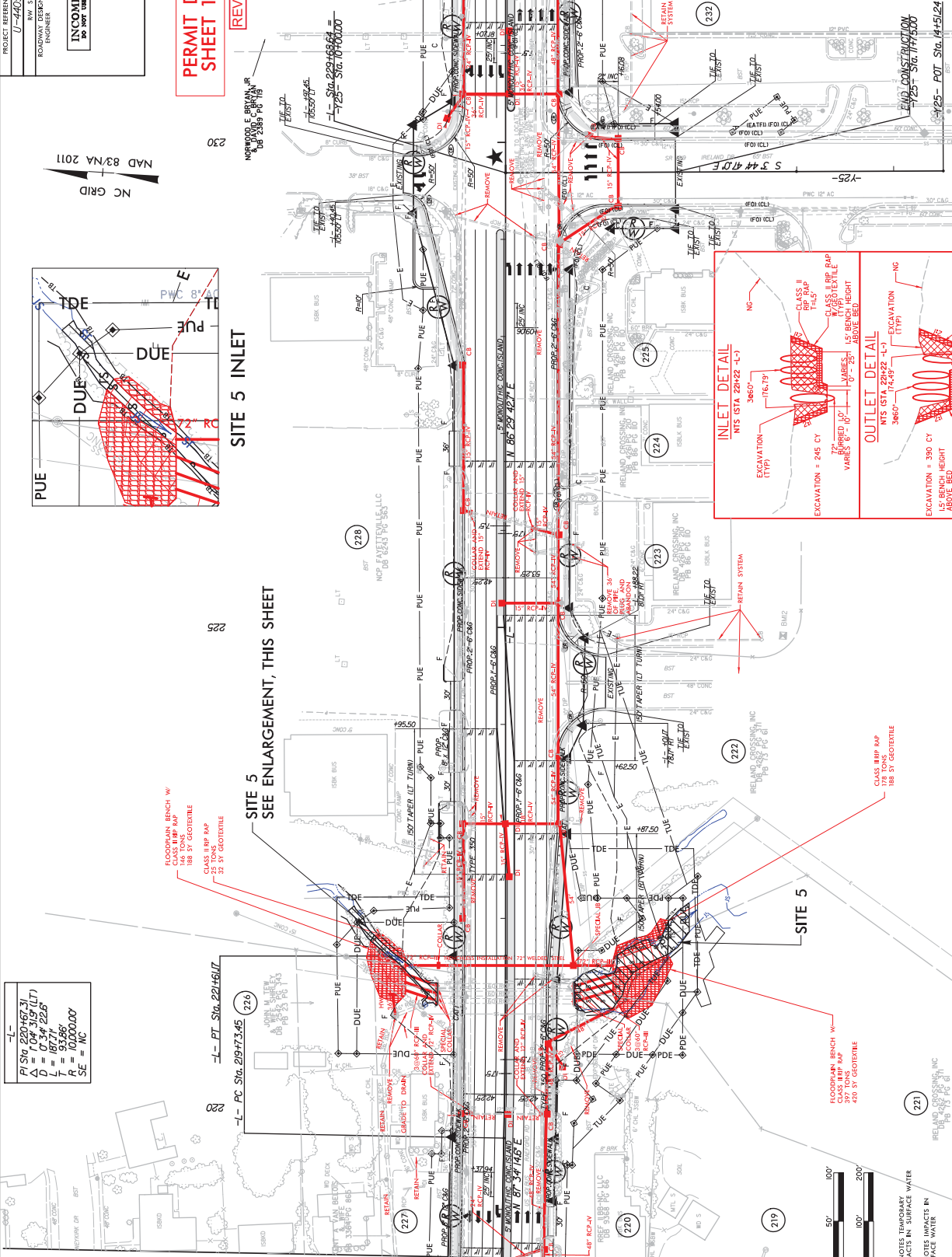

0' 50' 100' 200' 300'
 SCALE
 INSET SCALE
 DENOTES TEMPORARY IMPACTS IN SURFACE WATER
 DENOTES IMPACTS IN SURFACE WATER
 PROPOSED SIGNAL
 PROF CONIC SIDEWALK
 ** A DESIGN EXCEPTION FOR LANE WIDTH IS REQUIRED FOR L- STA. 218+50 TO L- 219+50

NOTE: SEE SHEET 40 FOR L- PROFILE
 SEE SHEET 48 FOR Y-25- PROFILE

PROJECT REFERENCE NO. U-4405
 SHEET NO. 20
 HYDRAULICS ENGINEER
 ROADWAY DESIGN ENGINEER
INCOMPLETE PLANS
 DO NOT CONSIDER FOR CONSTRUCTION

PERMIT DRAWING
SHEET 16 OF 18
 REVISED: 2/16/2018

P-64

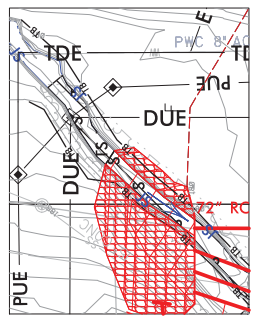
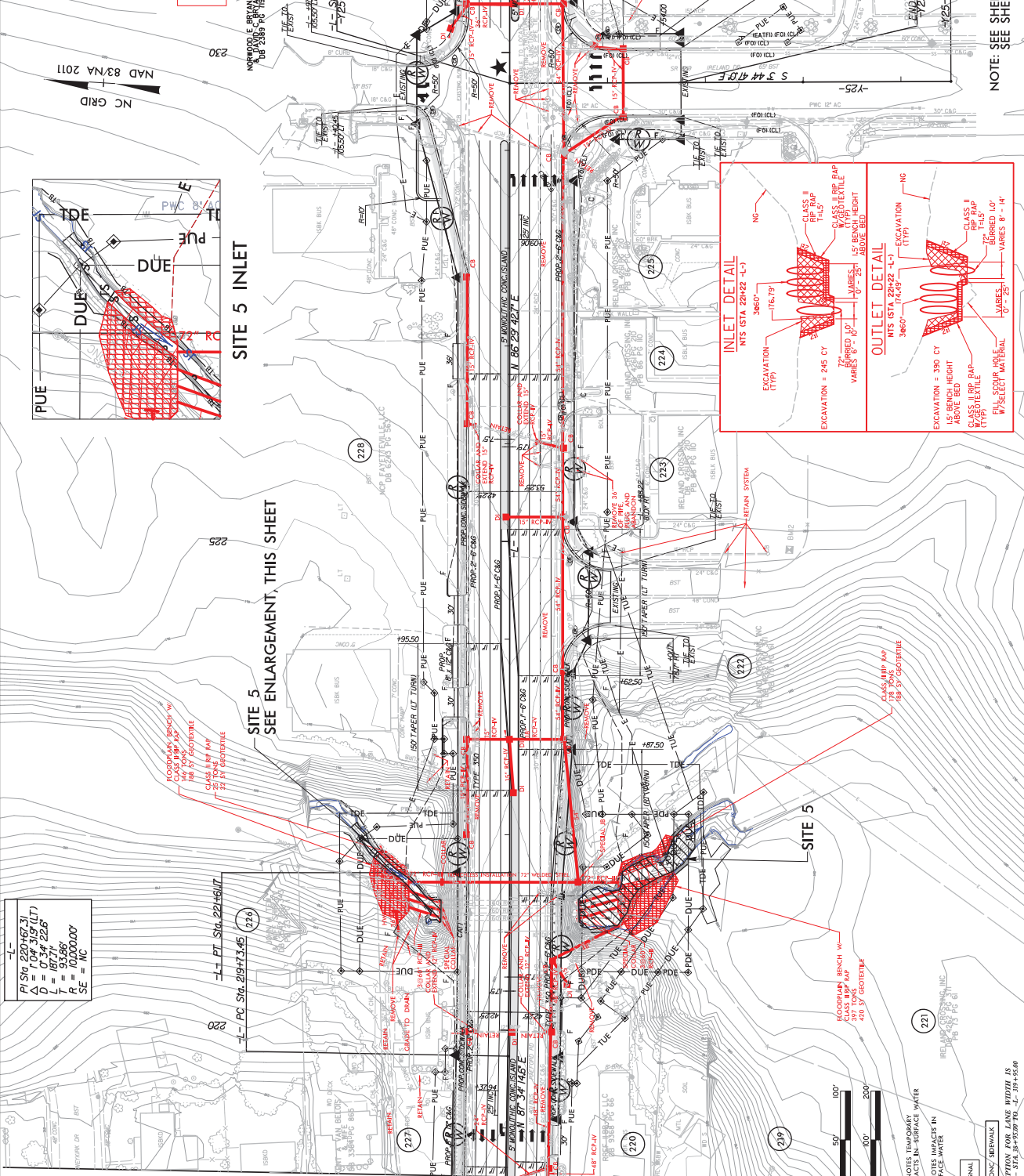

SITE 5 INLET

SITE 5
 SEE ENLARGEMENT, THIS SHEET

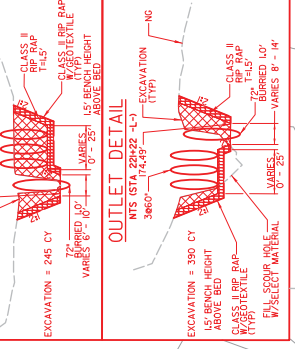

INLET DETAIL

OUTLET DETAIL

PI STA 220+427.31
 $\Delta = 0.34$
 $D = 0.34$
 $L = 187.71$
 $P = 0.158$
 $SE = NC$

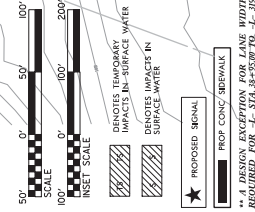

PROPOSED SIGNAL
 PROP CONC SIDEWALK
 DESIGN EXCEPTION FOR LANE WIDTH

DIAGONAL HATCHING DENOTES IMPACTS IN SURFACE WATER
 HORIZONTAL HATCHING DENOTES IMPACTS IN SURFACE WATER

** A DESIGN EXCEPTION FOR LANE WIDTH IS REQUIRED FOR L-STA 218+50 TO L-STA 220+50

NOTE: SEE SHEET 40 FOR L-PROFILE
 SEE SHEET 48 FOR Y-25-PROFILE

MATCHLINE SEE SHEET 19
 L- STA 218 + 50

MATCHLINE SEE SHEET 21
 L- STA 231 + 50

8/17/99

REVISIONS

\\fs1\p\m\psh\20\condgn\4405\hd\p\m\psh\20\condgn\p\m\psh\20\condgn\p\m\psh\20\condgn

PERMIT DRAWING
SHEET 17 OF 18

P-65

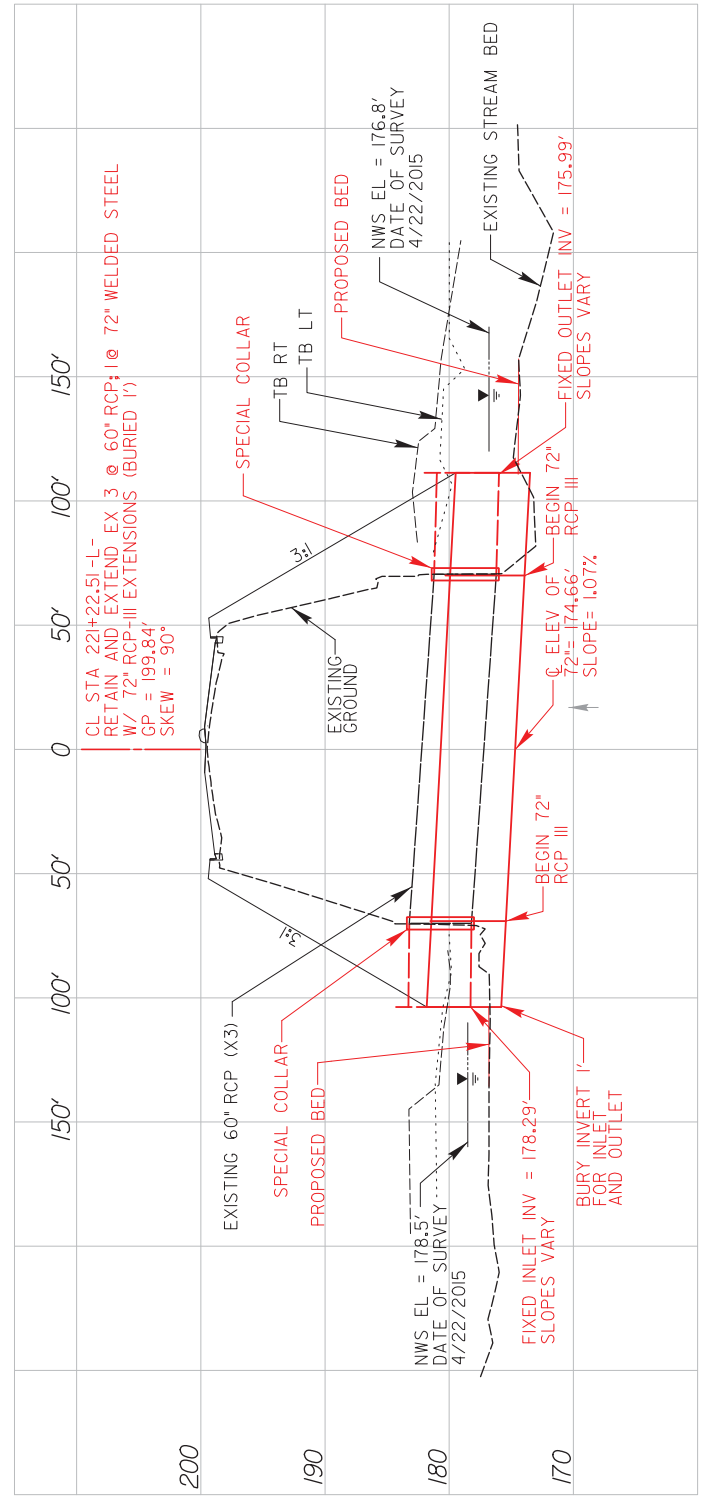

T.I.P. NO.
U-4405

SHEET NO.
UE-1

STATE OF NORTH CAROLINA DIVISION OF HIGHWAYS

NEU PERMIT PLANS CUMBERLAND COUNTY

LOCATION: US 401 FROM WEST OF HAMPTON OAKS DRIVE TO
EAST OF FAIRWAY DRIVE IN FAYETTEVILLE
TYPE OF WORK: RELOCATION OF WATER, SEWER, TELEPHONE,
CABLE, GAS, POWER

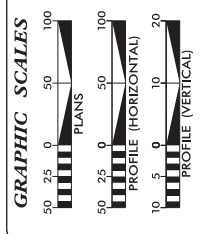
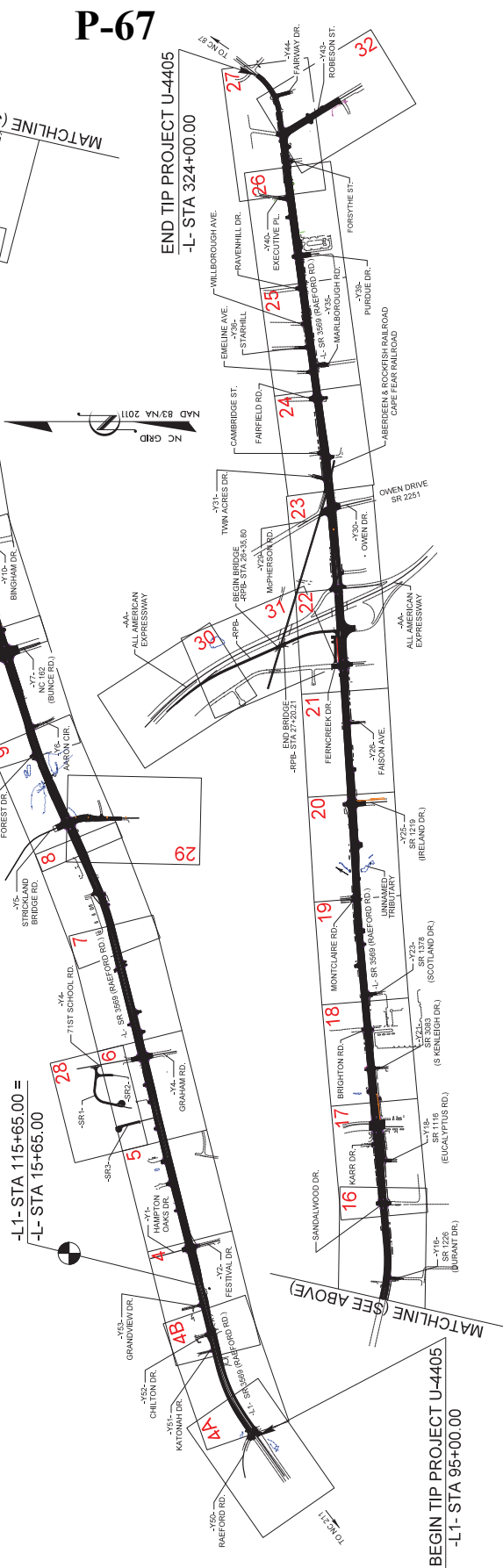
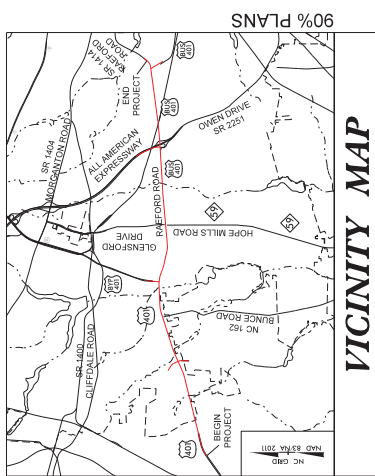

INDEX OF SHEETS

SHEET NO.	DESCRIPTION:
UE-1	NEU PERMIT TITLE SHEET
UE-2	UE PLAN SHEET

- UTILITY OWNERS WITH CONFLICTS
- (A) WATER - PHC WATER AND SEWER
 - (B) SEWER - PHC WATER AND SEWER
 - (C) POWER - PHC WATER AND SEWER
 - (D) TELEPHONE - CENTURYLINK
 - (E) CABLE - SPECTRUM
 - (F) POWER - PHC POWER
 - (G) GAS - PIEDMONT NATURAL GAS
 - (H) WATER - AQUA INC.

PRELIMINARY PLANS
DO NOT USE FOR CONSTRUCTION

DIVISION OF HIGHWAYS
UTILITIES UNIT
CENTRAL OFFICE
1000 WEST GATEWAY CENTER
RALEIGH, NC 27603-4335
PHONE (919) 733-4000
FAX (919) 733-4142

BO JEMPHILL, P.E. UTILITIES REGIONAL ENGINEER
KELLYN MARTIN UTILITIES ENGINEER
KYLE PLEASANT UTILITIES AREA COORDINATOR
LARRY JAMES, JR. UTILITIES COORDINATOR

P-67

TIP PROJECT: U-4405

UTILITIES BY OTHERS

NOTE:
 ALL UTILITY WORK SHOWN ON THIS SHEET WILL BE DONE BY OTHERS. NO PAYMENT WILL BE MADE TO THE CONTRACTOR FOR UTILITY WORK SHOWN ON THIS SHEET.

UE-2 CORRESPONDS TO R0Y 9

P-68

MATCHLINE SEE SHEET 10
 -L- STA 88+00

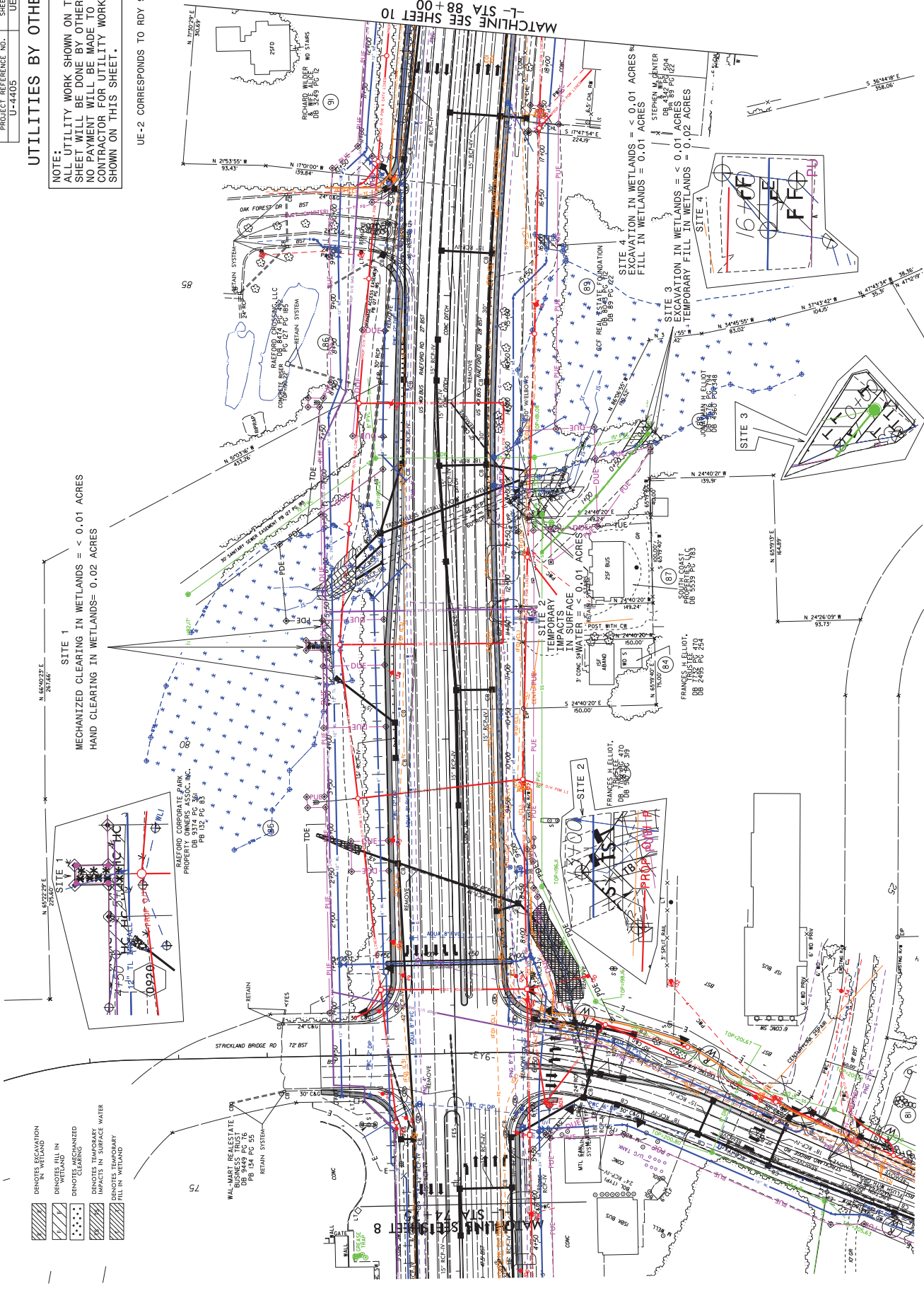

- DENOTES EXCAVATION
- DENOTES FILL IN WETLAND
- DENOTES MECHANIZED CLEARING
- DENOTES TEMPORARY IMPACTS IN SURFACE WATER
- DENOTES TEMPORARY FILL IN WETLAND

PROJECT REFERENCE NO. U-4405 SHEET NO. UE-5

UTILITIES BY OTHERS

NOTE: ALL UTILITY WORK SHOWN ON THIS SHEET WILL BE DONE BY OTHERS. NO PAYMENT WILL BE MADE TO THE CONTRACTOR FOR UTILITY WORK SHOWN ON THIS SHEET.

DENOTES TEMPORARY IMPACTS IN SURFACE WATER

SITE 5 TEMPORARY IMPACTS IN SURFACE WATER = <.01 ACRES; = 7.3 LF

SITE 6 TEMPORARY IMPACTS IN SURFACE WATER = .02 ACRES; = 22 LF

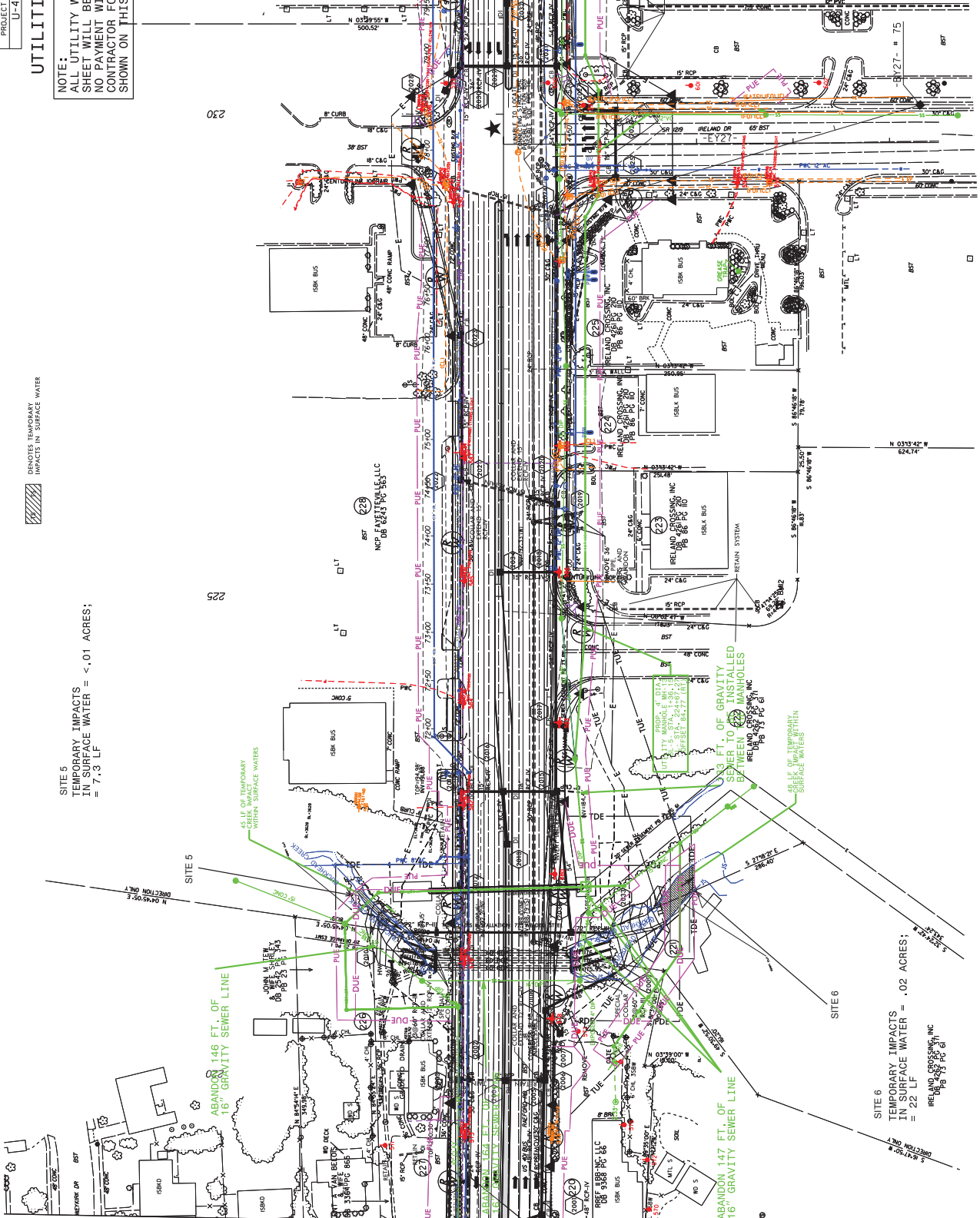

MATCHLINE SEE SHEET 19 -L- STA 218 + 50

MATCHLINE SEE SHEET 21 -L- STA 231 + 50

County : Cumberland

Line #	Item Number	Sec #	Description	Quantity	Unit Cost	Amount
ROADWAY ITEMS						
0001	0000100000-N	800	MOBILIZATION	Lump Sum	L.S.	
0002	0000400000-N	801	CONSTRUCTION SURVEYING	Lump Sum	L.S.	
0003	0001000000-E	200	CLEARING & GRUBBING .. ACRE(S)	Lump Sum	L.S.	
0004	0008000000-E	200	SUPPLEMENTARY CLEARING & GRUB- BING	1 ACR		
0005	0022000000-E	225	UNCLASSIFIED EXCAVATION	3,300 CY		
0006	0036000000-E	225	UNDERCUT EXCAVATION	1,100 CY		
0007	0106000000-E	230	BORROW EXCAVATION	53,300 CY		
0008	0134000000-E	240	DRAINAGE DITCH EXCAVATION	890 CY		
0009	0156000000-E	250	REMOVAL OF EXISTING ASPHALT PAVEMENT	2,730 SY		
0010	0195000000-E	265	SELECT GRANULAR MATERIAL	1,200 CY		
0011	0196000000-E	270	GEOTEXTILE FOR SOIL STABILIZA- TION	8,700 SY		
0012	0199000000-E	SP	TEMPORARY SHORING	1,272 SF		
0013	0255000000-E	SP	GENERIC GRADING ITEM HAULING AND DISPOSAL OF PETRO- LEUM CONTAMINATED SOIL	100 TON		
0014	0318000000-E	300	FOUNDATION CONDITIONING MATE- RIAL, MINOR STRUCTURES	3,822 TON		
0015	0320000000-E	300	FOUNDATION CONDITIONING GEO- TEXTILE	13,382 SY		
0016	0335000000-E	305	*** DRAINAGE PIPE (54")	268 LF		
0017	0335000000-E	305	*** DRAINAGE PIPE (66")	52 LF		
0018	0335100000-E	305	12" DRAINAGE PIPE	52 LF		

County : Cumberland

Line #	Item Number	Sec #	Description	Quantity	Unit Cost	Amount
0019	0335200000-E	305	15" DRAINAGE PIPE	1,076	LF	
0020	0335300000-E	305	18" DRAINAGE PIPE	636	LF	
0021	0335400000-E	305	24" DRAINAGE PIPE	140	LF	
0022	0335500000-E	305	30" DRAINAGE PIPE	604	LF	
0023	0335600000-E	305	36" DRAINAGE PIPE	60	LF	
0024	0335700000-E	305	42" DRAINAGE PIPE	768	LF	
0025	0335800000-E	305	48" DRAINAGE PIPE	572	LF	
0026	0335850000-E	305	*** DRAINAGE PIPE ELBOWS (12")	2	EA	
0027	0335850000-E	305	*** DRAINAGE PIPE ELBOWS (30")	4	EA	
0028	0343000000-E	310	15" SIDE DRAIN PIPE	60	LF	
0029	0354000000-E	310	**** RC PIPE CULVERTS, CLASS ***** (66", V)	100	LF	
0030	0402000000-E	310	48" RC PIPE CULVERTS, CLASS III	20	LF	
0031	0414000000-E	310	60" RC PIPE CULVERTS, CLASS III	44	LF	
0032	0420000000-E	310	66" RC PIPE CULVERTS, CLASS III	48	LF	
0033	0426000000-E	310	72" RC PIPE CULVERTS, CLASS III	40	LF	
0034	0448000000-E	310	***** RC PIPE CULVERTS, CLASS IV (48")	652	LF	
0035	0448000000-E	310	***** RC PIPE CULVERTS, CLASS IV (54")	1,024	LF	
0036	0448200000-E	310	15" RC PIPE CULVERTS, CLASS IV	7,384	LF	

County : Cumberland

Line #	Item Number	Sec #	Description	Quantity	Unit Cost	Amount
0037	0448300000-E	310	18" RC PIPE CULVERTS, CLASS IV	1,416 LF		
0038	0448400000-E	310	24" RC PIPE CULVERTS, CLASS IV	1,964 LF		
0039	0448500000-E	310	30" RC PIPE CULVERTS, CLASS IV	1,132 LF		
0040	0448600000-E	310	36" RC PIPE CULVERTS, CLASS IV	1,648 LF		
0041	0448700000-E	310	42" RC PIPE CULVERTS, CLASS IV	1,240 LF		
0042	0973100000-E	330	*** WELDED STEEL PIPE, ***** THICK, GRADE B IN SOIL (72", 1.000")	84 LF		
0043	0973300000-E	330	*** WELDED STEEL PIPE, ***** THICK, GRADE B NOT IN SOIL (72", 1.000")	84 LF		
0044	0986000000-E	SP	GENERIC PIPE ITEM 4" PVC SLEEVE	950 LF		
0045	0995000000-E	340	PIPE REMOVAL	8,542 LF		
0046	1011000000-N	500	FINE GRADING	Lump Sum	L.S.	
0047	1099500000-E	505	SHALLOW UNDERCUT	1,300 CY		
0048	1099700000-E	505	CLASS IV SUBGRADE STABILIZA- TION	3,850 TON		
0049	1220000000-E	545	INCIDENTAL STONE BASE	1,500 TON		
0050	1297000000-E	607	MILLING ASPHALT PAVEMENT, ***** DEPTH (1-1/2")	16,490 SY		
0051	1330000000-E	607	INCIDENTAL MILLING	5,000 SY		
0052	1491000000-E	610	ASPHALT CONC BASE COURSE, TYPE B25.0C	17,990 TON		
0053	1503000000-E	610	ASPHALT CONC INTERMEDIATE COURSE, TYPE I19.0C	18,360 TON		
0054	1519000000-E	610	ASPHALT CONC SURFACE COURSE, TYPE S9.5B	2,140 TON		

County : Cumberland

Line #	Item Number	Sec #	Description	Quantity	Unit Cost	Amount
0055	1523000000-E	610	ASPHALT CONC SURFACE COURSE, TYPE S9.5C	17,590 TON		
0056	1575000000-E	620	ASPHALT BINDER FOR PLANT MIX	2,895 TON		
0057	1693000000-E	654	ASPHALT PLANT MIX, PAVEMENT REPAIR	1,242 TON		
0058	2022000000-E	815	SUBDRAIN EXCAVATION	45 CY		
0059	2026000000-E	815	GEOTEXTILE FOR SUBSURFACE DRAINS	200 SY		
0060	2036000000-E	815	SUBDRAIN COARSE AGGREGATE	34 CY		
0061	2044000000-E	815	6" PERFORATED SUBDRAIN PIPE	200 LF		
0062	2070000000-N	815	SUBDRAIN PIPE OUTLET	1 EA		
0063	2077000000-E	815	6" OUTLET PIPE	6 LF		
0064	2209000000-E	838	ENDWALLS	11.7 CY		
0065	2220000000-E	838	REINFORCED ENDWALLS	207.5 CY		
0066	2253000000-E	840	PIPE COLLARS	24.72 CY		
0067	2264000000-E	840	PIPE PLUGS	3.75 CY		
0068	2275000000-E	SP	FLOWABLE FILL	64 CY		
0069	2286000000-N	840	MASONRY DRAINAGE STRUCTURES	213 EA		
0070	2297000000-E	840	MASONRY DRAINAGE STRUCTURES	57.233 CY		
0071	2308000000-E	840	MASONRY DRAINAGE STRUCTURES	155.6 LF		
0072	2352000000-N	840	FRAME WITH GRATE, STD 840.**** (840.16)	81 EA		
0073	2366000000-N	840	FRAME WITH TWO GRATES, STD 840.24	5 EA		

County : Cumberland

Line #	Item Number	Sec #	Description	Quantity	Unit Cost	Amount
0074	2367000000-N	840	FRAME WITH TWO GRATES, STD 840.29	8 EA		
0075	2374000000-N	840	FRAME WITH GRATE & HOOD, STD 840.03, TYPE ** (E)	14 EA		
0076	2374000000-N	840	FRAME WITH GRATE & HOOD, STD 840.03, TYPE ** (F)	53 EA		
0077	2374000000-N	840	FRAME WITH GRATE & HOOD, STD 840.03, TYPE ** (G)	47 EA		
0078	2396000000-N	840	FRAME WITH COVER, STD 840.54	16 EA		
0079	2451000000-N	852	CONCRETE TRANSITIONAL SECTION FOR DROP INLET	36 EA		
0080	2535000000-E	846	***X *** CONCRETE CURB (8" X 12")	110 LF		
0081	2542000000-E	846	1'-6" CONCRETE CURB & GUTTER	9,270 LF		
0082	2549000000-E	846	2'-6" CONCRETE CURB & GUTTER	22,690 LF		
0083	2591000000-E	848	4" CONCRETE SIDEWALK	10,505 SY		
0084	2605000000-N	848	CONCRETE CURB RAMPS	89 EA		
0085	2612000000-E	848	6" CONCRETE DRIVEWAY	1,209 SY		
0086	2655000000-E	852	5" MONOLITHIC CONCRETE ISLANDS (KEYED IN)	2,500 SY		
0087	2800000000-N	858	ADJUSTMENT OF CATCH BASINS	3 EA		
0088	2815000000-N	858	ADJUSTMENT OF DROP INLETS	1 EA		
0089	2845000000-N	858	ADJUSTMENT OF METER BOXES OR VALVE BOXES	30 EA		
0090	2860000000-N	859	CONVERT EXISTING CATCH BASIN TO JUNCTION BOX	1 EA		
0091	3030000000-E	862	STEEL BEAM GUARDRAIL	1,125 LF		

County : Cumberland

Line #	Item Number	Sec #	Description	Quantity	Unit Cost	Amount
0092	3150000000-N	862	ADDITIONAL GUARDRAIL POSTS	5 EA		
0093	3210000000-N	862	GUARDRAIL END UNITS, TYPE CAT-1	4 EA		
0094	3287000000-N	SP	GUARDRAIL END UNITS, TYPE TL-3	4 EA		
0095	3628000000-E	876	RIP RAP, CLASS I	300 TON		
0096	3635000000-E	876	RIP RAP, CLASS II	620 TON		
0097	3649000000-E	876	RIP RAP, CLASS B	60 TON		
0098	3656000000-E	876	GEOTEXTILE FOR DRAINAGE	1,850 SY		
0099	4072000000-E	903	SUPPORTS, 3-LB STEEL U-CHANNEL	2,746 LF		
0100	4096000000-N	904	SIGN ERECTION, TYPE D	4 EA		
0101	4102000000-N	904	SIGN ERECTION, TYPE E	171 EA		
0102	4108000000-N	904	SIGN ERECTION, TYPE F	11 EA		
0103	4116100000-N	904	SIGN ERECTION, RELOCATE TYPE **** (GROUND MOUNTED) (D)	24 EA		
0104	4155000000-N	907	DISPOSAL OF SIGN SYSTEM, U- CHANNEL	139 EA		
0105	4192000000-N	907	DISPOSAL OF SUPPORT, U-CHANNEL	24 EA		
0106	4400000000-E	1110	WORK ZONE SIGNS (STATIONARY)	480 SF		
0107	4405000000-E	1110	WORK ZONE SIGNS (PORTABLE)	480 SF		
0108	4410000000-E	1110	WORK ZONE SIGNS (BARRICADE MOUNTED)	36 SF		
0109	4415000000-N	1115	FLASHING ARROW BOARD	2 EA		
0110	4420000000-N	1120	PORTABLE CHANGEABLE MESSAGE SIGN	4 EA		

County : Cumberland

Line #	Item Number	Sec #	Description	Quantity	Unit Cost	Amount
0111	4430000000-N	1130	DRUMS	175 EA		
0112	4435000000-N	1135	CONES	100 EA		
0113	4445000000-E	1145	BARRICADES (TYPE III)	32 LF		
0114	4447000000-E	SP	PEDESTRIAN CHANNELIZING DEVICES	64 LF		
0115	4455000000-N	1150	FLAGGER	100 DAY		
0116	4480000000-N	1165	TMA	2 EA		
0117	4510000000-N	1190	LAW ENFORCEMENT	500 HR		
0118	4516000000-N	1180	SKINNY DRUM	75 EA		
0119	4685000000-E	1205	THERMOPLASTIC PAVEMENT MARKING LINES (4", 90 MILS)	37,899 LF		
0120	4695000000-E	1205	THERMOPLASTIC PAVEMENT MARKING LINES (8", 90 MILS)	10,250 LF		
0121	4720000000-E	1205	THERMOPLASTIC PAVEMENT MARKING CHARACTER (90 MILS)	90 EA		
0122	4725000000-E	1205	THERMOPLASTIC PAVEMENT MARKING SYMBOL (90 MILS)	179 EA		
0123	4810000000-E	1205	PAINT PAVEMENT MARKING LINES (4")	625 LF		
0124	4891000000-E	1205	GENERIC PAVEMENT MARKING ITEM THERMOPLASTIC PAVEMENT MARKING LINES (24", 90 MILS)	2,140 LF		
0125	4900000000-N	1251	PERMANENT RAISED PAVEMENT MARKERS	1,691 EA		
0126	5255000000-N	1413	PORTABLE LIGHTING	Lump Sum	L.S.	
0128	5325600000-E	1510	6" WATER LINE	858 LF		
0129	5325800000-E	1510	8" WATER LINE	292 LF		

County : Cumberland

Line #	Item Number	Sec #	Description	Quantity	Unit Cost	Amount
0130	5326200000-E	1510	12" WATER LINE	4,094	LF	
0131	5326600000-E	1510	16" WATER LINE	880	LF	
0132	5327400000-E	1510	24" WATER LINE	6,416	LF	
0133	5329000000-E	1510	DUCTILE IRON WATER PIPE FITTINGS	98,466	LB	
0134	5540000000-E	1515	6" VALVE	21	EA	
0135	5546000000-E	1515	8" VALVE	4	EA	
0136	5558000000-E	1515	12" VALVE	8	EA	
0137	5558600000-E	1515	16" VALVE	2	EA	
0138	5559400000-E	1515	24" VALVE	11	EA	
0139	5571800000-E	1515	8" TAPPING SLEEVE & VALVE	1	EA	
0140	5572200000-E	1515	12" TAPPING SLEEVE & VALVE	2	EA	
0141	5573400000-E	1515	24" TAPPING SLEEVE & VALVE	5	EA	
0143	5643150000-E	1515	1-1/2" WATER METER	6	EA	
0144	5648000000-N	1515	RELOCATE WATER METER	9	EA	
0145	5649000000-N	1515	RECONNECT WATER METER	1	EA	
0146	5656000000-E	1515	*** RPZ BACKFLOW PREVENTION ASSEMBLY (1-1/2")	6	EA	
0147	5666000000-N	1515	FIRE HYDRANT	20	EA	
0148	5672000000-N	1515	RELOCATE FIRE HYDRANT	1	EA	
0149	5673000000-E	1515	FIRE HYDRANT LEG	280	LF	
0150	5686000000-E	1515	*** WATER SERVICE LINE (2")	627	LF	

County : Cumberland

Line #	Item Number	Sec #	Description	Quantity	Unit Cost	Amount
0151	5686500000-E	1515	WATER SERVICE LINE	157		LF
0152	5691300000-E	1520	8" SANITARY GRAVITY SEWER	179		LF
0153	5768000000-N	1520	SANITARY SEWER CLEAN-OUT	1		EA
0154	5768500000-E	1520	SEWER SERVICE LINE	26		LF
0155	5775000000-E	1525	4' DIA UTILITY MANHOLE	2		EA
0156	5781000000-E	1525	UTILITY MANHOLE WALL 4' DIA	8		LF
0157	5801000000-E	1530	ABANDON 8" UTILITY PIPE	119		LF
0158	5813000000-E	1530	ABANDON 24" UTILITY PIPE	5,798		LF
0159	5815500000-N	1530	REMOVE FIRE HYDRANT	4		EA
0160	5816000000-N	1530	ABANDON UTILITY MANHOLE	1		EA
0161	5828000000-N	1530	REMOVE UTILITY MANHOLE	1		EA
0162	5836000000-E	1540	24" ENCASEMENT PIPE	325		LF
0163	5836400000-E	1540	36" ENCASEMENT PIPE	321		LF
0164	5872500000-E	1550	BORE AND JACK OF *** (24")	325		LF
0165	5872500000-E	1550	BORE AND JACK OF *** (36")	321		LF
0166	5872600000-E	1550	DIRECTIONAL DRILLING OF *** (16")	368		LF
0167	5882000000-N	SP	GENERIC UTILITY ITEM 16" NITRILE PIPE GASKET	3		EA
0168	5882000000-N	SP	GENERIC UTILITY ITEM 2" COMBINATION AIR RELEASE VALVE	1		EA
0169	5882000000-N	SP	GENERIC UTILITY ITEM 24" NITRILE PIPE GASKET	20		EA

County : Cumberland

Line #	Item Number	Sec #	Description	Quantity	Unit Cost	Amount
0170	5882000000-N	SP	GENERIC UTILITY ITEM ADJUSTMENT OF BRICK AND MORTAR MANHOLES	2 EA		
0171	5882000000-N	SP	GENERIC UTILITY ITEM ADJUSTMENT OF PRECAST MANHOLES	5 EA		
0172	5888000000-E	SP	GENERIC UTILITY ITEM MAJOR DRAINAGE STRUCTURES AND BRICK AND MORTAR MANHOLES	3.5 LF		
0173	5888000000-E	SP	GENERIC UTILITY ITEM MAJOR DRAINAGE STRUCTURES AND PRECAST MANHOLES	2 LF		
0174	5888000000-E	SP	GENERIC UTILITY ITEM POLYETHYLENE ENCASEMENT ON 16" DIA MAIN	101 LF		
0175	5888000000-E	SP	GENERIC UTILITY ITEM POLYETHYLENE ENCASEMENT ON 24" DIA MAIN	340 LF		
0176	6000000000-E	1605	TEMPORARY SILT FENCE	14,000 LF		
0177	6006000000-E	1610	STONE FOR EROSION CONTROL, CLASS A	630 TON		
0178	6009000000-E	1610	STONE FOR EROSION CONTROL, CLASS B	905 TON		
0179	6012000000-E	1610	SEDIMENT CONTROL STONE	2,520 TON		
0180	6015000000-E	1615	TEMPORARY MULCHING	60 ACR		
0181	6018000000-E	1620	SEED FOR TEMPORARY SEEDING	1,100 LB		
0182	6021000000-E	1620	FERTILIZER FOR TEMPORARY SEED- ING	6.5 TON		
0183	6024000000-E	1622	TEMPORARY SLOPE DRAINS	885 LF		
0184	6029000000-E	SP	SAFETY FENCE	800 LF		
0185	6030000000-E	1630	SILT EXCAVATION	1,500 CY		
0186	6036000000-E	1631	MATTING FOR EROSION CONTROL	60,000 SY		

County : Cumberland

Line #	Item Number	Sec #	Description	Quantity	Unit Cost	Amount
0187	6037000000-E	SP	COIR FIBER MAT	100 SY		
0188	6038000000-E	SP	PERMANENT SOIL REINFORCEMENT MAT	125 SY		
0189	6042000000-E	1632	1/4" HARDWARE CLOTH	8,750 LF		
0190	6043000000-E	SP	LOW PERMEABILITY GEOTEXTILE	20 SY		
0191	6070000000-N	1639	SPECIAL STILLING BASINS	6 EA		
0192	6071012000-E	SP	COIR FIBER WATTLE	4,100 LF		
0193	6071020000-E	SP	POLYACRYLAMIDE (PAM)	1,100 LB		
0194	6071030000-E	1640	COIR FIBER BAFFLE	450 LF		
0195	6071050000-E	SP	*** SKIMMER (1-1/2")	1 EA		
0196	6084000000-E	1660	SEEDING & MULCHING	18 ACR		
0197	6087000000-E	1660	MOWING	9 ACR		
0198	6090000000-E	1661	SEED FOR REPAIR SEEDING	200 LB		
0199	6093000000-E	1661	FERTILIZER FOR REPAIR SEEDING	0.75 TON		
0200	6096000000-E	1662	SEED FOR SUPPLEMENTAL SEEDING	450 LB		
0201	6108000000-E	1665	FERTILIZER TOPDRESSING	13 TON		
0202	6111000000-E	SP	IMPERVIOUS DIKE	455 LF		
0203	6114500000-N	1667	SPECIALIZED HAND MOWING	10 MHR		
0204	6117000000-N	SP	RESPONSE FOR EROSION CONTROL	25 EA		
0205	6117500000-N	SP	CONCRETE WASHOUT STRUCTURE	4 EA		
0206	6120000000-E	SP	CULVERT DIVERSION CHANNEL	61 CY		

County : Cumberland

Line #	Item Number	Sec #	Description	Quantity	Unit Cost	Amount
0207	6132000000-N	SP	GENERIC EROSION CONTROL ITEM FABRIC INSERT INLET PROTECTION DEVICE CLEANOUT	75 EA		
0208	6132000000-N	SP	GENERIC EROSION CONTROL ITEM FABRIC INSERT INLET PROTECTION DEVICE	25 EA		
0209	6147000000-E	SP	GENERIC EROSION CONTROL ITEM TREE PROTECTION FENCE	1,700 LF		
0210	7048500000-E	1705	PEDESTRIAN SIGNAL HEAD (16", 1 SECTION W/COUNTDOWN)	32 EA		
0211	7060000000-E	1705	SIGNAL CABLE	39,760 LF		
0212	7120000000-E	1705	VEHICLE SIGNAL HEAD (12", 3 SECTION)	104 EA		
0213	7132000000-E	1705	VEHICLE SIGNAL HEAD (12", 4 SECTION)	12 EA		
0214	7144000000-E	1705	VEHICLE SIGNAL HEAD (12", 5 SECTION)	21 EA		
0215	7180000000-N	1706	BACKPLATE	133 EA		
0216	7252000000-E	1710	MESSENGER CABLE (1/4")	40 LF		
0217	7264000000-E	1710	MESSENGER CABLE (3/8")	6,010 LF		
0218	7288000000-E	1715	PAVED TRENCHING (***** (1, 2"))	50 LF		
0219	7300000000-E	1715	UNPAVED TRENCHING (***** (1, 2"))	4,000 LF		
0220	7300000000-E	1715	UNPAVED TRENCHING (***** (2, 2"))	2,340 LF		
0221	7300000000-E	1715	UNPAVED TRENCHING (***** (3, 2"))	120 LF		
0222	7300000000-E	1715	UNPAVED TRENCHING (***** (4, 2"))	70 LF		
0223	7300100000-E	1715	UNPAVED TRENCHING FOR TEMP- ORARY LEAD-IN	370 LF		

County : Cumberland

Line #	Item Number	Sec #	Description	Quantity	Unit Cost	Amount
0224	7301000000-E	1715	DIRECTIONAL DRILL (***** (1, 2"))	110 LF		
0225	7301000000-E	1715	DIRECTIONAL DRILL (***** (2, 2"))	170 LF		
0226	7324000000-N	1716	JUNCTION BOX (STANDARD SIZE)	59 EA		
0227	7348000000-N	1716	JUNCTION BOX (OVER-SIZED, HEAVY DUTY)	5 EA		
0228	7360000000-N	1720	WOOD POLE	17 EA		
0229	7372000000-N	1721	GUY ASSEMBLY	34 EA		
0230	7396000000-E	1722	1/2" RISER WITH WEATHERHEAD	13 EA		
0231	7408000000-E	1722	1" RISER WITH WEATHERHEAD	8 EA		
0232	7420000000-E	1722	2" RISER WITH WEATHERHEAD	18 EA		
0233	7444000000-E	1725	INDUCTIVE LOOP SAWCUT	10,040 LF		
0234	7456000000-E	1726	LEAD-IN CABLE (***** (14-2))	43,800 LF		
0235	7481000000-N	SP	SITE SURVEY	5 EA		
0236	7481200000-N	SP	LUMINAIRE ARM FOR VIDEO SYSTEM	18 EA		
0237	7481240000-N	SP	CAMERA WITHOUT INTERNAL LOOP EMULATOR PROCESSING UNIT	18 EA		
0238	7481260000-N	SP	EXTERNAL LOOP EMULATOR PROCESSING UNIT	5 EA		
0239	7481280000-N	SP	RELOCATE CAMERA SENSOR UNIT	21 EA		
0241	7528000000-E	1730	DROP CABLE	100 LF		
0242	7540000000-N	1731	SPLICE ENCLOSURE	1 EA		
0243	7552000000-N	1731	INTERCONNECT CENTER	1 EA		

County : Cumberland

Line #	Item Number	Sec #	Description	Quantity	Unit Cost	Amount
0244	7566000000-N	1733	DELINEATOR MARKER	1 EA		
0245	7575160000-E	1734	REMOVE EXISTING COMMUNICATIONS CABLE	100 LF		
0246	7576000000-N	SP	METAL STRAIN SIGNAL POLE	10 EA		
0247	7613000000-N	SP	SOIL TEST	18 EA		
0248	7614100000-E	SP	DRILLED PIER FOUNDATION	108 CY		
0249	7636000000-N	1745	SIGN FOR SIGNALS	23 EA		
0250	7642200000-N	1743	TYPE II PEDESTAL WITH FOUNDATION	28 EA		
0251	7684000000-N	1750	SIGNAL CABINET FOUNDATION	5 EA		
0252	7696000000-N	1751	CONTROLLERS WITH CABINET (*****) (TYPE 2070LX, BASE MOUNTED)	1 EA		
0253	7696000000-N	1751	CONTROLLERS WITH CABINET (*****) (TYPE 2070LX, POLE MOUNTED)	1 EA		
0254	7744000000-N	1751	DETECTOR CARD (TYPE 170)	61 EA		
0255	7901000000-N	1753	CABINET BASE EXTENDER	1 EA		
0256	7960000000-N	SP	METAL POLE FOUNDATION REMOVAL	5 EA		
0257	7972000000-N	SP	METAL POLE REMOVAL	5 EA		
0258	7980000000-N	SP	GENERIC SIGNAL ITEM DIGITAL CCTV CAMERA ASSEMBLY	1 EA		
0259	7980000000-N	SP	GENERIC SIGNAL ITEM DMS ELECTRICAL SERVICE	2 EA		
0260	7980000000-N	SP	GENERIC SIGNAL ITEM DMS STRUCTURE	1 EA		
0261	7980000000-N	SP	GENERIC SIGNAL ITEM DUAL DMS MOUNTED BACK TO BACK	1 EA		

County : Cumberland

Line #	Item Number	Sec #	Description	Quantity	Unit Cost	Amount
0262	7980000000-N	SP	GENERIC SIGNAL ITEM EQUIPMENT CABINET DISCONNECT	1 EA		
0263	7980000000-N	SP	GENERIC SIGNAL ITEM ETHERNET EDGE SWITCH	1 EA		
0264	7980000000-N	SP	GENERIC SIGNAL ITEM SOIL TEST FOR DMS FOUNDATION	1 EA		
0265	7992000000-E	SP	GENERIC SIGNAL ITEM DMS FOUNDATION	15 CY		
0268	5571600000-E	1515	6" TAPPING SLEEVE & VALVE	11 EA		
0269	5804000000-E	1530	ABANDON 12" UTILITY PIPE	434 LF		
0270	7430000000-N	1722	HEAT SHRINK TUBING RETROFIT KIT	5 EA		
0271	7432000000-E	1722	2" RISER WITH HEAT SHRINK TUBING	1 EA		
0272	7541000000-N	1731	MODIFY SPLICE ENCLOSURE	5 EA		
0273	7990000000-E	SP	GENERIC SIGNAL ITEM BACK PULL FIBER OPTIC CABLE	500 LF		
WALL ITEMS						
0266	8203000000-E	420	CLASS A CONCRETE (RETAINING WALL)	28 CY		
0267	8252000000-E	425	REINFORCING STEEL (RETAINING WALL)	3,002 LB		
1532/Oct26/Q651156.253/D1209478902000/E270			Total Amount Of Bid For Entire Project :			