

2/25/2019
Us:\Traffic\Signing\CA00\Signing\U-4405A\Signing Plan Sheets\Proposed Signing\U-4405 Title Sheet and Details.dgn
Inamberight

401 QUANTITY REQ'D 10



ONE "U" POST PER SIGN

402 QUANTITY REQ'D 17

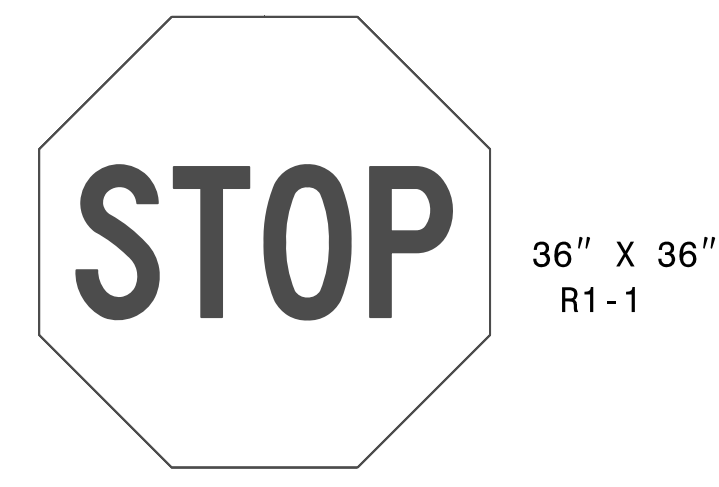

TWO "U" POST PER SIGN
(MOUNT BELOW SIGN #403
IN 15 INSTALLATIONS)

403 QUANTITY REQ'D 24



TWO "U" POST PER SIGN
(MOUNT BACK TO BACK WITH
SIGN #404 IN 7 INSTALLATIONS)

404 QUANTITY REQ'D 21



TWO "U" POST PER SIGN
(MOUNT BACK TO BACK WITH
SIGN #403 IN 7 INSTALLATIONS)

405 QUANTITY REQ'D 8

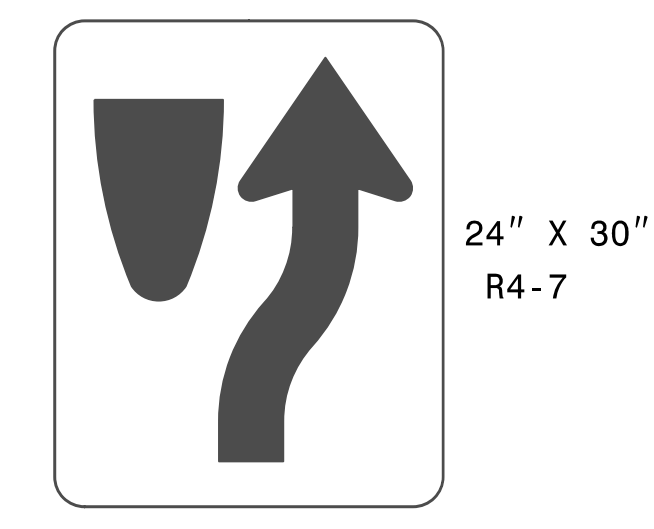

ONE "U" POST PER SIGN

406 QUANTITY REQ'D 8

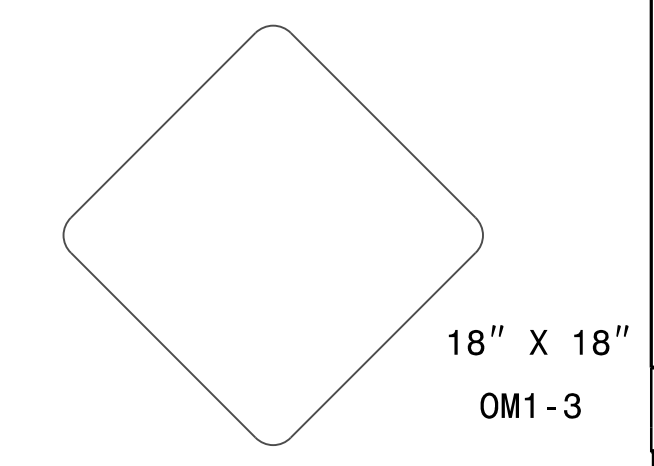

MOUNT BELOW SIGN #405

TIP NO. U-4405A	SHEET NO. SIGN-2A
APPROVED: <i>Betsy L. Watson</i> DATE: 3/4/2019	
SEAL 	
DOCUMENT NOT CONSIDERED FINAL UNLESS ALL SIGNATURES COMPLETED	



407 QUANTITY REQ'D 15

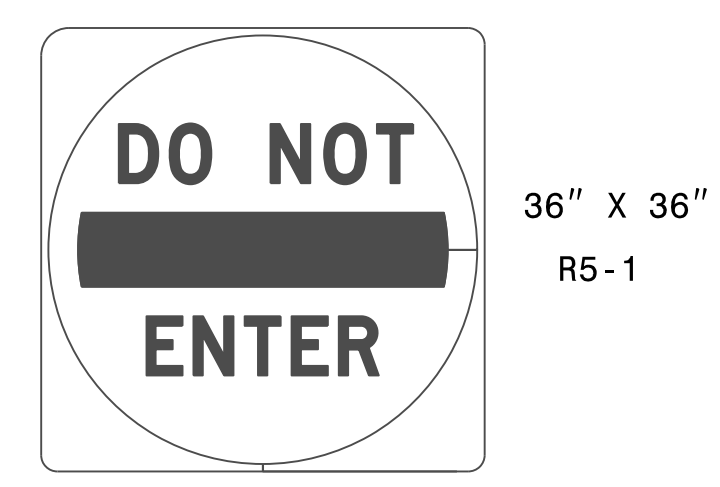

ONE "U" POST PER SIGN

408 QUANTITY REQ'D 0



W16-9p

409 QUANTITY REQ'D 9



ONE "U" POST PER SIGN

410 QUANTITY REQ'D 4



ONE "U" POST PER SIGN

411 QUANTITY REQ'D 5

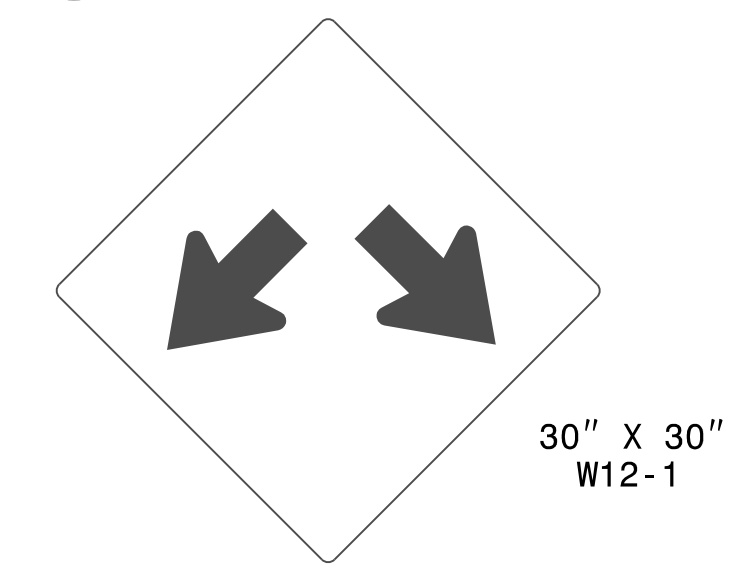

ONE "U" POST PER SIGN

412 QUANTITY REQ'D 12



ONE "U" POST PER SIGN

413 QUANTITY REQ'D 0



ONE "U" POST PER SIGN

414 QUANTITY REQ'D 4

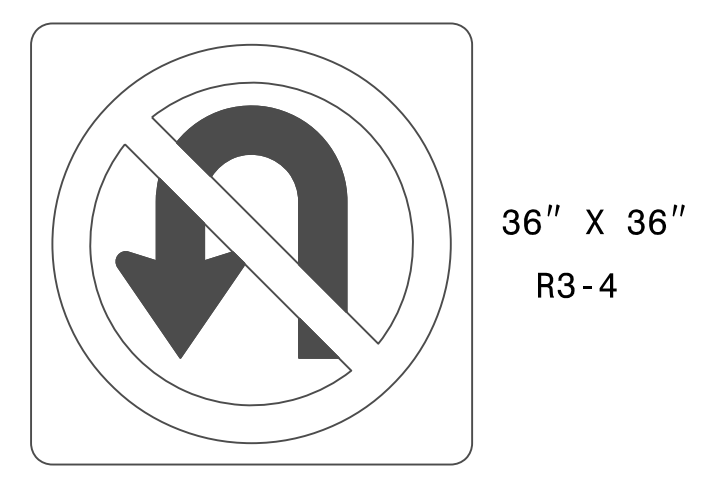

ONE "U" POST PER SIGN

415 QUANTITY REQ'D 0

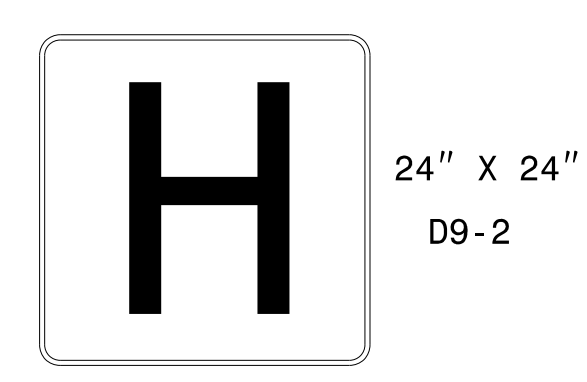

D9-2

416 QUANTITY REQ'D 0



D9-13dP

417 QUANTITY REQ'D 0

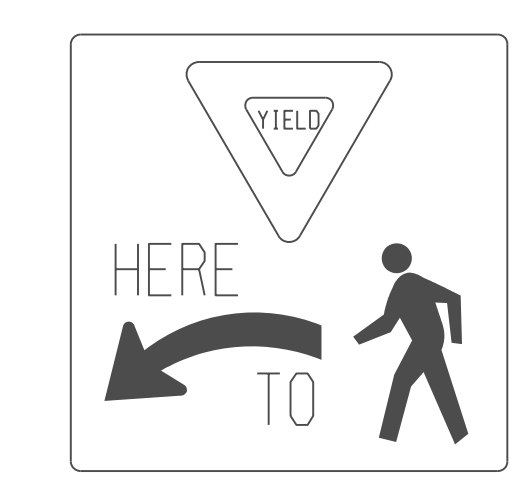

R1-5

418 QUANTITY REQ'D 4

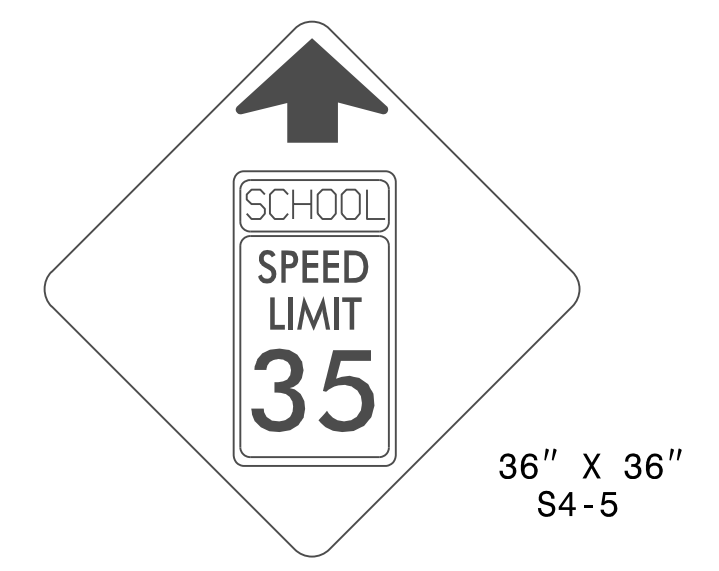

ONE "U" POST PER SIGN

419 QUANTITY REQ'D 7



ONE "U" POST PER SIGN

420 QUANTITY REQ'D 7



(MOUNT BELOW SIGN #419 IN
3 INSTALLATIONS)
(MOUNT ABOVE SIGN #410 IN
4 INSTALLATIONS)

421 QUANTITY REQ'D 2

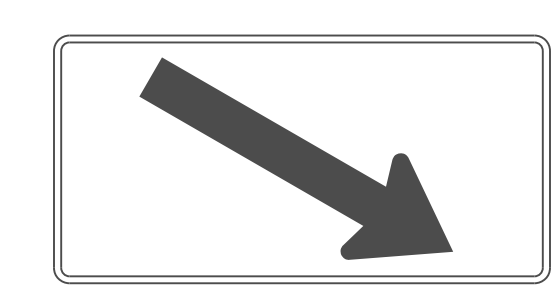

(MOUNT BELOW SIGN #419
IN 2 INSTALLATIONS)

422 QUANTITY REQ'D 2

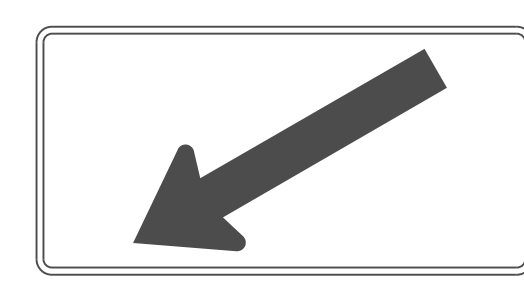

(MOUNT BELOW SIGN #419
IN 2 INSTALLATIONS)

423 QUANTITY REQ'D 1

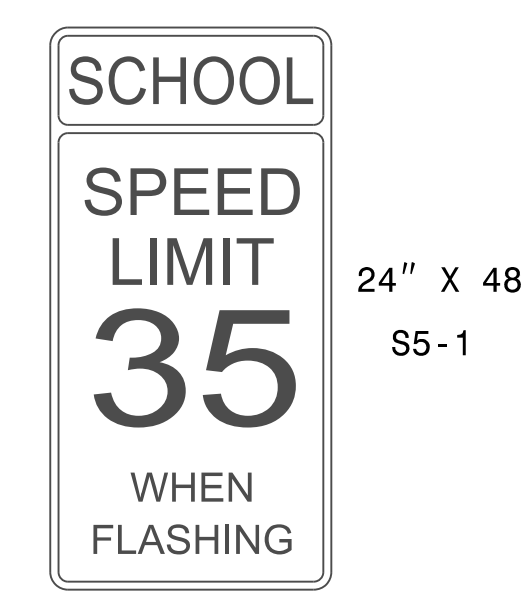

SIGN TO BE MOUNTED ON A
SUPPORT WITH A FLASHER ASSEMBLY.

424 QUANTITY REQ'D 2

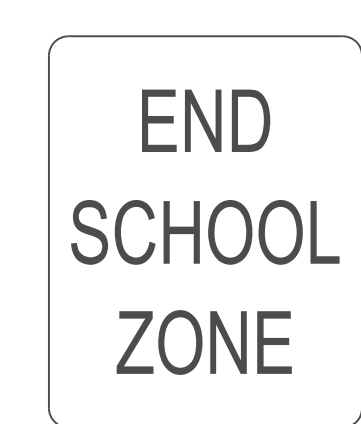

ONE "U" POST PER SIGN

425 QUANTITY REQ'D 4

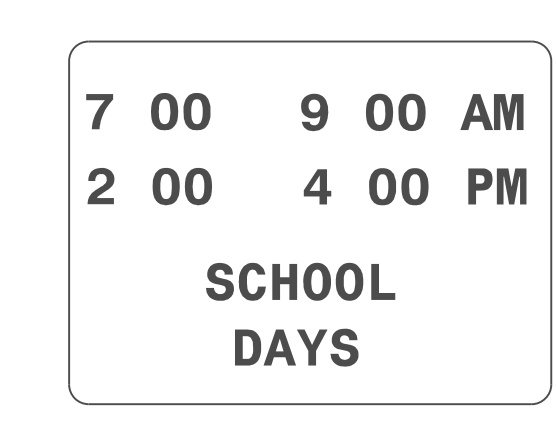

(MOUNT BELOW SIGN #410
IN 4 INSTALLATIONS)

426 QUANTITY REQ'D 0

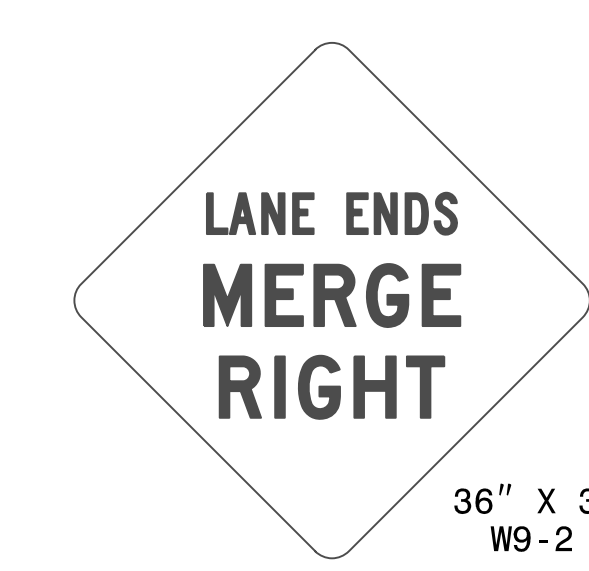

W9-2

427 QUANTITY REQ'D 0

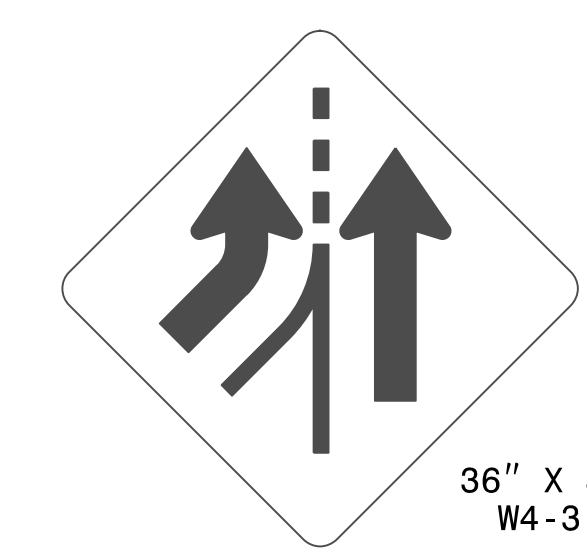

W4-3

428 QUANTITY REQ'D 0

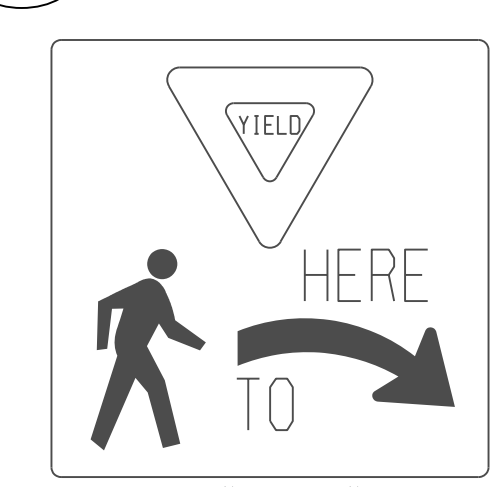

R1-5

429 QUANTITY REQ'D 1

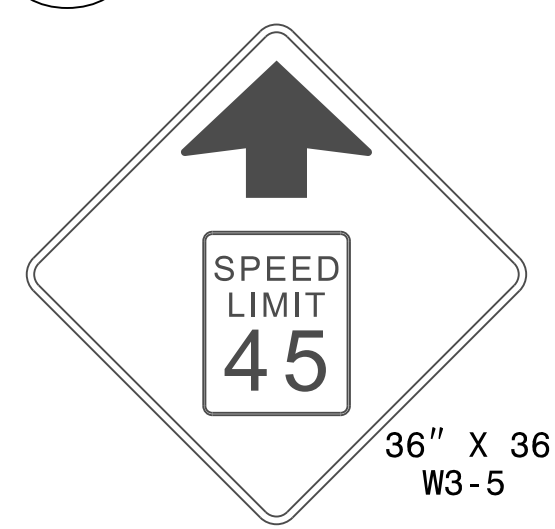

ONE "U" POST PER SIGN

430 QUANTITY REQ'D 0

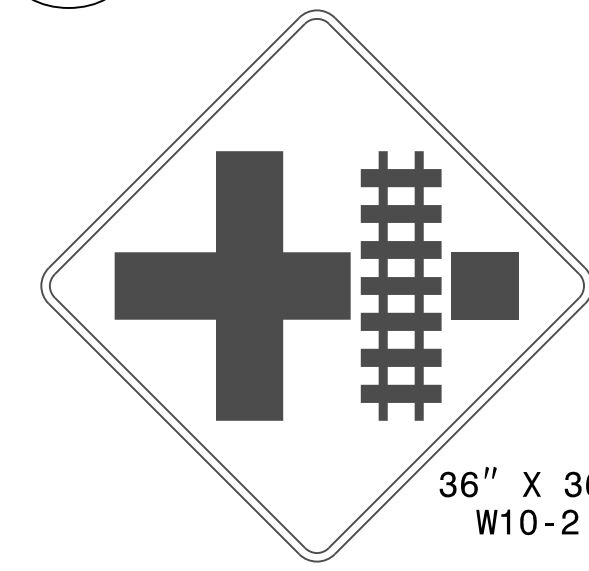

W10-2

431 QUANTITY REQ'D 0



R8-8

432 QUANTITY REQ'D 0

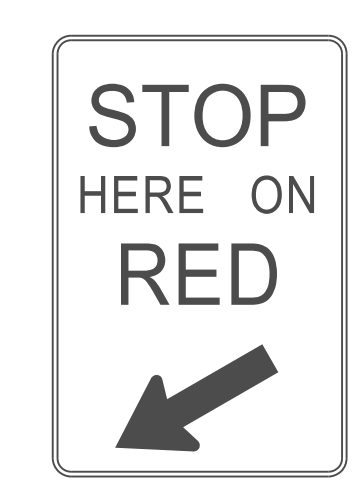

R10-6

TYPE "E" SIGNS