

T.I.P.: I-5878

CONTRACT NO.:

**STATE OF NORTH CAROLINA  
DEPARTMENT OF TRANSPORTATION**

**SIGNING PLAN  
CUMBERLAND, HARNETT,  
AND JOHNSTON COUNTIES**

**LOCATION: I-95 FROM US 421 (E. CUMBERLAND ST.)  
(EXIT 73) TO POPE ROAD (EXIT 72).**

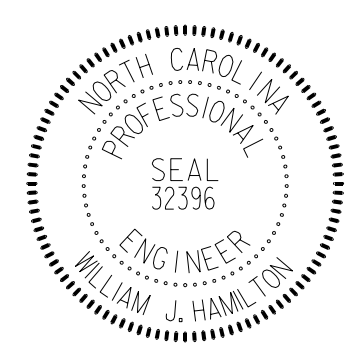
|  |                                    |
|--|------------------------------------|
| <small>TIP NO.</small><br>I-5878   | <small>SHEET NO.</small><br>SIGN-1 |
| <small>APPROVED BY:</small> <i>William J. Hamilton</i><br><small>AS00070468484</small> |                                    |
| <small>DATE:</small> 3/15/2021   |                                    |
|     |                                    |
| <b>DOCUMENT NOT CONSIDERED FINAL<br/>UNLESS ALL SIGNATURES COMPLETED</b>               |                                    |

**INDEX**

| <u>SHEET NO.</u> | <u>DESCRIPTION</u>                 |
|------------------|------------------------------------|
| SIGN-1           | TITLE SHEET                        |
| SIGN-2           | SUPPORT INFORMATION                |
| SIGN-3-3A        | TYPE "E", "F" AND MILEMARKER SIGNS |
| SIGN-4-4L        | SIGN DESIGNS AND OVERHEAD DETAILS  |
| SIGN-5-21        | SIGN DETAIL SHEETS                 |

**PROJECT NOTES**

- 1 DISPOSAL OF SIGN SYSTEM, U-CHANNEL
- 2 DISPOSAL OF SIGN SYSTEM, WOOD
- 3 DISPOSAL OF SIGN SYSTEM, STEEL BEAM
- 4 RELOCATE SIGN, TYPE E
- 5 RELOCATE SIGN, TYPE A
- 6 DISPOSAL OF SUPPORT, STEEL

**ROADWAY STANDARD DRAWING**

THE FOLLOWING ROADWAY STANDARDS AS APPEAR IN "ROADWAY STANDARD DRAWINGS" - PROJECT SERVICES UNIT - N.C. DEPARTMENT OF TRANSPORTATION - RALEIGH, N.C., DATED JANUARY 2018 ARE APPLICABLE TO THIS PROJECT AND BY REFERENCE HEREBY ARE CONSIDERED A PART OF THESE PLANS:

| <u>STD. NO.</u> | <u>TITLE</u>   |
|-----------------|--|
| 901.10          | TYPE 'A' SIGNS   |
| 901.20          | TYPE 'B' SIGNS   |
| 901.50          | ARROWS AND SHIELDS   |
| 901.70          | SIGN STRINGERS AND SUPPORT SPACING                           |
| 901.80          | SIGN MOUNTING DETAILS - FOR TYPE A AND TYPE B SIGNS          |
| 903.10          | GROUND MOUNTED SIGN SUPPORTS                                 |
| 904.10          | ORIENTATION OF GROUND MOUNTED SIGNS                          |
| 904.20          | SECONDARY SIGN MOUNTING                                      |
| 904.30          | SUPPLEMENTAL SIGN MOUNTING                                   |
| 904.40          | MILEPOST AND PLACEMENT                                       |
| 904.50          | MOUNTING OF TYPE 'D', 'E' AND 'F' SIGNS ON 'U' CHANNEL POSTS |
| 910.40          | MOUNTING OF TYPE 'D', 'E' AND 'F' SIGNS ON 'U' CHANNEL POSTS |

**SUMMARY OF QUANTITIES**

| ITEM NO.   |           | ITEM DESCRIPTION                                     | QUANTITY | UNIT |
|------------|-----------|--|----------|------|
| DESC. NO.  | SECT. NO. |  |          |      |
| 4048000000 | 902       | REINFORCED CONCRETE SIGN FOUNDATION                  | 5        | C.Y. |
| 4054000000 | 902       | PLAIN CONCRETE SIGN FOUNDATION                       | 4        | C.Y. |
| 4057000000 | SP        | OVERHEAD FOOTING                                     | 77       | C.Y. |
| 4060000000 | 903       | SUPPORTS, BREAKAWAY STEEL BEAM                       | 11075    | LB.  |
| 4072000000 | 903       | SUPPORTS, 3 LB STEEL U-CHANNEL                       | 3215     | L.F. |
| 4096000000 | 904       | SIGN ERECTION, TYPE D                                | 21       | EA.  |
| 4102000000 | 904       | SIGN ERECTION, TYPE E                                | 142      | EA.  |
| 4108000000 | 904       | SIGN ERECTION, TYPE F                                | 21       | EA.  |
| 4109000000 | 904       | SIGN ERECTION, TYPE A (OVERHEAD)                     | 5        | EA.  |
| 4109000000 | 904       | SIGN ERECTION, TYPE B (OVERHEAD)                     | 5        | EA.  |
| 4110000000 | 904       | SIGN ERECTION, TYPE A (GROUND MOUNTED)               | 6        | EA.  |
| 4116300000 | 904       | SIGN ERECTION, LOGO TO PANEL                         | 7        | EA.  |
| 4114000000 | 904       | SIGN ERECTION, MILEMARKERS                           | 6        | EA.  |
| 4116100000 | 904       | SIGN ERECTION, RELOCATE SIGN TYPE A (GROUND MOUNTED) | 13       | EA.  |
| 4116100000 | 904       | SIGN ERECTION, RELOCATE SIGN TYPE E (GROUND MOUNTED) | 1        | EA.  |
| 4082100000 | 906       | SUPPORTS, OVERHEAD SIGN STRUCTURE @ STA 956+67 -L-   | 1        | L.S. |
| 4082100000 | 906       | SUPPORTS, OVERHEAD SIGN STRUCTURE @ STA 1019+50 -L-  | 1        | L.S. |
| 4082100000 | 906       | SUPPORTS, OVERHEAD SIGN STRUCTURE @ STA 1034+40 -L-  | 1        | L.S. |
| 4082100000 | 906       | SUPPORTS, OVERHEAD SIGN STRUCTURE @ STA 1044+00 -L-  | 1        | L.S. |
| 4082100000 | 906       | SUPPORTS, OVERHEAD SIGN STRUCTURE @ STA 1060+60 -L-  | 1        | L.S. |
| 4138000000 | 907       | DISPOSAL OF SUPPORT, STEEL BEAM                      | 13       | EA.  |
| 4152000000 | 907       | DISPOSAL OF SIGN SYSTEM, STEEL BEAM                  | 16       | EA.  |
| 4155000000 | 907       | DISPOSAL OF SIGN SYSTEM, U-CHANNEL                   | 179      | EA.  |

**GENERAL NOTES**

- . SIGNS FURNISHED BY STATE
- . CONFIRM IN WRITING AT LEAST 4 MONTHS IN ADVANCE, THE ACTUAL DATE THE DEPARTMENT FURNISHED SIGNS WILL BE REQUIRED.
- . ALL TYPE 'D' SIGNS SHALL BE MOUNTED ON TWO U-CHANNEL POSTS UNLESS OTHERWISE INDICATED ON THE PLANS.
- . IF REMOVAL OR RELOCATION OF SIGNS ON PRIVATE STREET (NON-STATE MAINTAINED) IS REQUIRED DUE TO CONSTRUCTION, THE CONTRACTOR SHALL INFORM THE ENGINEER. THE WORK WILL BE COMPLETED BY OTHERS.
- . WHEN NOT STATIONED OR DIMENSIONED ON PLANS, ALL 'E' AND 'F' SIGNS SHALL BE FIELD LOCATED BY THE ENGINEER
- . ALL EXISTING SIGNS ON "U" CHANNEL POST WITHIN THE PROJECT LIMITS SHALL BE REMOVED AND DISPOSED OF UNLESS OTHERWISE NOTED ON PLANS.
- . WHEN EXISTING SIGNS ARE REMOVED AND INSTALLED ON NEW SUPPORTS, THE RE-ERECTION SHALL IMMEDIATELY FOLLOW THE REMOVAL.
- . THE BACKGROUND FOR TYPE E & F SIGNS SHALL BE TYPE C REFLECTIVE SHEETING.
- . DO NOT BEGIN FABRICATION FOR TYPES A & B SIGNS MOUNTED ON OVERHEAD STRUCTURES OR STEEL SUPPORTS UNTIL "S" DIMENSIONS HAVE BEEN FIELD VERIFIED.
- . SEE ROADWAY PLANS FOR GUARD/GUIDE RAIL DETAILS.

|  |   |   |
|--|---|---|
| <b>PLAN REVIEWED BY: N.C.D.O.T. SIGNING AND DELINEATION UNIT</b> |   |  |
| <b>AYMAN ALQUDWAH, P.E.</b>                                      | SIGNING & DELINEATION REGIONAL ENGINEER       |   |
| <b>ERIC WARD</b>   | SIGNING & DELINEATION PROJECT DESIGN ENGINEER |   |

|  |                  |   |
|--|------------------|---|
| <b>PLAN PREPARED BY: Ramey Kemp Associates</b> |                  |  |
| <b>W.JASON HAMILTON, P.E., PTOE</b>            | PROJECT MANAGER  |   |
| <b>TIMOTHY S. POPELKA, P.E.</b>                | PROJECT ENGINEER |   |

5808 Farington Place Raleigh, North Carolina 27609  
Phone: 919-872-5115 | www.rameykemp.com | NC License No. C-0910

APPROVED: *William J. Hamilton*  
REGISTERED PROFESSIONAL ENGINEER

DATE: 3/15/2021

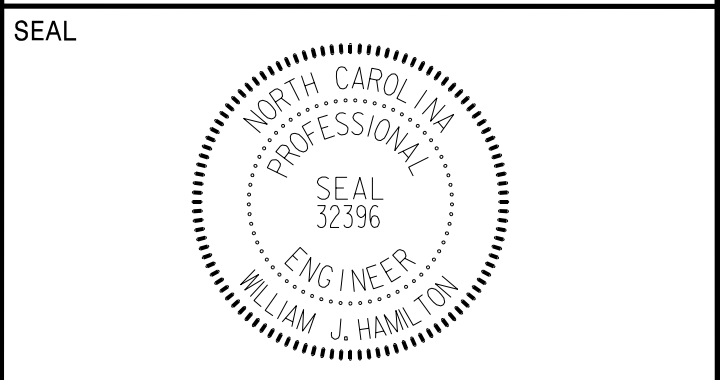

**DOCUMENT NOT CONSIDERED FINAL  
 UNLESS ALL SIGNATURES COMPLETED**



| NUMBER | TYPE | SIGN SIZE (in.) |     |     | ROADWAY STATION     | NUMBER OF SUPPORTS | BEAM SECTION | SUPPORT TYPE BA or S | OMNI COUPLER | ATTACHMENT METHOD | MOUNTING METHOD | HORIZONTAL CLEARANCE (ft.) | SUPPORT SPACING | LENGTH (ft) |        |            | LEFT SUPPORT (ft) |       |        | CENTER SUPPORT (ft) |      |        | RIGHT SUPPORT (ft) |       |        | SUPPORT WEIGHTS |               | FOOTINGS       |             |                   |              | FIELD VERIFIED SEE NOTE 2 (mm/dd/yy) |
|--------|------|-----------------|-----|-----|---------------------|--------------------|--------------|----------------------|--------------|-------------------|-----------------|----------------------------|-----------------|-------------|--------|------------|-------------------|-------|--------|---------------------|------|--------|--------------------|-------|--------|-----------------|---------------|----------------|-------------|-------------------|--------------|--------------------------------------|
|        |      | w               | x   | h   |                     |                    |              |                      |              |                   |                 |                            |                 | SNS HT      | MTG HT | EMBED-MENT | S                 | L     | LENGTH | S                   | L    | LENGTH | S                  | L     | LENGTH | B/A (lbs.)      | SIMPLE (lbs.) | DIAMETER (ft.) | DEPTH (ft.) | REINFORCED (c.y.) | PLAIN (c.y.) |                                      |
|        |      | "H"             | "C" |     |                     |                    |              |                      |              |                   |                 |                            |                 |             |        |            |                   |       |        |                     |      |        |                    |       |        |                 |               |                |             |                   |              |                                      |
| 101    | A    | 192             | x   | 66  | STA. 949+00 -L-     | 2                  | W6x12        | BA                   | N/A          | N/A               | N/A             | 30.00                      | 9.38            | 5.50        | 7.00   | 3.5        | 4.83              | 17.33 | 20.83  | 0.00                | 0.00 | 0.00   | 5.86               | 18.36 | 21.86  | 590.28          | 0             | 1.5            | 4           | 0.52              | 0.00         |                                      |
| 102    | A    | 144             | x   | 90  | STA. 21+00 -Y14RPC- | 2                  | W6x16        | BA                   | N/A          | N/A               | N/A             | 18.00                      | 7.03            | 7.50        | 7.00   | 3.5        | 2.80              | 17.30 | 20.80  | 0.00                | 0.00 | 0.00   | 5.80               | 20.30 | 23.80  | 807.60          | 0             | 1.5            | 4           | 0.52              | 0.00         |                                      |
| 103    | A    | 144             | x   | 78  | STA. 14+00 -SBCD-   | 2                  | W6x12        | BA                   | N/A          | N/A               | N/A             | 18.00                      | 7.03            | 6.50        | 7.00   | 3.5        | 1.46              | 14.96 | 18.46  | 0.00                | 0.00 | 0.00   | 5.46               | 18.96 | 22.46  | 569.04          | 0             | 1.5            | 4           | 0.52              | 0.00         |                                      |
| 104    | A    | 144             | x   | 72  | STA. 33+50 -NBCD-   | 2                  | W6x9         | BA                   | N/A          | N/A               | N/A             | 18.00                      | 7.03            | 6.00        | 7.00   | 3.0        | 1.75              | 14.75 | 17.75  | 0.00                | 0.00 | 0.00   | 3.75               | 16.75 | 19.75  | 401.50          | 0             | 1.5            | 3.5         | 0.46              | 0.00         |                                      |
| 105    | A    | 138             | x   | 54  | STA. 17+00 -Y15RPA- | 2                  | S4x7.7       | BA                   | N/A          | N/A               | N/A             | 18.00                      | 6.74            | 4.50        | 7.00   | 3.0        | 2.75              | 14.25 | 17.25  | 0.00                | 0.00 | 0.00   | 0.85               | 12.35 | 15.35  | 291.02          | 0             | 1.0            | 3.5         | 0.00              | 0.20         |                                      |
| 106    | A    | 192             | x   | 66  | STA. 1028+00 -L-    | 2                  | W6x12        | BA                   | N/A          | N/A               | N/A             | 30.00                      | 9.38            | 5.50        | 7.00   | 3.5        | 2.01              | 14.51 | 18.01  | 0.00                | 0.00 | 0.00   | 4.50               | 17.00 | 20.50  | 540.12          | 0             | 1.5            | 4           | 0.52              | 0.00         |                                      |
| 107    | A    | 90              | x   | 84  | STA. 16+50 -Y14RPC  | 2                  | S4x7.7       | BA                   | N/A          | N/A               | N/A             | 18.00                      | 4.40            | 7.00        | 7.00   | 3.0        | 1.02              | 15.02 | 18.02  | 0.00                | 0.00 | 0.00   | 0.25               | 14.25 | 17.25  | 311.58          | 0             | 1.0            | 3.5         | 0.00              | 0.20         |                                      |
| 108    | B    | 90              | x   | 48  | STA. 16+50 -Y14RPC  | 2                  | S3x5.7       | BA                   | N/A          | N/A               | N/A             | 18.00                      | 4.40            | 4.00        | 7.00   | 2.5        | 1.61              | 12.61 | 15.11  | 0.00                | 0.00 | 0.00   | 2.34               | 13.34 | 15.84  | 212.42          | 0             | 1.0            | 3           | 0.00              | 0.17         |                                      |
| 109    | A    | 90              | x   | 72  | STA. 18+00 -Y14RPC  | 2                  | S3x5.7       | BA                   | N/A          | N/A               | N/A             | 18.00                      | 4.40            | 6.00        | 7.00   | 3.0        | 1.09              | 14.09 | 17.09  | 0.00                | 0.00 | 0.00   | 0.00               | 13.00 | 16.00  | 224.61          | 0             | 1.0            | 3.5         | 0.00              | 0.20         |                                      |
| 110    | A    | 90              | x   | 72  | STA. 19+50 -Y14RPC  | 2                  | S3x5.7       | BA                   | N/A          | N/A               | N/A             | 18.00                      | 4.40            | 6.00        | 7.00   | 3.0        | 0.79              | 13.79 | 16.79  | 0.00                | 0.00 | 0.00   | 0.00               | 13.00 | 16.00  | 222.90          | 0             | 1.0            | 3.5         | 0.00              | 0.20         |                                      |
| 111    | A    | 90              | x   | 84  | STA. 19+50 -Y14RPC  | 2                  | S4x7.7       | BA                   | N/A          | N/A               | N/A             | 18.00                      | 4.40            | 7.00        | 7.00   | 3.0        | 2.12              | 16.12 | 19.12  | 0.00                | 0.00 | 0.00   | 3.22               | 17.22 | 20.22  | 342.92          | 0             | 1.0            | 3.5         | 0.00              | 0.20         |                                      |
| 112    | A    | 90              | x   | 84  | STA. 23+00 -Y14RPA- | 2                  | S4x7.7       | BA                   | N/A          | N/A               | N/A             | 18.00                      | 4.40            | 7.00        | 7.00   | 3.0        | 1.23              | 15.23 | 18.23  | 0.00                | 0.00 | 0.00   | 0.49               | 14.49 | 17.49  | 315.04          | 0             | 1.0            | 3.5         | 0.00              | 0.20         |                                      |
| 113    | A    | 180             | x   | 138 | STA. 1036+00 -L-    | 2                  | W8x18        | BA                   | N/A          | N/A               | N/A             | 30.00                      | 8.79            | 11.50       | 7.00   | 4.5        | 3.23              | 21.73 | 26.23  | 0.00                | 0.00 | 0.00   | 4.69               | 23.19 | 27.69  | 1110.56         | 0             | 2.0            | 5           | 1.16              | 0.00         |                                      |
| 201    | A    | 78              | x   | 60  | STA. 961+00 -L-     | 2                  | S3x5.7       | BA                   | N/A          | N/A               | N/A             | Δ                          | 3.81            | 5.00        | 7.00   | 2.5        | 0.50              | 12.50 | 15.00  | 0.00                | 0.00 | 0.00   | 0.50               | 12.50 | 15.00  | 207.00          | 0             | 1.0            | 3           | 0.00              | 0.17         |                                      |
| 202    | A    | 78              | x   | 60  | STA. 1014+25 -L-    | 2                  | S3x5.7       | BA                   | N/A          | N/A               | N/A             | Δ                          | 3.81            | 5.00        | 7.00   | 2.5        | 0.50              | 12.50 | 15.00  | 0.00                | 0.00 | 0.00   | 0.50               | 12.50 | 15.00  | 207.00          | 0             | 1.0            | 3           | 0.00              | 0.17         |                                      |
| 901    | A    | 90              | x   | 72  | STA. 15+50 -SBCD-   | 2                  | S4x7.7       | BA                   | N/A          | N/A               | N/A             | 18.00                      | 4.40            | 6.00        | 7.00   | 3.0        | 1.55              | 14.55 | 17.55  | 0.00                | 0.00 | 0.00   | 2.28               | 15.28 | 18.28  | 315.89          | 0             | 1.0            | 3.5         | 0.00              | 0.20         |                                      |
| 902    | A    | 90              | x   | 72  | STA. 17+00 -SBCD-   | 2                  | S4x7.7       | BA                   | N/A          | N/A               | N/A             | 18.00                      | 4.40            | 6.00        | 7.00   | 3.0        | 1.55              | 14.55 | 17.55  | 0.00                | 0.00 | 0.00   | 2.28               | 15.28 | 18.28  | 315.89          | 0             | 1.0            | 3.5         | 0.00              | 0.20         |                                      |
| 903    | A    | 90              | x   | 72  | STA. 35+00 -NBCD-   | 2                  | S4x7.7       | BA                   | N/A          | N/A               | N/A             | 18.00                      | 4.40            | 6.00        | 7.00   | 3.0        | 1.75              | 14.75 | 17.75  | 0.00                | 0.00 | 0.00   | 2.48               | 15.48 | 18.48  | 318.97          | 0             | 1.0            | 3.5         | 0.00              | 0.20         |                                      |
| 904    | A    | 90              | x   | 72  | STA. 36+50 -NBCD-   | 2                  | S4x7.7       | BA                   | N/A          | N/A               | N/A             | 18.00                      | 4.40            | 6.00        | 7.00   | 3.0        | 1.75              | 14.75 | 17.75  | 0.00                | 0.00 | 0.00   | 2.48               | 15.48 | 18.48  | 318.97          | 0             | 1.0            | 3.5         | 0.00              | 0.20         |                                      |
| 905    | A    | 90              | x   | 72  | STA. 38+00 -NBCD-   | 2                  | S4x7.7       | BA                   | N/A          | N/A               | N/A             | 18.00                      | 4.40            | 6.00        | 7.00   | 3.0        | 1.75              | 14.75 | 17.75  | 0.00                | 0.00 | 0.00   | 2.48               | 15.48 | 18.48  | 318.97          | 0             | 1.0            | 3.5         | 0.00              | 0.20         |                                      |
| 906    | A    | 63              | x   | 114 | STA. 39+50 -NBCD-   | 2                  | W6x9         | BA                   | N/A          | N/A               | N/A             | 18.00                      | 3.08            | 9.50        | 7.00   | 3.0        | 1.55              | 18.05 | 21.05  | 0.00                | 0.00 | 0.00   | 2.72               | 19.22 | 22.22  | 453.43          | 0             | 1.5            | 3.5         | 0.46              | 0.00         |                                      |
| 907    | A    | 63              | x   | 114 | STA. 21+50 -Y15RPA- | 2                  | S4x7.7       | BA                   | N/A          | N/A               | N/A             | 18.00                      | 3.08            | 9.50        | 7.00   | 3.0        | 1.94              | 18.44 | 21.44  | 0.00                | 0.00 | 0.00   | 2.18               | 18.68 | 21.68  | 372.02          | 0             | 1.0            | 3.5         | 0.00              | 0.20         |                                      |
| 908    | A    | 90              | x   | 72  | STA. 21+50 -Y15RPA- | 2                  | S3x5.7       | BA                   | N/A          | N/A               | N/A             | 18.00                      | 4.40            | 6.00        | 7.00   | 3.0        | 0.35              | 13.35 | 16.35  | 0.00                | 0.00 | 0.00   | 1.22               | 14.22 | 17.22  | 227.35          | 0             | 1.0            | 3.5         | 0.00              | 0.20         |                                      |
| 909    | A    | 90              | x   | 72  | STA. 20+00 -Y15RPA- | 2                  | S4x7.7       | BA                   | N/A          | N/A               | N/A             | 18.00                      | 4.40            | 6.00        | 7.00   | 3.0        | 1.28              | 14.28 | 17.28  | 0.00                | 0.00 | 0.00   | 2.01               | 15.01 | 18.01  | 311.73          | 0             | 1.0            | 3.5         | 0.00              | 0.20         |                                      |
| 910    | A    | 90              | x   | 72  | STA. 18+50 -Y15RPA- | 2                  | S4x7.7       | BA                   | N/A          | N/A               | N/A             | 18.00                      | 4.40            | 6.00        | 7.00   | 3.0        | 1.55              | 14.55 | 17.55  | 0.00                | 0.00 | 0.00   | 2.28               | 15.28 | 18.28  | 315.89          | 0             | 1.0            | 3.5         | 0.00              | 0.20         |                                      |
| 911    | A    | 63              | x   | 114 | STA. 1051+50 -L-    | 2                  | S4x7.7       | BA                   | N/A          | N/A               | N/A             | 30.00                      | 3.08            | 9.50        | 7.00   | 3.0        | 0.00              | 16.50 | 19.50  | 0.00                | 0.00 | 0.00   | 2.01               | 18.51 | 21.51  | 355.78          | 0             | 1.0            | 3.5         | 0.00              | 0.20         |                                      |
| 912    | A    | 180             | x   | 138 | STA. 1057+50 -L-    | 2                  | W6x16        | BA                   | N/A          | N/A               | N/A             | 30.00                      | 8.79            | 11.50       | 7.00   | 4.5        | 2.45              | 20.95 | 25.45  | 0.00                | 0.00 | 0.00   | 0.00               | 18.50 | 23.00  | 869.20          | 0             | 1.5            | 5           | 0.65              | 0.00         |                                      |
| 913    | B    | 78              | x   | 48  | STA. 30+00 -Y15-    | 2                  | S3x5.7       | BA                   | N/A          | N/A               | N/A             | 18.00                      | 3.81            | 4.00        | 7.00   | 2.5        | 2.94              | 13.94 | 16.44  | 0.00                | 0.00 | 0.00   | 3.02               | 14.02 | 16.52  | 223.87          | 0             | 1.0            | 3           | 0.00              | 0.17         |                                      |

|       |          |       |      |       |      |       |      |
|-------|----------|-------|------|-------|------|-------|------|
| TOTAL | 11071.56 | TOTAL | 0.00 | TOTAL | 4.83 | TOTAL | 3.96 |
| USE:  | 11072.00 |       | 0.00 |       | 5.00 |       | 4.00 |

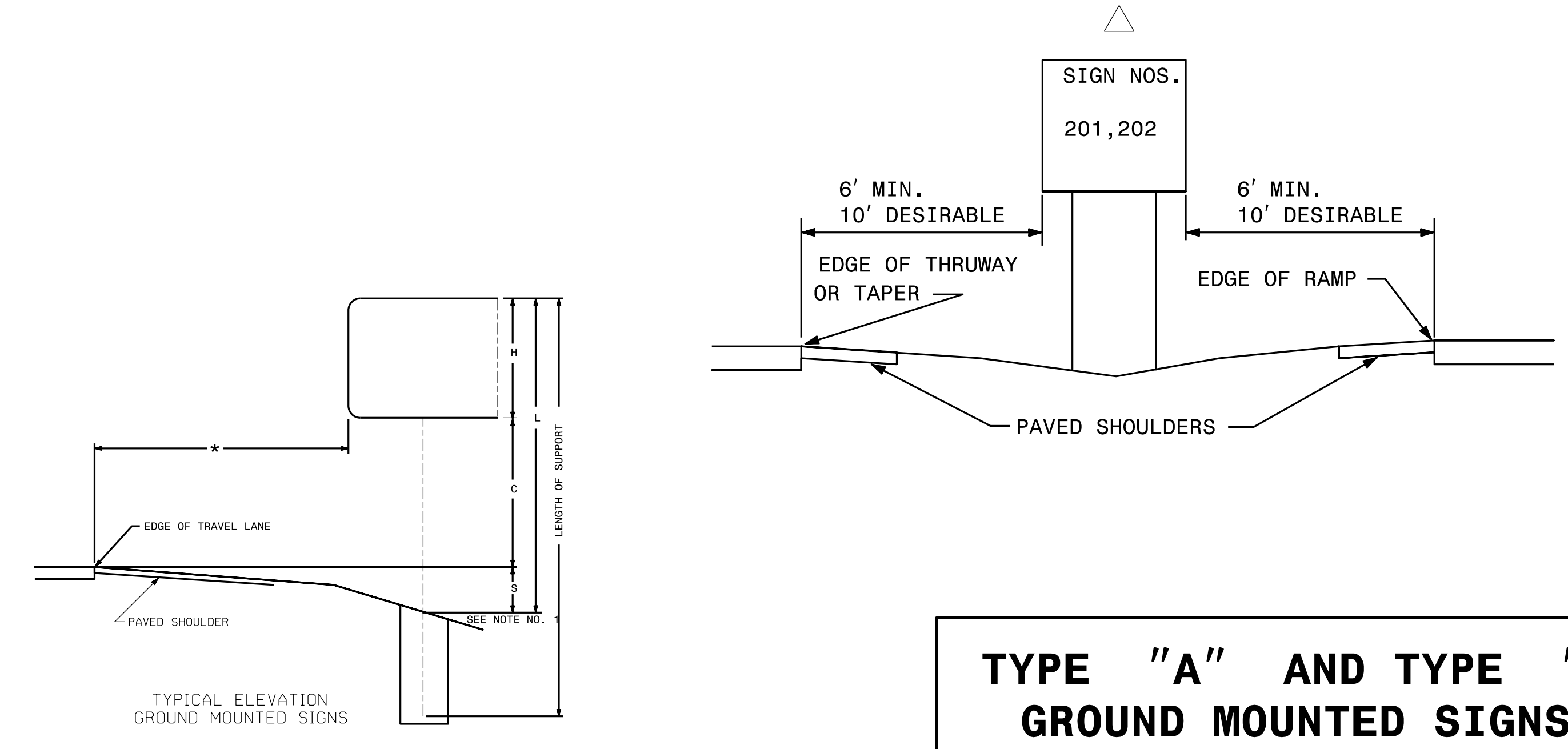

**NOTES**

- DIMENSION "S" REPRESENTS AN INCREASE (+), OR A DECREASE (-) IN POLE LENGTH, RELATIVE TO THE ELEVATION OF THE EDGE OF TRAVEL LANE.
- FIELD VERIFICATIONS SHALL BE REQUIRED FOR ALL SUPPORTS, SEE (\*) ARTICLE 903-3. FABRICATORS SHALL BE AISC CERTIFIED IN CATEGORY 1, SEE (\*) ARTICLE 1072-1. (\*) = N.C.D.O.T. STANDARD SPECIFICATIONS FOR ROADS AND STRUCTURES
- PLAN LOCATIONS FOR EXISTING UTILITIES ARE BASED ON THE BEST AVAILABLE INFORMATION AND, THEREFORE MAY NOT BE PRECISELY ACCURATE. THEREFORE, IT IS INCUMBENT UPON THE CONTRACTOR TO DETERMINE THE EXACT LOCATION OF UTILITIES BEFORE BEGINNING WORK IN A LOCATION.



**TYPE "A" AND TYPE "B"  
 GROUND MOUNTED SIGNS**

3/15/2021 15:09:58 Sgn\_Sign02\_011419.dgn User:jlwendt

|   |                              |
|---|------------------------------|
| TIP NO.<br><b>I - 5878</b>  | SHEET NO.<br><b>SIGN - 3</b> |
| APPROVED: <i>William J. Hamilton</i><br><small>AGS607048484</small>   |                              |
| DATE: <b>3/15/2021</b>  |                              |
| SEAL<br>   |                              |
| <b>DOCUMENT NOT CONSIDERED FINAL<br/>UNLESS ALL SIGNATURES COMPLETED</b>  |                              |
| <br><b>RKA</b><br>RAMEY KEMP ASSOCIATES<br><small>5808 Faringdon Place<br/>Raleigh, North Carolina 27609<br/>Phone: 919-872-5115</small> |                              |
| <small>NC License No. C-0910<br/>www.rameykemp.com</small>  |                              |

401 QUANTITY REQ'D 2



30" X 12"  
D9-13aP

MOUNT BELOW SIGNS 101 AND 106

406 QUANTITY REQ'D 8



36" X 36"  
R5-1

ONE "U" POST PER SIGN;  
MOUNT BACK TO BACK WITH SIGN 402  
IN 2 INSTALLATIONS

411 QUANTITY REQ'D 8



30" X 36"  
R2-1

ONE "U" POST PER SIGN

416 QUANTITY REQ'D 3

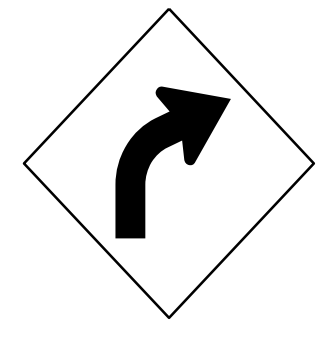

30" X 30"  
W1-2R

ONE "U" POST PER SIGN

421 QUANTITY REQ'D 11

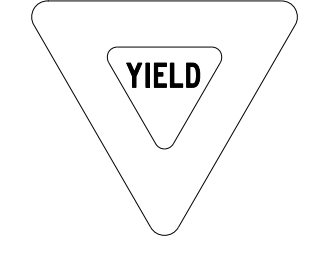

48" X 48" X 48"  
R1-2

ONE "U" POST PER SIGN

QUANTITY REQ'D 2

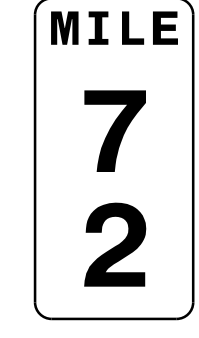

12" X 48"  
D10-2

ONE "U" POST PER SIGN

402 QUANTITY REQ'D 23

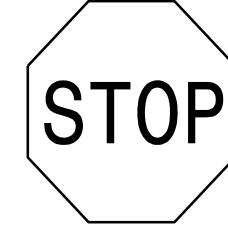

36" X 36"  
R1-1

ONE "U" POST PER SIGN

407 QUANTITY REQ'D 8



36" X 24"  
R5-1a

ONE "U" POST PER SIGN

412 QUANTITY REQ'D 4



30" X 36"  
R2-1

ONE "U" POST PER SIGN

417 QUANTITY REQ'D 2



36" X 36"  
R3-7R

ONE "U" POST PER SIGN

422 QUANTITY REQ'D 6



30" X 24"  
R6-4

ONE "U" POST PER SIGN

QUANTITY REQ'D 2

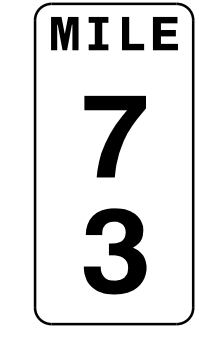

12" X 48"  
D10-2

ONE "U" POST PER SIGN

403 QUANTITY REQ'D 2

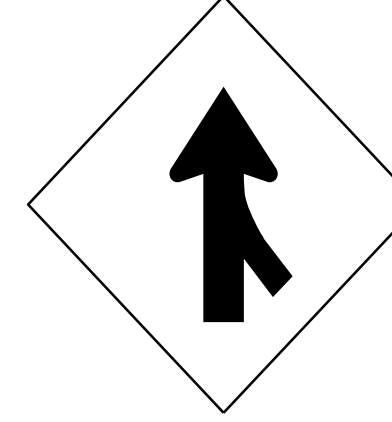

48" X 48"  
W4-1 (R)

TWO "U" POSTS PER SIGN

408 QUANTITY REQ'D 4

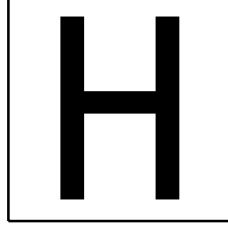

30" X 30"  
D9-2

MOUNT BELOW SIGNS 310, 316 AND 504

413 QUANTITY REQ'D 3



30" X 36"  
R2-1

ONE "U" POST PER SIGN

418 QUANTITY REQ'D 4

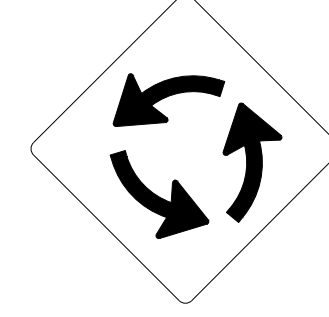

36" X 36"  
W2-6

ONE "U" POST PER SIGN

423 QUANTITY REQ'D 12

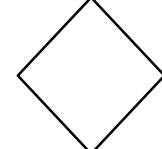

18" X 18"  
OM4-3

ONE "U" POST PER SIGN

QUANTITY REQ'D 2

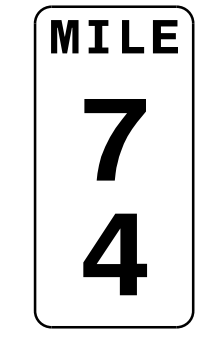

12" X 48"  
D10-2

ONE "U" POST PER SIGN

404 QUANTITY REQ'D 10

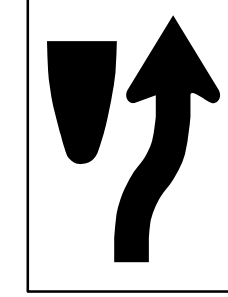

24" X 30"  
R4-7

ONE "U" POST PER SIGN

409 QUANTITY REQ'D 3



54" X 18"  
R6-1 (R)

TWO "U" POSTS PER SIGN

414 QUANTITY REQ'D 1



48" X 60"  
R2-1

TWO "U" POSTS PER SIGN

419 QUANTITY REQ'D 4



36" X 36"  
W11-2

ONE "U" POST PER SIGN

424 QUANTITY REQ'D 2

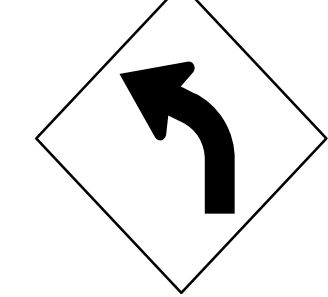

30" X 30"  
W1-2L

ONE "U" POST PER SIGN

405 QUANTITY REQ'D 10

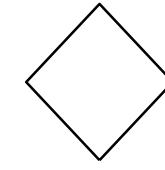

18" X 18"  
OM1-3

MOUNT BELOW SIGN 404  
IN 10 INSTALLATIONS

410 QUANTITY REQ'D 3



54" X 18"  
R6-1 (L)

MOUNT BACK TO BACK WITH SIGN 409  
IN 3 INSTALLATIONS

415 QUANTITY REQ'D 1

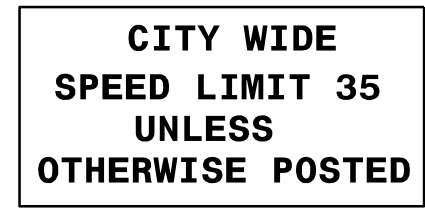

60" X 36"  
R2-27

MOUNT BELOW SIGN 424

420 QUANTITY REQ'D 4

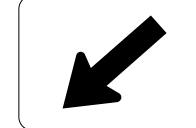

24" X 12"  
W16-7pL

MOUNT BELOW SIGN 419

425 QUANTITY REQ'D 4



24" X 24"  
W13-1

MOUNT BELOW SIGN 416/424  
IN 4 INSTALLATIONS

**TYPE "E"  
AND MILEMARKER SIGNS**

3/15/2021 15:00:03\_15986B\_Sgn\_Sign03\_011419.dgn  
 User:tlwendt

|  |           |
|--|-----------|
| TIP NO.  | SHEET NO. |
| I - 5878   | SIGN - 3A |
| APPROVED: <i>William J. Hamilton</i>                             |           |
| DATE: 3/15/2021  |           |
| SEAL   |           |
|  |           |
| DOCUMENT NOT CONSIDERED FINAL<br>UNLESS ALL SIGNATURES COMPLETED |           |

**RKA**  
RAMEY KEMP ASSOCIATES  
5808 Faringdon Place  
Raleigh, North Carolina 27609  
Phone: 919-872-5115  
NC License No. C-0910  
www.rameykemp.com

501

**SOUTH** 1 - 30" X 15"  
**INTERSTATE 95** 1 - 36" X 36"

ONE "U" POST PER ASSEMBLY

505

**NORTH** 1 - 24" X 12"  
**INTERSTATE 95** 1 - 24" X 24"  
**←** 1 - 21" X 15"

ONE "U" POST PER ASSEMBLY

511

**NORTH WEST** 2 - 24" X 12"  
**421 55** 2 - 24" X 24"  
**← ←** 2 - 21" X 15"

**SOUTH EAST** 2 - 24" X 12"  
**421 55** 2 - 24" X 24"  
**→ →** 2 - 21" X 15"

TWO "U" POSTS PER ASSEMBLY

516

**SOUTH** 1 - 24" X 12"  
**INTERSTATE 95** 1 - 24" X 24"  
**←** 1 - 21" X 15"

ONE "U" POST PER ASSEMBLY

502 510 512 520

**JCT** 1 - 24" X 12"  
**INTERSTATE 95** 1 - 24" X 24"

ONE "U" POST PER ASSEMBLY

506

**SOUTH** 1 - 24" X 12"  
**INTERSTATE 95** 1 - 24" X 24"  
**←** 1 - 21" X 15"

ONE "U" POST PER ASSEMBLY

513

**SOUTH EAST** 2 - 24" X 12"  
**421 55** 2 - 24" X 24"  
**→ →** 2 - 21" X 15"

TWO "U" POSTS PER ASSEMBLY

518

**SOUTH EAST** 2 - 24" X 12"  
**421 55** 2 - 24" X 24"  
**← ←** 2 - 21" X 15"

TWO "U" POSTS PER ASSEMBLY

503

**SOUTH NORTH** 2 - 24" X 12"  
**INTERSTATE 95 INTERSTATE 95** 2 - 24" X 24"  
**↑ →** 2 - 21" X 15"  
**TO TO** 2 - 24" X 12"  
**421 55** 2 - 24" X 24"  
**→ →** 2 - 21" X 15"

TWO "U" POSTS PER ASSEMBLY

507

**NORTH** 1 - 24" X 12"  
**INTERSTATE 95** 1 - 24" X 24"  
**↗** 1 - 21" X 15"

ONE "U" POST PER ASSEMBLY

514

**SOUTH NORTH** 2 - 24" X 12"  
**INTERSTATE 95 INTERSTATE 95** 2 - 24" X 24"  
**↑ →** 2 - 21" X 15"

TWO "U" POSTS PER ASSEMBLY

519

**NORTH WEST** 2 - 24" X 12"  
**421 55** 2 - 24" X 24"

TWO "U" POSTS PER ASSEMBLY

504

**NORTH** 1 - 24" X 12"  
**INTERSTATE 95** 1 - 24" X 24"  
**↗** 1 - 21" X 15"  
**TO TO** 2 - 24" X 12"  
**421 55** 2 - 24" X 24"  
**↗ ↗** 2 - 21" X 15"

TWO "U" POSTS PER ASSEMBLY

508

**SOUTH** 1 - 24" X 12"  
**INTERSTATE 95** 1 - 24" X 24"  
**↗** 1 - 21" X 15"

ONE "U" POST PER ASSEMBLY

515

**NORTH** 1 - 24" X 12"  
**INTERSTATE 95** 1 - 24" X 24"  
**←** 1 - 21" X 15"

ONE "U" POST PER ASSEMBLY

521

**NORTH** 1 - 30" X 15"  
**INTERSTATE 95** 1 - 36" X 36"

ONE "U" POST PER ASSEMBLY



509 517

**NORTH SOUTH** 2 - 24" X 12"  
**INTERSTATE 95 INTERSTATE 95** 2 - 24" X 24"  
**↑ ↗** 2 - 21" X 15"

TWO "U" POSTS PER ASSEMBLY

3/15/2021 15:03:15 986B\_Sgn\_Sign03A\_011419.dgn User:jlwendt

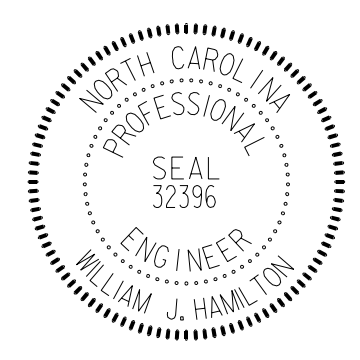
TYPE "F" SIGNS

|   |           |
|---|-----------|
| TIP NO.   | SHEET NO. |
| I-5878  | SIGN-4    |
| APPROVED: <i>William J. Hamilton</i><br>3/15/2021                                   |           |
| DATE: 3/15/2021   |           |
|  |           |
| <b>DOCUMENT NOT CONSIDERED FINAL<br/>UNLESS ALL SIGNATURES COMPLETED</b>            |           |
|  |           |
| 5808 Faringdon Place<br>Raleigh, North Carolina 27609<br>Phone: 919-872-5115        |           |
| NC License No. C-0910<br>www.rameykemp.com  |           |

| SIGN NUMBER: 1B<br>TYPE: A (OH)<br>QUANTITY: 1<br>SIGN WIDTH: 15'-0"<br>HEIGHT: 11'-0"<br>TOTAL AREA: 165.0 Sq.Ft.<br>BORDER TYPE: FLUSH<br>RECESS: 0"<br>WIDTH: 2"<br>RADII: 12"<br>NO. Z BARS: 3<br>LENGTH: 172.0 | BACKG COLOR: Green<br>COPY COLOR: White<br><table border="1"> <tr><th>SYMBOL</th><th>X</th><th>Y</th><th>WID</th><th>HT</th></tr> <tr><td>AR_Type A</td><td>133.6</td><td>52.2</td><td>22.2</td><td>35</td></tr> <tr><td>M1_4</td><td>18.9</td><td>49.2</td><td>45</td><td>36</td></tr> <tr><td>M1-5-2-36-15C</td><td>79.9</td><td>49.2</td><td>36</td><td>36</td></tr> </table> MAT'L: 0.125" (3.2 mm) ALUMINUM | SYMBOL | X    | Y  | WID | HT | AR_Type A | 133.6 | 52.2 | 22.2 | 35 | M1_4 | 18.9 | 49.2 | 45 | 36 | M1-5-2-36-15C | 79.9 | 49.2 | 36 | 36 | DESIGN BY: TSP<br>CHECKED BY: WJH<br>Jul 10, 2019<br>DIV: 6<br>PROJECT ID: I-5878 |
|---|--|--------|------|----|-----|----|-----------|-------|------|------|----|------|------|------|----|----|---------------|------|------|----|----|---|
| SYMBOL  | X  | Y      | WID  | HT |     |    |           |       |      |      |    |      |      |      |    |    |               |      |      |    |    |   |
| AR_Type A   | 133.6  | 52.2   | 22.2 | 35 |     |    |           |       |      |      |    |      |      |      |    |    |               |      |      |    |    |   |
| M1_4  | 18.9   | 49.2   | 45   | 36 |     |    |           |       |      |      |    |      |      |      |    |    |               |      |      |    |    |   |
| M1-5-2-36-15C   | 79.9   | 49.2   | 36   | 36 |     |    |           |       |      |      |    |      |      |      |    |    |               |      |      |    |    |   |

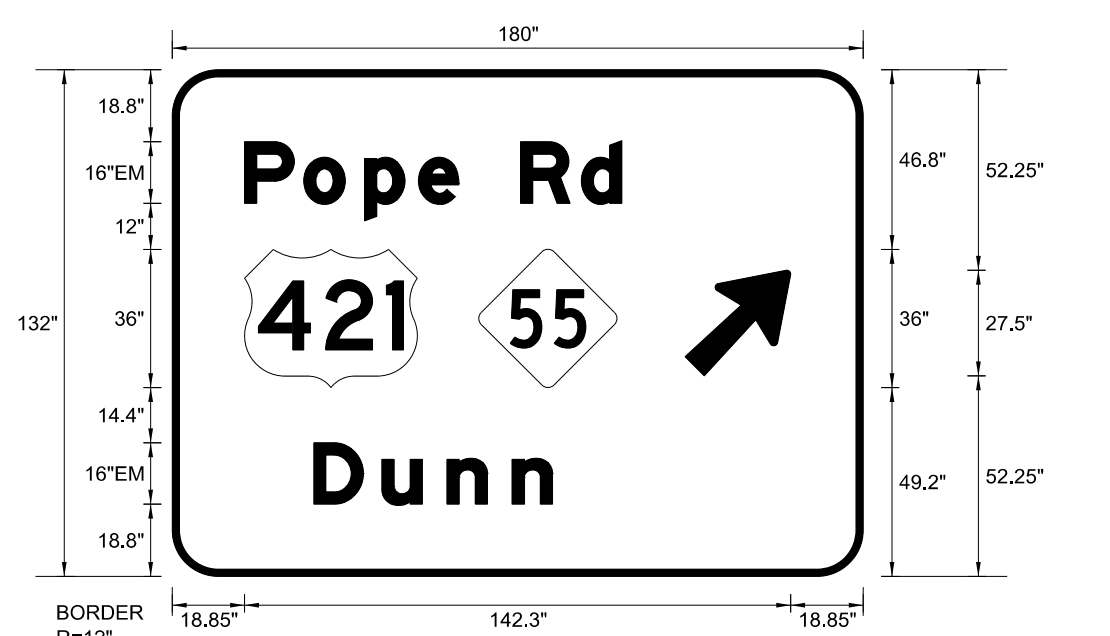

Spacing Factor is 1 unless specified otherwise

| Letter spacings are to start of next letter |      |      |      |      |      |    |      |      |      | Series/Size |
|---|------|------|------|------|------|----|------|------|------|-------------|
|   | P    | o    | p    | e    | R    | d  |      |      |      | Text Length |
|   | 18.9 | 15.4 | 15.8 | 14.1 | 10.6 | 16 | 15.8 | 10.6 | 62.9 | EM 2000     |
|   |      |      |      |      |      |    |      |      |      | 98.2        |
|   |      |      |      |      |      |    |      |      |      | EM 2000     |
|   |      |      |      |      |      |    |      |      |      | 62.2        |

NORTH CAROLINA D.O.T. SIGN DETAIL

FILENAME: 5878\_Sign Designs

| SIGN NUMBER: 2B<br>TYPE: A (OH)<br>QUANTITY: 1<br>SIGN WIDTH: 15'-0"<br>HEIGHT: 11'-0"<br>TOTAL AREA: 165.0 Sq.Ft.<br>BORDER TYPE: FLUSH<br>RECESS: 0"<br>WIDTH: 2"<br>RADII: 12"<br>NO. Z BARS: 3<br>LENGTH: 172.0 | BACKG COLOR: Green<br>COPY COLOR: White<br><table border="1"> <tr><th>SYMBOL</th><th>X</th><th>Y</th><th>WID</th><th>HT</th></tr> <tr><td>M1_4</td><td>18.9</td><td>77.2</td><td>45</td><td>36</td></tr> <tr><td>M1-5-2-36-15C</td><td>79.9</td><td>77.2</td><td>36</td><td>36</td></tr> <tr><td>AR_Type A</td><td>133.6</td><td>52.2</td><td>22.2</td><td>35</td></tr> </table> MAT'L: 0.125" (3.2 mm) ALUMINUM | SYMBOL | X    | Y  | WID | HT | M1_4 | 18.9 | 77.2 | 45 | 36 | M1-5-2-36-15C | 79.9 | 77.2 | 36 | 36 | AR_Type A | 133.6 | 52.2 | 22.2 | 35 | DESIGN BY: TSP<br>CHECKED BY: WJH<br>Nov 20, 2019<br>DIV: 6<br>PROJECT ID: I-5878 |
|---|--|--------|------|----|-----|----|------|------|------|----|----|---------------|------|------|----|----|-----------|-------|------|------|----|---|
| SYMBOL  | X  | Y      | WID  | HT |     |    |      |      |      |    |    |               |      |      |    |    |           |       |      |      |    |   |
| M1_4  | 18.9   | 77.2   | 45   | 36 |     |    |      |      |      |    |    |               |      |      |    |    |           |       |      |      |    |   |
| M1-5-2-36-15C   | 79.9   | 77.2   | 36   | 36 |     |    |      |      |      |    |    |               |      |      |    |    |           |       |      |      |    |   |
| AR_Type A   | 133.6  | 52.2   | 22.2 | 35 |     |    |      |      |      |    |    |               |      |      |    |    |           |       |      |      |    |   |

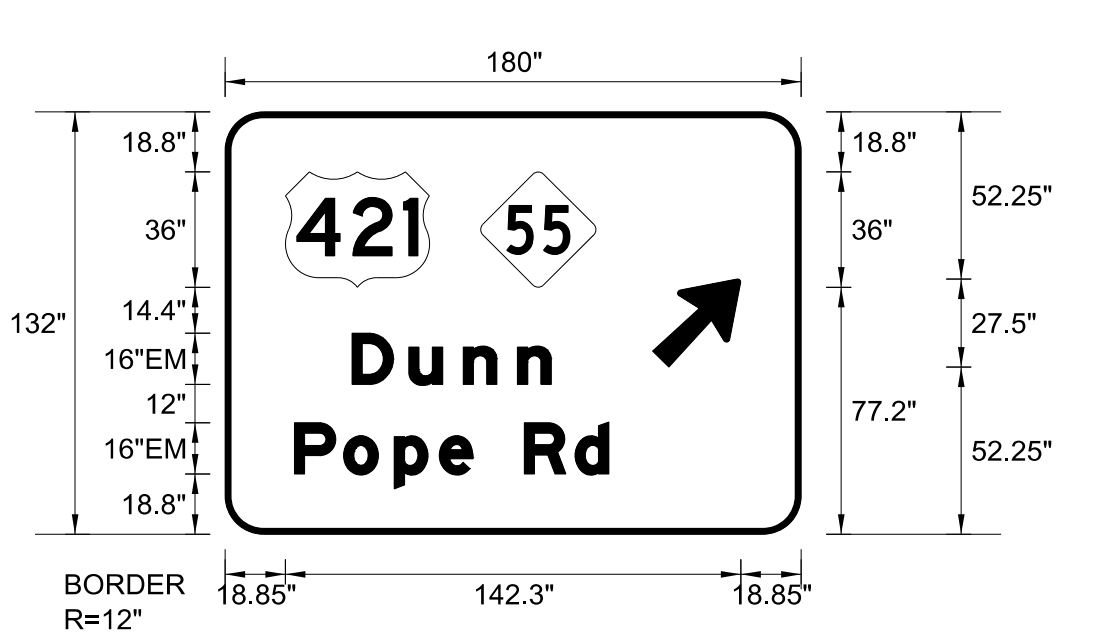

Spacing Factor is 1 unless specified otherwise

| Letter spacings are to start of next letter |      |      |    |    |      |      |   |   |   | Series/Size |             |
|---|------|------|----|----|------|------|---|---|---|-------------|-------------|
|   | D    | u    | n  | n  | P    | o    | p | e | R | d           | Text Length |
|   | 39.7 | 17.8 | 17 | 17 | 10.6 | 78.1 |   |   |   |             | EM 2000     |
|   |      |      |    |    |      |      |   |   |   |             | 62.2        |
|   |      |      |    |    |      |      |   |   |   |             | EM 2000     |
|   |      |      |    |    |      |      |   |   |   |             | 98.2        |

NORTH CAROLINA D.O.T. SIGN DETAIL

FILENAME: 5878\_Sign Designs

| SIGN NUMBER: 3B<br>TYPE: A (OH)<br>QUANTITY: 1<br>SIGN WIDTH: 17'-6"<br>HEIGHT: 6'-6"<br>TOTAL AREA: 113.8 Sq.Ft.<br>BORDER TYPE: FLUSH<br>RECESS: 0"<br>WIDTH: 2"<br>RADII: 12"<br>NO. Z BARS: 2<br>LENGTH: 202.0 | BACKG COLOR: Green<br>COPY COLOR: White<br><table border="1"> <tr><th>SYMBOL</th><th>X</th><th>Y</th><th>WID</th><th>HT</th></tr> </table> MAT'L: 0.125" (3.2 mm) ALUMINUM | SYMBOL | X   | Y  | WID | HT | DESIGN BY: TSP<br>CHECKED BY: WJH<br>Mar 05, 2020<br>DIV: 6<br>PROJECT ID: I-5878 |
|--|--|--------|-----|----|-----|----|---|
| SYMBOL   | X  | Y      | WID | HT |     |    |   |

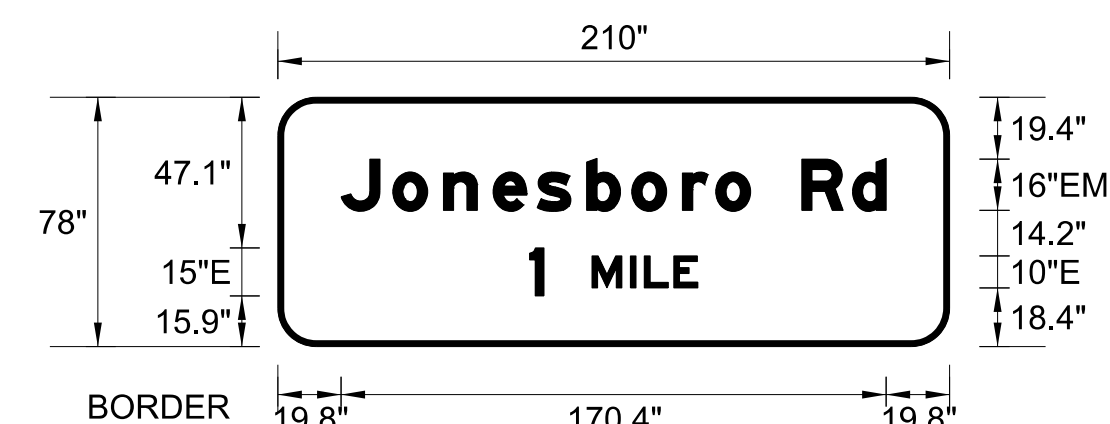

Spacing Factor is 1 unless specified otherwise

| Letter spacings are to start of next letter |      |      |      |      |      |      |      |      |      | Series/Size |    |             |      |      |         |
|---|------|------|------|------|------|------|------|------|------|-------------|----|-------------|------|------|---------|
|   | J    | o    | n    | e    | s    | b    | o    | r    | o    | R           | d  | Text Length |      |      |         |
|   | 19.8 | 16.2 | 15.8 | 15.5 | 13.8 | 15.5 | 14.1 | 15.8 | 10.4 | 10.9        | 16 | 15.8        | 10.6 | 19.8 | EM 2000 |
|   |      |      |      |      |      |      |      |      |      |             |    |             |      |      | 170.4   |
|   |      |      |      |      |      |      |      |      |      |             |    |             |      |      | E 2000  |
|   |      |      |      |      |      |      |      |      |      |             |    |             |      |      | 52.6    |

NORTH CAROLINA D.O.T. SIGN DETAIL

FILENAME: 5878\_Sign Designs

| SIGN NUMBER: 4B<br>TYPE: A (OH)<br>QUANTITY: 1<br>SIGN WIDTH: 11'-6"<br>HEIGHT: 13'-0"<br>TOTAL AREA: 149.5 Sq.Ft.<br>BORDER TYPE: FLUSH<br>RECESS: 0"<br>WIDTH: 2"<br>RADII: 12"<br>NO. Z BARS: 4<br>LENGTH: 130.0 | BACKG COLOR: Green<br>COPY COLOR: White<br><table border="1"> <tr><th>SYMBOL</th><th>X</th><th>Y</th><th>WID</th><th>HT</th></tr> <tr><td>M1_4</td><td>18.5</td><td>101.1</td><td>45</td><td>36</td></tr> <tr><td>M1-5-2-36-15C</td><td>83.5</td><td>101.1</td><td>36</td><td>36</td></tr> </table> MAT'L: 0.125" (3.2 mm) ALUMINUM | SYMBOL | X   | Y  | WID | HT | M1_4 | 18.5 | 101.1 | 45 | 36 | M1-5-2-36-15C | 83.5 | 101.1 | 36 | 36 | DESIGN BY: TSP<br>CHECKED BY: WJH<br>Feb 12, 2020<br>DIV: 6<br>PROJECT ID: I-5878 |
|---|---|--------|-----|----|-----|----|------|------|-------|----|----|---------------|------|-------|----|----|---|
| SYMBOL  | X   | Y      | WID | HT |     |    |      |      |       |    |    |               |      |       |    |    |   |
| M1_4  | 18.5  | 101.1  | 45  | 36 |     |    |      |      |       |    |    |               |      |       |    |    |   |
| M1-5-2-36-15C   | 83.5  | 101.1  | 36  | 36 |     |    |      |      |       |    |    |               |      |       |    |    |   |

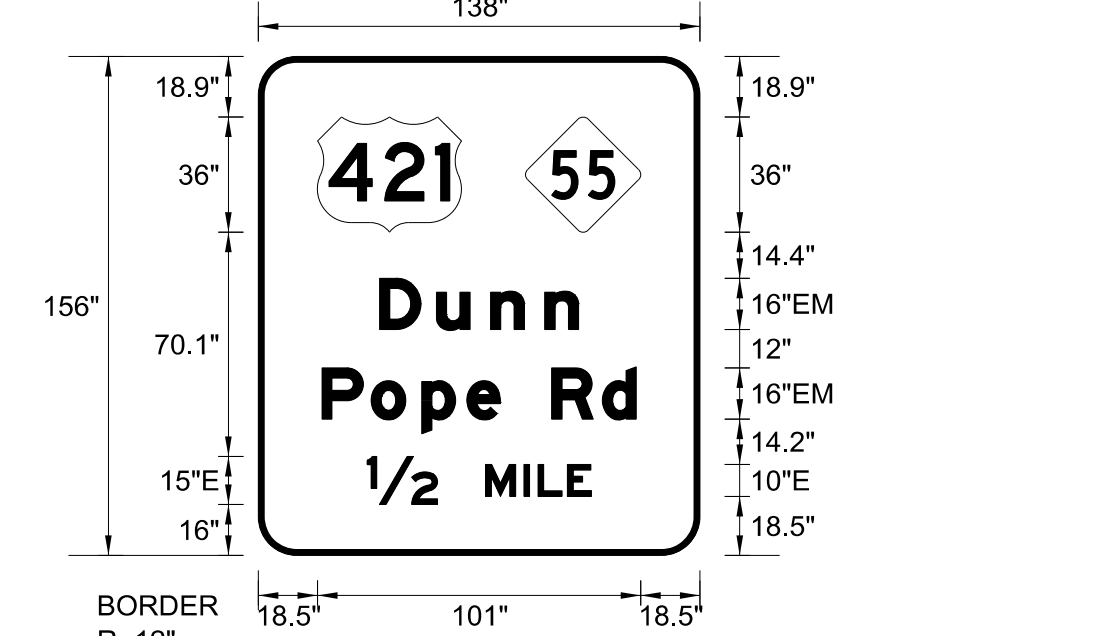

Spacing Factor is 1 unless specified otherwise

| Letter spacings are to start of next letter |      |      |    |    |      |      |   |   |   | Series/Size |             |
|---|------|------|----|----|------|------|---|---|---|-------------|-------------|
|   | D    | u    | n  | n  | P    | o    | p | e | R | d           | Text Length |
|   | 37.9 | 17.8 | 17 | 17 | 10.6 | 37.9 |   |   |   |             | EM 2000     |
|   |      |      |    |    |      |      |   |   |   |             | 62.2        |
|   |      |      |    |    |      |      |   |   |   |             | EM 2000     |
|   |      |      |    |    |      |      |   |   |   |             | 98.2        |
|   |      |      |    |    |      |      |   |   |   |             | E 2000      |
|   |      |      |    |    |      |      |   |   |   |             | 70.1        |

NORTH CAROLINA D.O.T. SIGN DETAIL

FILENAME: 5878\_Sign Designs

3/15/2021 15:38:66L\_Sgn-51gn04\_011419.dgn  
 User: jwendt

APPROVED: *William J. Hamilton*  
ASSOCIATE ENGINEER  
 DATE: 3/15/2021

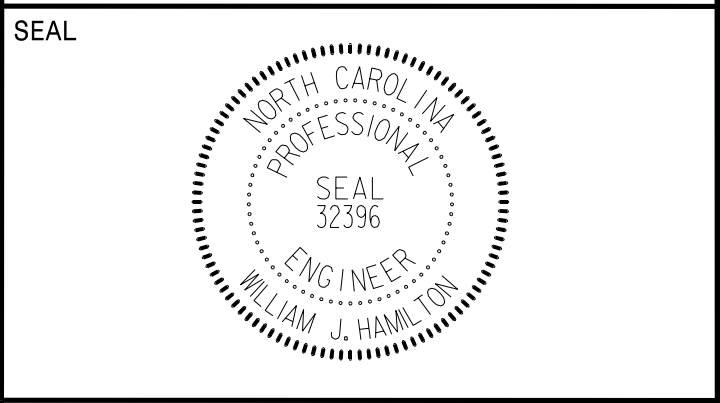

**DOCUMENT NOT CONSIDERED FINAL  
 UNLESS ALL SIGNATURES COMPLETED**



|  |   |   |
|--|---|---|
| SIGN NUMBER: 58<br>TYPE: A (OH)<br>QUANTITY: 1<br>SIGN WIDTH: 17'-6"<br>HEIGHT: 6'-6"<br>TOTAL AREA: 113.8 Sq.Ft.<br>BORDER TYPE: FLUSH<br>RECESS: 0"<br>WIDTH: 2"<br>RADII: 12"<br>NO. Z BARS: 2<br>LENGTH: 202.0 | BACKG COLOR: Green<br>COPY COLOR: White<br>SYMBOl: [Table with columns X, Y, WID, HT] | DESIGN BY: TSP<br>CHECKED BY: WJH<br>Mar 05, 2020<br>PROJECT ID: I-5878<br>DIV: 6 |
|--|---|---|

Spacing Factor is 1 unless specified otherwise

| Letter spacings are to start of next letter |      |      |      |      |      |      |      |      |      |    |      |      |      |  | Series/Size |
|---|------|------|------|------|------|------|------|------|------|----|------|------|------|--|-------------|
|   |      |      |      |      |      |      |      |      |      |    |      |      |      |  | Text Length |
| 19.8  | 16.2 | 15.8 | 15.5 | 13.8 | 15.5 | 14.1 | 15.8 | 10.4 | 10.9 | 16 | 15.8 | 10.6 | 19.8 |  | EM 2000     |
|   |      |      |      |      |      |      |      |      |      |    |      |      |      |  | 170.4       |
|   |      |      |      |      |      |      |      |      |      |    |      |      |      |  | E 2000      |
|   |      |      |      |      |      |      |      |      |      |    |      |      |      |  | 70.1        |

FILENAME: 5878\_Sign Designs NORTH CAROLINA D.O.T. SIGN DETAIL

|   |   |   |
|---|---|---|
| SIGN NUMBER: 101.106<br>TYPE: A<br>QUANTITY: 2<br>SIGN WIDTH: 16'-0"<br>HEIGHT: 5'-6"<br>TOTAL AREA: 88.0 Sq.Ft.<br>BORDER TYPE: FLUSH<br>RECESS: 0"<br>WIDTH: 2"<br>RADII: 12"<br>NO. Z BARS: 2<br>LENGTH: 184.0 | BACKG COLOR: Green<br>COPY COLOR: White<br>SYMBOl: [Table with columns X, Y, WID, HT] | DESIGN BY: TSP<br>CHECKED BY: WJH<br>Mar 02, 2020<br>PROJECT ID: I-5878<br>DIV: 6 |
|---|---|---|

Spacing Factor is 1 unless specified otherwise

| Letter spacings are to start of next letter |      |      |      |    |      |    |   |     |      |      |      |     |      |      | Series/Size |
|---|------|------|------|----|------|----|---|-----|------|------|------|-----|------|------|-------------|
|   |      |      |      |    |      |    |   |     |      |      |      |     |      |      | Text Length |
| 17.9  | 13.4 | 14.2 | 20.1 | 13 | 11.8 | 13 | 8 | 2.7 | 13.4 | 15.4 | 14.2 | 6.6 | 10.3 | 17.9 | EM 2000     |
|   |      |      |      |    |      |    |   |     |      |      |      |     |      |      | 156.1       |
|   |      |      |      |    |      |    |   |     |      |      |      |     |      |      | E 2000      |
|   |      |      |      |    |      |    |   |     |      |      |      |     |      |      | 67.1        |

FILENAME: 5878\_Sign Designs NORTH CAROLINA D.O.T. SIGN DETAIL

|   |   |   |
|---|---|---|
| SIGN NUMBER: 102<br>TYPE: A<br>QUANTITY: 1<br>SIGN WIDTH: 12'-0"<br>HEIGHT: 7'-6"<br>TOTAL AREA: 90.0 Sq.Ft.<br>BORDER TYPE: FLUSH<br>RECESS: 0"<br>WIDTH: 2"<br>RADII: 12"<br>NO. Z BARS: 3<br>LENGTH: 136.0 | BACKG COLOR: Green<br>COPY COLOR: White<br>SYMBOl: [Table with columns X, Y, WID, HT] | DESIGN BY: TSP<br>CHECKED BY: WJH<br>Feb 12, 2020<br>PROJECT ID: I-5878<br>DIV: 6 |
|---|---|---|

Spacing Factor is 1 unless specified otherwise

| Letter spacings are to start of next letter |     |   |     |     |     |     |     |   |     |     |     |     |   |     | Series/Size |      |        |
|---|-----|---|-----|-----|-----|-----|-----|---|-----|-----|-----|-----|---|-----|-------------|------|--------|
|   |     |   |     |     |     |     |     |   |     |     |     |     |   |     | Text Length |      |        |
| 39.3  | 3.7 | 6 | 5.2 | 4.7 | 7.1 | 4.3 | 4.4 | 3 | 1.9 | 4.6 | 4.4 | 3.6 | 6 | 4.4 | 2.4         | 38.9 | D 2000 |
|   |     |   |     |     |     |     |     |   |     |     |     |     |   |     |             |      | 65.8   |
|   |     |   |     |     |     |     |     |   |     |     |     |     |   |     |             |      | D 2000 |
|   |     |   |     |     |     |     |     |   |     |     |     |     |   |     |             |      | 22.7   |
|   |     |   |     |     |     |     |     |   |     |     |     |     |   |     |             |      | D 2000 |
|   |     |   |     |     |     |     |     |   |     |     |     |     |   |     |             |      | 22.7   |
|   |     |   |     |     |     |     |     |   |     |     |     |     |   |     |             |      | D 2000 |
|   |     |   |     |     |     |     |     |   |     |     |     |     |   |     |             |      | 38.9   |
|   |     |   |     |     |     |     |     |   |     |     |     |     |   |     |             |      | D 2000 |
|   |     |   |     |     |     |     |     |   |     |     |     |     |   |     |             |      | 38.9   |
|   |     |   |     |     |     |     |     |   |     |     |     |     |   |     |             |      | D 2000 |
|   |     |   |     |     |     |     |     |   |     |     |     |     |   |     |             |      | 20.1   |
|   |     |   |     |     |     |     |     |   |     |     |     |     |   |     |             |      | D 2000 |
|   |     |   |     |     |     |     |     |   |     |     |     |     |   |     |             |      | 18.8   |
|   |     |   |     |     |     |     |     |   |     |     |     |     |   |     |             |      | D 2000 |
|   |     |   |     |     |     |     |     |   |     |     |     |     |   |     |             |      | 20.1   |

FILENAME: 5878\_Sign Designs NORTH CAROLINA D.O.T. SIGN DETAIL

|   |   |   |
|---|---|---|
| SIGN NUMBER: 103<br>TYPE: A<br>QUANTITY: 1<br>SIGN WIDTH: 12'-0"<br>HEIGHT: 6'-6"<br>TOTAL AREA: 78.0 Sq.Ft.<br>BORDER TYPE: FLUSH<br>RECESS: 0"<br>WIDTH: 2"<br>RADII: 12"<br>NO. Z BARS: 2<br>LENGTH: 136.0 | BACKG COLOR: Green<br>COPY COLOR: White<br>SYMBOl: [Table with columns X, Y, WID, HT] | DESIGN BY: TSP<br>CHECKED BY: WJH<br>Feb 12, 2020<br>PROJECT ID: I-5878<br>DIV: 6 |
|---|---|---|

Spacing Factor is 1 unless specified otherwise

| Letter spacings are to start of next letter |   |     |   |     |     |      |  |  |  |  |  |  |  |  | Series/Size |  |        |
|---|---|-----|---|-----|-----|------|--|--|--|--|--|--|--|--|-------------|--|--------|
|   |   |     |   |     |     |      |  |  |  |  |  |  |  |  | Text Length |  |        |
| 75.1  | 5 | 5.6 | 5 | 4.6 | 4.1 | 44.7 |  |  |  |  |  |  |  |  |             |  | D 2000 |
|   |   |     |   |     |     |      |  |  |  |  |  |  |  |  |             |  | 24.2   |
|   |   |     |   |     |     |      |  |  |  |  |  |  |  |  |             |  | D 2000 |
|   |   |     |   |     |     |      |  |  |  |  |  |  |  |  |             |  | 22.7   |
|   |   |     |   |     |     |      |  |  |  |  |  |  |  |  |             |  | D 2000 |
|   |   |     |   |     |     |      |  |  |  |  |  |  |  |  |             |  | 22.7   |
|   |   |     |   |     |     |      |  |  |  |  |  |  |  |  |             |  | D 2000 |
|   |   |     |   |     |     |      |  |  |  |  |  |  |  |  |             |  | 38.9   |
|   |   |     |   |     |     |      |  |  |  |  |  |  |  |  |             |  | D 2000 |
|   |   |     |   |     |     |      |  |  |  |  |  |  |  |  |             |  | 38.9   |
|   |   |     |   |     |     |      |  |  |  |  |  |  |  |  |             |  | D 2000 |
|   |   |     |   |     |     |      |  |  |  |  |  |  |  |  |             |  | 20.1   |
|   |   |     |   |     |     |      |  |  |  |  |  |  |  |  |             |  | D 2000 |
|   |   |     |   |     |     |      |  |  |  |  |  |  |  |  |             |  | 18.8   |

FILENAME: 5878\_Sign Designs NORTH CAROLINA D.O.T. SIGN DETAIL

3/15/2021  
 250\_011\_15986B\_Sgn\_Sign04A\_011419.dgn  
 User: jwendt

APPROVED: *William J. Hamilton*  
DATE: 3/15/2021



DOCUMENT NOT CONSIDERED FINAL  
UNLESS ALL SIGNATURES COMPLETED



**SIGN NUMBER: 104**      **BACKG COLOR: Green**      **DESIGN BY: TSP**      **CHECKED BY: WJH**      **Feb 12, 2020**  
**TYPE: A**      **COPY COLOR: White**      **PROJECT ID: I-5878**      **DIV: 6**

| SYMBOL    | X    | Y    | WID  | HT |
|-----------|------|------|------|----|
| M_1       | 45   | 38.3 | 24   | 24 |
| AR_Type A | 10.8 | 21   | 18.3 | 30 |

QUANTITY: 1  
SIGN WIDTH: 12'-0"  
HEIGHT: 6'-0"  
TOTAL AREA: 72.0 Sq.Ft.

**BORDER TYPE: FLUSH**  
RECESS: 0"  
WIDTH: 2"  
RADIUS: 12"

NO. Z BARS: 2  
LENGTH: 136.0

MAT'L: 0.125" (3.2 mm) ALUMINUM

USE NOTES: 1, 2, 3

- Legend and border(except those that are colored black) shall be direct applied Grade C sheeting.
- Background shall be Grade C reflective sheeting.
- Shields; A, B, and C type arrows shall be on 0.032" (0.8mm) aluminum with Grade C reflective sheeting and demountable.

Spacing Factor is 1 unless specified otherwise

**LETTER POSITIONS**

| Letter spacings are to start of next letter |      |     |      |      |      |     |      |  |  | Series/Size | Text Length |         |      |
|---|------|-----|------|------|------|-----|------|--|--|-------------|-------------|---------|------|
|   | N    | O   | R    | T    | H    |     |      |  |  |             |             |         |      |
| 84  | 9.7  | 2.3 | 10.7 | 9.2  | 9.2  | 8.1 | 10.8 |  |  |             |             | E 2000  | 49.2 |
|   | B    | e   | n    | s    | o    | n   |      |  |  |             |             | EM 2000 | 73   |
| 52.6  | 13.4 | 13  | 12.7 | 11.8 | 13.3 | 8.8 | 18.4 |  |  |             |             |         |      |

FILENAME: 5878\_Sign Designs      NORTH CAROLINA D.O.T. SIGN DETAIL

**SIGN NUMBER: 105**      **BACKG COLOR: Green**      **DESIGN BY: TSP**      **CHECKED BY: WJH**      **Nov 20, 2019**  
**TYPE: A**      **COPY COLOR: White**      **PROJECT ID: I-5878**      **DIV: 6**

| SYMBOL    | X    | Y  | WID  | HT |
|-----------|------|----|------|----|
| AR_Type A | 12.3 | 12 | 18.3 | 30 |

QUANTITY: 1  
SIGN WIDTH: 11'-6"  
HEIGHT: 4'-6"  
TOTAL AREA: 51.8 Sq.Ft.

**BORDER TYPE: FLUSH**  
RECESS: 0"  
WIDTH: 2"  
RADIUS: 12"

NO. Z BARS: 2  
LENGTH: 130.0

MAT'L: 0.125" (3.2 mm) ALUMINUM

USE NOTES: 1, 2, 3

- Legend and border(except those that are colored black) shall be direct applied Grade C sheeting.
- Background shall be Grade C reflective sheeting.
- Shields; A, B, and C type arrows shall be on 0.032" (0.8mm) aluminum with Grade C reflective sheeting and demountable.

Spacing Factor is 1 unless specified otherwise

**LETTER POSITIONS**

| Letter spacings are to start of next letter |      |      |      |     |      |      |     |      |  | Series/Size | Text Length |         |      |
|---|------|------|------|-----|------|------|-----|------|--|-------------|-------------|---------|------|
|   | P    | o    | p    | e   | R    | d    |     |      |  |             |             |         |      |
| 43.9  | 12.8 | 13.2 | 11.7 | 8.8 | 13.3 | 13.2 | 8.8 | 12.3 |  |             |             | EM 2000 | 81.8 |

FILENAME: 5878\_Sign Designs      NORTH CAROLINA D.O.T. SIGN DETAIL

**SIGN NUMBER: 201,202**      **BACKG COLOR: Green**      **DESIGN BY: TSP**      **CHECKED BY: WJH**      **Jul 10, 2019**  
**TYPE: A**      **COPY COLOR: White**      **PROJECT ID: I-5878**      **DIV: 6**

| SYMBOL    | X    | Y | WID  | HT   |
|-----------|------|---|------|------|
| AR_Type A | 49.8 | 7 | 17.9 | 28.2 |

QUANTITY: 2  
SIGN WIDTH: 6'-6"  
HEIGHT: 5'-0"  
TOTAL AREA: 32.5 Sq.Ft.

**BORDER TYPE: FLUSH**  
RECESS: 0"  
WIDTH: 1.5"  
RADIUS: 6"

NO. Z BARS: 2  
LENGTH: 70.0

MAT'L: 0.125" (3.2 mm) ALUMINUM

USE NOTES: 1, 2

- Legend and border(except those that are colored black) shall be direct applied Grade C sheeting.
- Background shall be Grade C reflective sheeting.
- Shields; A, B, and C type arrows shall be on 0.032" (0.8mm) aluminum and demountable.

Spacing Factor is 2.25 for 'EXIT'  
Spacing Factor is 1 unless specified otherwise

**LETTER POSITIONS**

| Letter spacings are to start of next letter |      |      |      |   |      |  | Series/Size | Text Length |      |
|---|------|------|------|---|------|--|-------------|-------------|------|
|   | E    | X    | I    | T |      |  |             |             |      |
| 16.8  | 12.8 | 15.9 | 6.8  | 9 | 16.8 |  |             | E 2000      | 44.4 |
|   | 7    | 3    |      |   |      |  |             | E 2000      | 32.2 |
| 8   | 17.6 | 14.6 | 37.8 |   |      |  |             |             |      |

FILENAME: 5878\_Sign Designs      NORTH CAROLINA D.O.T. SIGN DETAIL

**SIGN NUMBER: 1A,2A,4A**      **BACKG COLOR: Green**      **DESIGN BY: TSP**      **CHECKED BY: WJH**      **Jan 07, 2019**  
**TYPE: B**      **COPY COLOR: White**      **PROJECT ID: I-5878**      **DIV: 6**

| SYMBOL | X | Y | WID | HT |
|--------|---|---|-----|----|
|        |   |   |     |    |

QUANTITY: 3  
SIGN WIDTH: 9'-6"  
HEIGHT: 2'-6"  
TOTAL AREA: 23.8 Sq.Ft.

**BORDER TYPE: FLUSH**  
RECESS: 0"  
WIDTH: 0.75"  
RADIUS: 6"

NO. Z BARS: 2  
LENGTH: 106.0

MAT'L: 0.125" (3.2 mm) ALUMINUM

USE NOTES: 1, 2

- Legend and border(except those that are colored black) shall be direct applied Grade C sheeting.
- Background shall be Grade C reflective sheeting.

Spacing Factor is 1.2 for 'EXITS'  
Spacing Factor is 1 unless specified otherwise

**LETTER POSITIONS**

| Letter locations are panel edge to lower left corner |      |      |      |     |      |  | Series/Size | Text Length |      |
|--|------|------|------|-----|------|--|-------------|-------------|------|
|  | E    | X    | I    | T   |      |  |             |             |      |
| 21.5   | 9.2  | 11.1 | 3.8  | 7.5 | 60.9 |  |             | E 2000      | 31.6 |
|  | 7    | 3    |      |     |      |  |             | E 2000      | 26.9 |
| 65.6   | 14.7 | 12.1 | 21.5 |     |      |  |             |             |      |

FILENAME: 5878\_Sign Designs      NORTH CAROLINA D.O.T. SIGN DETAIL

3/15/2021 10:25:00 AM C:\Users\jwendt\Documents\3152021\159866B\_Sgn-Sign04B\_011419.dgn User: jwendt

APPROVED: *William J. Hamilton*  
REGISTERED PROFESSIONAL ENGINEER  
 DATE: 3/15/2021

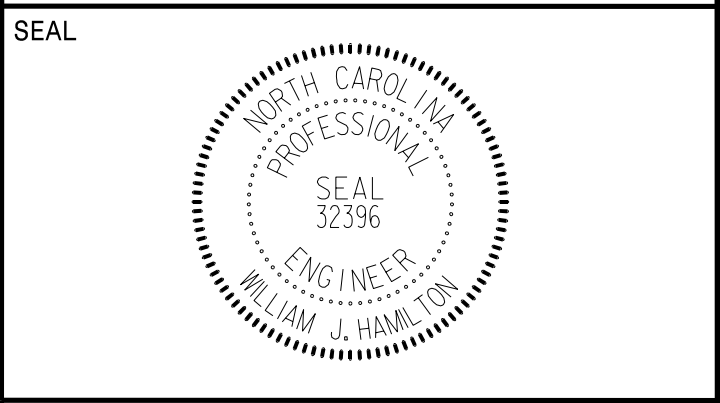

**DOCUMENT NOT CONSIDERED FINAL  
 UNLESS ALL SIGNATURES COMPLETED**



|  |   |   |
|--|---|---|
| SIGN NUMBER: <b>302,318</b><br>TYPE: B<br>QUANTITY: 2<br>SIGN WIDTH: 9'-6"<br>HEIGHT: 2'-6"<br>TOTAL AREA: 23.8 Sq.Ft.<br>BORDER TYPE: FLUSH<br>RECESS: 0"<br>WIDTH: 2"<br>RADII: 3"<br>NO. Z BARS: 2<br>LENGTH: 106.0 | BACKG COLOR: Green<br>COPY COLOR: White<br>SYMBOL TABLE<br>MAT'L: 0.125" ALUMINUM | DESIGN BY: TSP<br>CHECKED BY: WJH<br>Apr 25, 2019<br>PROJECT ID: I-5878<br>DIV: 6 |
|--|---|---|

USE NOTES: 1, 2  
 1. Legend and border(except those that are colored black) shall be direct applied Grade A sheeting.  
 2. Background shall be Grade C reflective sheeting.

Spacing Factor is 1.2 for "EXIT"  
 Spacing Factor is 1 unless specified otherwise

| Letter spacings are to start of next letter |      |      |      |      |      |  |  |  |  | Series/Size |
|---|------|------|------|------|------|--|--|--|--|-------------|
|   |      |      |      |      |      |  |  |  |  | Text Length |
| E   | X    | I    | T    |      |      |  |  |  |  | E 2000      |
| 20.3  | 9.2  | 11.1 | 3.8  | 7.5  | 62.1 |  |  |  |  | 31.6        |
|   | 7    | 5    |      |      |      |  |  |  |  | E 2000      |
|   | 66.9 | 14.7 | 12.2 | 20.3 |      |  |  |  |  | 26.9        |

FILENAME: Tim Sign Designs NORTH CAROLINA D.O.T. SIGN DETAIL

|   |  |   |
|---|--|---|
| SIGN NUMBER: <b>301,304,317</b><br>TYPE: D<br>QUANTITY: 3<br>SIGN WIDTH: 5'-6"<br>HEIGHT: 2'-0"<br>TOTAL AREA: 11.0 Sq.Ft.<br>BORDER TYPE: FLUSH<br>RECESS: 0"<br>WIDTH: 0.75"<br>RADII: 3"<br>NO. Z BARS: 2<br>LENGTH: | BACKG COLOR: Green<br>COPY COLOR: White<br>SYMBOL TABLE<br>MAT'L: 0.125" (3.2 mm) ALUMINUM | DESIGN BY: TSP<br>CHECKED BY: WJH<br>Feb 12, 2020<br>PROJECT ID: I-5878<br>DIV: 6 |
|---|--|---|

USE NOTES: 1, 2  
 1. Legend and border(except those that are colored black) shall be direct applied Grade C sheeting.  
 2. Background shall be Grade C reflective sheeting.

Spacing Factor is 1 unless specified otherwise

| Letter spacings are to start of next letter |      |     |     |     |     |     |     |     |     | Series/Size |
|---|------|-----|-----|-----|-----|-----|-----|-----|-----|-------------|
|   |      |     |     |     |     |     |     |     |     | Text Length |
| W   | e    | l   | c   | o   | m   | e   | T   | o   |     | EM 2000     |
| 5.4   | 7.3  | 5.8 | 3.1 | 5.3 | 5.9 | 8.5 | 4   | 6   | 5.3 | 55.2        |
|   | D    | U   | N   | N   |     |     |     |     |     | E 2000      |
|   | 21   | 6.2 | 6.4 | 6.4 | 4.9 | 21  |     |     |     | 23.9        |
|   | C    | I   | T   | Y   | L   | I   | M   | I   | T   | D 2000      |
|   | 19.3 | 3.6 | 1.2 | 2.7 | 3.4 | 4   | 3.1 | 1.6 | 4.1 | 27.5        |

FILENAME: 5878\_Sign Designs NORTH CAROLINA D.O.T. SIGN DETAIL

|  |  |   |
|--|--|---|
| SIGN NUMBER: <b>302,318</b><br>TYPE: D<br>QUANTITY: 2<br>SIGN WIDTH: 4'-6"<br>HEIGHT: 1'-0"<br>TOTAL AREA: 4.5 Sq.Ft.<br>BORDER TYPE: FLUSH<br>RECESS: 0"<br>WIDTH: 0.75"<br>RADII: 3"<br>NO. Z BARS: 2<br>LENGTH: | BACKG COLOR: Green<br>COPY COLOR: White<br>SYMBOL TABLE<br>MAT'L: 0.125" (3.2 mm) ALUMINUM | DESIGN BY: TSP<br>CHECKED BY: WJH<br>Feb 12, 2020<br>PROJECT ID: I-5878<br>DIV: 6 |
|--|--|---|

USE NOTES: 1, 2  
 1. Legend and border(except those that are colored black) shall be direct applied Grade C sheeting.  
 2. Background shall be Grade C reflective sheeting.

Spacing Factor is 1 unless specified otherwise

| Letter spacings are to start of next letter |     |     |     |     |   |   |   |     |     | Series/Size |
|---|-----|-----|-----|-----|---|---|---|-----|-----|-------------|
|   |     |     |     |     |   |   |   |     |     | Text Length |
| B   | I   | R   | D   | S   | A | N | C | T   | U   | D 2000      |
| 4.1   | 3.4 | 1.6 | 3.4 | 2.7 | 4 | 3 | 4 | 3.6 | 3.2 | 45.9        |
|   |     |     |     |     |   |   |   |     |     |             |
|   |     |     |     |     |   |   |   |     |     |             |

FILENAME: 5878\_Sign Designs NORTH CAROLINA D.O.T. SIGN DETAIL

|   |  |   |
|---|--|---|
| SIGN NUMBER: <b>303</b><br>TYPE: D<br>QUANTITY: 1<br>SIGN WIDTH: 5'-0"<br>HEIGHT: 2'-0"<br>TOTAL AREA: 10.0 Sq.Ft.<br>BORDER TYPE: FLUSH<br>RECESS: 0"<br>WIDTH: 0.75"<br>RADII: 3"<br>NO. Z BARS: 2<br>LENGTH: | BACKG COLOR: Green<br>COPY COLOR: White<br>SYMBOL TABLE<br>MAT'L: 0.125" (3.2 mm) ALUMINUM | DESIGN BY: TSP<br>CHECKED BY: WJH<br>Dec 16, 2019<br>PROJECT ID: I-5878<br>DIV: 6 |
|---|--|---|

USE NOTES: 1, 2  
 1. Legend and border(except those that are colored black) shall be direct applied Grade C sheeting.  
 2. Background shall be Grade C reflective sheeting.

Spacing Factor is 1 unless specified otherwise

| Letter spacings are to start of next letter |      |     |     |     |     |      |     |   |      | Series/Size |
|---|------|-----|-----|-----|-----|------|-----|---|------|-------------|
|   |      |     |     |     |     |      |     |   |      | Text Length |
| C   | a    | m   | p   | b   | e   | l    | i   |   |      | D 2000      |
| 6.7   | 5    | 4.6 | 7.1 | 4.6 | 4.3 | 4.4  | 2.2 | 1 | 20.3 | 33          |
|   | U    | n   | i   | v   |     |      |     |   |      | D 2000      |
|   | 15.2 | 5.4 | 4.7 | 1.7 | 4.3 | 28.7 |     |   |      | 16          |

FILENAME: 5878\_Sign Designs NORTH CAROLINA D.O.T. SIGN DETAIL

3/15/2021 10:13:15 AM 159866L\_Sgn-5\_sgn04C\_011419.dgn User: jwendt

SIGN DESIGNS



APPROVED: *William J. Hamilton*  
AS00071046484  
 DATE: 3/15/2021

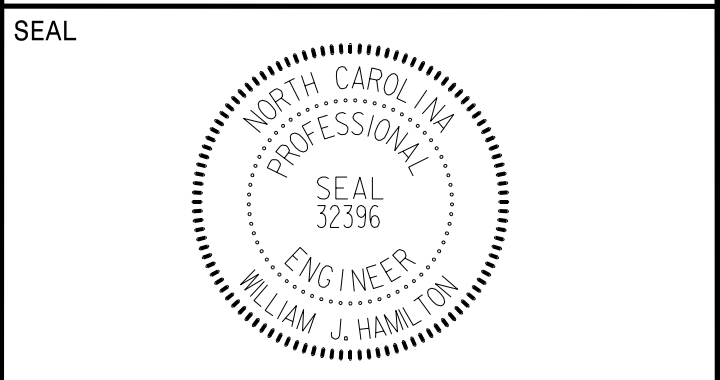

**DOCUMENT NOT CONSIDERED FINAL  
 UNLESS ALL SIGNATURES COMPLETED**



| SIGN NUMBER: 316<br>TYPE: D<br>QUANTITY: 1<br>SIGN WIDTH: 5'-0"<br>HEIGHT: 2'-0"<br>TOTAL AREA: 10.0 Sq.Ft.<br>BORDER TYPE: FLUSH<br>RECESS: 0"<br>WIDTH: 0.75"<br>RADII: 3"<br>NO. Z BARS:<br>LENGTH: | BACKG COLOR: Green<br>COPY COLOR: White<br>SYMBOL<br><table border="1"> <tr> <th>SYMBOL</th> <th>X</th> <th>Y</th> <th>WID</th> <th>HT</th> </tr> <tr> <td>AR_Type D</td> <td>45.8</td> <td>9</td> <td>6</td> <td>9</td> </tr> </table> MAT'L: 0.125" (3.2 mm) ALUMINUM | SYMBOL | X   | Y  | WID | HT | AR_Type D | 45.8 | 9 | 6 | 9 | DESIGN BY: TSP<br>CHECKED BY: WJH<br>Dec 16, 2019<br>PROJECT ID: I-5878<br>DIV: 6 |
|--|---|--------|-----|----|-----|----|-----------|------|---|---|---|---|
| SYMBOL   | X   | Y      | WID | HT |     |    |           |      |   |   |   |   |
| AR_Type D  | 45.8  | 9      | 6   | 9  |     |    |           |      |   |   |   |   |

USE NOTES: 1, 2  
 1. Legend and border(except those that are colored black) shall be direct applied Grade C sheeting.  
 2. Background shall be Grade C reflective sheeting.

Spacing Factor is 1 unless specified otherwise

| Letter spacings are to start of next letter |     |     |     |     |      |     |     |   |      |  | Series/Size |
|---|-----|-----|-----|-----|------|-----|-----|---|------|--|-------------|
|   |     |     |     |     |      |     |     |   |      |  | Text Length |
| 5.2   | 5   | 4.6 | 7.1 | 4.6 | 4.3  | 4.4 | 2.2 | 1 | 21.8 |  | D 2000      |
|   |     |     |     |     |      |     |     |   |      |  | 33          |
|   |     |     |     |     |      |     |     |   |      |  | D 2000      |
| 13.7  | 5.4 | 4.7 | 1.7 | 4.3 | 30.2 |     |     |   |      |  | 16          |

FILENAME: 5878\_Sign Designs NORTH CAROLINA D.O.T. SIGN DETAIL

| SIGN NUMBER: 310<br>TYPE: D<br>QUANTITY: 1<br>SIGN WIDTH: 5'-0"<br>HEIGHT: 2'-0"<br>TOTAL AREA: 10.0 Sq.Ft.<br>BORDER TYPE: FLUSH<br>RECESS: 0"<br>WIDTH: 0.75"<br>RADII: 3"<br>NO. Z BARS:<br>LENGTH: | BACKG COLOR: Green<br>COPY COLOR: White<br>SYMBOL<br><table border="1"> <tr> <th>SYMBOL</th> <th>X</th> <th>Y</th> <th>WID</th> <th>HT</th> </tr> <tr> <td>AR_Type D</td> <td>5.3</td> <td>9</td> <td>6</td> <td>9</td> </tr> </table> MAT'L: 0.125" (3.2 mm) ALUMINUM | SYMBOL | X   | Y  | WID | HT | AR_Type D | 5.3 | 9 | 6 | 9 | DESIGN BY: TSP<br>CHECKED BY: WJH<br>Dec 16, 2019<br>PROJECT ID: I-5878<br>DIV: 6 |
|--|--|--------|-----|----|-----|----|-----------|-----|---|---|---|---|
| SYMBOL   | X  | Y      | WID | HT |     |    |           |     |   |   |   |   |
| AR_Type D  | 5.3  | 9      | 6   | 9  |     |    |           |     |   |   |   |   |

USE NOTES: 1, 2  
 1. Legend and border(except those that are colored black) shall be direct applied Grade C sheeting.  
 2. Background shall be Grade C reflective sheeting.

Spacing Factor is 1 unless specified otherwise

| Letter spacings are to start of next letter |     |     |     |     |      |     |     |   |     |  | Series/Size |
|---|-----|-----|-----|-----|------|-----|-----|---|-----|--|-------------|
|   |     |     |     |     |      |     |     |   |     |  | Text Length |
| 21.8  | 5   | 4.6 | 7.1 | 4.6 | 4.3  | 4.4 | 2.2 | 1 | 5.3 |  | D 2000      |
|   |     |     |     |     |      |     |     |   |     |  | 33          |
|   |     |     |     |     |      |     |     |   |     |  | D 2000      |
| 30.2  | 5.4 | 4.7 | 1.7 | 4.3 | 13.7 |     |     |   |     |  | 16          |

FILENAME: 5878\_Sign Designs NORTH CAROLINA D.O.T. SIGN DETAIL

| SIGN NUMBER: 305,314<br>TYPE: D<br>QUANTITY: 2<br>SIGN WIDTH: 6'-0"<br>HEIGHT: 2'-6"<br>TOTAL AREA: 15.0 Sq.Ft.<br>BORDER TYPE: FLUSH<br>RECESS: 0"<br>WIDTH: 0.75"<br>RADII: 3"<br>NO. Z BARS:<br>LENGTH: | BACKG COLOR: Green<br>COPY COLOR: White<br>SYMBOL<br><table border="1"> <tr> <th>SYMBOL</th> <th>X</th> <th>Y</th> <th>WID</th> <th>HT</th> </tr> <tr> <td>AR_Type D</td> <td>20</td> <td>17.8</td> <td>6</td> <td>9</td> </tr> <tr> <td>AR_Type D</td> <td>55.1</td> <td>4.7</td> <td>6</td> <td>9</td> </tr> </table> MAT'L: 0.125" (3.2 mm) ALUMINUM | SYMBOL | X   | Y  | WID | HT | AR_Type D | 20 | 17.8 | 6 | 9 | AR_Type D | 55.1 | 4.7 | 6 | 9 | DESIGN BY: TSP<br>CHECKED BY: WJH<br>Apr 25, 2019<br>PROJECT ID: I-5878<br>DIV: 6 |
|--|---|--------|-----|----|-----|----|-----------|----|------|---|---|-----------|------|-----|---|---|---|
| SYMBOL   | X   | Y      | WID | HT |     |    |           |    |      |   |   |           |      |     |   |   |   |
| AR_Type D  | 20  | 17.8   | 6   | 9  |     |    |           |    |      |   |   |           |      |     |   |   |   |
| AR_Type D  | 55.1  | 4.7    | 6   | 9  |     |    |           |    |      |   |   |           |      |     |   |   |   |

USE NOTES: 1, 2  
 1. Legend and border(except those that are colored black) shall be direct applied Grade C sheeting.  
 2. Background shall be Grade C reflective sheeting.

Spacing Factor is 1 unless specified otherwise

| Letter spacings are to start of next letter |     |     |     |     |     |     |     |   |     |     | Series/Size |     |      |
|---|-----|-----|-----|-----|-----|-----|-----|---|-----|-----|-------------|-----|------|
|   |     |     |     |     |     |     |     |   |     |     | Text Length |     |      |
| 32  | 4.7 | 4.4 | 4.3 | 3.4 | 4.6 | 3.5 | 15  |   |     |     | D 2000      |     |      |
|   |     |     |     |     |     |     |     |   |     |     | 25          |     |      |
|   |     |     |     |     |     |     |     |   |     |     | D 2000      |     |      |
| 8   | 4.2 | 4.1 | 5   | 3.8 | 2.5 | 2.8 | 3.9 | 5 | 2.2 | 2.2 | 1.9         | 3.5 | 22.9 |

FILENAME: Tim Sign Designs NORTH CAROLINA D.O.T. SIGN DETAIL

| SIGN NUMBER: 305,311<br>TYPE: D<br>QUANTITY: 2<br>SIGN WIDTH: 6'-0"<br>HEIGHT: 2'-6"<br>TOTAL AREA: 15.0 Sq.Ft.<br>BORDER TYPE: FLUSH<br>RECESS: 0"<br>WIDTH: 0.75"<br>RADII: 3"<br>NO. Z BARS:<br>LENGTH: | BACKG COLOR: Green<br>COPY COLOR: White<br>SYMBOL<br><table border="1"> <tr> <th>SYMBOL</th> <th>X</th> <th>Y</th> <th>WID</th> <th>HT</th> </tr> <tr> <td>AR_Type D</td> <td>9.5</td> <td>17.8</td> <td>6</td> <td>9</td> </tr> <tr> <td>AR_Type D</td> <td>47</td> <td>4.7</td> <td>6</td> <td>9</td> </tr> </table> MAT'L: 0.125" (3.2 mm) ALUMINUM | SYMBOL | X   | Y  | WID | HT | AR_Type D | 9.5 | 17.8 | 6 | 9 | AR_Type D | 47 | 4.7 | 6 | 9 | DESIGN BY: TSP<br>CHECKED BY: WJH<br>Apr 25, 2019<br>PROJECT ID: I-5878<br>DIV: 6 |
|--|--|--------|-----|----|-----|----|-----------|-----|------|---|---|-----------|----|-----|---|---|---|
| SYMBOL   | X  | Y      | WID | HT |     |    |           |     |      |   |   |           |    |     |   |   |   |
| AR_Type D  | 9.5  | 17.8   | 6   | 9  |     |    |           |     |      |   |   |           |    |     |   |   |   |
| AR_Type D  | 47   | 4.7    | 6   | 9  |     |    |           |     |      |   |   |           |    |     |   |   |   |

USE NOTES: 1, 2  
 1. Legend and border(except those that are colored black) shall be direct applied Grade C sheeting.  
 2. Background shall be Grade C reflective sheeting.

Spacing Factor is 1 unless specified otherwise

| Letter spacings are to start of next letter |     |     |     |     |     |     |     |   |     |     | Series/Size |     |        |
|---|-----|-----|-----|-----|-----|-----|-----|---|-----|-----|-------------|-----|--------|
|   |     |     |     |     |     |     |     |   |     |     | Text Length |     |        |
| 21.5  | 4.2 | 4.1 | 5   | 3.8 | 2.5 | 2.8 | 3.9 | 5 | 2.2 | 2.2 | 1.9         | 3.5 | 9.4    |
|   |     |     |     |     |     |     |     |   |     |     |             |     | 41.1   |
|   |     |     |     |     |     |     |     |   |     |     |             |     | D 2000 |
| 16  | 4.7 | 4.4 | 4.3 | 3.4 | 4.6 | 3.5 | 31  |   |     |     |             |     | 25     |

FILENAME: Tim Sign Designs NORTH CAROLINA D.O.T. SIGN DETAIL

3/15/2021  
 250\_014\_15986B\_Sgn-Sign04D\_011419.dgn  
 User: jwendt

SIGN DESIGNS

APPROVED: *William J. Hamilton*  
ACCOUNT 0704648484  
 DATE: 3/15/2021



**DOCUMENT NOT CONSIDERED FINAL  
 UNLESS ALL SIGNATURES COMPLETED**



| SIGN NUMBER: 312<br>TYPE: D<br>QUANTITY: 1<br>SIGN WIDTH: 4'-6"<br>HEIGHT: 1'-6"<br>TOTAL AREA: 6.8 Sq.Ft.<br>BORDER TYPE: FLUSH<br>RECESS: 0"<br>WIDTH: 0.75"<br>RADII: 3"<br>NO. Z BARS:<br>LENGTH: | BACKG COLOR: Green<br>COPY COLOR: White<br>SYMBOL<br><table border="1"> <tr> <th>SYMBOL</th> <th>X</th> <th>Y</th> <th>WID</th> <th>HT</th> </tr> <tr> <td>AR_Type D</td> <td>7</td> <td>6</td> <td>6</td> <td>9</td> </tr> </table> MAT'L: 0.125" (3.2 mm) ALUMINUM | SYMBOL | X   | Y  | WID | HT | AR_Type D | 7 | 6 | 6 | 9 | DESIGN BY: TSP<br>CHECKED BY: WJH<br>PROJECT ID: I-5878<br>Apr 25, 2019<br>DIV: 6 |
|---|--|--------|-----|----|-----|----|-----------|---|---|---|---|---|
| SYMBOL  | X  | Y      | WID | HT |     |    |           |   |   |   |   |   |
| AR_Type D   | 7  | 6      | 6   | 9  |     |    |           |   |   |   |   |   |

BORDER R=3" TH=0.75"

Spacing Factor is 1 unless specified otherwise

| Letter spacings are to start of next letter |     |     |     |     |     |     |   |  |  | Series/Size |
|---|-----|-----|-----|-----|-----|-----|---|--|--|-------------|
|   |     |     |     |     |     |     |   |  |  | Text Length |
|   |     |     |     |     |     |     |   |  |  | D 2000      |
| 22  | 4.7 | 4.4 | 4.3 | 3.4 | 4.6 | 3.5 | 7 |  |  | 25          |

FILENAME: Tim Sign Designs NORTH CAROLINA D.O.T. SIGN DETAIL

| SIGN NUMBER: 313<br>TYPE: D<br>QUANTITY: 1<br>SIGN WIDTH: 6'-0"<br>HEIGHT: 1'-6"<br>TOTAL AREA: 9.0 Sq.Ft.<br>BORDER TYPE: FLUSH<br>RECESS: 0"<br>WIDTH: 0.75"<br>RADII: 3"<br>NO. Z BARS:<br>LENGTH: | BACKG COLOR: Green<br>COPY COLOR: White<br>SYMBOL<br><table border="1"> <tr> <th>SYMBOL</th> <th>X</th> <th>Y</th> <th>WID</th> <th>HT</th> </tr> <tr> <td>AR_Type D</td> <td>7.9</td> <td>6</td> <td>6</td> <td>9</td> </tr> </table> MAT'L: 0.125" (3.2 mm) ALUMINUM | SYMBOL | X   | Y  | WID | HT | AR_Type D | 7.9 | 6 | 6 | 9 | DESIGN BY: TSP<br>CHECKED BY: WJH<br>PROJECT ID: I-5878<br>Apr 02, 2019<br>DIV: 6 |
|---|--|--------|-----|----|-----|----|-----------|-----|---|---|---|---|
| SYMBOL  | X  | Y      | WID | HT |     |    |           |     |   |   |   |   |
| AR_Type D   | 7.9  | 6      | 6   | 9  |     |    |           |     |   |   |   |   |

BORDER R=3" TH=0.75"

Spacing Factor is 1 unless specified otherwise

| Letter spacings are to start of next letter |     |     |   |     |     |     |     |   |     | Series/Size |
|---|-----|-----|---|-----|-----|-----|-----|---|-----|-------------|
|   |     |     |   |     |     |     |     |   |     | Text Length |
|   |     |     |   |     |     |     |     |   |     | D 2000      |
| 22.9  | 4.2 | 4.1 | 5 | 3.8 | 2.5 | 2.8 | 3.9 | 5 | 2.2 | 41.1        |

FILENAME: Tim Sign Designs NORTH CAROLINA D.O.T. SIGN DETAIL

| SIGN NUMBER: 309<br>TYPE: D<br>QUANTITY: 1<br>SIGN WIDTH: 4'-0"<br>HEIGHT: 1'-6"<br>TOTAL AREA: 6.0 Sq.Ft.<br>BORDER TYPE: FLUSH<br>RECESS: 0"<br>WIDTH: 0.75"<br>RADII: 3"<br>NO. Z BARS:<br>LENGTH: | BACKG COLOR: Green<br>COPY COLOR: White<br>SYMBOL<br><table border="1"> <tr> <th>SYMBOL</th> <th>X</th> <th>Y</th> <th>WID</th> <th>HT</th> </tr> <tr> <td>AR_Type D</td> <td>7.4</td> <td>6</td> <td>6</td> <td>9</td> </tr> </table> MAT'L: 0.125" (3.2 mm) ALUMINUM | SYMBOL | X   | Y  | WID | HT | AR_Type D | 7.4 | 6 | 6 | 9 | DESIGN BY: TSP<br>CHECKED BY: WJH<br>PROJECT ID: I-5878<br>May 23, 2019<br>DIV: 6 |
|---|--|--------|-----|----|-----|----|-----------|-----|---|---|---|---|
| SYMBOL  | X  | Y      | WID | HT |     |    |           |     |   |   |   |   |
| AR_Type D   | 7.4  | 6      | 6   | 9  |     |    |           |     |   |   |   |   |

BORDER R=3" TH=0.75"

Spacing Factor is 1 unless specified otherwise

| Letter spacings are to start of next letter |     |     |     |     |     |  |  |  |  | Series/Size |
|---|-----|-----|-----|-----|-----|--|--|--|--|-------------|
|   |     |     |     |     |     |  |  |  |  | Text Length |
|   |     |     |     |     |     |  |  |  |  | D 2000      |
| 22.4  | 5.2 | 4.7 | 4.7 | 3.5 | 7.4 |  |  |  |  | 18.2        |

FILENAME: Sign Designs NORTH CAROLINA D.O.T. SIGN DETAIL



| SIGN NUMBER: 315<br>TYPE: D<br>QUANTITY: 1<br>SIGN WIDTH: 4'-0"<br>HEIGHT: 1'-6"<br>TOTAL AREA: 6.0 Sq.Ft.<br>BORDER TYPE: FLUSH<br>RECESS: 0"<br>WIDTH: 0.75"<br>RADII: 3"<br>NO. Z BARS:<br>LENGTH: | BACKG COLOR: Green<br>COPY COLOR: White<br>SYMBOL<br><table border="1"> <tr> <th>SYMBOL</th> <th>X</th> <th>Y</th> <th>WID</th> <th>HT</th> </tr> <tr> <td>AR_Type D</td> <td>31.6</td> <td>6</td> <td>6</td> <td>9</td> </tr> </table> MAT'L: 0.125" (3.2 mm) ALUMINUM | SYMBOL | X   | Y  | WID | HT | AR_Type D | 31.6 | 6 | 6 | 9 | DESIGN BY: TSP<br>CHECKED BY: WJH<br>PROJECT ID: I-5878<br>Jul 11, 2019<br>DIV: 6 |
|---|---|--------|-----|----|-----|----|-----------|------|---|---|---|---|
| SYMBOL  | X   | Y      | WID | HT |     |    |           |      |   |   |   |   |
| AR_Type D   | 31.6  | 6      | 6   | 9  |     |    |           |      |   |   |   |   |

BORDER R=3" TH=0.75"

Spacing Factor is 1 unless specified otherwise

| Letter spacings are to start of next letter |     |     |     |     |      |  |  |  |  | Series/Size |
|---|-----|-----|-----|-----|------|--|--|--|--|-------------|
|   |     |     |     |     |      |  |  |  |  | Text Length |
|   |     |     |     |     |      |  |  |  |  | D 2000      |
| 7.4   | 5.2 | 4.7 | 4.7 | 3.5 | 22.4 |  |  |  |  | 18.2        |

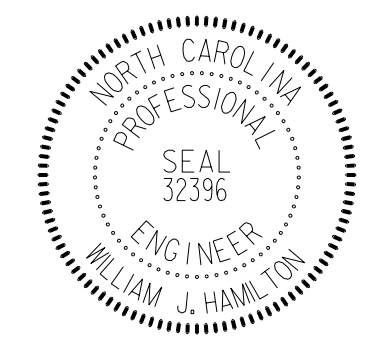
FILENAME: 5878\_Sign Designs NORTH CAROLINA D.O.T. SIGN DETAIL

|  |                             |
|--|-----------------------------|
| TIP NO.<br><b>I-5878</b>   | SHEET NO.<br><b>SIGN-4F</b> |
| APPROVED: <i>William J. Hamilton</i><br>A056070464844  |                             |
| DATE: <b>3/15/2021</b>   |                             |
| SEAL<br>  |                             |
| <b>DOCUMENT NOT CONSIDERED FINAL<br/>UNLESS ALL SIGNATURES COMPLETED</b>   |                             |
| <br><b>RKA</b><br>RAMEY KEMP ASSOCIATES<br>5808 Faringdon Place<br>Raleigh, North Carolina 27609<br>Phone: 919-872-5115<br>NC License No. C-0910<br>www.rameykemp.com |                             |

| SIGN NUMBER: 306<br>TYPE: D<br>QUANTITY: 1<br>SIGN WIDTH: 4'-6"<br>HEIGHT: 1'-6"<br>TOTAL AREA: 6.8 Sq.Ft.<br>BORDER TYPE: FLUSH<br>RECESS: 0"<br>WIDTH: 1.5"<br>RADII: 3"<br>NO. Z BARS:<br>LENGTH: | BACKG COLOR: Green<br>COPY COLOR: White<br><table border="1"> <tr> <th>SYMBOL</th> <th>X</th> <th>Y</th> <th>WID</th> <th>HT</th> </tr> <tr> <td>AR_FISHOOK</td> <td>6.6</td> <td>3.6</td> <td>9.9</td> <td>10.8</td> </tr> </table> MAT'L: 0.125" (3.2 mm) ALUMINUM | SYMBOL | X   | Y    | WID | HT | AR_FISHOOK | 6.6 | 3.6 | 9.9 | 10.8 | DESIGN BY: TSP<br>CHECKED BY: WJH<br>PROJECT ID: I-5878<br>Feb 12, 2020<br>DIV: 6 |
|--|--|--------|-----|------|-----|----|------------|-----|-----|-----|------|---|
| SYMBOL   | X  | Y      | WID | HT   |     |    |            |     |     |     |      |   |
| AR_FISHOOK   | 6.6  | 3.6    | 9.9 | 10.8 |     |    |            |     |     |     |      |   |

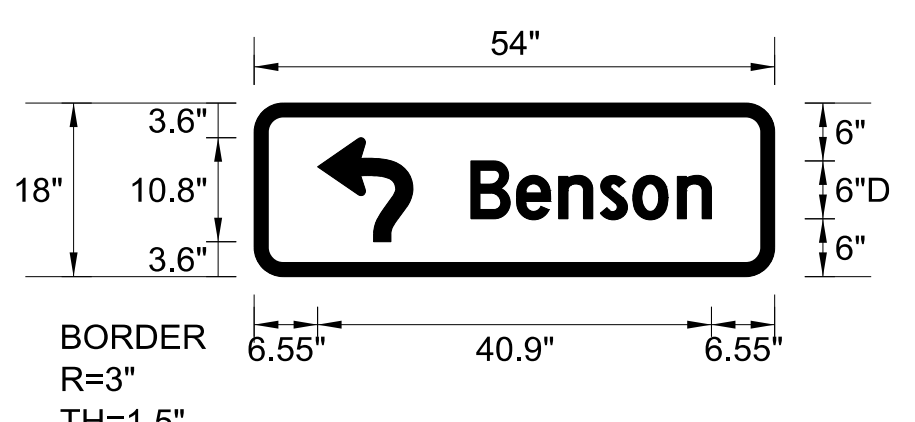

USE NOTES: 1, 2  
 1. Legend and border(except those that are colored black) shall be direct applied Grade C sheeting.  
 2. Background shall be Grade C reflective sheeting.

LETTER POSITIONS

| Letter spacings are to start of next letter |     |     |     |     |     |     |     |  |  | Series/Size |
|---|-----|-----|-----|-----|-----|-----|-----|--|--|-------------|
|   |     |     |     |     |     |     |     |  |  | Text Length |
| 22.5  | 4.7 | 4.4 | 4.3 | 3.4 | 4.6 | 3.5 | 6.6 |  |  | D 2000      |
|   |     |     |     |     |     |     |     |  |  | 25          |

FILENAME: 5878\_Sign Designs  
NORTH CAROLINA D.O.T. SIGN DETAIL

| SIGN NUMBER: 307<br>TYPE: D<br>QUANTITY: 1<br>SIGN WIDTH: 6'-0"<br>HEIGHT: 1'-6"<br>TOTAL AREA: 9.0 Sq.Ft.<br>BORDER TYPE: FLUSH<br>RECESS: 0"<br>WIDTH: 1.5"<br>RADII: 3"<br>NO. Z BARS:<br>LENGTH: | BACKG COLOR: Green<br>COPY COLOR: White<br><table border="1"> <tr> <th>SYMBOL</th> <th>X</th> <th>Y</th> <th>WID</th> <th>HT</th> </tr> <tr> <td>AR_FISHOOK</td> <td>7.5</td> <td>3.6</td> <td>9.9</td> <td>10.8</td> </tr> </table> MAT'L: 0.125" (3.2 mm) ALUMINUM | SYMBOL | X   | Y    | WID | HT | AR_FISHOOK | 7.5 | 3.6 | 9.9 | 10.8 | DESIGN BY: TSP<br>CHECKED BY: WJH<br>PROJECT ID: I-5878<br>Feb 12, 2020<br>DIV: 6 |
|--|--|--------|-----|------|-----|----|------------|-----|-----|-----|------|---|
| SYMBOL   | X  | Y      | WID | HT   |     |    |            |     |     |     |      |   |
| AR_FISHOOK   | 7.5  | 3.6    | 9.9 | 10.8 |     |    |            |     |     |     |      |   |

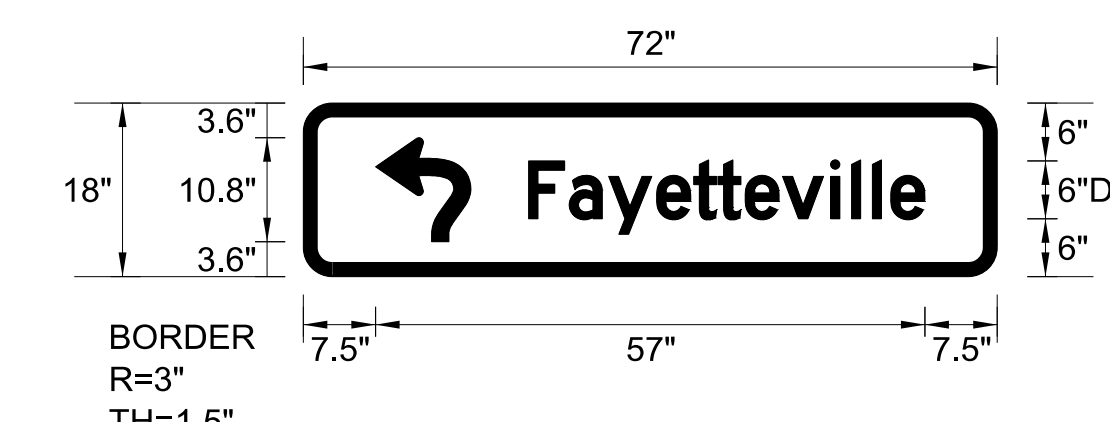

USE NOTES: 1, 2  
 1. Legend and border(except those that are colored black) shall be direct applied Grade C sheeting.  
 2. Background shall be Grade C reflective sheeting.

LETTER POSITIONS

| Letter spacings are to start of next letter |     |     |   |     |     |     |     |   |     |     |     | Series/Size |     |        |
|---|-----|-----|---|-----|-----|-----|-----|---|-----|-----|-----|-------------|-----|--------|
|   |     |     |   |     |     |     |     |   |     |     |     | Text Length |     |        |
| 23.4  | 4.2 | 4.1 | 5 | 3.8 | 2.5 | 2.8 | 3.9 | 5 | 2.2 | 2.2 | 1.9 | 3.5         | 7.5 | D 2000 |
|   |     |     |   |     |     |     |     |   |     |     |     |             |     | 41.1   |

FILENAME: 5878\_Sign Designs  
NORTH CAROLINA D.O.T. SIGN DETAIL

| SIGN NUMBER: 319<br>TYPE: D<br>QUANTITY: 1<br>SIGN WIDTH: 6'-0"<br>HEIGHT: 2'-6"<br>TOTAL AREA: 15.0 Sq.Ft.<br>BORDER TYPE: FLUSH<br>RECESS: 0"<br>WIDTH: 0.75"<br>RADII: 3"<br>NO. Z BARS:<br>LENGTH: | BACKG COLOR: Green<br>COPY COLOR: White<br><table border="1"> <tr> <th>SYMBOL</th> <th>X</th> <th>Y</th> <th>WID</th> <th>HT</th> </tr> </table> MAT'L: 0.125" (3.2 mm) ALUMINUM | SYMBOL | X   | Y  | WID | HT | DESIGN BY: TSP<br>CHECKED BY: WJH<br>PROJECT ID: I-5878<br>Feb 12, 2020<br>DIV: 6 |
|--|--|--------|-----|----|-----|----|---|
| SYMBOL   | X  | Y      | WID | HT |     |    |   |

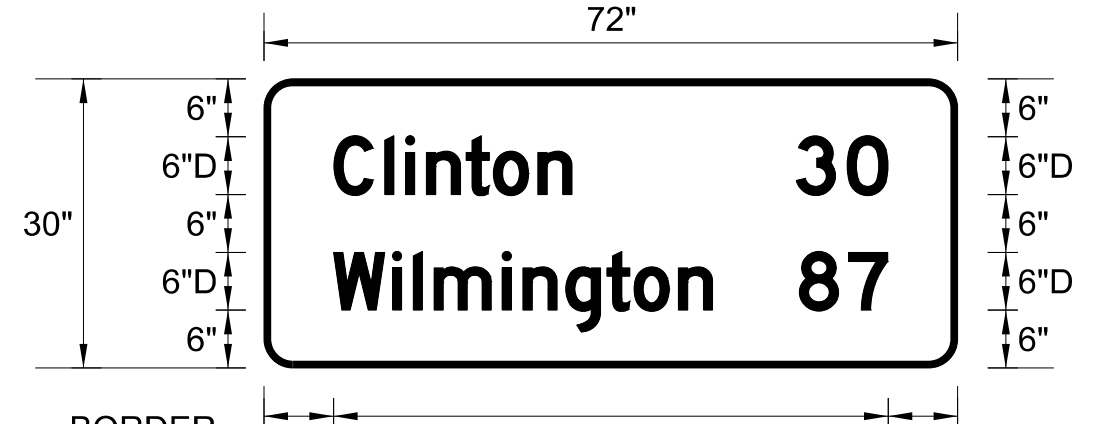

USE NOTES: 1, 2  
 1. Legend and border(except those that are colored black) shall be direct applied Grade C sheeting.  
 2. Background shall be Grade C reflective sheeting.

LETTER POSITIONS

| Letter spacings are to start of next letter |     |     |     |     |     |     |     |      |     |     |     | Series/Size |
|---|-----|-----|-----|-----|-----|-----|-----|------|-----|-----|-----|-------------|
|   |     |     |     |     |     |     |     |      |     |     |     | Text Length |
| 7.3   | 5.3 | 2.2 | 2.2 | 4.1 | 2.8 | 4.6 | 3.5 | 23.3 | 5.3 | 4.3 | 7.2 | D 2000      |
|   |     |     |     |     |     |     |     |      |     |     |     | 57.5        |
| 7.2   | 6.1 | 2.2 | 2.2 | 7.1 | 2.2 | 4.4 | 4.3 | 2.8  | 4.6 | 3.5 | 9   | D 2000      |
|   |     |     |     |     |     |     |     |      |     |     |     | 57.5        |

FILENAME: 5878\_Sign Designs  
NORTH CAROLINA D.O.T. SIGN DETAIL

| SIGN NUMBER: 320<br>TYPE: D<br>QUANTITY: 1<br>SIGN WIDTH: 6'-6"<br>HEIGHT: 2'-6"<br>TOTAL AREA: 16.3 Sq.Ft.<br>BORDER TYPE: FLUSH<br>RECESS: 0"<br>WIDTH: 0.75"<br>RADII: 3"<br>NO. Z BARS:<br>LENGTH: | BACKG COLOR: Green<br>COPY COLOR: White<br><table border="1"> <tr> <th>SYMBOL</th> <th>X</th> <th>Y</th> <th>WID</th> <th>HT</th> </tr> <tr> <td>AR_Type D</td> <td>19.4</td> <td>17.8</td> <td>6</td> <td>9</td> </tr> <tr> <td>AR_Type D</td> <td>4.8</td> <td>4.7</td> <td>6</td> <td>9</td> </tr> </table> MAT'L: 0.125" (3.2 mm) ALUMINUM | SYMBOL | X   | Y  | WID | HT | AR_Type D | 19.4 | 17.8 | 6 | 9 | AR_Type D | 4.8 | 4.7 | 6 | 9 | DESIGN BY: TSP<br>CHECKED BY: WJH<br>PROJECT ID: I-5878<br>Feb 12, 2020<br>DIV: 6 |
|--|--|--------|-----|----|-----|----|-----------|------|------|---|---|-----------|-----|-----|---|---|---|
| SYMBOL   | X  | Y      | WID | HT |     |    |           |      |      |   |   |           |     |     |   |   |   |
| AR_Type D  | 19.4   | 17.8   | 6   | 9  |     |    |           |      |      |   |   |           |     |     |   |   |   |
| AR_Type D  | 4.8  | 4.7    | 6   | 9  |     |    |           |      |      |   |   |           |     |     |   |   |   |

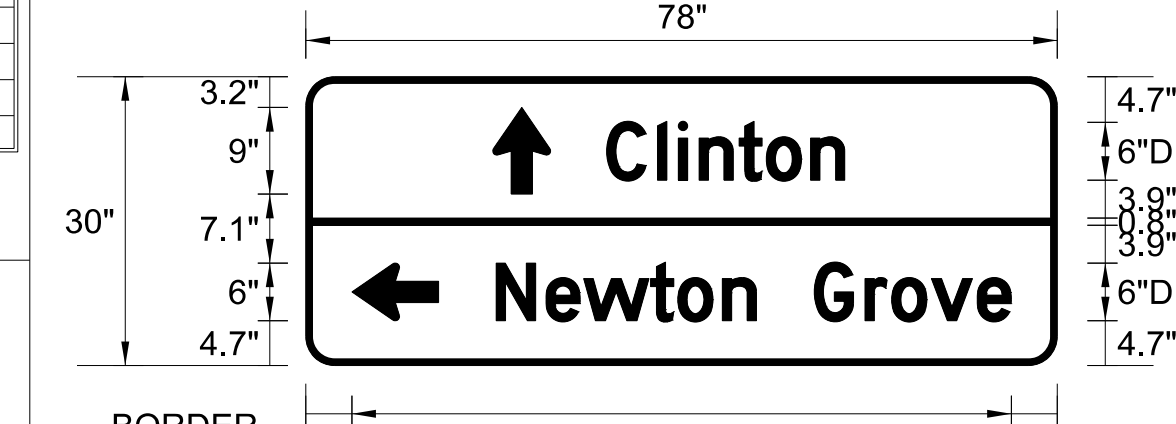

USE NOTES: 1, 2  
 1. Legend and border(except those that are colored black) shall be direct applied Grade C sheeting.  
 2. Background shall be Grade C reflective sheeting.



LETTER POSITIONS

| Letter spacings are to start of next letter |     |     |     |     |     |     |     |      |     |     |     | Series/Size |     |        |
|---|-----|-----|-----|-----|-----|-----|-----|------|-----|-----|-----|-------------|-----|--------|
|   |     |     |     |     |     |     |     |      |     |     |     | Text Length |     |        |
| 31.2  | 5.3 | 2.2 | 2.2 | 4.1 | 2.8 | 4.6 | 3.5 | 22.1 |     |     |     | D 2000      |     |        |
|   |     |     |     |     |     |     |     |      |     |     |     | 24.7        |     |        |
| 19.8  | 5.2 | 3.9 | 7   | 2.8 | 4.6 | 3.5 | 6   | 5.3  | 2.8 | 4.1 | 4.7 | 3.5         | 4.8 | D 2000 |
|   |     |     |     |     |     |     |     |      |     |     |     |             |     | 53.5   |

FILENAME: 5878\_Sign Designs  
NORTH CAROLINA D.O.T. SIGN DETAIL

3/15/2021 11:25:06 AM User: J. Wendt

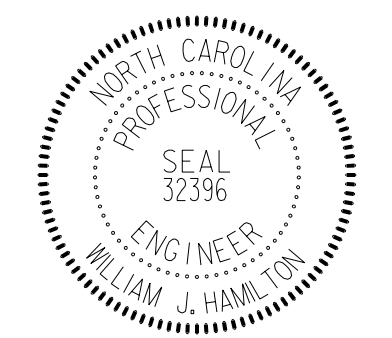
SIGN DESIGNS

|  |                             |
|--|-----------------------------|
| TIP NO.<br><b>I-5878</b>   | SHEET NO.<br><b>SIGN-4G</b> |
| APPROVED: <i>William J. Hamilton</i><br>AS06070464844  |                             |
| DATE: <b>3/15/2021</b>   |                             |
| SEAL<br>  |                             |
| <b>DOCUMENT NOT CONSIDERED FINAL<br/>UNLESS ALL SIGNATURES COMPLETED</b>   |                             |
| <br><b>RKA</b><br>RAMEY KEMP ASSOCIATES<br>5808 Faringdon Place<br>Raleigh, North Carolina 27609<br>Phone: 919-872-5115<br>NC License No. C-0910<br>www.rameykemp.com |                             |

| SIGN NUMBER: <b>321</b><br>TYPE: <b>D</b><br>QUANTITY: <b>1</b><br>SIGN WIDTH: <b>6'-0"</b><br>HEIGHT: <b>3'-0"</b><br>TOTAL AREA: <b>18.0 Sq.Ft.</b><br>BORDER TYPE: <b>FLUSH</b><br>RECESS: <b>0"</b><br>WIDTH: <b>0.75"</b><br>RADII: <b>3"</b><br>NO. Z BARS: <b>2</b><br>LENGTH: <b>36"</b> | BACKG COLOR: <b>Green</b><br>COPY COLOR: <b>White</b><br>SYMBOLOGY TABLE:<br><table border="1"> <tr><th>SYMBOL</th><th>X</th><th>Y</th><th>WID</th><th>HT</th></tr> <tr><td> </td><td> </td><td> </td><td> </td><td> </td></tr> <tr><td> </td><td> </td><td> </td><td> </td><td> </td></tr> <tr><td> </td><td> </td><td> </td><td> </td><td> </td></tr> <tr><td> </td><td> </td><td> </td><td> </td><td> </td></tr> <tr><td> </td><td> </td><td> </td><td> </td><td> </td></tr> <tr><td> </td><td> </td><td> </td><td> </td><td> </td></tr> <tr><td> </td><td> </td><td> </td><td> </td><td> </td></tr> <tr><td> </td><td> </td><td> </td><td> </td><td> </td></tr> <tr><td> </td><td> </td><td> </td><td> </td><td> </td></tr> <tr><td> </td><td> </td><td> </td><td> </td><td> </td></tr> </table> MAT'L: <b>0.125" (3.2 mm) ALUMINUM</b> | SYMBOL | X   | Y  | WID | HT |  |  |  |  |  |  |  |  |  |  |  |  |  |  |  |  |  |  |  |  |  |  |  |  |  |  |  |  |  |  |  |  |  |  |  |  |  |  |  |  |  |  |  |  |  |  |  |  |  |  | DESIGN BY: <b>TSP</b><br>CHECKED BY: <b>WJH</b><br>PROJECT ID: <b>I-5878</b><br>Feb 12, 2020<br>DIV: <b>6</b> |
|--|---|--------|-----|----|-----|----|--|--|--|--|--|--|--|--|--|--|--|--|--|--|--|--|--|--|--|--|--|--|--|--|--|--|--|--|--|--|--|--|--|--|--|--|--|--|--|--|--|--|--|--|--|--|--|--|--|--|---|
| SYMBOL   | X   | Y      | WID | HT |     |    |  |  |  |  |  |  |  |  |  |  |  |  |  |  |  |  |  |  |  |  |  |  |  |  |  |  |  |  |  |  |  |  |  |  |  |  |  |  |  |  |  |  |  |  |  |  |  |  |  |  |   |
|  |   |        |     |    |     |    |  |  |  |  |  |  |  |  |  |  |  |  |  |  |  |  |  |  |  |  |  |  |  |  |  |  |  |  |  |  |  |  |  |  |  |  |  |  |  |  |  |  |  |  |  |  |  |  |  |  |   |
|  |   |        |     |    |     |    |  |  |  |  |  |  |  |  |  |  |  |  |  |  |  |  |  |  |  |  |  |  |  |  |  |  |  |  |  |  |  |  |  |  |  |  |  |  |  |  |  |  |  |  |  |  |  |  |  |  |   |
|  |   |        |     |    |     |    |  |  |  |  |  |  |  |  |  |  |  |  |  |  |  |  |  |  |  |  |  |  |  |  |  |  |  |  |  |  |  |  |  |  |  |  |  |  |  |  |  |  |  |  |  |  |  |  |  |  |   |
|  |   |        |     |    |     |    |  |  |  |  |  |  |  |  |  |  |  |  |  |  |  |  |  |  |  |  |  |  |  |  |  |  |  |  |  |  |  |  |  |  |  |  |  |  |  |  |  |  |  |  |  |  |  |  |  |  |   |
|  |   |        |     |    |     |    |  |  |  |  |  |  |  |  |  |  |  |  |  |  |  |  |  |  |  |  |  |  |  |  |  |  |  |  |  |  |  |  |  |  |  |  |  |  |  |  |  |  |  |  |  |  |  |  |  |  |   |
|  |   |        |     |    |     |    |  |  |  |  |  |  |  |  |  |  |  |  |  |  |  |  |  |  |  |  |  |  |  |  |  |  |  |  |  |  |  |  |  |  |  |  |  |  |  |  |  |  |  |  |  |  |  |  |  |  |   |
|  |   |        |     |    |     |    |  |  |  |  |  |  |  |  |  |  |  |  |  |  |  |  |  |  |  |  |  |  |  |  |  |  |  |  |  |  |  |  |  |  |  |  |  |  |  |  |  |  |  |  |  |  |  |  |  |  |   |
|  |   |        |     |    |     |    |  |  |  |  |  |  |  |  |  |  |  |  |  |  |  |  |  |  |  |  |  |  |  |  |  |  |  |  |  |  |  |  |  |  |  |  |  |  |  |  |  |  |  |  |  |  |  |  |  |  |   |
|  |   |        |     |    |     |    |  |  |  |  |  |  |  |  |  |  |  |  |  |  |  |  |  |  |  |  |  |  |  |  |  |  |  |  |  |  |  |  |  |  |  |  |  |  |  |  |  |  |  |  |  |  |  |  |  |  |   |
|  |   |        |     |    |     |    |  |  |  |  |  |  |  |  |  |  |  |  |  |  |  |  |  |  |  |  |  |  |  |  |  |  |  |  |  |  |  |  |  |  |  |  |  |  |  |  |  |  |  |  |  |  |  |  |  |  |   |

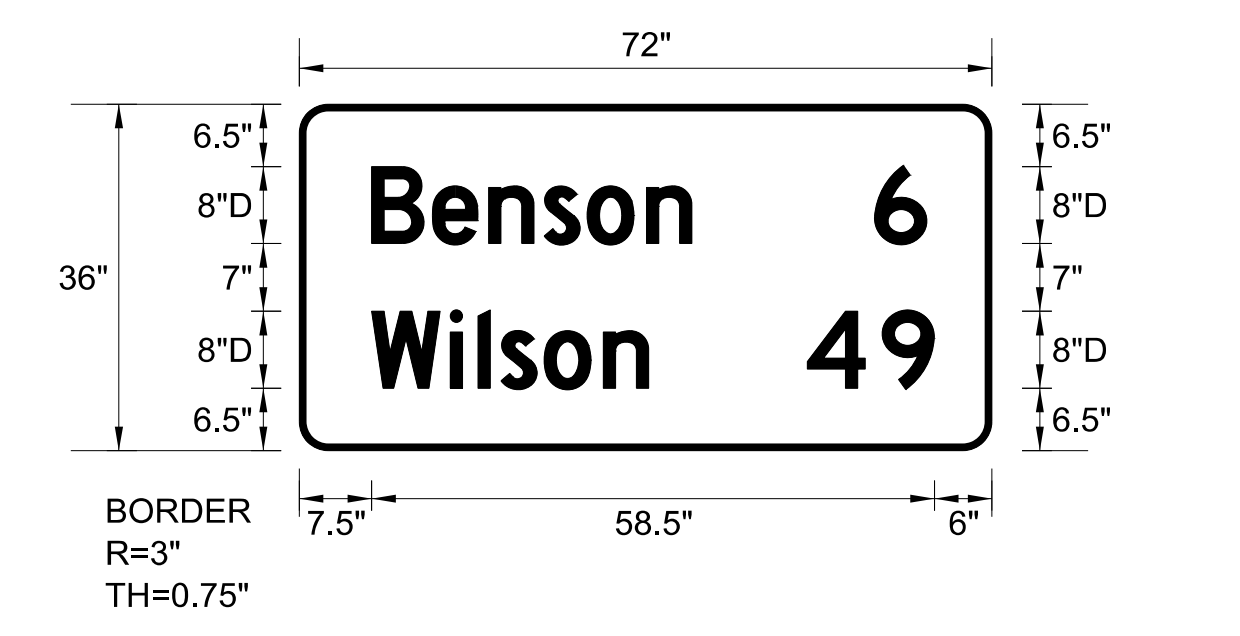

Spacing Factor is 1 unless specified otherwise

| LETTER POSITIONS                            |     |     |     |     |     |     |      |     |     |   | Series/Size |
|---|-----|-----|-----|-----|-----|-----|------|-----|-----|---|-------------|
| Letter spacings are to start of next letter |     |     |     |     |     |     |      |     |     |   | Text Length |
| B   | e   | n   | s   | o   | n   | 6   |      |     |     |   | D 2000      |
| 7.5   | 6.3 | 5.8 | 5.8 | 4.5 | 6.2 | 4.7 | 19   | 5.4 | 6.8 |   | 57.7        |
| W   | i   | l   | s   | o   | n   | 4   | 9    |     |     |   | D 2000      |
| 7.5   | 8.2 | 2.9 | 2.4 | 4.5 | 6.2 | 4.7 | 16.5 | 7.8 | 5.4 | 6 | 58.5        |

FILENAME: 5878\_Sign Designs NORTH CAROLINA D.O.T. SIGN DETAIL

| SIGN NUMBER: <b>107,112</b><br>TYPE: <b>A</b><br>QUANTITY: <b>2</b><br>SIGN WIDTH: <b>7'-6"</b><br>HEIGHT: <b>7'-0"</b><br>TOTAL AREA: <b>52.5 Sq.Ft.</b><br>BORDER TYPE: <b>FLUSH</b><br>RECESS: <b>0"</b><br>WIDTH: <b>0.75"</b><br>RADII: <b>6"</b><br>NO. Z BARS: <b>2</b><br>LENGTH: <b>82.0</b> | BACKG COLOR: <b>Blue</b><br>COPY COLOR: <b>White</b><br>SYMBOLOGY TABLE:<br><table border="1"> <tr><th>SYMBOL</th><th>X</th><th>Y</th><th>WID</th><th>HT</th></tr> <tr><td> </td><td> </td><td> </td><td> </td><td> </td></tr> <tr><td> </td><td> </td><td> </td><td> </td><td> </td></tr> <tr><td> </td><td> </td><td> </td><td> </td><td> </td></tr> <tr><td> </td><td> </td><td> </td><td> </td><td> </td></tr> <tr><td> </td><td> </td><td> </td><td> </td><td> </td></tr> <tr><td> </td><td> </td><td> </td><td> </td><td> </td></tr> <tr><td> </td><td> </td><td> </td><td> </td><td> </td></tr> <tr><td> </td><td> </td><td> </td><td> </td><td> </td></tr> <tr><td> </td><td> </td><td> </td><td> </td><td> </td></tr> <tr><td> </td><td> </td><td> </td><td> </td><td> </td></tr> </table> MAT'L: <b>0.125" (3.2 mm) ALUMINUM</b> | SYMBOL | X   | Y  | WID | HT |  |  |  |  |  |  |  |  |  |  |  |  |  |  |  |  |  |  |  |  |  |  |  |  |  |  |  |  |  |  |  |  |  |  |  |  |  |  |  |  |  |  |  |  |  |  |  |  |  |  | DESIGN BY: <b>TSP</b><br>CHECKED BY: <b>WJH</b><br>PROJECT ID: <b>I-5878</b><br>Dec 10, 2019<br>DIV: <b>6</b> |
|---|--|--------|-----|----|-----|----|--|--|--|--|--|--|--|--|--|--|--|--|--|--|--|--|--|--|--|--|--|--|--|--|--|--|--|--|--|--|--|--|--|--|--|--|--|--|--|--|--|--|--|--|--|--|--|--|--|--|---|
| SYMBOL  | X  | Y      | WID | HT |     |    |  |  |  |  |  |  |  |  |  |  |  |  |  |  |  |  |  |  |  |  |  |  |  |  |  |  |  |  |  |  |  |  |  |  |  |  |  |  |  |  |  |  |  |  |  |  |  |  |  |  |   |
|   |  |        |     |    |     |    |  |  |  |  |  |  |  |  |  |  |  |  |  |  |  |  |  |  |  |  |  |  |  |  |  |  |  |  |  |  |  |  |  |  |  |  |  |  |  |  |  |  |  |  |  |  |  |  |  |  |   |
|   |  |        |     |    |     |    |  |  |  |  |  |  |  |  |  |  |  |  |  |  |  |  |  |  |  |  |  |  |  |  |  |  |  |  |  |  |  |  |  |  |  |  |  |  |  |  |  |  |  |  |  |  |  |  |  |  |   |
|   |  |        |     |    |     |    |  |  |  |  |  |  |  |  |  |  |  |  |  |  |  |  |  |  |  |  |  |  |  |  |  |  |  |  |  |  |  |  |  |  |  |  |  |  |  |  |  |  |  |  |  |  |  |  |  |  |   |
|   |  |        |     |    |     |    |  |  |  |  |  |  |  |  |  |  |  |  |  |  |  |  |  |  |  |  |  |  |  |  |  |  |  |  |  |  |  |  |  |  |  |  |  |  |  |  |  |  |  |  |  |  |  |  |  |  |   |
|   |  |        |     |    |     |    |  |  |  |  |  |  |  |  |  |  |  |  |  |  |  |  |  |  |  |  |  |  |  |  |  |  |  |  |  |  |  |  |  |  |  |  |  |  |  |  |  |  |  |  |  |  |  |  |  |  |   |
|   |  |        |     |    |     |    |  |  |  |  |  |  |  |  |  |  |  |  |  |  |  |  |  |  |  |  |  |  |  |  |  |  |  |  |  |  |  |  |  |  |  |  |  |  |  |  |  |  |  |  |  |  |  |  |  |  |   |
|   |  |        |     |    |     |    |  |  |  |  |  |  |  |  |  |  |  |  |  |  |  |  |  |  |  |  |  |  |  |  |  |  |  |  |  |  |  |  |  |  |  |  |  |  |  |  |  |  |  |  |  |  |  |  |  |  |   |
|   |  |        |     |    |     |    |  |  |  |  |  |  |  |  |  |  |  |  |  |  |  |  |  |  |  |  |  |  |  |  |  |  |  |  |  |  |  |  |  |  |  |  |  |  |  |  |  |  |  |  |  |  |  |  |  |  |   |
|   |  |        |     |    |     |    |  |  |  |  |  |  |  |  |  |  |  |  |  |  |  |  |  |  |  |  |  |  |  |  |  |  |  |  |  |  |  |  |  |  |  |  |  |  |  |  |  |  |  |  |  |  |  |  |  |  |   |
|   |  |        |     |    |     |    |  |  |  |  |  |  |  |  |  |  |  |  |  |  |  |  |  |  |  |  |  |  |  |  |  |  |  |  |  |  |  |  |  |  |  |  |  |  |  |  |  |  |  |  |  |  |  |  |  |  |   |

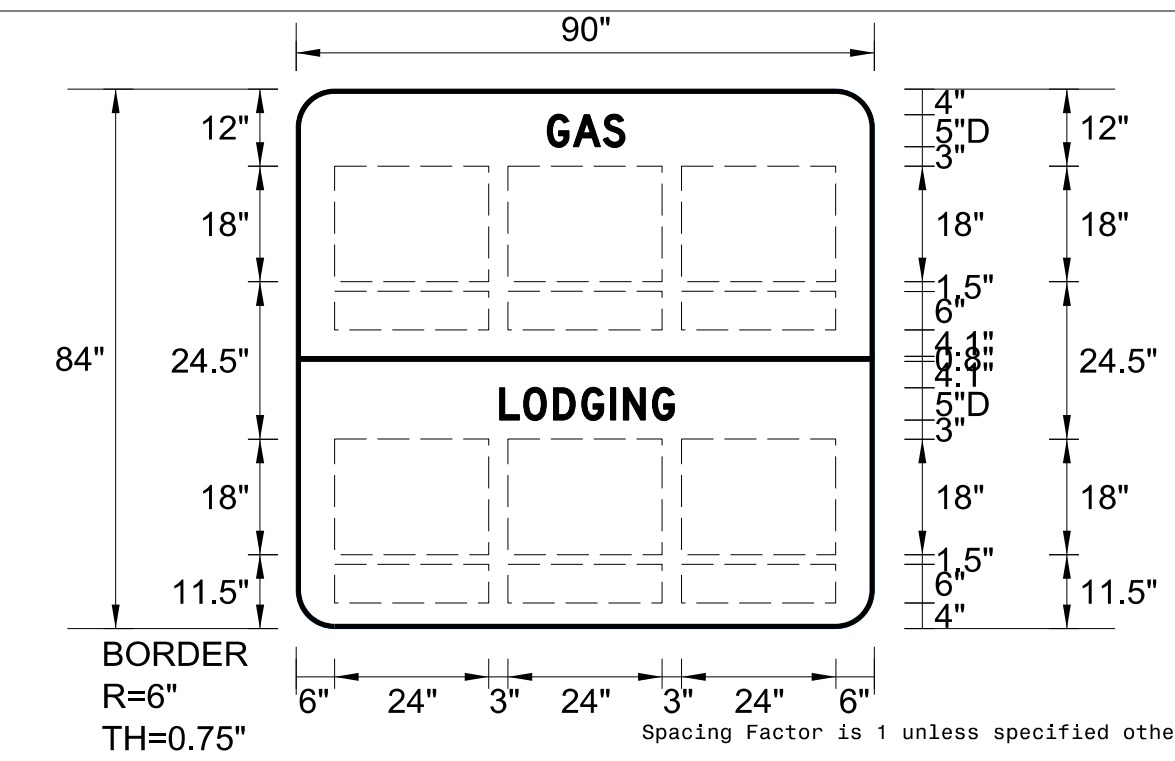

Spacing Factor is 1 unless specified otherwise

| LETTER POSITIONS                            |     |     |     |      |   |     |     |      |  |  | Series/Size |
|---|-----|-----|-----|------|---|-----|-----|------|--|--|-------------|
| Letter spacings are to start of next letter |     |     |     |      |   |     |     |      |  |  | Text Length |
| G   | A   | S   |     |      |   |     |     |      |  |  | D 2000      |
| 39.1  | 4.1 | 4.6 | 3.4 | 38.8 |   |     |     |      |  |  | 12.1        |
| L   | O   | D   | G   | I    | N | G   |     |      |  |  | D 2000      |
| 31.7  | 3.7 | 4.6 | 4.4 | 4.5  | 2 | 4.5 | 3.4 | 31.2 |  |  | 27.2        |

FILENAME: 5878\_Sign Designs NORTH CAROLINA D.O.T. SIGN DETAIL

| SIGN NUMBER: <b>108</b><br>TYPE: <b>A</b><br>QUANTITY: <b>1</b><br>SIGN WIDTH: <b>7'-6"</b><br>HEIGHT: <b>4'-0"</b><br>TOTAL AREA: <b>30.0 Sq.Ft.</b><br>BORDER TYPE: <b>FLUSH</b><br>RECESS: <b>0"</b><br>WIDTH: <b>0.75"</b><br>RADII: <b>6"</b><br>NO. Z BARS: <b>2</b><br>LENGTH: <b>82.0</b> | BACKG COLOR: <b>Green</b><br>COPY COLOR: <b>White</b><br>SYMBOLOGY TABLE:<br><table border="1"> <tr><th>SYMBOL</th><th>X</th><th>Y</th><th>WID</th><th>HT</th></tr> <tr><td> </td><td> </td><td> </td><td> </td><td> </td></tr> <tr><td> </td><td> </td><td> </td><td> </td><td> </td></tr> <tr><td> </td><td> </td><td> </td><td> </td><td> </td></tr> <tr><td> </td><td> </td><td> </td><td> </td><td> </td></tr> <tr><td> </td><td> </td><td> </td><td> </td><td> </td></tr> <tr><td> </td><td> </td><td> </td><td> </td><td> </td></tr> <tr><td> </td><td> </td><td> </td><td> </td><td> </td></tr> <tr><td> </td><td> </td><td> </td><td> </td><td> </td></tr> <tr><td> </td><td> </td><td> </td><td> </td><td> </td></tr> <tr><td> </td><td> </td><td> </td><td> </td><td> </td></tr> </table> MAT'L: <b>0.125" (3.2 mm) ALUMINUM</b> | SYMBOL | X   | Y  | WID | HT |  |  |  |  |  |  |  |  |  |  |  |  |  |  |  |  |  |  |  |  |  |  |  |  |  |  |  |  |  |  |  |  |  |  |  |  |  |  |  |  |  |  |  |  |  |  |  |  |  |  | DESIGN BY: <b>TSP</b><br>CHECKED BY: <b>WJH</b><br>PROJECT ID: <b>I-5878</b><br>Jul 10, 2019<br>DIV: <b>6</b> |
|---|---|--------|-----|----|-----|----|--|--|--|--|--|--|--|--|--|--|--|--|--|--|--|--|--|--|--|--|--|--|--|--|--|--|--|--|--|--|--|--|--|--|--|--|--|--|--|--|--|--|--|--|--|--|--|--|--|--|---|
| SYMBOL  | X   | Y      | WID | HT |     |    |  |  |  |  |  |  |  |  |  |  |  |  |  |  |  |  |  |  |  |  |  |  |  |  |  |  |  |  |  |  |  |  |  |  |  |  |  |  |  |  |  |  |  |  |  |  |  |  |  |  |   |
|   |   |        |     |    |     |    |  |  |  |  |  |  |  |  |  |  |  |  |  |  |  |  |  |  |  |  |  |  |  |  |  |  |  |  |  |  |  |  |  |  |  |  |  |  |  |  |  |  |  |  |  |  |  |  |  |  |   |
|   |   |        |     |    |     |    |  |  |  |  |  |  |  |  |  |  |  |  |  |  |  |  |  |  |  |  |  |  |  |  |  |  |  |  |  |  |  |  |  |  |  |  |  |  |  |  |  |  |  |  |  |  |  |  |  |  |   |
|   |   |        |     |    |     |    |  |  |  |  |  |  |  |  |  |  |  |  |  |  |  |  |  |  |  |  |  |  |  |  |  |  |  |  |  |  |  |  |  |  |  |  |  |  |  |  |  |  |  |  |  |  |  |  |  |  |   |
|   |   |        |     |    |     |    |  |  |  |  |  |  |  |  |  |  |  |  |  |  |  |  |  |  |  |  |  |  |  |  |  |  |  |  |  |  |  |  |  |  |  |  |  |  |  |  |  |  |  |  |  |  |  |  |  |  |   |
|   |   |        |     |    |     |    |  |  |  |  |  |  |  |  |  |  |  |  |  |  |  |  |  |  |  |  |  |  |  |  |  |  |  |  |  |  |  |  |  |  |  |  |  |  |  |  |  |  |  |  |  |  |  |  |  |  |   |
|   |   |        |     |    |     |    |  |  |  |  |  |  |  |  |  |  |  |  |  |  |  |  |  |  |  |  |  |  |  |  |  |  |  |  |  |  |  |  |  |  |  |  |  |  |  |  |  |  |  |  |  |  |  |  |  |  |   |
|   |   |        |     |    |     |    |  |  |  |  |  |  |  |  |  |  |  |  |  |  |  |  |  |  |  |  |  |  |  |  |  |  |  |  |  |  |  |  |  |  |  |  |  |  |  |  |  |  |  |  |  |  |  |  |  |  |   |
|   |   |        |     |    |     |    |  |  |  |  |  |  |  |  |  |  |  |  |  |  |  |  |  |  |  |  |  |  |  |  |  |  |  |  |  |  |  |  |  |  |  |  |  |  |  |  |  |  |  |  |  |  |  |  |  |  |   |
|   |   |        |     |    |     |    |  |  |  |  |  |  |  |  |  |  |  |  |  |  |  |  |  |  |  |  |  |  |  |  |  |  |  |  |  |  |  |  |  |  |  |  |  |  |  |  |  |  |  |  |  |  |  |  |  |  |   |
|   |   |        |     |    |     |    |  |  |  |  |  |  |  |  |  |  |  |  |  |  |  |  |  |  |  |  |  |  |  |  |  |  |  |  |  |  |  |  |  |  |  |  |  |  |  |  |  |  |  |  |  |  |  |  |  |  |   |

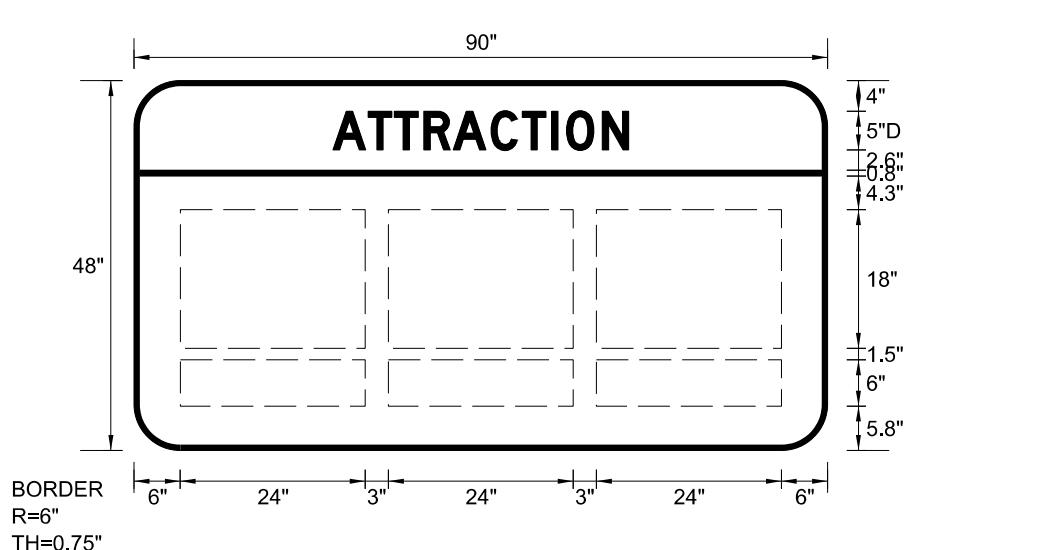

Spacing Factor is 1 unless specified otherwise

| LETTER POSITIONS                            |     |     |     |     |     |   |     |     |     |     | Series/Size |
|---|-----|-----|-----|-----|-----|---|-----|-----|-----|-----|-------------|
| Letter spacings are to start of next letter |     |     |     |     |     |   |     |     |     |     | Text Length |
| A   | T   | T   | R   | A   | C   | T | I   | O   | N   |     | D 2000      |
| 25.8  | 4.6 | 3.4 | 3.9 | 3.8 | 4.9 | 4 | 3.9 | 1.9 | 4.7 | 3.4 | 38.4        |

FILENAME: 5878\_Sign Designs NORTH CAROLINA D.O.T. SIGN DETAIL

| SIGN NUMBER: <b>109</b><br>TYPE: <b>A</b><br>QUANTITY: <b>1</b><br>SIGN WIDTH: <b>7'-6"</b><br>HEIGHT: <b>6'-0"</b><br>TOTAL AREA: <b>45.0 Sq.Ft.</b><br>BORDER TYPE: <b>FLUSH</b><br>RECESS: <b>0"</b><br>WIDTH: <b>0.75"</b><br>RADII: <b>6"</b><br>NO. Z BARS: <b>2</b><br>LENGTH: <b>82.0</b> | BACKG COLOR: <b>Green</b><br>COPY COLOR: <b>White</b><br>SYMBOLOGY TABLE:<br><table border="1"> <tr><th>SYMBOL</th><th>X</th><th>Y</th><th>WID</th><th>HT</th></tr> <tr><td> </td><td> </td><td> </td><td> </td><td> </td></tr> <tr><td> </td><td> </td><td> </td><td> </td><td> </td></tr> <tr><td> </td><td> </td><td> </td><td> </td><td> </td></tr> <tr><td> </td><td> </td><td> </td><td> </td><td> </td></tr> <tr><td> </td><td> </td><td> </td><td> </td><td> </td></tr> <tr><td> </td><td> </td><td> </td><td> </td><td> </td></tr> <tr><td> </td><td> </td><td> </td><td> </td><td> </td></tr> <tr><td> </td><td> </td><td> </td><td> </td><td> </td></tr> <tr><td> </td><td> </td><td> </td><td> </td><td> </td></tr> <tr><td> </td><td> </td><td> </td><td> </td><td> </td></tr> </table> MAT'L: <b>0.125" (3.2 mm) ALUMINUM</b> | SYMBOL | X   | Y  | WID | HT |  |  |  |  |  |  |  |  |  |  |  |  |  |  |  |  |  |  |  |  |  |  |  |  |  |  |  |  |  |  |  |  |  |  |  |  |  |  |  |  |  |  |  |  |  |  |  |  |  |  | DESIGN BY: <b>TSP</b><br>CHECKED BY: <b>WJH</b><br>PROJECT ID: <b>I-5878</b><br>Jul 10, 2019<br>DIV: <b>6</b> |
|---|---|--------|-----|----|-----|----|--|--|--|--|--|--|--|--|--|--|--|--|--|--|--|--|--|--|--|--|--|--|--|--|--|--|--|--|--|--|--|--|--|--|--|--|--|--|--|--|--|--|--|--|--|--|--|--|--|--|---|
| SYMBOL  | X   | Y      | WID | HT |     |    |  |  |  |  |  |  |  |  |  |  |  |  |  |  |  |  |  |  |  |  |  |  |  |  |  |  |  |  |  |  |  |  |  |  |  |  |  |  |  |  |  |  |  |  |  |  |  |  |  |  |   |
|   |   |        |     |    |     |    |  |  |  |  |  |  |  |  |  |  |  |  |  |  |  |  |  |  |  |  |  |  |  |  |  |  |  |  |  |  |  |  |  |  |  |  |  |  |  |  |  |  |  |  |  |  |  |  |  |  |   |
|   |   |        |     |    |     |    |  |  |  |  |  |  |  |  |  |  |  |  |  |  |  |  |  |  |  |  |  |  |  |  |  |  |  |  |  |  |  |  |  |  |  |  |  |  |  |  |  |  |  |  |  |  |  |  |  |  |   |
|   |   |        |     |    |     |    |  |  |  |  |  |  |  |  |  |  |  |  |  |  |  |  |  |  |  |  |  |  |  |  |  |  |  |  |  |  |  |  |  |  |  |  |  |  |  |  |  |  |  |  |  |  |  |  |  |  |   |
|   |   |        |     |    |     |    |  |  |  |  |  |  |  |  |  |  |  |  |  |  |  |  |  |  |  |  |  |  |  |  |  |  |  |  |  |  |  |  |  |  |  |  |  |  |  |  |  |  |  |  |  |  |  |  |  |  |   |
|   |   |        |     |    |     |    |  |  |  |  |  |  |  |  |  |  |  |  |  |  |  |  |  |  |  |  |  |  |  |  |  |  |  |  |  |  |  |  |  |  |  |  |  |  |  |  |  |  |  |  |  |  |  |  |  |  |   |
|   |   |        |     |    |     |    |  |  |  |  |  |  |  |  |  |  |  |  |  |  |  |  |  |  |  |  |  |  |  |  |  |  |  |  |  |  |  |  |  |  |  |  |  |  |  |  |  |  |  |  |  |  |  |  |  |  |   |
|   |   |        |     |    |     |    |  |  |  |  |  |  |  |  |  |  |  |  |  |  |  |  |  |  |  |  |  |  |  |  |  |  |  |  |  |  |  |  |  |  |  |  |  |  |  |  |  |  |  |  |  |  |  |  |  |  |   |
|   |   |        |     |    |     |    |  |  |  |  |  |  |  |  |  |  |  |  |  |  |  |  |  |  |  |  |  |  |  |  |  |  |  |  |  |  |  |  |  |  |  |  |  |  |  |  |  |  |  |  |  |  |  |  |  |  |   |
|   |   |        |     |    |     |    |  |  |  |  |  |  |  |  |  |  |  |  |  |  |  |  |  |  |  |  |  |  |  |  |  |  |  |  |  |  |  |  |  |  |  |  |  |  |  |  |  |  |  |  |  |  |  |  |  |  |   |
|   |   |        |     |    |     |    |  |  |  |  |  |  |  |  |  |  |  |  |  |  |  |  |  |  |  |  |  |  |  |  |  |  |  |  |  |  |  |  |  |  |  |  |  |  |  |  |  |  |  |  |  |  |  |  |  |  |   |

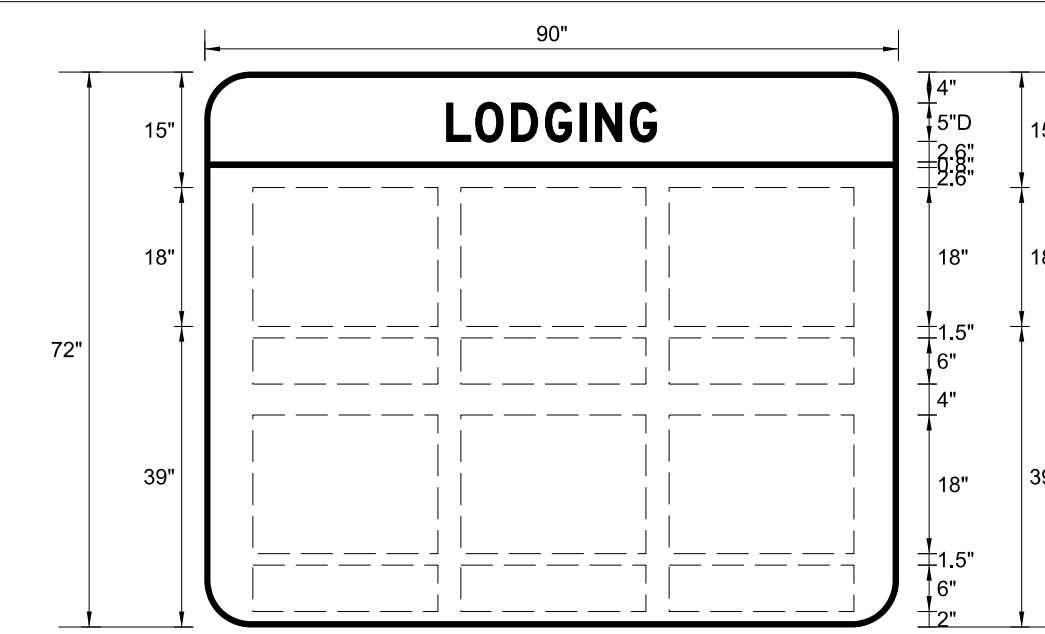



Spacing Factor is 1 unless specified otherwise

| LETTER POSITIONS                            |     |     |     |     |   |     |     |      |  |  | Series/Size |
|---|-----|-----|-----|-----|---|-----|-----|------|--|--|-------------|
| Letter spacings are to start of next letter |     |     |     |     |   |     |     |      |  |  | Text Length |
| L   | O   | D   | G   | I   | N | G   |     |      |  |  | D 2000      |
| 31.4  | 3.8 | 4.7 | 4.4 | 4.5 | 2 | 4.5 | 3.4 | 31.4 |  |  | 27.2        |

FILENAME: 5878\_Sign Designs NORTH CAROLINA D.O.T. SIGN DETAIL

3/15/2021 11:25:07 AM User: J. Wendt

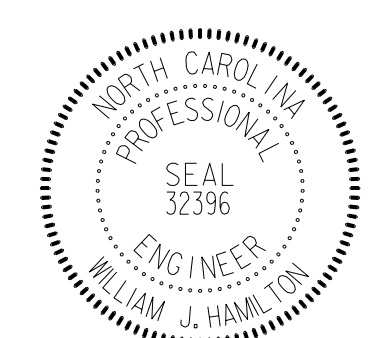
SIGN DESIGNS

|   |           |
|---|-----------|
| TIP NO.   | SHEET NO. |
| I - 5878  | SIGN - 4H |
| APPROVED: <i>William J. Hamilton</i><br>Date Signed: 3/15/2021  |           |
| DATE: 3/15/2021   |           |
| SEAL<br>   |           |
| DOCUMENT NOT CONSIDERED FINAL<br>UNLESS ALL SIGNATURES COMPLETED  |           |
| <br><b>RAMEY KEMP ASSOCIATES</b><br>5808 Faringdon Place<br>Raleigh, North Carolina 27609<br>Phone: 919-872-5115<br>NC License No. C-0910<br>www.rameykemp.com |           |

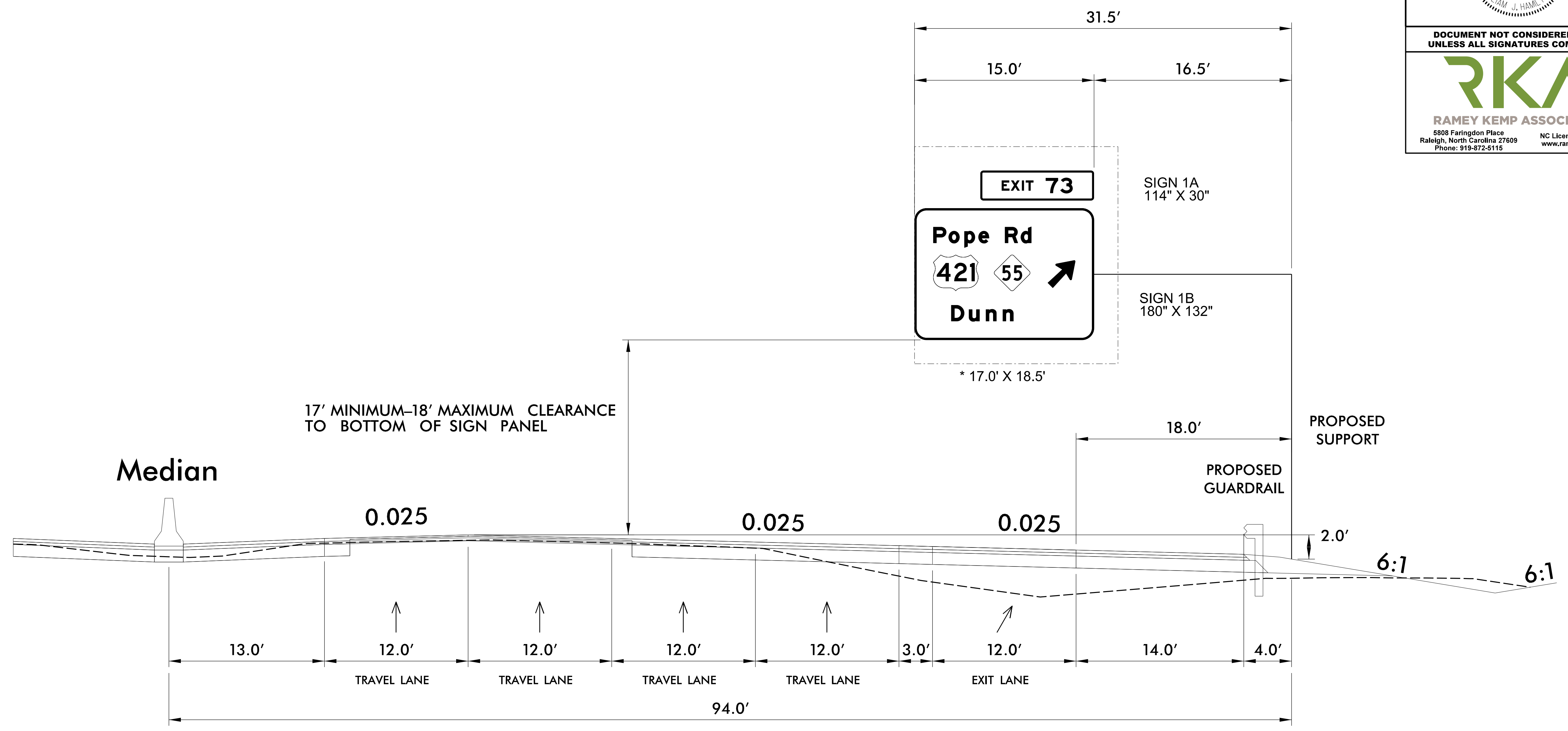

# I-95 Northbound



**NOTES:**

- IF THE CONTRACTOR BIDS ALUMINUM SIGN STRUCTURE, EACH SHALL BE PROVIDED WITH AN APPROVED HIGHWAY TRUSS DAMPER DEVICE IN ACCORDANCE WITH AASHTO SPECIFICATIONS.
- MOUNT SIGNS VERTICALLY CENTERED ON HORIZONTAL MEMBER OF STRUCTURE.
- FIELD VERIFICATION SHALL BE REQUIRED FOR ALL FOOTING ELEVATIONS, PER THE LATEST NCDOT STANDARD SPECIFICATIONS FOR ROADS AND STRUCTURES. PROVIDE FIELD VERIFICATION TO THE SIGNING SECTION.
- THE TOP OF THE FOOTING SHALL EXTEND AT LEAST 4 INCHES AND NOT MORE THAN 24 INCHES ABOVE THE HIGHEST POINT OF THE GROUND SURFACE AT THE FOOTING.
- SIGN HANGERS AND ATTACHMENT HARDWARE SHALL BE PROVIDED AND INSTALLED ON THE ASSEMBLY TO ACCOMMODATE ALL SIGNS SHOWN IN THIS PLAN SHEET.
- DESIGN AND CONSTRUCTION REQUIREMENTS FOR SIGN STRUCTURES SHALL ACCOMMODATE WIND VELOCITY OF 110 M.P.H.

\* THESE DIMENSIONS SHALL BE USED FOR WIND LOAD AND DEAD LOAD COMPUTATIONS IN DESIGN OF STRUCTURE AND FOOTINGS. DESIGN AND CONSTRUCTION REQUIREMENTS FOR SIGN STRUCTURES SHALL ACCOMMODATE WIND VELOCITY OF 110 M.P.H.

**OVERHEAD SIGN ASSEMBLY "A"**  
**STA 956+67 -L-**

3/15/2021 11:25:00 AM \\0301159866-Sgn\_Sign4H-01141.dgn User:J.Wenct

|   |           |
|---|-----------|
| TIP NO.   | SHEET NO. |
| I - 5878  | SIGN - 4I |
| APPROVED <i>William J. Hamilton</i><br>3/15/2021  |           |
| DATE: 3/15/2021   |           |
| SEAL<br>   |           |
| DOCUMENT NOT CONSIDERED FINAL<br>UNLESS ALL SIGNATURES COMPLETED  |           |
| <br><b>RAMEY KEMP ASSOCIATES</b><br>5808 Faringdon Place<br>Raleigh, North Carolina 27609<br>Phone: 919-872-5115<br>NC License No. C-0910<br>www.rameykemp.com |           |

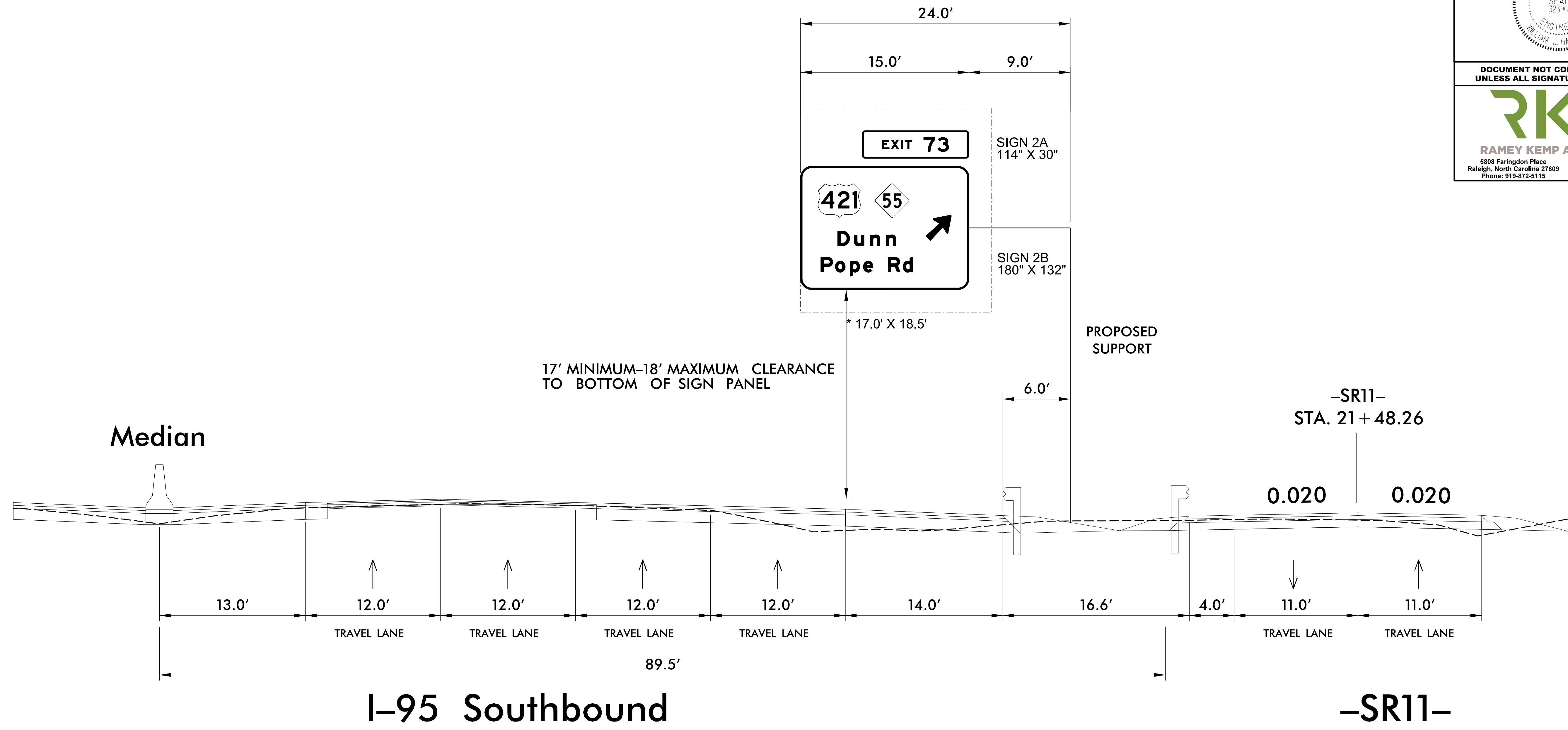

NOTES:

- IF THE CONTRACTOR BIDS ALUMINUM SIGN STRUCTURE, EACH SHALL BE PROVIDED WITH AN APPROVED HIGHWAY TRUSS DAMPER DEVICE IN ACCORDANCE WITH AASHTO SPECIFICATIONS.
- MOUNT SIGNS VERTICALLY CENTERED ON HORIZONTAL MEMBER OF STRUCTURE.
- FIELD VERIFICATION SHALL BE REQUIRED FOR ALL FOOTING ELEVATIONS, PER THE LATEST NCDOT STANDARD SPECIFICATIONS FOR ROADS AND STRUCTURES. PROVIDE FIELD VERIFICATION TO THE SIGNING SECTION.
- THE TOP OF THE FOOTING SHALL EXTEND AT LEAST 4 INCHES AND NOT MORE THAN 24 INCHES ABOVE THE HIGHEST POINT OF THE GROUND SURFACE AT THE FOOTING.
- SIGN HANGERS AND ATTACHMENT HARDWARE SHALL BE PROVIDED AND INSTALLED ON THE ASSEMBLY TO ACCOMMODATE ALL SIGNS SHOWN IN THIS PLAN SHEET.
- DESIGN AND CONSTRUCTION REQUIREMENTS FOR SIGN STRUCTURES SHALL ACCOMMODATE WIND VELOCITY OF 110 M.P.H.

\* THESE DIMENSIONS SHALL BE USED FOR WIND LOAD AND DEAD LOAD COMPUTATIONS IN DESIGN OF STRUCTURE AND FOOTINGS. DESIGN AND CONSTRUCTION REQUIREMENTS FOR SIGN STRUCTURES SHALL ACCOMMODATE WIND VELOCITY OF 110 M.P.H.

**OVERHEAD SIGN ASSEMBLY "B"**  
**STA 1019+50 -L-**

3/26/2021 11:25:00 AM User:tpoeika

|   |           |
|---|-----------|
| TIP NO.   | SHEET NO. |
| I - 5878  | SIGN - 4J |
| APPROVED: <i>William J. Hamilton</i>  |           |
| DATE: 3/15/2021   |           |
| SEAL  |           |
|   |           |
| DOCUMENT NOT CONSIDERED FINAL<br>UNLESS ALL SIGNATURES COMPLETED  |           |
|   |           |
| RAMEY KEMP ASSOCIATES<br>5808 Faringdon Place<br>Raleigh, North Carolina 27609<br>Phone: 919-872-5115<br>NC License No. C-0910<br>www.rameykemp.com |           |

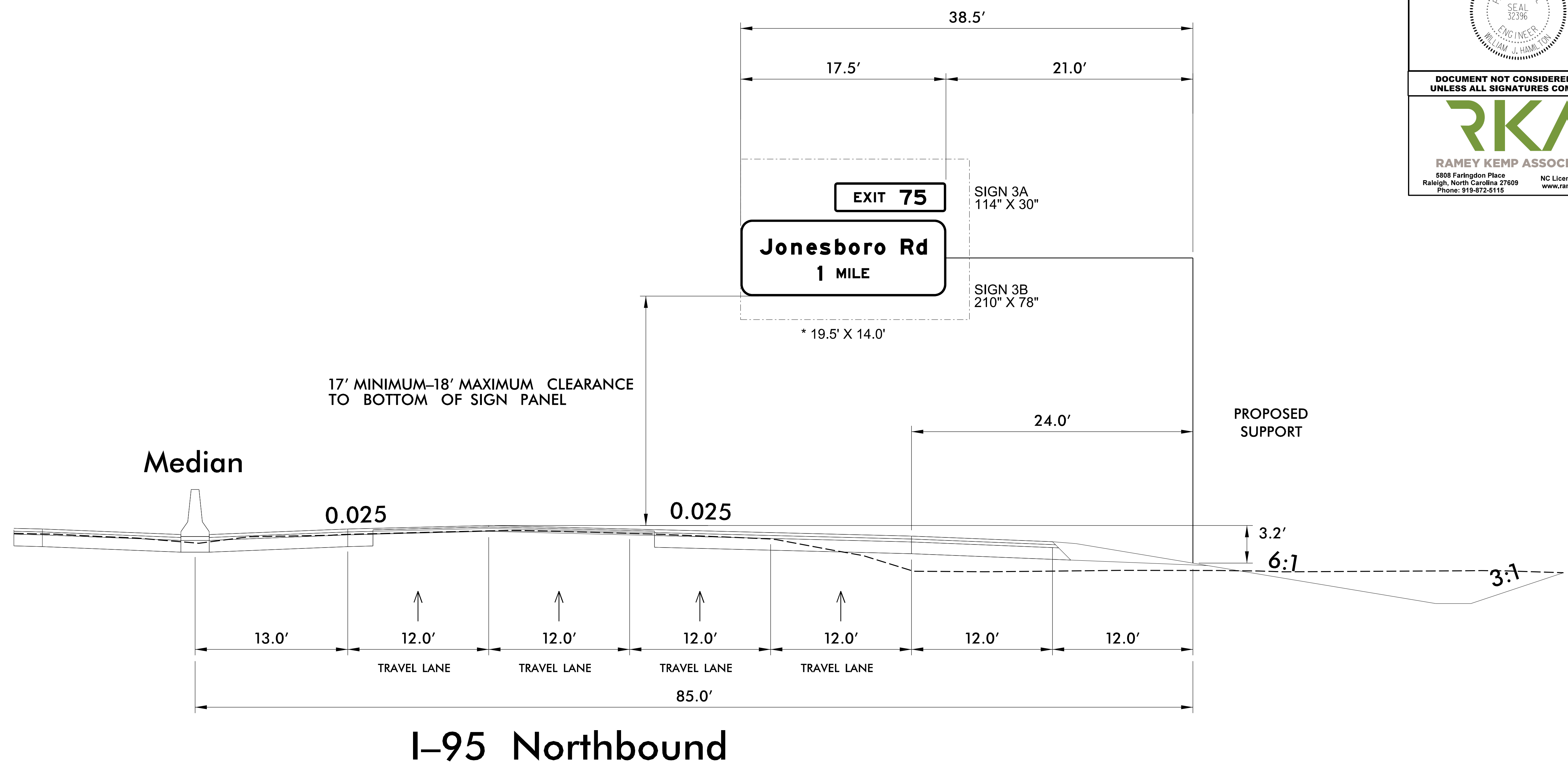



**NOTES:**

- IF THE CONTRACTOR BIDS ALUMINUM SIGN STRUCTURE, EACH SHALL BE PROVIDED WITH AN APPROVED HIGHWAY TRUSS DAMPER DEVICE IN ACCORDANCE WITH AASHTO SPECIFICATIONS.
- MOUNT SIGNS VERTICALLY CENTERED ON HORIZONTAL MEMBER OF STRUCTURE.
- FIELD VERIFICATION SHALL BE REQUIRED FOR ALL FOOTING ELEVATIONS, PER THE LATEST NCDOT STANDARD SPECIFICATIONS FOR ROADS AND STRUCTURES. PROVIDE FIELD VERIFICATION TO THE SIGNING SECTION.
- THE TOP OF THE FOOTING SHALL EXTEND AT LEAST 4 INCHES AND NOT MORE THAN 24 INCHES ABOVE THE HIGHEST POINT OF THE GROUND SURFACE AT THE FOOTING.
- SIGN HANGERS AND ATTACHMENT HARDWARE SHALL BE PROVIDED AND INSTALLED ON THE ASSEMBLY TO ACCOMMODATE ALL SIGNS SHOWN IN THIS PLAN SHEET.
- DESIGN AND CONSTRUCTION REQUIREMENTS FOR SIGN STRUCTURES SHALL ACCOMMODATE WIND VELOCITY OF 110 M.P.H.

\* THESE DIMENSIONS SHALL BE USED FOR WIND LOAD AND DEAD LOAD COMPUTATIONS IN DESIGN OF STRUCTURE AND FOOTINGS. DESIGN AND CONSTRUCTION REQUIREMENTS FOR SIGN STRUCTURES SHALL ACCOMMODATE WIND VELOCITY OF 110 M.P.H.

**OVERHEAD SIGN ASSEMBLY "C"**  
**STA 1034+40 -L-**

3/15/2021  
 User: J. Weinst

|  |           |
|--|-----------|
| TIP NO.  | SHEET NO. |
| I - 5878   | SIGN - 4K |
| APPROVED: <i>William J. Hamilton</i><br><small>AD5500704848484</small>   |           |
| DATE: 3/15/2021  |           |
| SEAL<br>  |           |
| DOCUMENT NOT CONSIDERED FINAL<br>UNLESS ALL SIGNATURES COMPLETED   |           |
| <br><b>RAMEY KEMP ASSOCIATES</b><br><small>5808 Faringdon Place<br/>                 Raleigh, North Carolina 27609<br/>                 Phone: 919-872-5115</small> |           |

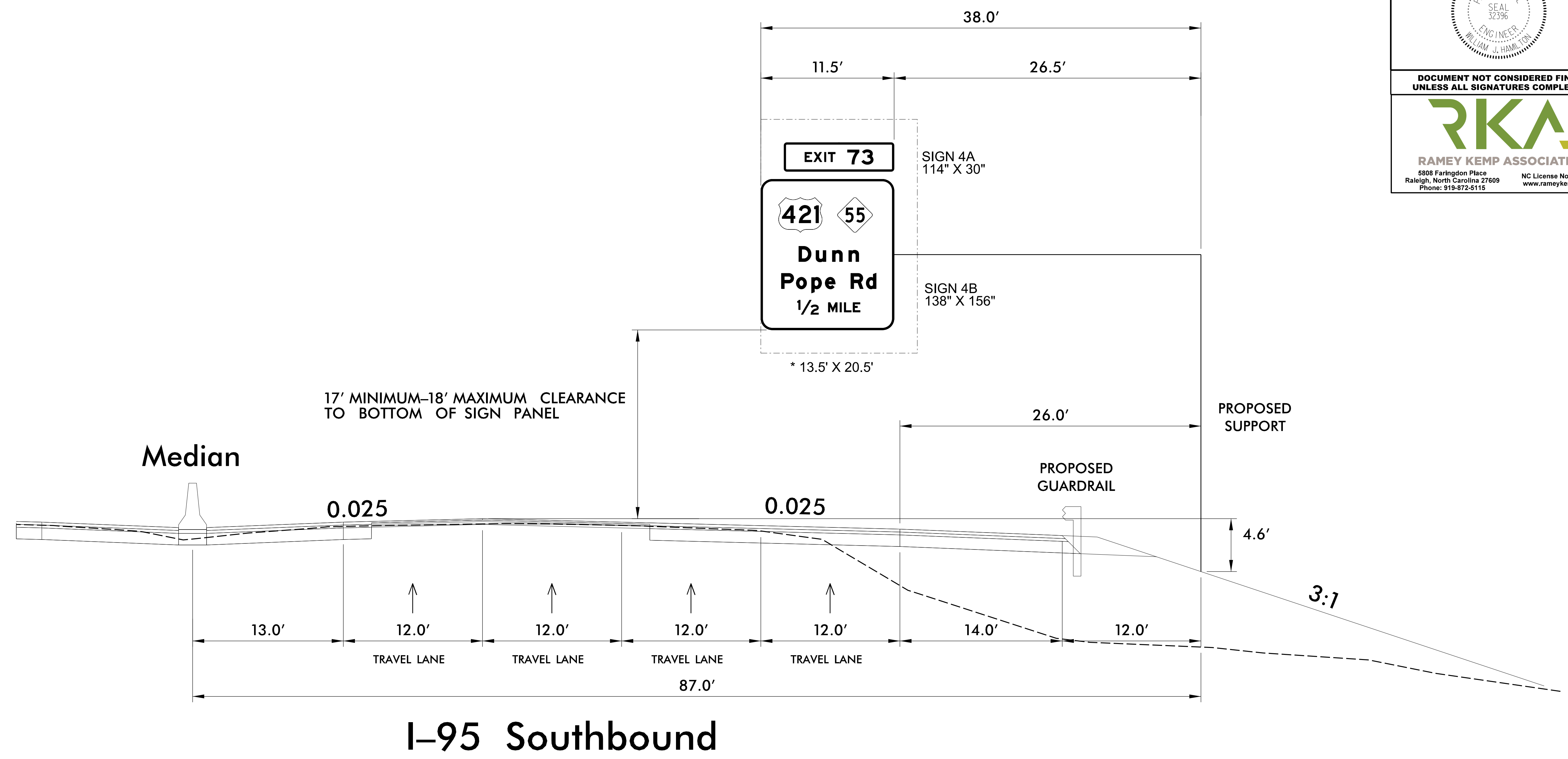

## I-95 Southbound

**NOTES:**



- IF THE CONTRACTOR BIDS ALUMINUM SIGN STRUCTURE, EACH SHALL BE PROVIDED WITH AN APPROVED HIGHWAY TRUSS DAMPER DEVICE IN ACCORDANCE WITH AASHTO SPECIFICATIONS.
- MOUNT SIGNS VERTICALLY CENTERED ON HORIZONTAL MEMBER OF STRUCTURE.
- FIELD VERIFICATION SHALL BE REQUIRED FOR ALL FOOTING ELEVATIONS, PER THE LATEST NCDOT STANDARD SPECIFICATIONS FOR ROADS AND STRUCTURES. PROVIDE FIELD VERIFICATION TO THE SIGNING SECTION.
- THE TOP OF THE FOOTING SHALL EXTEND AT LEAST 4 INCHES AND NOT MORE THAN 24 INCHES ABOVE THE HIGHEST POINT OF THE GROUND SURFACE AT THE FOOTING.
- SIGN HANGERS AND ATTACHMENT HARDWARE SHALL BE PROVIDED AND INSTALLED ON THE ASSEMBLY TO ACCOMMODATE ALL SIGNS SHOWN IN THIS PLAN SHEET.
- DESIGN AND CONSTRUCTION REQUIREMENTS FOR SIGN STRUCTURES SHALL ACCOMMODATE WIND VELOCITY OF 110 M.P.H.

\* THESE DIMENSIONS SHALL BE USED FOR WIND LOAD AND DEAD LOAD COMPUTATIONS IN DESIGN OF STRUCTURE AND FOOTINGS. DESIGN AND CONSTRUCTION REQUIREMENTS FOR SIGN STRUCTURES SHALL ACCOMMODATE WIND VELOCITY OF 110 M.P.H.

**OVERHEAD SIGN ASSEMBLY "D"**  
**STA 1044+00 -L-**

3/15/2021  
 User: J. Weinst



|   |           |
|---|-----------|
| TIP NO.   | SHEET NO. |
| I - 5878  | SIGN - 4L |
| APPROVED: <i>William J. Hamilton</i><br>0352007704648484  |           |
| DATE: 3/15/2021   |           |
| SEAL<br>   |           |
| DOCUMENT NOT CONSIDERED FINAL<br>UNLESS ALL SIGNATURES COMPLETED  |           |
| <br><b>RAMEY KEMP ASSOCIATES</b><br>5808 Faringdon Place<br>Raleigh, North Carolina 27609<br>Phone: 919-872-5115<br>NC License No. C-0910<br>www.rameykemp.com |           |

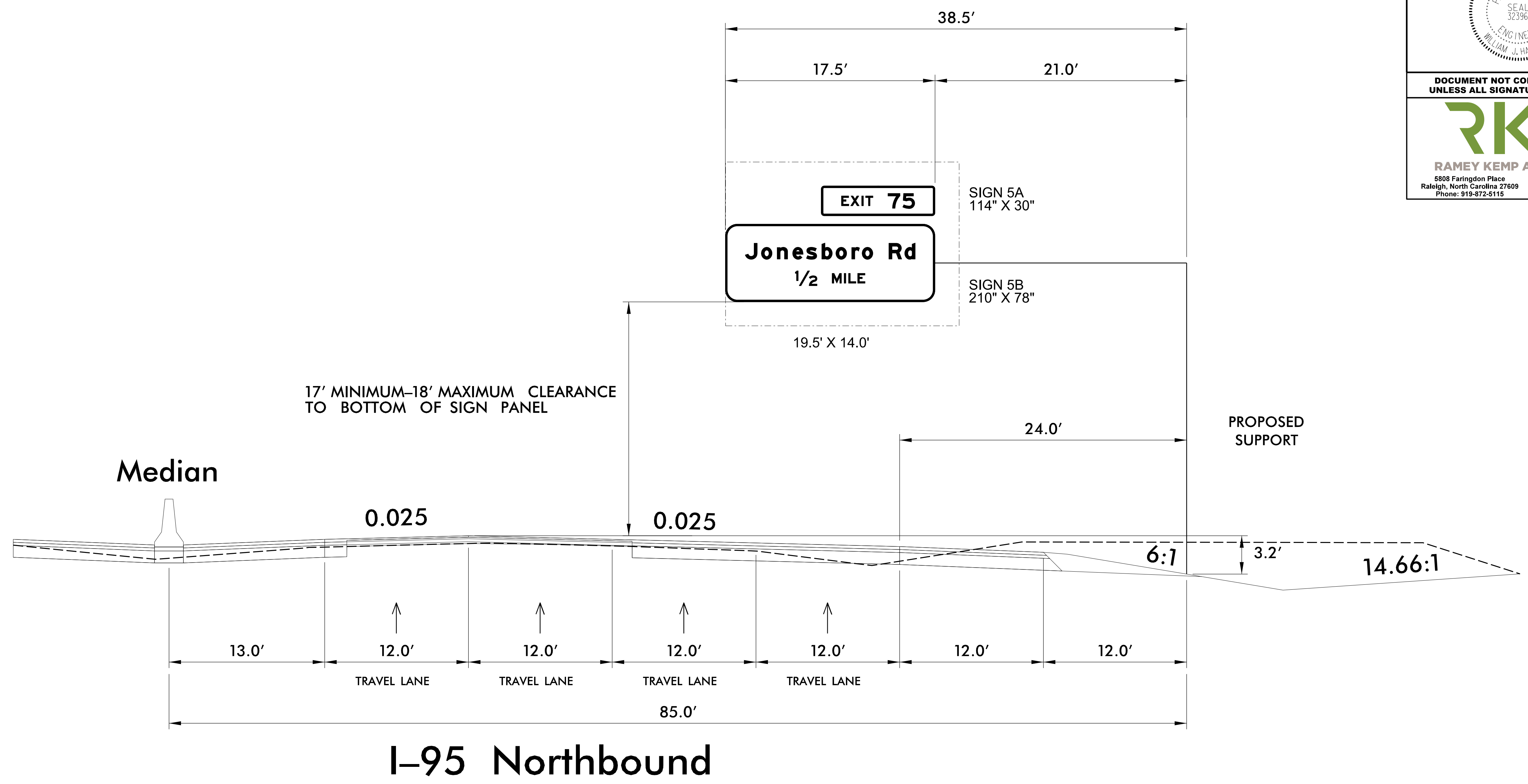



**NOTES:**

- IF THE CONTRACTOR BIDS ALUMINUM SIGN STRUCTURE, EACH SHALL BE PROVIDED WITH AN APPROVED HIGHWAY TRUSS DAMPER DEVICE IN ACCORDANCE WITH AASHTO SPECIFICATIONS.
- MOUNT SIGNS VERTICALLY CENTERED ON HORIZONTAL MEMBER OF STRUCTURE.
- FIELD VERIFICATION SHALL BE REQUIRED FOR ALL FOOTING ELEVATIONS, PER THE LATEST NCDOT STANDARD SPECIFICATIONS FOR ROADS AND STRUCTURES. PROVIDE FIELD VERIFICATION TO THE SIGNING SECTION.
- THE TOP OF THE FOOTING SHALL EXTEND AT LEAST 4 INCHES AND NOT MORE THAN 24 INCHES ABOVE THE HIGHEST POINT OF THE GROUND SURFACE AT THE FOOTING.
- SIGN HANGERS AND ATTACHMENT HARDWARE SHALL BE PROVIDED AND INSTALLED ON THE ASSEMBLY TO ACCOMMODATE ALL SIGNS SHOWN IN THIS PLAN SHEET.
- DESIGN AND CONSTRUCTION REQUIREMENTS FOR SIGN STRUCTURES SHALL ACCOMMODATE WIND VELOCITY OF 110 M.P.H.

\* THESE DIMENSIONS SHALL BE USED FOR WIND LOAD AND DEAD LOAD COMPUTATIONS IN DESIGN OF STRUCTURE AND FOOTINGS. DESIGN AND CONSTRUCTION REQUIREMENTS FOR SIGN STRUCTURES SHALL ACCOMMODATE WIND VELOCITY OF 110 M.P.H.

**OVERHEAD SIGN ASSEMBLY "E"**  
**STA 1060+60 -L-**

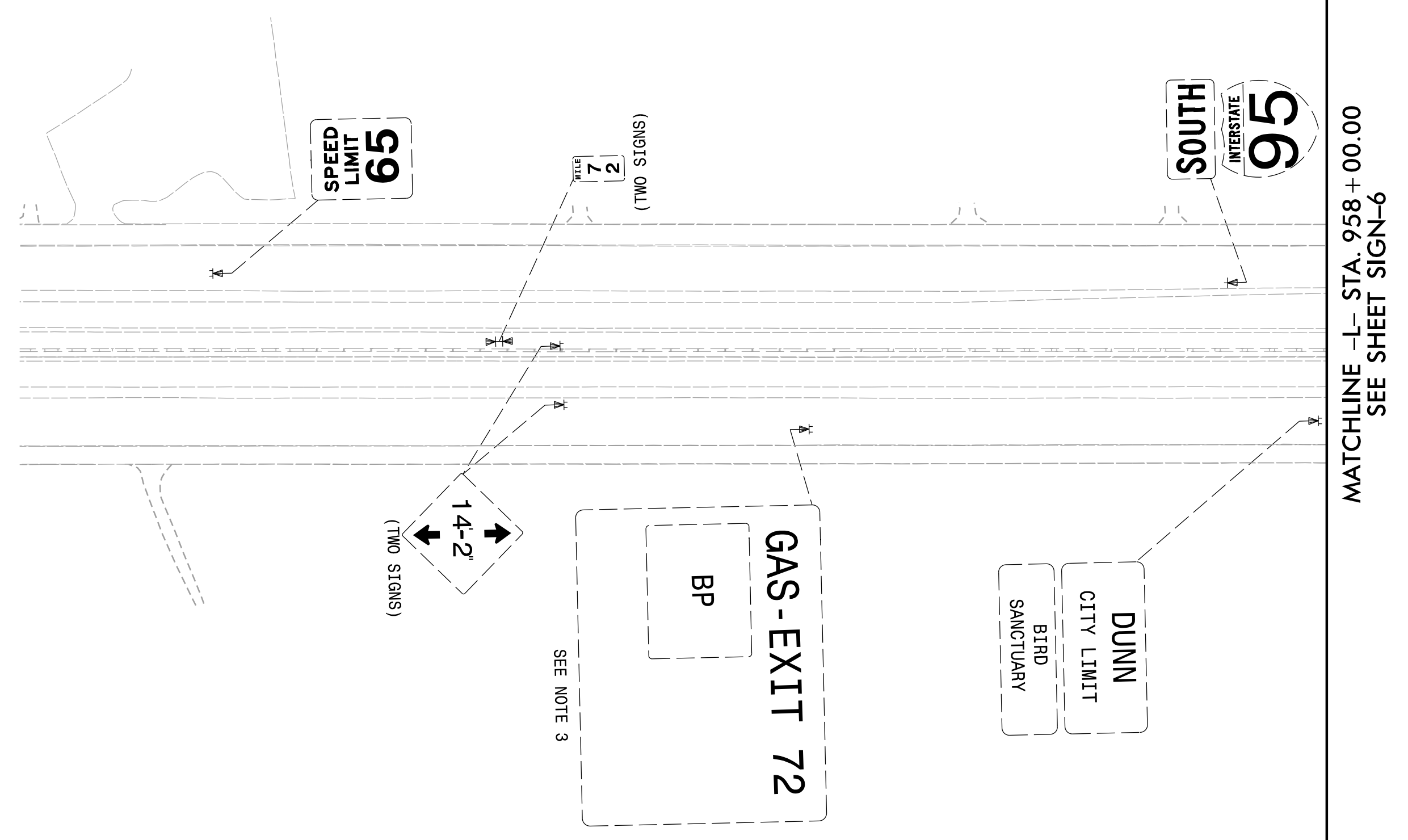
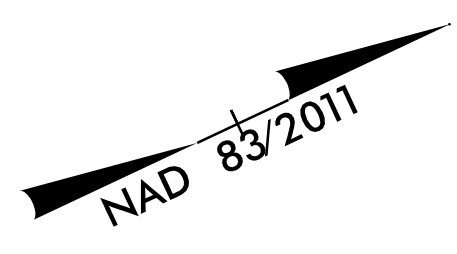

3/15/2021 11:25:00 AM 034\_159868\_Sign\_Sign4L\_011415.dgn User: j.wenct

|  |           |
|--|-----------|
| TIP NO.  | SHEET NO. |
| I - 5878   | SIGN - 5  |
| APPROVED: <i>William J. Hamilton</i><br><small>ADDRESS: 7104648484</small>   |           |
| DATE: 3/15/2021  |           |
| SEAL   |           |
|   |           |
| <b>DOCUMENT NOT CONSIDERED FINAL<br/>UNLESS ALL SIGNATURES COMPLETED</b>   |           |
| <br><b>RAMEY KEMP ASSOCIATES</b><br><small>5808 Faringdon Place<br/>Raleigh, North Carolina 27609<br/>Phone: 919-872-5115</small> |           |
| <small>NC License No. C-0910<br/>www.rameykemp.com</small>   |           |



SEE PROJECT NOTE 1 FOR ALL  
SIGN SYSTEMS THIS SHEET  
UNLESS OTHERWISE NOTED

**EXISTING SIGNS**

|  |                     |
|--|---------------------|
| TIP NO.<br>I - 5878  | SHEET NO.<br>SIGN-6 |
| APPROVED: <i>William J. Hamilton</i><br>Professional Engineer<br>No. 3500070648484   |                     |
| DATE: 3/15/2021  |                     |
| SEAL<br>  |                     |
| DOCUMENT NOT CONSIDERED FINAL<br>UNLESS ALL SIGNATURES COMPLETED   |                     |
| <br><b>RKA</b><br>RAMEY KEMP ASSOCIATES<br>5808 Faringdon Place<br>Raleigh, North Carolina 27609<br>Phone: 919-872-5115<br>NC License No. C-0910<br>www.rameykemp.com |                     |

SEE PROJECT NOTE 1 FOR ALL SIGN SYSTEMS THIS SHEET UNLESS OTHERWISE NOTED

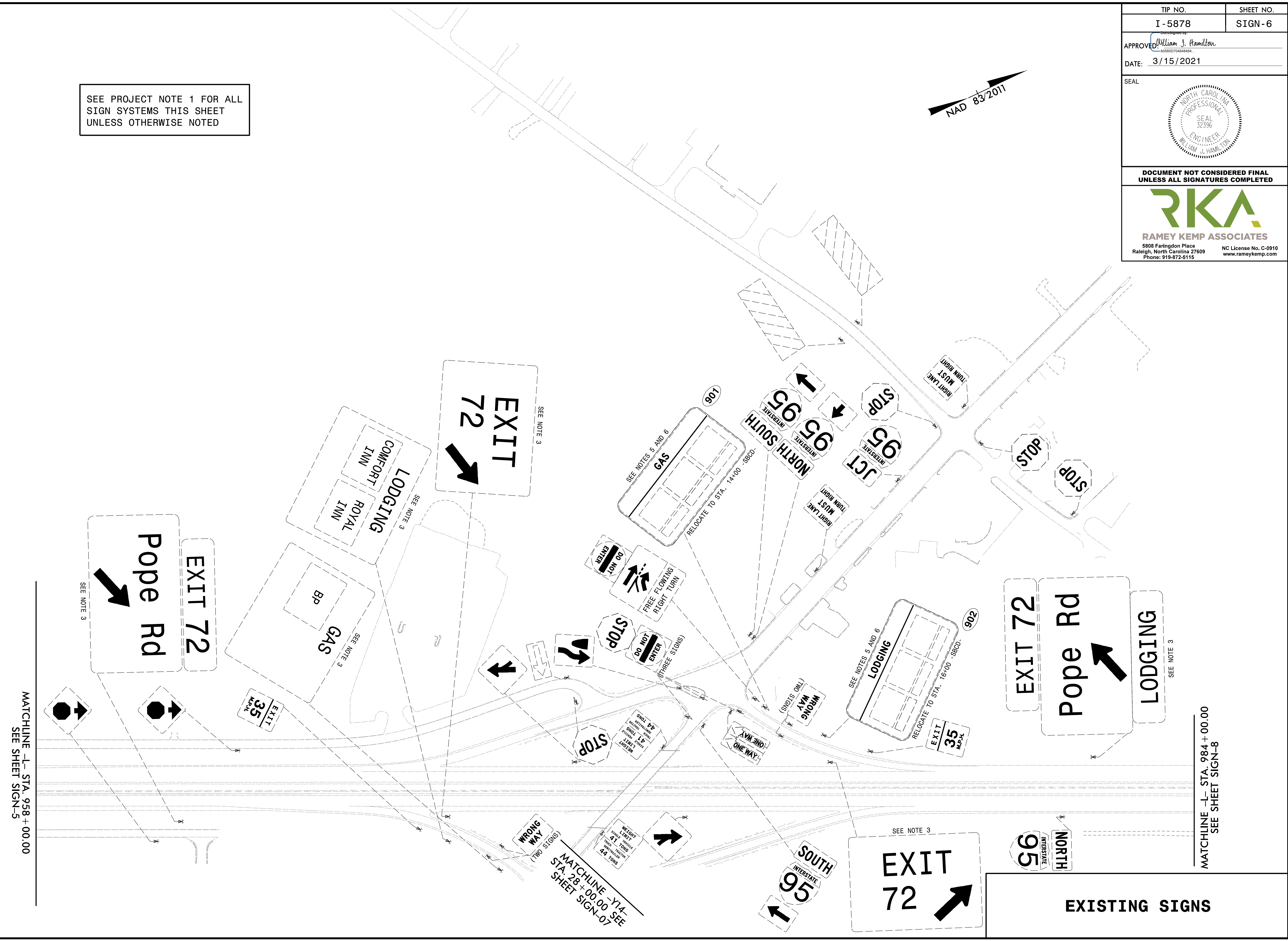



MATCHLINE -L- STA. 958+00.00  
SEE SHEET SIGN-5

MATCHLINE -Y1- STA. 28+00.00 SEE SHEET SIGN-07

MATCHLINE -L- STA. 984+00.00  
SEE SHEET SIGN-8

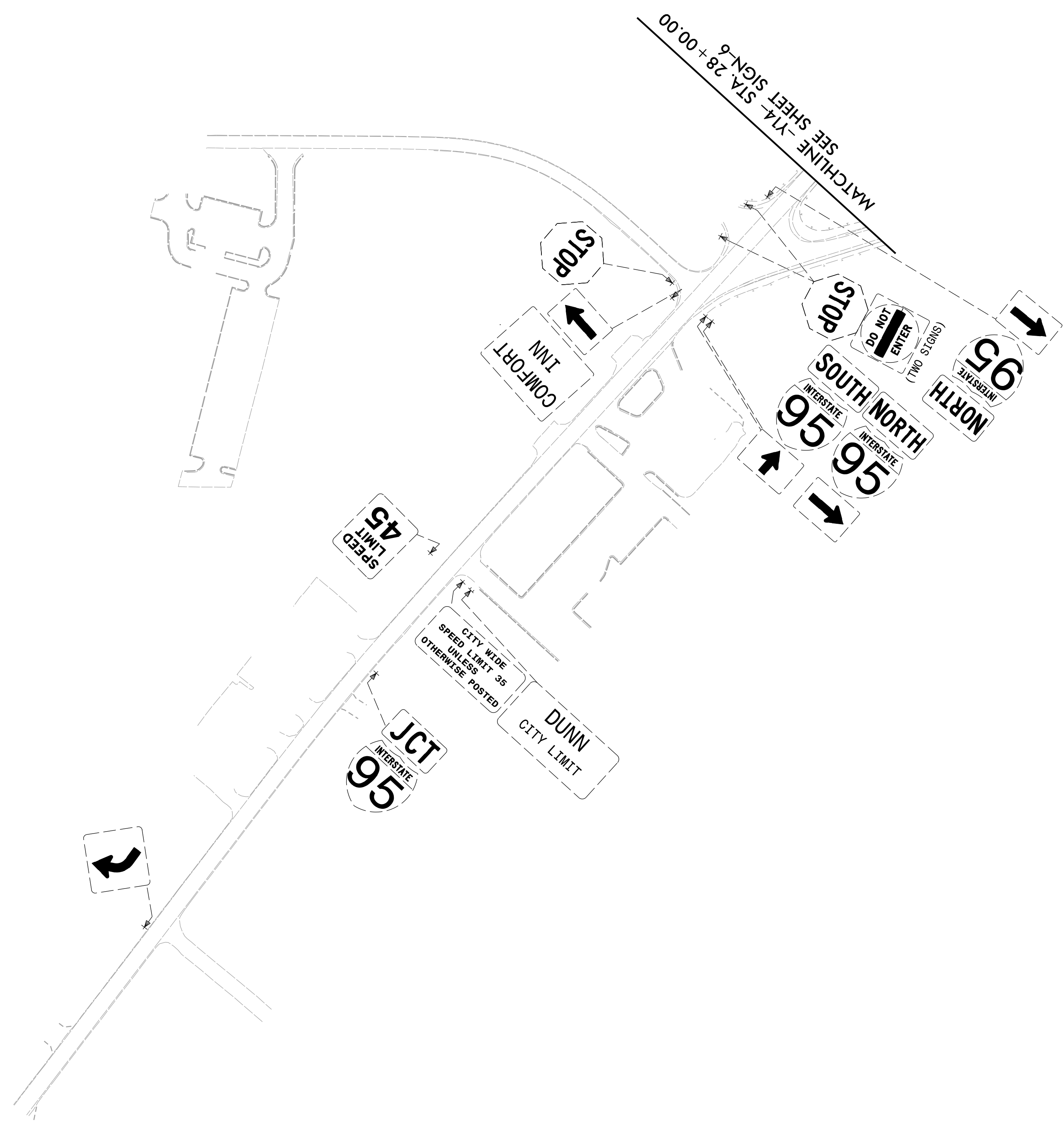

EXISTING SIGNS

|  |           |
|--|-----------|
| TIP NO.  | SHEET NO. |
| I - 5878   | SIGN - 7  |
| APPROVED: <i>William J. Hamilton</i><br><small>20562070646484</small>  |           |
| DATE: 3/15/2021  |           |
| SEAL   |           |
|   |           |
| <b>DOCUMENT NOT CONSIDERED FINAL<br/>UNLESS ALL SIGNATURES COMPLETED</b>   |           |
| <br><b>RAMEY KEMP ASSOCIATES</b><br><small>5808 Faringdon Place<br/>Raleigh, North Carolina 27609<br/>Phone: 919-872-5115</small><br><small>NC License No. C-0910<br/>www.rameykemp.com</small> |           |



SEE PROJECT NOTE 1 FOR ALL  
SIGN SYSTEMS THIS SHEET  
UNLESS OTHERWISE NOTED

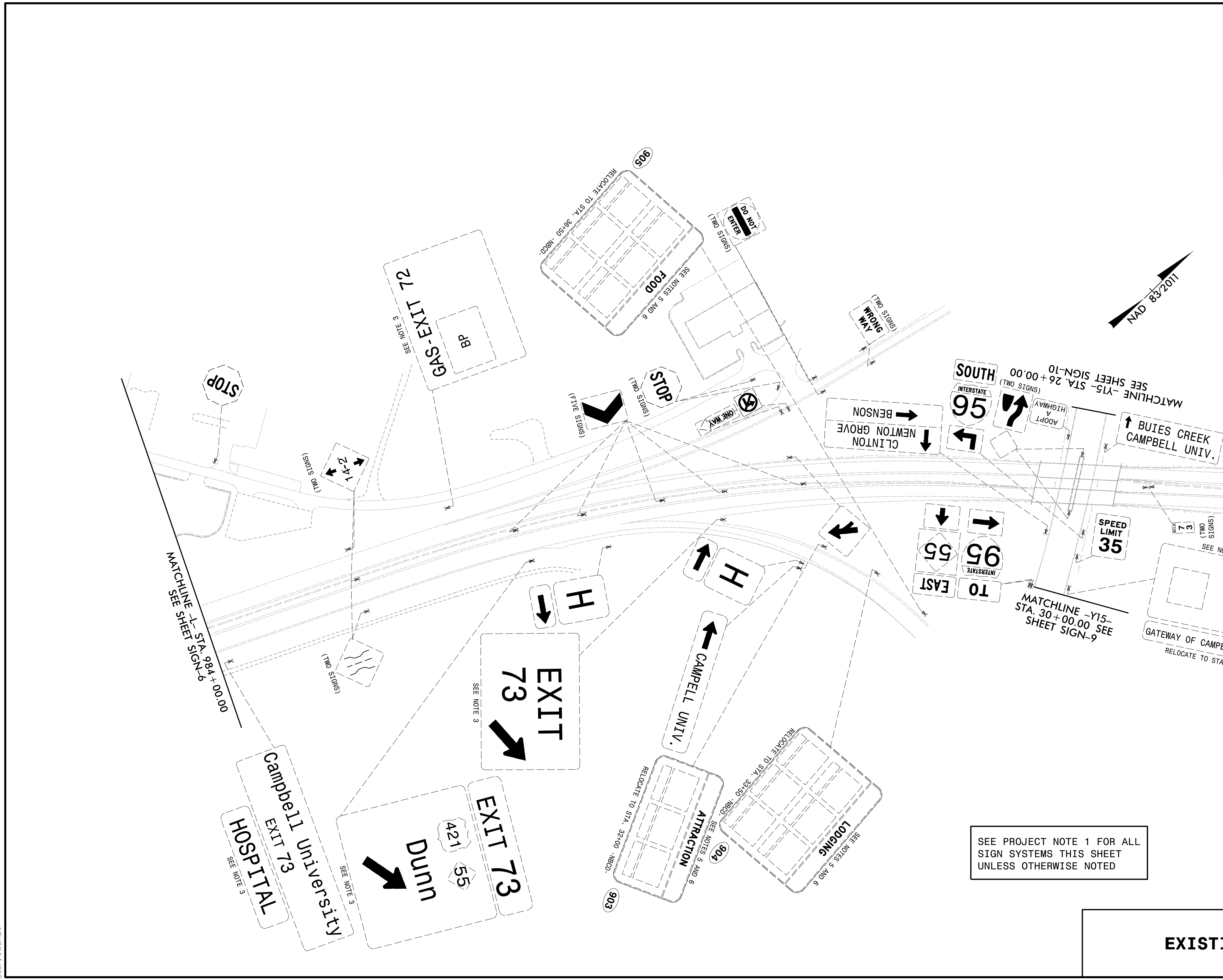

**EXISTING SIGNS**

|  |           |
|--|-----------|
| TIP NO.  | SHEET NO. |
| I-5878   | SIGN-8    |
| APPROVED: <i>William J. Hamilton</i><br><small>45560370468484</small>  |           |
| DATE: 3/15/2021  |           |
| SEAL   |           |
|   |           |
| <b>DOCUMENT NOT CONSIDERED FINAL<br/>UNLESS ALL SIGNATURES COMPLETED</b>   |           |
| <br><b>RAMEY KEMP ASSOCIATES</b><br><small>5808 Faringdon Place<br/>Raleigh, North Carolina 27609<br/>Phone: 919-872-5115</small><br><small>NC License No. C-0910<br/>www.rameykemp.com</small> |           |



SEE PROJECT NOTE 1 FOR ALL SIGN SYSTEMS THIS SHEET UNLESS OTHERWISE NOTED

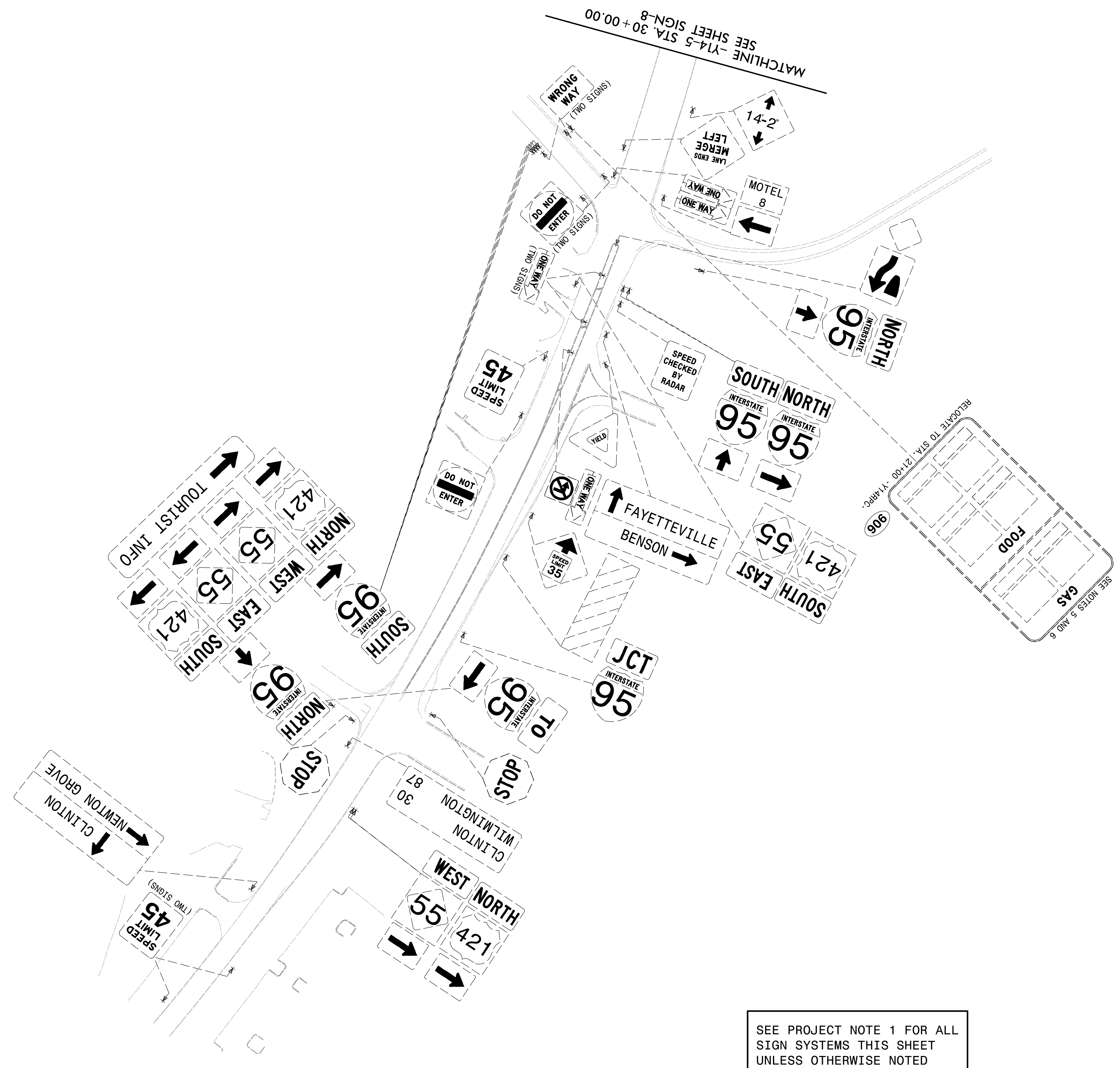
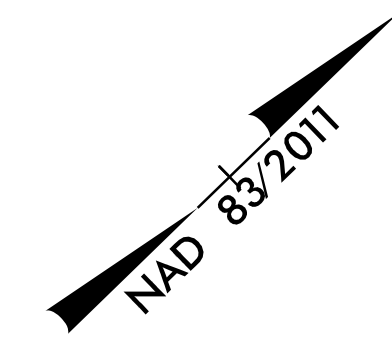

**EXISTING SIGNS**

|   |           |
|---|-----------|
| TIP NO.   | SHEET NO. |
| I - 5878  | SIGN - 9  |
| APPROVED: <i>William J. Hamilton</i><br>ASPECTOR/REGISTERED   |           |
| DATE: 3/15/2021   |           |
| SEAL  |           |
|    |           |
| DOCUMENT NOT CONSIDERED FINAL<br>UNLESS ALL SIGNATURES COMPLETED  |           |
|    |           |
| RAMEY KEMP ASSOCIATES<br>5808 Farington Place<br>Raleigh, North Carolina 27609<br>Phone: 919-872-5115<br>NC License No. C-0910<br>www.rameykemp.com |           |



SEE PROJECT NOTE 1 FOR ALL  
SIGN SYSTEMS THIS SHEET  
UNLESS OTHERWISE NOTED

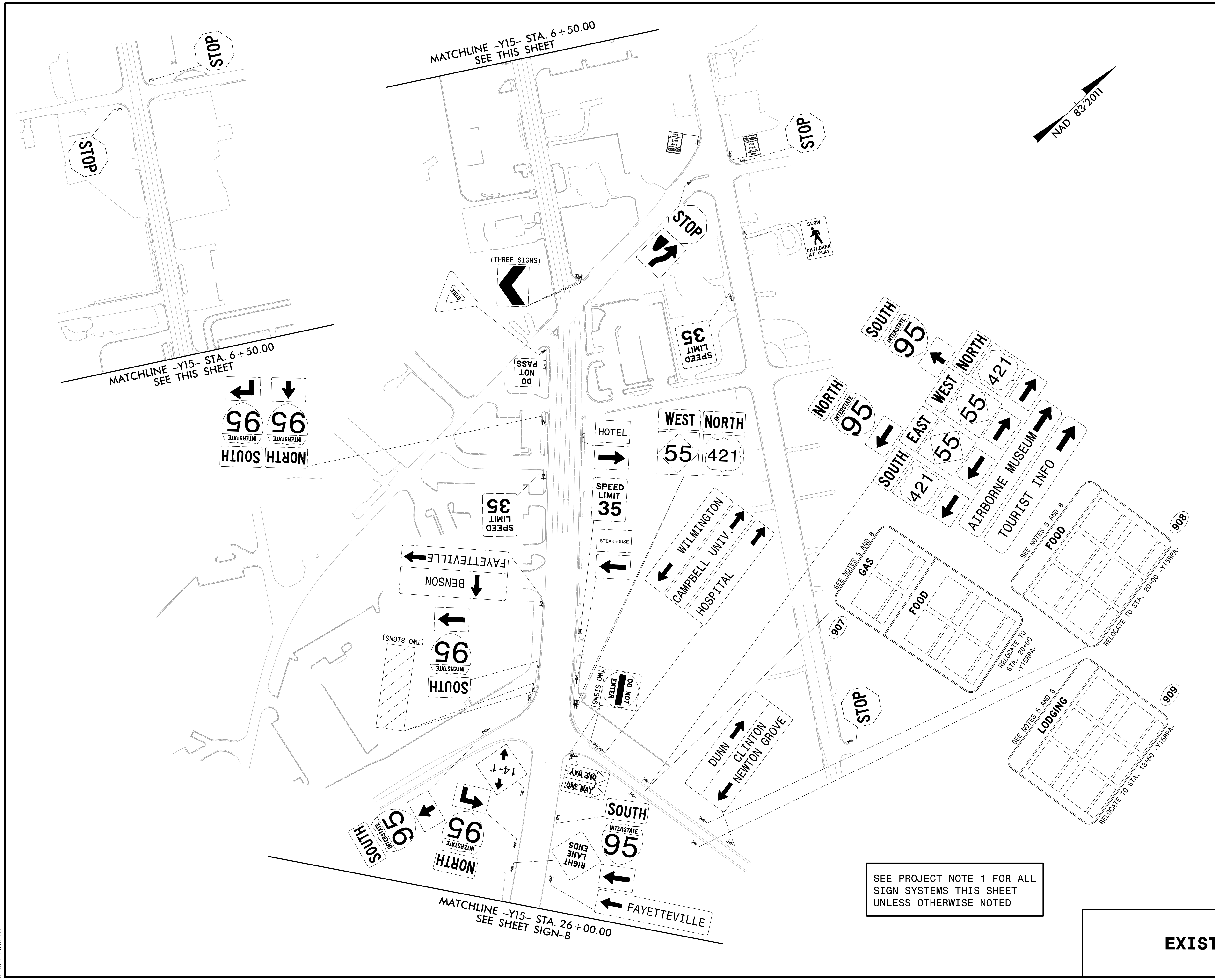

**EXISTING SIGNS**

|   |           |
|---|-----------|
| TIP NO.   | SHEET NO. |
| I - 5878  | SIGN - 10 |
| APPROVED: <i>William J. Hamilton</i><br><small>REGISTERED PROFESSIONAL ENGINEER</small>   |           |
| DATE: 3/15/2021   |           |
| SEAL<br>   |           |
| DOCUMENT NOT CONSIDERED FINAL<br>UNLESS ALL SIGNATURES COMPLETED  |           |
| <br><b>RKA</b><br>RAMEY KEMP ASSOCIATES<br><small>5808 Faringdon Place<br/>Raleigh, North Carolina 27609<br/>Phone: 919-872-5115</small> |           |



**EXISTING SIGNS**

3/15/2021  
1:25:07  
User: J.Wendt

|  |           |
|--|-----------|
| TIP NO.  | SHEET NO. |
| I - 5878   | SIGN - 11 |
| APPROVED: <i>William J. Hamilton</i><br>Professional Engineer<br>No. 35563 F04648484   |           |
| DATE: 3/15/2021  |           |
| SEAL<br>  |           |
| DOCUMENT NOT CONSIDERED FINAL<br>UNLESS ALL SIGNATURES COMPLETED   |           |
| <br><b>RKA</b><br>RAMEY KEMP ASSOCIATES<br>5808 Faringdon Place<br>Raleigh, North Carolina 27609<br>Phone: 919-872-5115<br>NC License No. C-0910<br>www.rameykemp.com |           |



MATCHLINE -L- STA. 1007 + 00.00  
SEE SHEET SIGN-8

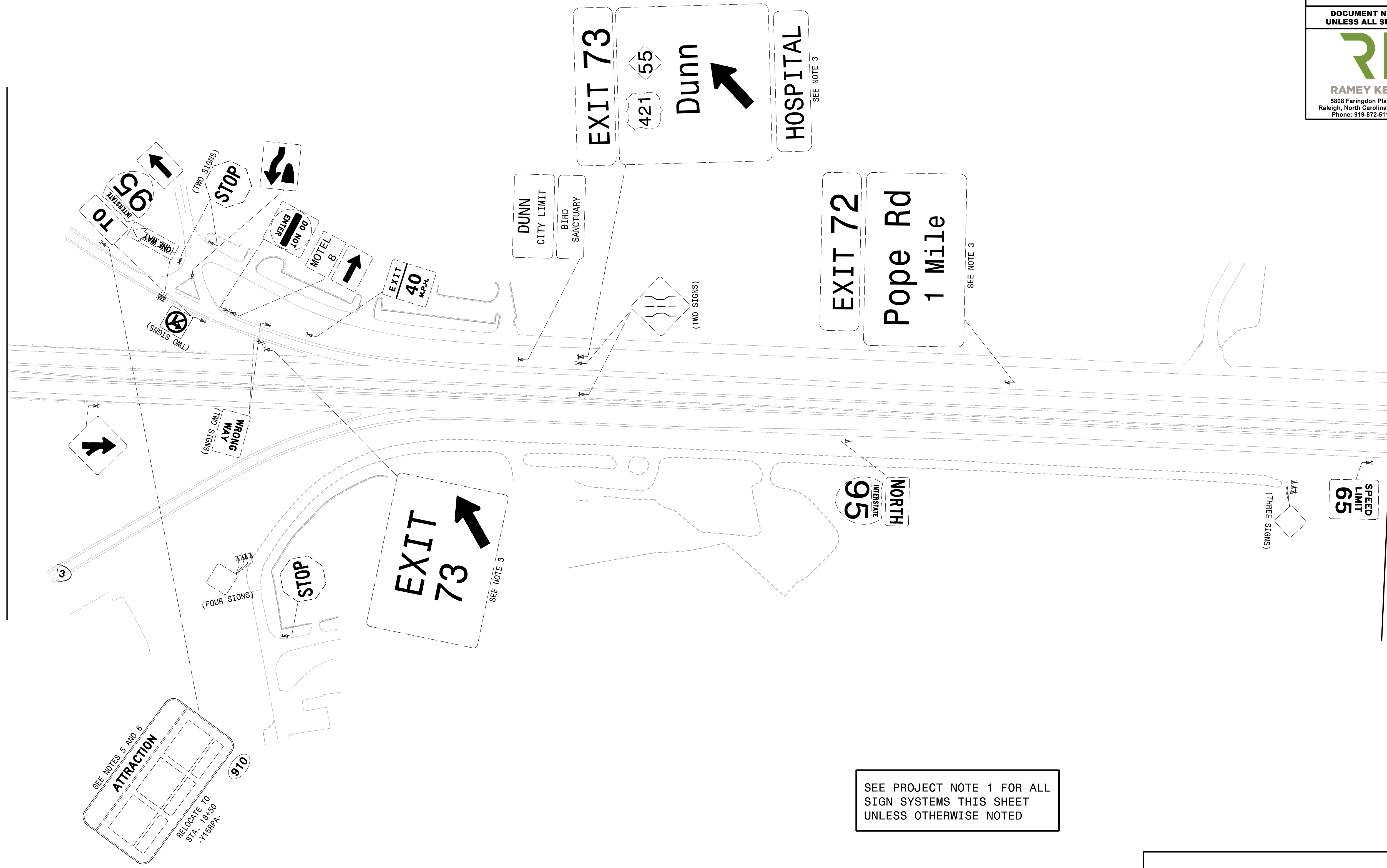

MATCHLINE -L- STA. 1033 + 00.00  
SEE SHEET SIGN-12



SEE PROJECT NOTE 1 FOR ALL  
SIGN SYSTEMS THIS SHEET  
UNLESS OTHERWISE NOTED

**EXISTING SIGNS**



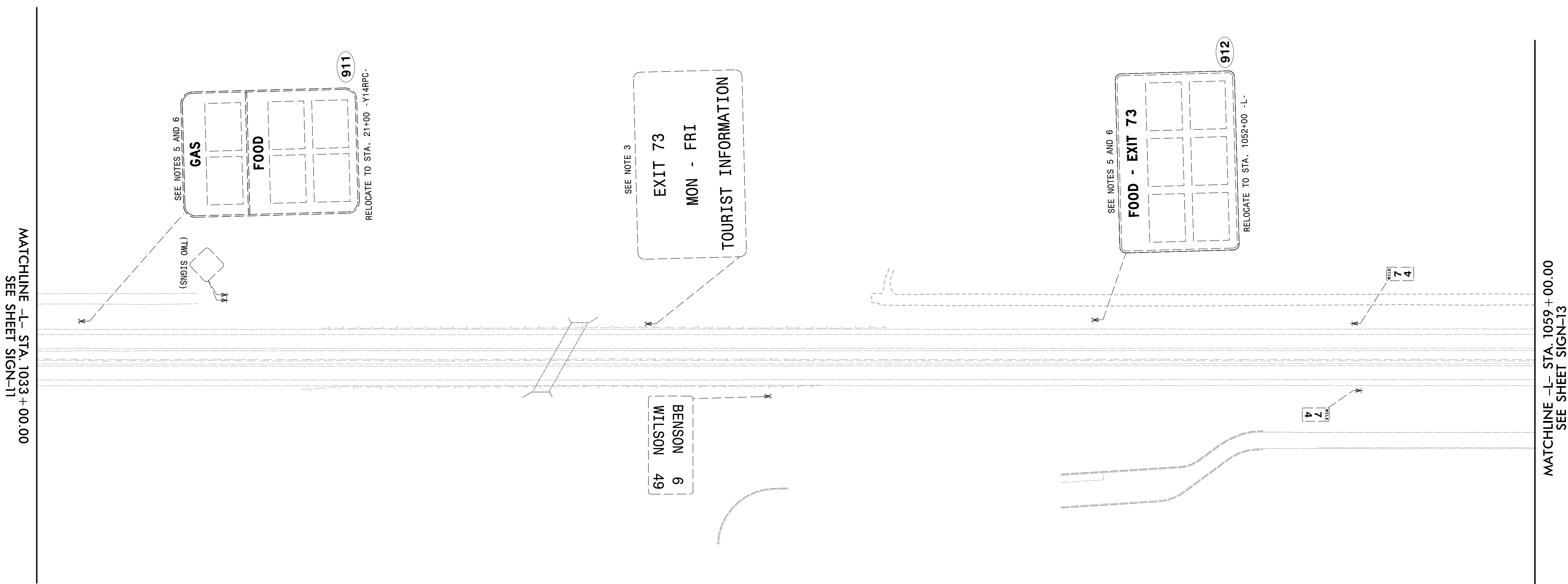

|  |           |
|--|-----------|
| TIP NO.  | SHEET NO. |
| I - 5878   | SIGN - 12 |
| APPROVED: <i>William J. Hamilton</i><br><small>AS2502704648484</small>   |           |
| DATE: 3/15/2021  |           |
| SEAL   |           |
|   |           |
| <b>DOCUMENT NOT CONSIDERED FINAL<br/>UNLESS ALL SIGNATURES COMPLETED</b>   |           |
| <br><b>RAMEY KEMP ASSOCIATES</b><br><small>5808 Farington Place<br/>Raleigh, North Carolina 27609<br/>Phone: 919-872-5115</small> |           |



SEE PROJECT NOTE 1 FOR ALL  
SIGN SYSTEMS THIS SHEET  
UNLESS OTHERWISE NOTED

**EXISTING SIGNS**

|  |           |
|--|-----------|
| TIP NO.  | SHEET NO. |
| I - 5878   | SIGN - 13 |
| <small>DocuSigned by:</small><br>APPROVED: <i>William J. Hamilton</i><br><small>A0560D704648484...</small>   |           |
| DATE: 3/15/2021  |           |
| SEAL   |           |
|   |           |
| DOCUMENT NOT CONSIDERED FINAL<br>UNLESS ALL SIGNATURES COMPLETED   |           |
| <br><b>RAMEY KEMP ASSOCIATES</b><br><small>5808 Faringdon Place<br/>Raleigh, North Carolina 27609<br/>Phone: 919-872-5115</small> |           |

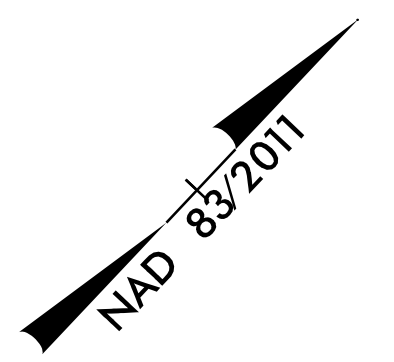

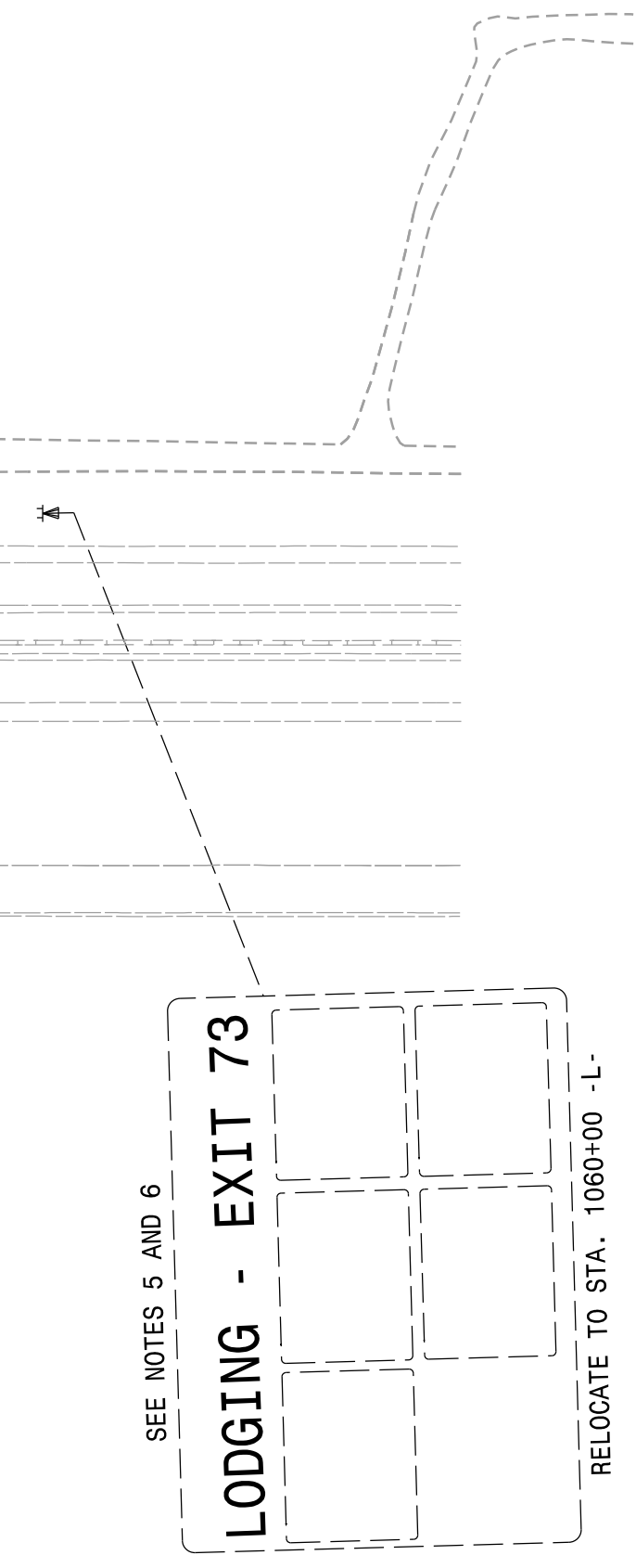

MATCHLINE -L- STA. 1059 + 00.00  
SEE SHEET SIGN-12



SEE PROJECT NOTE 1 FOR ALL  
SIGN SYSTEMS THIS SHEET  
UNLESS OTHERWISE NOTED

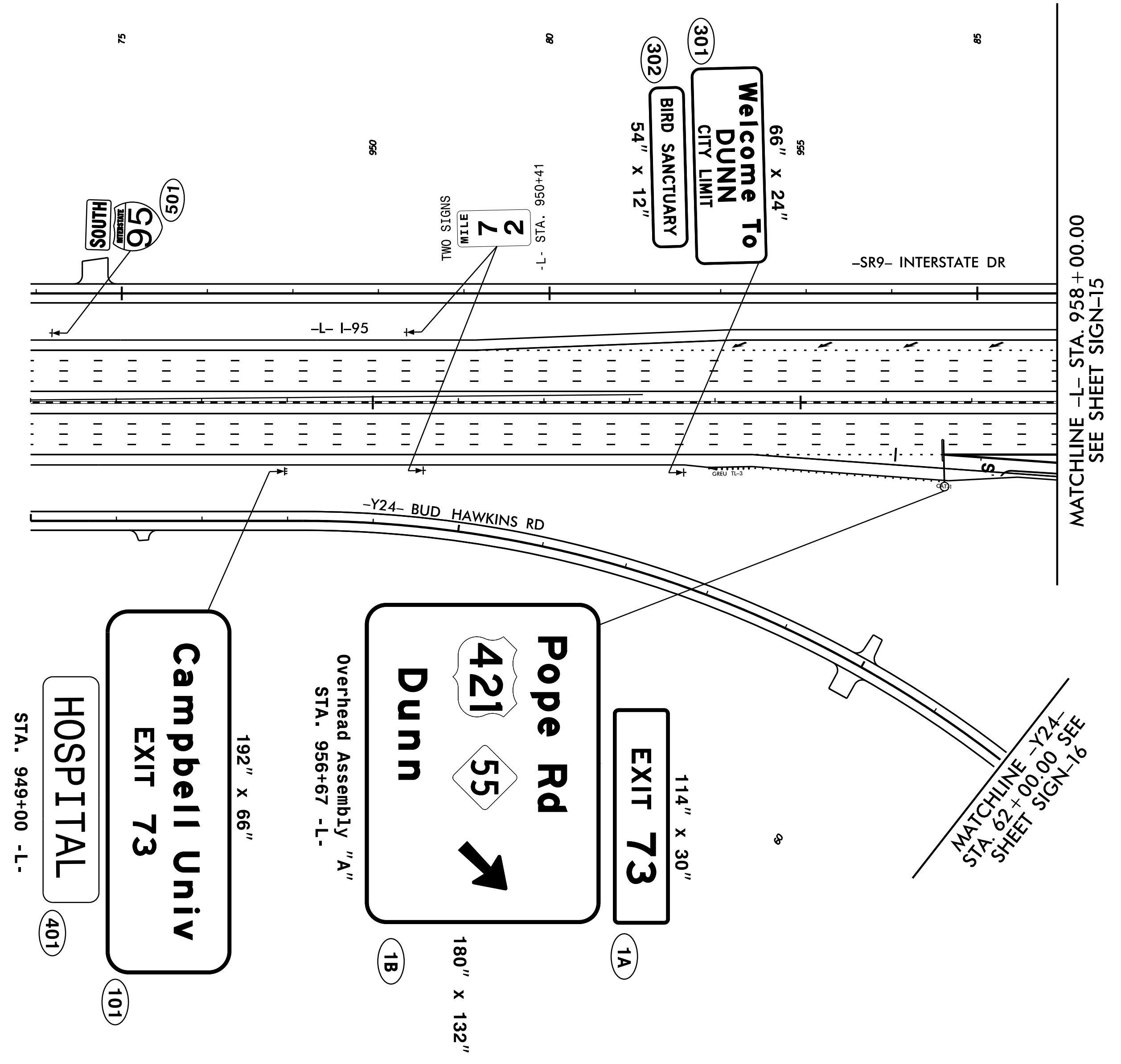

**EXISTING SIGNS**

|   |           |
|---|-----------|
| TIP NO.   | SHEET NO. |
| I - 5878  | SIGN - 14 |
| APPROVED: <i>William J. Hamilton</i><br>—REGISTERED PROFESSIONAL—   |           |
| DATE: 3/15/2021   |           |
| SEAL  |           |
|    |           |
| DOCUMENT NOT CONSIDERED FINAL<br>UNLESS ALL SIGNATURES COMPLETED  |           |
| <br><b>RAMEY KEMP ASSOCIATES</b><br>5808 Faringdon Place<br>Raleigh, North Carolina 27609<br>Phone: 919-872-5115<br>NC License No. C-0910<br>www.rameykemp.com |           |



**PROPOSED SIGNS**

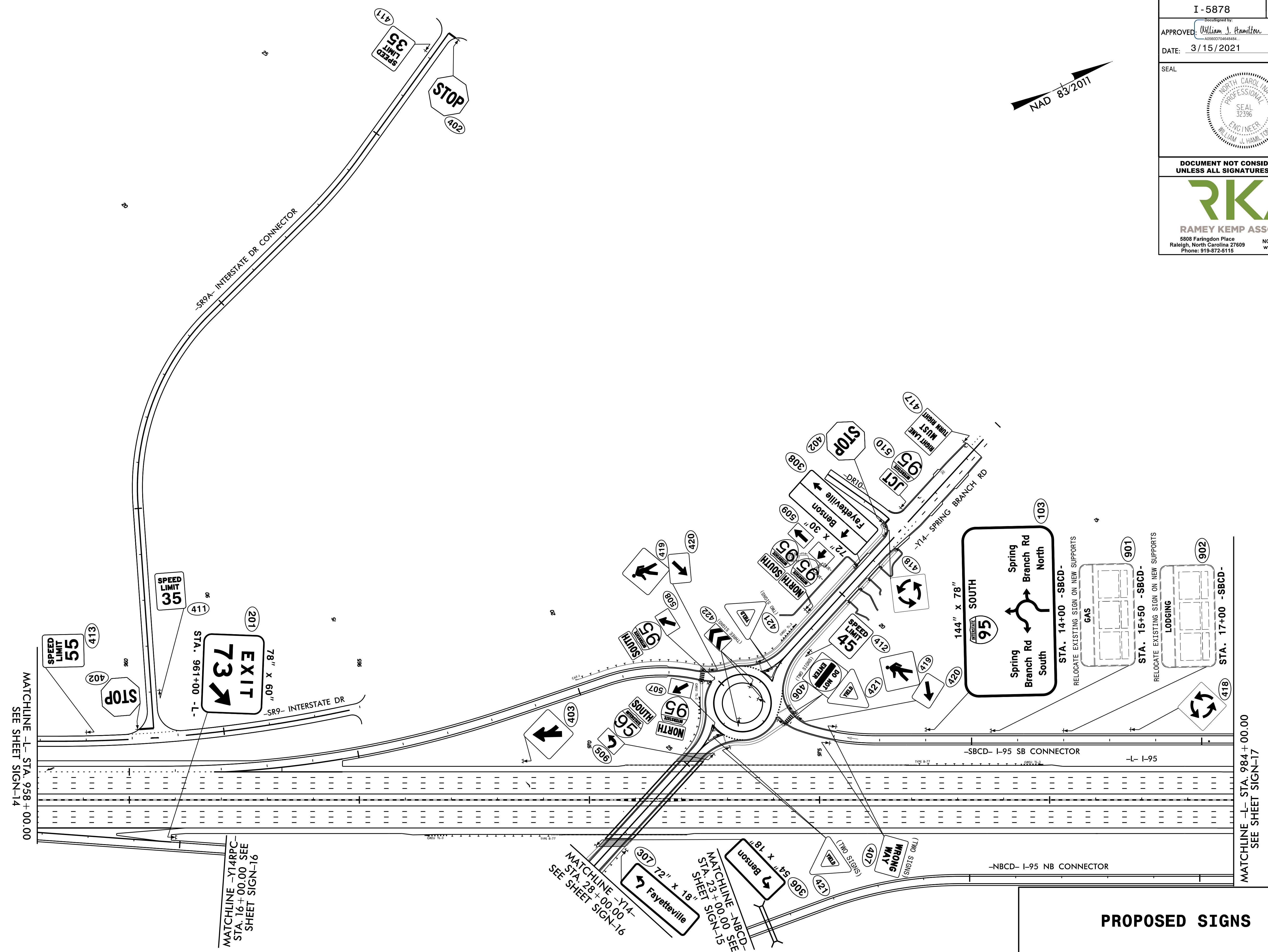

\$\$\$ TIME STAMPS \$\$\$

|   |           |
|---|-----------|
| TIP NO.   | SHEET NO. |
| I - 5878  | SIGN - 15 |
| APPROVED: <i>William J. Hamilton</i><br>A05800704848484   |           |
| DATE: 3/15/2021   |           |
| SEAL<br>   |           |
| DOCUMENT NOT CONSIDERED FINAL<br>UNLESS ALL SIGNATURES COMPLETED  |           |
| <br><b>RAMEY KEMP ASSOCIATES</b><br>5808 Faringdon Place<br>Raleigh, North Carolina 27609<br>Phone: 919-872-5115<br>NC License No. C-0910<br>www.rameykemp.com |           |



### PROPOSED SIGNS

3/15/2021  
User: J.Wendt

|   |           |
|---|-----------|
| TIP NO.   | SHEET NO. |
| I - 5878  | SIGN - 16 |
| APPROVED: <i>William J. Hamilton</i><br>ASSISTANT ENGINEER  |           |
| DATE: 3/15/2021   |           |
| SEAL<br>   |           |
| DOCUMENT NOT CONSIDERED FINAL<br>UNLESS ALL SIGNATURES COMPLETED  |           |
| <br><b>RAMEY KEMP ASSOCIATES</b><br>5808 Faringdon Place<br>Raleigh, North Carolina 27609<br>Phone: 919-872-5115<br>NC License No. C-0910<br>www.rameykemp.com |           |

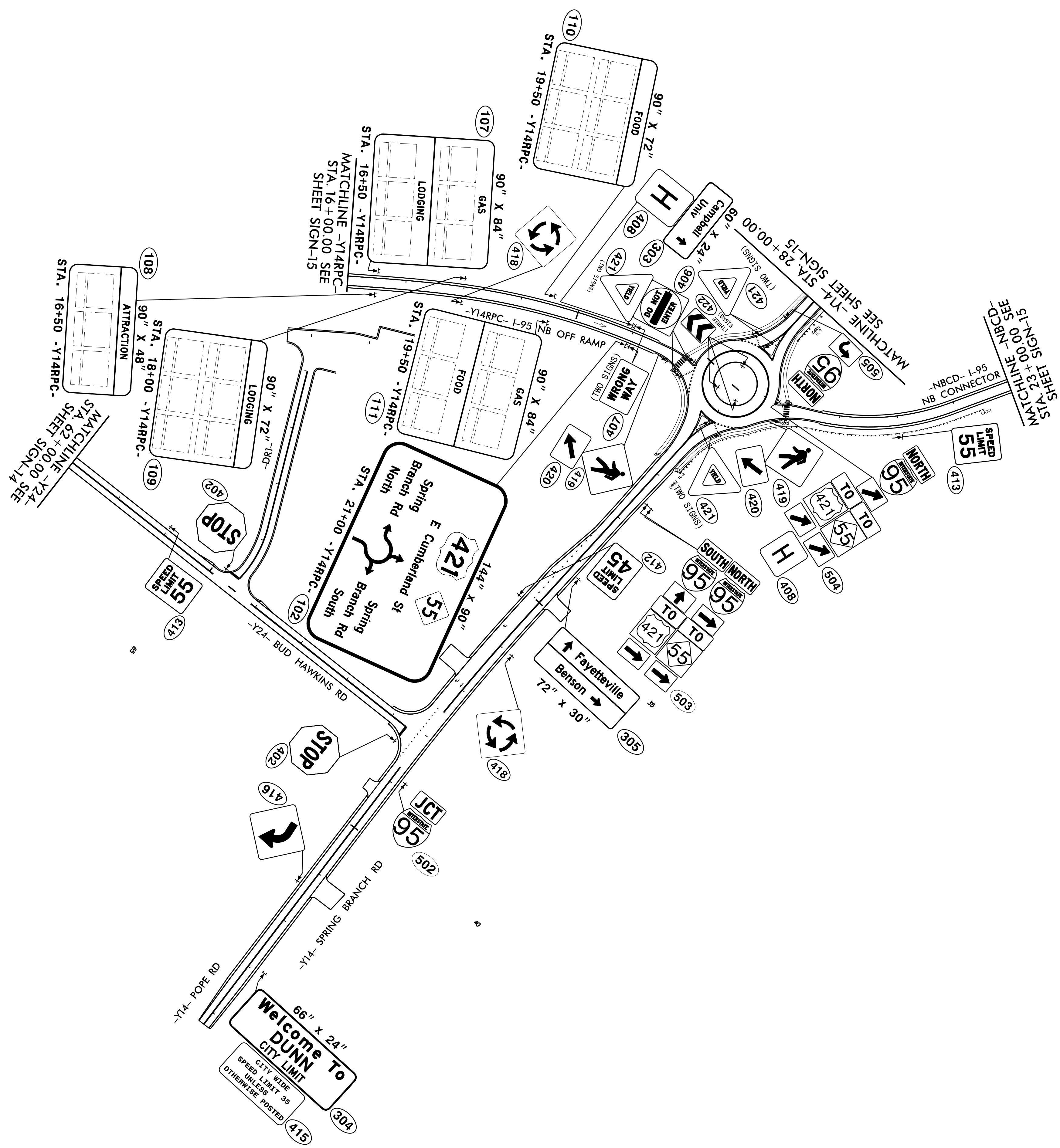

**PROPOSED SIGNS**

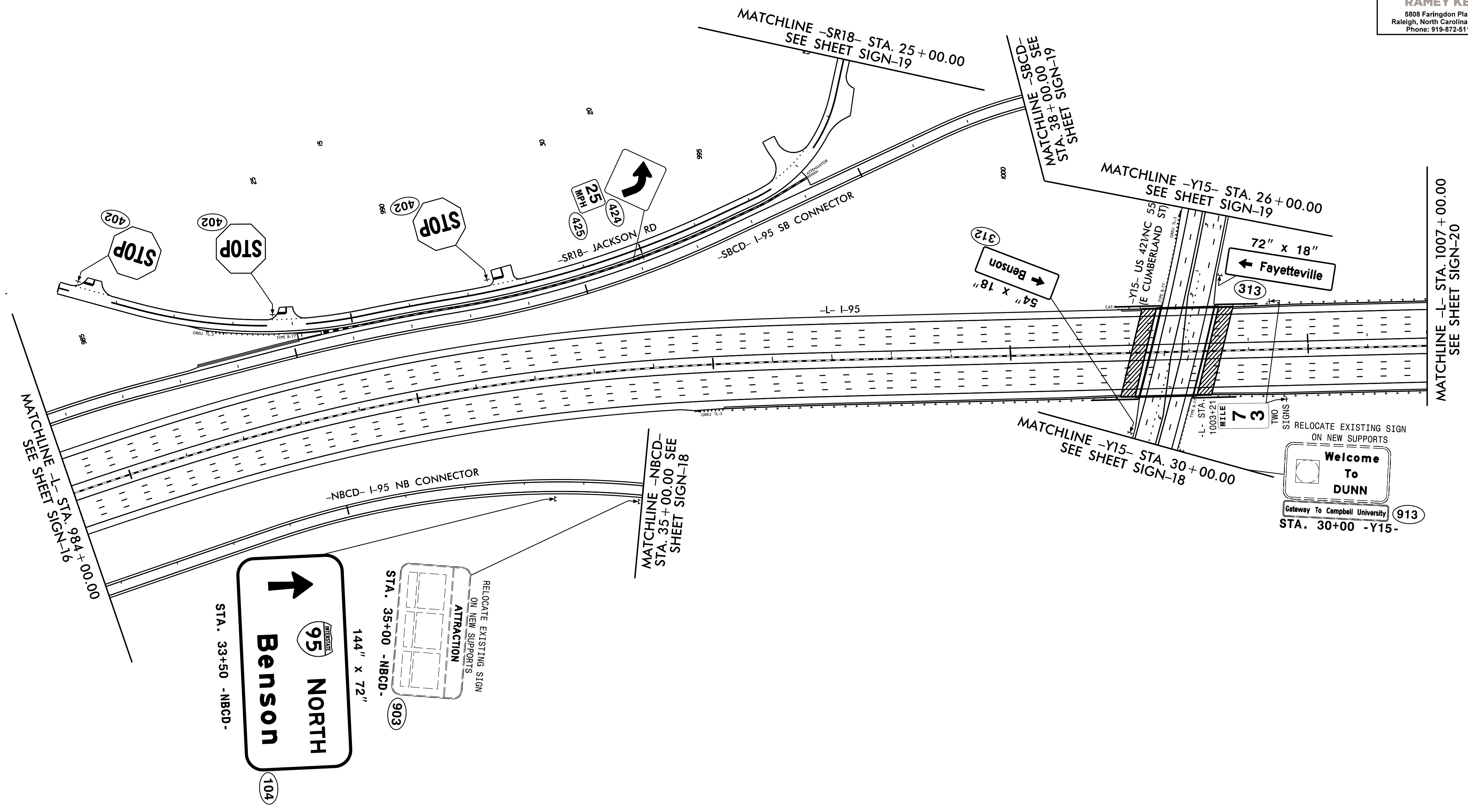

3/15/2021  
 \\112507052\_1159866\_Sgn\_Sign16\_011419.dgn  
 User: J.Wendt

|  |           |
|--|-----------|
| TIP NO.  | SHEET NO. |
| I - 5878   | SIGN - 17 |
| APPROVED: <i>William J. Hamilton</i><br>ASPECTOR/REGISTERED  |           |
| DATE: 3/15/2021  |           |
| SEAL   |           |
|  |           |
| DOCUMENT NOT CONSIDERED FINAL<br>UNLESS ALL SIGNATURES COMPLETED   |           |
|  |           |
| <small>5808 Faringdon Place<br/>Raleigh, North Carolina 27609<br/>Phone: 919-872-5115</small> <small>NC License No. C-0910<br/>www.rameykemp.com</small> |           |



3/15/2021  
 I:\2507053\_159866\_Sgn\_Sign17\_0111419.dgn  
 User:J.Wenget

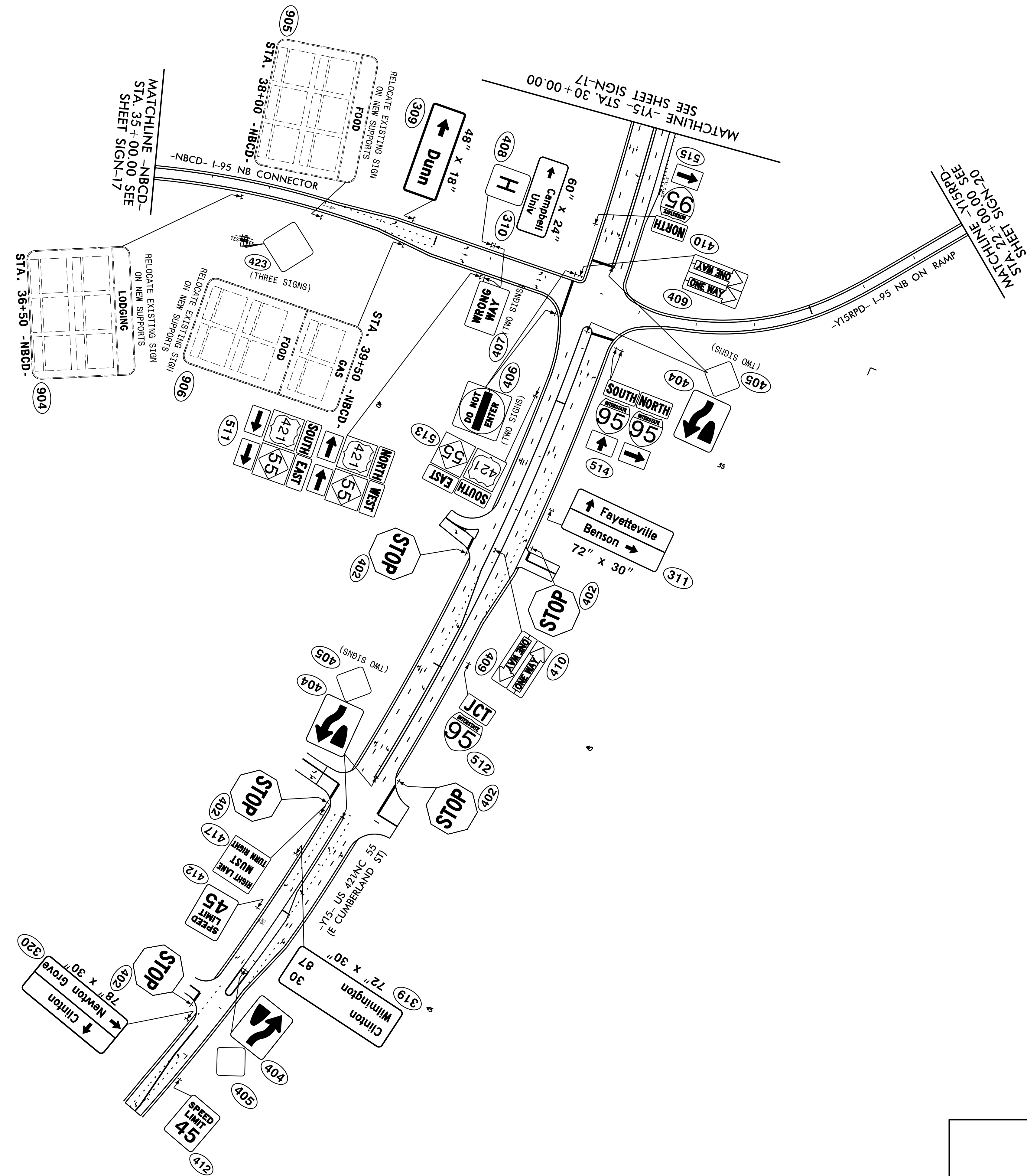

**PROPOSED SIGNS**

|  |           |
|--|-----------|
| TIP NO.  | SHEET NO. |
| I - 5878   | SIGN - 18 |
| APPROVED: <i>William J. Hamilton</i><br>Professional Engineer<br>No. 32396   |           |
| DATE: 3/15/2021  |           |
| SEAL   |           |
|   |           |
| DOCUMENT NOT CONSIDERED FINAL<br>UNLESS ALL SIGNATURES COMPLETED   |           |
| <br><b>RKA</b><br>RAMEY KEMP ASSOCIATES<br><small>5808 Faringdon Place<br/>Raleigh, North Carolina 27609<br/>Phone: 919-872-5115</small> <small>NC License No. C-0910<br/>www.rameykemp.com</small> |           |



3/15/2021  
 I:\2507054\_159866\_Sgn\_Sign18\_011419.dgn  
 User: J.Wendt

**PROPOSED SIGNS**

|  |           |
|--|-----------|
| TIP NO.  | SHEET NO. |
| I - 5878   | SIGN - 19 |
| APPROVED: <i>William J. Hamilton</i><br><small>AS000704648484</small>  |           |
| DATE: 3/15/2021  |           |
| SEAL   |           |
|   |           |
| <b>DOCUMENT NOT CONSIDERED FINAL<br/>UNLESS ALL SIGNATURES COMPLETED</b>   |           |
| <br><b>RAMEY KEMP ASSOCIATES</b><br><small>5808 Faringdon Place<br/>Raleigh, North Carolina 27609<br/>Phone: 919-872-5115</small><br><small>NC License No. C-0910<br/>www.rameykemp.com</small> |           |

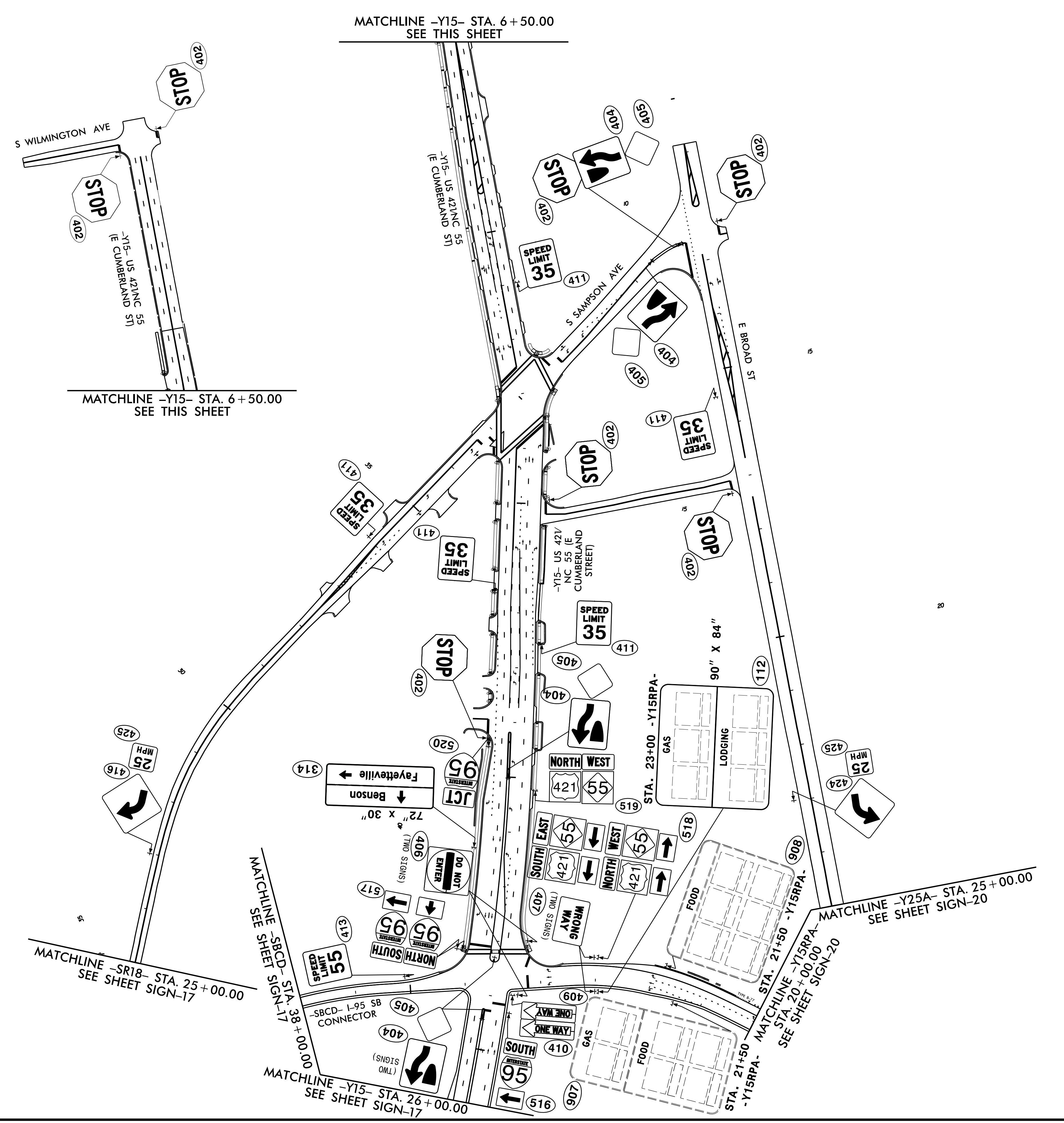

### PROPOSED SIGNS

3/15/2021  
 \\s1159866-Sgn\_Sign19\_011419.dgn  
 User: J.Wendt



|   |           |
|---|-----------|
| TIP NO.   | SHEET NO. |
| I - 5878  | SIGN-20   |
| APPROVED: <i>William J. Hamilton</i>  |           |
| DATE: 3/15/2021   |           |
| SEAL  |           |
|   |           |
| <p>DOCUMENT NOT CONSIDERED FINAL<br/>UNLESS ALL SIGNATURES COMPLETED</p>  |           |
| <p>RAMEY KEMP ASSOCIATES<br/>5808 Faringdon Place<br/>Raleigh, North Carolina 27609<br/>Phone: 919-872-5115<br/>NC License No. C-0910<br/>www.rameykemp.com</p> |           |

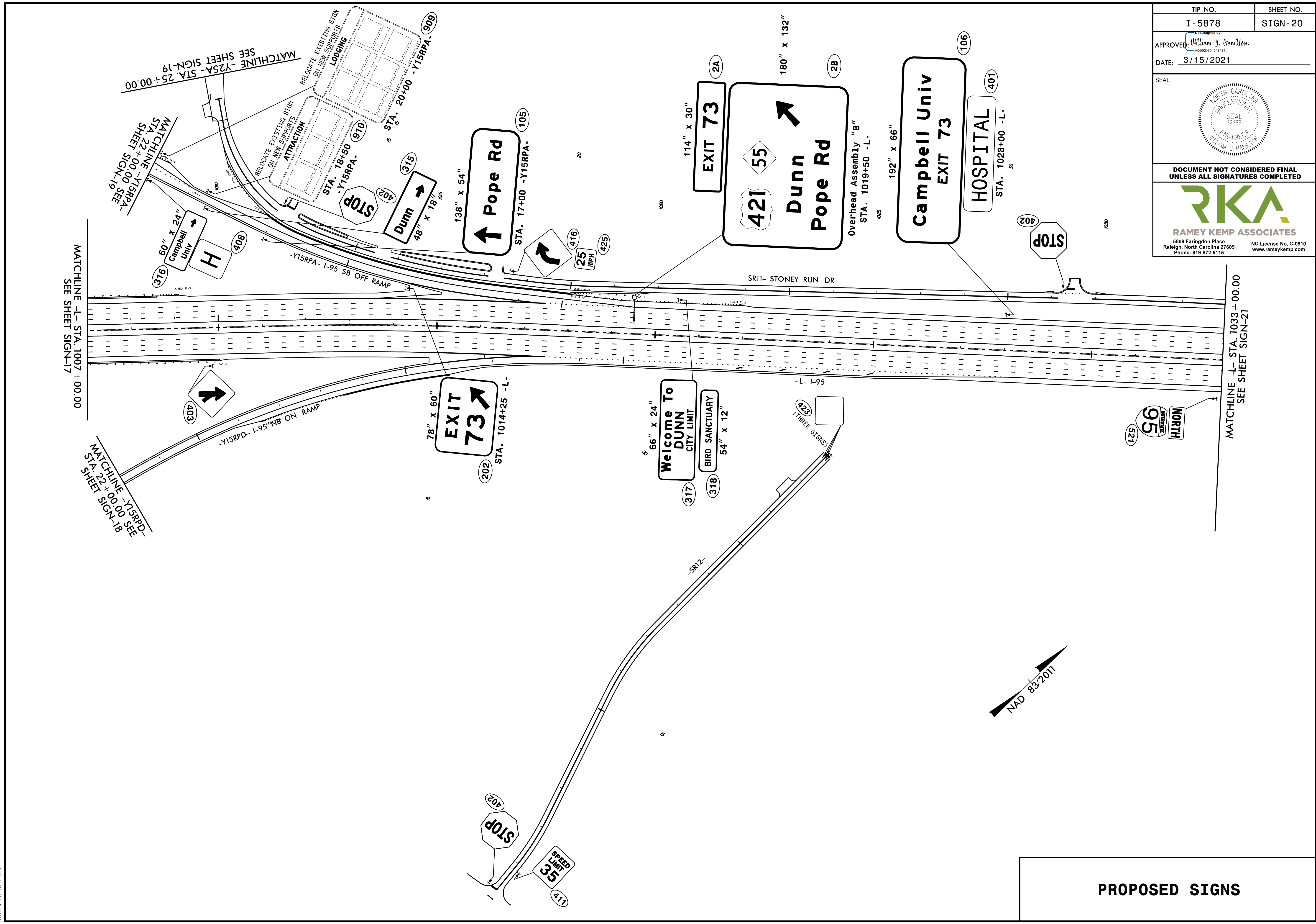

**PROPOSED SIGNS**

3/26/2021  
User: tpope@k.a

|  |           |
|--|-----------|
| TIP NO.  | SHEET NO. |
| I - 5878   | SIGN - 21 |
| APPROVED: <i>William J. Hamilton</i>   |           |
| DATE: 3/15/2021  |           |
| SEAL   |           |
|  |           |
| DOCUMENT NOT CONSIDERED FINAL<br>UNLESS ALL SIGNATURES COMPLETED   |           |
|  |           |
| <b>RAMEY KEMP ASSOCIATES</b><br>5808 Farington Place<br>Raleigh, North Carolina 27609<br>Phone: 919-872-5115<br>NC License No. C-0910<br>www.rameykemp.com |           |

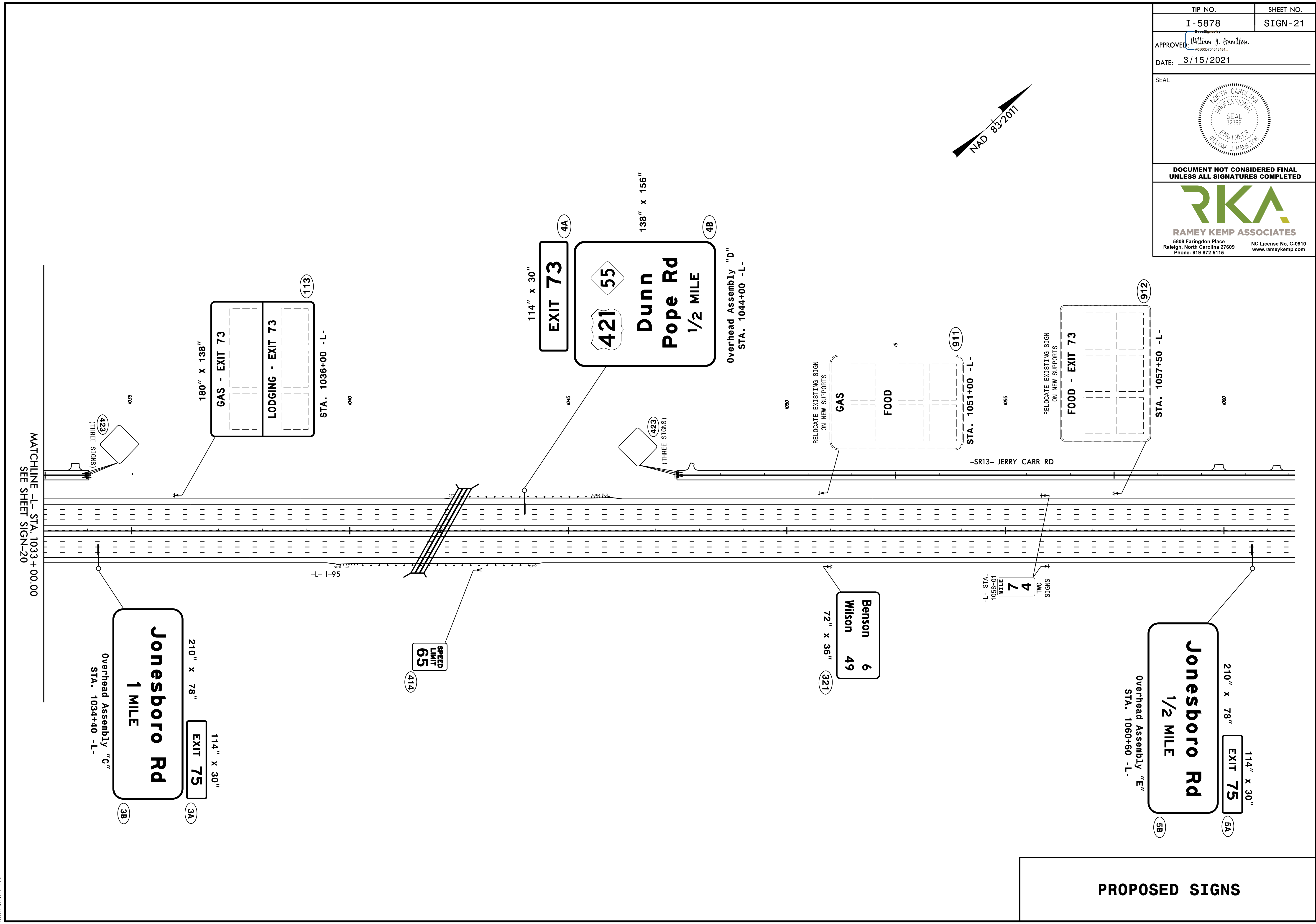

**PROPOSED SIGNS**