

PROJECT REFERENCE NO. 1-5883		SHEET NO. 2D-3	
RW SHEET NO.			
ROADWAY DESIGN ENGINEER Susan C. Lancaster Professional Seal 027373		HYDRAULICS ENGINEER Joshua G. Dalton Professional Seal 26971	
DocuSign 5/13/2021		DocuSign 5/13/2021	
DOCUMENT NOT CONSIDERED FINAL UNLESS ALL SIGNATURES COMPLETED			
Michael Baker Engineering, Inc. 6000 Gregory Drive Suite 500 Charlotte, NC 27718 Tel: 704.366.4600 Fax: 704.366.4601 www.michaelbaker.com		SUNGATE DESIGN GROUP, P.A. 9020A Research Road Raleigh, NC 27615 Tel: 919.876.1000 Fax: 919.876.1001 www.sungatedesign.com	

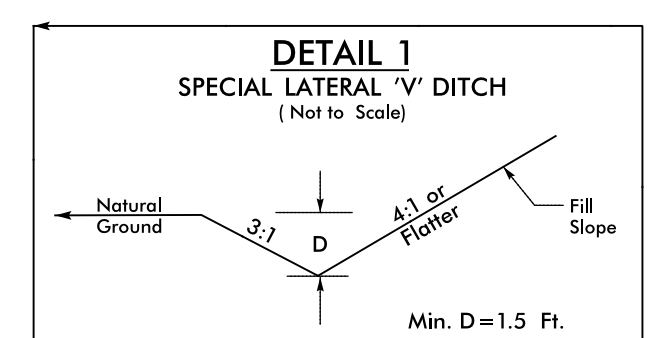

FROM STA. 1092+50 TO STA. 1096+00 -L- RT
 FROM STA. 1122+00 TO STA. 1128+00 -L- RT
 FROM STA. 1134+00 TO STA. 1137+50 -L- RT
 FROM STA. 49+00 TO STA. 52+40 -SR13- RT
 FROM STA. 53+04 TO STA. 53+50 -SR13- RT
 FROM STA. 57+00 TO STA. 58+50 -SR13- LT
 FROM STA. 29+00 TO STA. 31+47 -SR15- RT
 FROM STA. 43+21 TO STA. 49+71 -SR15- RT
 FROM STA. 19+00 TO STA. 20+30 -Y16- LT
 FROM STA. 20+00 TO STA. 22+22 -Y16RPC- LT
 FROM STA. 10+20 TO STA. 12+00 -SR16- LT
 FROM STA. 10+15 TO STA. 12+00 -SR16- RT
 FROM STA. 14+00 TO STA. 15+50 -SR16- LT
 FROM STA. 43+55 TO STA. 46+50 -SR16- LT
 FROM STA. 72+50 TO STA. 81+00 -SR16- LT
 FROM STA. 82+00 TO STA. 85+50 -SR16- LT
 FROM STA. 16+86 TO STA. 19+00 -Y17- RT
 FROM STA. 14+00 TO STA. 21+50 -Y26- LT
 FROM STA. 10+34 TO STA. 11+00 -DR2- LT
 FROM STA. 13+00 TO STA. 16+50 -DR3- LT

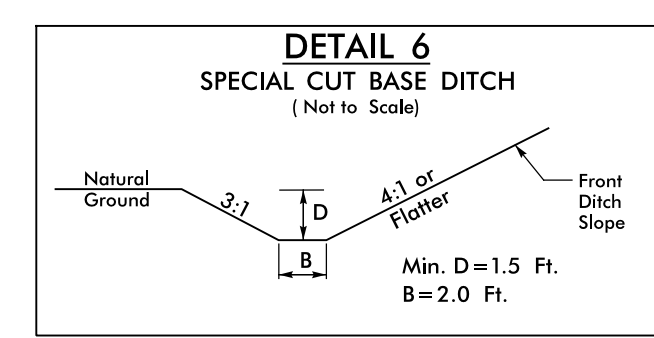

FROM STA. 1131+00 TO STA. 1134+00 -L- LT
 FROM STA. 12+00 TO STA. 13+50 -Y16- LT
 FROM STA. 15+80 TO STA. 17+80 -Y16- RT

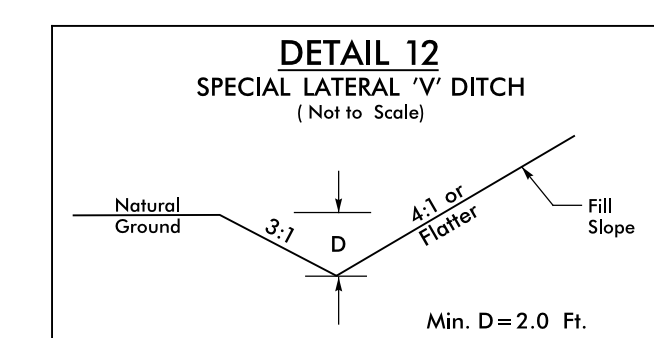

FROM STA. 1201+50 TO STA. 1206+04 -L- LT
 FROM STA. 34+50 TO STA. 35+85 -SR17- LT

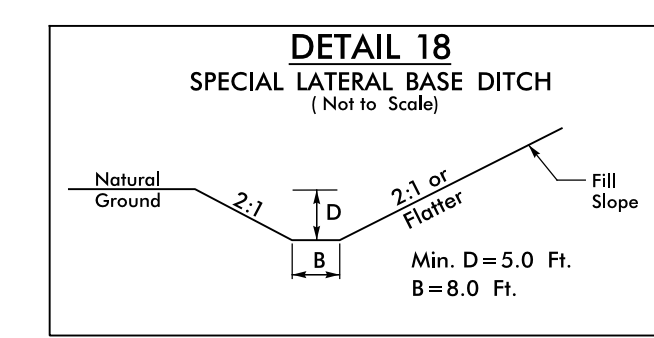

FROM STA. 38+20 TO STA. 39+80 -SR14- RT

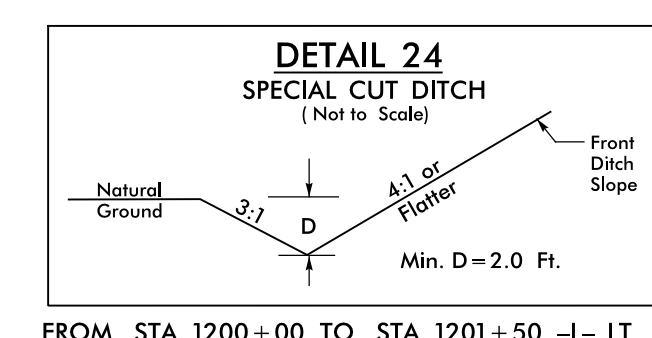

FROM STA. 1200+00 TO STA. 1201+50 -L- LT
 FROM STA. 1218+70 TO STA. 1220+00 -L- RT
 FROM STA. 39+00 TO STA. 46+67 -SR17- RT

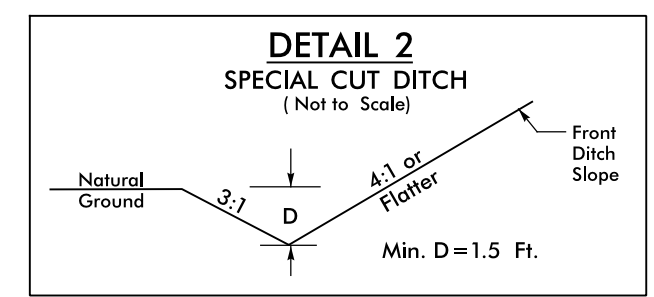

FROM STA. 1082+00 TO STA. 1082+50 -L- LT
 FROM STA. 1096+00 TO STA. 1097+50 -L- RT
 FROM STA. 1102+00 TO STA. 1106+50 -L- LT
 FROM STA. 1103+00 TO STA. 1107+00 -L- RT
 FROM STA. 1199+00 TO STA. 1201+00 -L- RT
 FROM STA. 1211+45 TO STA. 1213+00 -L- RT
 FROM STA. 1225+00 TO STA. 1227+50 -L- RT
 FROM STA. 11+00 TO STA. 14+00 -Y16- RT
 FROM STA. 10+50 TO STA. 12+00 -Y16- LT
 FROM STA. 15+00 TO STA. 15+80 -Y16- RT
 FROM STA. 17+80 TO STA. 19+00 -Y16- RT
 FROM STA. 38+00 TO STA. 38+64 -Y16- LT
 FROM STA. 41+00 TO STA. 43+50 -Y16- LT
 FROM STA. 12+70 TO STA. 16+12 -Y17- RT
 FROM STA. 13+00 TO STA. 18+00 -Y17- LT
 FROM STA. 36+00 TO STA. 38+00 -Y17- RT
 FROM STA. 39+50 TO STA. 40+39 -Y17- RT
 FROM STA. 12+74 TO STA. 22+25 -SR17- LT
 FROM STA. 19+00 TO STA. 19+60 -DR3- LT
 FROM STA. 19+00 TO STA. 19+65 -DR3- RT
 FROM STA. 13+50 TO STA. 15+80 -DR4- RT

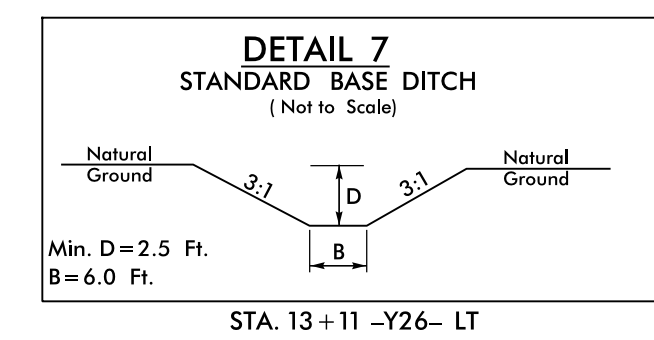

STA. 13+11 -Y26- LT

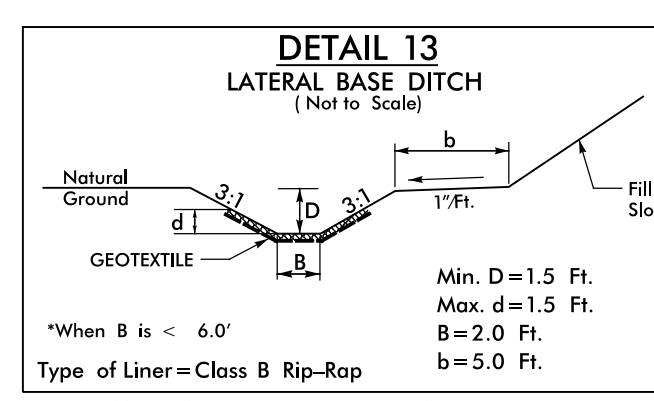

FROM STA. 1128+50 TO STA. 1131+00 -L- LT

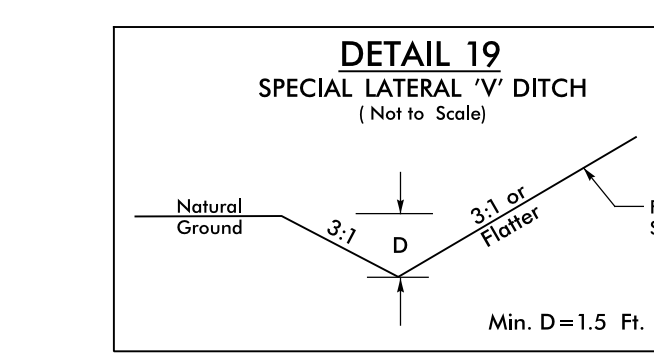

FROM STA. 1201+00 TO STA. 1203+87 -L- RT
 FROM STA. 56+36 TO STA. 58+21 -SR15- RT
 FROM STA. 77+25 TO STA. 82+10 -SR15- RT
 FROM STA. 20+50 TO STA. 21+00 -Y17- LT
 FROM STA. 17+50 TO STA. 21+50 -Y17RPA- RT
 FROM STA. 13+15 TO STA. 14+00 -Y26- LT

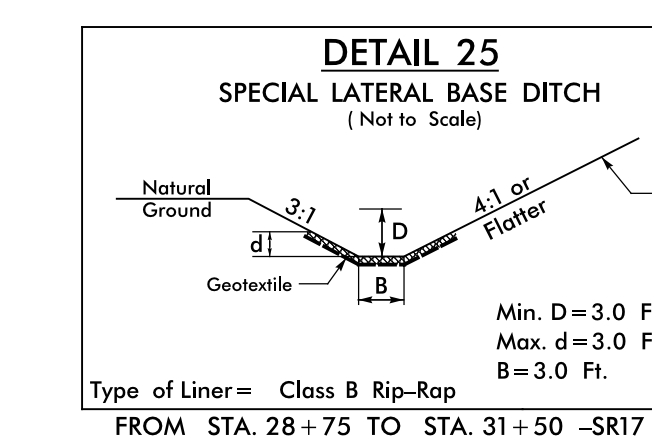

FROM STA. 28+75 TO STA. 31+50 -SR17 LT

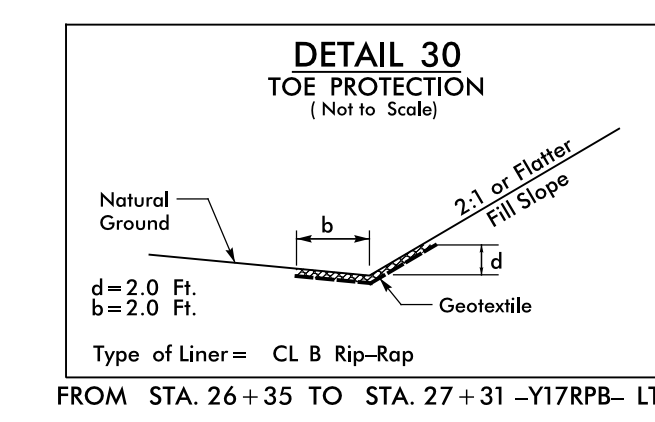

FROM STA. 26+35 TO STA. 27+31 -Y17RPB- LT

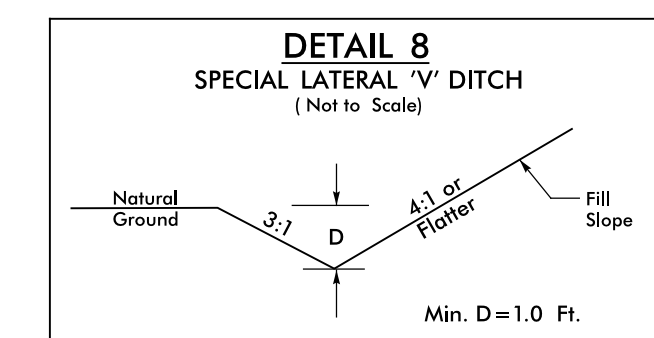

FROM STA. 44+50 TO STA. 45+00 -SR13- LT
 FROM STA. 14+50 TO STA. 21+50 -Y26- RT
 FROM STA. 22+50 TO STA. 27+60 -Y26- LT
 FROM STA. 22+00 TO STA. 26+00 -Y26- RT
 FROM STA. 27+60 TO STA. 30+00 -Y26- LT

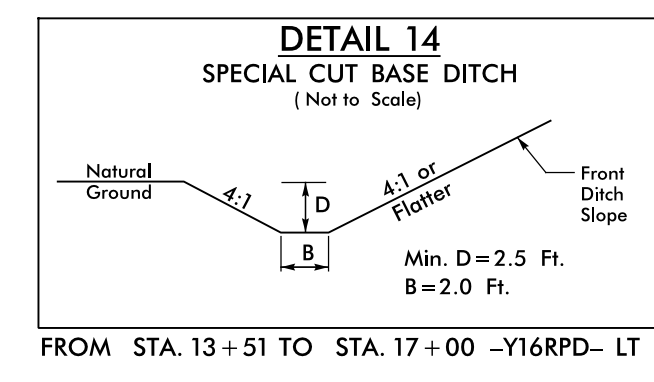

FROM STA. 13+51 TO STA. 17+00 -Y16RPD- LT

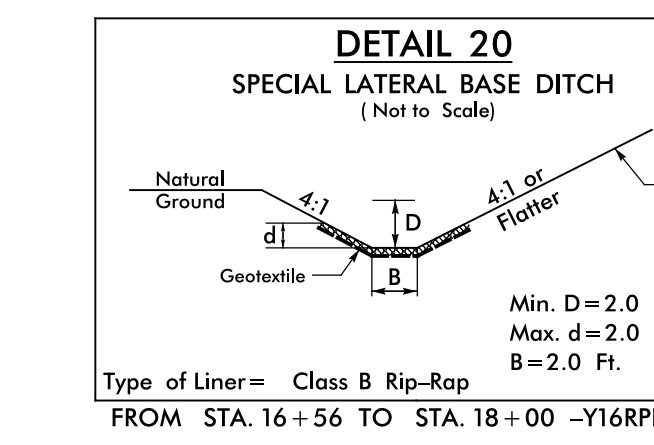

FROM STA. 16+56 TO STA. 18+00 -Y16RPB- LT

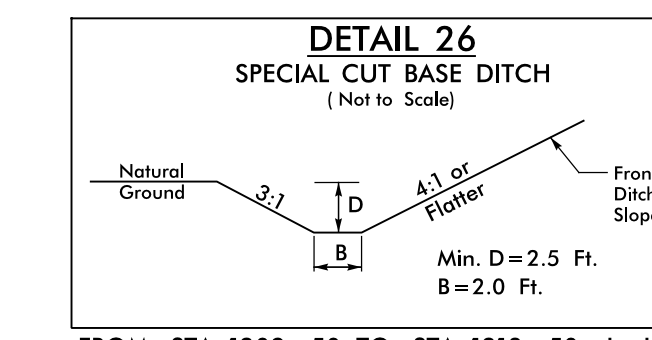

FROM STA. 1209+50 TO STA. 1213+50 -L- LT
 FROM STA. 1216+50 TO STA. 1219+00 -L- LT
 FROM STA. 18+80 TO STA. 23+00 -SR17- RT
 FROM STA. 22+25 TO STA. 28+75 -SR17- LT
 FROM STA. 14+63 TO STA. 17+50 -Y17RPA- RT

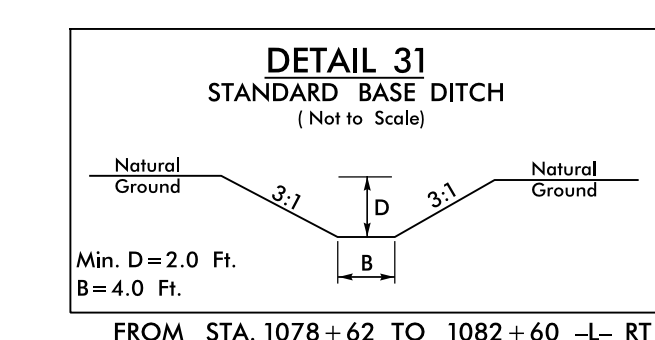

FROM STA. 1078+62 TO STA. 1082+60 -L- RT

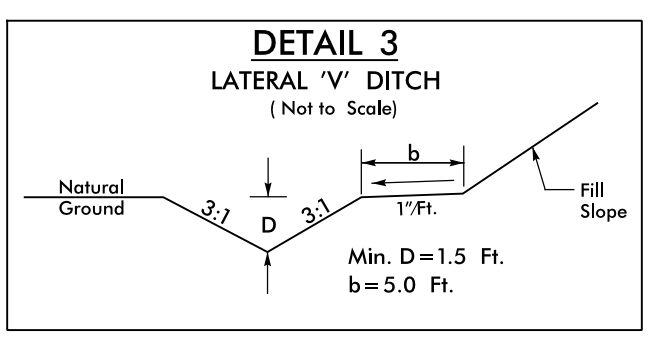

FROM STA. 38+55 TO STA. 40+50 -SR13- LT
 FROM STA. 33+65 TO STA. 36+00 -Y17- RT
 FROM STA. 22+00 TO STA. 24+00 -Y17RPC- RT

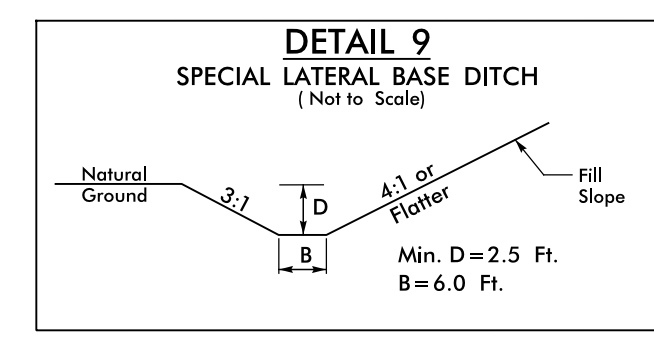

FROM STA. 45+00 TO STA. 47+90 -SR13- LT

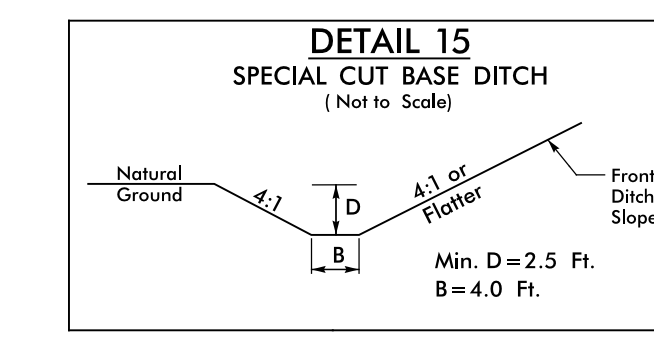

FROM STA. 32+85 TO STA. 34+50 -SR15- RT
 FROM STA. 17+00 TO STA. 18+91 -Y16RPD- LT

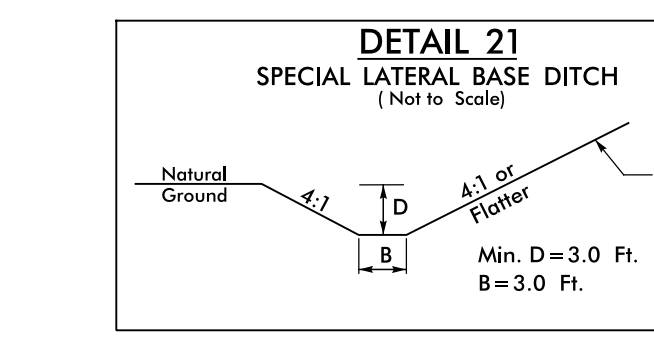

FROM STA. 1082+50 TO STA. 1091+00 -L- LT
 FROM STA. 14+59 TO STA. 16+56 -Y16RPB- LT

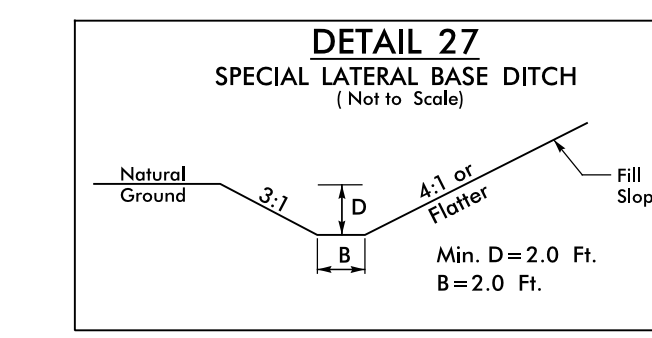

FROM STA. 29+35 TO STA. 30+25 -Y17- RT

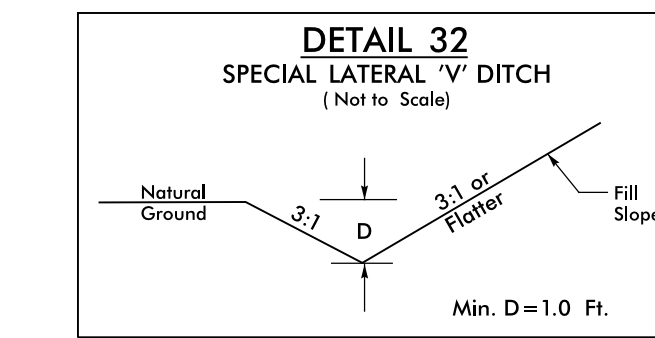

FROM STA. 69+71 TO STA. 72+41 -SR15- RT
 FROM STA. 88+45 TO STA. 98+30 -SR15- RT
 FROM STA. 10+50 TO STA. 13+08 -Y26- LT
 FROM STA. 22+00 TO STA. 22+50 -Y26- LT
 FROM STA. 26+00 TO STA. 27+74 -Y26- RT
 FROM STA. 27+74 TO STA. 30+00 -Y26- RT

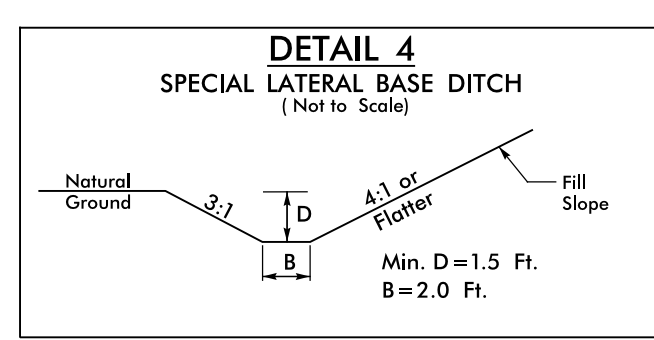

FROM STA. 1220+35 TO STA. 1224+50 -L- LT
 FROM STA. 45+00 TO STA. 49+00 -SR13- RT
 FROM STA. 37+60 TO STA. 43+21 -SR15- RT
 FROM STA. 24+12 TO STA. 26+12 -SR16- LT
 FROM STA. 61+90 TO STA. 64+20 -SR16- LT

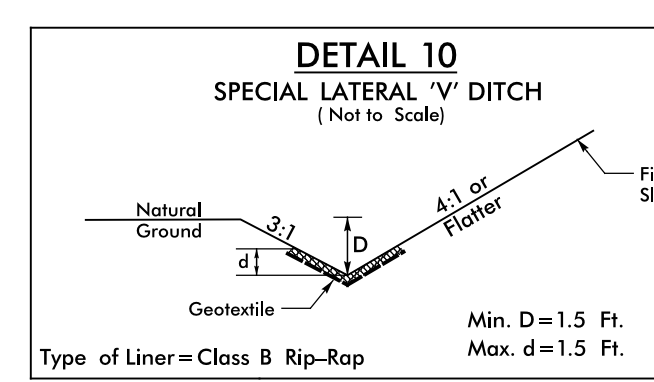

FROM STA. 53+85 TO STA. 57+00 -SR13- LT
 FROM STA. 31+47 TO STA. 32+85 -SR15- RT

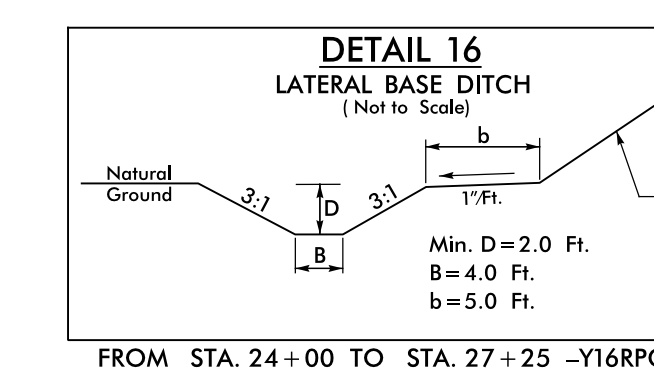

FROM STA. 24+00 TO STA. 27+25 -Y16RPC- RT

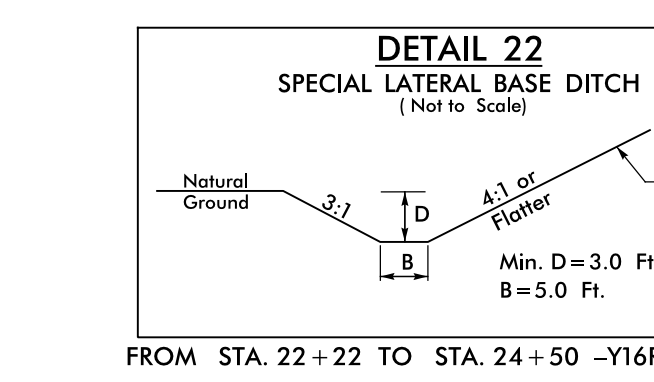

FROM STA. 22+22 TO STA. 24+50 -Y16RPC- LT

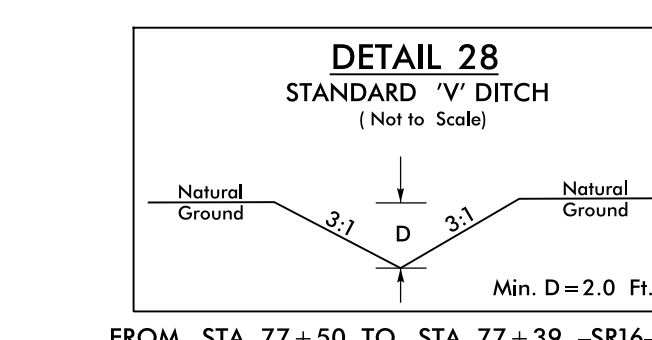

FROM STA. 77+50 TO STA. 77+39 -SR16- RT
 STA. 14+50 -SR16- RT

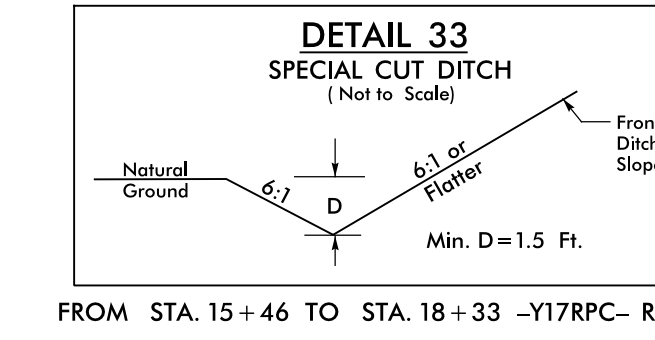

FROM STA. 15+46 TO STA. 18+33 -Y17RPC- RT

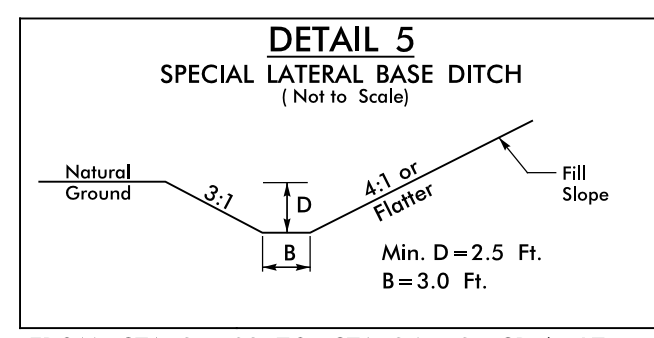

FROM STA. 21+82 TO STA. 24+12 -SR16- LT
 FROM STA. 46+50 TO STA. 47+35 -SR16- LT
 FROM STA. 31+50 TO STA. 34+52 -SR17- LT
 FROM STA. 20+50 TO STA. 22+28 -Y16RPA- LT
 FROM STA. 23+05 TO STA. 26+36 -Y17- RT

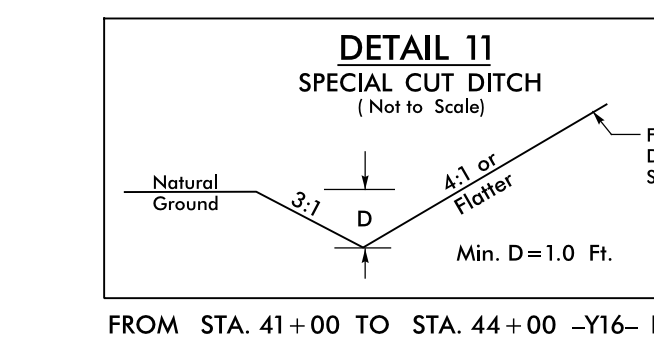

FROM STA. 41+00 TO STA. 44+00 -Y16- RT
 FROM STA. 39+00 TO STA. 41+77 -Y17- LT
 FROM STA. 15+00 TO STA. 15+75 -DR4- LT
 FROM STA. 23+60 TO STA. 27+37 -SR17- RT

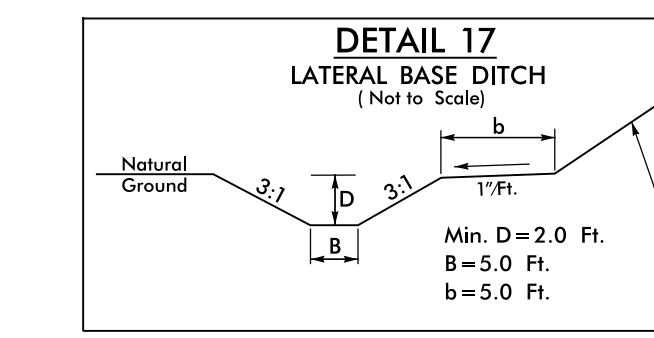

FROM STA. 22+22 TO STA. 24+00 -Y16RPC- RT

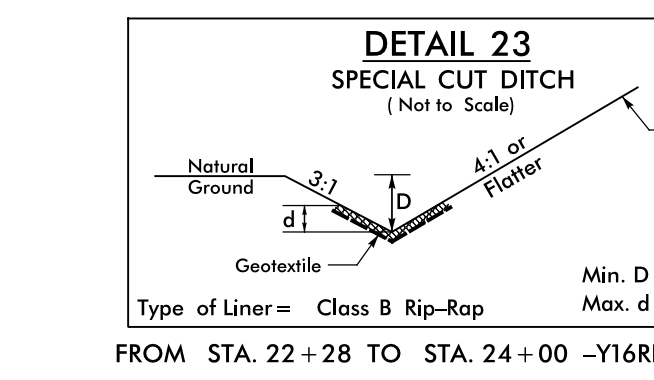

FROM STA. 22+28 TO STA. 24+00 -Y16RPA- LT

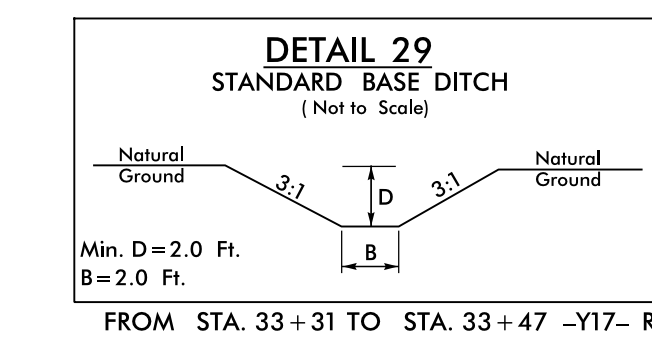

FROM STA. 33+31 TO STA. 33+47 -Y17- RT

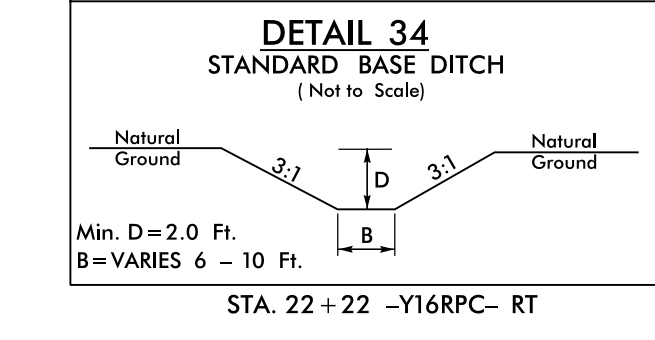

STA. 22+22 -Y16RPC- RT

B:17/99

R:\MAR-2021\08-31\1-5986B_Rdy_psh_2D-3.dgn