

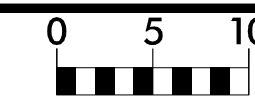

6/23/16



PROJ. REFERENCE NO.  
B-4407

SHEET NO.  
X-1

90 80 70 60 50 40 30 20 10 0 10 20 30 40 50 60 70 80 90

270 270

260 260

250 250

270 270

260 260

250 250

270 270

260 260

250 250

270 270

260 260

250 250

270 270

260 260

250 250

260 260

250 250

240 240

90 80 70 60 50 40 30 20 10 0 10 20 30 40 50 60 70 80 90

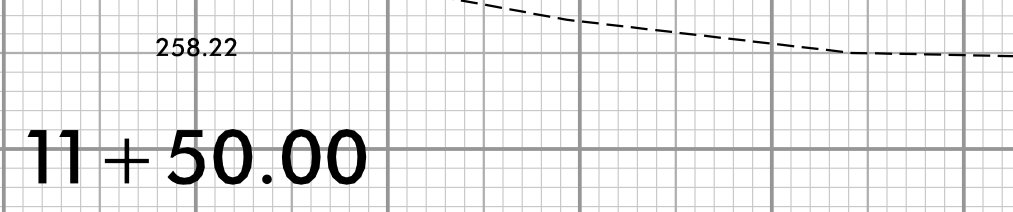
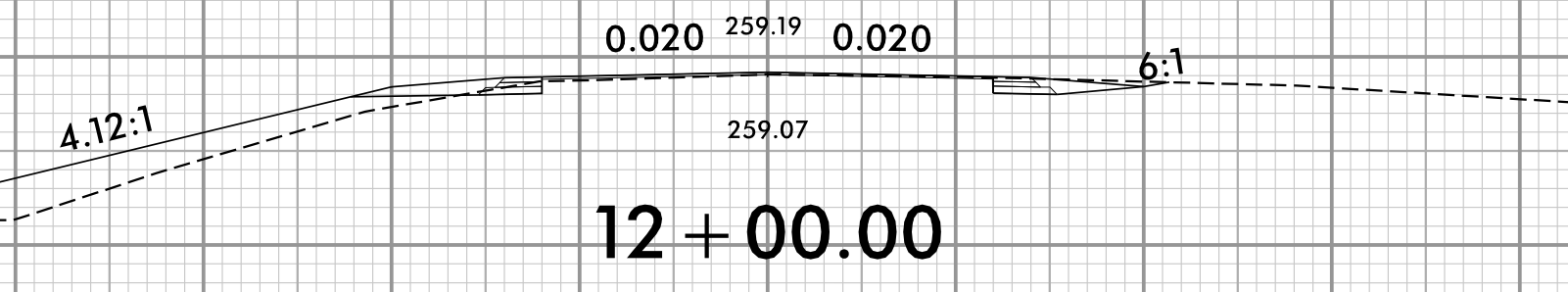
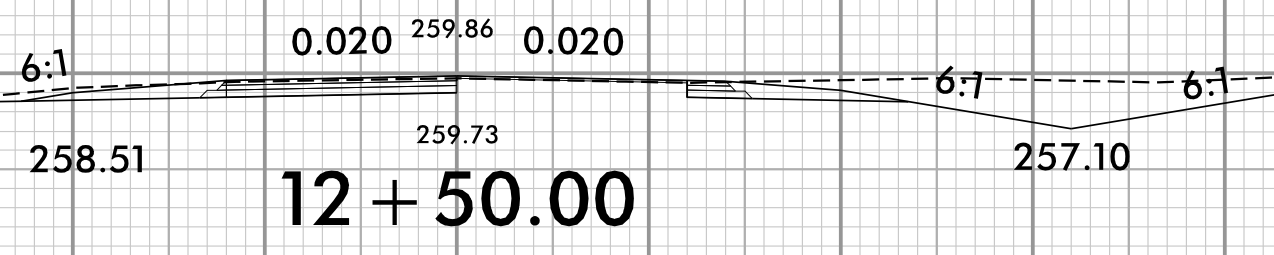
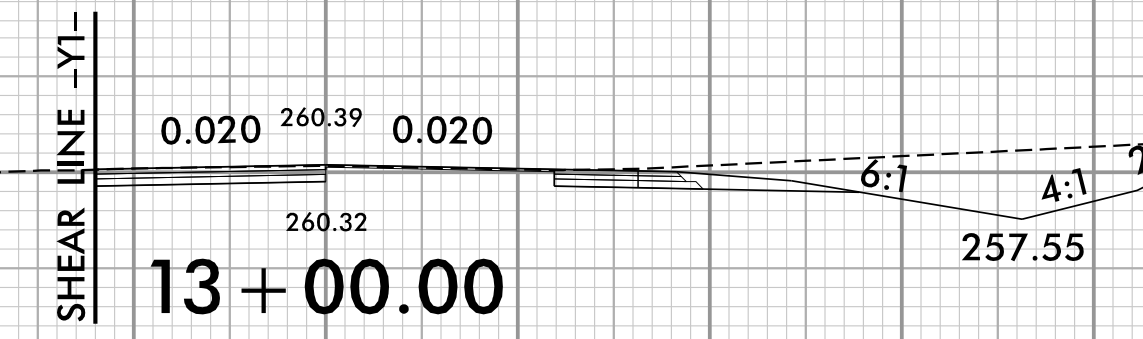
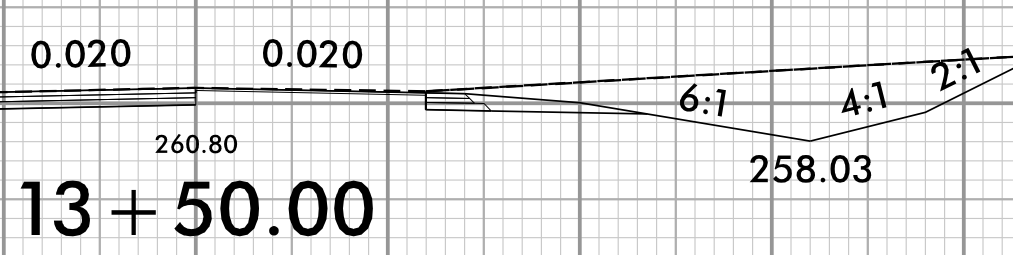

BEGIN PROJECT B-4407  
 BEGIN CONSTRUCTION -L- STA. 11 + 50.00

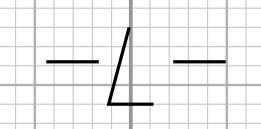
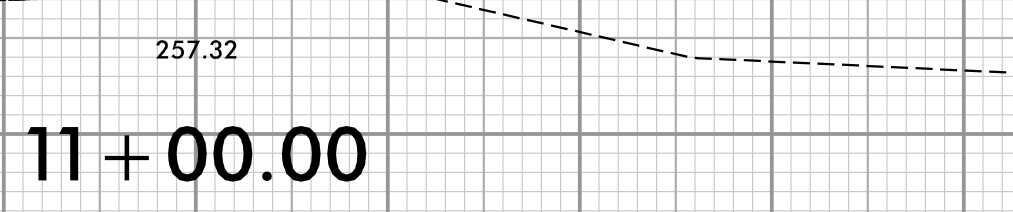

9/1/2020 1:32:26 PM  
..\\XSC\B4407-rdy-xpl.L.dgn  
User:rlodges

90 80 70 60 50 40 30 20 10 0 10 20 30 40 50 60 70 80 90

280

280

270

270

260

260

280

280

270

270

260

260

250

250

270

270

260

260

250

250

270

270

260

260

250

250

270

270

260

260

250

250

270

270

260

260

250

250

90 80 70 60 50 40 30 20 10 0 10 20 30 40 50 60 70 80 90

16 + 50.00

16 + 00.00

15 + 50.00

15 + 00.00

14 + 50.00

14 + 00.00

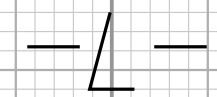

6/23/16

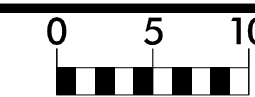

PROJ. REFERENCE NO.  
B-4407

SHEET NO.  
X-3

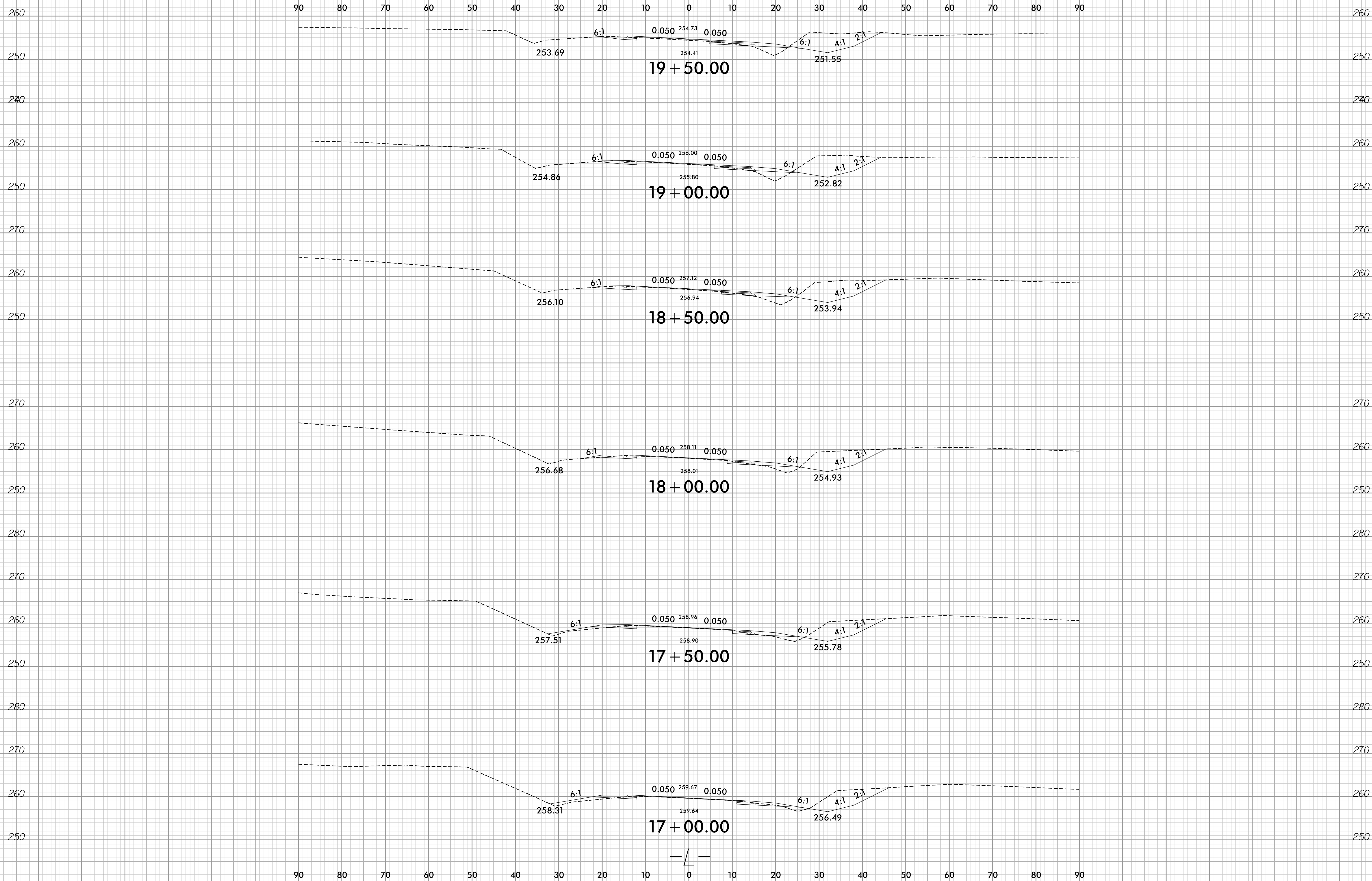

9/2/2020 10:21:19 AM  
\\XSC\B4407\_rdy\_xpl.L.dgn  
User:Riddovics

6/23/16

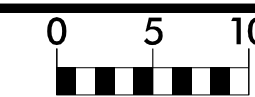

PROJ. REFERENCE NO.  
B-4407

SHEET NO.  
X-4

90 80 70 60 50 40 30 20 10 0 10 20 30 40 50 60 70 80 90

260

250

240

22 + 50.00

260

250

240

22 + 00.00

260

250

240

21 + 50.00

260

250

240

21 + 00.00

260

250

240

20 + 50.00

260

250

240

20 + 00.00

260

250

240

90 80 70 60 50 40 30 20 10 0 10 20 30 40 50 60 70 80 90

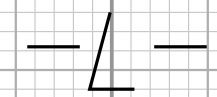

9/2/2020 10:21:19 AM  
\\XSC\B4407\_rdy\_xpl.L.dgn  
User:Riddovos

6/23/16

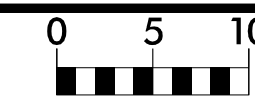

PROJ. REFERENCE NO.  
B-4407

SHEET NO.  
X-5

90 80 70 60 50 40 30 20 10 0 10 20 30 40 50 60 70 80 90

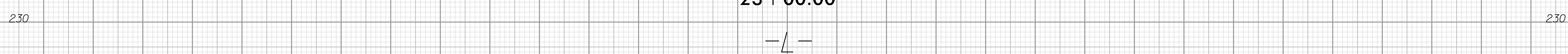
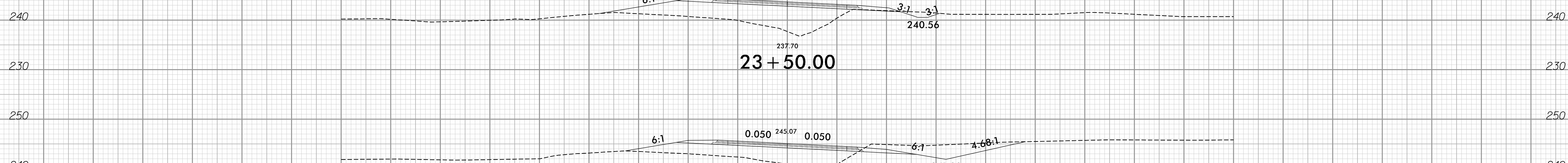
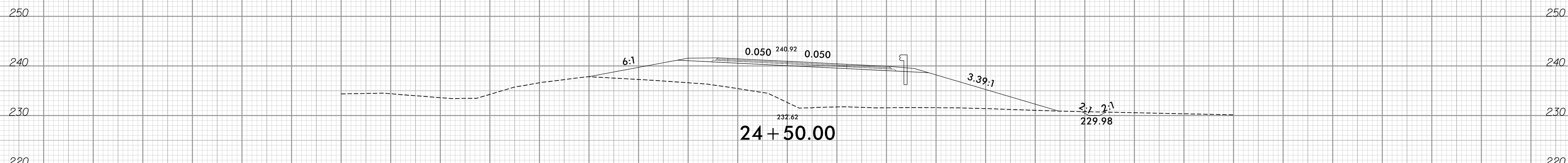
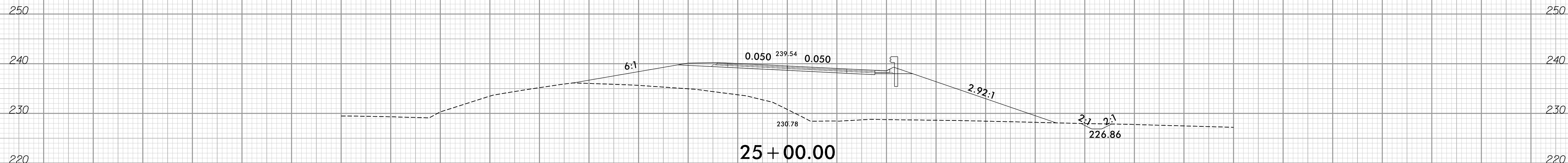

90 80 70 60 50 40 30 20 10 0 10 20 30 40 50 60 70 80 90

9/2/2020 10:21:19 AM  
\\XSC\B4407\_rdy\_xpl.L.dgn  
User:Riddovos

6/23/16

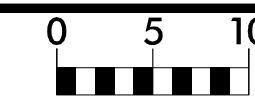

PROJ. REFERENCE NO.  
B-4407

SHEET NO.  
X-6

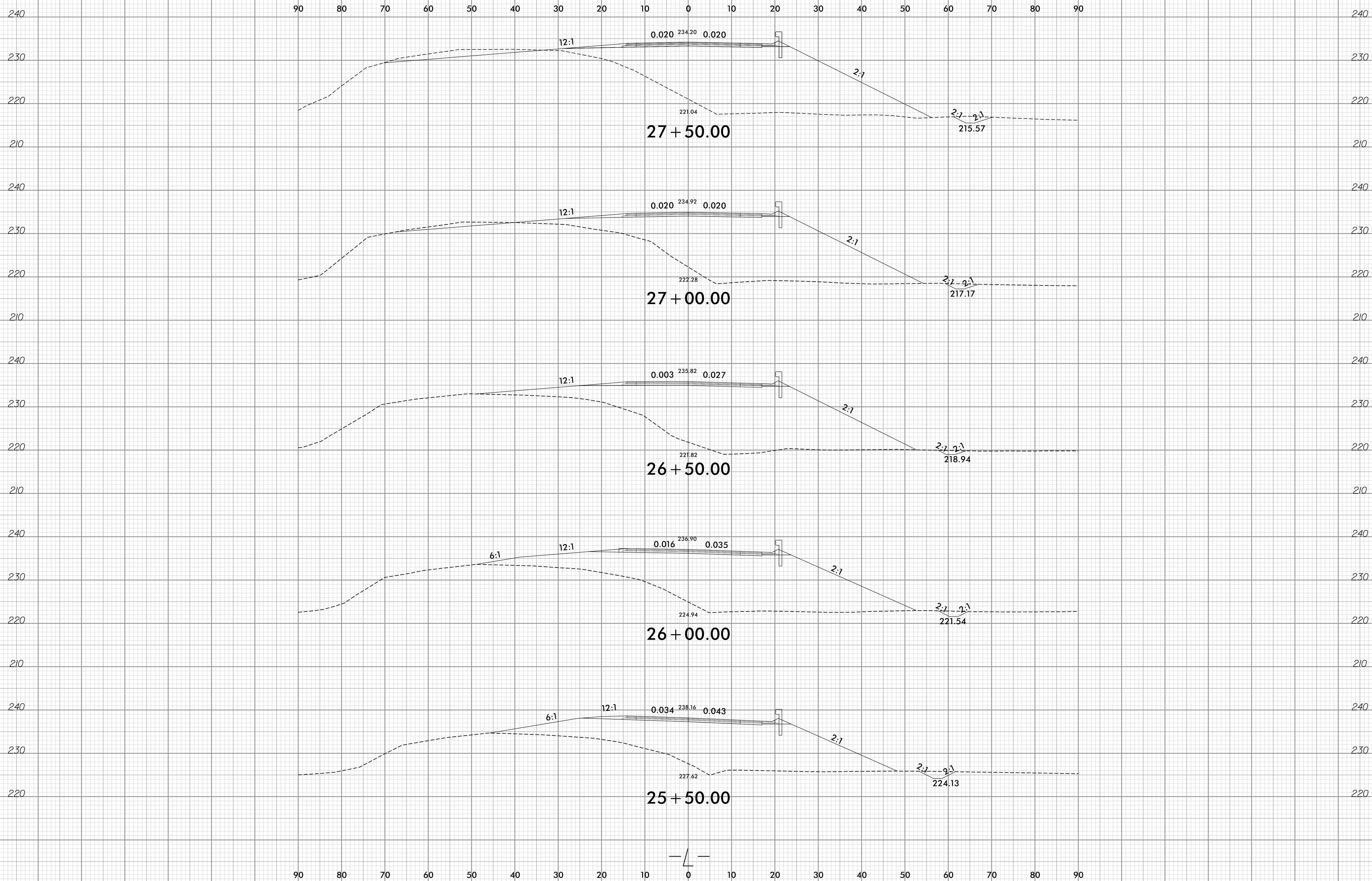

9/2/2020 10:21:19 AM  
User: fjdobies





6/23/16

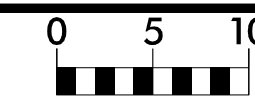

PROJ. REFERENCE NO.  
B-4407

SHEET NO.  
X-8

90 80 70 60 50 40 30 20 10 0 10 20 30 40 50 60 70 80 90

240

240

230

230

220

220

210

210

200

200

0.025 233.61 0.025

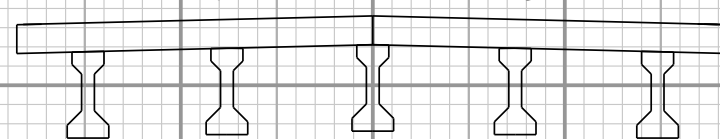

213.88

30 + 50.00

240

240

230

230

220

220

210

210

200

200

0.025 233.34 0.025

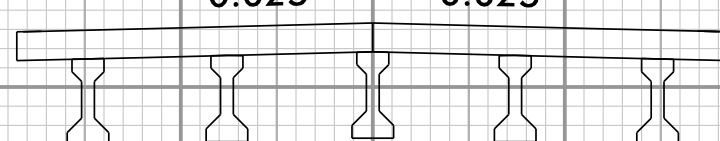

213.71

30 + 00.00

240

240

230

230

220

220

210

210

0.025 233.20 0.025

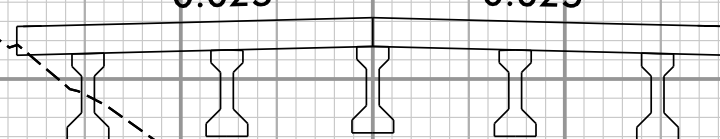

218.70

29 + 68.67

2:1

200

200

240

240

95 90 80 70 60 50 40 30 20 10 0 10 20 30 40 50 60 70 80 90

9/2/2020 02:19 AM  
\\XSC\B4407\_rdy\_xpl.L.dgn  
User:rlodges





90 80 70 60 50 40 30 20 10 0 10 20 30 40 50 60 70 80 90

240

230

220

210

200

240

230

220

210

200

190

240

230

220

210

200

190

180

90 80 70 60 50 40 30 20 10 0 10 20 30 40 50 60 70 80 90

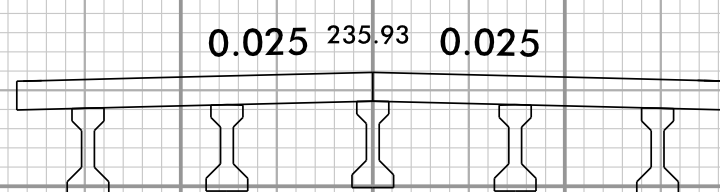

208.42  
**34 + 50.00**

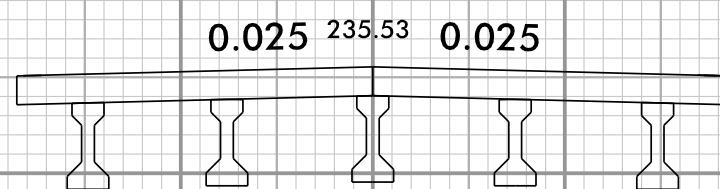

203.46  
**34 + 00.00**

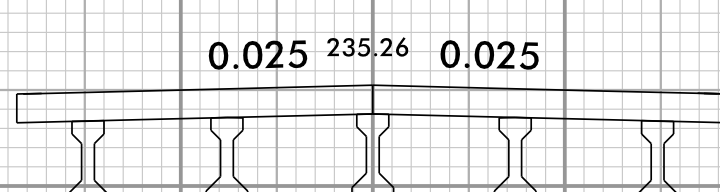

191.50  
**33 + 50.00**

6/23/16

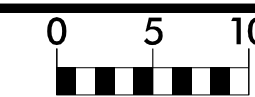

PROJ. REFERENCE NO.  
B-4407

SHEET NO.  
X-12

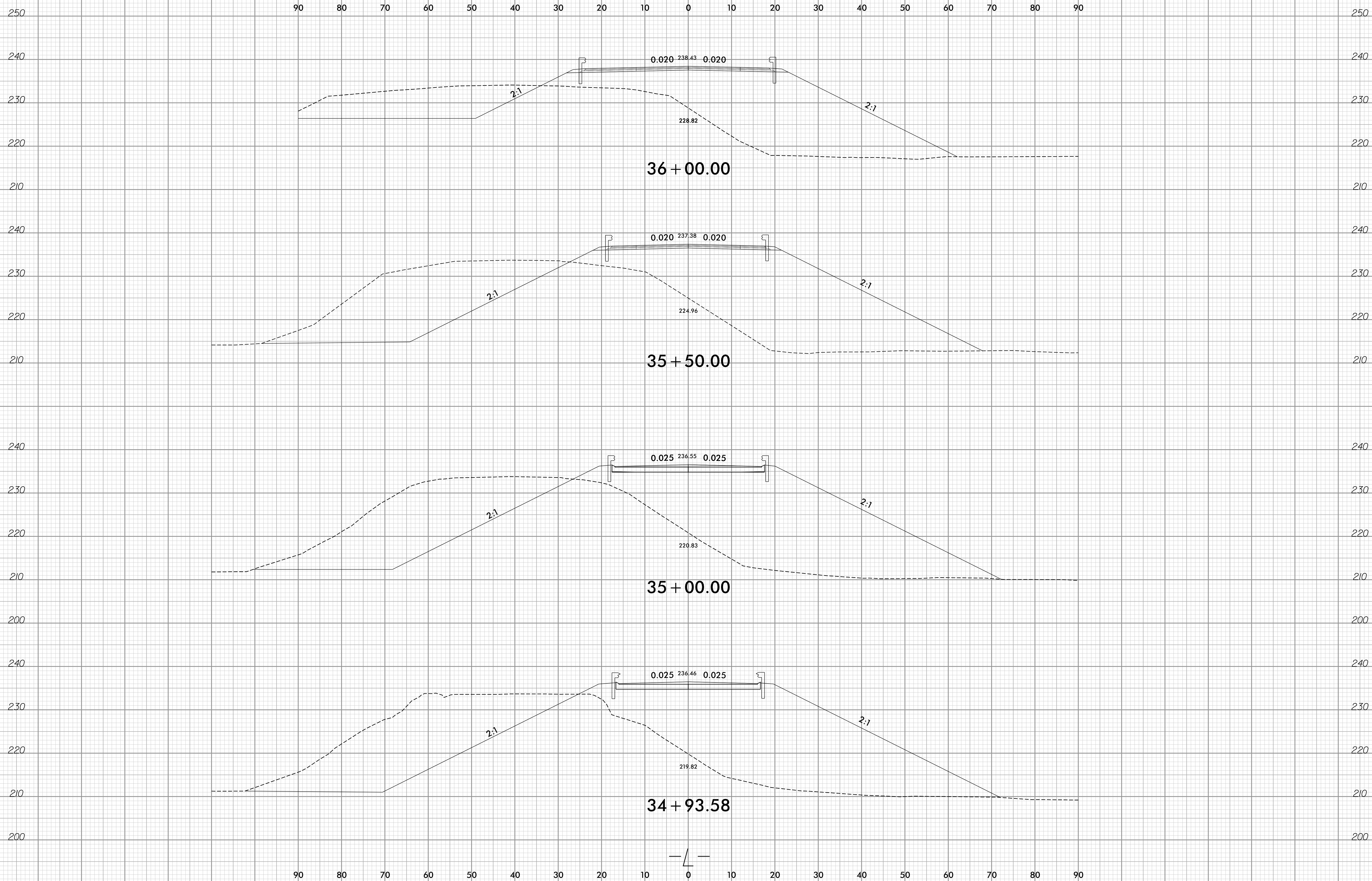

9/2/2020 02:19 AM  
User: fjdobies

6/23/16

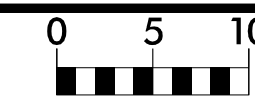

PROJ. REFERENCE NO.  
B-4407

SHEET NO.  
X-13

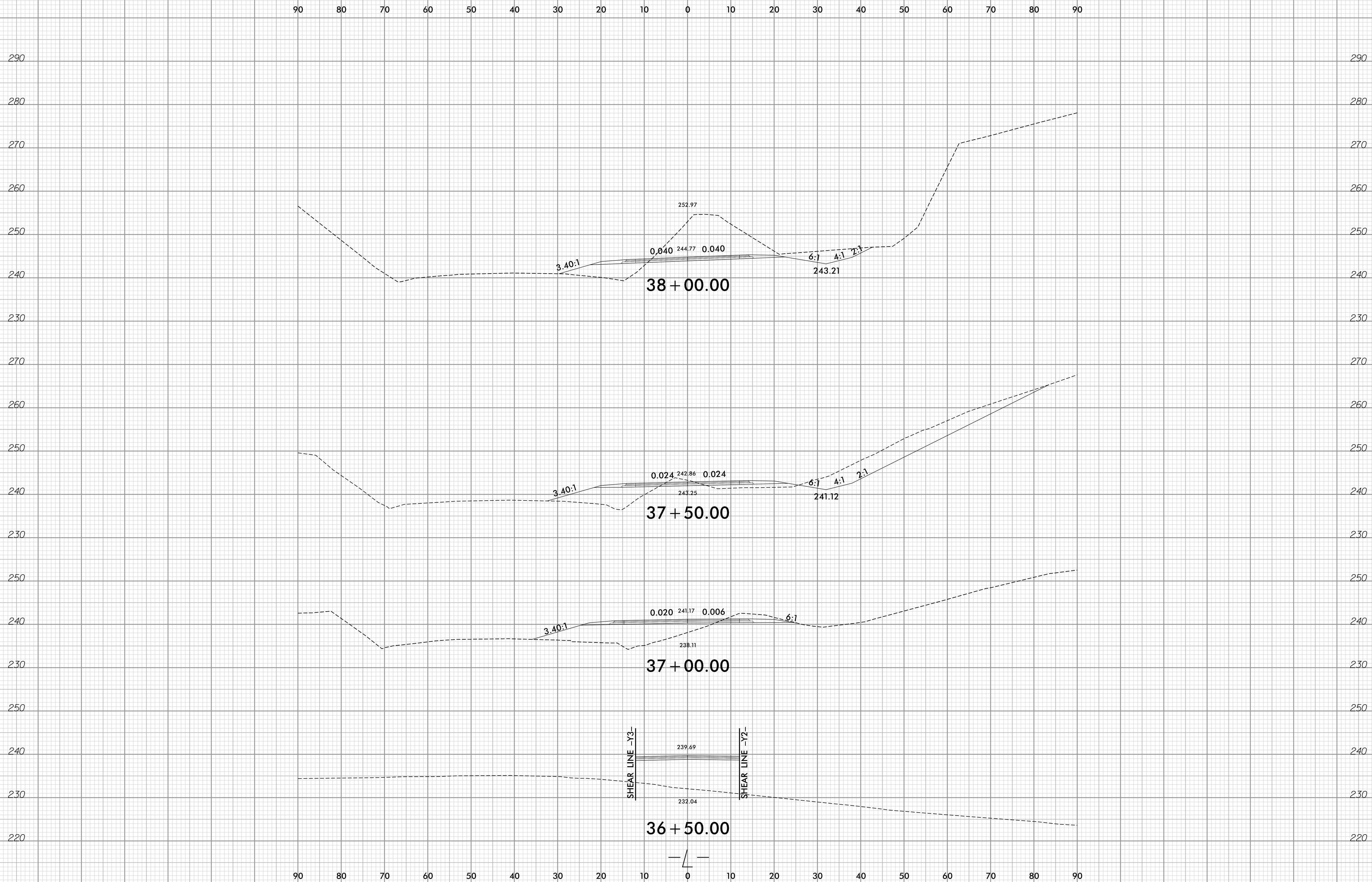

9/2/2020 10:21:19 AM  
User: jldcoves

6/23/16

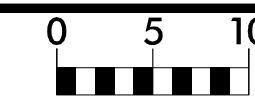

PROJ. REFERENCE NO.  
B-4407

SHEET NO.  
X-14

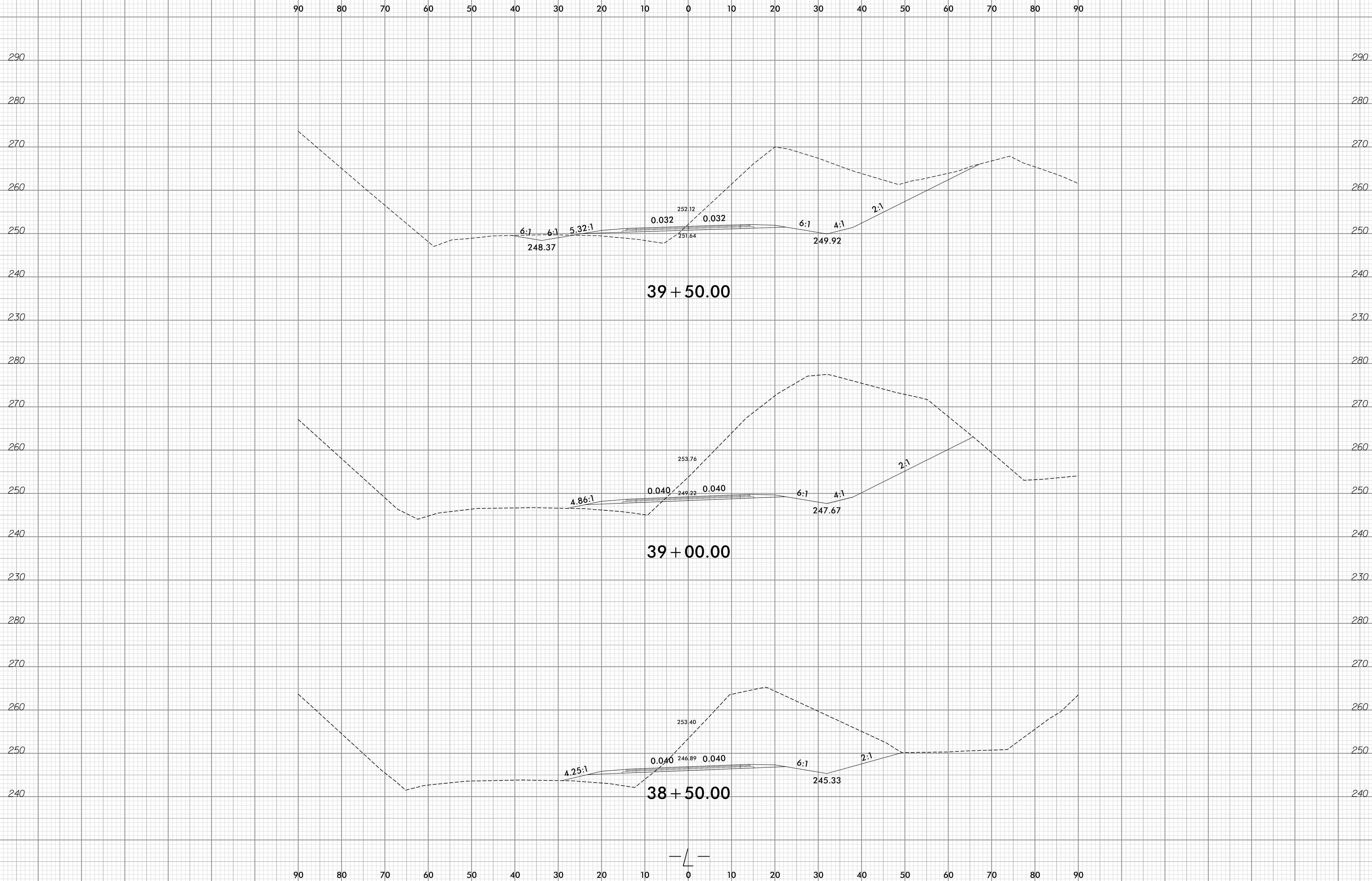

9/2/2020 10:21:19 AM  
\\XSC\B4407\_rdy\_xpl.L.dgn  
User:rlodges

6/23/16

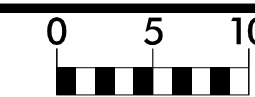

PROJ. REFERENCE NO.  
B-4407

SHEET NO.  
X-15

90 80 70 60 50 40 30 20 10 0 10 20 30 40 50 60 70 80 90

310

310

300

300

290

290

280

280

270

270

260

260

250

250

240

240

40 + 50.00

290

290

280

280

270

270

260

260

250

250

40 + 00.00

240

240

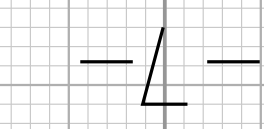

90 80 70 60 50 40 30 20 10 0 10 20 30 40 50 60 70 80 90

9/2/2020 10:21:19 AM  
\\XSC\B4407\_rdy\_xpl.L.dgn  
User:rdy



6/23/16

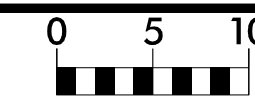

PROJ. REFERENCE NO.  
B-4407

SHEET NO.  
X-16

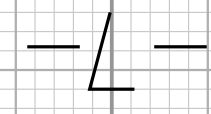
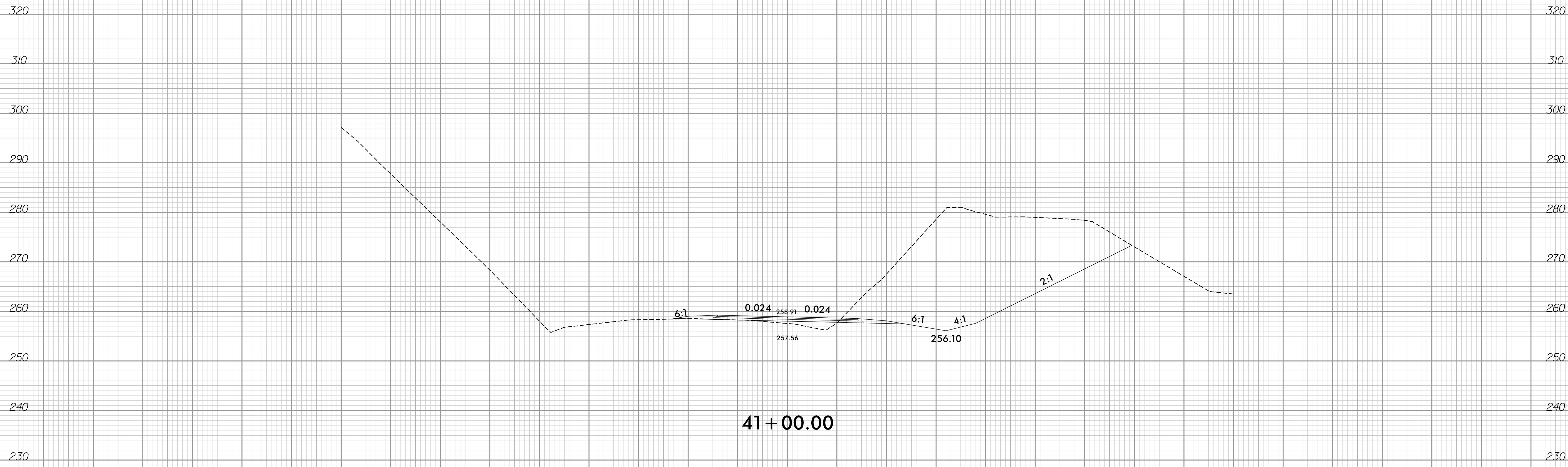
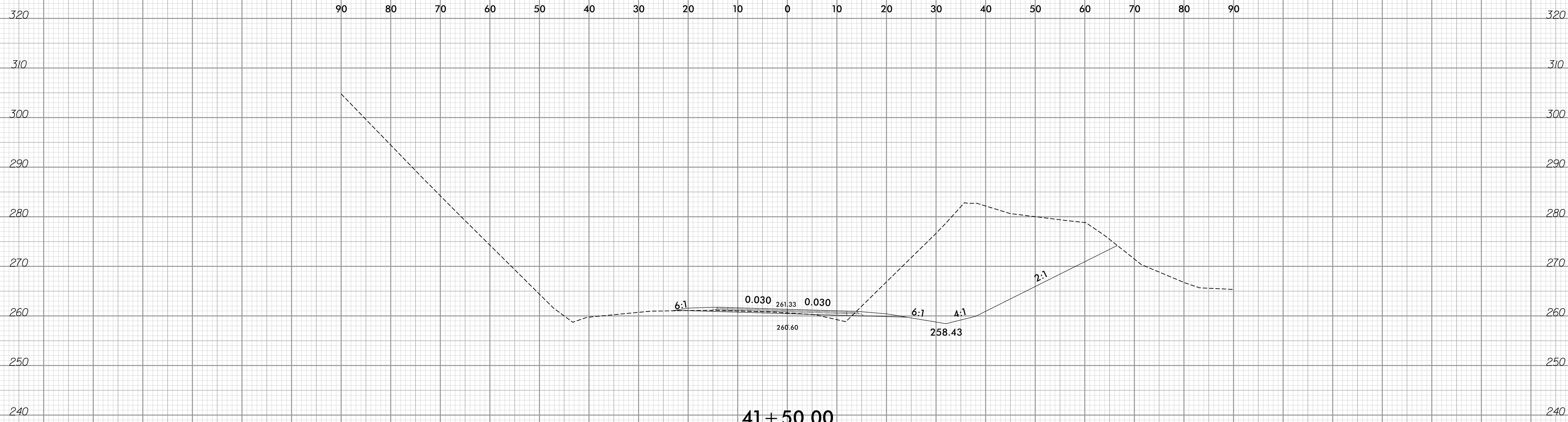

9/2/2020 02:19 AM  
..X:\SC\B4407\_rdy\_xpl.L.dgn  
User:rdy

6/23/16

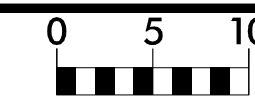

PROJ. REFERENCE NO.  
B-4407

SHEET NO.  
X-17

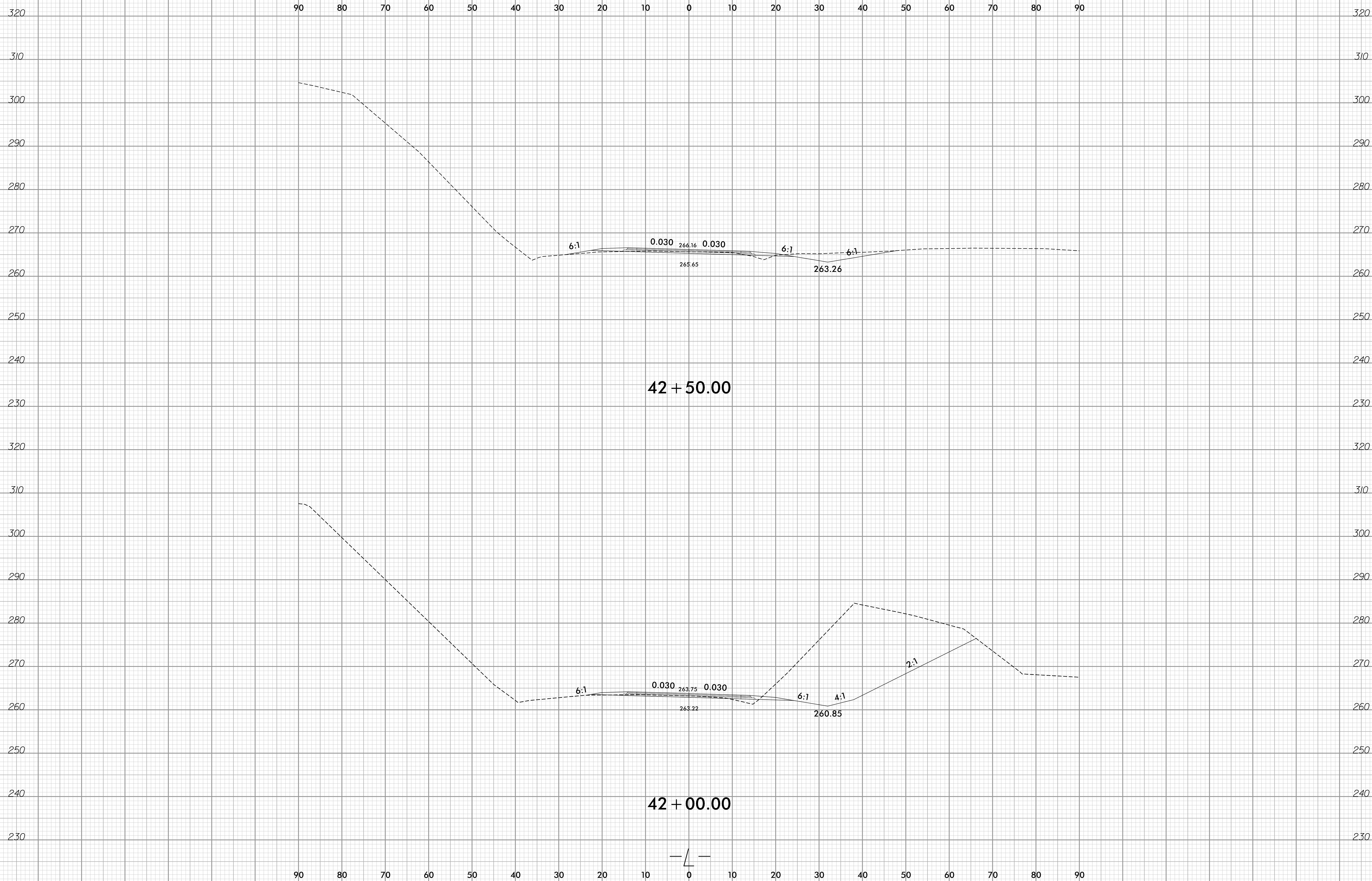

9/2/2020 02:19 AM  
 ..\XSC\B4407\_rdy\_xpl.L.dgn  
 User: jldcoves

6/23/16

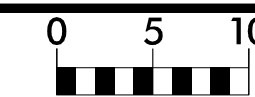

PROJ. REFERENCE NO.  
B-4407

SHEET NO.  
X-18

90 80 70 60 50 40 30 20 10 0 10 20 30 40 50 60 70 80 90

310

310

300

300

290

290

280

280

270

270

260

260

250

250

240

240

43 + 50.00

320

320

310

310

300

300

290

290

280

280

270

270

260

260

250

250

240

240

43 + 00.00

230

230

90 80 70 60 50 40 30 20 10 0 10 20 30 40 50 60 70 80 90

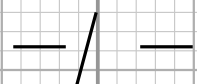

9/2/2020 02:19 AM  
 ..\XSC\B4407\_rdy\_xpl.L.dgn  
 User: jldcoves

6/23/16

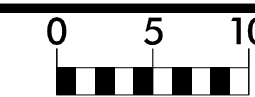

PROJ. REFERENCE NO.  
B-4407

SHEET NO.  
X-19

90 80 70 60 50 40 30 20 10 0 10 20 30 40 50 60 70 80 90

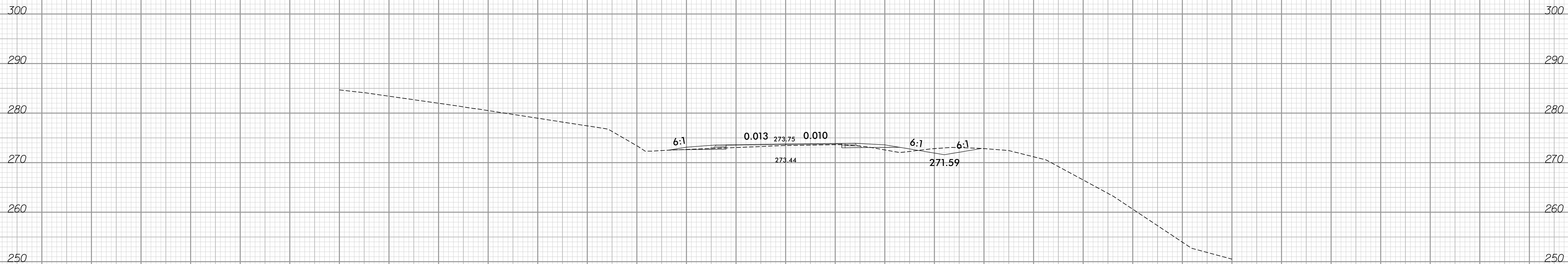

44 + 50.00

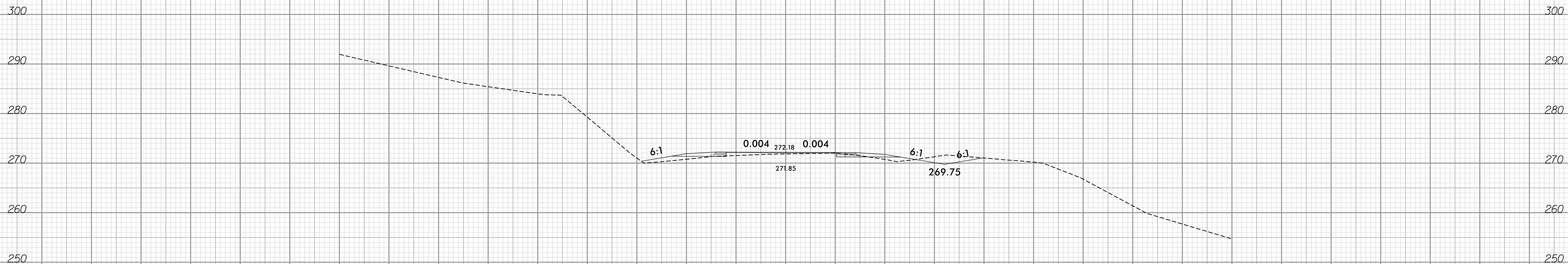

44 + 00.00

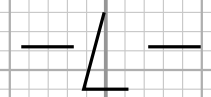

90 80 70 60 50 40 30 20 10 0 10 20 30 40 50 60 70 80 90

9/2/2020 02:19 AM  
\\XSC\B4407\_rdy\_xpl.L.dgn  
User:ldcoves

6/23/16

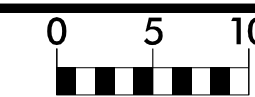

PROJ. REFERENCE NO.  
B-4407

SHEET NO.  
X-20

90 80 70 60 50 40 30 20 10 0 10 20 30 40 50 60 70 80 90

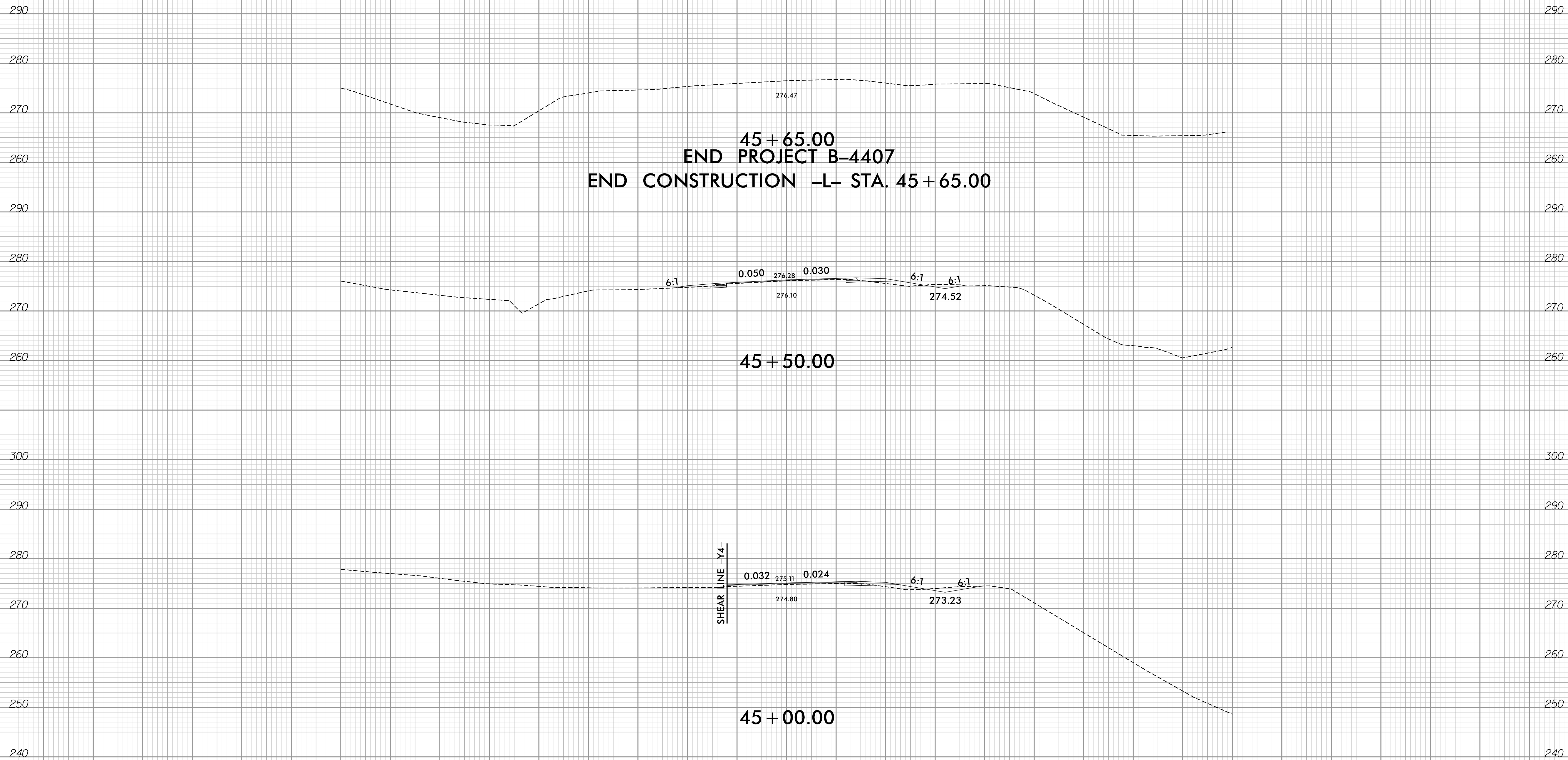

90 80 70 60 50 40 30 20 10 0 10 20 30 40 50 60 70 80 90

9/2/2020 02:19 AM  
\\XSC\B4407\_rdy\_xpl.L.dgn  
User:ldcoves

6/22/16

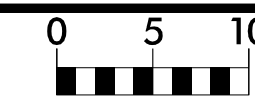

PROJ. REFERENCE NO.  
B-4407

SHEET NO.  
X-21

110 100 90 80 70 60 50 40 30 20 10 0 10 20 30 40 50 60 70 80 90 100 110

260

260

250

250

240

240

230

230

220

220

210

210

221.69  
0.020 0.020

2:1

2:1

219.55

11 + 00.00

250

250

240

240

230

230

220

220

210

210

217.57  
0.020 0.020

2:1

2:1

217.28

10 + 50.00

260

260

240

240

230

230

220

220

210

210

216.31  
10 + 22.00

BEGIN CONSTRUCTION -Y2- STA. 10 + 22.00

-Y2-

110 100 90 80 70 60 50 40 30 20 10 0 10 20 30 40 50 60 70 80 90 100 110

9/2/2020 10:03:59 AM  
User: fjdobson

110 100 90 80 70 60 50 40 30 20 10 0 10 20 30 40 50 60 70 80 90 100 110

250  
240  
230  
220  
210  
260  
250  
240  
230  
220  
210  
270  
260  
250  
240  
230  
220  
210

250  
240  
230  
220  
210  
260  
250  
240  
230  
220  
210  
270  
260  
250  
240  
230  
220  
210

12 + 43.96  
END CONSTRUCTION -Y2- STA. 12 + 43.96

12 + 00.00

11 + 50.00

-Y2-

232.25

234.35

226.33

227.90

0.020 0.020

0.020 0.020

2:1

2:1

2:1

2:1

6/23/16

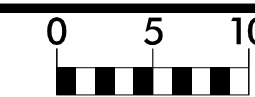

PROJ. REFERENCE NO.  
B-4407

SHEET NO.  
X-23

110 100 90 80 70 60 50 40 30 20 10 0 10 20 30 40 50 60 70 80 90 100 110

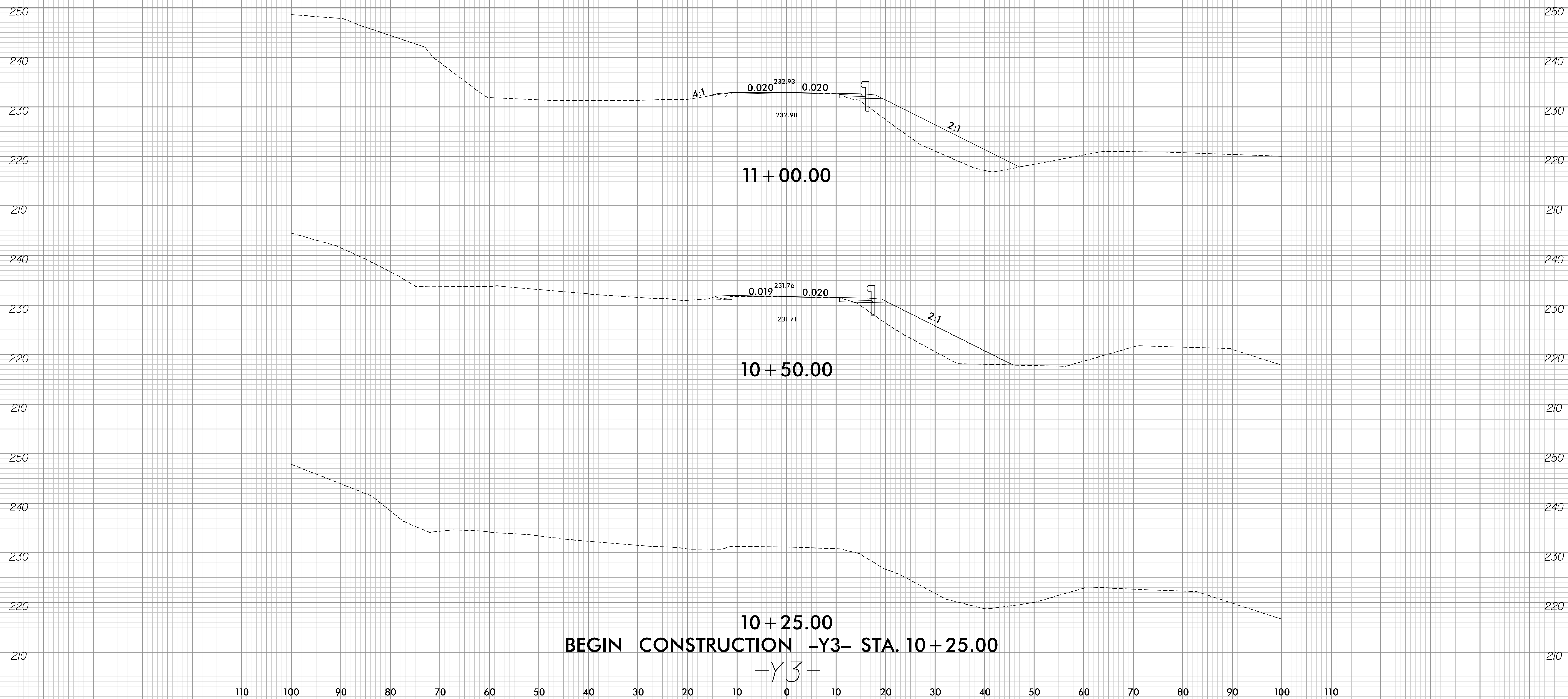

10+25.00  
 BEGIN CONSTRUCTION -Y3- STA. 10+25.00  
 -Y3-

9/2/2020 10:59:09 AM  
 ..\XSC\B4407-rdy-xpl-y3.dgn  
 User: jldavis

110 100 90 80 70 60 50 40 30 20 10 0 10 20 30 40 50 60 70 80 90 100 110



6/23/16

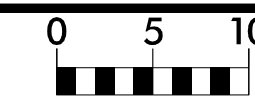

PROJ. REFERENCE NO.  
B-4407

SHEET NO.  
X-24

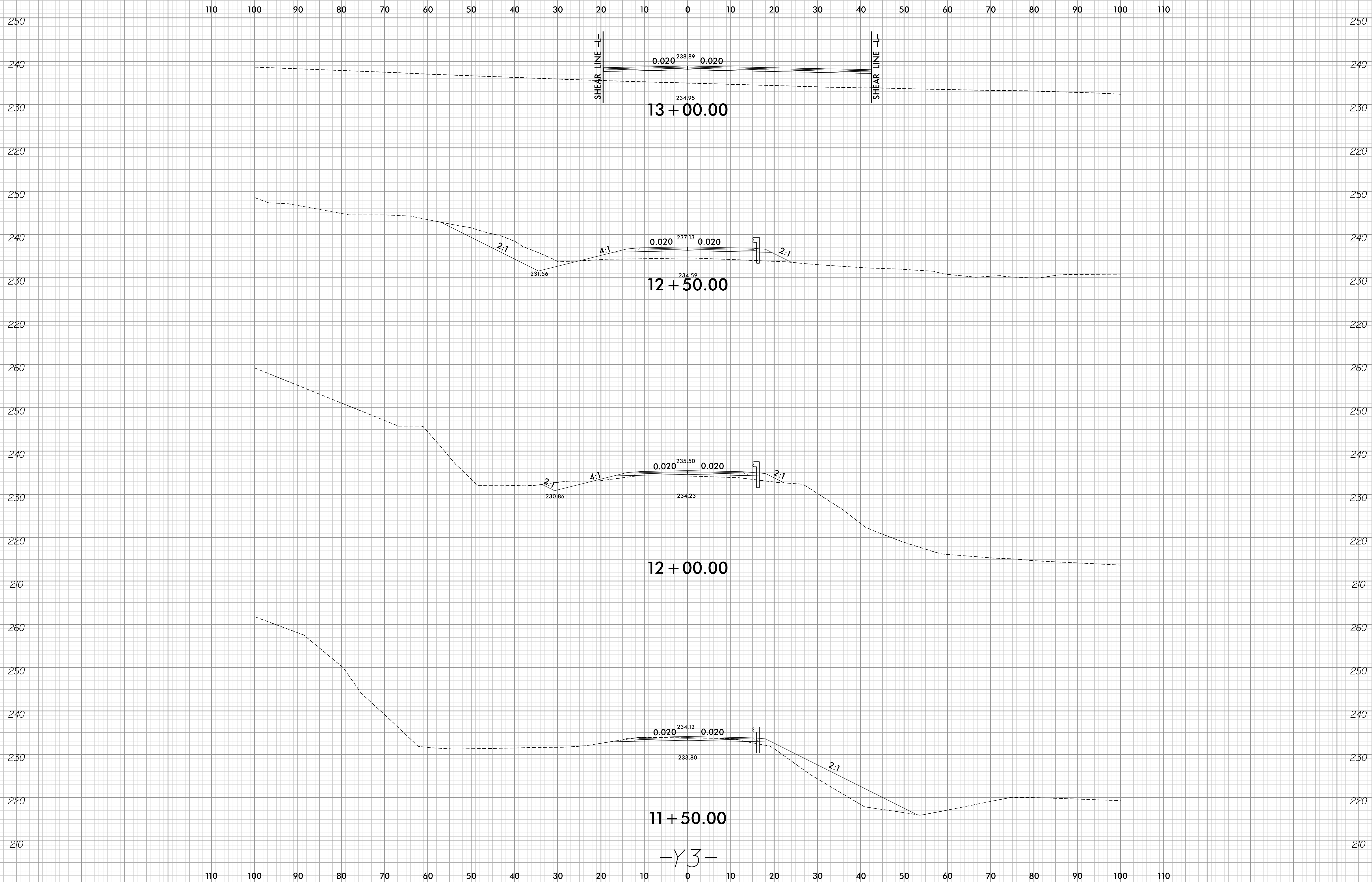

-Y3-

9/2/2020 10:59:09 AM  
User: jldcoves

6/23/16

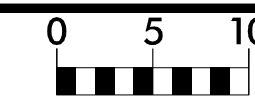

PROJ. REFERENCE NO.  
B-4407

SHEET NO.  
X-25

120 110 100 90 80 70 60 50 40 30 20 10 0 10 20 30 40 50 60 70 80 90 100 110

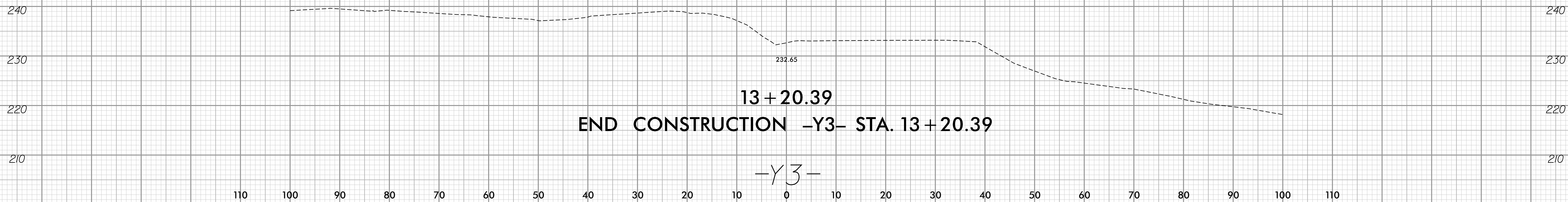

2/16/2021 9:02:54 AM  
\\XSC\B4407-rdy-xpl-Y3.dgn  
User:rlodges