

Project: B-5302

STATE OF NORTH CAROLINA
DIVISION OF HIGHWAYS

Project No.	Sheet No.
B-5302	Sig. 1.0

BEAUFORT COUNTY

LOCATION: REPLACE BRIDGE NO.3 OVER NORFOLK SOUTHERN RAILROAD ON US 17 BUS.

TYPE OF WORK: TRAFFIC SIGNALS

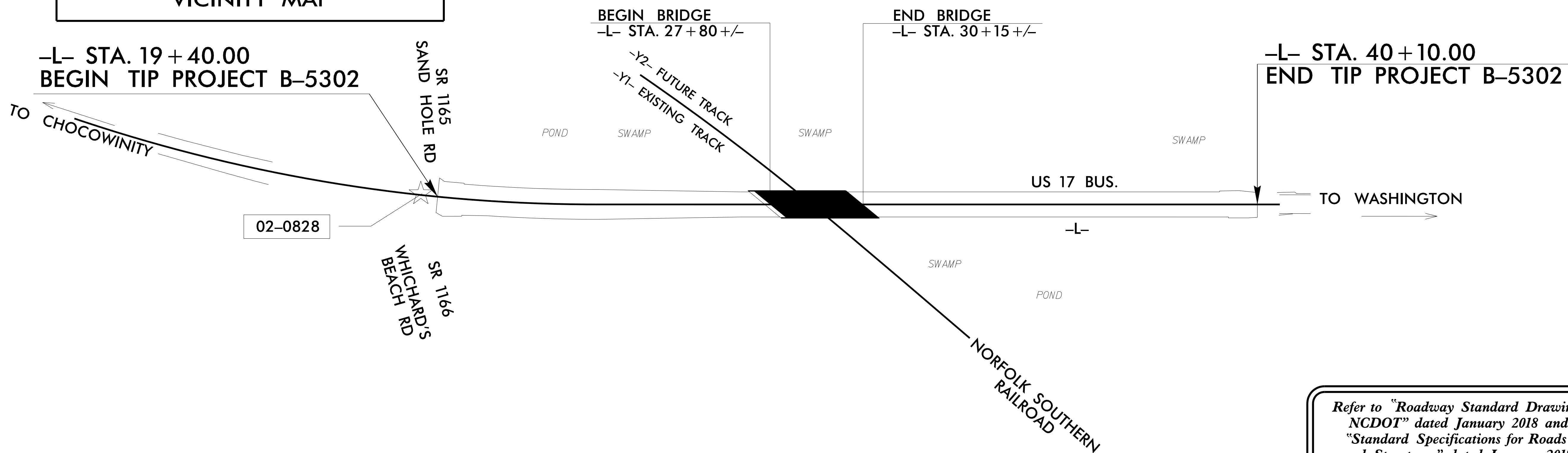
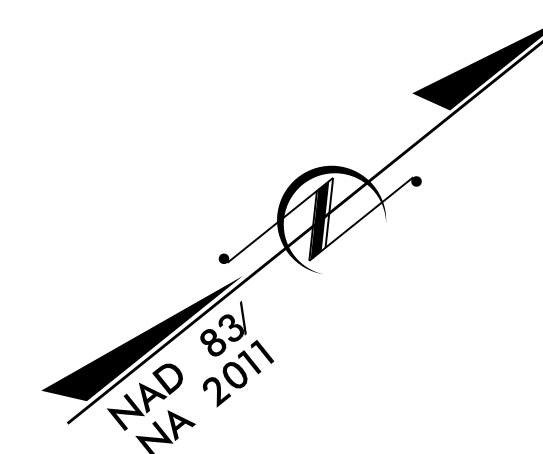
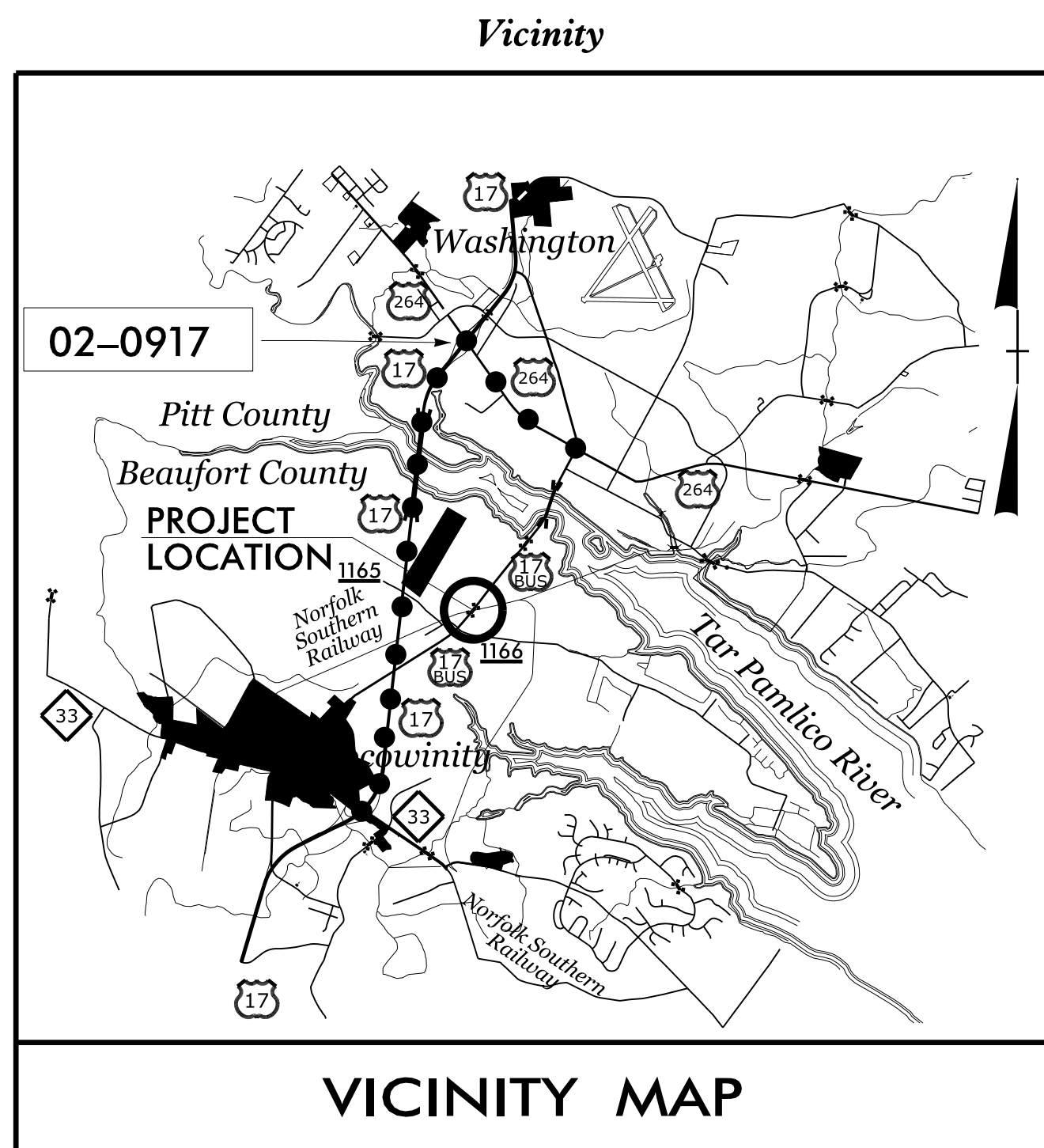

Refer to "Roadway Standard Drawings NCDOT" dated January 2018 and "Standard Specifications for Roads and Structures" dated January 2018.

Sheet #	Reference #	Index of Plans	Location/Description
Sig. 1.0	-----	Title Sheet	
Sig. 2.0-2.1	02-0828T	US 17 Bus. at SR 1165 (Sand Hole Rd.) / SR 1166 (Wichard's Beach Rd.)	
Sig. 3.0-3.2	02-0828	US 17 Bus. at SR 1165 (Sand Hole Rd.) / SR 1166 (Wichard's Beach Rd.)	
Sig. 4.0-4.2	* 02-0917	US 264 (Pactious Hwy.) at US 17 Byp. Southbound Ramps * On Detour	

INTELLIGENT TRANSPORTATION AND SIGNALS UNIT

Contacts:

Meredith McDiarmid, PE., CPM- ITS and Signals Engineer
 Meghan E. LeBlanc, PE. - Esatern Region Signals Project Engineer
 Keith M. Mimms, PE. - Signal Equipment Design Engineer

Prepared in the Office of:
 DIVISION OF HIGHWAYS
 TRANSPORTATION MOBILITY AND SAFETY
 DIVISION

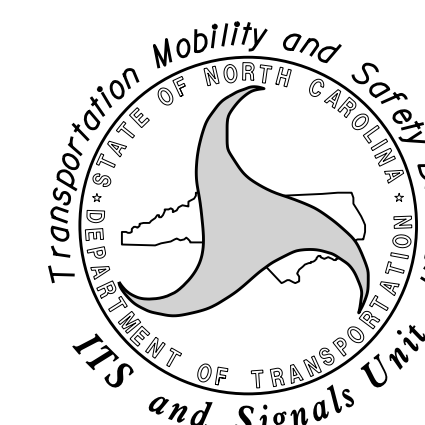

PHASING DIAGRAM

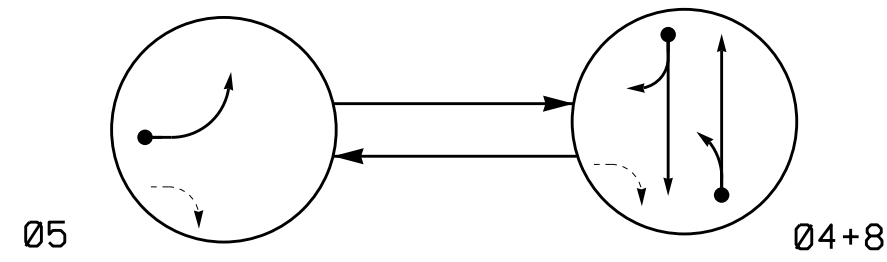

TABLE OF OPERATION

SIGNAL FACE	PHASE		
	05	04+8	F
51, 52	←	←	←
41, 42	R	G	R
81	R	G	R
82	R	G	R

OASIS 2070L LOOP & DETECTOR INSTALLATION CHART

LOOP	SIZE (FT)	DISTANCE FROM STOPBAR (FT)	TURNS	NEW LOOP	DETECTOR PROGRAMMING				SYSTEM LOOP	NEW CARD
					PHASE	CALLING EXTENSION	STRETCH TIME	DELAY TIME		
1B	6X40	0	2-4-2	-	TEMPORARILY DISCONNECT	-	-	-	-	-
2A	6X6	420	5	-	TEMPORARILY DISCONNECT	-	-	-	-	-
2B	6X6	420	5	-	TEMPORARILY DISCONNECT	-	-	-	-	-
4A	6X40	0	2-4-2	-	4	Y	Y	-	15	-
5A	6X40	0	2-4-2	Y	5	Y	Y	-	3	-
8A	6X40	0	2-4-2	-	8	Y	Y	-	3	-

2 Phase Fully Actuated Isolated

NOTES

- Refer to "Roadway Standard Drawings NCDOT" dated January 2018 and "Standard Specifications for Roads and Structures" dated January 2018.
- Do not program signal for late night flashing operation unless otherwise directed by the Engineer.
- Remove existing signal heads numbered 11, 21, 22, 23, 61 and 62.
- Set all detector units to presence mode.
- Pavement markings are existing.

PHASING DIAGRAM DETECTION LEGEND

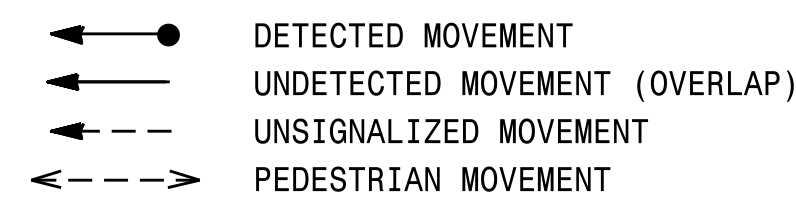

SIGNAL FACE I.D.

All Heads L.E.D.

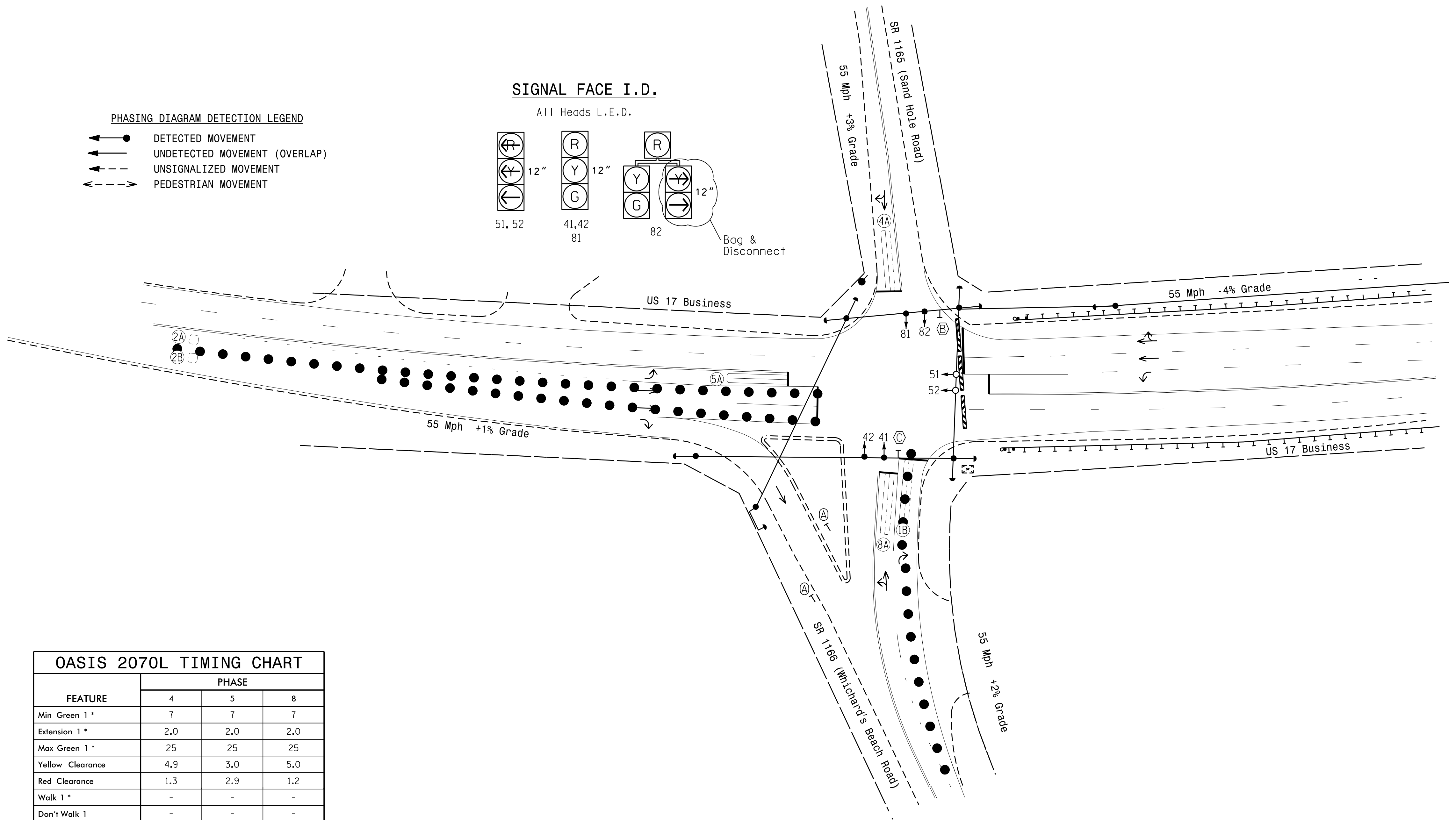
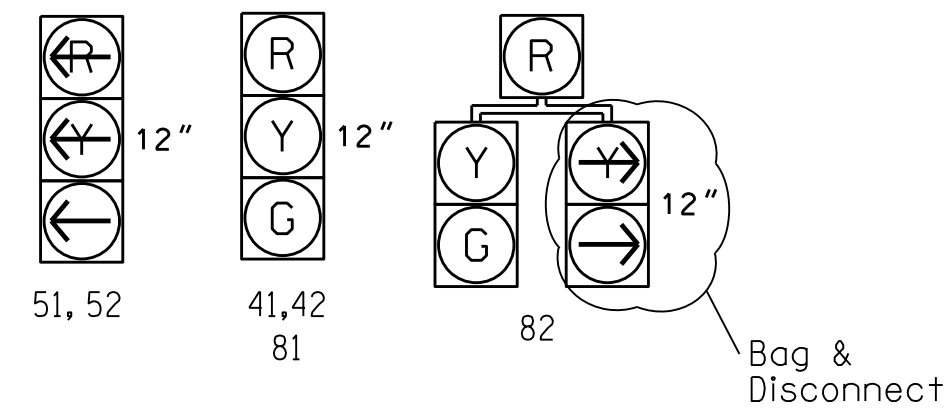

OASIS 2070L TIMING CHART

FEATURE	PHASE		
	4	5	8
Min Green 1 *	7	7	7
Extension 1 *	2.0	2.0	2.0
Max Green 1 *	25	25	25
Yellow Clearance	4.9	3.0	5.0
Red Clearance	1.3	2.9	1.2
Walk 1 *	-	-	-
Don't Walk 1	-	-	-
Seconds Per Actuation *	-	-	-
Max Variable Initial *	-	-	-
Time Before Reduction *	-	-	-
Time To Reduce *	-	-	-
Minimum Gap	-	-	-
Recall Mode	MIN RECALL	-	MIN RECALL
Vehicle Call Memory	-	-	-
Dual Entry	ON	-	ON
Simultaneous Gap	ON	ON	ON

* These values may be field adjusted. Min Green for all phases should not be lower than 4 seconds.

LEGEND

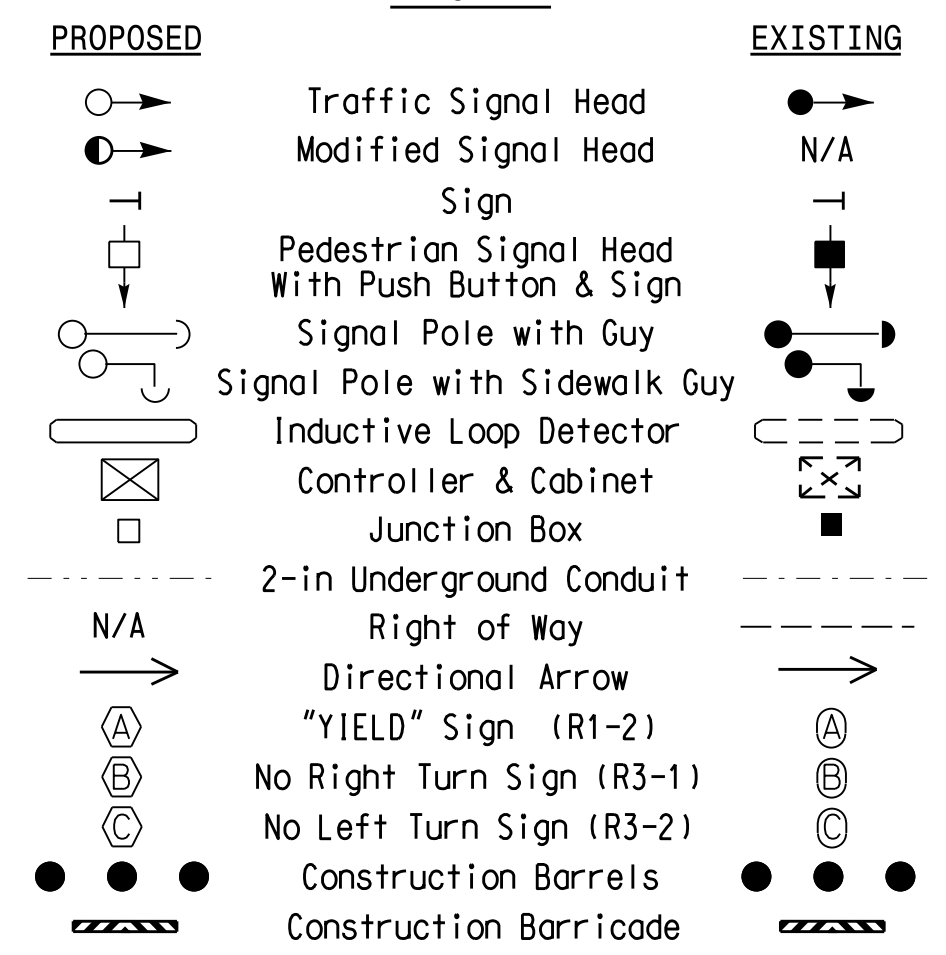

Signal Upgrade- Temporary

750 N. Greenfield Pkwy, Garner, NC 27529

US 17 Business at SR 1165 (Sand Hole Road) / SR 1166 (Whichard's Beach Road)

Division 2 Beaufort County N of Chocowinity

PLAN DATE: January 2019 REVIEWED BY: ZML

PREPARED BY: MEL REVIEWED BY:

SEAL

MEGHAN E. PLANE
ENGINEER
042608

DocuSigned by:
Meghan E. Plane
1/28/2019

SIG. INVENTORY NO. 02-0828T

SCALE 0 40
1" = 40'

28-Jan-2019 11:09
 \\p01\projects\B-5302\Traffic\Signal\02-0828T_5.dgn, 2019mdd.dgn
 mel/eb/lanc

EDI MODEL 2018ECL-NC CONFLICT MONITOR PROGRAMMING DETAIL

(remove jumper and set switches as shown)

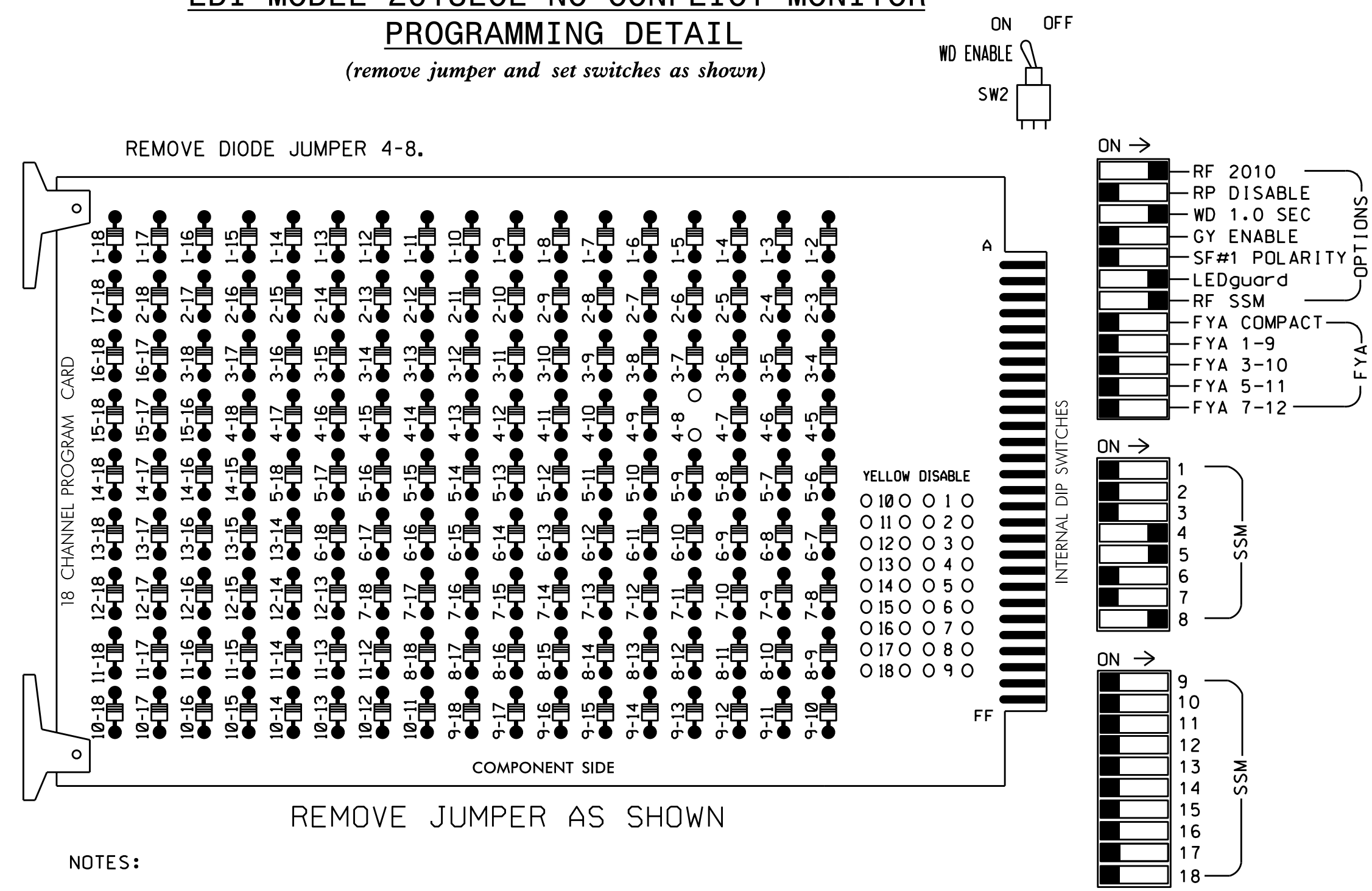

NOTES:

1. Card is provided with all diode jumpers in place. Removal of any jumper allows its channels to run concurrently.
2. Ensure jumpers SEL2-SEL5 and SEL9 are present on the monitor board.
3. Ensure that Red Enable is active at all times during normal operation.
4. Connect serial cable from conflict monitor to comm. port 1 of 2070 controller. Ensure conflict monitor communicates with 2070.

NOTES

1. To prevent "flash-conflict" problems, insert red flash program blocks for all unused vehicle load switches in the output file. The installer shall verify that signal heads flash in accordance with the Signal Plans.
2. Restore controller to factory defaults (Main Menu D-6) before programming per this electrical detail.
3. Program phases 4 and 8 for Dual Entry.
4. Enable Simultaneous Gap-Out for all phases.
5. Program phases 4 and 8 as First Phases.
6. Ensure phases 4, 5, and 8 are not programmed for Yellow Flash.

EQUIPMENT INFORMATION

CONTROLLER.....2070
 CABINET.....332 W/ AUX
 SOFTWARE.....ECONOLITE OASIS
 CABINET MOUNT.....BASE
 OUTPUT FILE POSITIONS...18 WITH AUX. OUTPUT FILE
 LOAD SWITCHES USED.....S5,S7,S11
 PHASES USED.....4,5,8
 OVERLAP "A".....NOT USED
 OVERLAP "B".....NOT USED
 OVERLAP "C".....NOT USED
 OVERLAP "D".....NOT USED

SIGNAL HEAD HOOK-UP CHART

LOAD SWITCH NO.	S1	S2	S3	S4	S5	S6	S7	S8	S9	S10	S11	S12	AUX S1	AUX S2	AUX S3	AUX S4	AUX S5	AUX S6
CMU CHANNEL NO.	1	2	13	3	4	14	5	6	15	7	8	16	9	10	17	11	12	18
PHASE	1	2	2 PED	3	4	4 PED	5	6	6 PED	7	8	8 PED	OLA	OLB	SPARE	OLC	OLD	SPARE
SIGNAL HEAD NO.	NU	NU	NU	NU	41,42	NU	51,52	NU	NU	NU	81,82	NU	NU	NU	NU	NU	NU	NU
RED					101						107							
YELLOW					102						108							
GREEN					103						109							
RED ARROW								131										
YELLOW ARROW								132										
FLASHING YELLOW ARROW																		
GREEN ARROW								133										

NU = Not Used

INPUT FILE POSITION LAYOUT

(front view)

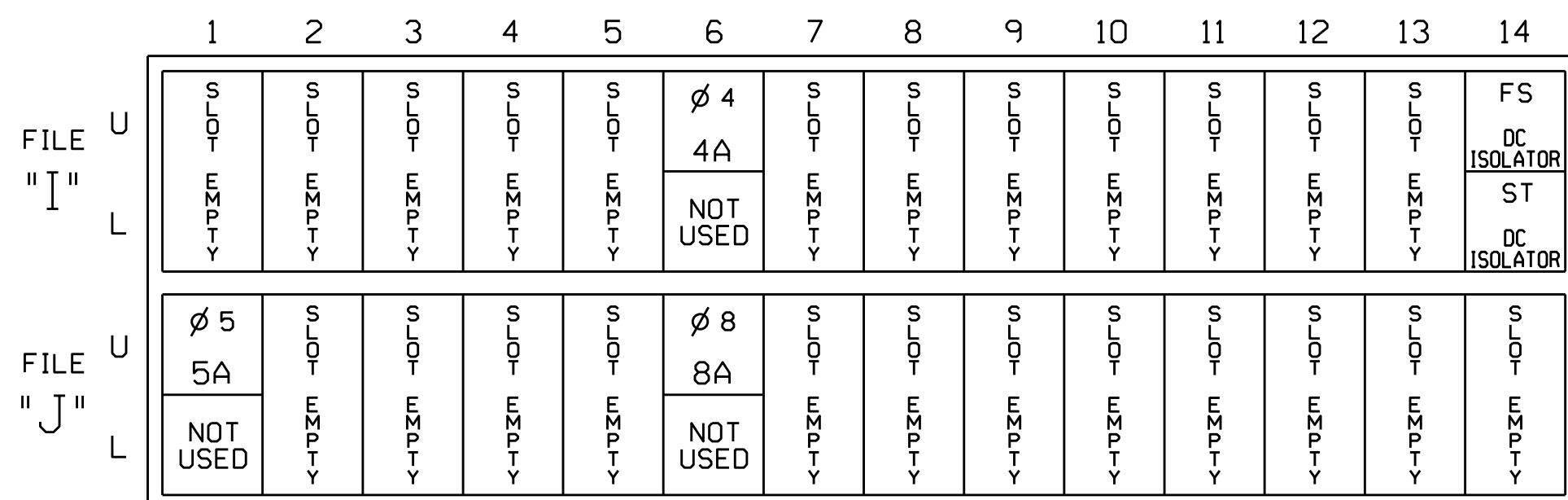

EX.: 1A, 2A, ETC. = LOOP NO.'S

FS = FLASH SENSE
 ST = STOP TIME

INPUT FILE CONNECTION & PROGRAMMING CHART

LOOP NO.	LOOP TERMINAL	INPUT FILE POS.	PIN NO.	INPUT ASSIGNMENT NO.	DETECTOR NO.	NEMA PHASE	CALL	EXTEND	FULL TIME DELAY	STRETCH TIME	DELAY TIME
4A	TB4-9,10	I6U	41	3	4	4	Y	Y			15
5A	TB3-1,2	J1U	55	17	5	5	Y	Y			3
8A	TB5-9,10	J6U	42	4	8	8	Y	Y			3

Remove jumper from I1-W to J4-W, on rear of input file.

INPUT FILE POSITION LEGEND: J2L

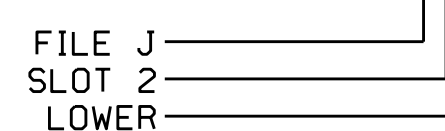

THIS ELECTRICAL DETAIL IS FOR THE SIGNAL DESIGN: 02-0828T
 DESIGNED: January 2019
 SEALED: 1/28/2019
 REVISED: N/A

LOAD RESISTOR INSTALLATION DETAIL

(install resistor as shown below)

ACCEPTABLE VALUES	
VALUE (ohms)	WATTAGE
1.5K - 1.9K	25W (min)
2.0K - 3.0K	10W (min)

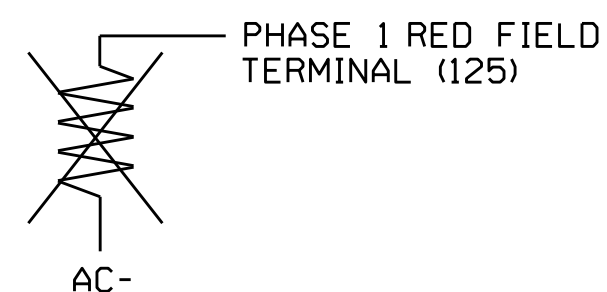

IMPORTANT! Remove resistor from Red field terminal as shown above.

Electrical Detail - Temporary

ELECTRICAL AND PROGRAMMING DETAILS FOR: Prepared In the Offices of: 750 N. Greenfield Pkwy, Garner, NC 27529	US 17 Business at SR 1165 (Sand Hole Road) / SR 1166 (Whichard's Beach Road)		SEAL Ryan W. Hough 1/29/2019
	Division 2 Beaufort County N of Chocowinity PLAN DATE: January 2019 PREPARED BY: S. Armstrong	REVIEWED BY: REVISIONS INIT. DATE	

EDI MODEL 2018ECL-NC CONFLICT MONITOR PROGRAMMING DETAIL

(remove jumpers and set switches as shown)

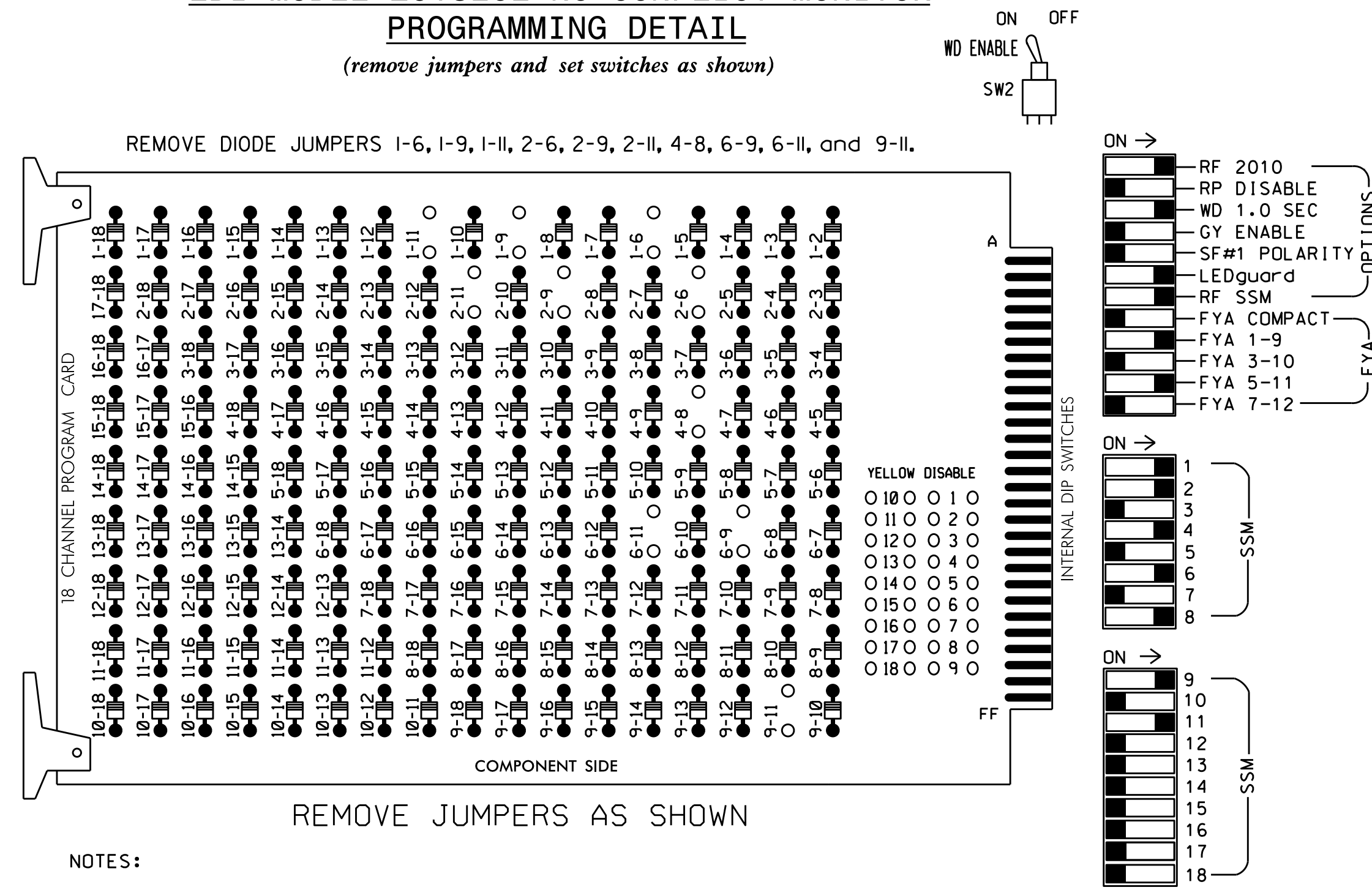

NOTES:

1. Card is provided with all diode jumpers in place. Removal of any jumper allows its channels to run concurrently.
2. Ensure jumpers SEL2-SEL5 and SEL9 are present on the monitor board.
3. Ensure that Red Enable is active at all times during normal operation.
4. Connect serial cable from conflict monitor to comm. port 1 of 2070 controller. Ensure conflict monitor communicates with 2070.

NOTES

1. To prevent "flash-conflict" problems, insert red flash program blocks for all unused vehicle load switches in the output file. The installer shall verify that signal heads flash in accordance with the Signal Plans.
2. Program phases 4 and 8 for Dual Entry.
3. Enable Simultaneous Gap-Out for all phases.
4. Program phases 2 and 6 for Variable Initial and Gap Reduction.
5. Program phases 2 and 6 for Start Up In Green.
6. Program phases 2 and 6 for Yellow Flash, and overlap 1 as Wag Overlaps.

EQUIPMENT INFORMATION

CONTROLLER.....2070
 CABINET.....332 W/ AUX
 SOFTWARE.....ECONOLITE OASIS
 CABINET MOUNT.....BASE
 OUTPUT FILE POSITIONS...18 WITH AUX. OUTPUT FILE
 LOAD SWITCHES USED.....S1,S2,S3*,S5,S8,S9*,S11,
 AUX S1,AUX S4
 PHASES USED.....1,2,4,6,8
 OVERLAP "A".....1+2
 OVERLAP "B".....NOT USED
 OVERLAP "C".....6
 OVERLAP "D".....NOT USED
 * Used for Advance Beacon only.

SIGNAL HEAD HOOK-UP CHART

LOAD SWITCH NO.	S1	S2	S3	S4	S5	S6	S7	S8	S9	S10	S11	S12	AUX S1	AUX S2	AUX S3	AUX S4	AUX S5	AUX S6
CMU CHANNEL NO.	1	2	13	3	4	14	5	6	15	7	8	16	9	10	17	11	12	18
PHASE	1	2	2 PED ADVANCE BEACON	3	4	4 PED	5	6	6 PED ADVANCE BEACON	7	8	8 PED	OLA	OLB	SPARE	OLC	OLD	SPARE
SIGNAL HEAD NO.	11	82	22,23	NU	63	NU	41,42	NU	61,62	NU	64	NU	81,82	NU	11	NU	21	NU
RED		*	128			101			134				107					
YELLOW			129			102			135				108					
GREEN			130			103			136				109					
RED ARROW													A121			A114		
YELLOW ARROW			126										A122			A115		
FLASHING YELLOW ARROW													A123			A116		
GREEN ARROW	127	127																
PED YELLOW						** 114			** 120									
			*						*									

NU = Not Used

- * Denotes install load resistor. See load resistor installation detail this sheet and sheet 3.
- ** Special advance beacons will be wired to S3-Y and S9-Y. See wiring and programming details on sheet 3 of this electrical detail.
- ★ See pictorial of head wiring in detail below.

INPUT FILE POSITION LAYOUT

(front view)

FILE "I"	1	2	3	4	5	6	7	8	9	10	11	12	13	14
U	∅ 1 1A	∅ 1 1B	∅ 2 2A	∅ 2 2C	-ORS	∅ 4 4A	-ORS	-ORS	-ORS	-ORS	-ORS	-ORS	-ORS	FS DC ISOLATOR ST
L	NOT USED	NOT USED	∅ 2 2B	NOT USED	←-ORS	NOT USED	←-ORS	←-ORS	←-ORS	←-ORS	←-ORS	←-ORS	←-ORS	DC ISOLATOR
U	-ORS	∅ 6 6A	-ORS	-ORS	-ORS	∅ 8 8A	-ORS	-ORS	-ORS	-ORS	-ORS	-ORS	-ORS	-ORS
L	←-ORS	∅ 6 6B	←-ORS	←-ORS	←-ORS	NOT USED	←-ORS	←-ORS	←-ORS	←-ORS	←-ORS	←-ORS	←-ORS	←-ORS

EX.: 1A, 2A, ETC. = LOOP NO.'S
 FS = FLASH SENSE
 ST = STOP TIME
 ⊗ Wired Input - Do not populate slot with detector card

INPUT FILE CONNECTION & PROGRAMMING CHART

LOOP NO.	LOOP TERMINAL	INPUT FILE POS.	PIN NO.	INPUT ASSIGNMENT NO.	DETECTOR NO.	NEMA PHASE	CALL	EXTEND	FULL TIME DELAY	STRETCH TIME	DELAY TIME
1A ¹	TB2-1,2	I1U	56	18	1	1	Y	Y			15
1B	TB2-5,6	I2U	39	1	2	1	Y	Y			15
2A	TB2-9,10	I3U	63	25	32	2	Y	Y			
2B	TB2-11,12	I3L	76	38	42	2	Y	Y			
2C	TB4-1,2	I4U	47	9	22	2	Y	Y	Y		3
4A	TB4-9,10	I6U	41	3	4	4	Y	Y			15
6A	TB3-5,6	J2U	40	2	6	6	Y	Y			
6B	TB3-7,8	J2L	44	6	16	6	Y	Y			
8A	TB5-9,10	J6U	42	4	8	8	Y	Y			3

¹Add jumper from I1-W to J4-W, on rear of input file.

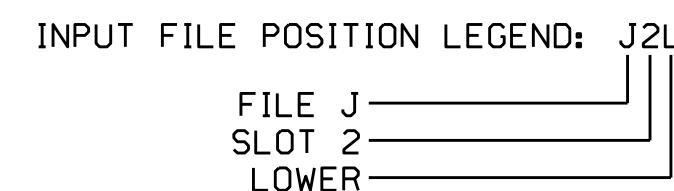

FYA SIGNAL WIRING DETAIL

(wire signal heads as shown)

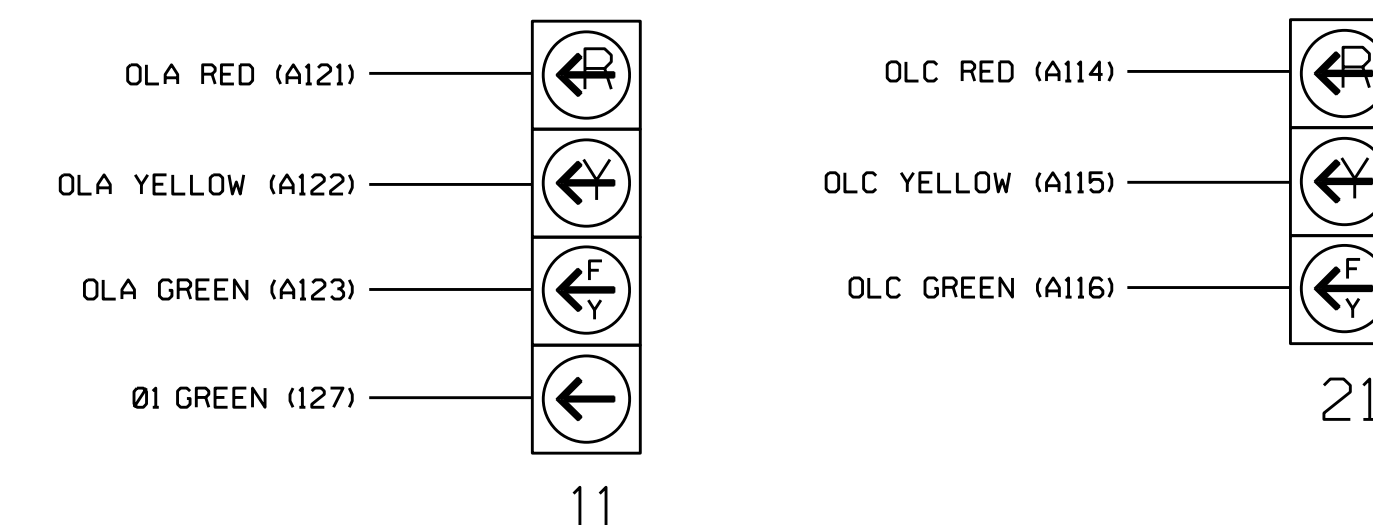

NOTE

The sequence display for signal head 11 requires special logic programming. See sheet 2 for programming instructions.

LOAD RESISTOR INSTALLATION DETAIL

(install resistor as shown below)

VALUE (ohms)	WATTAGE
1.5K - 1.9K	25W (min)
2.0K - 3.0K	10W (min)

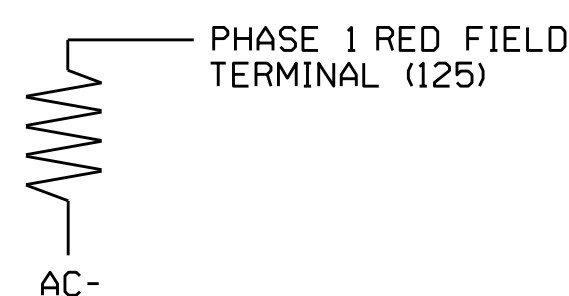

THIS ELECTRICAL DETAIL IS FOR THE SIGNAL DESIGN: 02-0828
 DESIGNED: February 2019
 SEALED: 2/27/2019
 REVISED: N/A

Electrical Detail - Final - Sheet 1 of 3

US 17 Business at SR 1165 (Sand Hole Road) / SR 1166 (Whichard's Beach Road)

Division 2 Beaufort County N of Chocowinity

Prepared by: S. Armstrong Reviewed by: Ryan W. Hough

REVISIONS: _____ INIT. DATE

Seal: Ryan W. Hough, Professional Engineer, License No. 036833, State of North Carolina

750 N. Greenfield Pkwy, Garner, NC 27529

SIG. INVENTORY NO. 02-0828

02-0828-2019 13-50
 S:\MITS\01\15\SIGNAL\work\hough\020828_sml.elec.xxx.dgn
 sarmstrong

**LOGICAL I/O PROCESSOR PROGRAMMING DETAIL
TO PRODUCE SPECIAL FYA-PPLT SIGNAL SEQUENCE**

(program controller as shown below)

- FROM MAIN MENU PRESS '2' (PHASE CONTROL), THEN '1' (PHASE CONTROL FUNCTIONS). SCROLL TO THE BOTTOM OF THE MENU AND ENABLE ACT LOGIC COMMANDS 1, 2, AND 3.
- FROM MAIN MENU PRESS '6' (OUTPUTS), THEN '3' (LOGICAL I/O PROCESSOR).

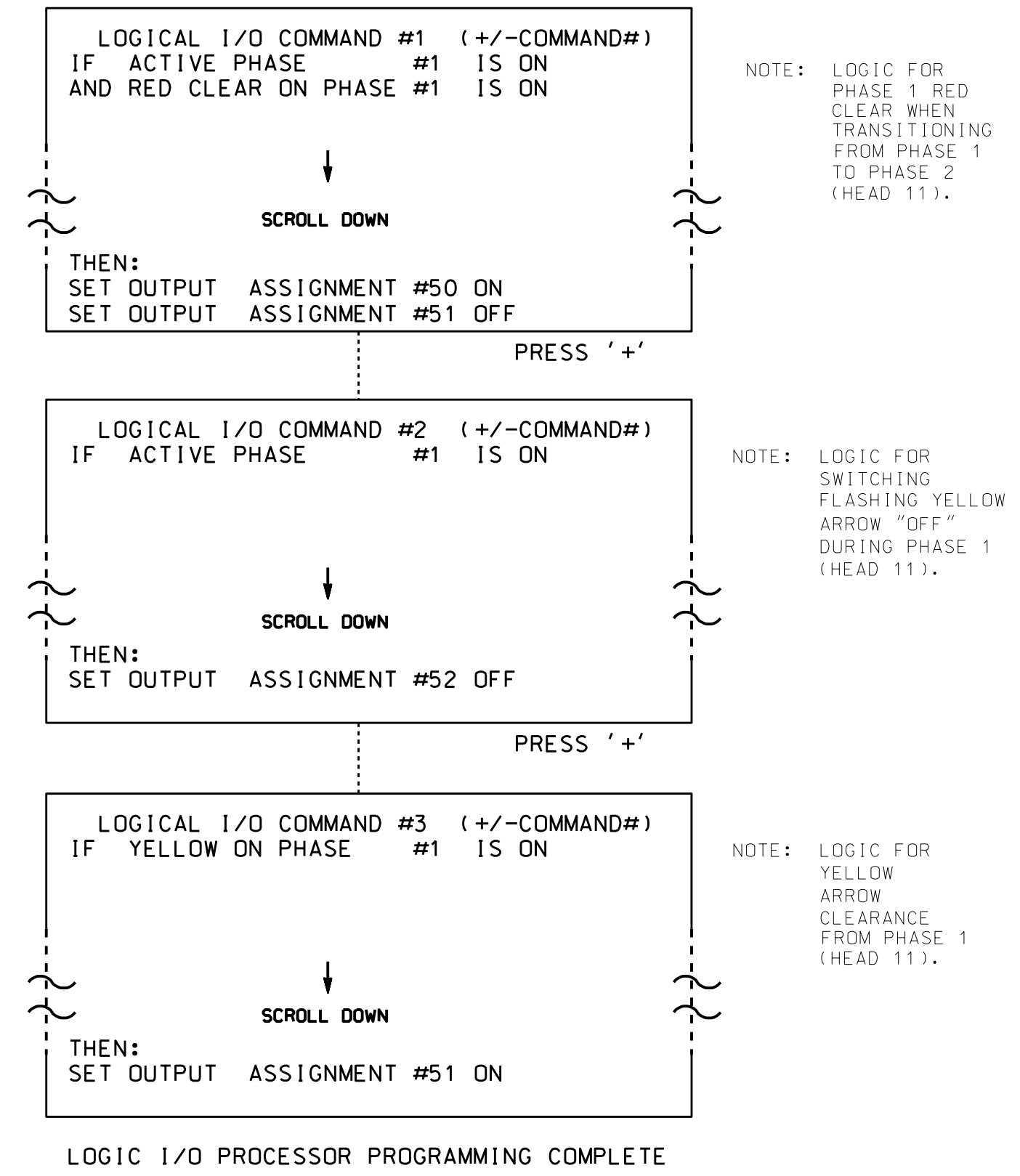

OUTPUT REFERENCE SCHEDULE

- OUTPUT 50 = Overlap A Red
- OUTPUT 51 = Overlap A Yellow
- OUTPUT 52 = Overlap A Green

OVERLAP PROGRAMMING DETAIL

(program controller as shown below)

FROM MAIN MENU PRESS '8' (OVERLAPS), THEN '1' (VEHICLE OVERLAP SETTINGS).

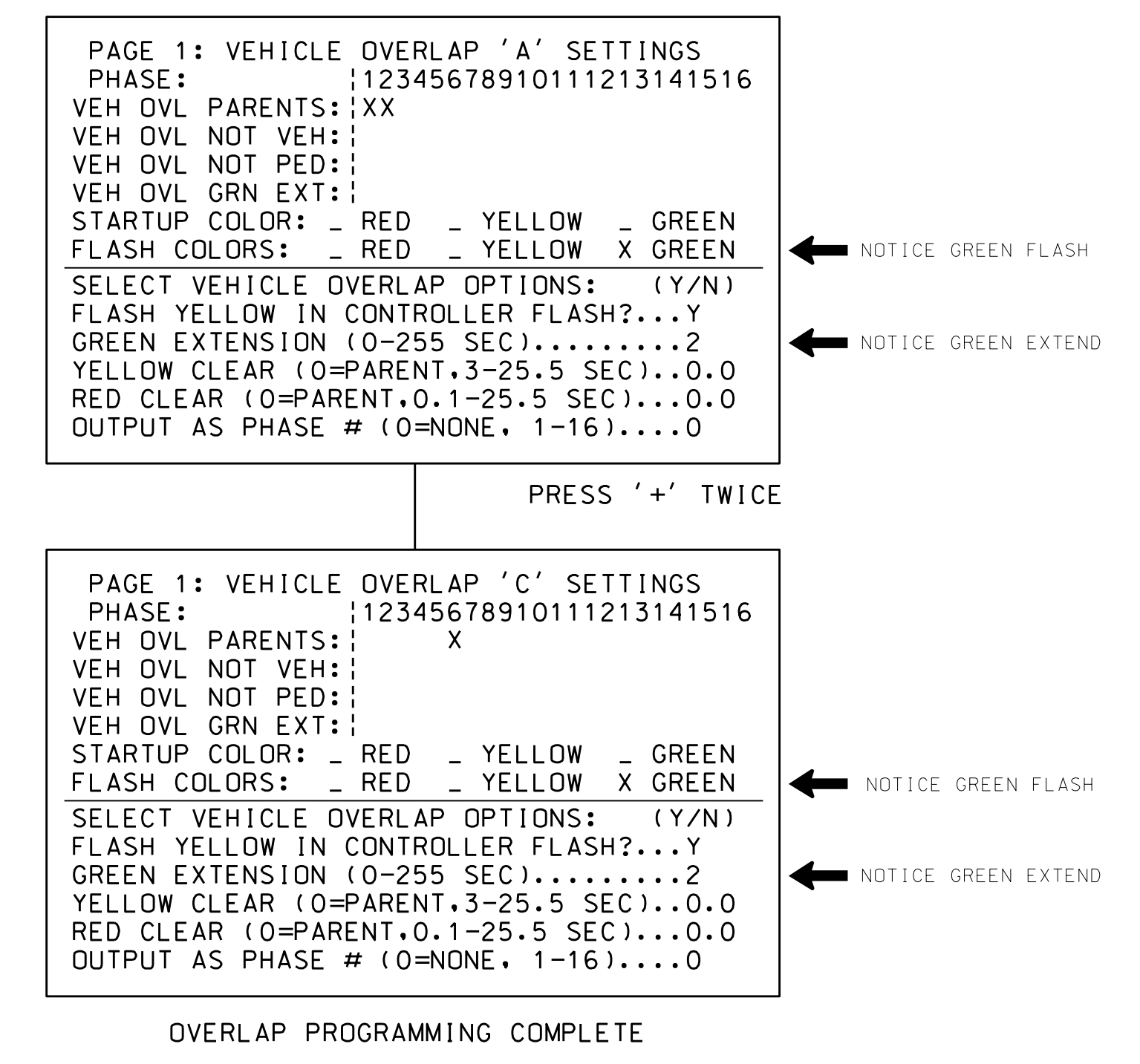

THIS ELECTRICAL DETAIL IS FOR
THE SIGNAL DESIGN: 02-0828
DESIGNED: February 2019
SEALED: 2/27/2019
REVISED: N/A

Electrical Detail - Final - Sheet 2 of 3

ELECTRICAL AND PROGRAMMING DETAILS FOR: Prepared In the Offices of: 750 N. Greenfield Pkwy, Garner, NC 27529	US 17 Business at SR 1165 (Sand Hole Road) / SR 1166 (Whichard's Beach Road)		SEAL SEAL 036833 ENGINEER RYAN W. HOUGH
	Division 2 Beaufort County N of Chocowinity	PLAN DATE: March 2019 PREPARED BY: S. Armstrong	
REVISIONS		INIT. DATE	DocuSigned by: 3/7/2019 DATE
SIG. INVENTORY NO. 02-0828			DOCUMENT NOT CONSIDERED FINAL UNLESS ALL SIGNATURES COMPLETED

05-1485-2019_12-45
*20190228:sm:et:vwk:cpm
s0r:msf:02g

ADVANCE BEACON #1 OUTPUT ASSIGNMENT PROGRAMMING DETAIL

(program controller as shown below)

FROM MAIN MENU PRESS '6' (OUTPUTS), THEN '1' (OUTPUT ASSIGNMENTS). PRESS '+' UNTIL OUTPUT #33 (PIN 35) IS REACHED.

```

PAGE:1 C1 PIN:35 NOT ENABLED
OUTPUT ASSIGNMENT #.....33
FREQUENCY (0=DEFAULT) (0-25.5 HZ)...1.0
DUTY CYCLE (0=DEFAULT) (0 - 100%)...50
MODE (0=SOLID,1=FLASH)...1
SELECT ASSIGNMENT:
NOT ENABLED.....Y
VEHICLE PHASE.....
PEDESTRIAN PHASE.....
VEHICLE OVERLAP.....
PEDESTRIAN OVERLAP.....
WATCHDOG.....
DETECTOR RESET.....
ADVANCE BEACON.....Y
OUT OF PHASE FLASHER.....
CONTROLLER FLASH.....
RUN FREE.....
RESERVED.....
PREEMPT.....
SOFT PREEMPT.....
ANY PREEMPT.....
COORDINATION PLAN.....
OFFSET.....
PHASE CHECK.....
PHASE ON.....
PHASE NEXT.....
    
```

THE FIRST THREE PROGRAMMING ROWS DEFINE THE OUTPUT TO FLASH, ALONG WITH THE RATE AT WHICH IT WILL FLASH.

THE NOT ENABLED 'Y' WILL REMAIN UNTIL THE FUNCTION OF THIS OUTPUT IS CHANGED. DO NOT ENTER AN 'N'.

```

PAGE:1 C1 PIN:35 NOT ENABLED
SELECT BEACON INDEX (1-4).....1
    
```

WHEN A 'Y' IS ENTERED FOR 'ADVANCE BEACON' THE SCREEN SHOWN ABOVE WILL APPEAR. ENTER DATA AS SHOWN.

PRESS THE 'ENT' KEY AFTER ENTERING DATA, THEN 'ESC'.

DISPLAY WILL NOW SHOW THE SPECIFIED OUTPUT ASSIGNED AS 'ADVANCE BEACON' AS SHOWN BELOW.

```

PAGE:1 C1 PIN:35 ADVANCE BEACON
OUTPUT ASSIGNMENT #.....33
FREQUENCY (0=DEFAULT) (0-25.5 HZ)...1.0
DUTY CYCLE (0=DEFAULT) (0 - 100%)...50
MODE (0=SOLID,1=FLASH)...1
SELECT ASSIGNMENT:
NOT ENABLED.....
VEHICLE PHASE.....
PEDESTRIAN PHASE.....
VEHICLE OVERLAP.....
PEDESTRIAN OVERLAP.....
WATCHDOG.....
DETECTOR RESET.....
ADVANCE BEACON.....Y
OUT OF PHASE FLASHER.....
CONTROLLER FLASH.....
RUN FREE.....
RESERVED.....
PREEMPT.....
SOFT PREEMPT.....
ANY PREEMPT.....
COORDINATION PLAN.....
OFFSET.....
PHASE CHECK.....
PHASE ON.....
PHASE NEXT.....
    
```

FROM MAIN MENU PRESS '6' (OUTPUTS), THEN '1' (OUTPUT ASSIGNMENTS). PRESS '+' UNTIL OUTPUT #34 (PIN 36) IS REACHED.

```

PAGE:1 C1 PIN:36 NOT ENABLED
OUTPUT ASSIGNMENT #.....34
FREQUENCY (0=DEFAULT) (0-25.5 HZ)...0.0
DUTY CYCLE (0=DEFAULT) (0 - 100%)...0
MODE (0=SOLID,1=FLASH)...0
SELECT ASSIGNMENT:
NOT ENABLED.....Y
VEHICLE PHASE.....
PEDESTRIAN PHASE.....
VEHICLE OVERLAP.....
PEDESTRIAN OVERLAP.....
WATCHDOG.....
DETECTOR RESET.....
ADVANCE BEACON.....
OUT OF PHASE FLASHER.....Y
CONTROLLER FLASH.....
RUN FREE.....
RESERVED.....
PREEMPT.....
SOFT PREEMPT.....
ANY PREEMPT.....
COORDINATION PLAN.....
OFFSET.....
PHASE CHECK.....
PHASE ON.....
PHASE NEXT.....
    
```

THE NOT ENABLED 'Y' WILL REMAIN UNTIL THE FUNCTION OF THIS OUTPUT IS CHANGED. DO NOT ENTER AN 'N'.

```

PAGE:1 C1 PIN:36 NOT ENABLED
SELECT OUTPUT ASSIGNMENT (1-64).....33
    
```

WHEN A 'Y' IS ENTERED FOR 'OUT OF PHASE FLASHER' THE SCREEN SHOWN ABOVE WILL APPEAR. ENTER DATA AS SHOWN.

PRESS THE 'ENT' KEY AFTER ENTERING DATA, THEN 'ESC'.

DISPLAY WILL NOW SHOW THE SPECIFIED OUTPUT ASSIGNED AS 'OUT OF PHASE FLASHER' AS SHOWN BELOW.

```

PAGE:1 C1 PIN:36 OUT OF PHASE FLASHER
OUTPUT ASSIGNMENT #.....34
FREQUENCY (0=DEFAULT) (0-25.5 HZ)...0.0
DUTY CYCLE (0=DEFAULT) (0 - 100%)...0
MODE (0=SOLID,1=FLASH)...0
SELECT ASSIGNMENT:
NOT ENABLED.....
VEHICLE PHASE.....
PEDESTRIAN PHASE.....
VEHICLE OVERLAP.....
PEDESTRIAN OVERLAP.....
WATCHDOG.....
DETECTOR RESET.....
ADVANCE BEACON.....
OUT OF PHASE FLASHER.....Y
CONTROLLER FLASH.....
RUN FREE.....
RESERVED.....
PREEMPT.....
SOFT PREEMPT.....
ANY PREEMPT.....
COORDINATION PLAN.....
OFFSET.....
PHASE CHECK.....
PHASE ON.....
PHASE NEXT.....
    
```

OUTPUT REFERENCE SCHEDULE

OUTPUT 33 = Ø 2 Ped Yellow
OUTPUT 34 = Ø 6 Ped Yellow

ADVANCE BEACON #1 WIRING DETAIL (wire flashers as shown below)

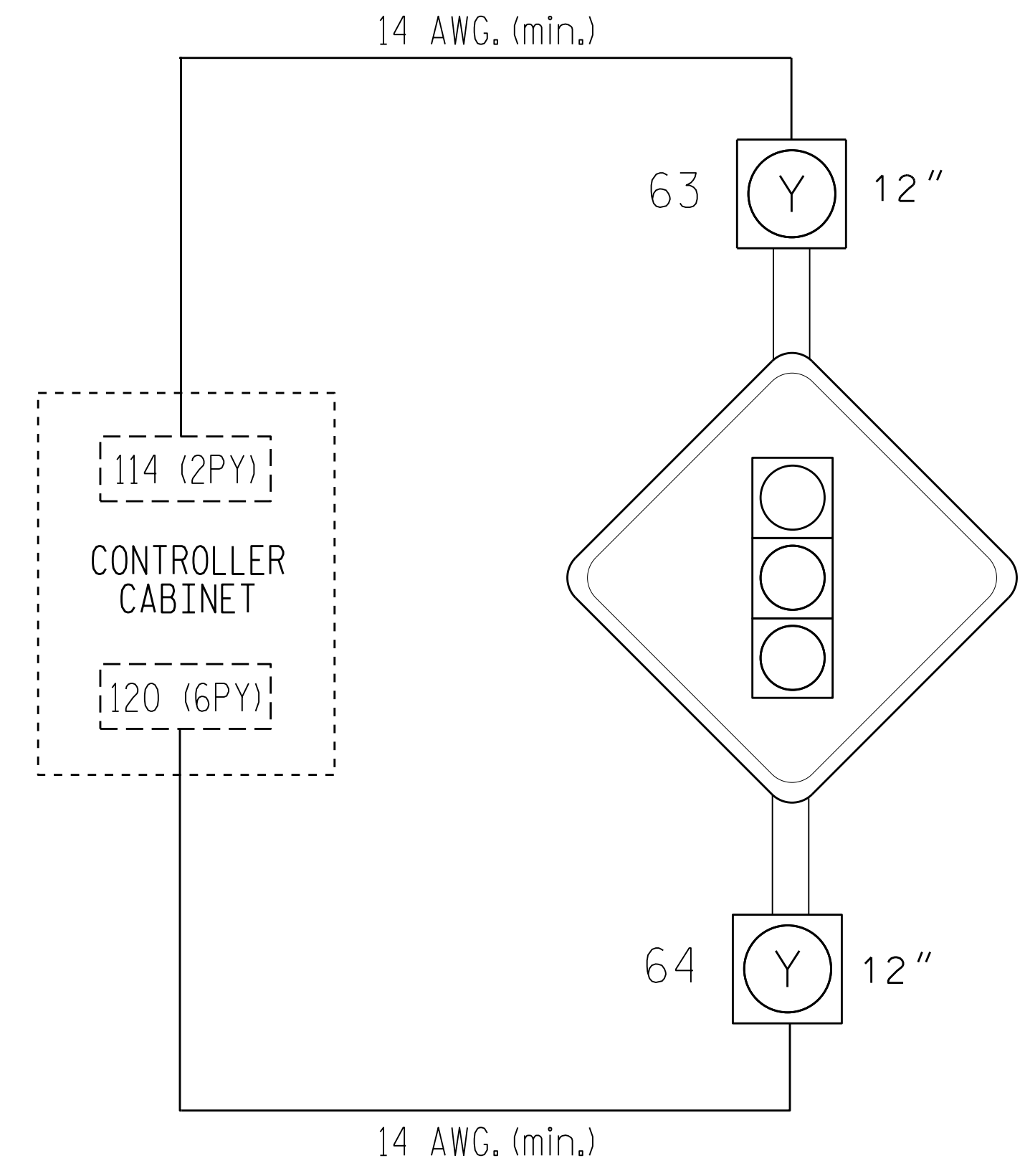

IMPORTANT

- REMOVE, TAPE AND LABEL CONFLICT MONITOR WIRE ATTACHED TO THE REAR OF TERMINAL 114 (2PY) AND TERMINAL 120 (6PY).
- INSERT LOAD SWITCH FOR S3 AND S9.
- MAKE SURE LOAD RESISTORS ARE IN PLACE AS SHOWN IN LOAD RESISTOR INSTALLATION DETAIL ON THIS SHEET.
- TO ACTIVATE SIGN OPERATION AS INDICATED ON THE SIGNAL PLANS, REASSIGN OUTPUT 33 AND 34 AS SHOWN ON THIS SHEET.

LOAD RESISTOR INSTALLATION DETAIL

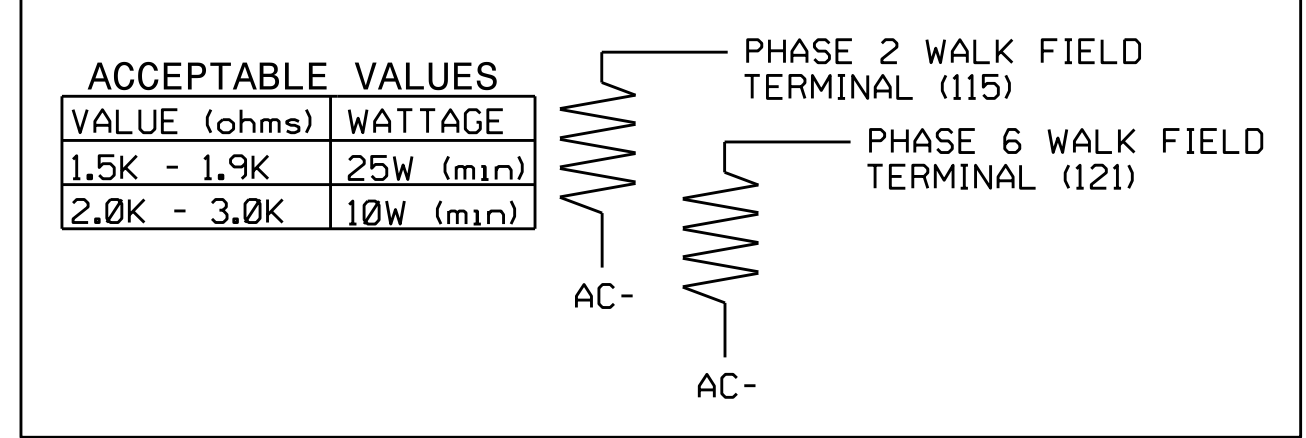

ADVANCE BEACON PROGRAMMING DETAIL (program controller as shown below)

- FROM MAIN MENU PRESS '6' (OUTPUTS), THEN '2' (OUTPUT BEACON SETTINGS).

```

OUTPUT BEACON SETTINGS
TRIGGER PHASES: 12345678910111213141516
BEACON #1 OFF X
BEACON #2 OFF
BEACON #3 OFF
BEACON #4 OFF
    
```

	BEACON	1	2	3	4
OFF DELAY TIME (0-255);	0	0	0	0	0
ON DELAY TIME (0-255);	0	0	0	0	0
STOP-TIME HOLD (0-255);	2	0	0	0	0

SCROLL DOWN TO VIEW ALL DATA

NOTICE STOP TIME HOLD

ADVANCE BEACON PROGRAMMING COMPLETE

NOTE: AN OUTPUT HAS TO BE ASSIGNED AS AN ADVANCE BEACON IN ORDER FOR PROPER OPERATION TO OCCUR. SEE OUTPUT ASSIGNMENT DETAIL ON THIS SHEET.

THIS ELECTRICAL DETAIL IS FOR THE SIGNAL DESIGN: 02-0828
DESIGNED: February 2019
SEALED: 2/27/2019
REVISED: N/A

Electrical Detail - Final - Sheet 3 of 3

Prepared In the Offices of:

 750 N. Greenfield Pkwy, Garner, NC 27529

US 17 Business at SR 1165 (Sand Hole Road) / SR 1166 (Whichard's Beach Road)
 Beaufort County N of Chocowinity

PLAN DATE: March 2019 REVIEWED BY:
 PREPARED BY: S. Armstrong REVIEWED BY:

REVISIONS INIT. DATE

DOCUMENT NOT CONSIDERED FINAL UNLESS ALL SIGNATURES COMPLETED

SEAL
 NORTH CAROLINA PROFESSIONAL ENGINEER
 SEAL 036833
 RYAN W. HOUGH
 3/7/2019
 DATE

SIG. INVENTORY NO. 02-0828

05-0485-2019 12x16
 2/20/2019 lam etl etl-wmk.dgm
 3/20/2019

PHASING DIAGRAM

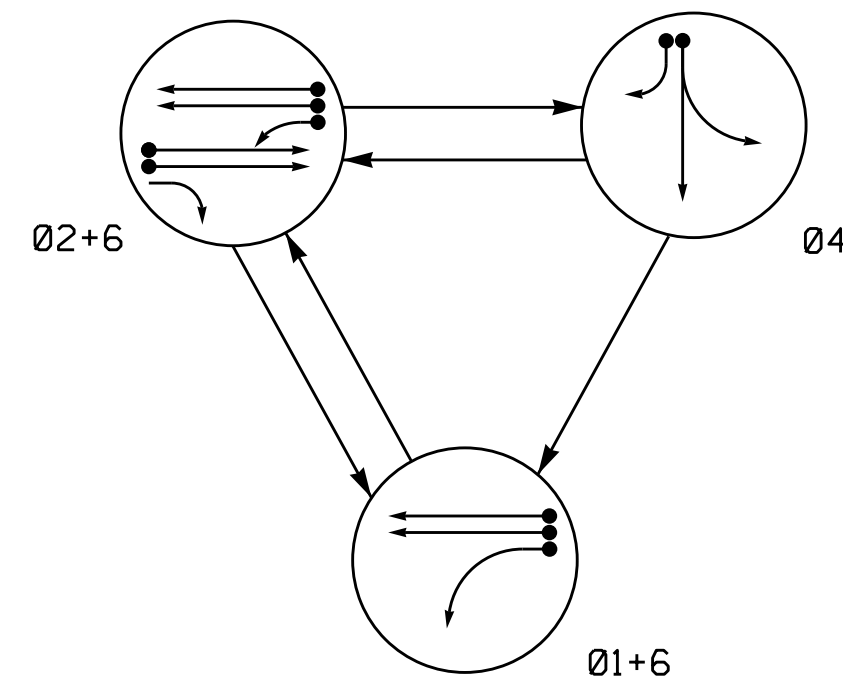

SIGNAL FACE	PHASE			
	01+6	02+6	04	F L S H A B
11	Y	R	Y	Y
21, 22	R	G	R	Y
41, 42, 43	R	R	G	R
61, 62	G	G	R	Y

OASIS 2070 LOOP & DETECTOR INSTALLATION CHART												
LOOP	SIZE (FT)	DISTANCE FROM STOPBAR (FT)	TURNS	NEW LOOP	DETECTOR PROGRAMMING						SYSTEM LOOP	NEW CARD
					PHASE	CALLING	EXTENSION	FULL TIME DELAY	STRETCH TIME	DELAY TIME		
1A	6X40	0	2-4-2	Y	1	Y	Y	-	-	15	-	Y
					6	Y	Y	Y	-	3	-	Y
2A	6X6	355	5	Y	2	Y	Y	-	-	-	-	Y
2B	6X6	355	5	Y	2	Y	Y	-	-	-	-	Y
4A	6X40	0	2-4-2	Y	4	Y	Y	-	-	-	-	Y
4B	6X40	0	2-4-2	Y	4	Y	Y	-	-	15	-	Y
6A	6X6	355	5	Y	6	Y	Y	-	-	-	-	Y
6B	6X6	355	5	Y	6	Y	Y	-	-	-	-	Y

3 Phase Fully Actuated Isolated

NOTES

1. Refer to "Roadway Standard Drawings NCDOT" dated January 2018 and "Standard Specifications for Roads and Structures" dated January 2018.
2. Do not program signal for late night flashing operation unless otherwise directed by the Engineer.
3. Phase 1 and/or phase 5 may be lagged.
4. Set all detector units to presence mode.
5. Locate new cabinet so as not to obstruct sight distance of vehicles turning right on red.

PHASING DIAGRAM DETECTION LEGEND

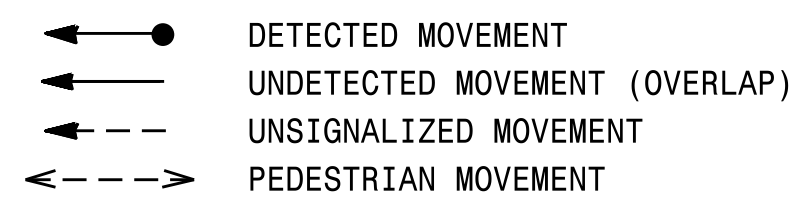

SIGNAL FACE I.D.

All Heads L.E.D.

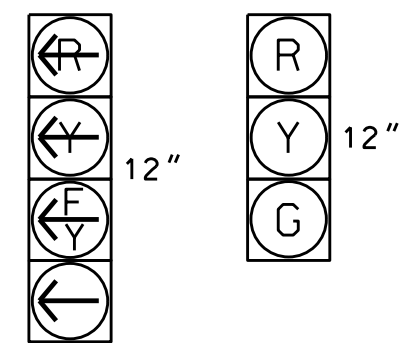

11 21, 22
41, 42, 43
61, 62

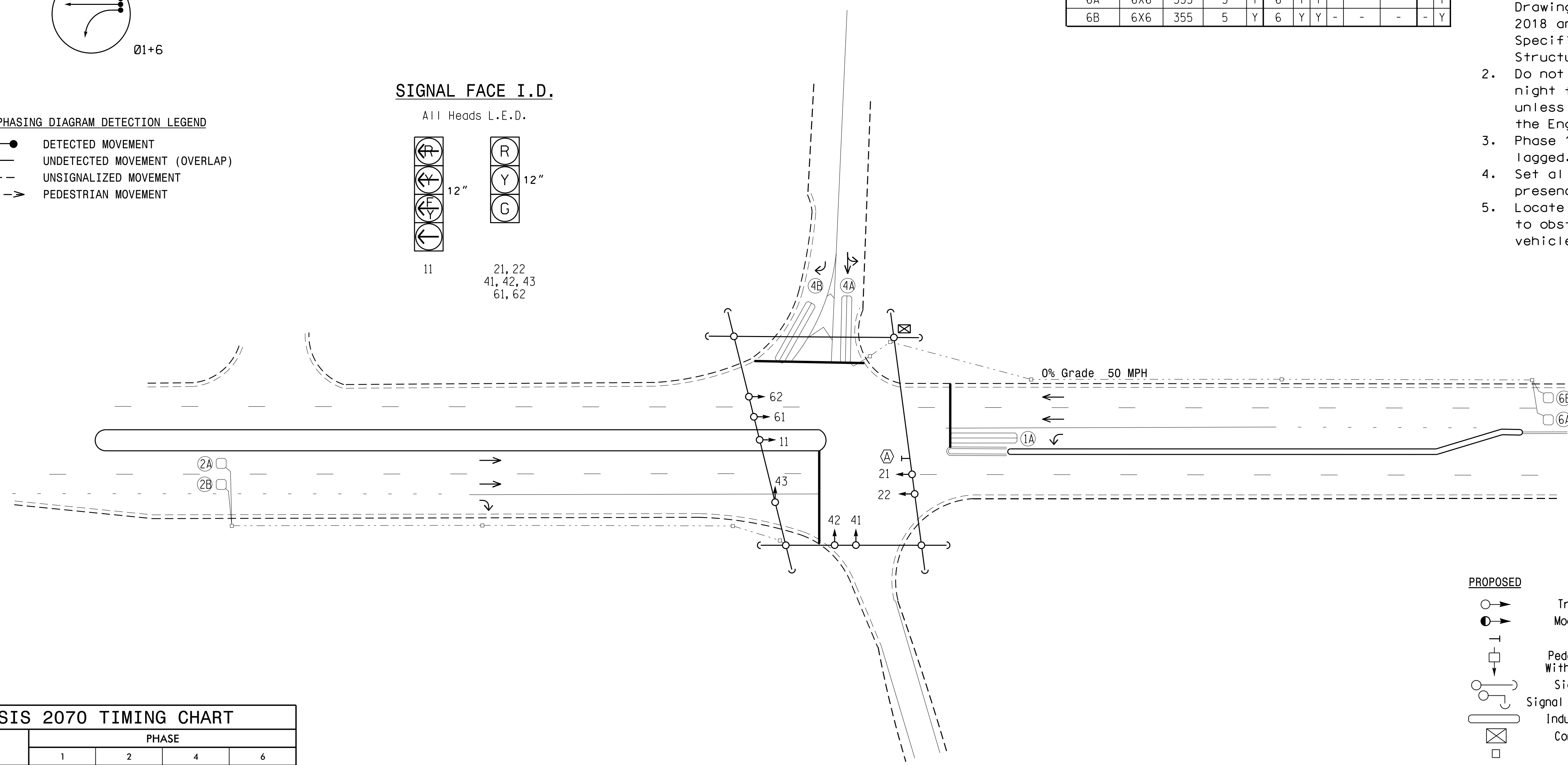

OASIS 2070 TIMING CHART				
FEATURE	PHASE			
	1	2	4	6
Min Green 1 *	7	14	7	14
Extension 1 *	2.0	6.0	2.0	6.0
Max Green 1 *	20	90	30	90
Yellow Clearance	3.0	4.8	3.0	4.8
Red Clearance	2.3	1.0	2.3	1.7
Red Revert	2.0	2.0	2.0	2.0
Walk 1 *	-	-	-	-
Don't Walk 1	-	-	-	-
Seconds Per Actuation *	-	1.5	-	1.5
Max Variable Initial *	-	40	-	40
Time Before Reduction *	-	15	-	15
Time To Reduce *	-	30	-	30
Minimum Gap	-	3.0	-	3.0
Recall Mode	-	MIN RECALL	-	MIN RECALL
Vehicle Call Memory	-	YELLOW	-	YELLOW
Dual Entry	-	-	-	-
Simultaneous Gap	ON	ON	ON	ON

* These values may be field adjusted. Do not adjust Min Green and Extension times for phases 2 and 6 lower than what is shown. Min Green for all other phases should not be lower than 4 seconds.

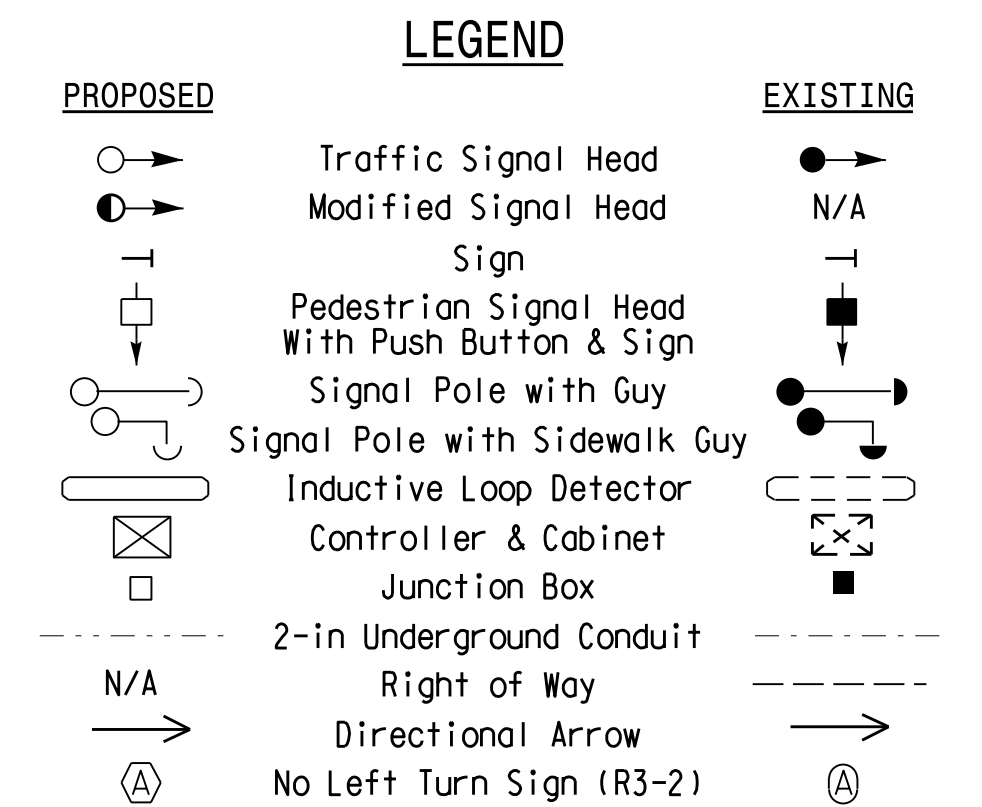

New Installation- Temporary Signal

Prepared in the Offices of:

750 N. Greenfield Pkwy, Garner, NC 27529

US 264 (Pactolus Hwy)
at
US 17 Byp Southbound Ramps

Division 2 Beaufort County Washington

PLAN DATE: January 2019 REVIEWED BY: ZML

PREPARED BY: MEL REVIEWED BY:

DOCUMENT NOT CONSIDERED FINAL UNLESS ALL SIGNATURES COMPLETED

DocuSigned by:
Megan E. LeBlanc
1/28/2019
DATE

SIG. INVENTORY NO. 02-0917T

PROGRAMMING DETAIL

(remove jumpers and set switches as shown)

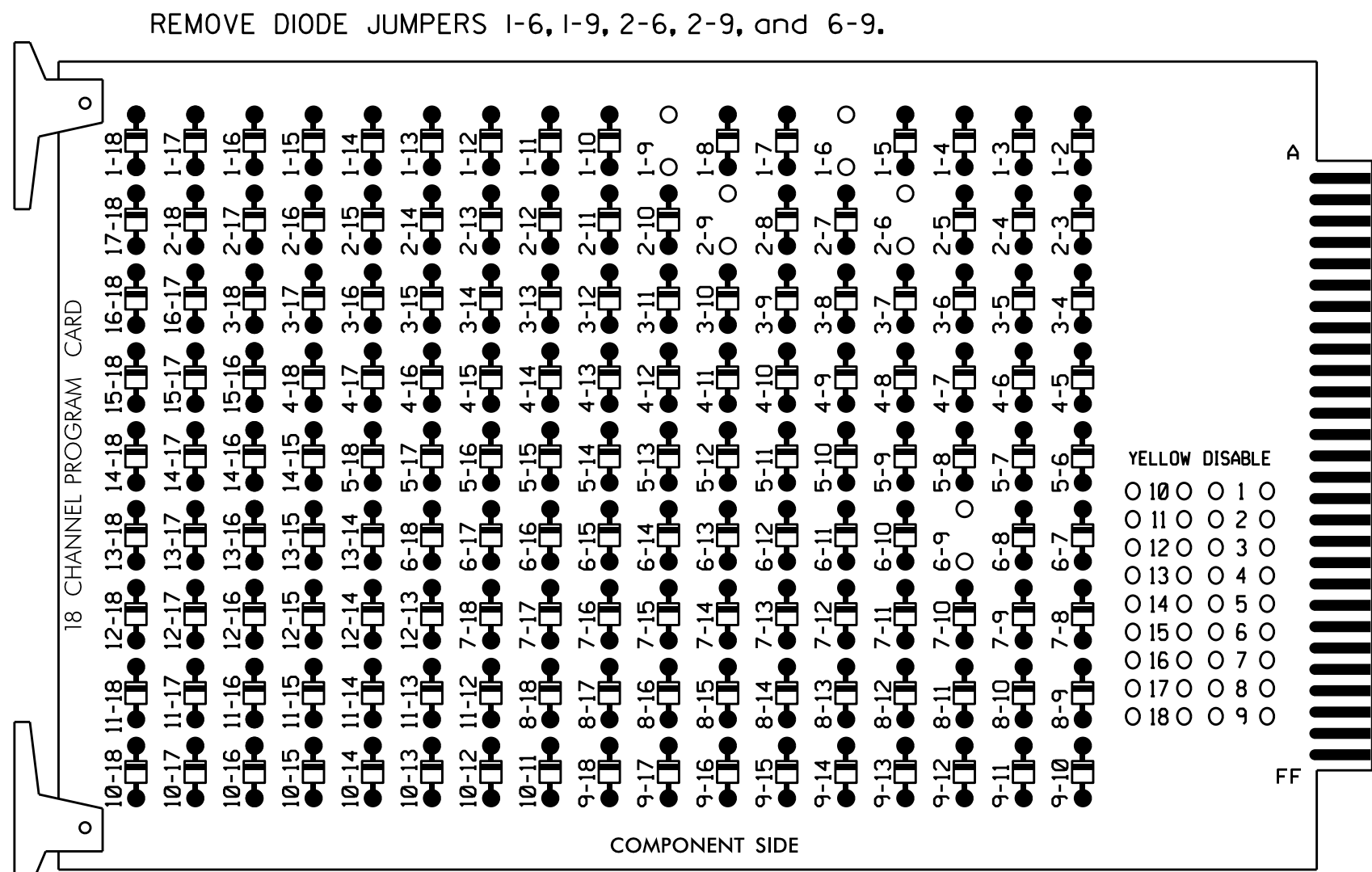

NOTES:

1. Card is provided with all diode jumpers in place. Removal of any jumper allows its channels to run concurrently.
2. Ensure jumpers SEL2-SEL5 and SEL9 are present on the monitor board.
3. Ensure that Red Enable is active at all times during normal operation.
4. Connect serial cable from conflict monitor to comm. port 1 of 2070 controller. Ensure conflict monitor communicates with 2070.

■ = DENOTES POSITION OF SWITCH

NOTES

1. To prevent "flash-conflict" problems, insert red flash program blocks for all unused vehicle load switches in the output file. The installer shall verify that signal heads flash in accordance with the Signal Plans.
2. Enable Simultaneous Gap-Out for all Phases.
3. Program phases 2 and 6 for Variable Initial and Gap Reduction.
4. Program phases 2 and 6 for Startup In Green.
5. Program phases 2 and 6 for Yellow Flash, and overlap 1 as Wag Overlaps.

EQUIPMENT INFORMATION

CONTROLLER.....2070
 CABINET.....332 W/ AUX
 SOFTWARE.....ECONOLITE OASIS
 CABINET MOUNT.....BASE
 OUTPUT FILE POSITIONS...18 WITH AUX. OUTPUT FILE
 LOAD SWITCHES USED.....S1,S2,S5,S8,AUX S1
 PHASES USED.....1,2,4,6
 OVERLAP "A".....1+2
 OVERLAP "B".....NOT USED
 OVERLAP "C".....NOT USED
 OVERLAP "D".....NOT USED

SIGNAL HEAD HOOK-UP CHART

LOAD SWITCH NO.	S1	S2	S3	S4	S5	S6	S7	S8	S9	S10	S11	S12	AUX S1	AUX S2	AUX S3	AUX S4	AUX S5	AUX S6
CMU CHANNEL NO.	1	2	13	3	4	14	5	6	15	7	8	16	9	10	17	11	12	18
PHASE	1	2	2 PED	3	4	4 PED	5	6	6 PED	7	8	8 PED	OLA	OLB	SPARE	OLC	OLD	SPARE
SIGNAL HEAD NO.	11	21,22	NU	NU	41,42 43	NU	NU	61,62	NU	NU	NU	NU	11	NU	NU	NU	NU	NU
RED		128			101			134										
YELLOW	*	129			102			135										
GREEN		130			103			136										
RED ARROW													A121					
YELLOW ARROW													A122					
FLASHING YELLOW ARROW													A123					
GREEN ARROW	127																	

NU = Not Used

* Denotes install load resistor. See load resistor installation detail this sheet.

★ See pictorial of head wiring in detail this sheet.

INPUT FILE POSITION LAYOUT

(front view)

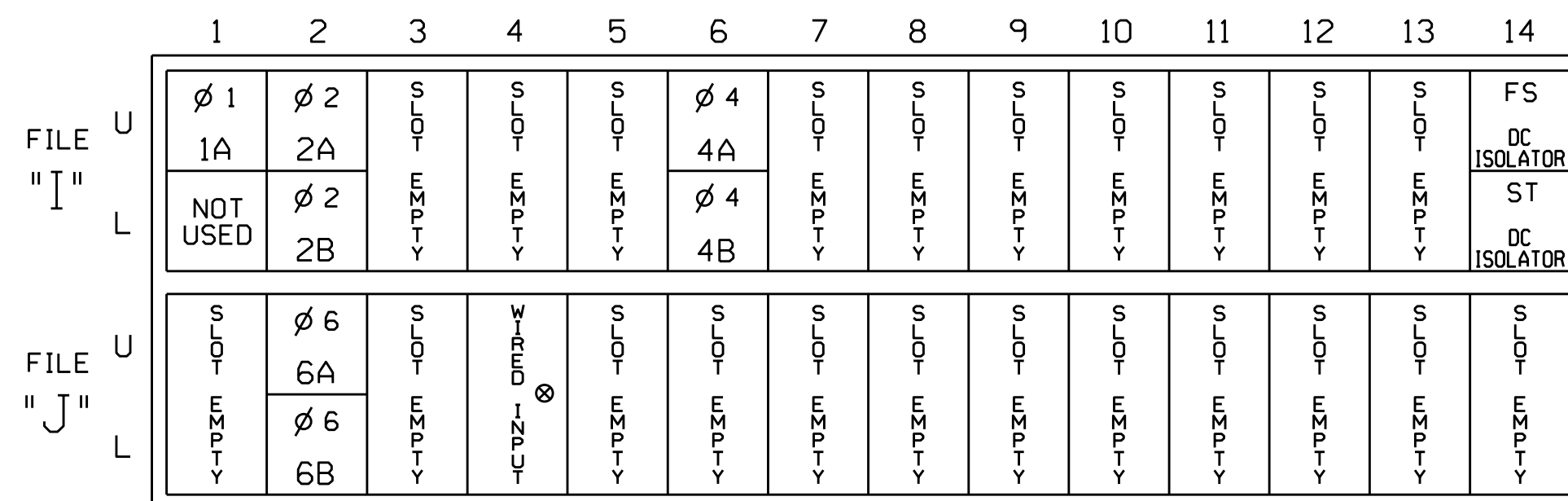

EX.: 1A, 2A, ETC. = LOOP NO.'S

FS = FLASH SENSE
 ST = STOP TIME

⊗ Wired Input - Do not populate slot with detector card

INPUT FILE CONNECTION & PROGRAMMING CHART

LOOP NO.	LOOP TERMINAL	INPUT FILE POS.	PIN NO.	INPUT ASSIGNMENT NO.	DETECTOR NO.	NEMA PHASE	CALL	EXTEND	FULL TIME DELAY	STRETCH TIME	DELAY TIME
1A ¹	TB2-1,2	I1U	56	18	1	1	Y	Y			15
	-	J4U	48	10	26	6	Y	Y	Y		3
2A	TB2-5,6	I2U	39	1	2	2	Y	Y			
2B	TB2-7,8	I2L	43	5	12	2	Y	Y			
4A	TB4-9,10	I6U	41	3	4	4	Y	Y			
4B	TB4-11,12	I6L	45	7	14	4	Y	Y			15
6A	TB3-5,6	J2U	40	2	6	6	Y	Y			
6B	TB3-7,8	J2L	44	6	16	6	Y	Y			

¹Add jumper from I1-W to J4-W, on rear of input file.

INPUT FILE POSITION LEGEND: J2L

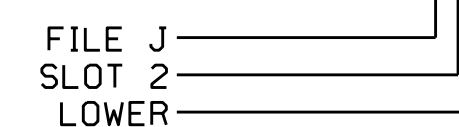

FYA SIGNAL WIRING DETAIL

(wire signal head as shown)

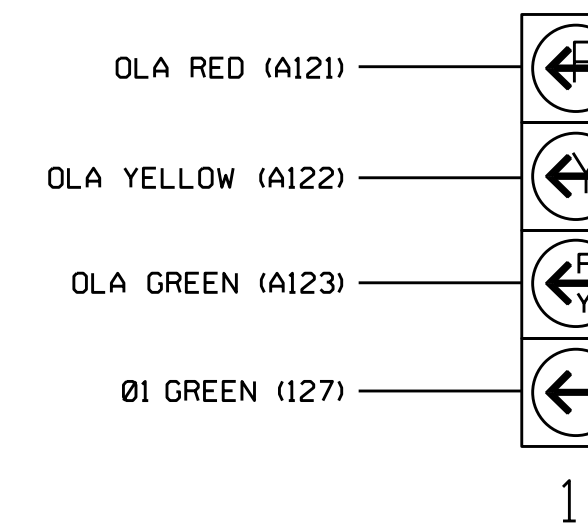

NOTE

The sequence display for signal head 11 requires special logic programming. See sheet 2 for programming instructions.

THIS ELECTRICAL DETAIL IS FOR THE SIGNAL DESIGN: 02-0917T
 DESIGNED: January 2019
 SEALED: 1/28/2019
 REVISED: N/A

LOAD RESISTOR INSTALLATION DETAIL

(install resistor as shown below)

ACCEPTABLE VALUES	
VALUE (ohms)	WATTAGE
1.5K - 1.9K	25W (min)
2.0K - 3.0K	10W (min)

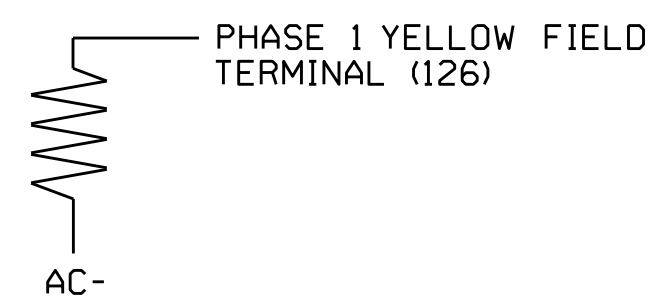

Electrical Detail - Temporary - Sheet 1 of 2

Prepared In the Offices of:
 TRANSPORTATION MOBILITY AND SAFETY DIVISION
 NORTH CAROLINA DEPARTMENT OF TRANSPORTATION
 750 N. Greenfield Pkwy, Garner, NC 27529

US 264 (Pactolus Hwy) at US 17 Byp Southbound Ramps

Division 2 Beaufort County Washington

PLAN DATE: January 2019 REVIEWED BY:

PREPARED BY: S. Armstrong REVIEWED BY:

REVISIONS INIT. DATE

DocuSigned by: Ryan W. Hough 1/29/2019

DOCUMENT NOT CONSIDERED FINAL UNLESS ALL SIGNATURES COMPLETED

SEAL
 NORTH CAROLINA DEPARTMENT OF TRANSPORTATION
 PROFESSIONAL ENGINEER
 SEAL 036833
 RYAN W. HOUGH

SIG. INVENTORY NO. 02-0917T

**LOGICAL I/O PROCESSOR PROGRAMMING DETAIL
TO PRODUCE SPECIAL FYA-PPLT SIGNAL SEQUENCE**

(program controller as shown below)

- FROM MAIN MENU PRESS '2' (PHASE CONTROL), THEN '1' (PHASE CONTROL FUNCTIONS). SCROLL TO THE BOTTOM OF THE MENU AND ENABLE ACT LOGIC COMMANDS 1, 2, AND 3.
- FROM MAIN MENU PRESS '6' (OUTPUTS), THEN '3' (LOGICAL I/O PROCESSOR).

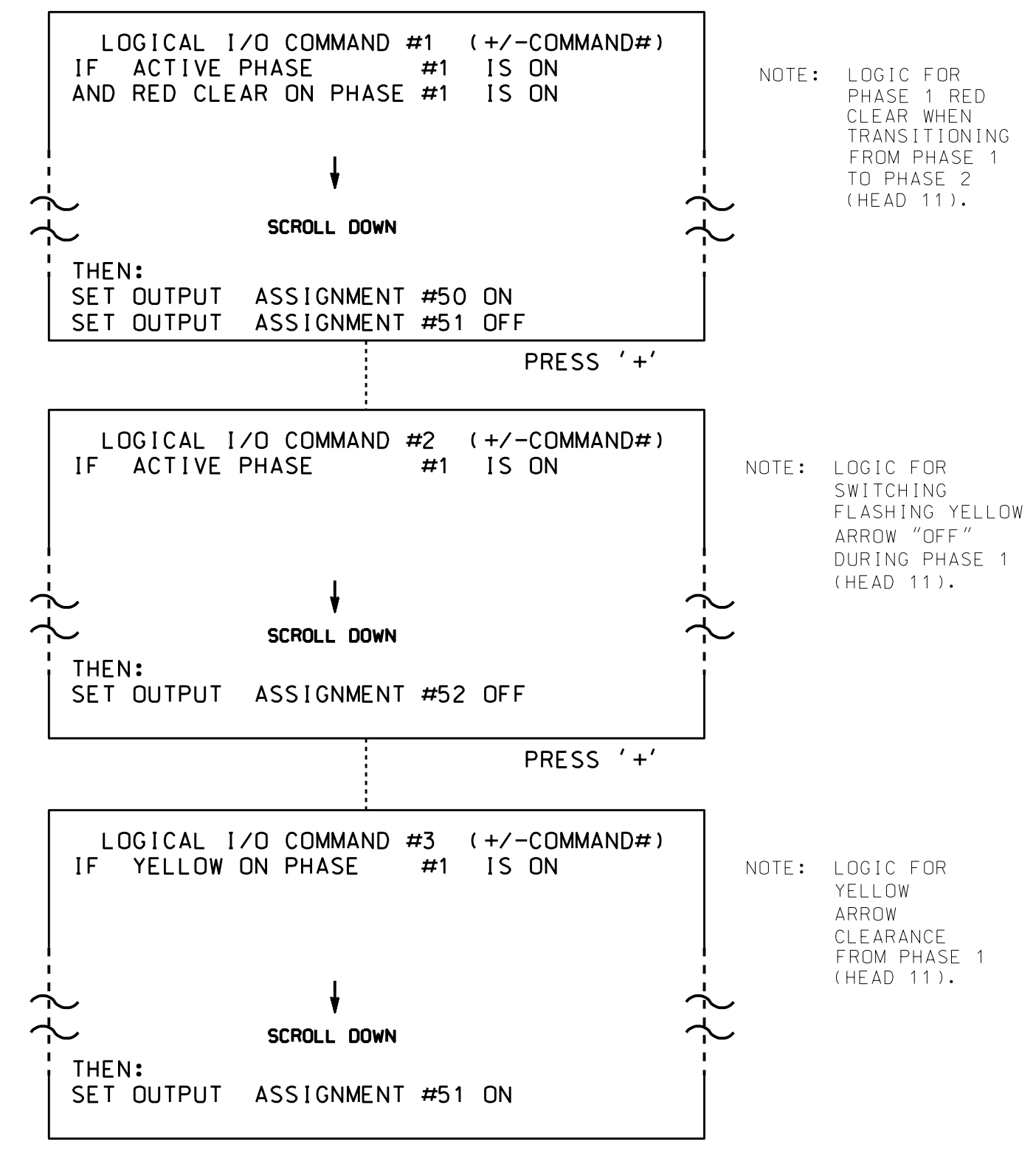

LOGIC I/O PROCESSOR PROGRAMMING COMPLETE

OUTPUT REFERENCE SCHEDULE	
OUTPUT 50	= Overlap A Red
OUTPUT 51	= Overlap A Yellow
OUTPUT 52	= Overlap A Green

OVERLAP PROGRAMMING DETAIL

(program controller as shown below)

FROM MAIN MENU PRESS '8' (OVERLAPS), THEN '1' (VEHICLE OVERLAP SETTINGS).

```

PAGE 1: VEHICLE OVERLAP 'A' SETTINGS
PHASE:      12345678910111213141516
VEH OVL PARENTS: XX
VEH OVL NOT VEH:
VEH OVL NOT PED:
VEH OVL GRN EXT:
STARTUP COLOR: - RED - YELLOW - GREEN
FLASH COLORS:  - RED - YELLOW X GREEN
SELECT VEHICLE OVERLAP OPTIONS: (Y/N)
FLASH YELLOW IN CONTROLLER FLASH?...Y
GREEN EXTENSION (0-255 SEC).....0
YELLOW CLEAR (0=PARENT,3-25.5 SEC)..0.0
RED CLEAR (0=PARENT,0.1-25.5 SEC)..0.0
OUTPUT AS PHASE # (0=NONE, 1-16)....0
    
```

← NOTICE GREEN FLASH

OVERLAP PROGRAMMING COMPLETE

THIS ELECTRICAL DETAIL IS FOR
THE SIGNAL DESIGN: 02-0917T
DESIGNED: January 2019
SEALED: 1/28/2019
REVISED: N/A

20-1116-2019 09:38
1/20/2019 1:00:00 PM
sarmstr.dgn

Electrical Detail - Temporary - Sheet 2 of 2		DOCUMENT NOT CONSIDERED FINAL UNLESS ALL SIGNATURES COMPLETED	
ELECTRICAL AND PROGRAMMING DETAILS FOR: Prepared In the Offices of: 750 N. Greenfield Pkwy, Garner, NC 27529		US 264 (Pactolus Hwy) at US 17 Byp Southbound Ramps	
Division 2 PLAN DATE: January 2019 PREPARED BY: S. Armstrong	Beaufort County REVIEWED BY: REVIEWED BY:	Washington SEAL NORTH CAROLINA PROFESSIONAL ENGINEER SEAL 036833 RYAN W. HOUGH	
REVISIONS INIT. DATE	REVISIONS INIT. DATE	DocuSigned by: Ryan W. Hough 1/29/2019 DATE	
SIG. INVENTORY NO. 02-0917T			