

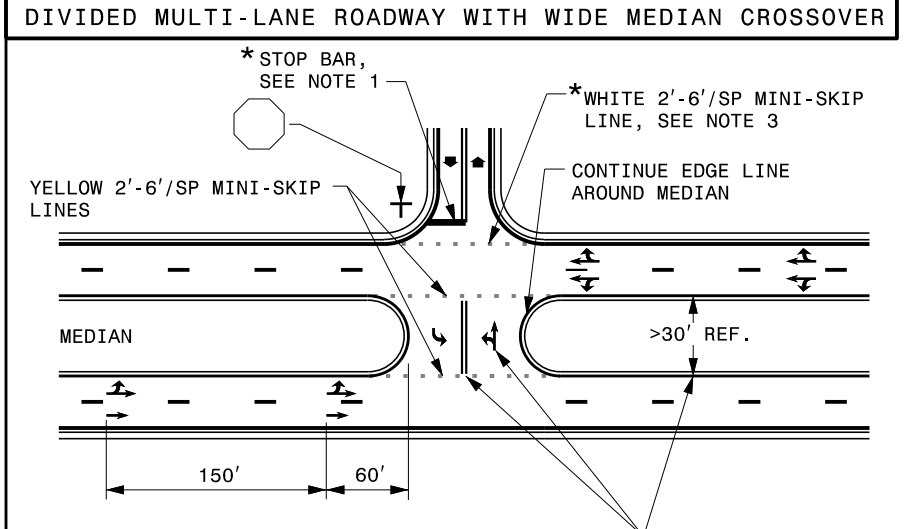

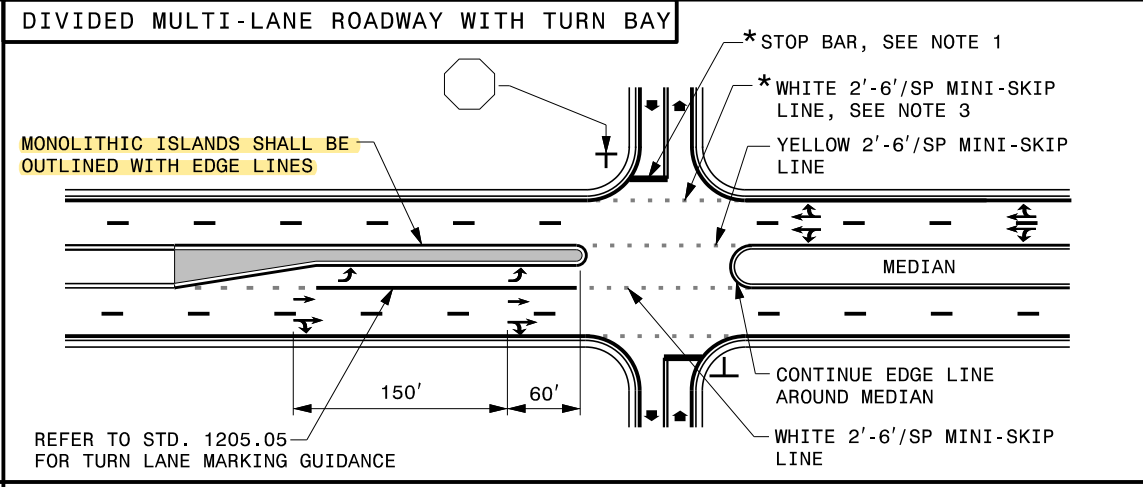

TIP NO.	SHEET NO.
DocuSigned by: <i>Matthew V. Springer</i>	
APPROVED:	6/19/2019
DATE:	07667068584403...
SEAL	
	

STATE OF NORTH CAROLINA  
DEPT. OF TRANSPORTATION  
DIVISION OF HIGHWAYS  
RALEIGH, N.C.

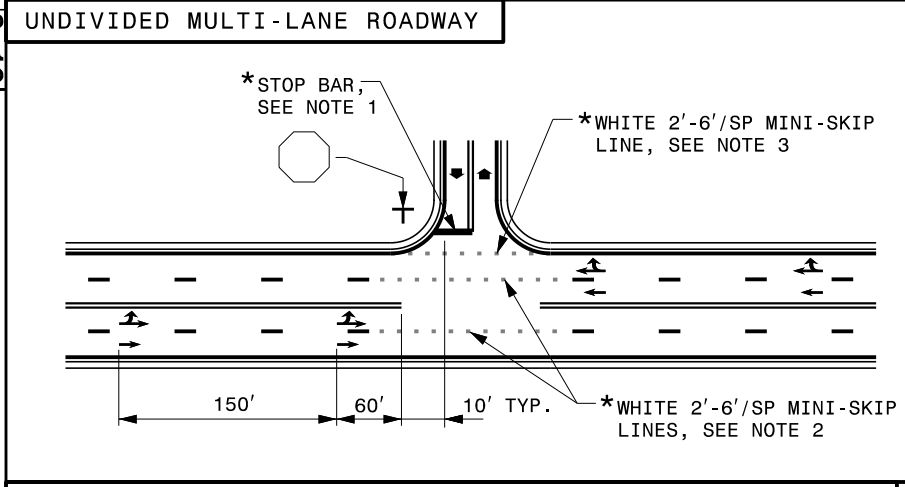
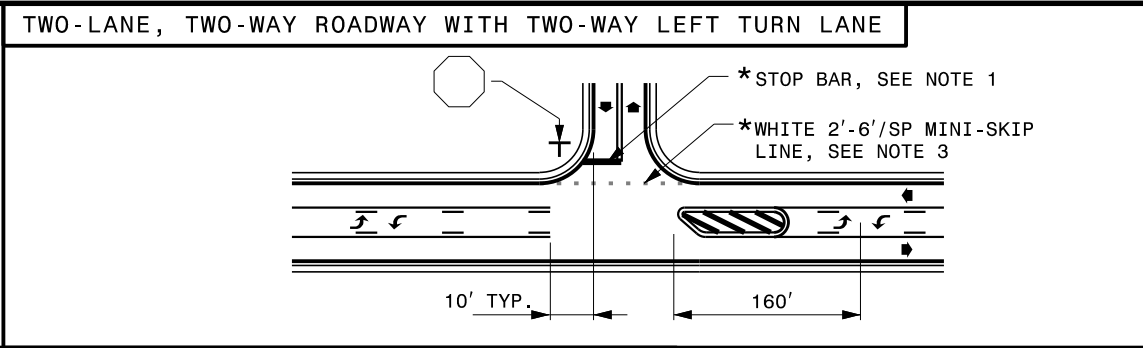
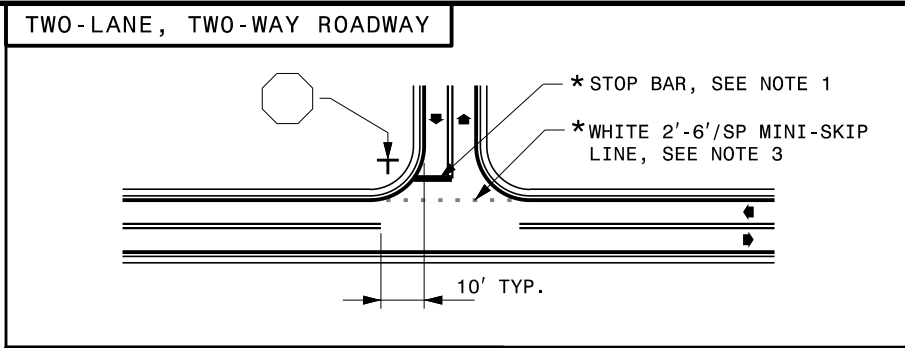

- GENERAL NOTES:
- 1- PLACEMENT OF STOP BARS AT NON-SIGNALIZED INTERSECTIONS IS OPTIONAL AND USED WHERE IT IS IMPORTANT TO INDICATE THE POINT WHICH VEHICLES ARE REQUIRED TO STOP. PLACE STOP BARS NO LESS THAN 4 FEET AND NO MORE THAN 30 FEET FROM THE NEAREST EDGE OF THE INTERSECTING ROADWAY. USE 10 FEET AS THE TYPICAL SETBACK DISTANCE OR AS DIRECTED BY THE ENGINEER.
  - 2- MINI-SKIP LANE LINE EXTENSIONS SHOULD BE USED AT INTERSECTIONS THAT HAVE REDUCED VISIBILITY CONDITIONS SUCH AS OFFSET, SKEWED, OR CURVED ROADWAYS.
  - 3- MINI-SKIP EDGE LINE EXTENSIONS MAY BE PLACED THROUGH INTERSECTIONS AND MAJOR DRIVEWAYS.
  - 4- REFER TO ROADWAY STANDARD DRAWINGS 1205.01, 1205.02, 1205.05, 1205.08 AND 1205.09 FOR ADDITIONAL PAVEMENT MARKING GUIDANCE.

LEGEND	
	STOP SIGN
	STATIONARY SIGN
	DIRECTION OF TRAFFIC FLOW
	PAVEMENT MARKING SYMBOLS
*	OPTIONAL

STATE OF NORTH CAROLINA  
DEPT. OF TRANSPORTATION  
DIVISION OF HIGHWAYS  
RALEIGH, N.C.

ENGLISH DETAIL DRAWING FOR  
**PAVEMENT MARKINGS**  
INTERSECTIONS

SHEET 2 OF 2  
**1205D04**

SHEET 2 OF 2  
**1205D04**

**REVISED PAVEMENT MARKING  
ROADWAY STANDARD DRAWING**