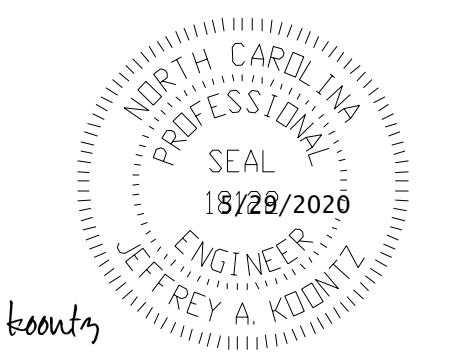

TIP NO. BR-0042	SHEET NO. PMP-1
APPROVED: _____	
DATE: _____	
SEAL	
	
DocuSigned by: <i>Jeffrey A. Koontz</i> 1848FECC02184F7	
<b>DOCUMENT NOT CONSIDERED FINAL UNLESS ALL SIGNATURES COMPLETED</b>	

**STATE OF NORTH CAROLINA  
DEPARTMENT OF TRANSPORTATION**

**PAVEMENT MARKING PLAN**

**ROCKINGHAM COUNTY**

**LOCATION: BRIDGE NO. 780116 ON SR 2600  
(MIZPAH CHURCH RD) OVER US 29**

**T.I.P.: BR-0042**

**CONTRACT: C204392**

**INDEX**

SHEET NO.	DESCRIPTION
PMP-1	PAVEMENT MARKING PLAN TITLE AND SCHEDULE SHEET
PMP-2 THRU PMP-3	PAVEMENT MARKING DETAILS

**GENERAL NOTES**

THE FOLLOWING GENERAL NOTES APPLY AT ALL TIMES FOR THE DURATION OF THE CONSTRUCTION PROJECT, EXCEPT WHEN OTHERWISE NOTED IN THE PLAN, OR DIRECTED BY THE ENGINEER.

A) INSTALL PAVEMENT MARKINGS AND PAVEMENT MARKERS ON THE FINAL SURFACE AS FOLLOWS:

ROAD NAME	MARKING	MARKER
MIZPAH CHURCH RD	THERMOPLASTIC	SNOWPLOWABLE
MIZPAH CHURCH RD (BRIDGE)	COLD APPLIED PLASTIC	RAISED
US 29	THERMOPLASTIC	SNOWPLOWABLE
ELM GROVE CHURCH RD	THERMOPLASTIC	NONE
MAGNOLIA DR	THERMOPLASTIC	NONE
COOK FLORIST RD	THERMOPLASTIC	SNOWPLOWABLE

B) TIE PROPOSED PAVEMENT MARKING LINES TO EXISTING PAVEMENT MARKING LINES.

C) REMOVE/REPLACE ANY CONFLICTING/DAMAGED PAVEMENT MARKINGS AND MARKERS.

D) STOP BAR LOCATION AT NON-SIGNALIZED INTERSECTIONS MAY BE ADJUSTED AS DIRECTED BY THE ENGINEER.

**ROADWAY STANDARD DRAWING**

THE FOLLOWING ROADWAY STANDARDS AS APPEAR IN "ROADWAY STANDARD DRAWINGS" - PROJECT SERVICES UNIT - N.C. DEPARTMENT OF TRANSPORTATION - RALEIGH, N.C., DATED JANUARY 2018 ARE APPLICABLE TO THIS PROJECT AND BY REFERENCE HEREBY ARE CONSIDERED A PART OF THESE PLANS:

STD. NO.	TITLE
1205.01	PAVEMENT MARKINGS - LINE TYPES AND OFFSETS
1205.02	PAVEMENT MARKINGS - TWO-LANE AND MULTILANE ROADWAYS
1205.04	PAVEMENT MARKINGS - INTERSECTIONS
1205.12	PAVEMENT MARKINGS - BRIDGES
1250.01	RAISED PAVEMENT MARKERS - INSTALLATION SPACING
1251.01	RAISED PAVEMENT MARKERS - PERMANENT AND TEMPORARY
1253.01	RAISED PAVEMENT MARKERS - SNOWPLOWABLE
1261.01	GUARDRAIL AND BARRIER DELINEATORS - INSTALLATION SPACING
1261.02	GUARDRAIL AND BARRIER DELINEATORS - TYPES AND MOUNTING
1262.01	GUARDRAIL END DELINEATION

**FINAL PAVEMENT MARKING SCHEDULE**

SYMBOL	DESCRIPTION	SYMBOL	DESCRIPTION
THERMOPLASTIC		COLD APPLIED PLASTIC	
T2	WHITE STOPBAR (24", 90 MIL)	CA	WHITE EDGELINE (4")
T6	WHITE EDGELINE (6", 90 MIL)	CI	YELLOW DOUBLE CENTER (4")
T7	YELLOW EDGELINE (6", 90 MIL)		
T8	2FT.-6FT./SP WHITE MINISKIP (4", 90 MIL)		
TA	WHITE EDGELINE (4" 90 MIL)		
TI	YELLOW DOUBLE CENTER (4" 90 MIL)		
TJ	10FT. WHITE SKIP (6", 90 MIL)		

**PLAN SUBMITTED TO:**

DAVID STUTTS, PE

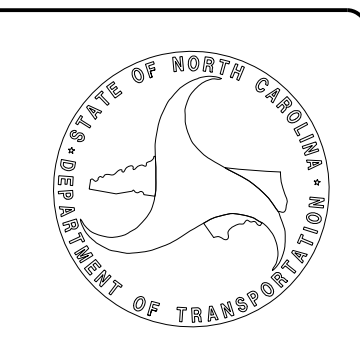



**PLAN PREPARED BY:**

JEFFREY KOONTZ, PE PROJECT ENGINEER  
TIMOTHY KLOTZ, PE DESIGN ENGINEER

**AECOM**

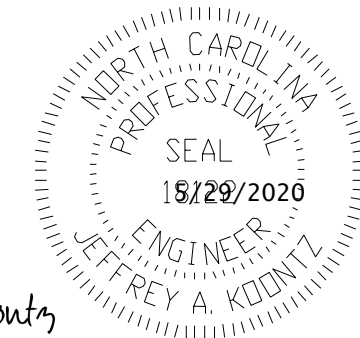
NC FIRM LICENSE No: F-0342  
701 Corporate Center Drive, Suite 475  
Raleigh, NC 27601  
(919) 854-6200 / (919) 854-6253(FAX)

TIP NO. BR-0042	SHEET NO. PMP-2
APPROVED: _____	
DATE: _____	
SEAL	
	
Assigned by: Jeffrey A. Koontz AEBPECC023847	
<b>DOCUMENT NOT CONSIDERED FINAL UNLESS ALL SIGNATURES COMPLETED</b>	
	
<small>NC FIRM LICENSE No. F-0342 701 Corporate Center Drive, Suite 475 Raleigh, NC 27603 (919) 854-6200 • (919) 854-6259 FAX</small>	

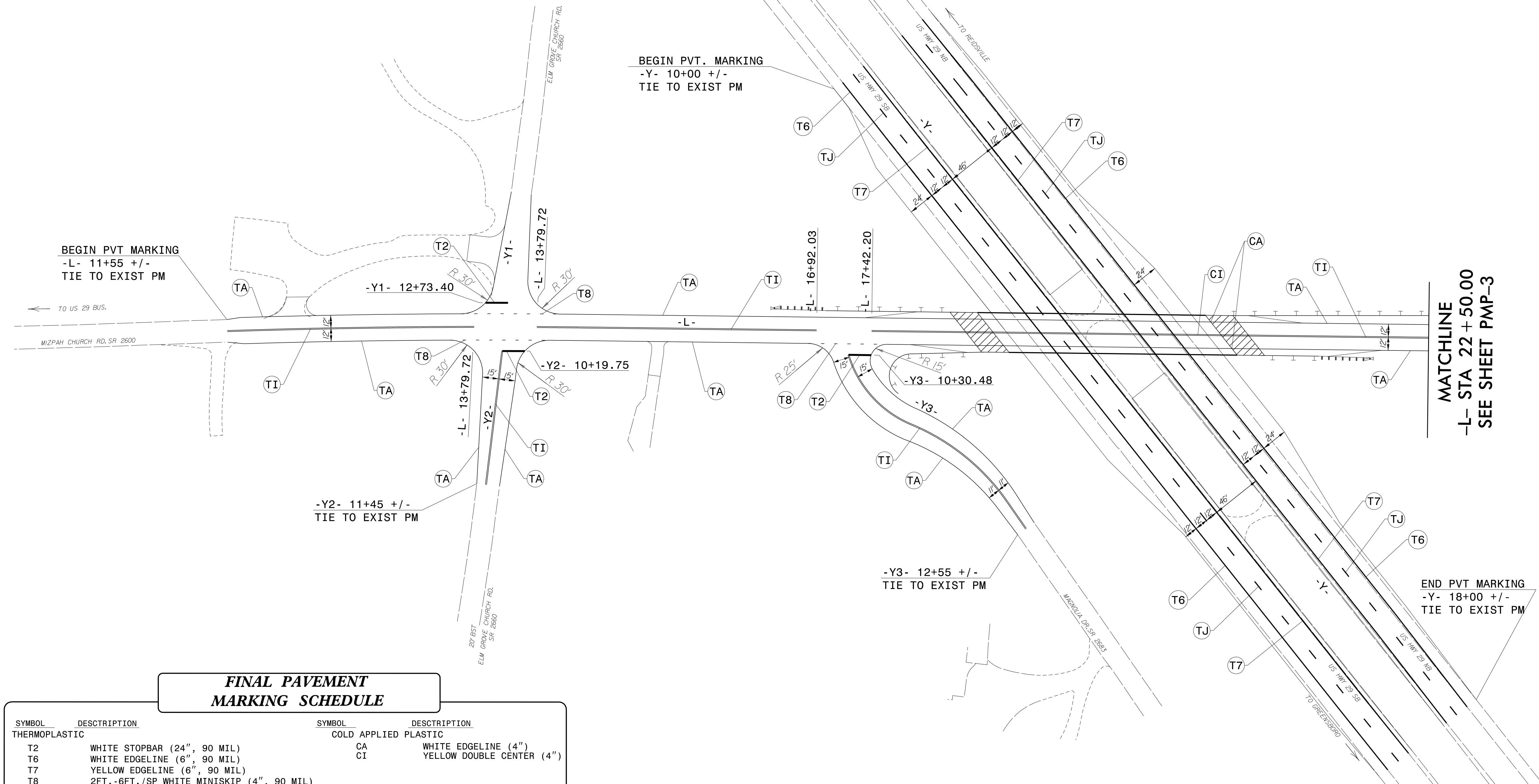
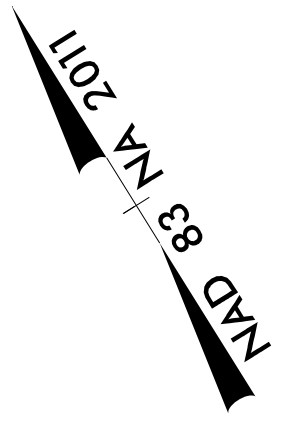

**FINAL PAVEMENT  
MARKING SCHEDULE**

SYMBOL	DESCRIPTION	SYMBOL	DESCRIPTION
<b>THERMOPLASTIC</b>			
T2	WHITE STOPBAR (24", 90 MIL)	CA	WHITE EDGELINE (4")
T6	WHITE EDGELINE (6", 90 MIL)	CI	YELLOW DOUBLE CENTER (4")
T7	YELLOW EDGELINE (6", 90 MIL)		
T8	2FT.-6FT./SP WHITE MINISKIP (4", 90 MIL)		
TA	WHITE EDGELINE (4" 90 MIL)		
TI	YELLOW DOUBLE CENTER (4" 90 MIL)		
TJ	10FT. WHITE SKIP (6", 90 MIL)		
<b>COLD APPLIED PLASTIC</b>			

**PAVEMENT MARKING DETAIL**

12/10/2019  
 R:\Traffic\TrafficControl\TCP\BR0042.pmp\_psh02.dgn  
 User:Jeff.Koontz

TIP NO. BR - 0042	SHEET NO. PMP - 3
APPROVED: _____	
DATE: _____	
SEAL	
DocuSigned by: Jeffrey A. Koontz -B4EBFCC02384F7	5/29/2020
<b>DOCUMENT NOT CONSIDERED FINAL UNLESS ALL SIGNATURES COMPLETED</b>	
<small>NC FIRM LICENSE No. F-0342 701 Corporate Center Drive, Suite 475 Raleigh, NC 27607 (919) 854-6200 • (919) 854-6259 FAX</small>	

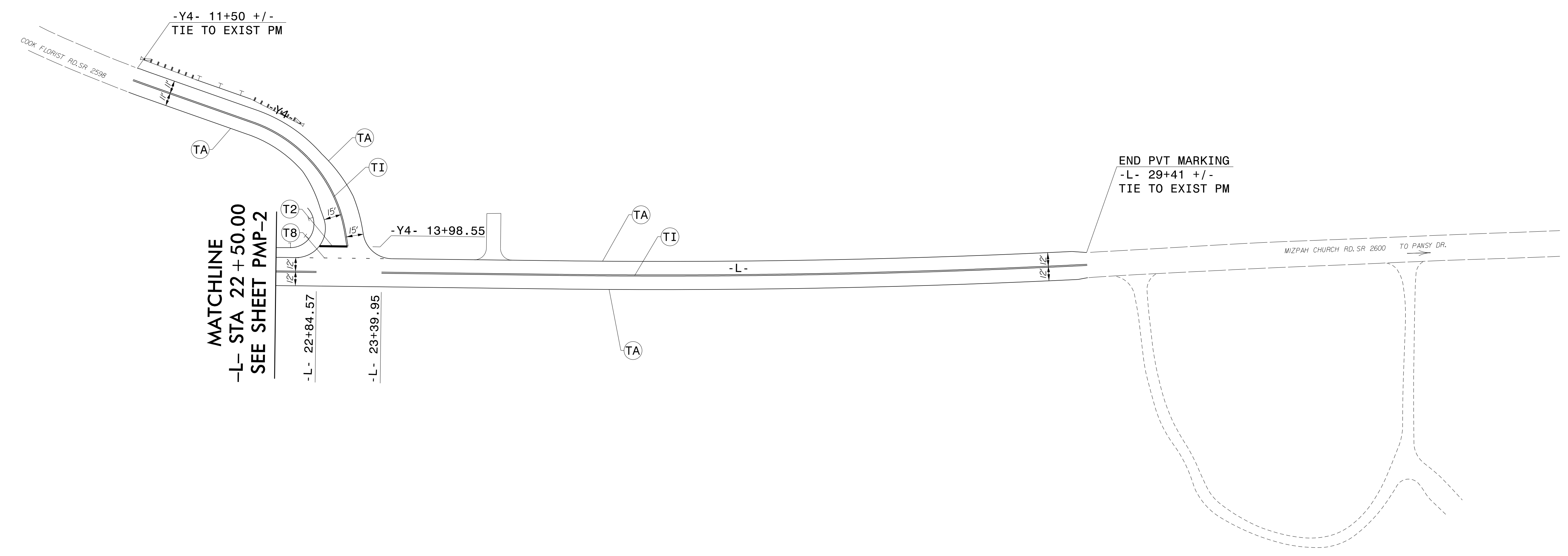
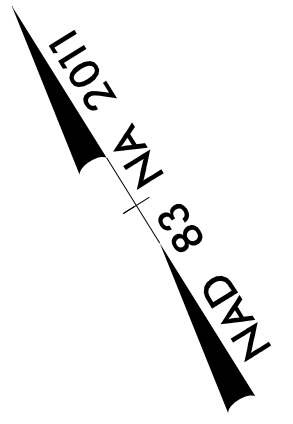

**FINAL PAVEMENT  
MARKING SCHEDULE**

SYMBOL	DESCRIPTION	SYMBOL	DESCRIPTION
<b>THERMOPLASTIC</b>			
T2	WHITE STOPBAR (24", 90 MIL)	CA	WHITE EDGELINE (4")
T6	WHITE EDGELINE (6", 90 MIL)	CI	YELLOW DOUBLE CENTER (4")
T7	YELLOW EDGELINE (6", 90 MIL)		
T8	2FT.-6FT./SP WHITE MINISKIP (4", 90 MIL)		
TA	WHITE EDGELINE (4" 90 MIL)		
TI	YELLOW DOUBLE CENTER (4" 90 MIL)		
TJ	10FT. WHITE SKIP (6", 90 MIL)		
<b>COLD APPLIED PLASTIC</b>			

**PAVEMENT MARKING DETAIL**

12/10/2019  
 R:\Traffic\TrafficControl\TCP\BR0042.pmp\_psh03.dgn  
 User:Jeff.Koontz