



# STATE OF NORTH CAROLINA DIVISION OF HIGHWAYS

PROJ. REFERENCE NO.	SHEET NO.
I-5711	X-1B

Approximate quantities only. Unclassified excavation, borrow excavation, grading, clearing and grubbing, and removal of existing pavement will be paid for at the lump sum price for "Grading".

NOTE: EMBANKMENT COLUMN DOES NOT INCLUDES BACKFILL FOR UNDERCUT

## CROSS-SECTION SUMMARY

Station	Uncl. Exc.	Embt	Station	Uncl. Exc.	Embt	Station	Uncl. Exc.	Embt	Station	Uncl. Exc.	Embt	Station	Uncl. Exc.	Embt
L (LT)	(cu. yd.)	(cu. yd.)	L (LT)	(cu. yd.)	(cu. yd.)	L (RT)	(cu. yd.)	(cu. yd.)	Rpb_Y1	(cu. yd.)	(cu. yd.)	Y3	(cu. yd.)	(cu. yd.)
18+03.85	0	0	44+50.00	10	134	36+00.00	17	90	15+50.00	526	0	12+10.00	0	0
18+50.00	0	0	45+00.00	9	142	36+50.00	5	131	16+00.00	611	13	12+50.00	0	0
19+00.00	0	0	45+50.00	8	149	37+00.00	19	113	16+50.00	681	13	13+00.00	28	22
19+50.00	0	0	46+00.00	8	144	37+50.00	34	83	17+00.00	815	7	13+50.00	35	9
20+00.00	59	0	46+50.00	11	139	38+00.00	26	83	17+50.00	881	12	13+95.01	0	0
20+50.00	82	0	47+00.00	13	127	38+50.00	18	66	18+00.00	787	12			
21+00.00	56	0	47+50.00	14	112	39+00.00	19	52	18+50.00	676	11	<b>Station</b>	<b>Uncl. Exc.</b>	<b>Embt</b>
21+50.00	54	6	48+00.00	18	75	39+50.00	26	31	19+00.00	540	10	<b>Y4</b>	<b>(cu. yd.)</b>	<b>(cu. yd.)</b>
22+00.00	47	26	48+50.00	13	69	40+00.00	33	6	19+50.00	237	24	10+25.52	0	0
22+50.00	23	52	49+00.00	5	79	40+50.00	34	2	20+00.00	6	89	10+50.00	0	0
23+00.00	4	172	49+50.00	4	61	41+00.00	33	1	20+50.00	1	269	11+00.00	14	12
23+50.00	0	452	50+00.00	0	0	41+50.00	31	3	20+72.91	0	0	11+50.00	52	12
24+00.00	0	311				42+00.00	144	2				11+96.20	0	0
24+50.00	1	131	<b>Station</b>	<b>Uncl. Exc.</b>	<b>Embt</b>	42+50.00	130	0	<b>Station</b>	<b>Uncl. Exc.</b>	<b>Embt</b>			
25+00.00	7	487				43+00.00	55	0				<b>Station</b>	<b>Uncl. Exc.</b>	<b>Embt</b>
25+96.62	17	995	<b>L (RT)</b>	<b>(cu. yd.)</b>	<b>(cu. yd.)</b>	43+50.00	74	0	<b>Rpc_Y1</b>	<b>(cu. yd.)</b>	<b>(cu. yd.)</b>	<b>Y4A</b>	<b>(cu. yd.)</b>	<b>(cu. yd.)</b>
			18+03.85	0	0	44+00.00	19	0	10+50.00	0	0	10+50.00	0	0
<b>Station</b>	<b>Uncl. Exc.</b>	<b>Embt</b>	18+50.00	0	0	44+50.00	0	0	11+00.00	5	26	11+00.00	232	438
<b>L (LT)</b>	<b>(cu. yd.)</b>	<b>(cu. yd.)</b>	19+00.00	0	0	45+00.00	0	0	11+50.00	10	69	11+50.00	205	283
			19+50.00	0	0	45+50.00	0	0	11+95.54	0	0	12+00.00	504	23
28+15.65	0	0	20+00.00	8	66	46+00.00	0	0				12+50.00	745	0
28+50.00	0	0	20+50.00	14	82	46+50.00	0	0	<b>Station</b>	<b>Uncl. Exc.</b>	<b>Embt</b>	13+40.00	623	0
29+00.00	19	454	21+00.00	19	86	47+00.00	0	0						
29+50.00	14	158	21+50.00	19	81	47+50.00	0	0	<b>Rpd_Y1</b>	<b>(cu. yd.)</b>	<b>(cu. yd.)</b>			
30+00.00	11	64	22+00.00	15	95	48+00.00	0	0	19+80.09	0	0			
30+50.00	4	83	22+50.00	11	107	48+50.00	0	0	20+00.00	0	0			
31+00.00	7	45	23+00.00	7	121	49+00.00	0	0	20+50.00	17	67			
31+50.00	11	60	23+50.00	6	120	49+50.00	0	0	21+00.00	8	101			
32+00.00	9	91	24+00.00	2	58	50+00.00	0	0	21+42.67	0	0			
32+50.00	4	131	24+50.00	2	1									
33+00.00	1	156	25+00.00	13	57	<b>Station</b>	<b>Uncl. Exc.</b>	<b>Embt</b>	<b>Station</b>	<b>Uncl. Exc.</b>	<b>Embt</b>			
33+50.00	9	81	25+50.00	27	96									
34+00.00	9	0	25+96.62	0	0	<b>Rpa_Y1</b>	<b>(cu. yd.)</b>	<b>(cu. yd.)</b>	<b>Y</b>	<b>(cu. yd.)</b>	<b>(cu. yd.)</b>			
34+50.00	1	43				12+50.00	0	0	13+72.47	0	0			
35+00.00	8	57	<b>Station</b>	<b>Uncl. Exc.</b>	<b>Embt</b>	13+00.00	18	128	14+00.00	0	0			
35+50.00	7	16				13+50.00	11	167	15+00.00	0	36			
36+00.00	11	4	<b>L (RT)</b>	<b>(cu. yd.)</b>	<b>(cu. yd.)</b>	14+00.00	0	307	15+50.00	52	18			
36+50.00	21	6	28+15.65	0	0	14+50.00	2	538	16+00.00	83	18			
37+00.00	21	5	28+50.00	0	0	14+89.10	0	0	16+50.00	39	17			
37+50.00	31	2	29+00.00	19	130				16+87.00	0	0			
38+00.00	43	2	29+50.00	5	28	<b>Station</b>	<b>Uncl. Exc.</b>	<b>Embt</b>						
38+50.00	38	6	30+00.00	3	40				<b>Station</b>	<b>Uncl. Exc.</b>	<b>Embt</b>			
39+00.00	23	16	30+50.00	7	63	<b>Rpb_Y1</b>	<b>(cu. yd.)</b>	<b>(cu. yd.)</b>	<b>Y2</b>	<b>(cu. yd.)</b>	<b>(cu. yd.)</b>			
39+50.00	17	26	31+00.00	6	43	10+75.00	0	0						
40+00.00	17	33	31+50.00	10	31	11+00.00	0	0	10+50.93	0	0			
40+50.00	24	32	32+00.00	29	12	11+50.00	126	0	11+00.00	2	178			
41+00.00	26	26	32+50.00	70	0	12+00.00	170	0	11+50.00	1	141			
41+50.00	22	25	33+00.00	55	0	12+50.00	196	0	12+00.00	3	74			
42+00.00	21	35	33+50.00	8	1	13+00.00	209	0	12+50.00	3	32			
42+50.00	18	60	34+00.00	22	11	13+50.00	244	1	13+05.00	3	10			
43+00.00	15	100	34+50.00	35	17	14+00.00	295	3						
43+50.00	13	131	35+00.00	37	88	14+50.00	366	4						
44+00.00	12	137	35+50.00	32	113	15+00.00	453	1						

6/23/16

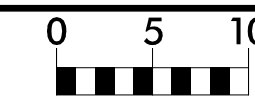

PROJ. REFERENCE NO.	SHEET NO.
I-5711	X-1

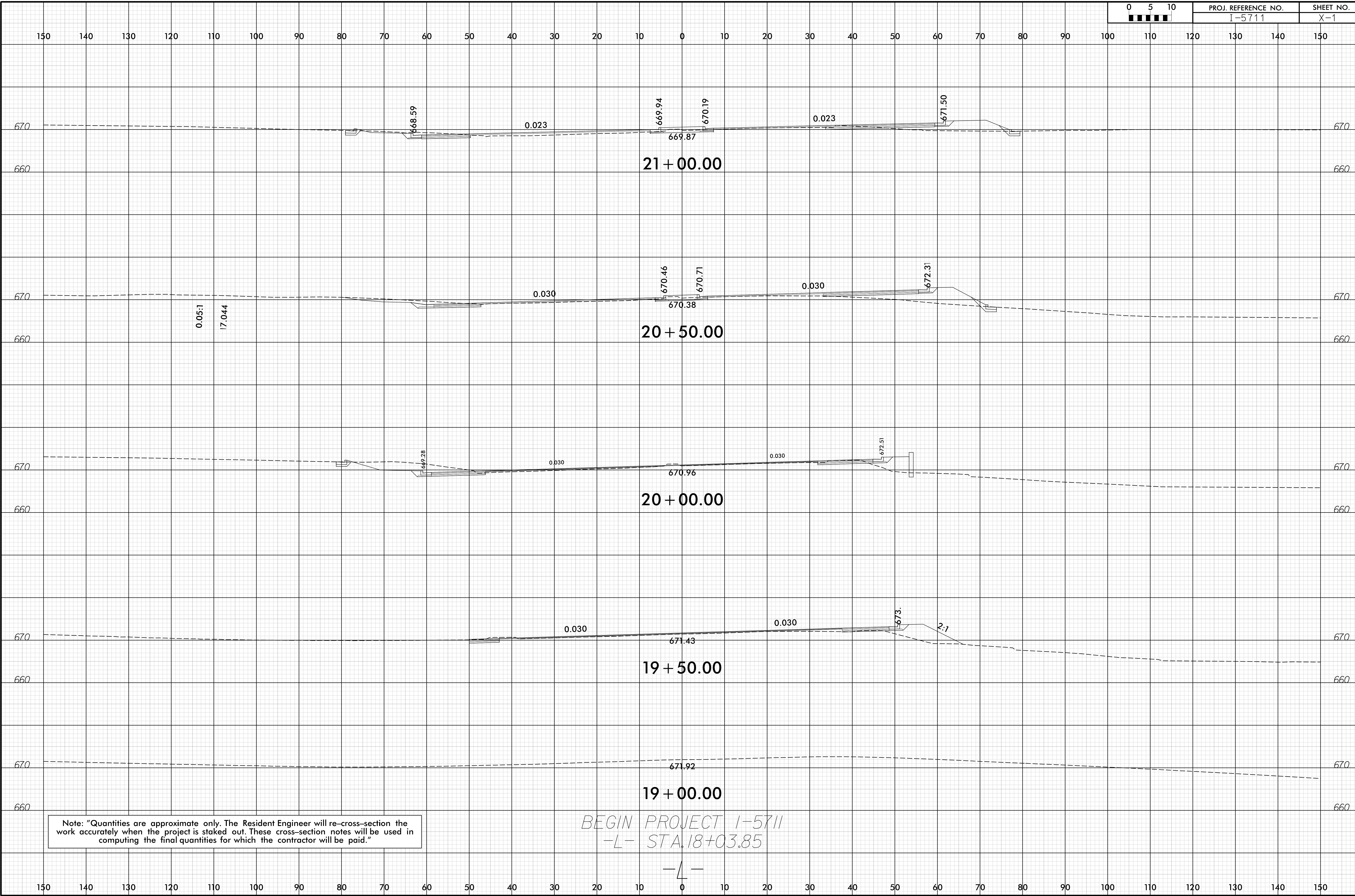

4/20/2020  
L-50A.PLY\_XPL.L.dgn  
C. DONNELLY

6/23/16

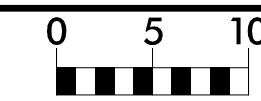

PROJ. REFERENCE NO.	SHEET NO.
I-5711	X-2

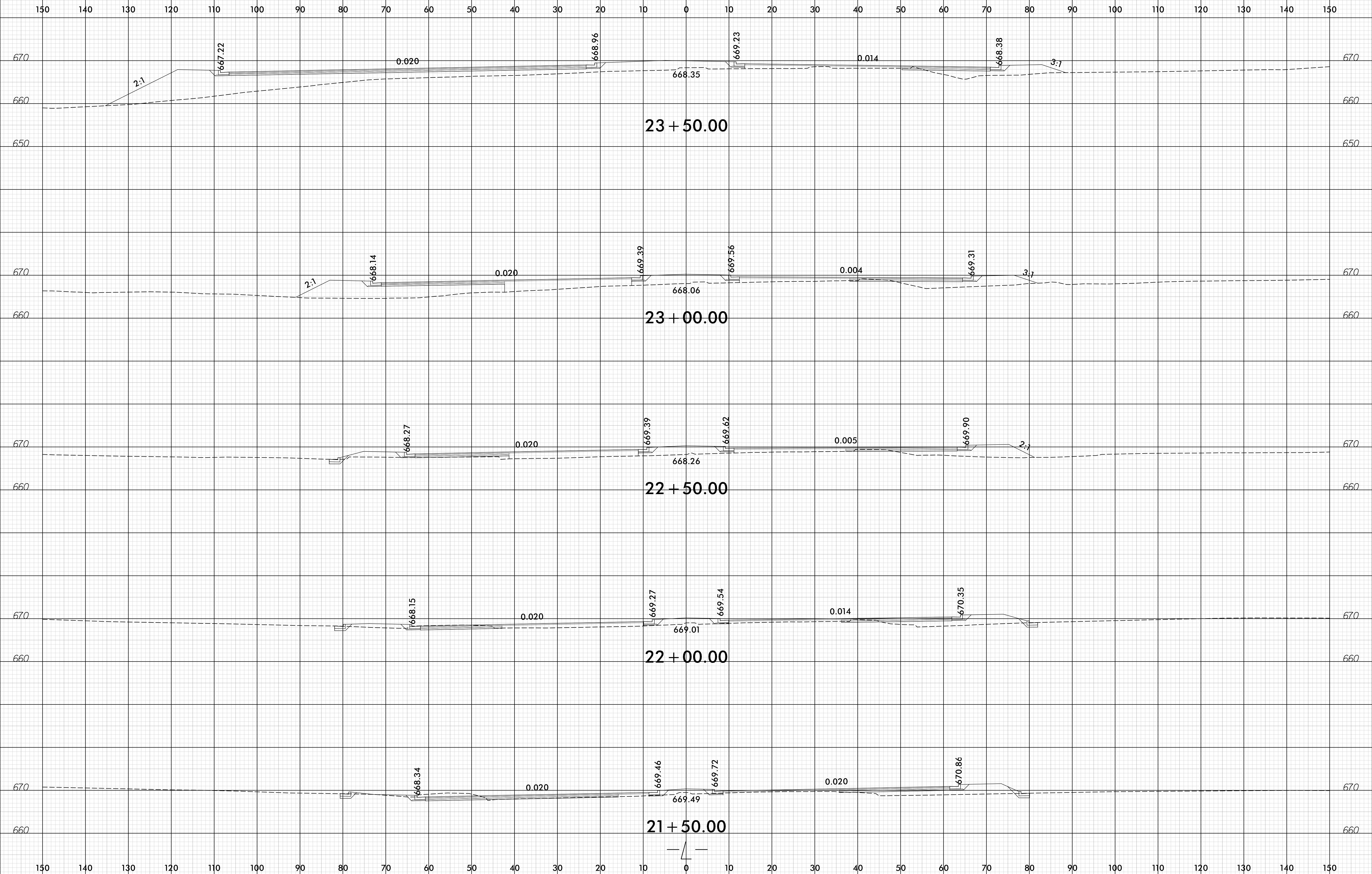

I:\2016\160623\160623.dgn

6/23/16

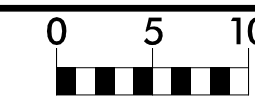

PROJ. REFERENCE NO.	SHEET NO.
I-5711	X-3

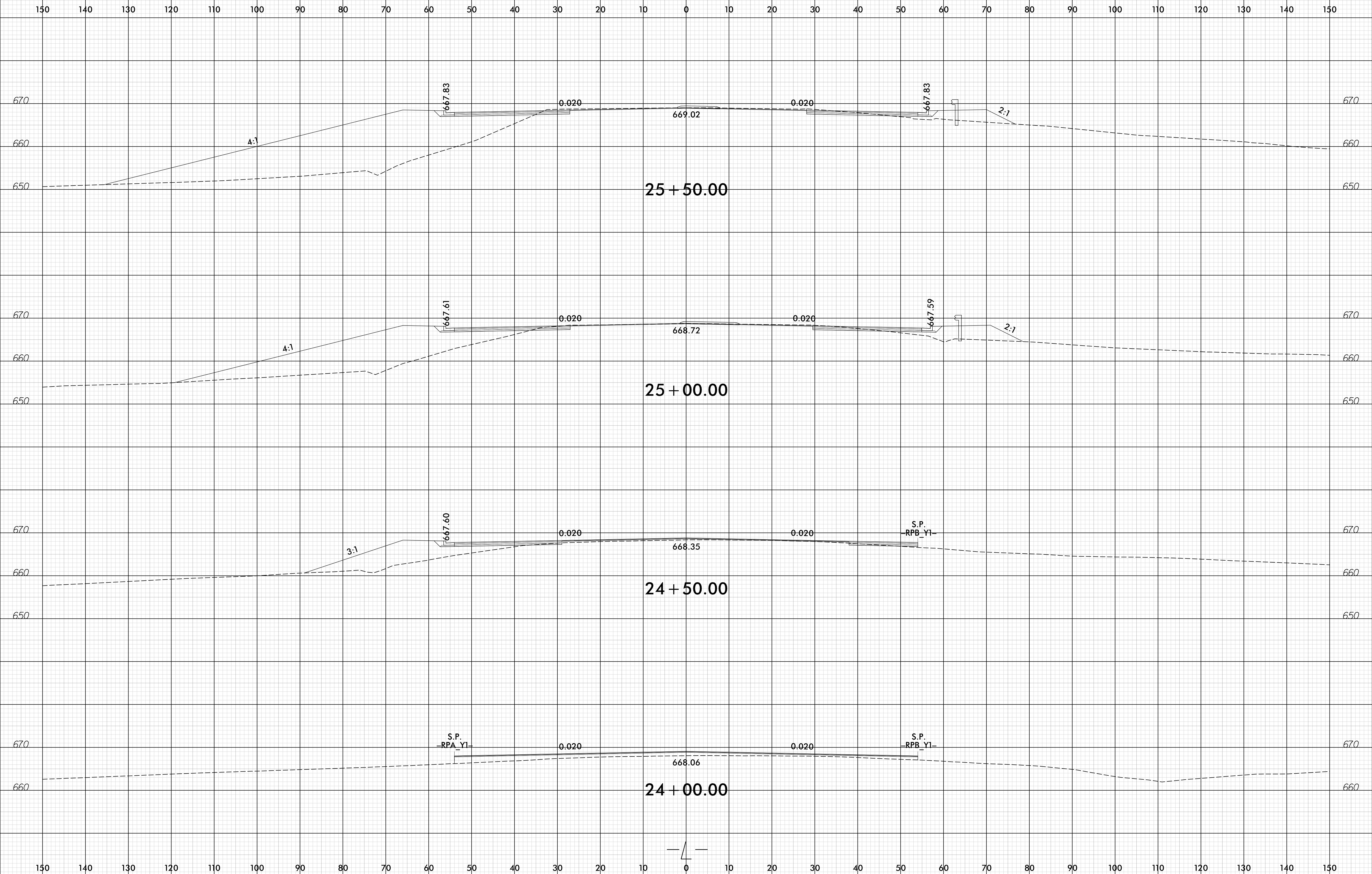

I:\2016\16\I-5711\RDY\_XPL.L.dgn

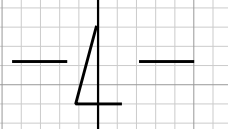

6/23/16

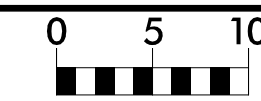

PROJ. REFERENCE NO.	SHEET NO.
I-5711	X-4

150 140 130 120 110 100 90 80 70 60 50 40 30 20 10 0 10 20 30 40 50 60 70 80 90 100 110 120 130 140 150

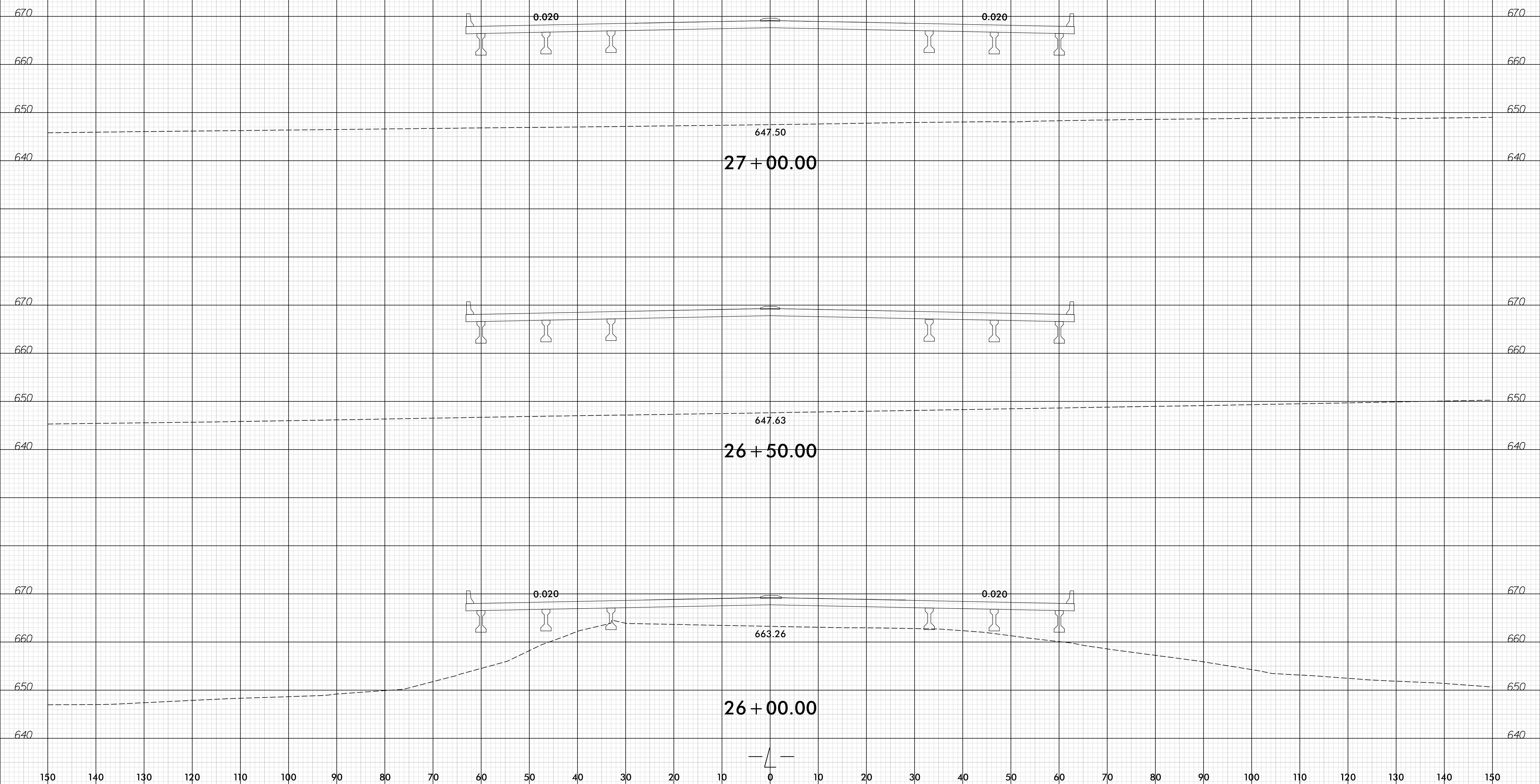

I:\2016\2016\I-5711\RDY\_XPL.L.dgn

150 140 130 120 110 100 90 80 70 60 50 40 30 20 10 0 10 20 30 40 50 60 70 80 90 100 110 120 130 140 150

150 140 130 120 110 100 90 80 70 60 50 40 30 20 10 0 10 20 30 40 50 60 70 80 90 100 110 120 130 140 150

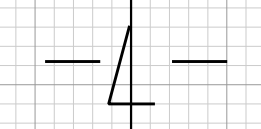
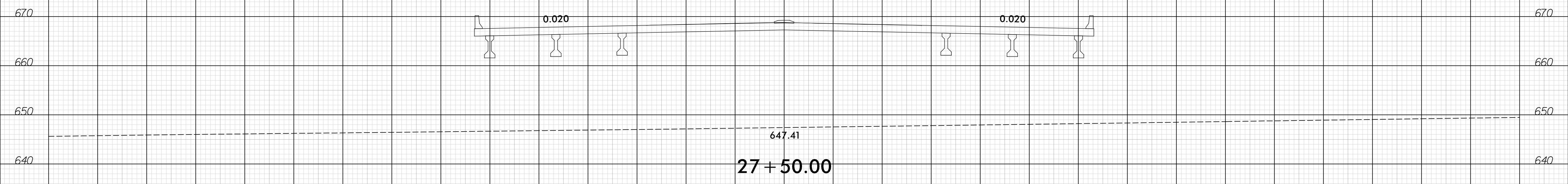
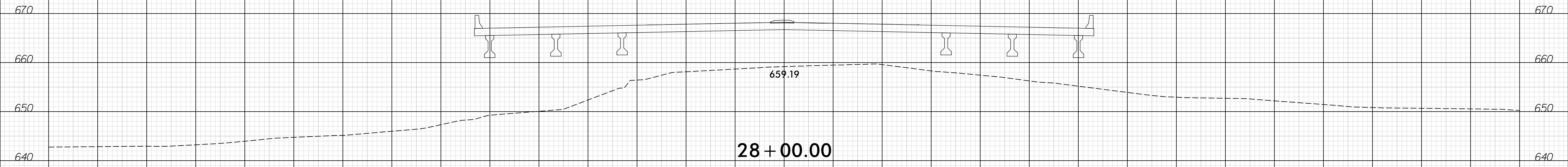
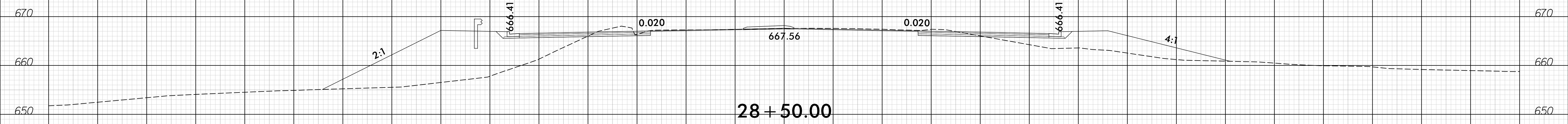

6/23/16

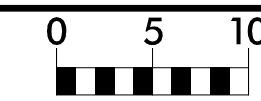

PROJ. REFERENCE NO.	SHEET NO.
I-5711	X-6

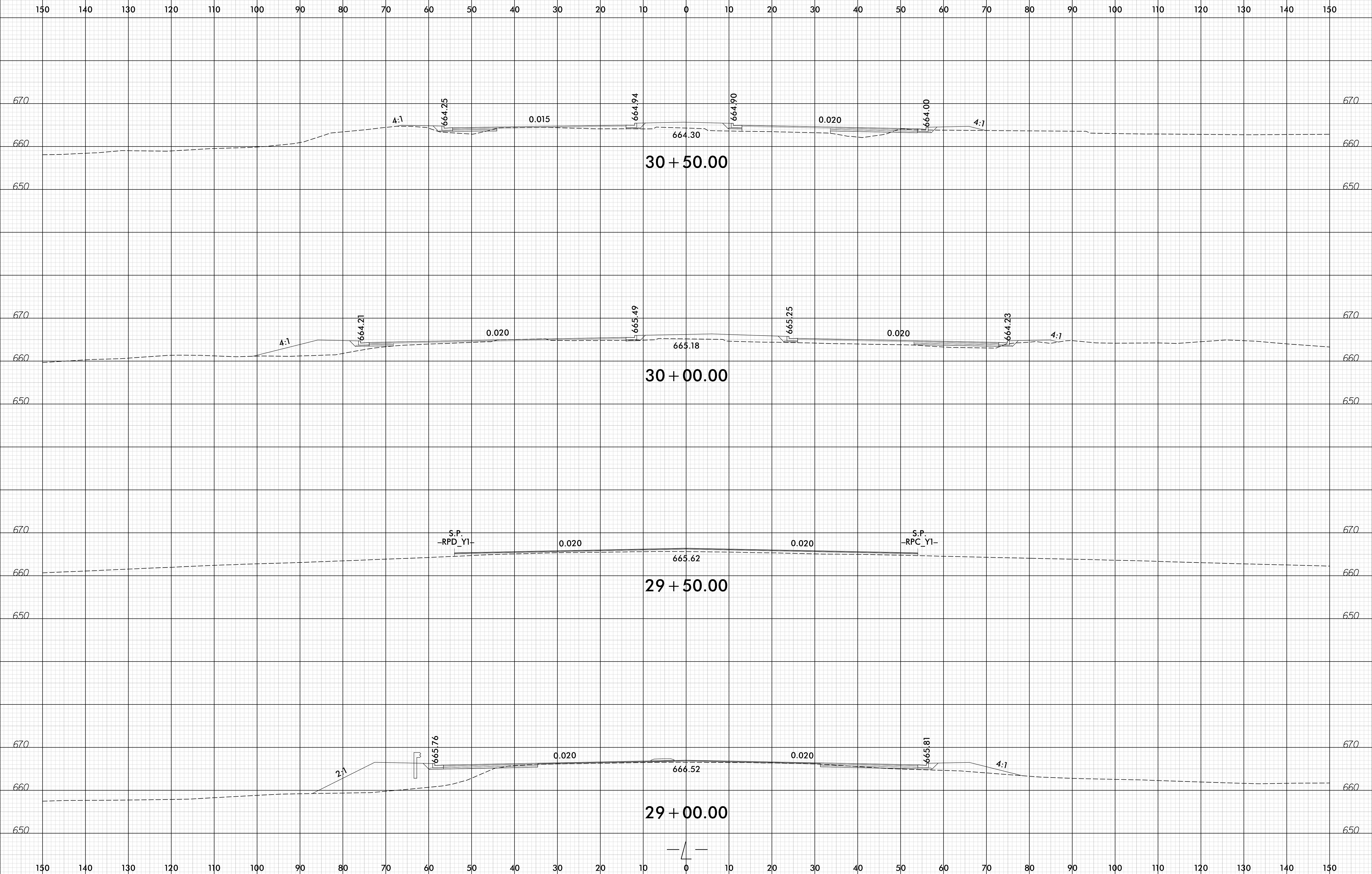

I:\2016\16\I-5711\RDY\_XPL.L.dgn



6/23/16

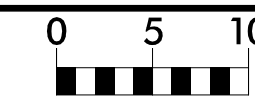

PROJ. REFERENCE NO.	SHEET NO.
I-5711	X-7

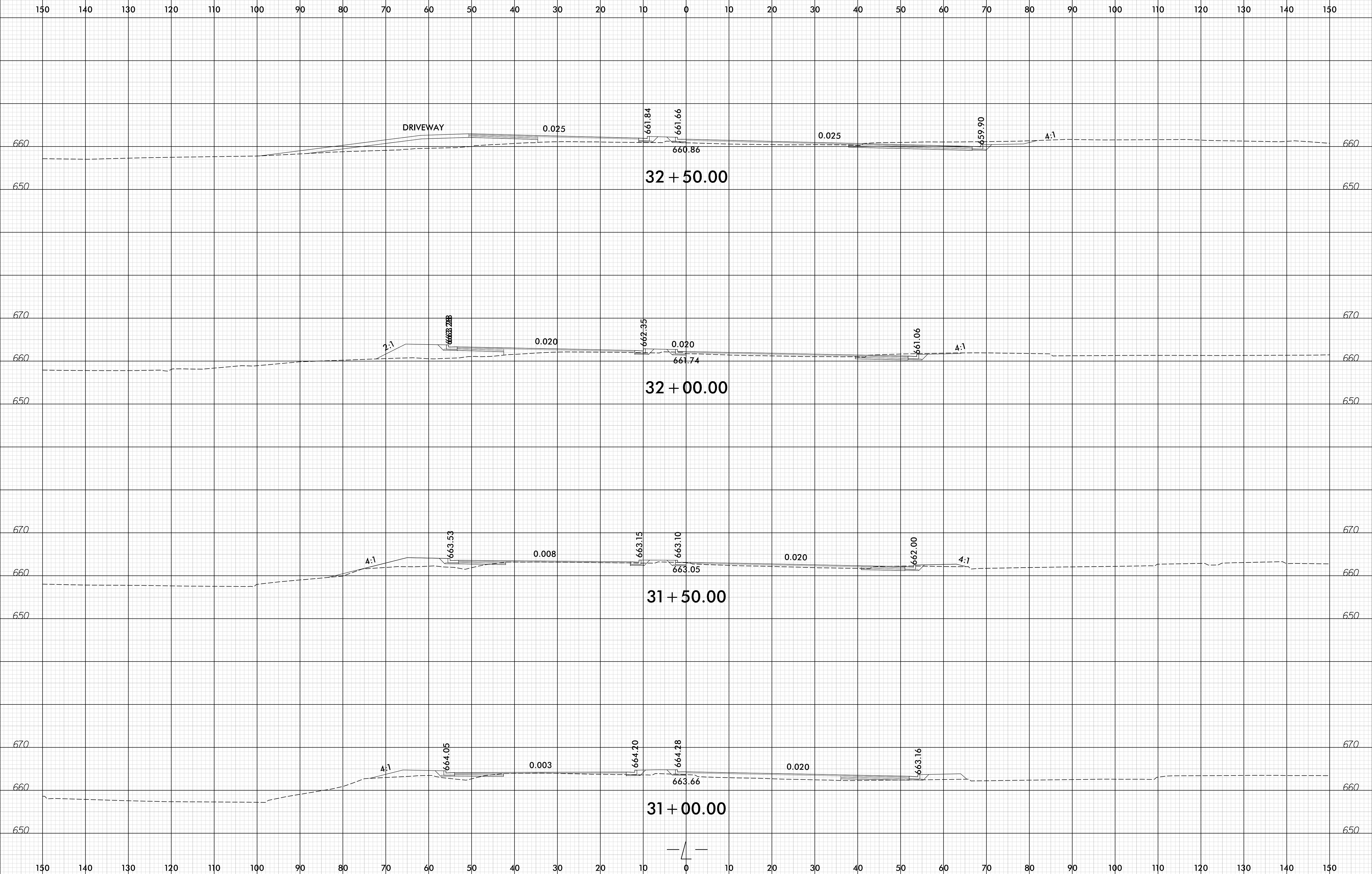

I:\2016\160617\160617-01\160617-01.dgn

6/23/16

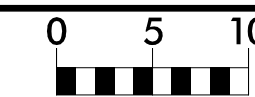

PROJ. REFERENCE NO.	SHEET NO.
I-5711	X-8

150 140 130 120 110 100 90 80 70 60 50 40 30 20 10 0 10 20 30 40 50 60 70 80 90 100 110 120 130 140 150

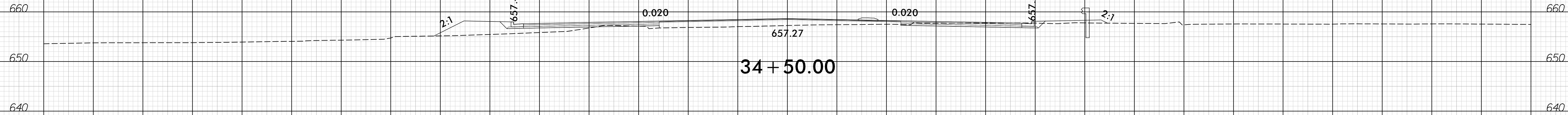

34 + 50.00

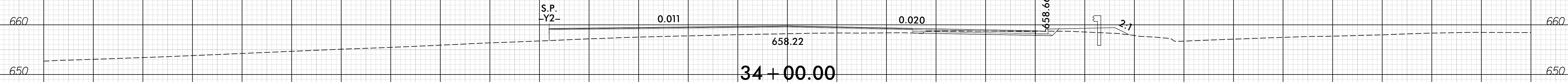

34 + 00.00

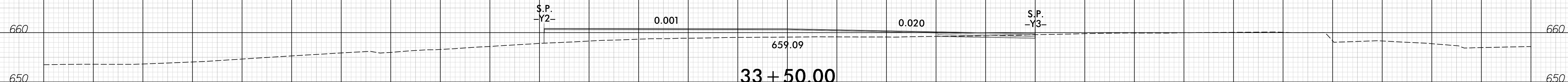

33 + 50.00

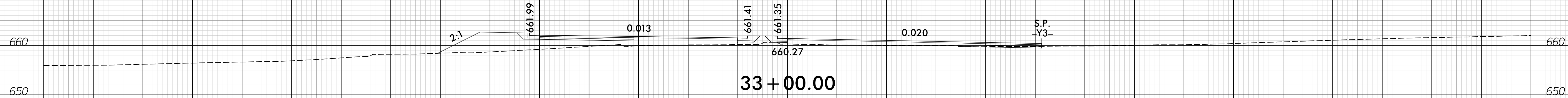

33 + 00.00

I:\2016\12\21\2016 I-5711 RDY - XPL.L.dgn

6/23/16

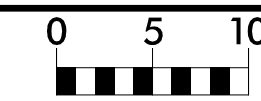

PROJ. REFERENCE NO.	SHEET NO.
I-5711	X-9

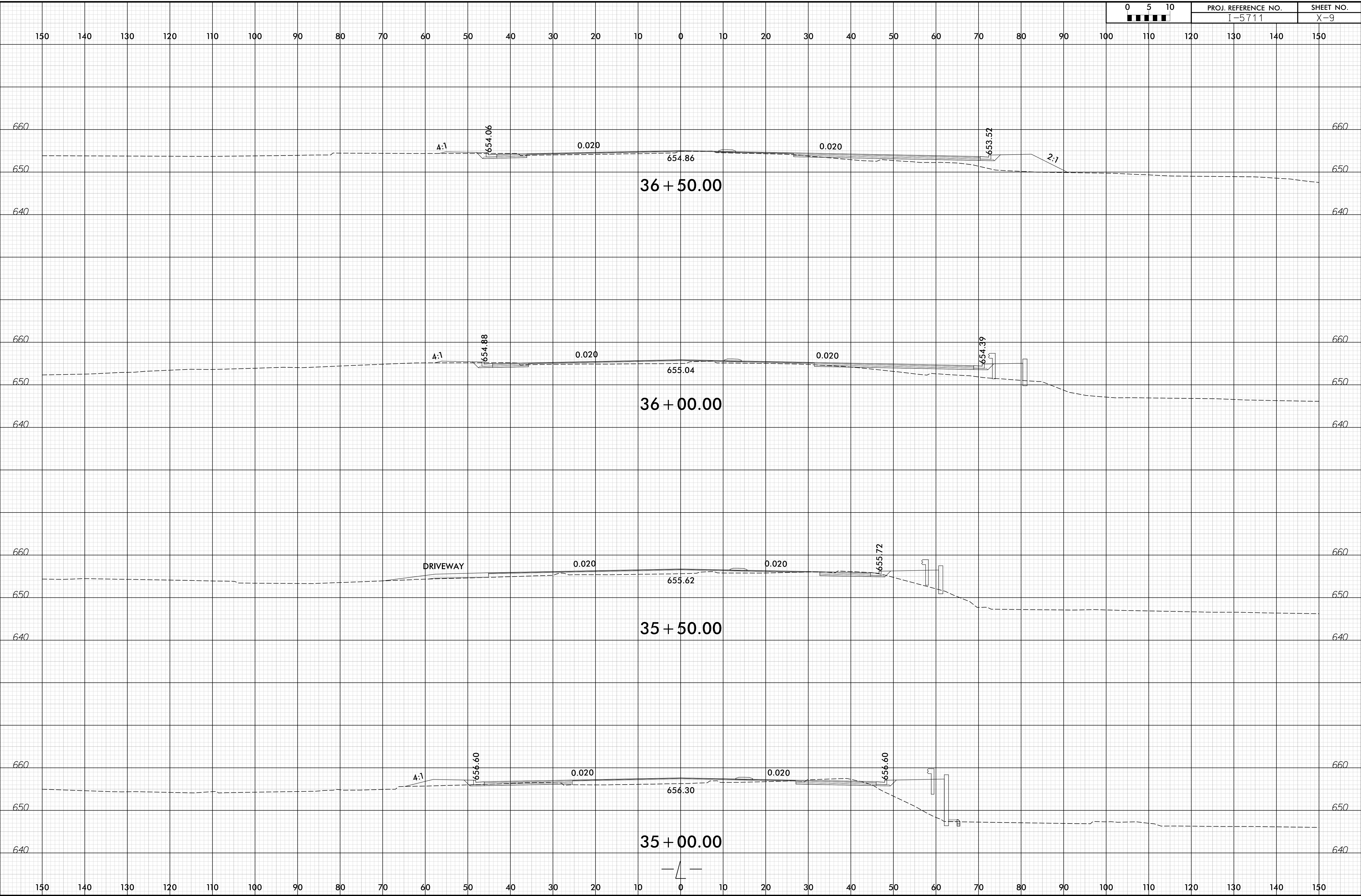

I:\2016\16\I-5711\RDY\_XPL.L.dgn



6/23/16

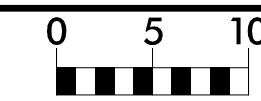

PROJ. REFERENCE NO.	SHEET NO.
I-5711	X-10

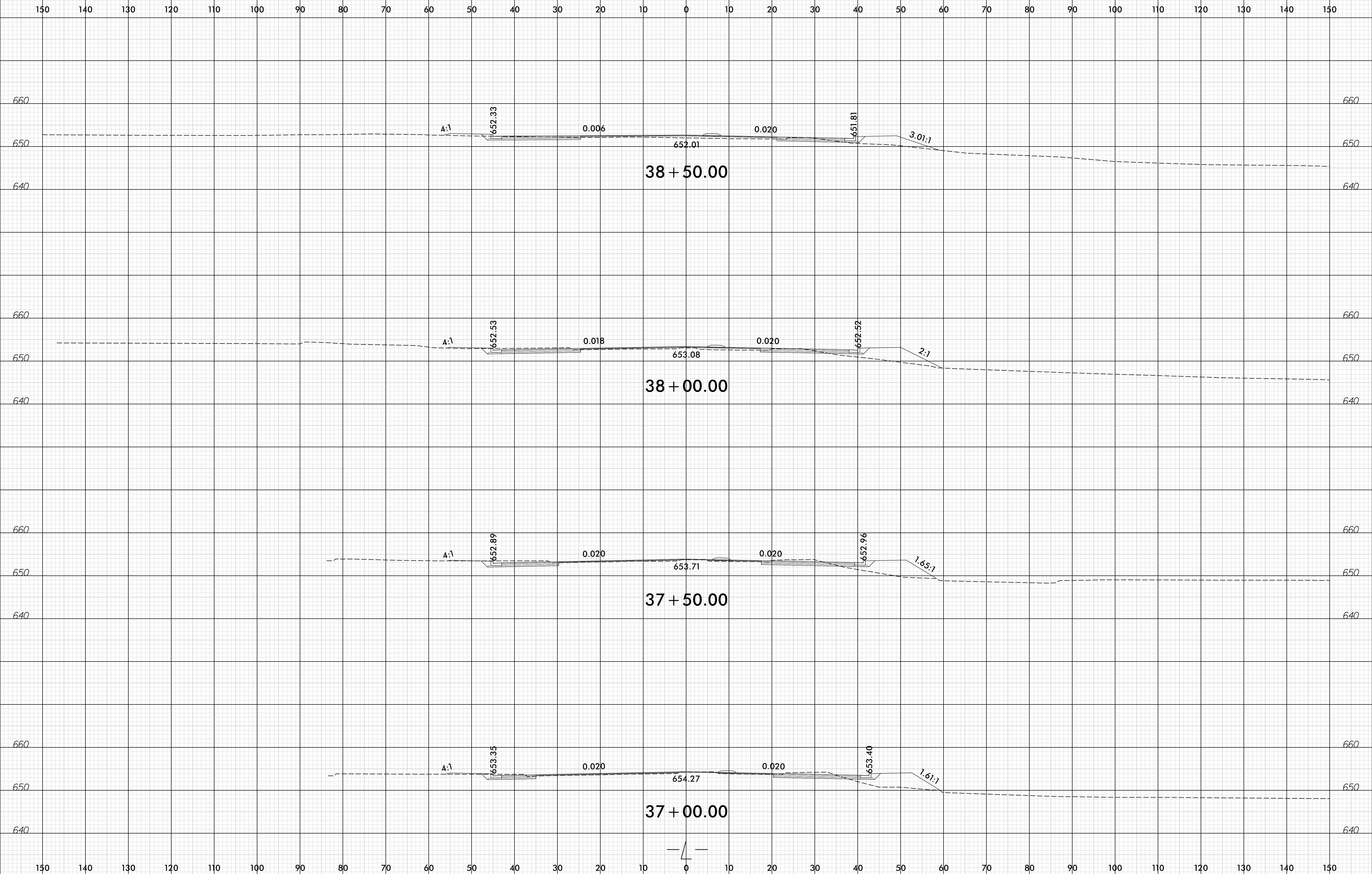

I:\2016\16\I-5711\RDY\_XPL.L.dgn

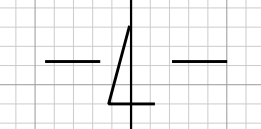

6/23/16

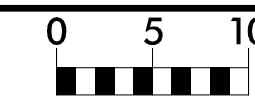

PROJ. REFERENCE NO.	SHEET NO.
I-5711	X-11

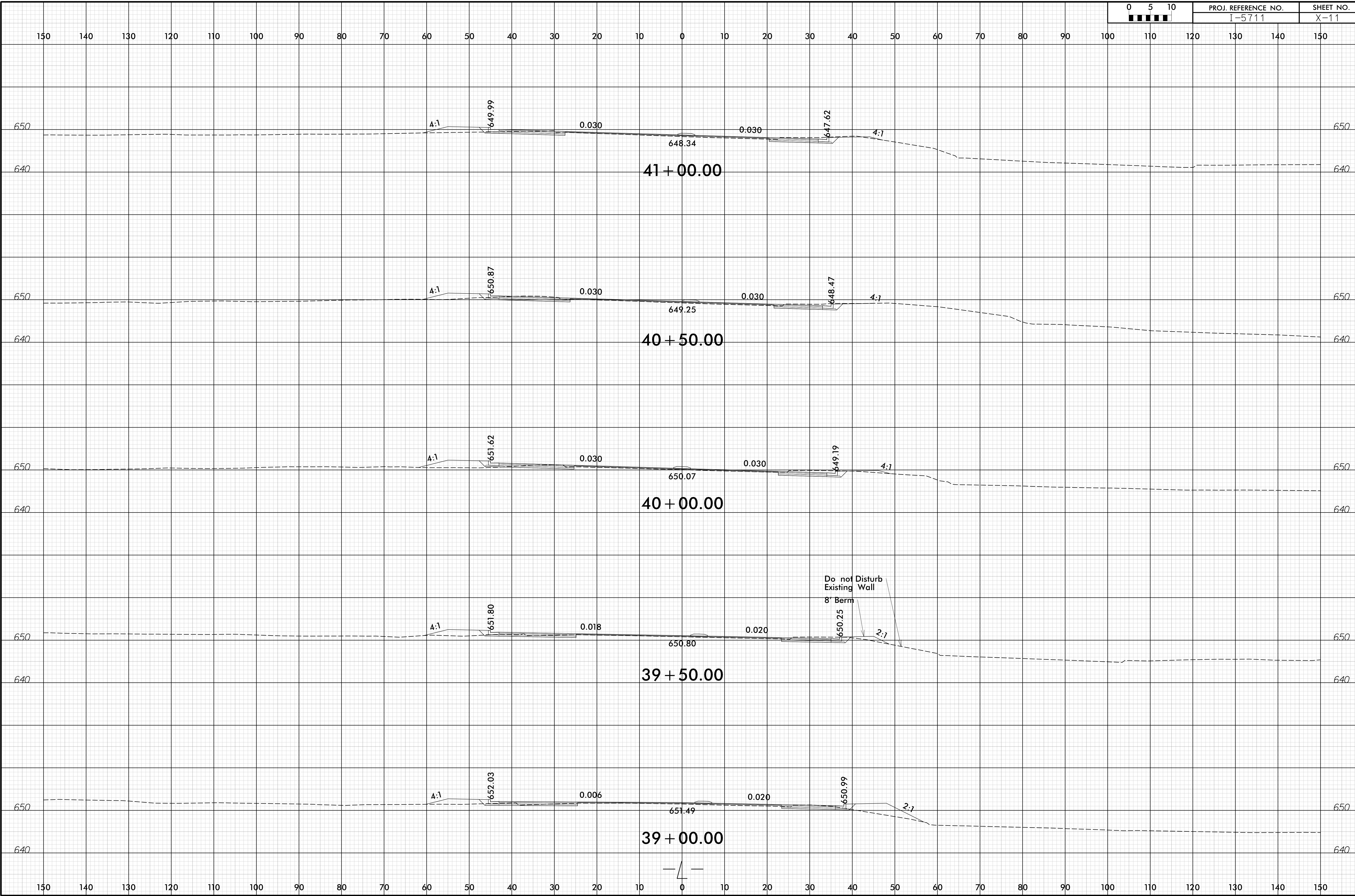

I:\2016\160623\160623.dgn

6/23/16

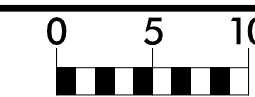

PROJ. REFERENCE NO.	SHEET NO.
I-5711	X-12

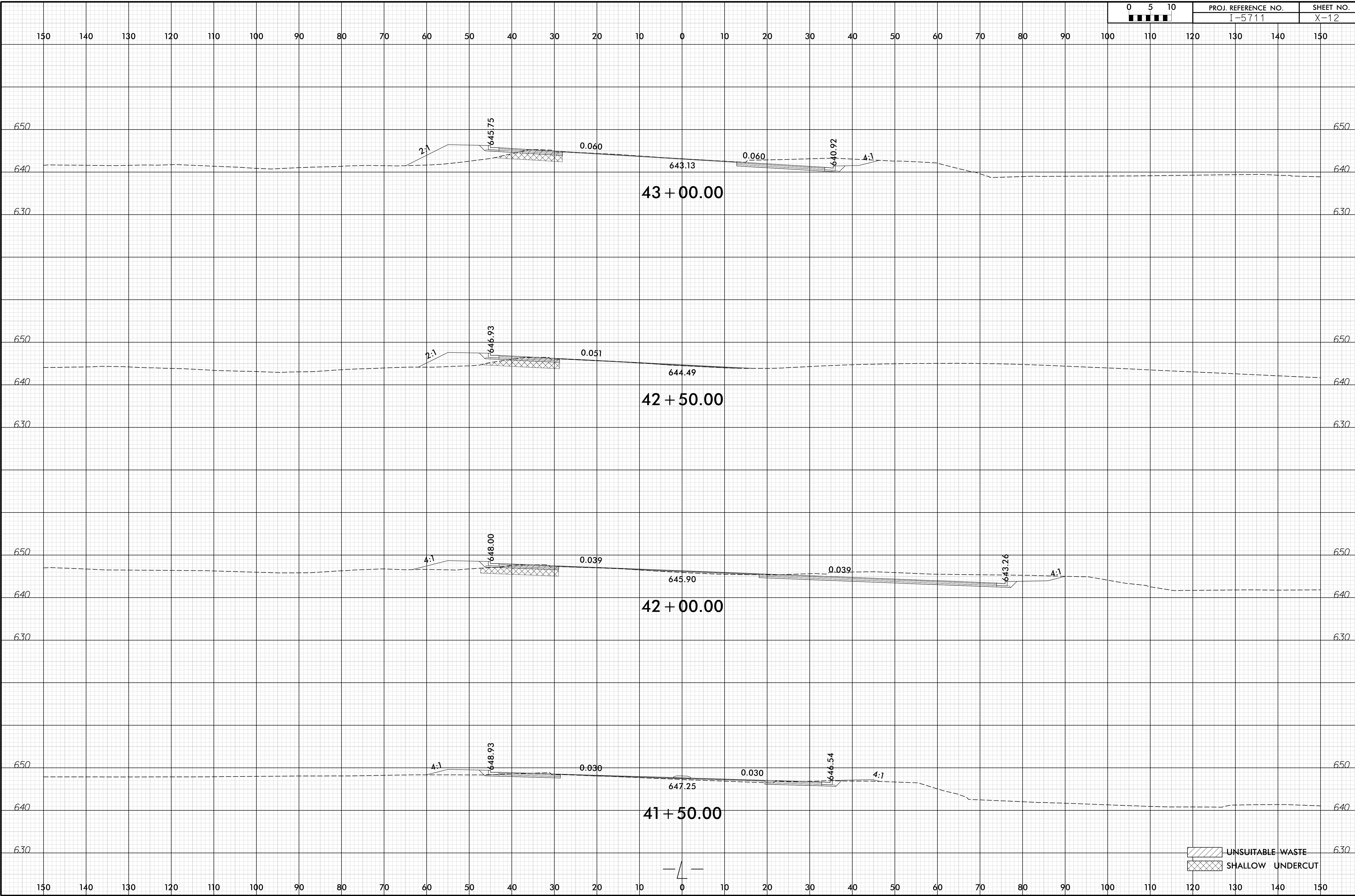

- UNSUITABLE WASTE
- SHALLOW UNDERCUT

I:\5711\RDY\_XPL.L.dgn

6/23/16

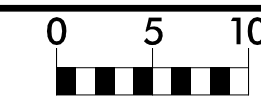

PROJ. REFERENCE NO.	SHEET NO.
I-5711	X-13

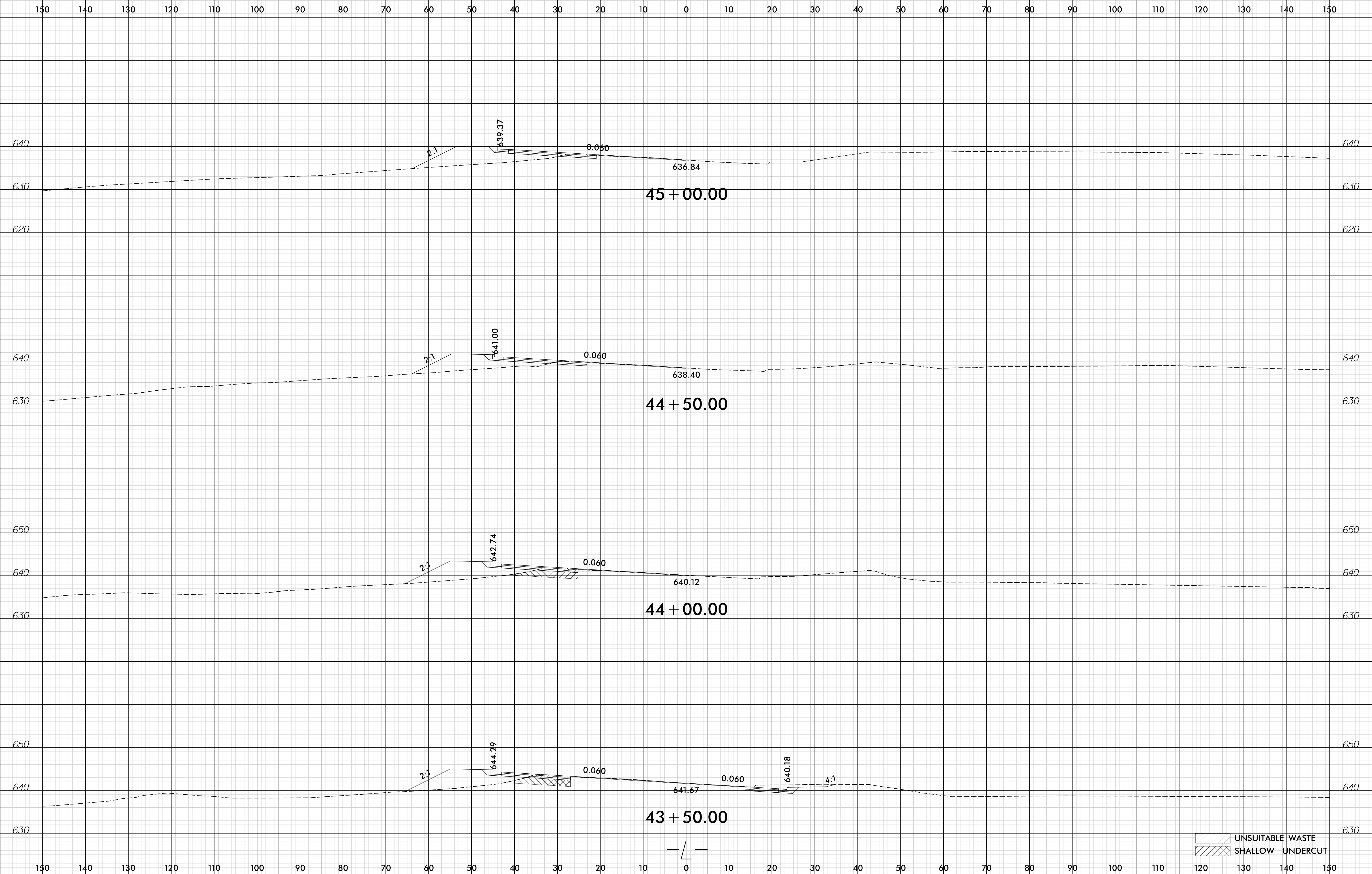

I-5711 RDY - XPL.L.dgn

- UNSUITABLE WASTE
- SHALLOW UNDERCUT

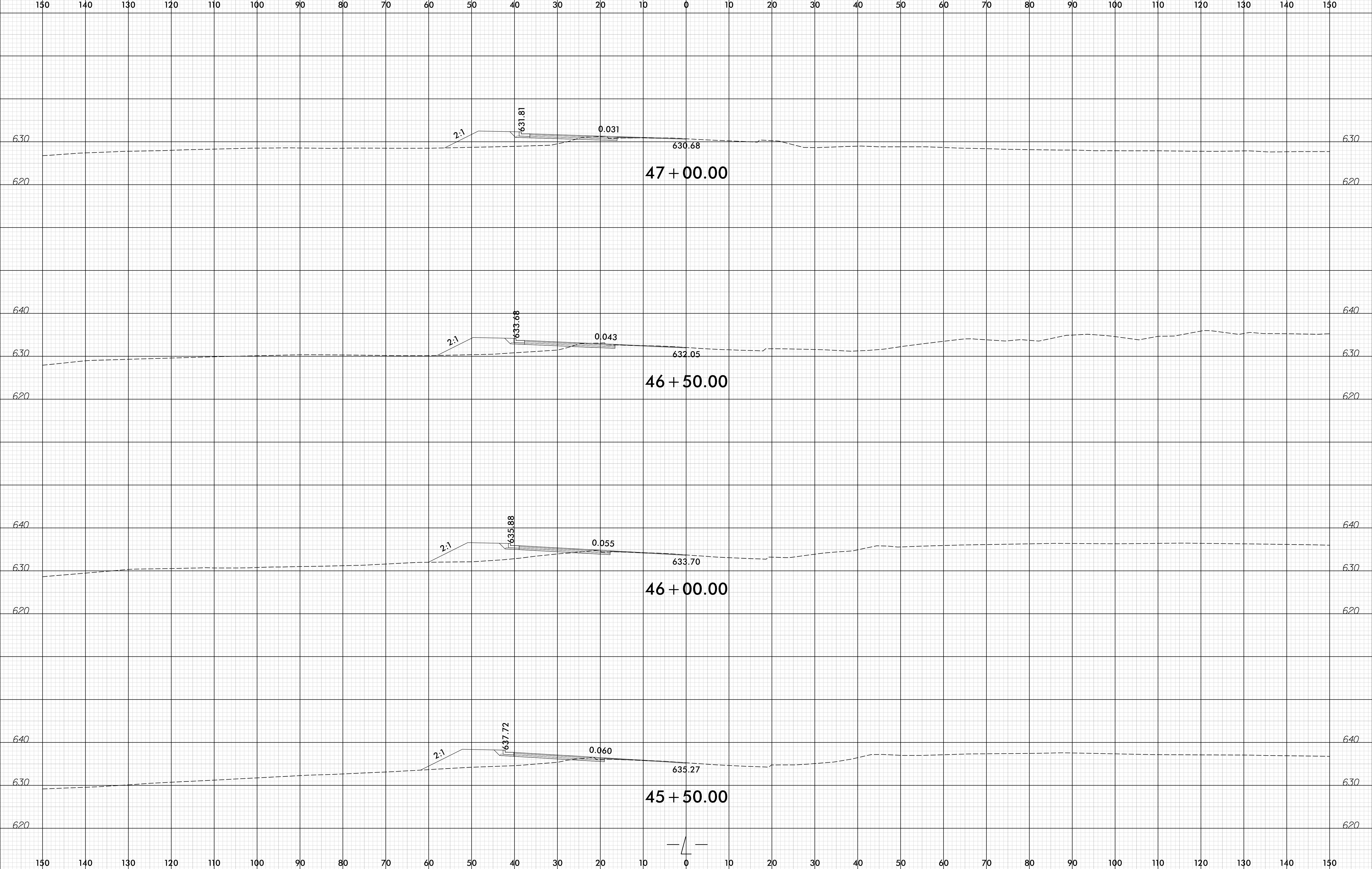



6/23/16

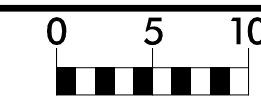

PROJ. REFERENCE NO.	SHEET NO.
I-5711	X-15

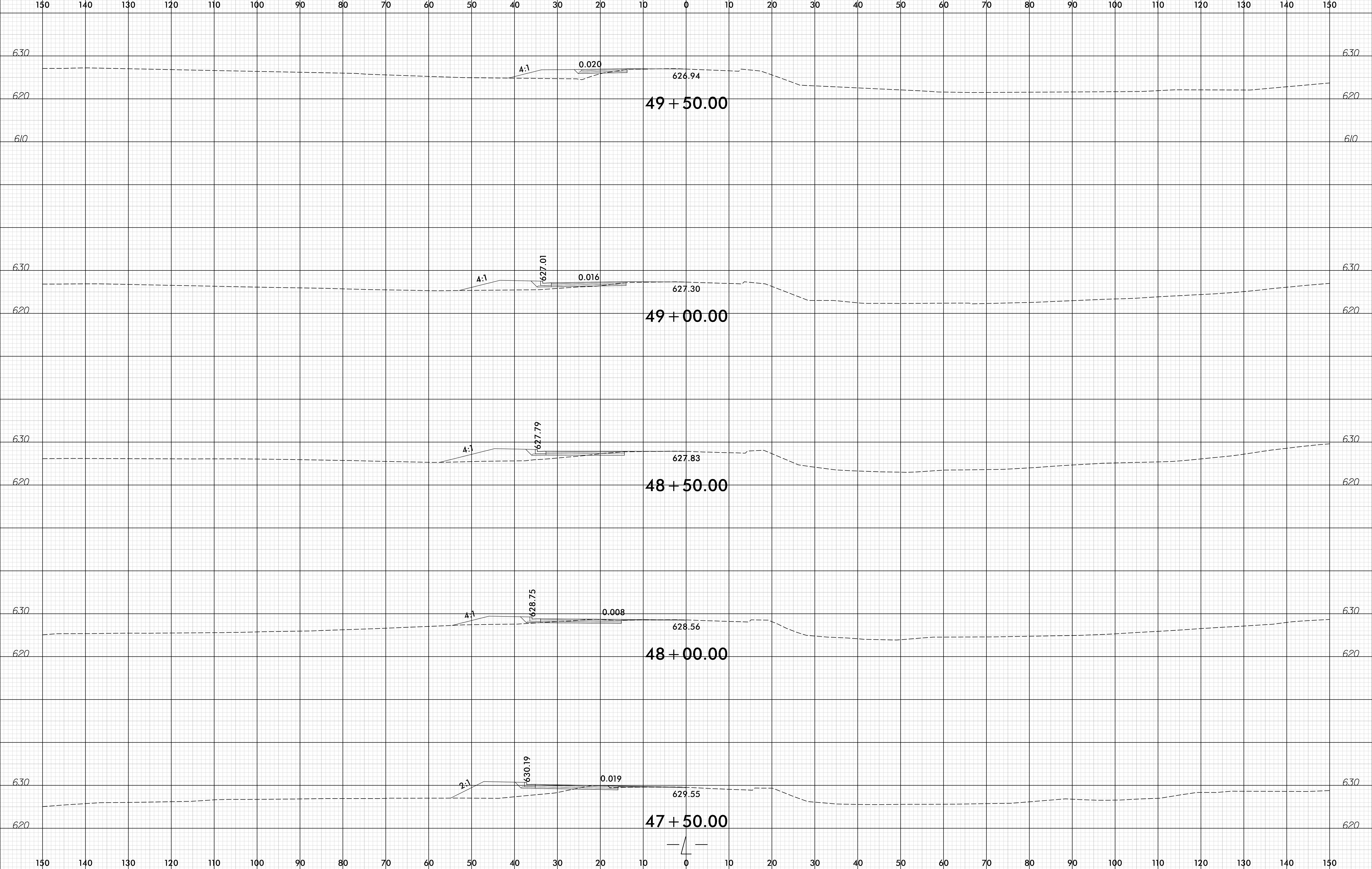

I:\2016\16\I-5711\RDY\_XPL.L.dgn

6/23/16

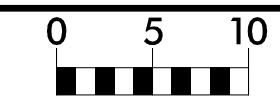

PROJ. REFERENCE NO.  
I-5711

SHEET NO.  
X-16

150 140 130 120 110 100 90 80 70 60 50 40 30 20 10 0 10 20 30 40 50 60 70 80 90 100 110 120 130 140 150

END PROJECT I-5711  
-L- STA. 50+00.00

626.61

50 + 00.00

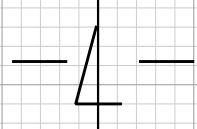

620

610

620

610

150 140 130 120 110 100 90 80 70 60 50 40 30 20 10 0 10 20 30 40 50 60 70 80 90 100 110 120 130 140 150

I:\2016\2016\I-5711\RDY\_XPL.L.dgn  
c:\pcc\teley

6/23/16

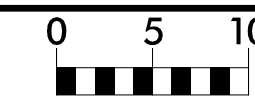

PROJ. REFERENCE NO.	I-5711
---------------------	--------

SHEET NO.	X-17
-----------	------

150 140 130 120 110 100 90 80 70 60 50 40 30 20 10 0 10 20 30 40 50 60 70 80 90 100 110 120 130 140 150

670 670

<sup>671.98</sup>  
**14 + 50.00**

660 660

670 670

<sup>672.15</sup>  
**14 + 00.00**

660 660

BEGIN CONSTRUCTION  
-Y- STA. 13+72.47

670 670

<sup>670.03</sup>  
**13 + 50.00**

660 660

660 660

<sup>664.46</sup>  
**13 + 00.00**

660 660

<sup>664.40</sup>  
**12 + 50.00**

650 650

-Y-

150 140 130 120 110 100 90 80 70 60 50 40 30 20 10 0 10 20 30 40 50 60 70 80 90 100 110 120 130 140 150

I:\2016\12\23\2016 I-5711 RDY - XPL - Y.dgn

6/23/16

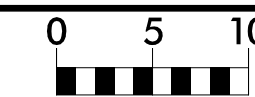

PROJ. REFERENCE NO.	SHEET NO.
I-5711	X-18

150 140 130 120 110 100 90 80 70 60 50 40 30 20 10 0 10 20 30 40 50 60 70 80 90 100 110 120 130 140 150

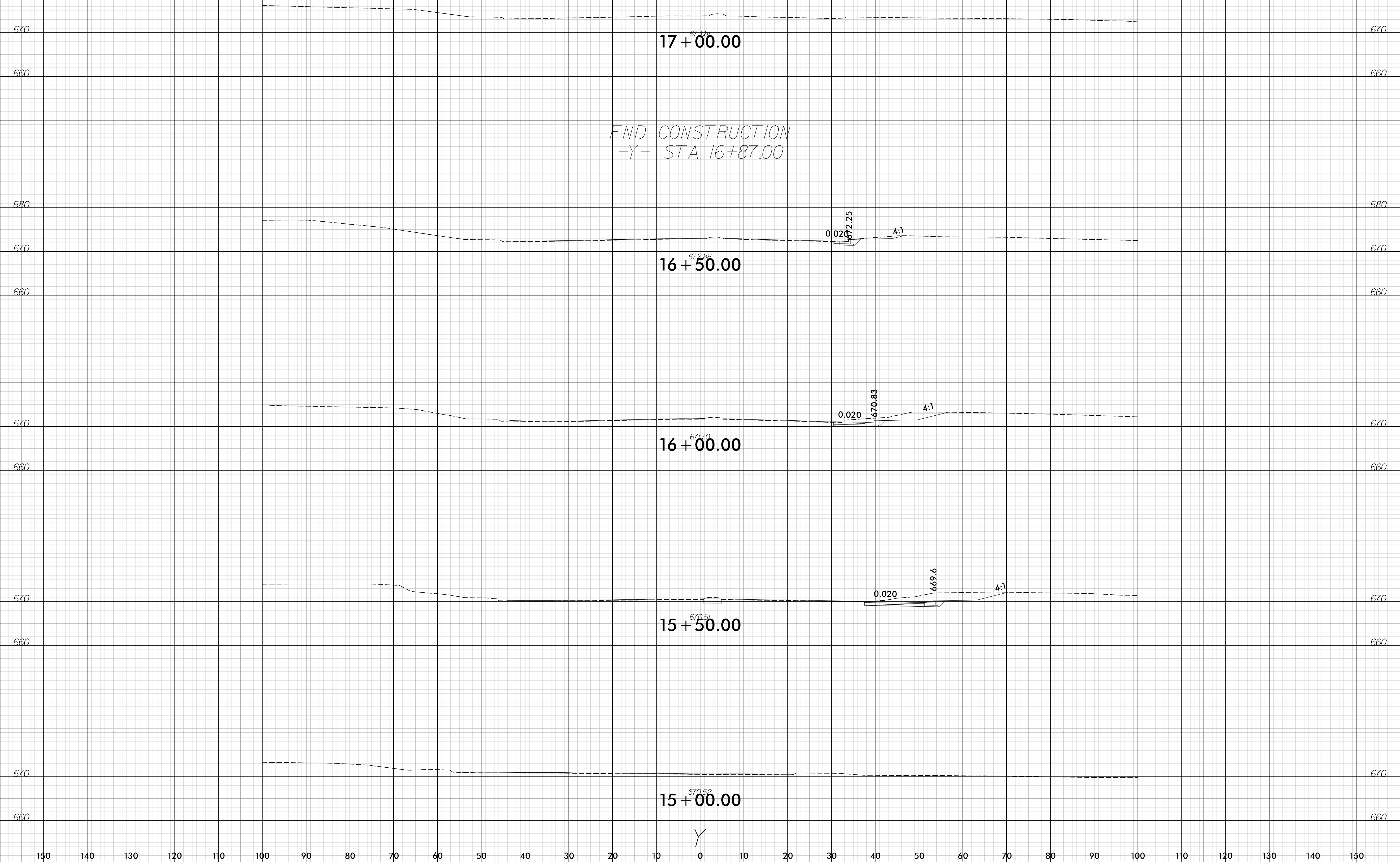

150 140 130 120 110 100 90 80 70 60 50 40 30 20 10 0 10 20 30 40 50 60 70 80 90 100 110 120 130 140 150

I:\2016\12\23\2016\I-5711\RDY\_XPL\_Y.dgn

6/23/16

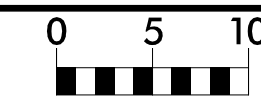

PROJ. REFERENCE NO.	SHEET NO.
I-5711	X-19

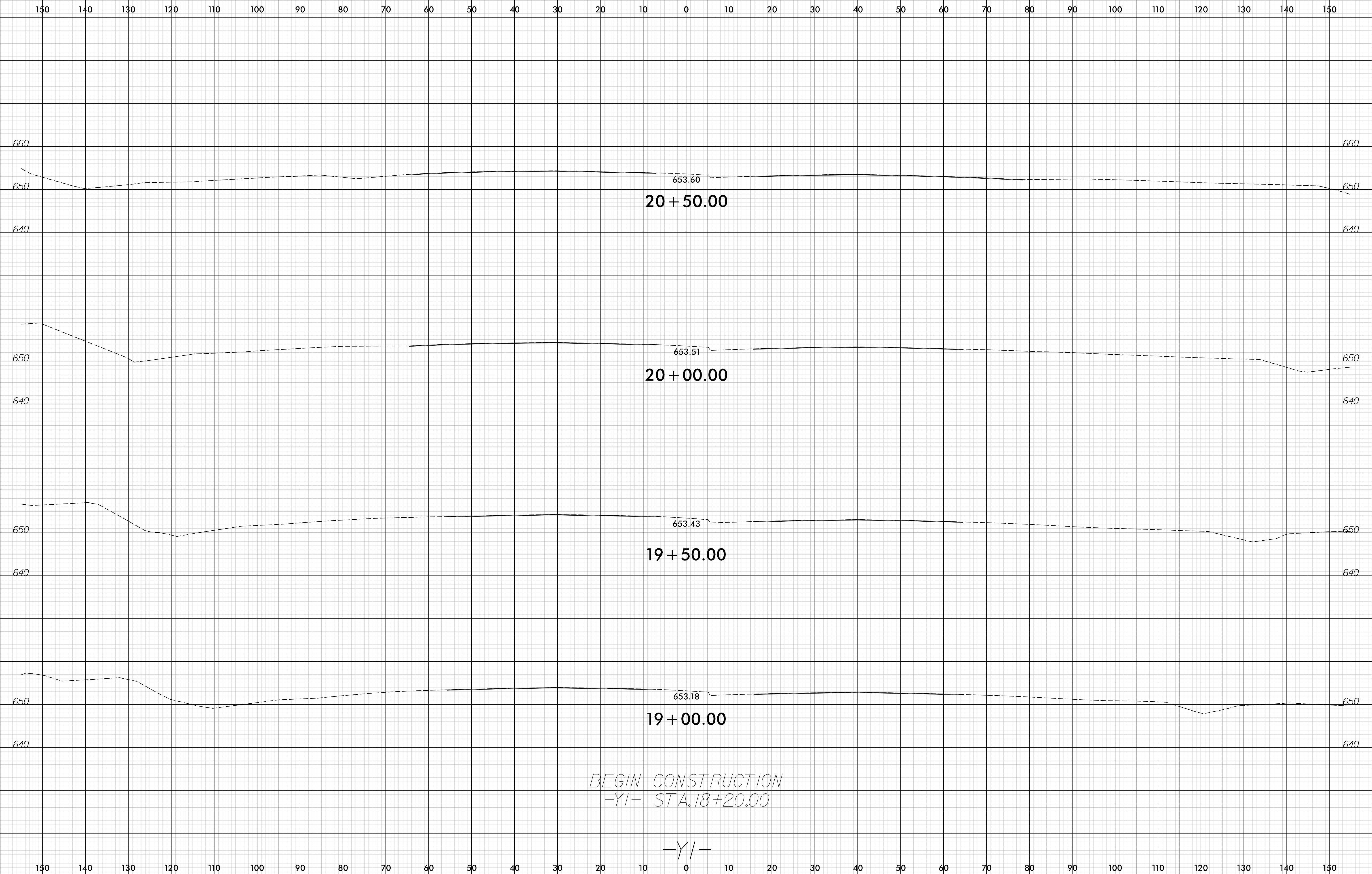

BEGIN CONSTRUCTION  
 -YI- STA. 18+20.00

-YI-

I:\2016\2016\I-5711\RDY\_XPL\_Y1.dgn  
 6/23/16

6/23/16

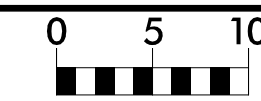

PROJ. REFERENCE NO.	SHEET NO.
I-5711	X-20

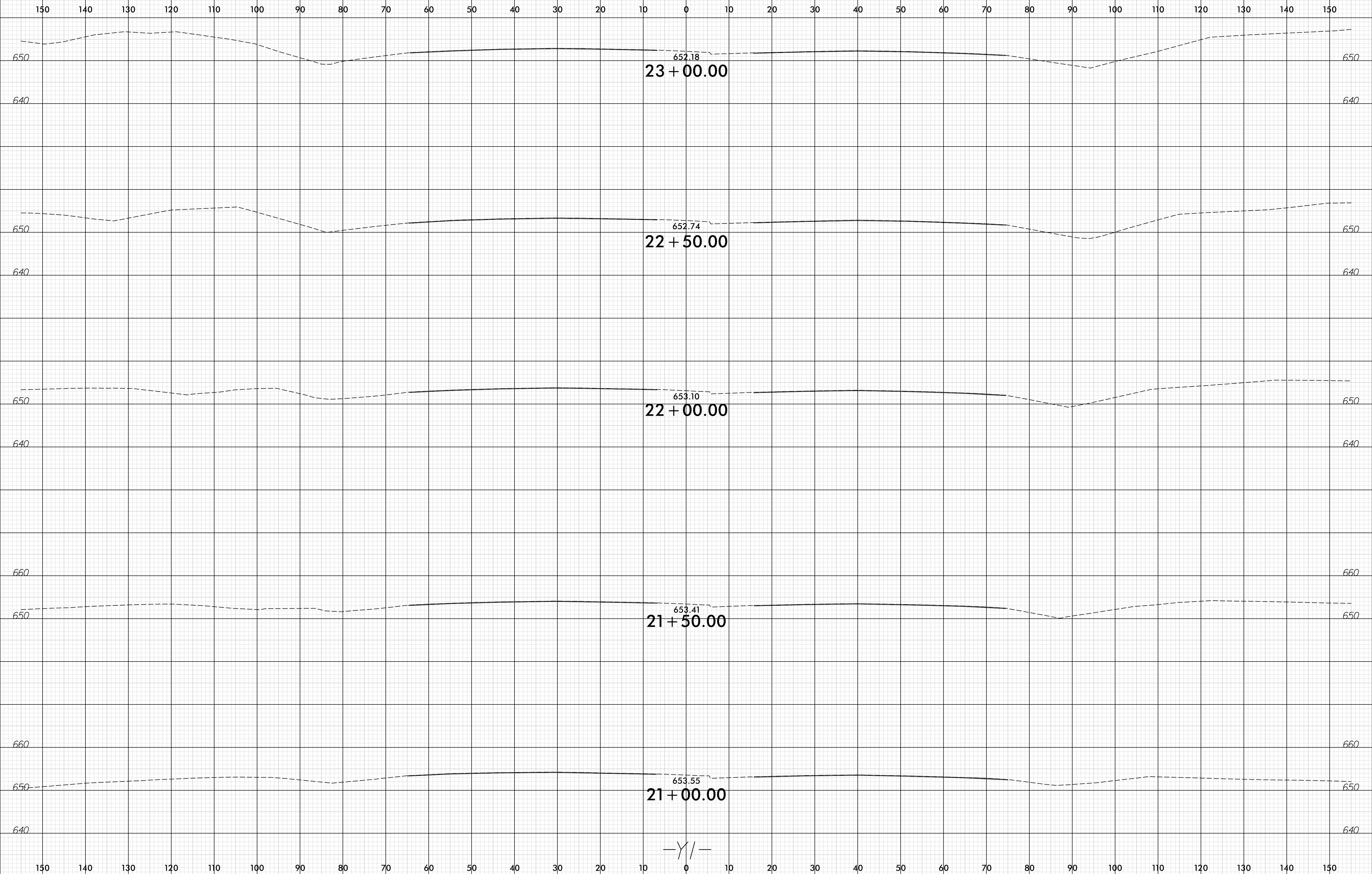

I:\2016\2016\I-5711\RDY\_XPL\_Y1.dgn

-Y/-

6/23/16

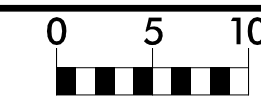

PROJ. REFERENCE NO.	SHEET NO.
I-5711	X-21

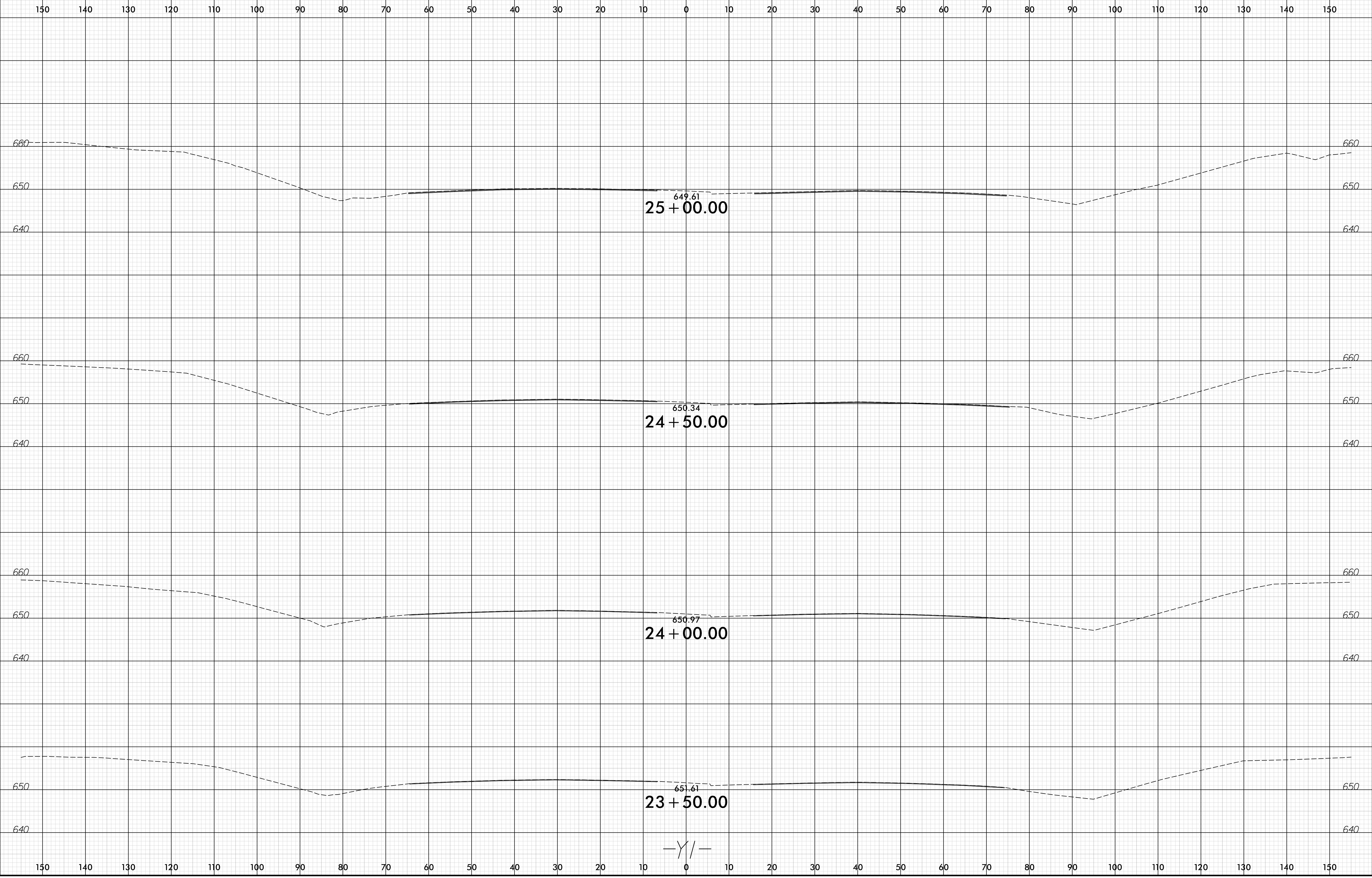

I:\2016\2016\I-5711\RDY\_XPL\_Y1.dgn

-Y/-

6/23/16

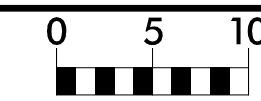

PROJ. REFERENCE NO.	SHEET NO.
I-5711	X-22

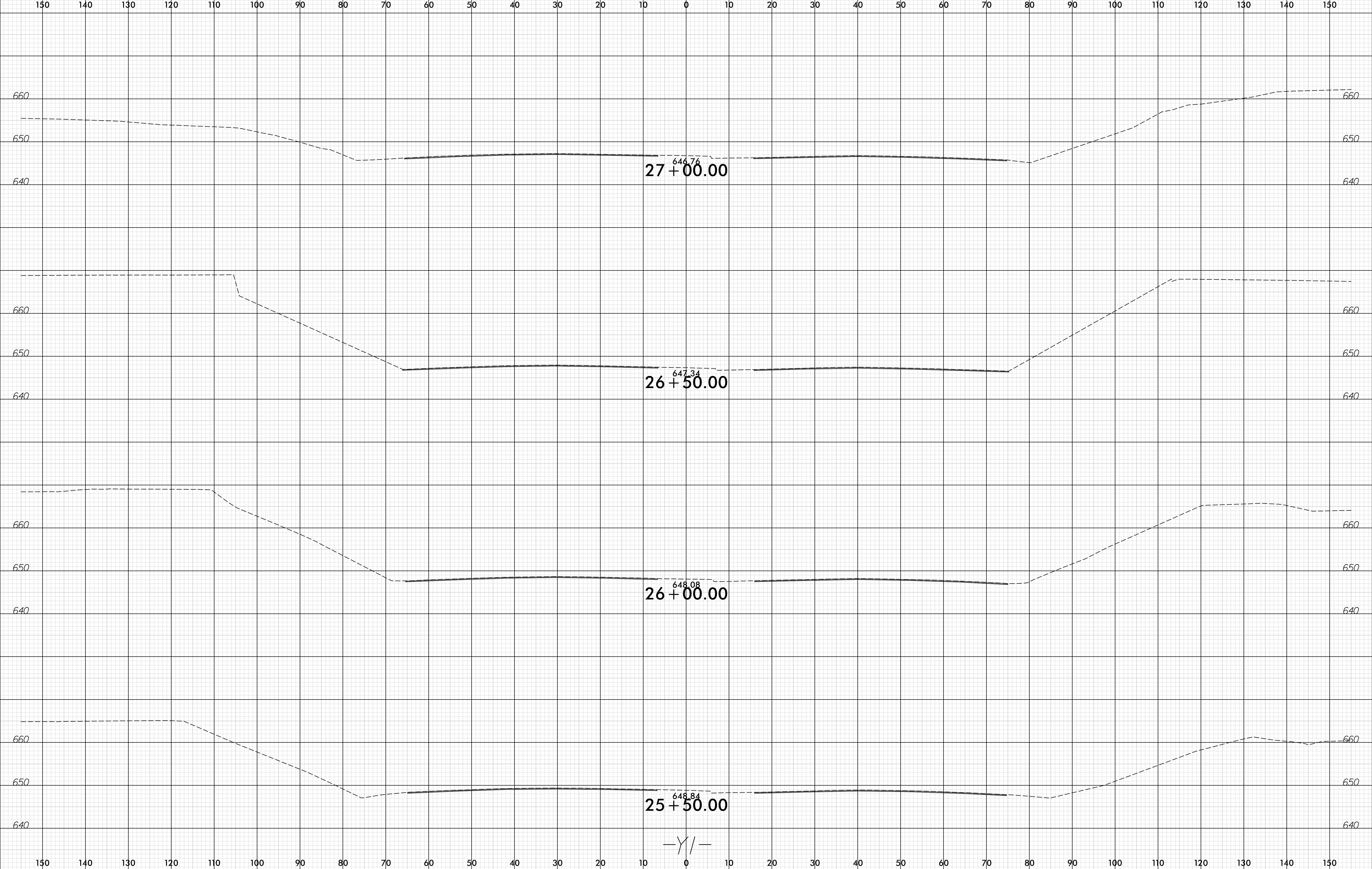

I:\2016\16\I-5711\RDY\_XPL\_Y1.dgn

-Y/-



6/23/16

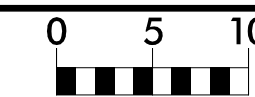

PROJ. REFERENCE NO.	SHEET NO.
I-5711	X-23

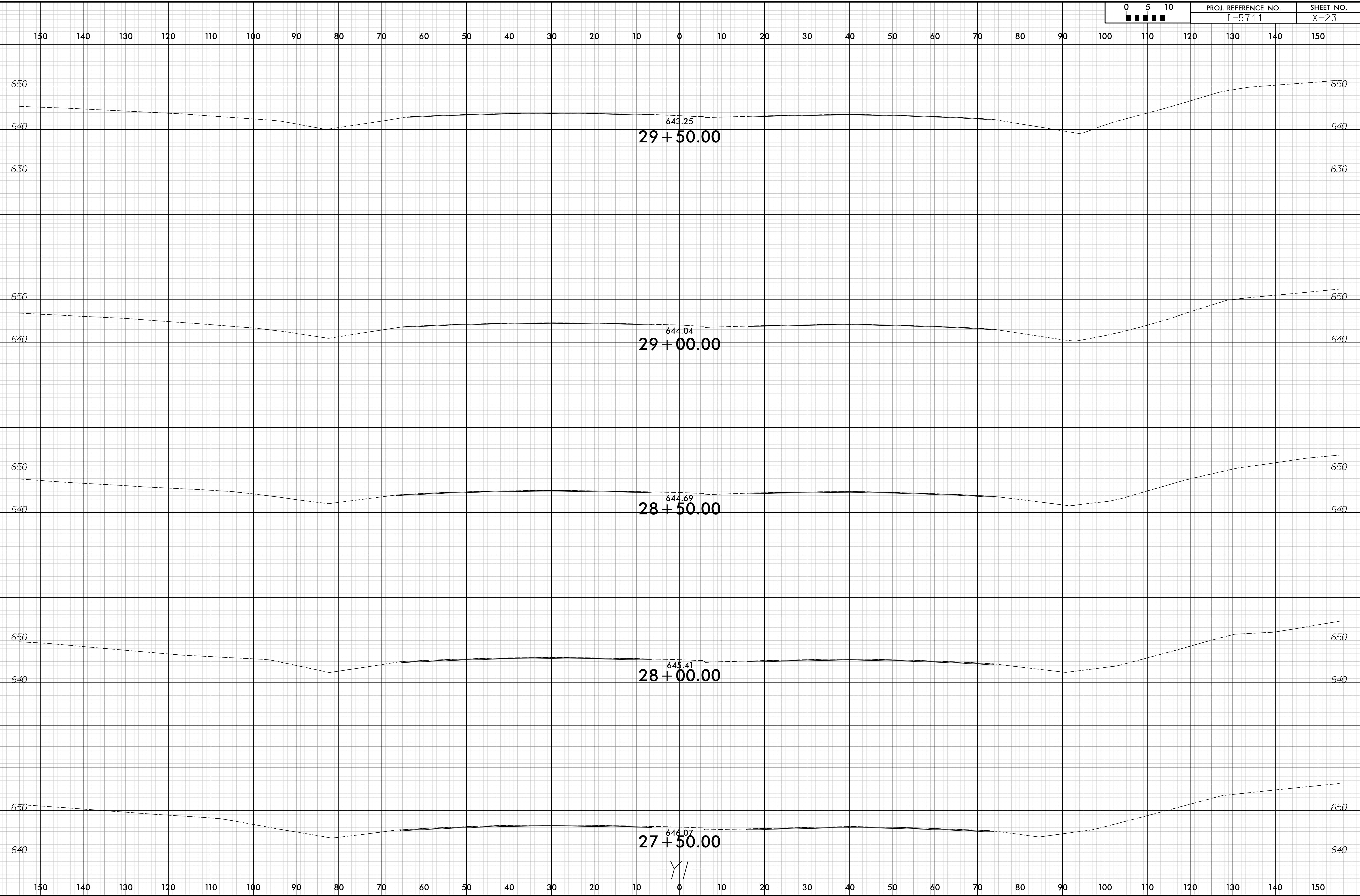

I:\2016\I-5711\RDY\_XPL\_Y1.dgn

—Y/—

6/23/16

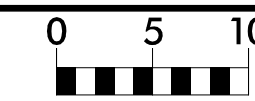

PROJ. REFERENCE NO.	SHEET NO.
I-5711	X-24

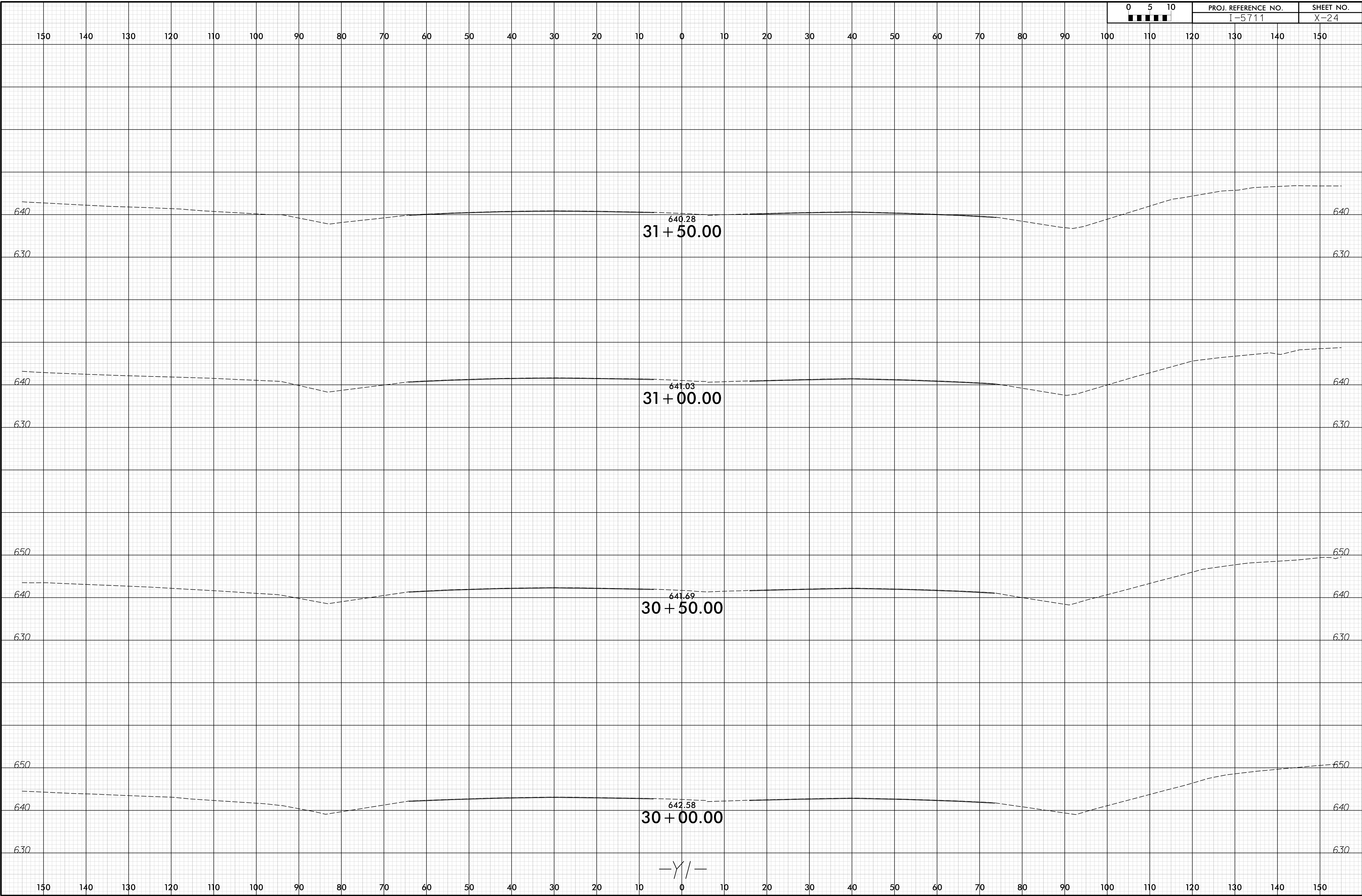

I:\2016\16-06\I-5711\RDY\_XPL\_Y1.dgn

6/23/16

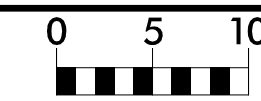

PROJ. REFERENCE NO.	SHEET NO.
I-5711	X-25

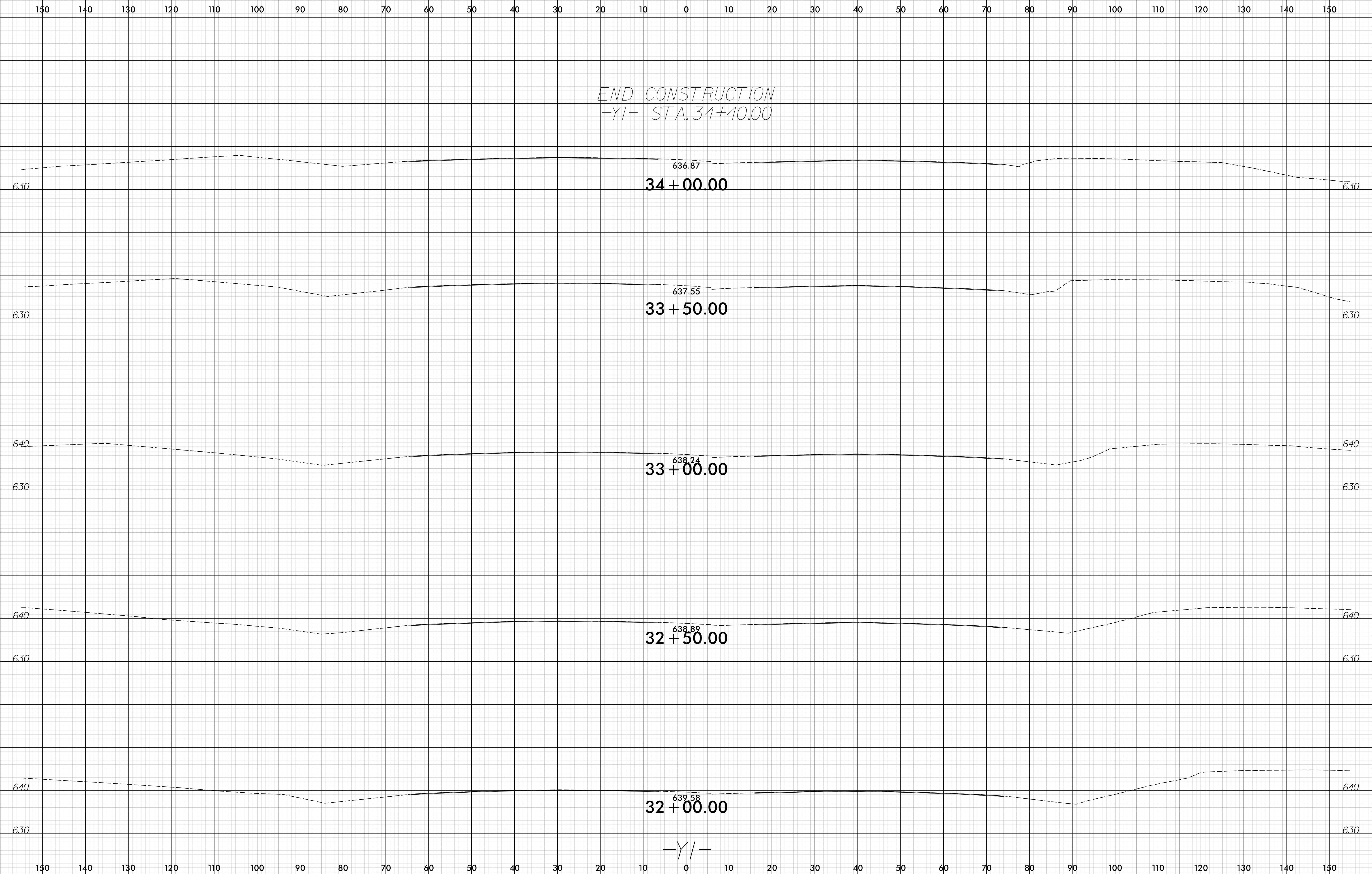

END CONSTRUCTION  
-YI- STA. 34+40.00

I:\2016\12\21\2016 I-5711 RDY - XPL - Y1.dgn  
6/23/16

-YI-

6/23/16

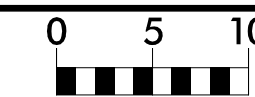

PROJ. REFERENCE NO.	SHEET NO.
I-5711	X-26

150 140 130 120 110 100 90 80 70 60 50 40 30 20 10 0 10 20 30 40 50 60 70 80 90 100 110 120 130 140 150

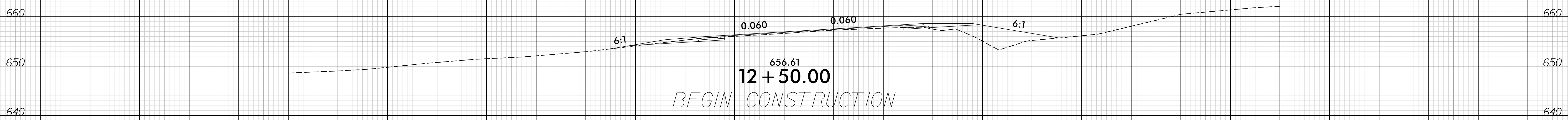
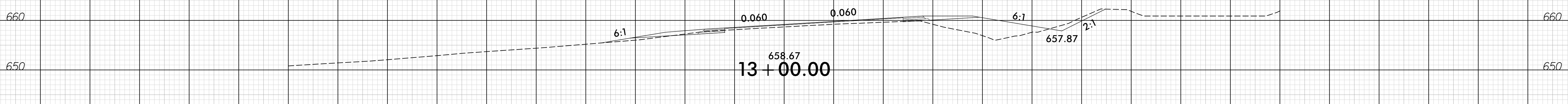
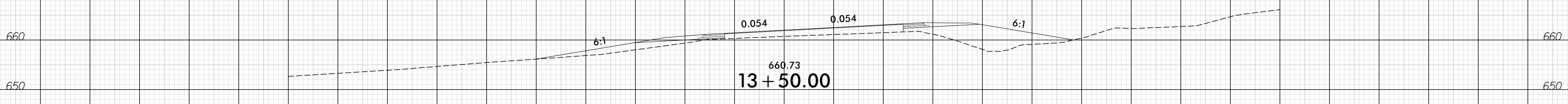
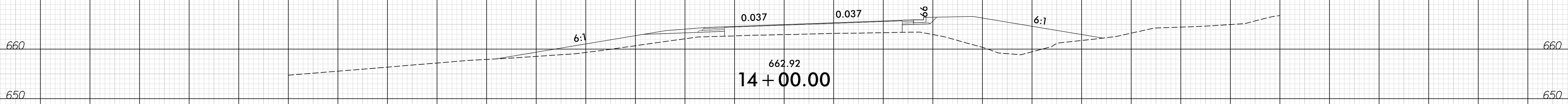

-RPA\_YI-

I:\2016\2016\I-5711\RDY\_XPL\_RPA\_YI.dgn

150 140 130 120 110 100 90 80 70 60 50 40 30 20 10 0 10 20 30 40 50 60 70 80 90 100 110 120 130 140 150

6/23/16

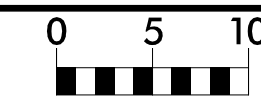

PROJ. REFERENCE NO.  
I-5711

SHEET NO.  
X-27

150 140 130 120 110 100 90 80 70 60 50 40 30 20 10 0 10 20 30 40 50 60 70 80 90 100 110 120 130 140 150

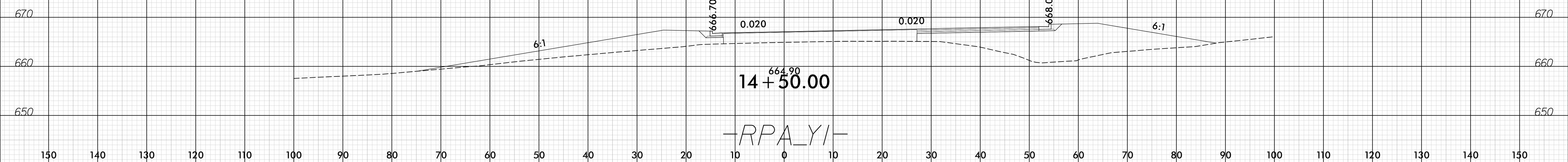

I:\2016\16\6\23\16\I-5711\RDY\_XPL\_RPA\_YI.dgn

150 140 130 120 110 100 90 80 70 60 50 40 30 20 10 0 10 20 30 40 50 60 70 80 90 100 110 120 130 140 150

6/23/16

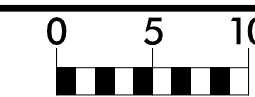

PROJ. REFERENCE NO.	SHEET NO.
I-5711	X-28

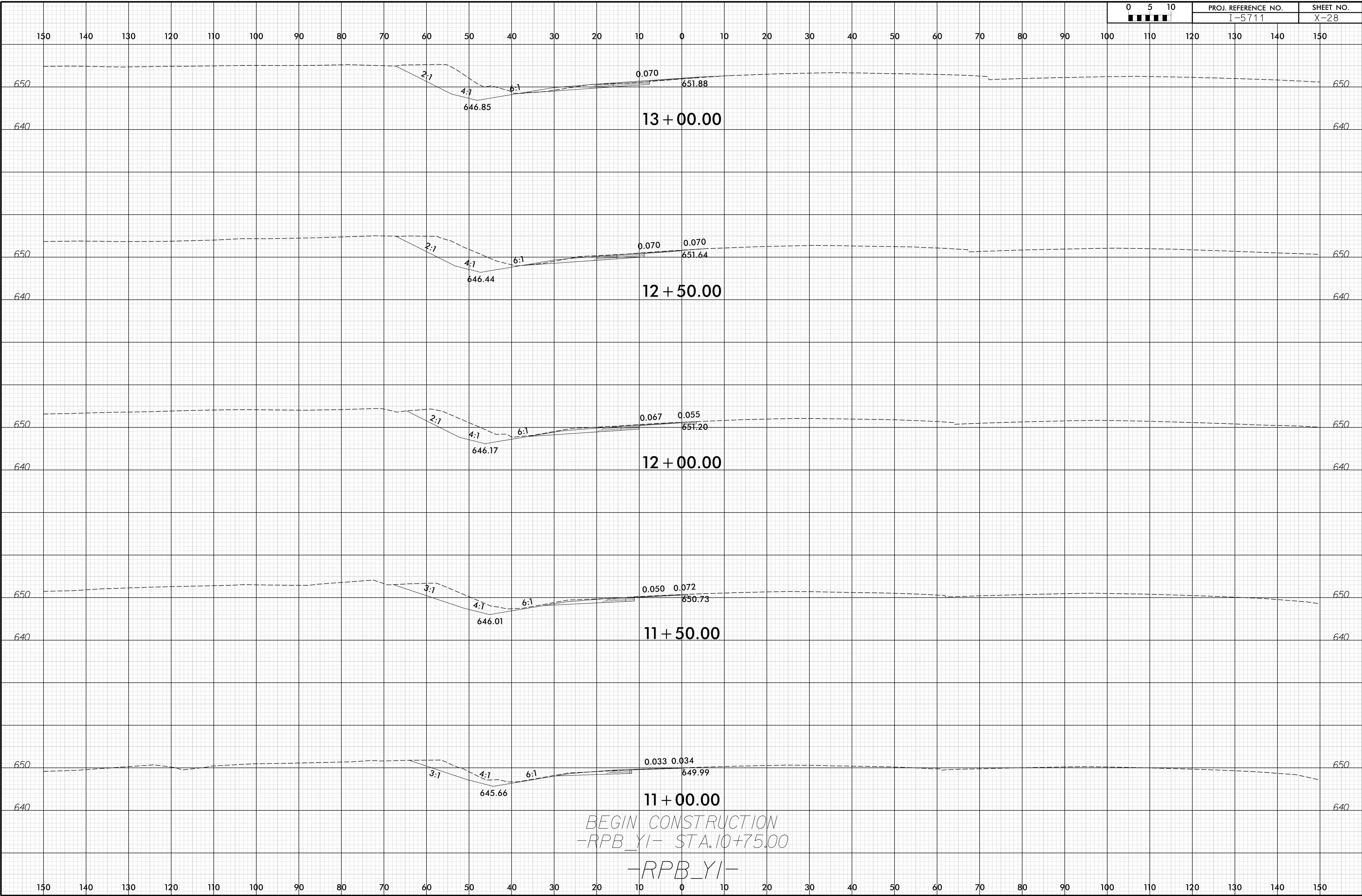

I:\2016\2016\I-5711\RDY\_XPL\_RPB\_YI.dgn

150 140 130 120 110 100 90 80 70 60 50 40 30 20 10 0 10 20 30 40 50 60 70 80 90 100 110 120 130 140 150

6/23/16

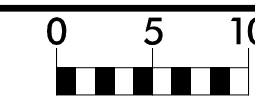

PROJ. REFERENCE NO.	SHEET NO.
I-5711	X-29

150 140 130 120 110 100 90 80 70 60 50 40 30 20 10 0 10 20 30 40 50 60 70 80 90 100 110 120 130 140 150

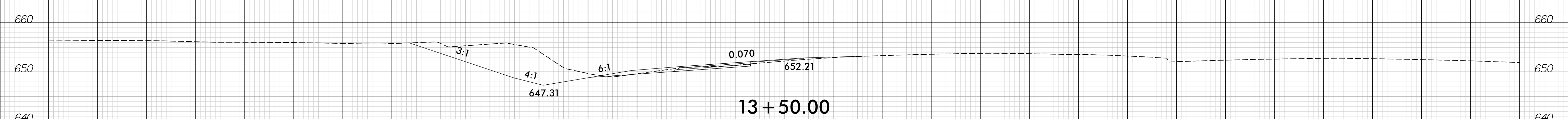
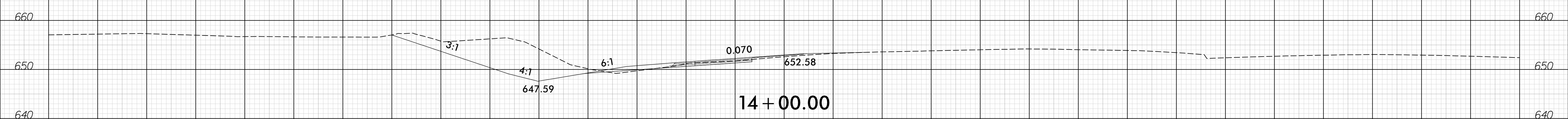
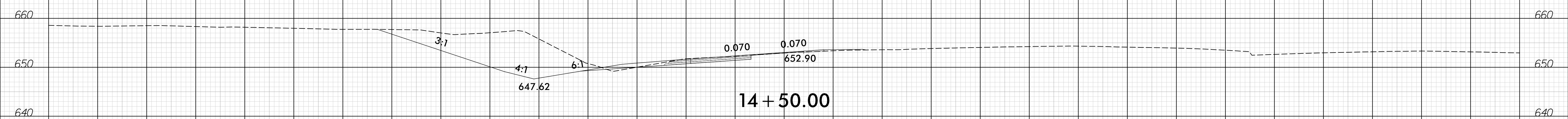
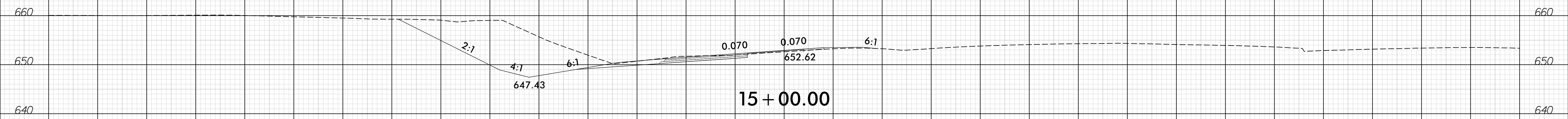

-RPB\_YI-

I:\2016\16\I-5711\RDY\_XPL\_RPB\_YI.dgn

150 140 130 120 110 100 90 80 70 60 50 40 30 20 10 0 10 20 30 40 50 60 70 80 90 100 110 120 130 140 150

6/23/16

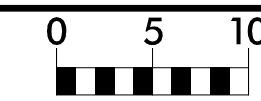

PROJ. REFERENCE NO.	SHEET NO.
I-5711	X-30

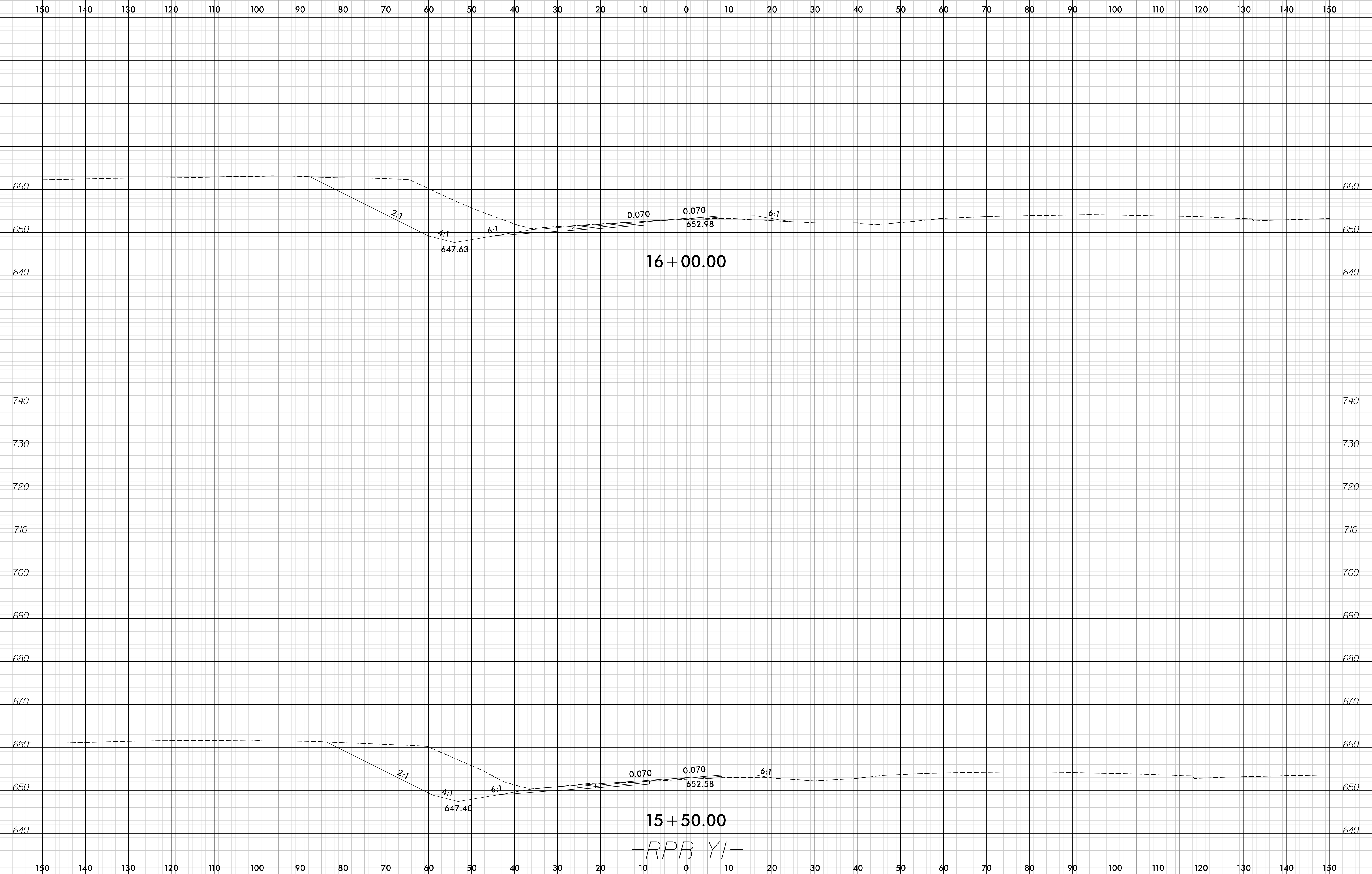

I:\2016\16\I-5711\RDY\_XPL\_RPB\_YI.dgn



6/23/16

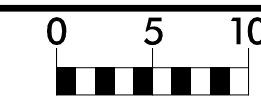

PROJ. REFERENCE NO.	SHEET NO.
I-5711	X-31

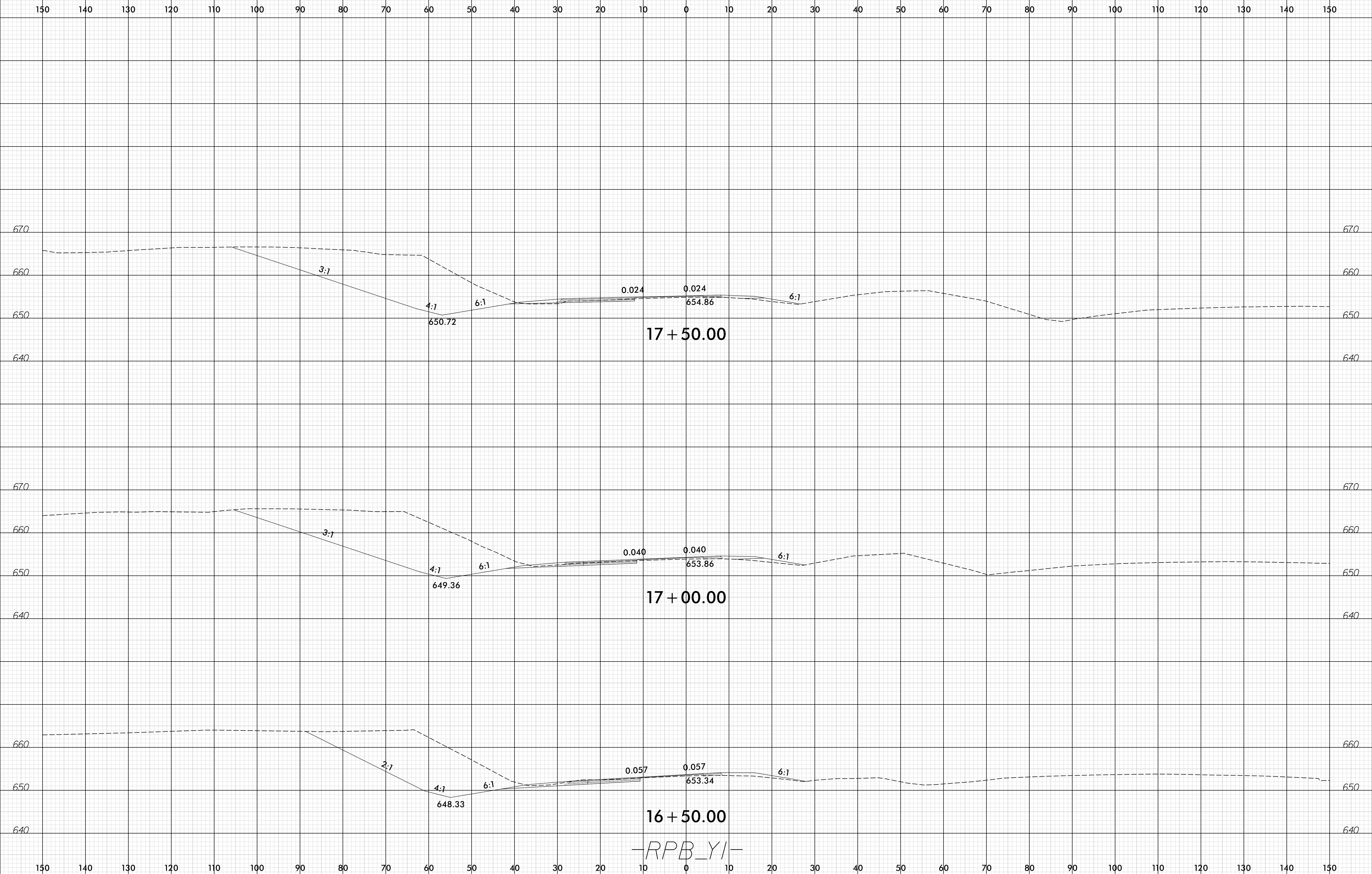

-RPB\_YI-

I:\2016\2016\I-5711\RDY\_XPL\_RPB\_YI.dgn

6/23/16

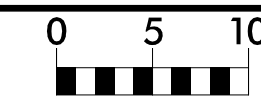

PROJ. REFERENCE NO.	SHEET NO.
I-5711	X-32

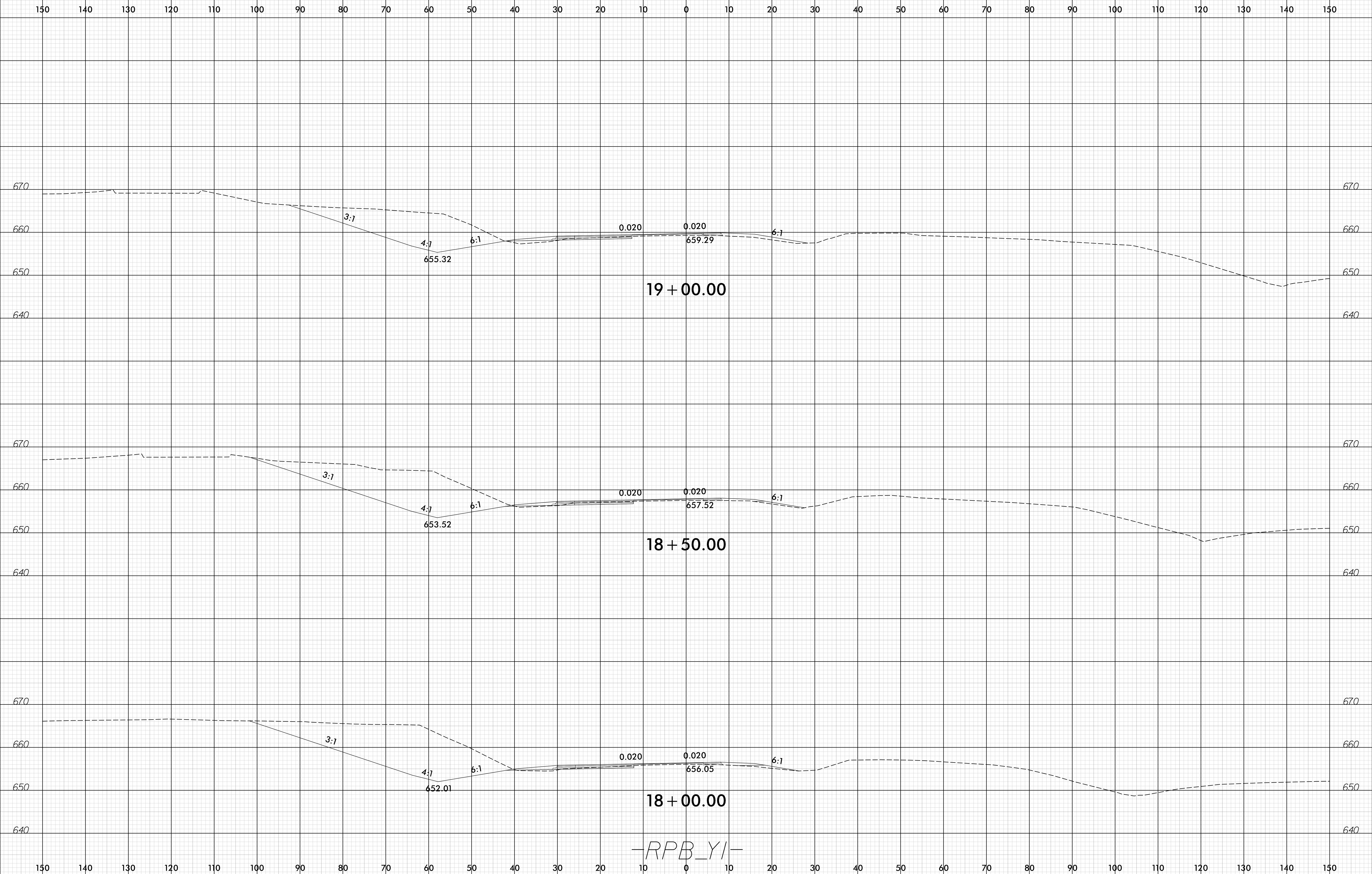

-RPB\_YI-

I:\2016\16\I-5711\RDY\_XPL\_RPB\_YI.dgn

6/23/16

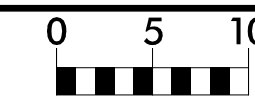

PROJ. REFERENCE NO.	SHEET NO.
I-5711	X-33

150 140 130 120 110 100 90 80 70 60 50 40 30 20 10 0 10 20 30 40 50 60 70 80 90 100 110 120 130 140 150

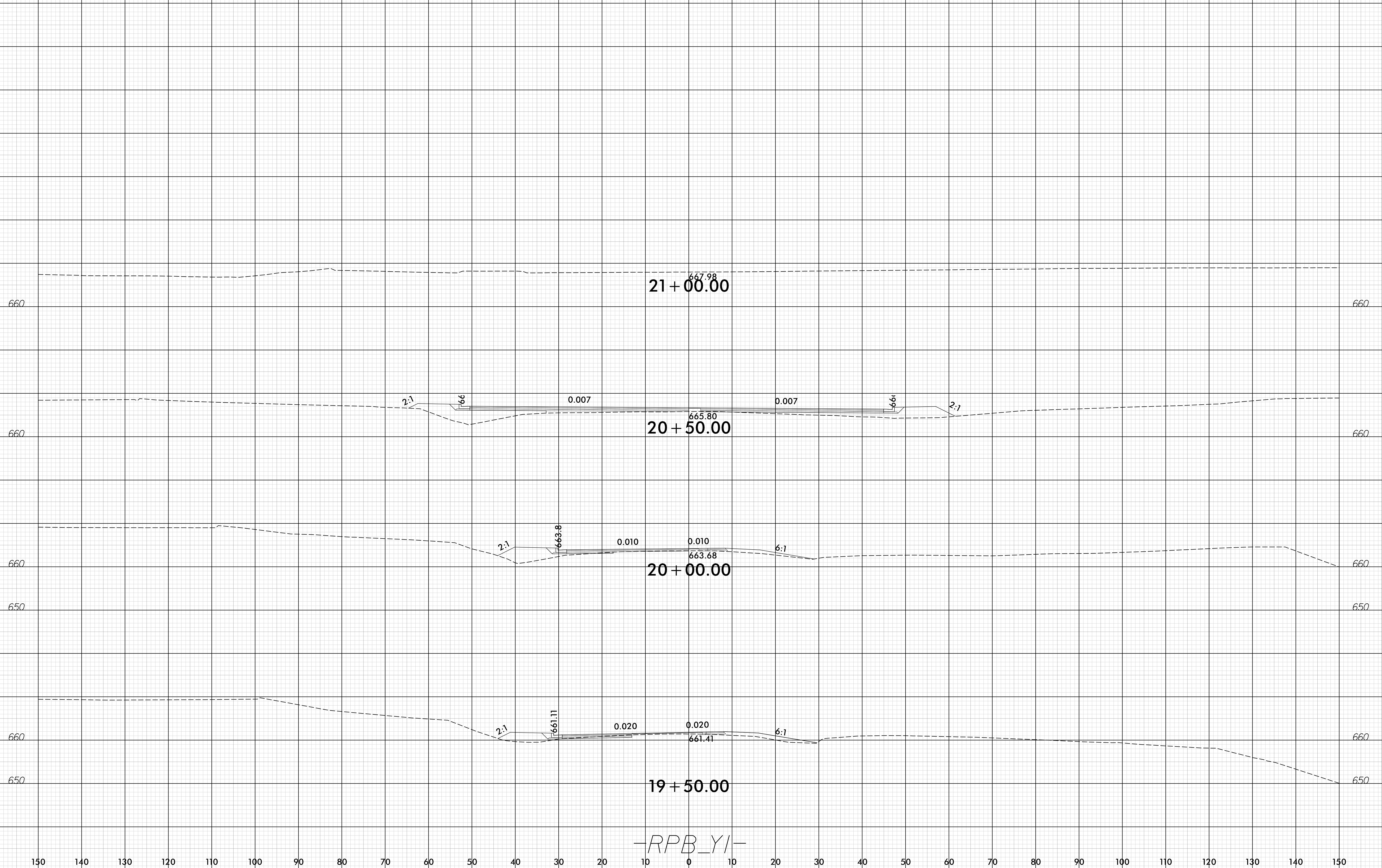

-RPB\_YI-

I:\2016\16\I-5711\RDY\_XPL\_RPB\_YI.dgn  
6/23/16

6/23/16

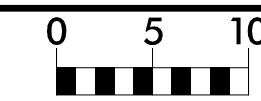

PROJ. REFERENCE NO.	I-5711
---------------------	--------

SHEET NO.	X-34
-----------	------

150 140 130 120 110 100 90 80 70 60 50 40 30 20 10 0 10 20 30 40 50 60 70 80 90 100 110 120 130 140 150

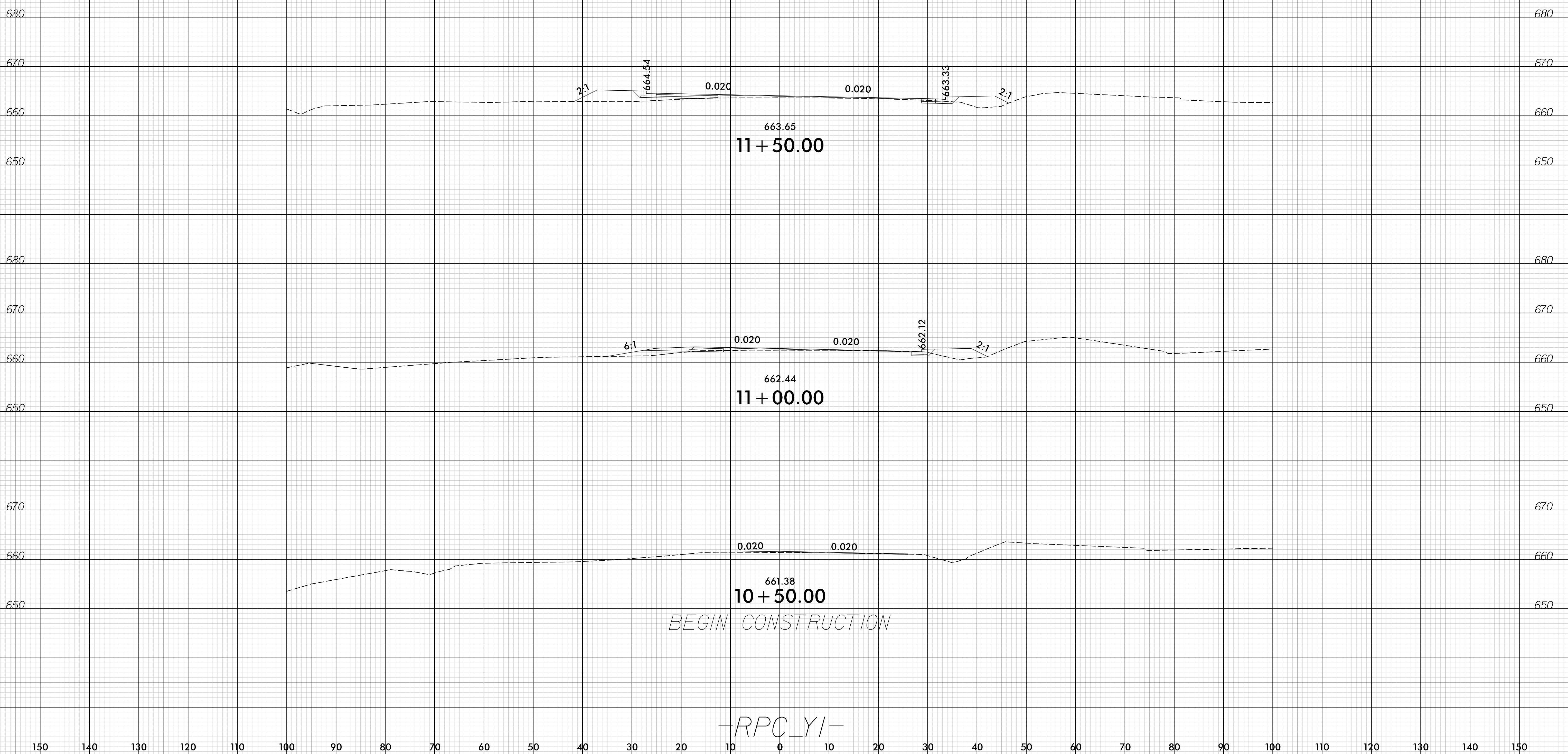

BEGIN CONSTRUCTION

-RPC\_YI-

I:\2016\2016\1-5711\RDY\_XPL\_RPC\_YI.dgn  
 6/23/16

6/23/16

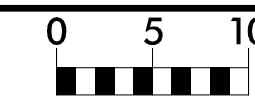

PROJ. REFERENCE NO.  
I-5711

SHEET NO.  
X-35

150 140 130 120 110 100 90 80 70 60 50 40 30 20 10 0 10 20 30 40 50 60 70 80 90 100 110 120 130 140 150

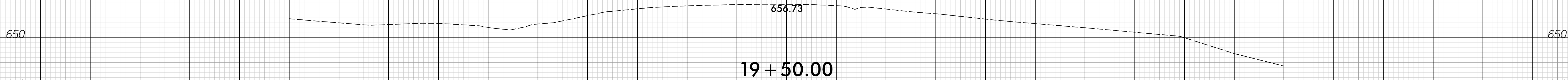
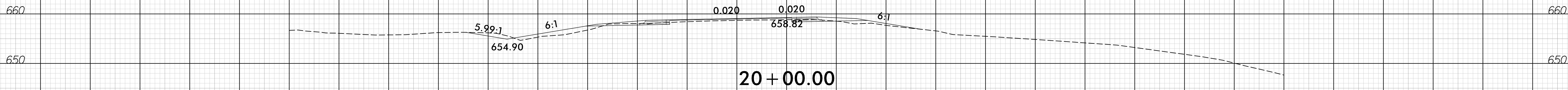
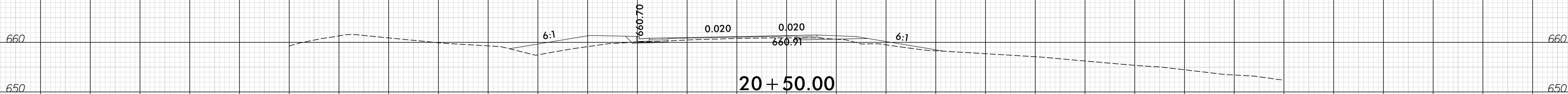
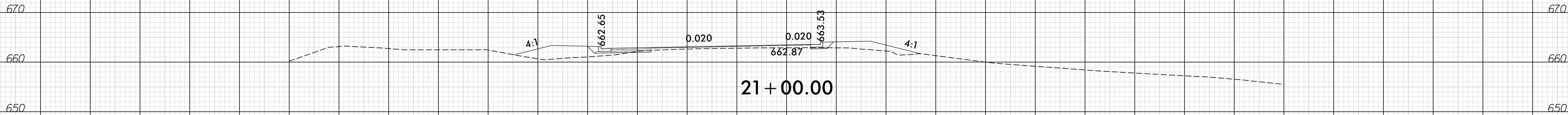

BEGIN CONSTRUCTION  
 -RPD\_YI- STA. 12+00.00  
 1.5" OVERLAY FROM 12+00.00 TO 19+80.00

-RPD\_YI-

150 140 130 120 110 100 90 80 70 60 50 40 30 20 10 0 10 20 30 40 50 60 70 80 90 100 110 120 130 140 150

I:\2016\12\23\2016\12\23\16\1-5711\RDY\_XPL\_RPD\_YI.dgn

6/23/16

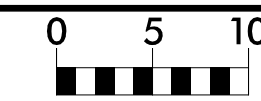

PROJ. REFERENCE NO.	I-5711
---------------------	--------

SHEET NO.	X-36
-----------	------

150 140 130 120 110 100 90 80 70 60 50 40 30 20 10 0 10 20 30 40 50 60 70 80 90 100 110 120 130 140 150

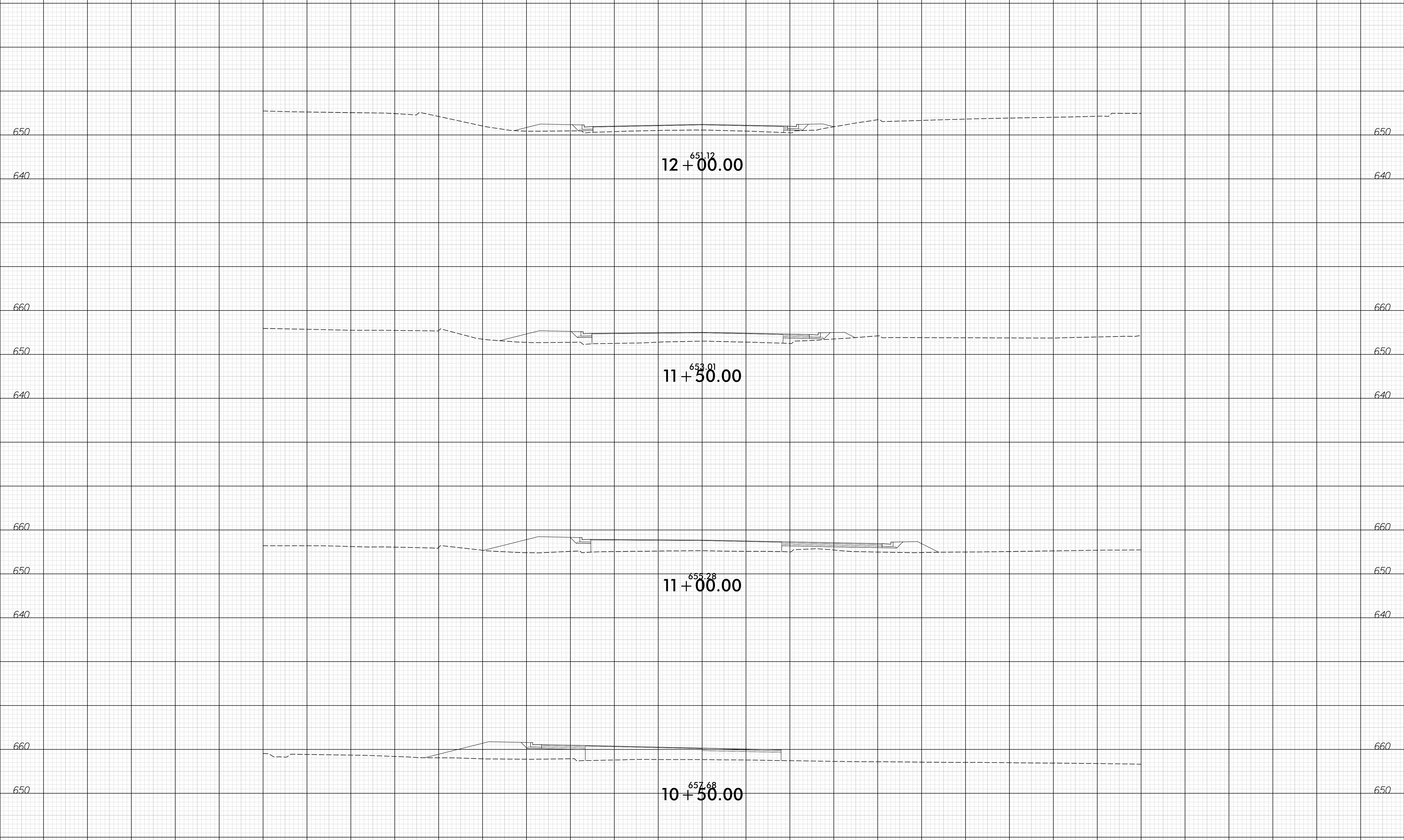

-Y2-

I:\2016\12\23\2016\I-5711\RDY\_XPL\_Y2.dgn  
 6/23/16

150 140 130 120 110 100 90 80 70 60 50 40 30 20 10 0 10 20 30 40 50 60 70 80 90 100 110 120 130 140 150

6/23/16

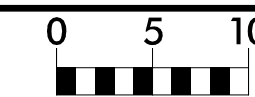

PROJ. REFERENCE NO.
I-5711

SHEET NO.
X-37

150 140 130 120 110 100 90 80 70 60 50 40 30 20 10 0 10 20 30 40 50 60 70 80 90 100 110 120 130 140 150

END CONSTRUCTION  
-Y2- STA. 13+05.00

DRIVEWAY

647.88  
13+00.00

649.52  
12+50.00

-Y2-

I:\2016\12\23\2016\I-5711\RDY\_XPL\_Y2.dgn

150 140 130 120 110 100 90 80 70 60 50 40 30 20 10 0 10 20 30 40 50 60 70 80 90 100 110 120 130 140 150

6/23/16

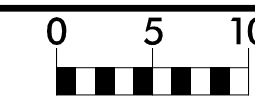

PROJ. REFERENCE NO.	I-5711
---------------------	--------

SHEET NO.	X-38
-----------	------

150 140 130 120 110 100 90 80 70 60 50 40 30 20 10 0 10 20 30 40 50 60 70 80 90 100 110 120 130 140 150

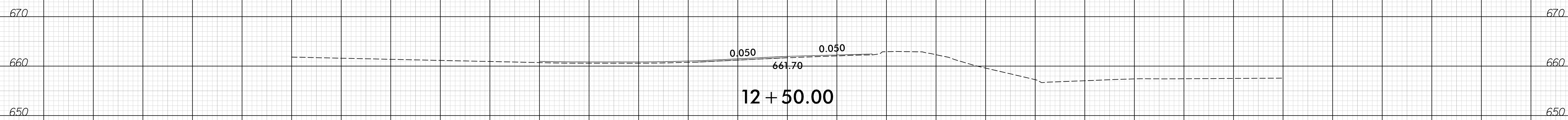
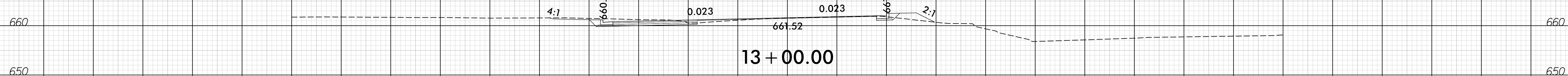
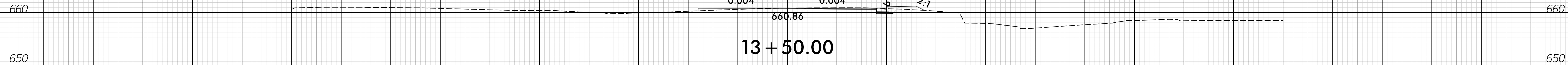

BEGIN CONSTRUCTION  
-Y3- STA. 12+10.00  
-Y3-

150 140 130 120 110 100 90 80 70 60 50 40 30 20 10 0 10 20 30 40 50 60 70 80 90 100 110 120 130 140 150

I:\2016\12\23\16\1-5711\RDY\_XPL\_Y3.dgn



6/23/16

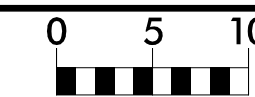

PROJ. REFERENCE NO.	SHEET NO.
I-5711	X-39

PROJ. REFERENCE NO.	SHEET NO.
I-5711	X-39

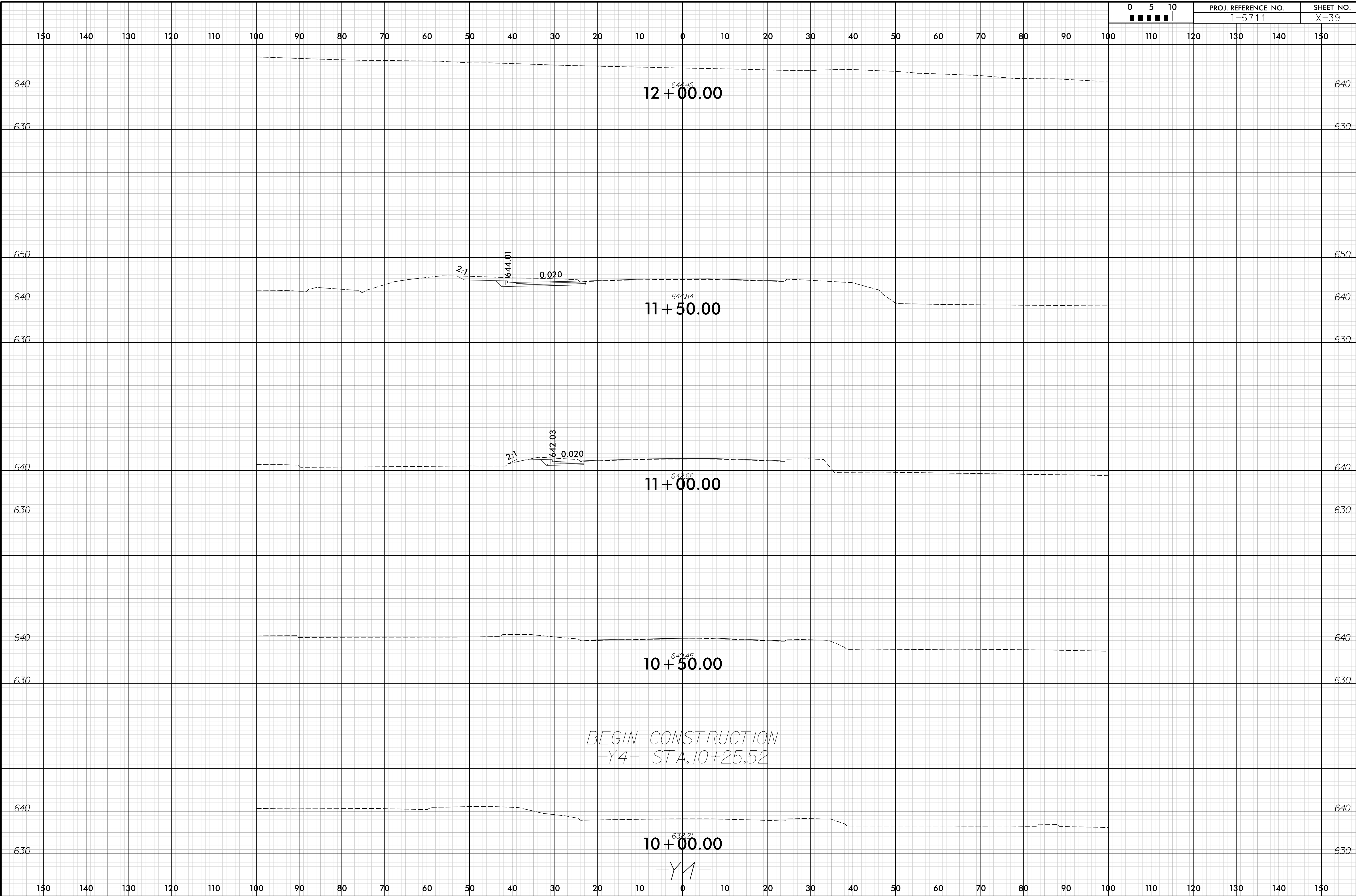

I:\2016\16\I-5711\RDY\_XPL\_Y4.dgn  
 6/23/16

150 140 130 120 110 100 90 80 70 60 50 40 30 20 10 0 10 20 30 40 50 60 70 80 90 100 110 120 130 140 150

# END CONSTRUCTION -Y4A- STA. 13+40

