

6/23/16

0 2.5 5	PROJ. REFERENCE NO. BR-0125	SHEET NO. X-1
---------	--------------------------------	------------------

75 70 65 60 55 50 45 40 35 30 25 20 15 10 5 0 5 10 15 20 25 30 35 40 45 50 55 60 65 70 75

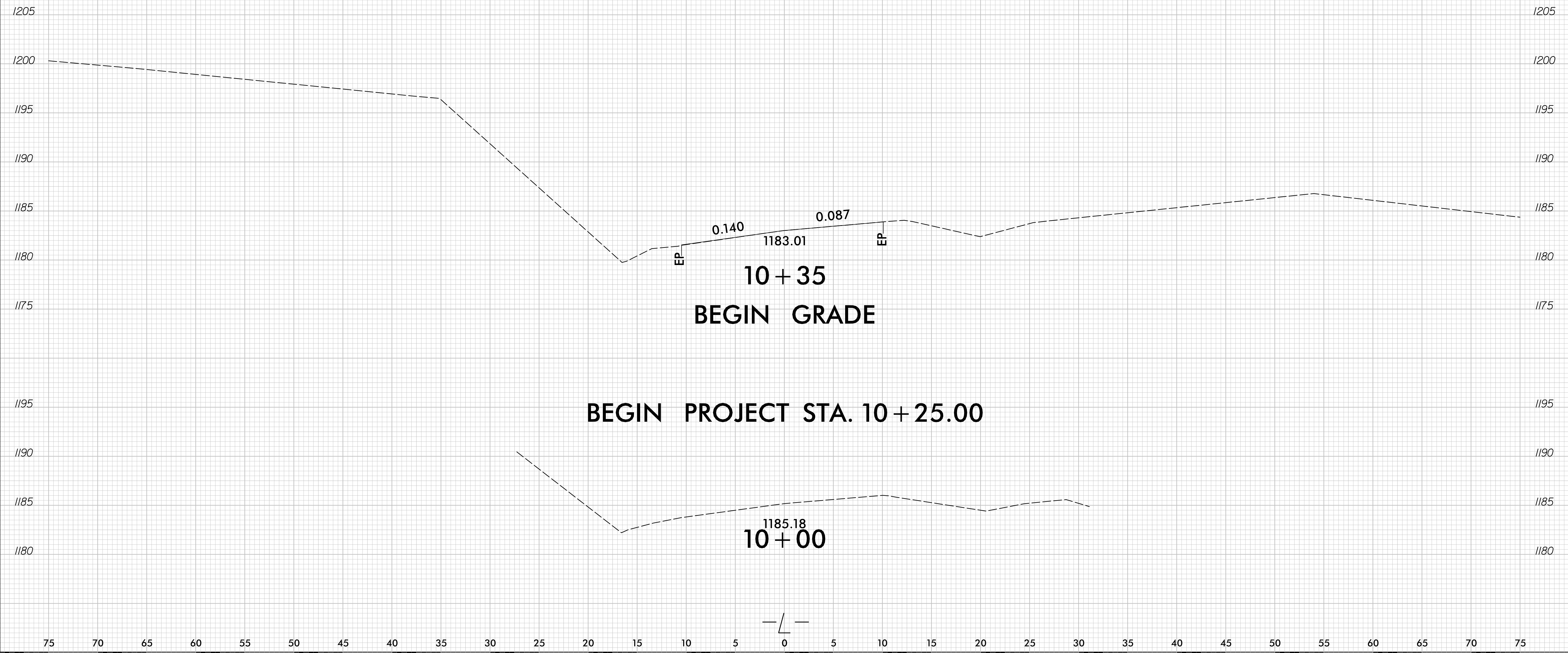

11/9/2020
F:\Roadway\Corridor-Modeling\BR0125_rdy.Lxp1.dgn
Plot

6/23/16

0 2.5 5	PROJ. REFERENCE NO. BR-0125	SHEET NO. X-2
---------	--------------------------------	------------------

75 70 65 60 55 50 45 40 35 30 25 20 15 10 5 0 5 10 15 20 25 30 35 40 45 50 55 60 65 70 75

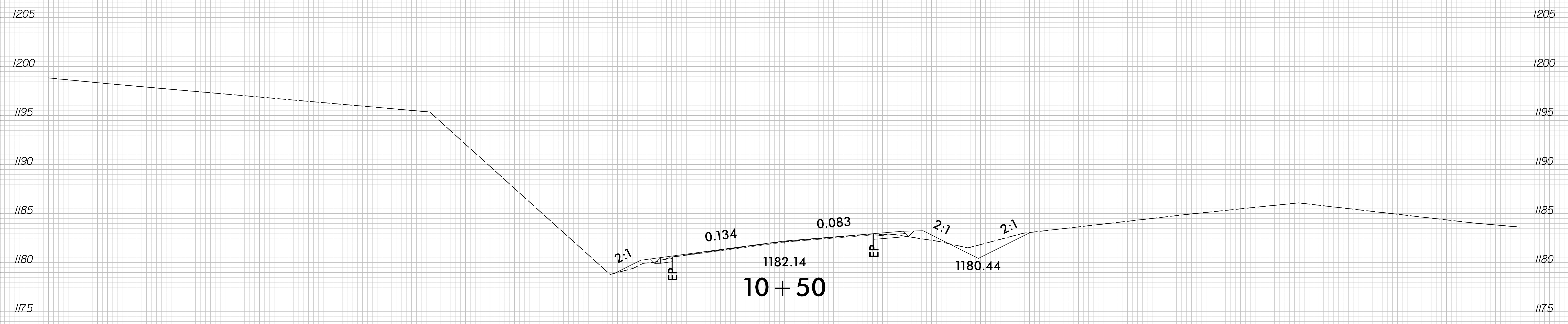
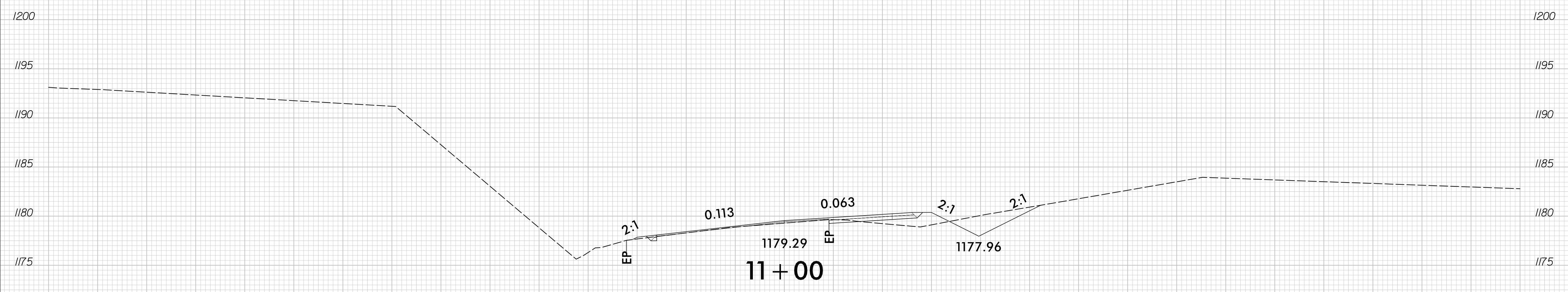

75 70 65 60 55 50 45 40 35 30 25 20 15 10 5 0 5 10 15 20 25 30 35 40 45 50 55 60 65 70 75

11/9/2020
 F:\Roadway\Corridor-Modeling\BR0125_rdy_L_xpl.dgn
 Plot

6/23/16

0 2.5 5	PROJ. REFERENCE NO. BR-0125	SHEET NO. X-3
---------	--------------------------------	------------------

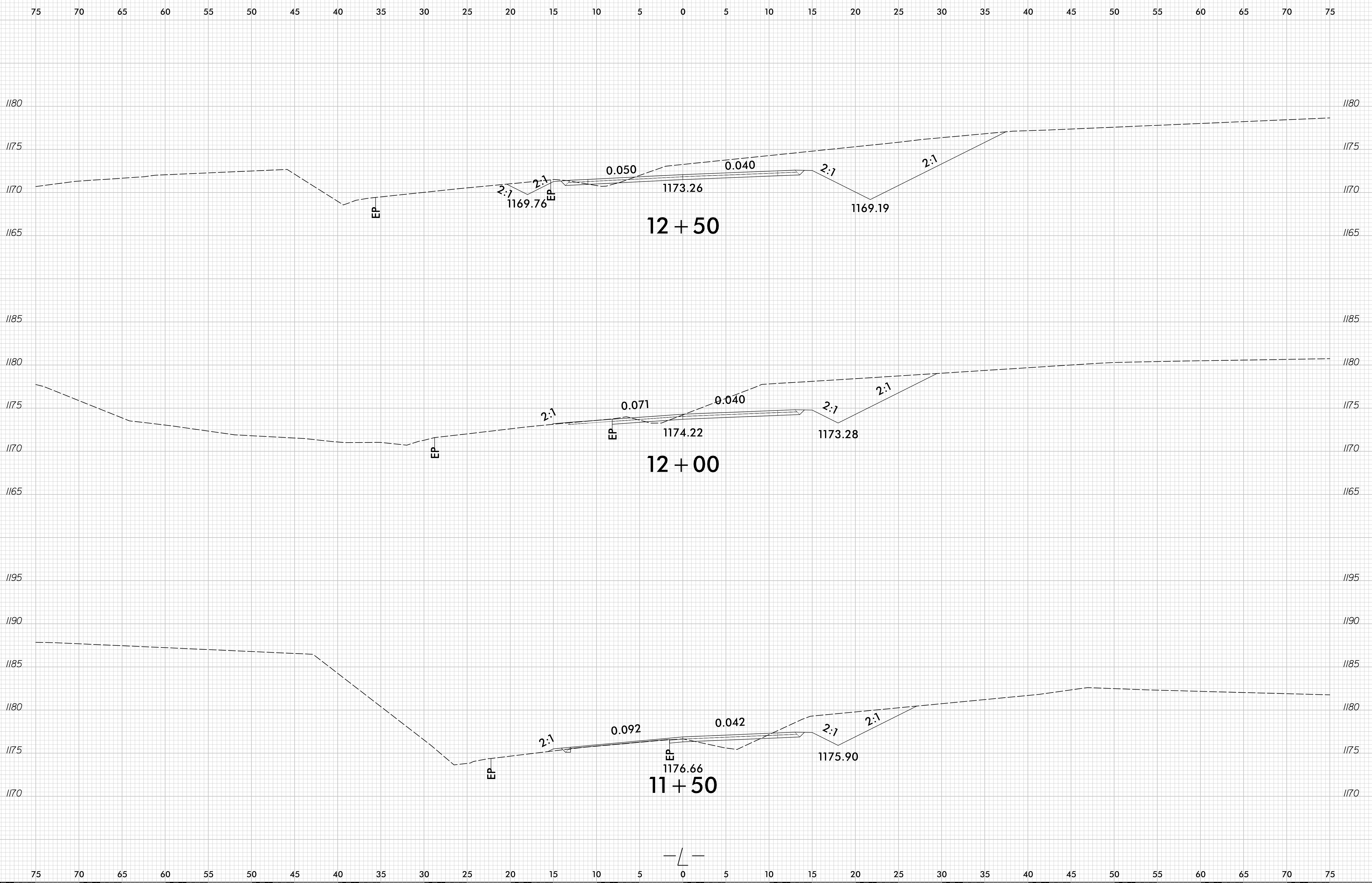

11/9/2020
F:\Roadway\Corridor-Modeling\BRT0125_rdy_L_xpl.dgn
Plan

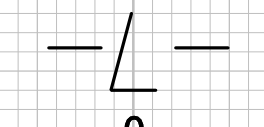

6/23/16

0 2.5 5	PROJ. REFERENCE NO. BR-0125	SHEET NO. X-4
---------	--------------------------------	------------------

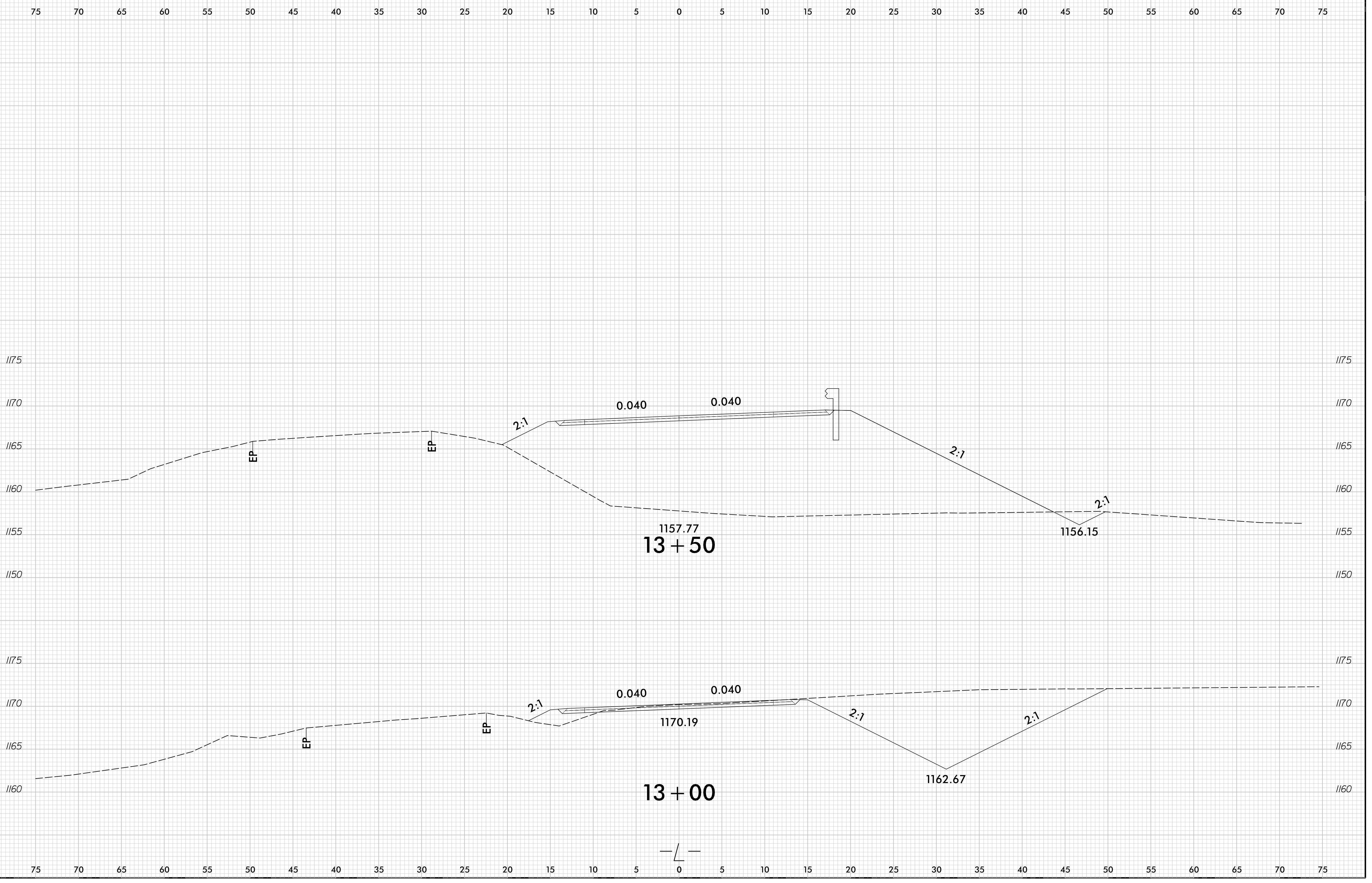

11/9/2020
F:\Roadway\Corridor-Modeling\BR0125_rdy_L_xpl.dgn
Plot

6/23/16

0 2.5 5	PROJ. REFERENCE NO. BR-0125	SHEET NO. X-5
---------	--------------------------------	------------------

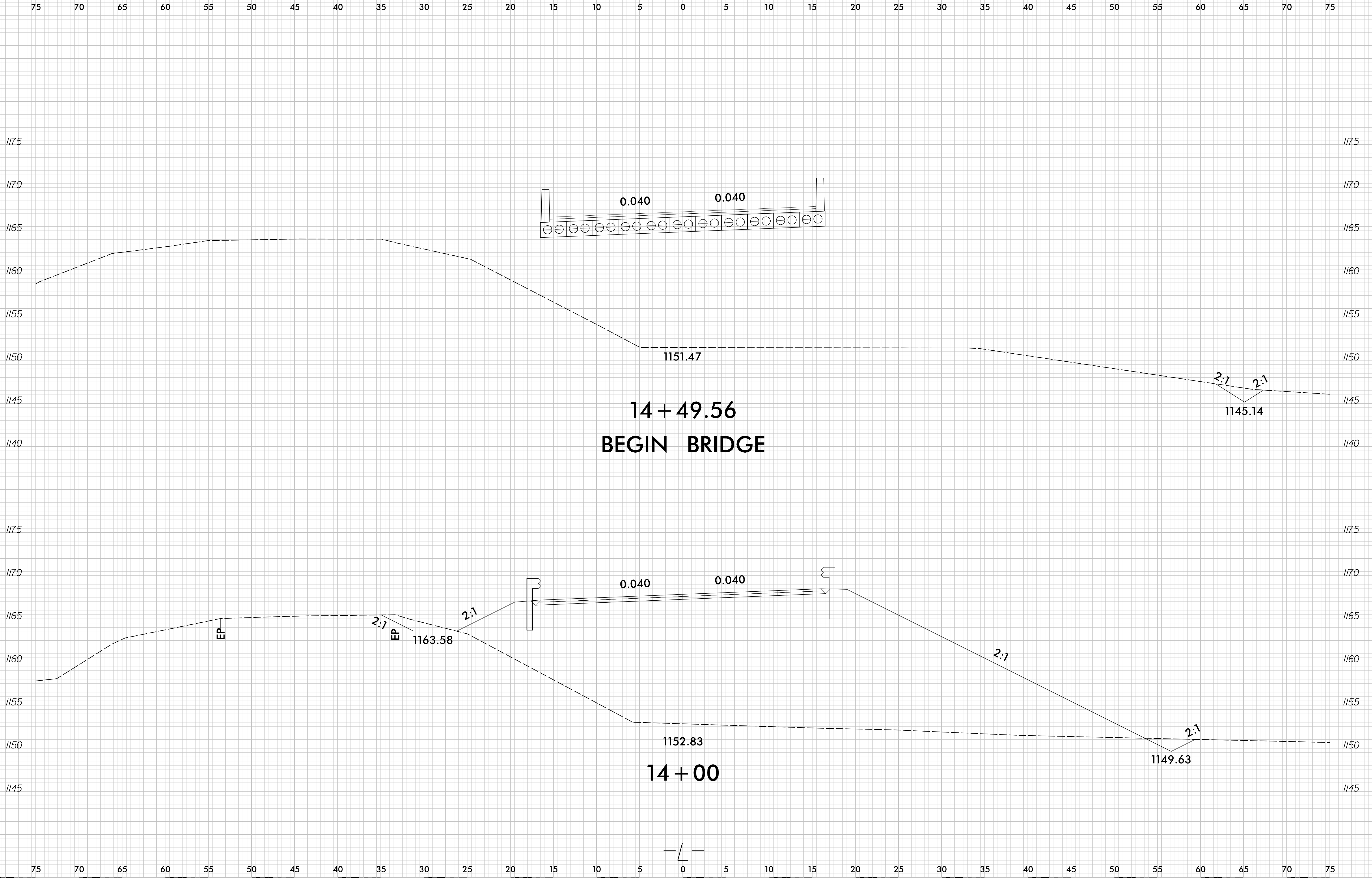

11/9/2020
F:\Roadway\Corridor-Modeling\BR0125_rdy_L_xpl.dgn
Print

6/23/16

0 2.5 5	PROJ. REFERENCE NO. BR-0125	SHEET NO. X-6
---------	--------------------------------	------------------

75 70 65 60 55 50 45 40 35 30 25 20 15 10 5 0 5 10 15 20 25 30 35 40 45 50 55 60 65 70 75

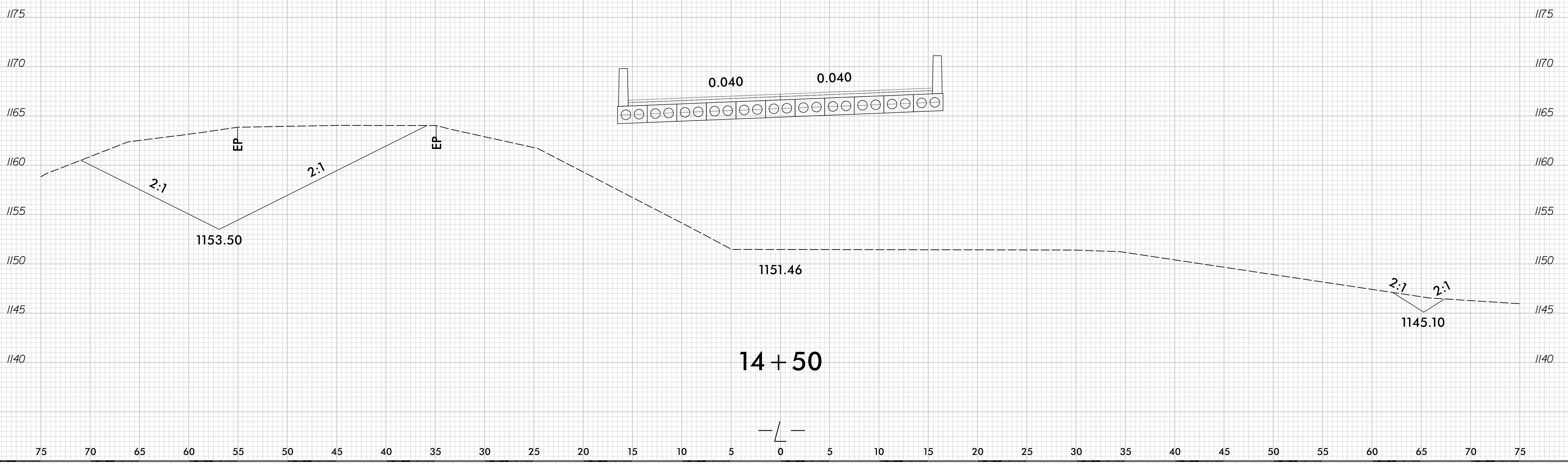
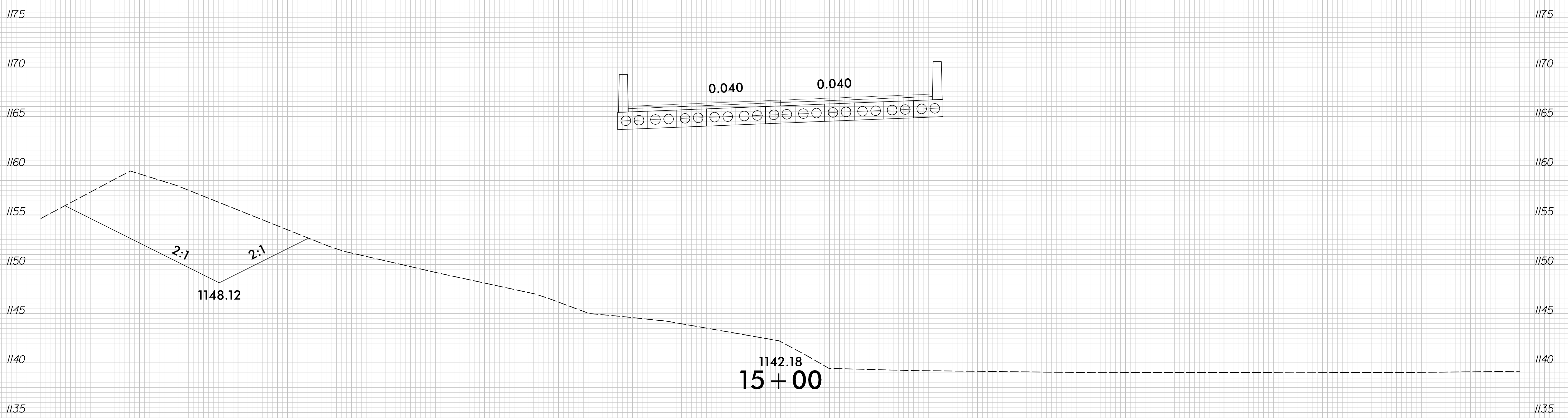

11/9/2020
F:\Roadway\Corridor-Modeling\BR0125_rdy.Lxp1.dgn
Plan

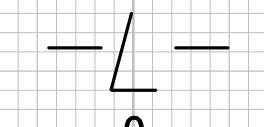

6/23/16

0 2.5 5	PROJ. REFERENCE NO. BR-0125	SHEET NO. X-7
---------	--------------------------------	------------------

75 70 65 60 55 50 45 40 35 30 25 20 15 10 5 0 5 10 15 20 25 30 35 40 45 50 55 60 65 70 75

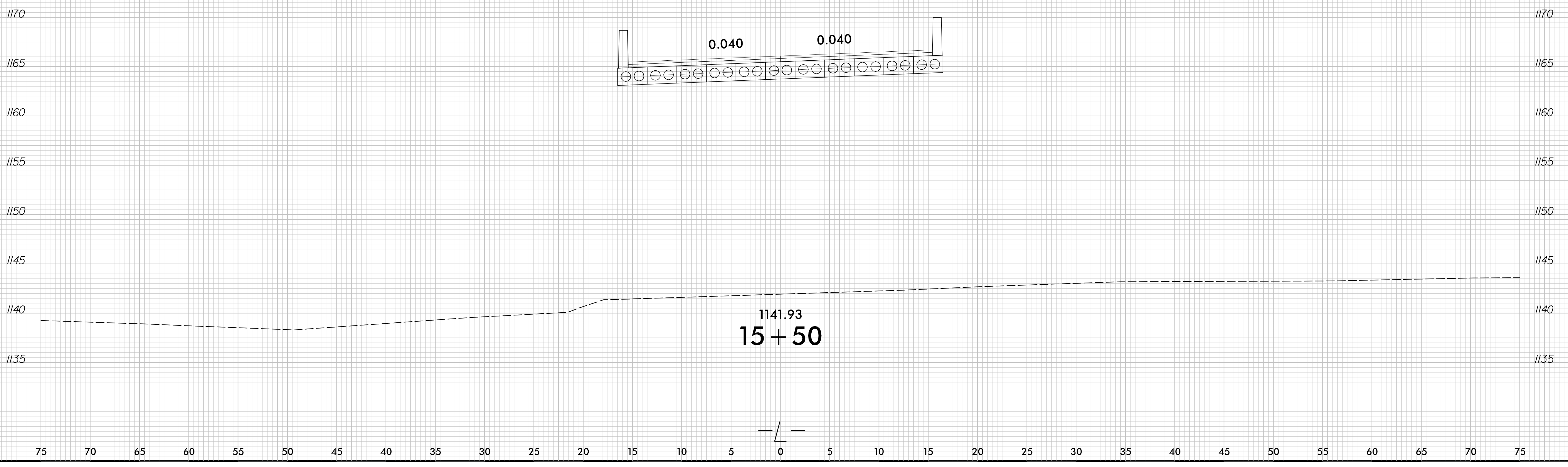
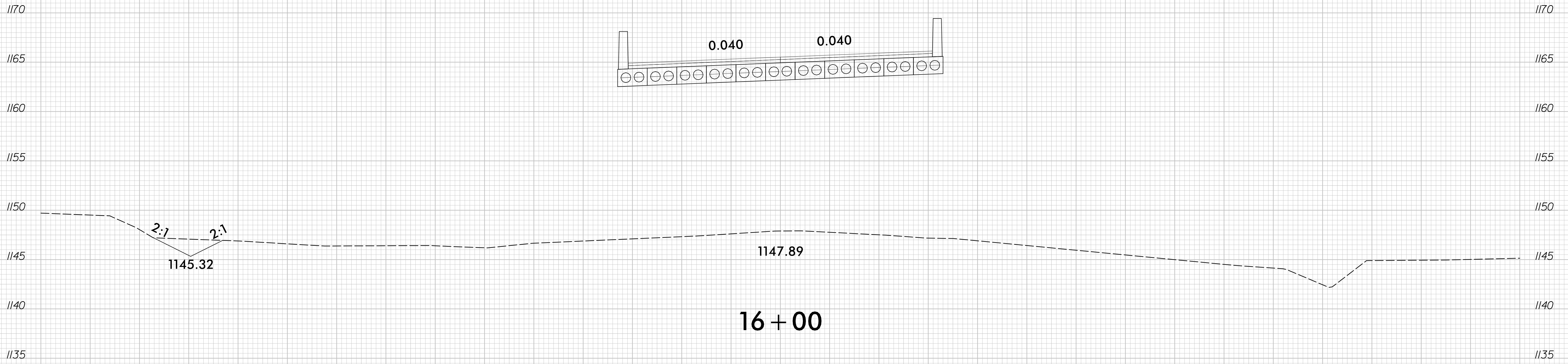

11/9/2020
F:\Roadway\Corridor-Modeling\BR0125_rdy.Lxp1.dgn
Plan

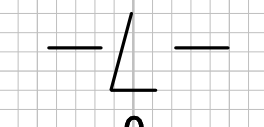

6/23/2020

75 70 65 60 55 50 45 40 35 30 25 20 15 10 5 0 5 10 15 20 25 30 35 40 45 50 55 60 65 70 75

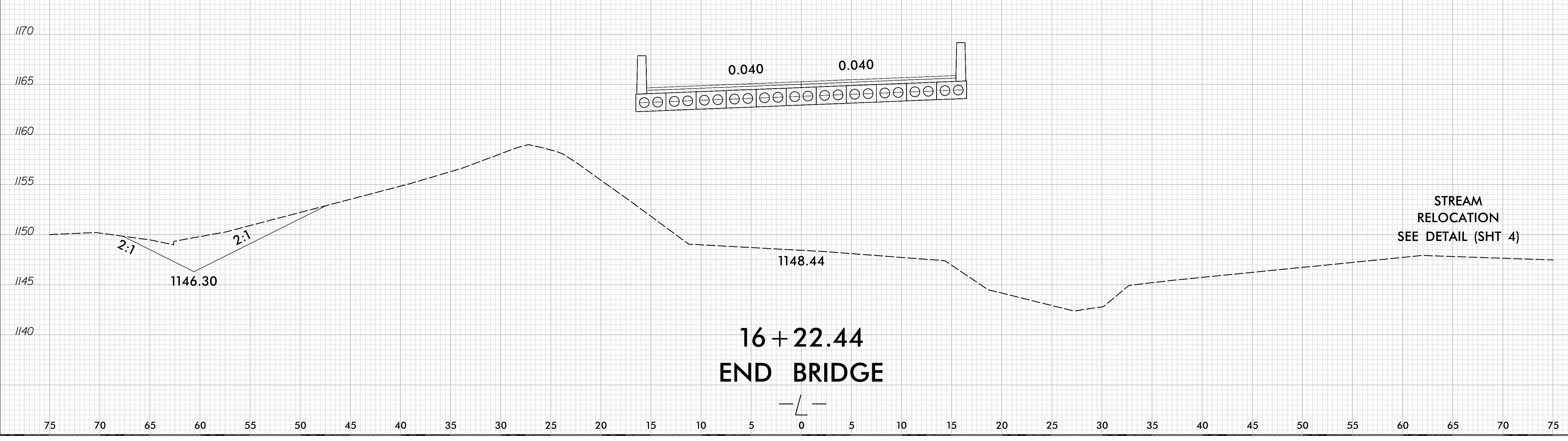
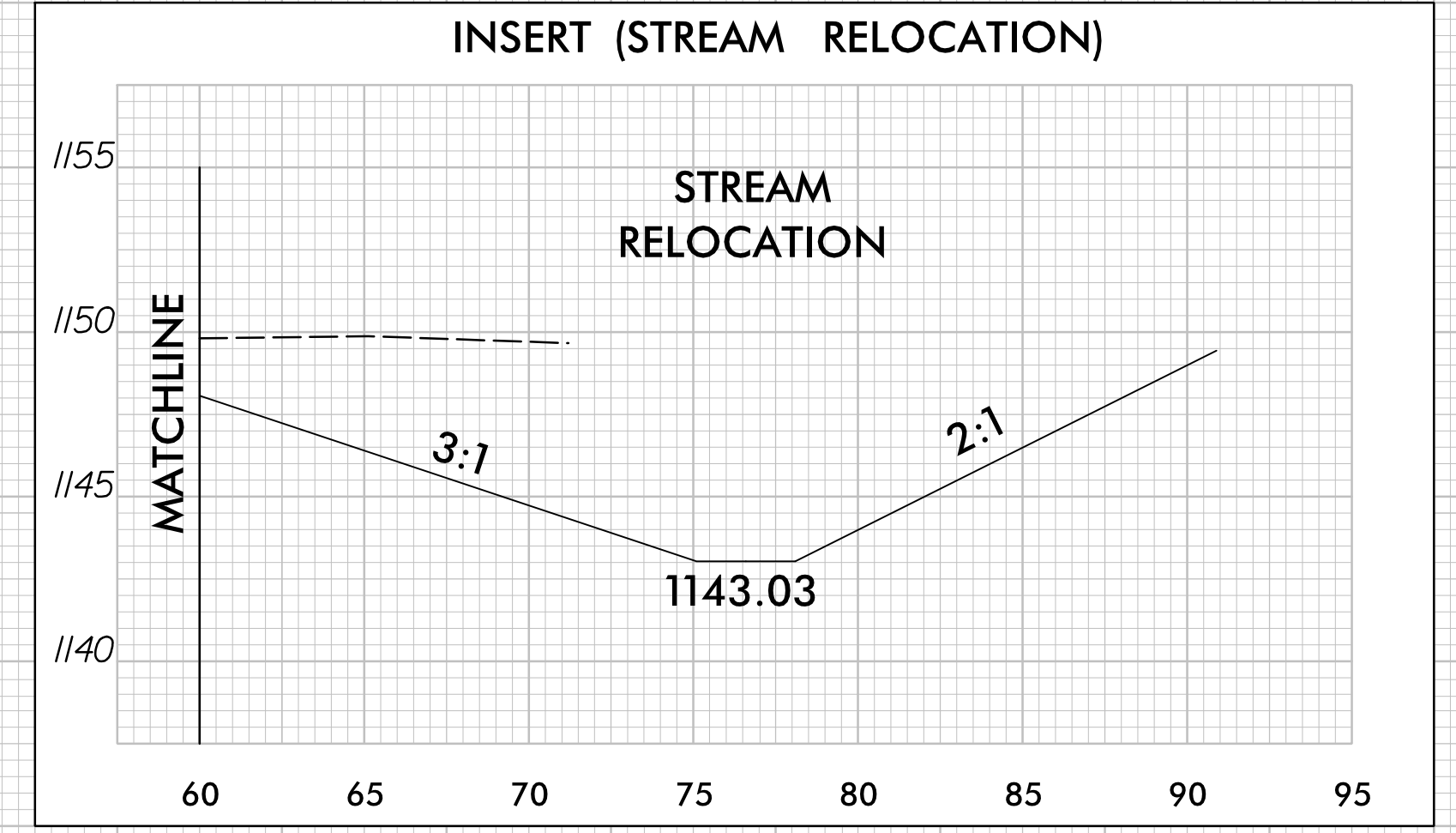
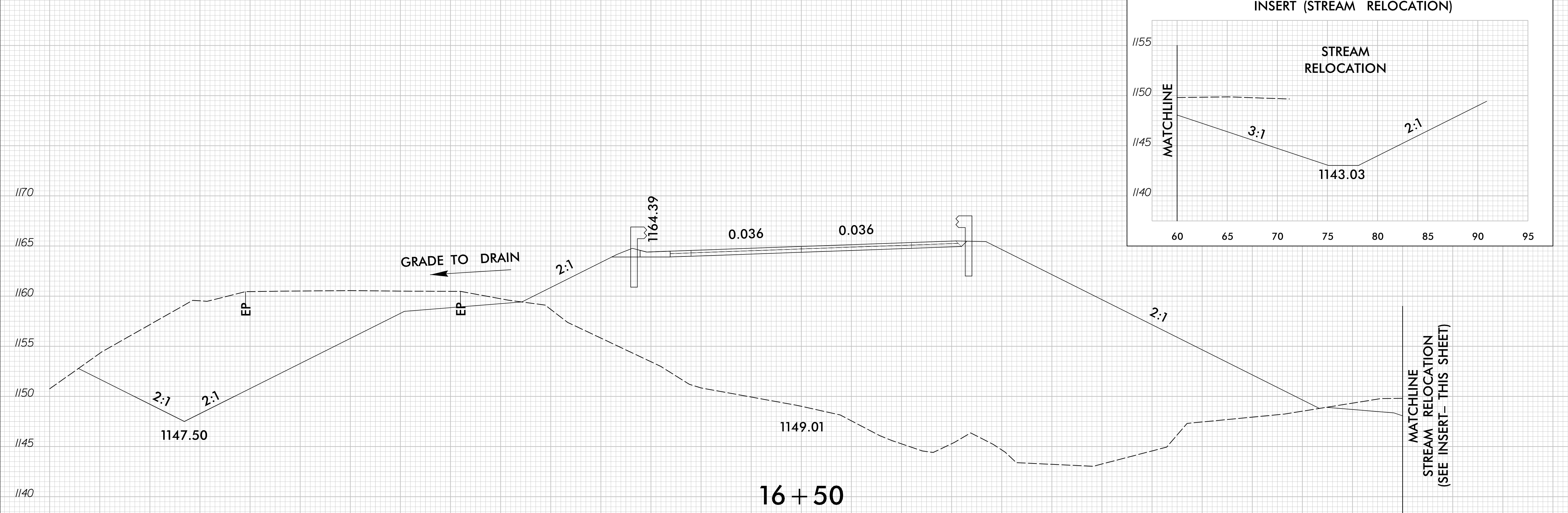

K:\2020\Highway\CorridorModeling\BR0125_rdy_L_xpl.dgn

6/23/16

0 2.5 5	PROJ. REFERENCE NO. BR-0125	SHEET NO. X-9
---------	--------------------------------	------------------

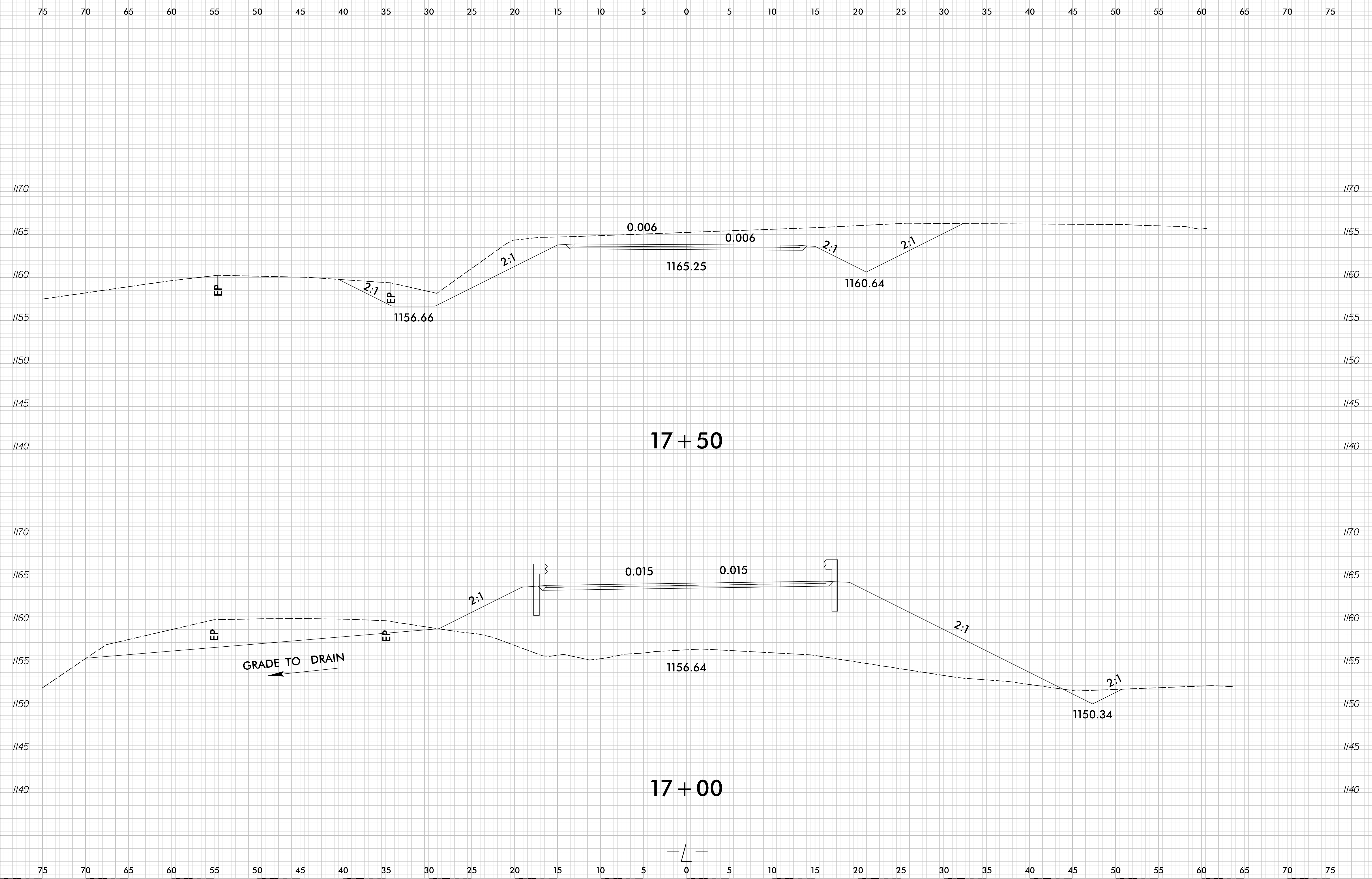

11/9/2020
F:\Roadway\Corridor-Modeling\BR0125_rdy_L_xpl.dgn
Plan

6/23/16

0 2.5 5	PROJ. REFERENCE NO. BR-0125	SHEET NO. X-10
---------	--------------------------------	-------------------

75 70 65 60 55 50 45 40 35 30 25 20 15 10 5 0 5 10 15 20 25 30 35 40 45 50 55 60 65 70 75

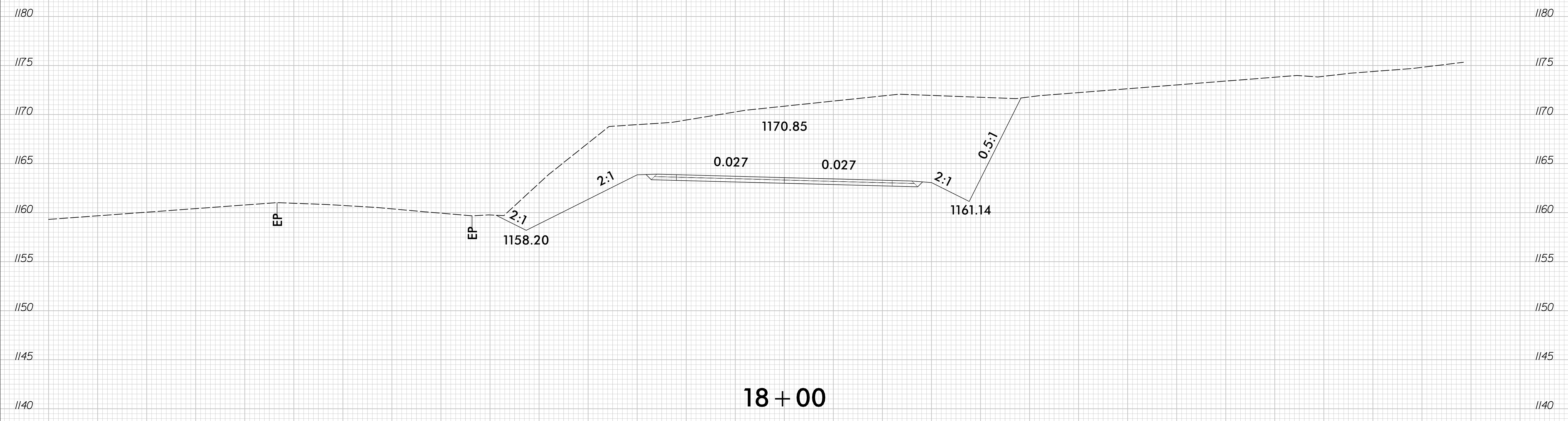

11/9/2020
F:\Roadway\Corridor-Modeling\BR0125_rdy.L\xp1.dgn
Plot

75 70 65 60 55 50 45 40 35 30 25 20 15 10 5 0 5 10 15 20 25 30 35 40 45 50 55 60 65 70 75

6/23/16

0 2.5 5	PROJ. REFERENCE NO. BR-0125	SHEET NO. X-11
---------	--------------------------------	-------------------

75 70 65 60 55 50 45 40 35 30 25 20 15 10 5 0 5 10 15 20 25 30 35 40 45 50 55 60 65 70 75

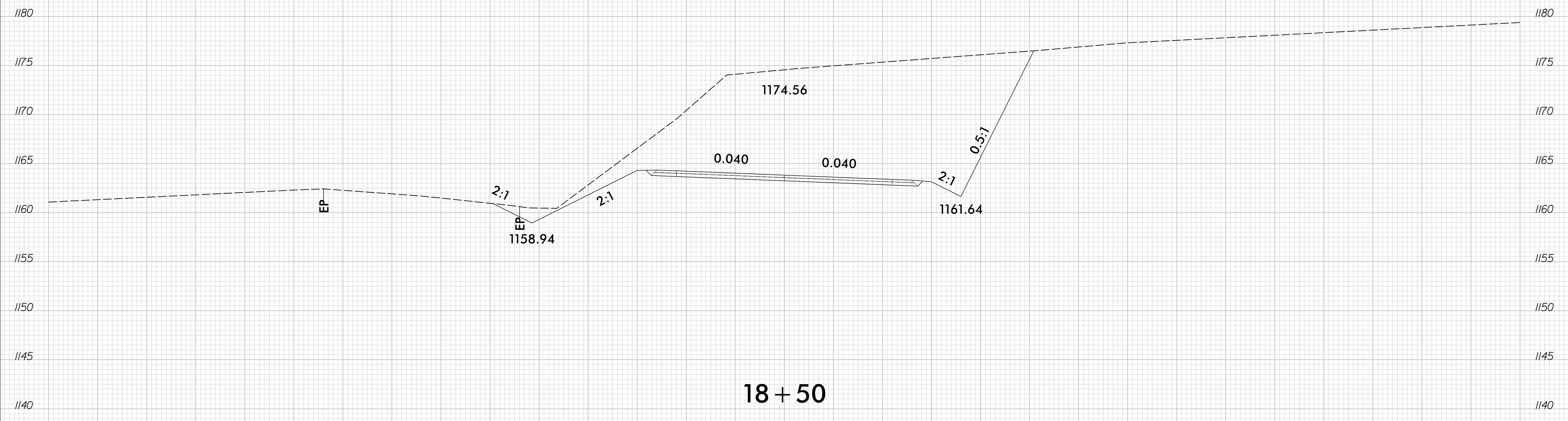

11/9/2020
F:\Roadway\Corridor-Modeling\BR0125_rdy.L\xp1.dgn
Plot

75 70 65 60 55 50 45 40 35 30 25 20 15 10 5 0 5 10 15 20 25 30 35 40 45 50 55 60 65 70 75

6/23/16

	PROJ. REFERENCE NO.	SHEET NO.
	BR-0125	X-12

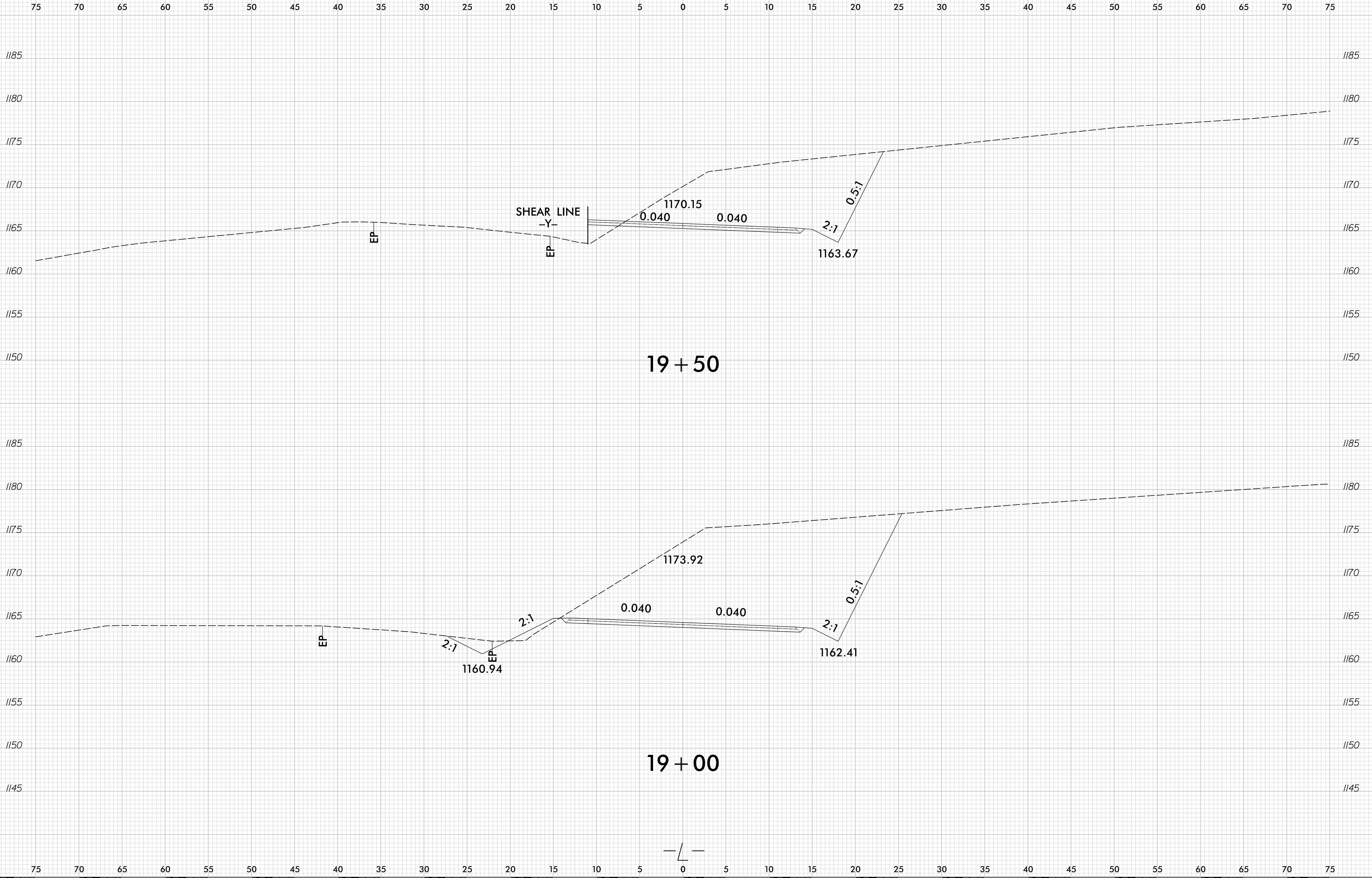

11/9/2020
F:\Roadway\Corridor-Modeling\BR0125_rdy_L_xpl.dgn
Plan

6/23/16

0 2.5 5	PROJ. REFERENCE NO. BR-0125	SHEET NO. X-13
---------	--------------------------------	-------------------

75 70 65 60 55 50 45 40 35 30 25 20 15 10 5 0 5 10 15 20 25 30 35 40 45 50 55 60 65 70 75

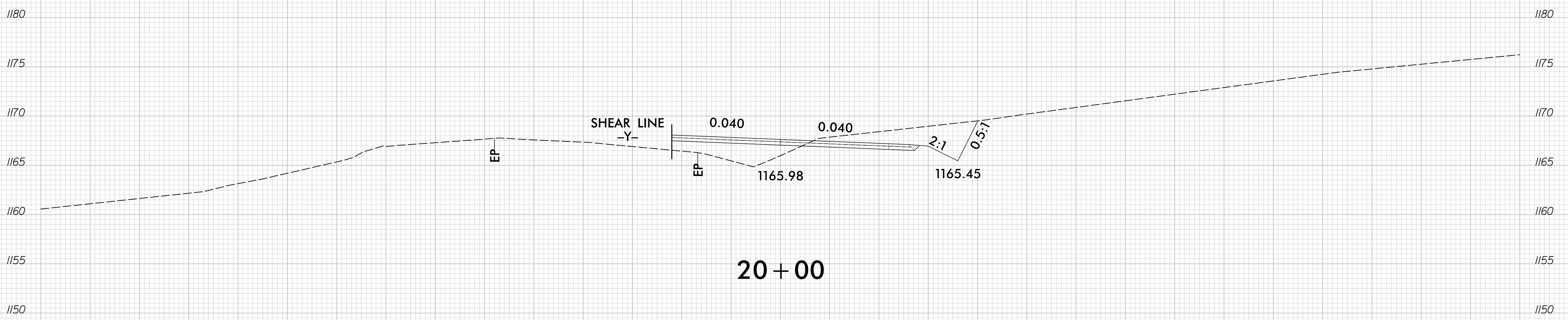
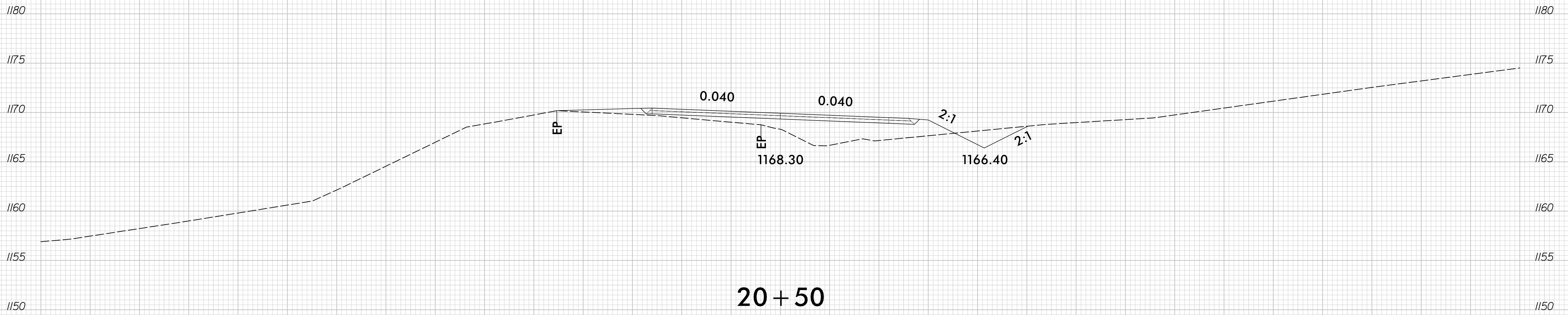

75 70 65 60 55 50 45 40 35 30 25 20 15 10 5 0 5 10 15 20 25 30 35 40 45 50 55 60 65 70 75

11/9/2020
F:\Roadway\Corridor-Modeling\BR0125_rdy.Lxp1.dgn
Print

6/23/16

0 2.5 5	PROJ. REFERENCE NO. BR-0125	SHEET NO. X-14
---------	--------------------------------	-------------------

75 70 65 60 55 50 45 40 35 30 25 20 15 10 5 0 5 10 15 20 25 30 35 40 45 50 55 60 65 70 75

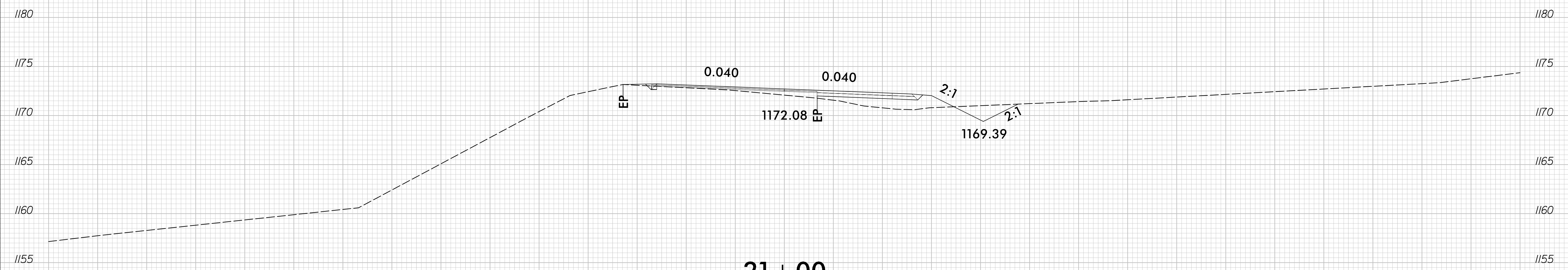
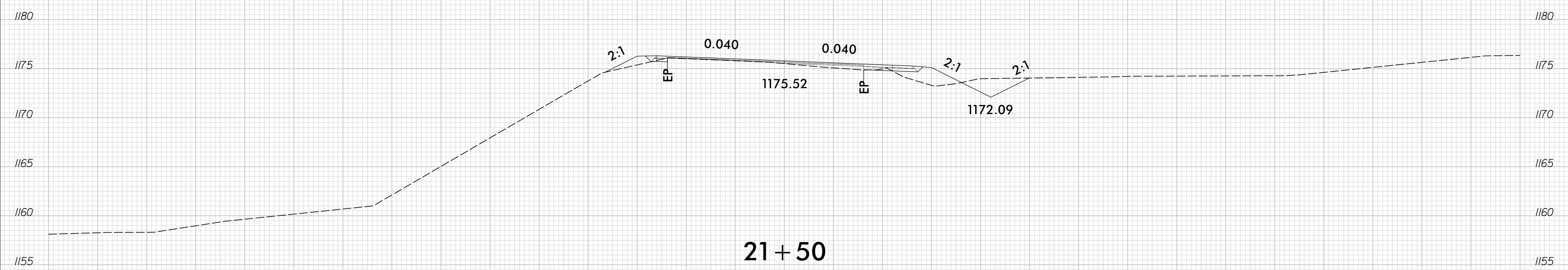

75 70 65 60 55 50 45 40 35 30 25 20 15 10 5 0 5 10 15 20 25 30 35 40 45 50 55 60 65 70 75

11/9/2020
 F:\Roadway\Corridor-Modeling\BR0125_rdy_L_xpl.dgn
 Plot

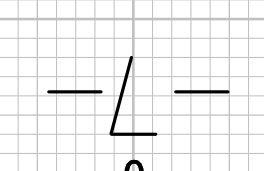

6/23/16

0 2.5 5	PROJ. REFERENCE NO. BR-0125	SHEET NO. X-15
---------	--------------------------------	-------------------

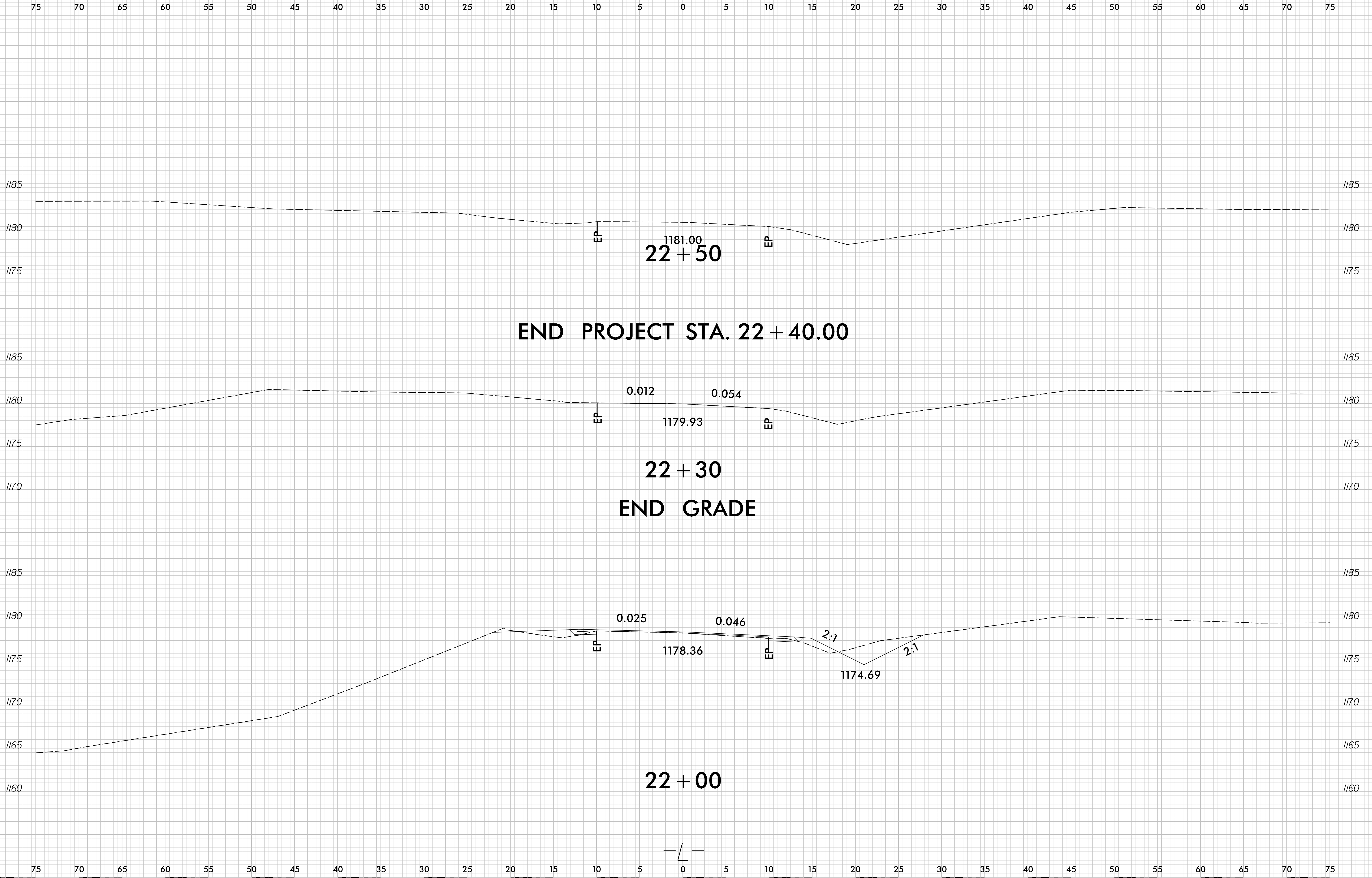

11/9/2020
F:\Roadway\Corridor-Modeling\BRT0125_rdy_L_xpl.dgn
Plot

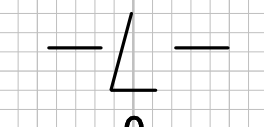

6/23/16

0 2.5 5	PROJ. REFERENCE NO. BR-0125	SHEET NO. X-16
---------	--------------------------------	-------------------

75 70 65 60 55 50 45 40 35 30 25 20 15 10 5 0 5 10 15 20 25 30 35 40 45 50 55 60 65 70 75

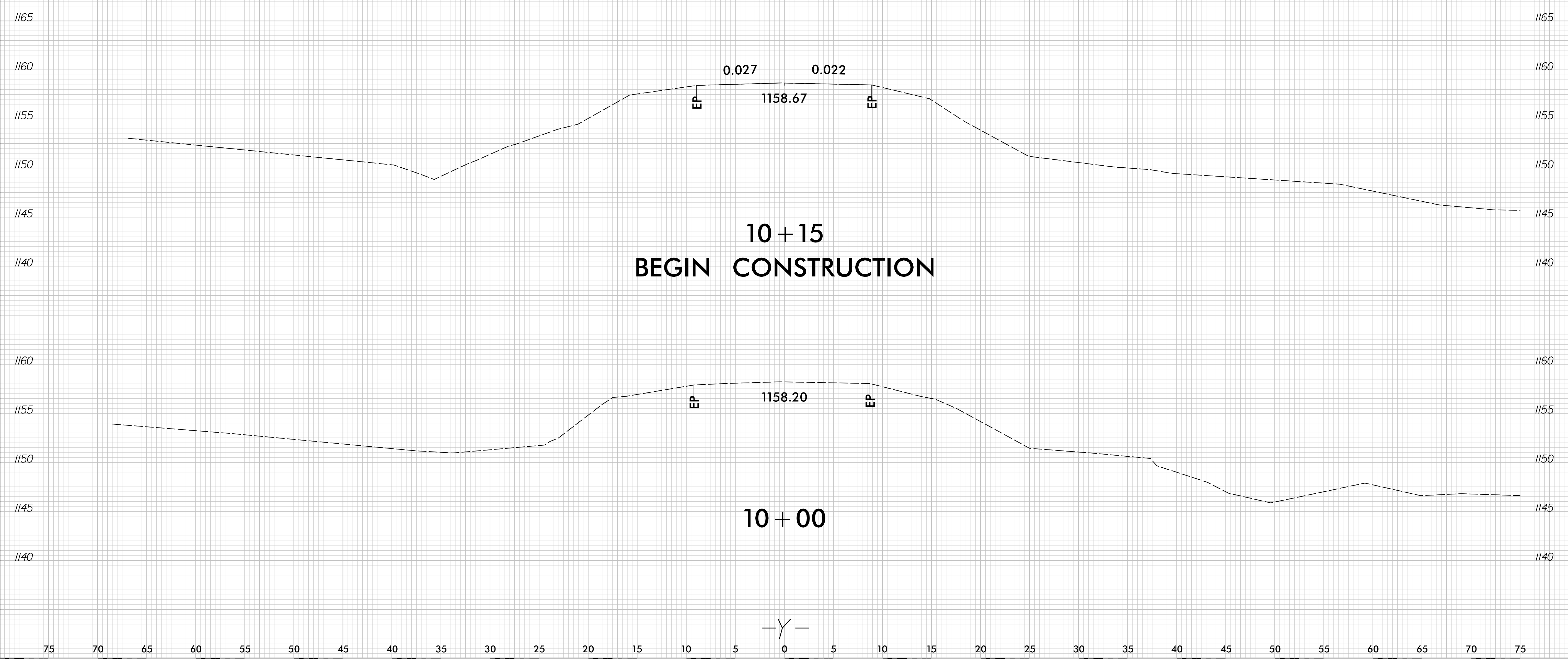

11/9/2020
F:\Roadway\Corridor-Modeling\BR0125_rdy_Y_xpl.dgn
Plot

—Y—

6/23/16

0 2.5 5	PROJ. REFERENCE NO. BR-0125	SHEET NO. X-17
---------	--------------------------------	-------------------

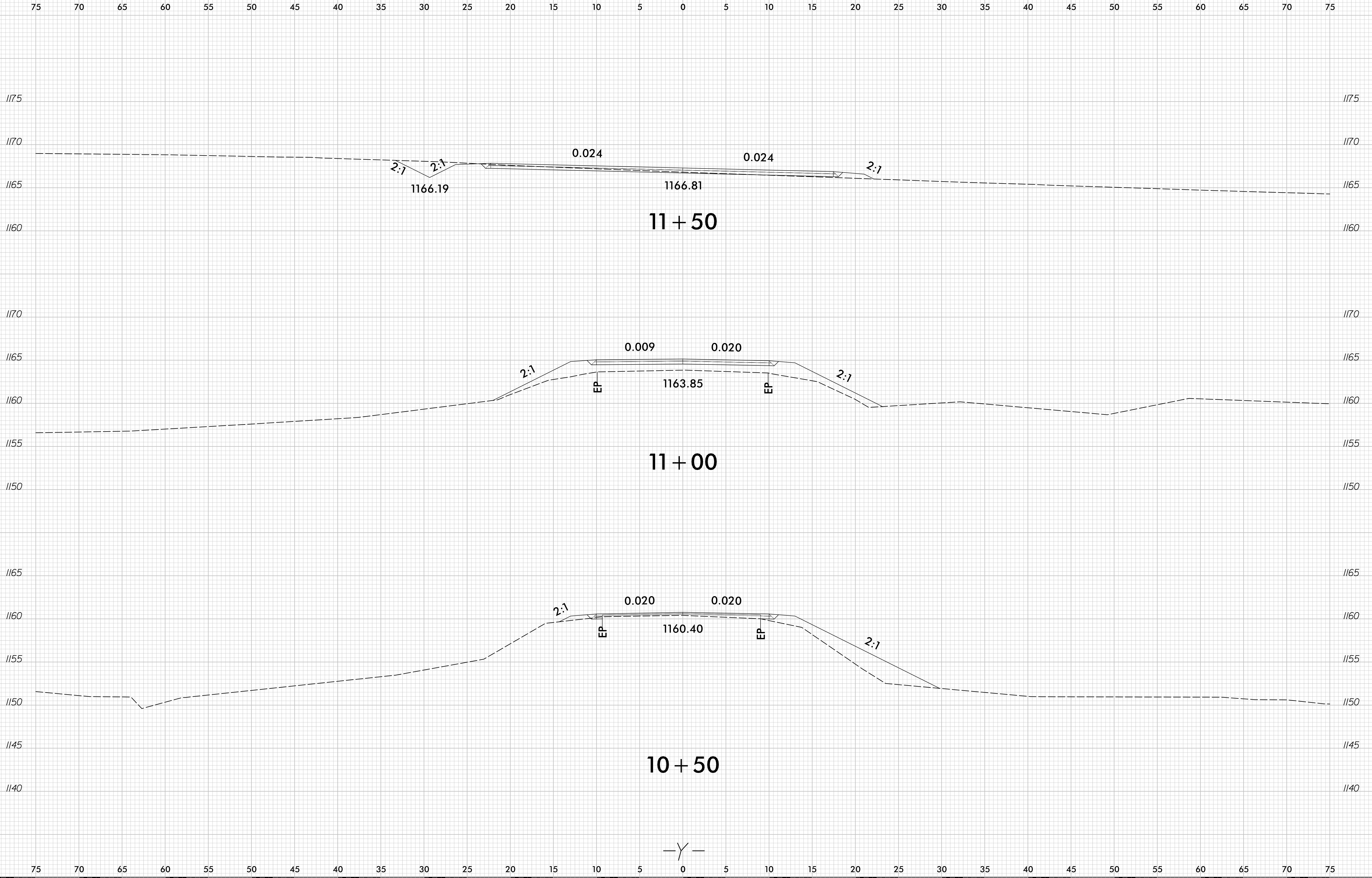

11/9/2020
F:\Roadway\Corridor-Modeling\BR0125_rdy_Y_xpl.dgn
Plot

—Y—