

CROSS SECTION INDEX

<i>-L-</i>	<i>X-1 thru X-16</i>
<i>-Y-</i>	<i>X-17 and X-18</i>
<i>-Y1-</i>	<i>X-19 thru X-25</i>
<i>-RPA_Y1-</i>	<i>X-26 and X-27</i>
<i>-RPB_Y1-</i>	<i>X-28 thru X-33</i>
<i>-RPC_Y1-</i>	<i>X-34</i>
<i>-RPD_Y1-</i>	<i>X-35</i>
<i>-Y2-</i>	<i>X-36 and X-37</i>
<i>-Y3-</i>	<i>X-38</i>
<i>-Y4-</i>	<i>X-39</i>

**STATE OF NORTH CAROLINA
DIVISION OF HIGHWAYS**

PROJ. REFERENCE NO.	SHEET NO.
I-5711	X-1B

Approximate quantities only. Unclassified excavation, borrow excavation, grading, clearing and grubbing, and removal of existing pavement will be paid for at the lump sum price for "Grading".

NOTE: EMBANKMENT COLUMN INCLUDES BACKFILL FOR UNDERCUT

CROSS-SECTION SUMMARY

Station	Uncl. Exc.	Embt	Station	Uncl. Exc.	Embt	Station	Uncl. Exc.	Embt	Station	Uncl. Exc.	Embt	Station	Uncl. Exc.	Embt
L (LT)	(cu. yd.)	(cu. yd.)	L (LT)	(cu. yd.)	(cu. yd.)	L (RT)	(cu. yd.)	(cu. yd.)	Rpb_Y1	(cu. yd.)	(cu. yd.)	Y3	(cu. yd.)	(cu. yd.)
18+03.85	0	0	44+50.00	10	134	36+00.00	17	90	15+50.00	526	0	12+10.00	0	0
18+50.00	0	0	45+00.00	9	142	36+50.00	5	131	16+00.00	611	13	12+50.00	0	0
19+00.00	0	0	45+50.00	8	149	37+00.00	19	113	16+50.00	681	13	13+00.00	28	22
19+50.00	0	0	46+00.00	8	144	37+50.00	34	83	17+00.00	815	7	13+50.00	35	9
20+00.00	59	0	46+50.00	11	139	38+00.00	26	83	17+50.00	881	12	13+95.01	0	0
20+50.00	82	0	47+00.00	13	127	38+50.00	18	66	18+00.00	787	12			
21+00.00	56	0	47+50.00	14	112	39+00.00	19	52	18+50.00	676	11	Station	Uncl. Exc.	Embt
21+50.00	54	6	48+00.00	18	75	39+50.00	26	31	19+00.00	540	10	Y4	(cu. yd.)	(cu. yd.)
22+00.00	47	26	48+50.00	13	69	40+00.00	33	6	19+50.00	237	24	10+25.52	0	0
22+50.00	23	52	49+00.00	5	79	40+50.00	34	2	20+00.00	6	89	10+50.00	0	0
23+00.00	4	172	49+50.00	4	61	41+00.00	33	1	20+50.00	1	269	11+00.00	14	12
23+50.00	0	452	50+00.00	0	0	41+50.00	31	3	20+72.91	0	0	11+50.00	52	12
24+00.00	0	311				42+00.00	144	2				11+96.20	0	0
24+50.00	1	131	Station	Uncl. Exc.	Embt	42+50.00	130	0	Station	Uncl. Exc.	Embt			
25+00.00	7	487	L (RT)	(cu. yd.)	(cu. yd.)	43+00.00	55	0	Rpc_Y1	(cu. yd.)	(cu. yd.)			
25+96.62	17	995				43+50.00	74	0						
			18+03.85	0	0	44+00.00	19	0	10+50.00	0	0			
Station	Uncl. Exc.	Embt	18+50.00	0	0	44+50.00	0	0	11+00.00	5	26			
L (LT)	(cu. yd.)	(cu. yd.)	19+00.00	0	0	45+00.00	0	0	11+50.00	10	69			
			19+50.00	0	0	45+50.00	0	0	11+95.54	0	0			
28+15.65	0	0	20+00.00	8	66	46+00.00	0	0						
28+50.00	0	0	20+50.00	14	82	46+50.00	0	0	Station	Uncl. Exc.	Embt			
29+00.00	19	454	21+00.00	19	86	47+00.00	0	0	Rpd_Y1	(cu. yd.)	(cu. yd.)			
29+50.00	14	158	21+50.00	19	81	47+50.00	0	0	19+80.09	0	0			
30+00.00	11	64	22+00.00	15	95	48+00.00	0	0	20+00.00	0	0			
30+50.00	4	83	22+50.00	11	107	48+50.00	0	0	20+50.00	17	67			
31+00.00	7	45	23+00.00	7	121	49+00.00	0	0	21+00.00	8	101			
31+50.00	11	60	23+50.00	6	120	49+50.00	0	0	21+42.67	0	0			
32+00.00	9	91	24+00.00	2	58	50+00.00	0	0						
32+50.00	4	131	24+50.00	2	1									
33+00.00	1	156	25+00.00	13	57	Station	Uncl. Exc.	Embt	Station	Uncl. Exc.	Embt			
33+50.00	9	81	25+50.00	27	96	Rpa_Y1	(cu. yd.)	(cu. yd.)	Y	(cu. yd.)	(cu. yd.)			
34+00.00	9	0	25+96.62	0	0	12+50.00	0	0	13+72.47	0	0			
34+50.00	1	43				13+00.00	18	128	14+00.00	0	0			
35+00.00	8	57	Station	Uncl. Exc.	Embt	13+50.00	11	167	15+00.00	0	36			
35+50.00	7	16	L (RT)	(cu. yd.)	(cu. yd.)	14+00.00	0	307	15+50.00	52	18			
36+00.00	11	4				14+50.00	2	538	16+00.00	83	18			
36+50.00	21	6	28+15.65	0	0	14+89.10	0	0	16+50.00	39	17			
37+00.00	21	5	28+50.00	0	0				16+87.00	0	0			
37+50.00	31	2	29+00.00	19	130									
38+00.00	43	2	29+50.00	5	28	Station	Uncl. Exc.	Embt						
38+50.00	38	6	30+00.00	3	40	Rpb_Y1	(cu. yd.)	(cu. yd.)	Station	Uncl. Exc.	Embt			
39+00.00	23	16	30+50.00	7	63				Y2	(cu. yd.)	(cu. yd.)			
39+50.00	17	26	31+00.00	6	43	10+75.00	0	0	10+50.93	0	0			
40+00.00	17	33	31+50.00	10	31	11+00.00	0	0	11+00.00	2	178			
40+50.00	24	32	32+00.00	29	12	11+50.00	126	0	11+50.00	1	141			
41+00.00	26	26	32+50.00	70	0	12+00.00	170	0	12+00.00	3	74			
41+50.00	22	25	33+00.00	55	0	12+50.00	196	0	12+50.00	3	32			
42+00.00	21	35	33+50.00	8	1	13+00.00	209	0	13+05.00	3	10			
42+50.00	18	60	34+00.00	22	11	13+50.00	244	1						
43+00.00	15	100	34+50.00	35	17	14+00.00	295	3						
43+50.00	13	131	35+00.00	37	88	14+50.00	366	4						
44+00.00	12	137	35+50.00	32	113	15+00.00	453	1						

6/23/16

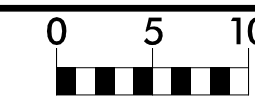

PROJ. REFERENCE NO.	SHEET NO.
I-5711	X-1

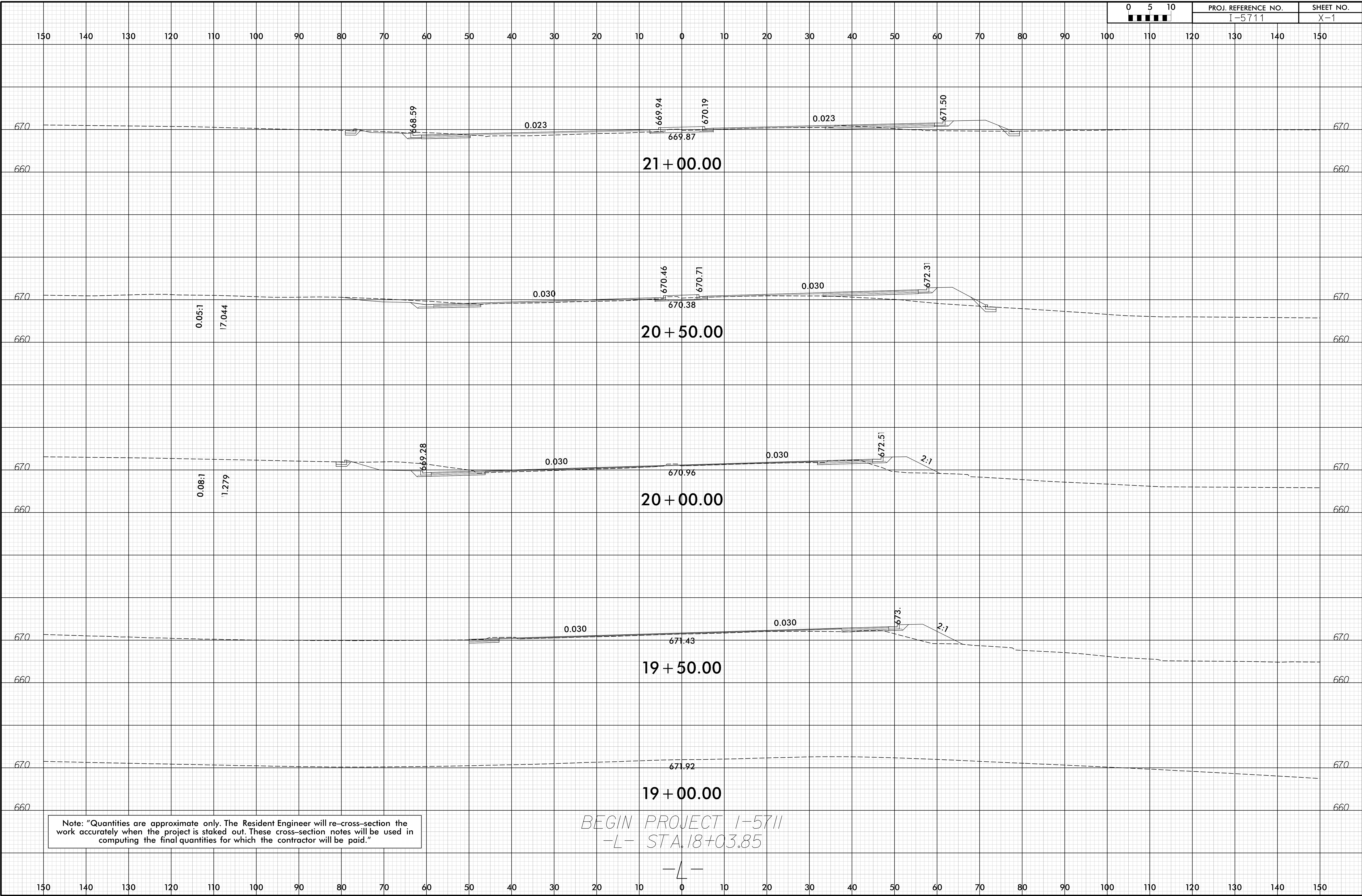

Note: "Quantities are approximate only. The Resident Engineer will re-cross-section the work accurately when the project is staked out. These cross-section notes will be used in computing the final quantities for which the contractor will be paid."

BEGIN PROJECT I-5711
-L- STA. 18+03.85

I:\2016\16\I-5711\RDY_XPL.L.dgn
6/23/16

6/23/16

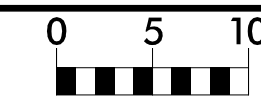

PROJ. REFERENCE NO.	SHEET NO.
I-5711	X-2

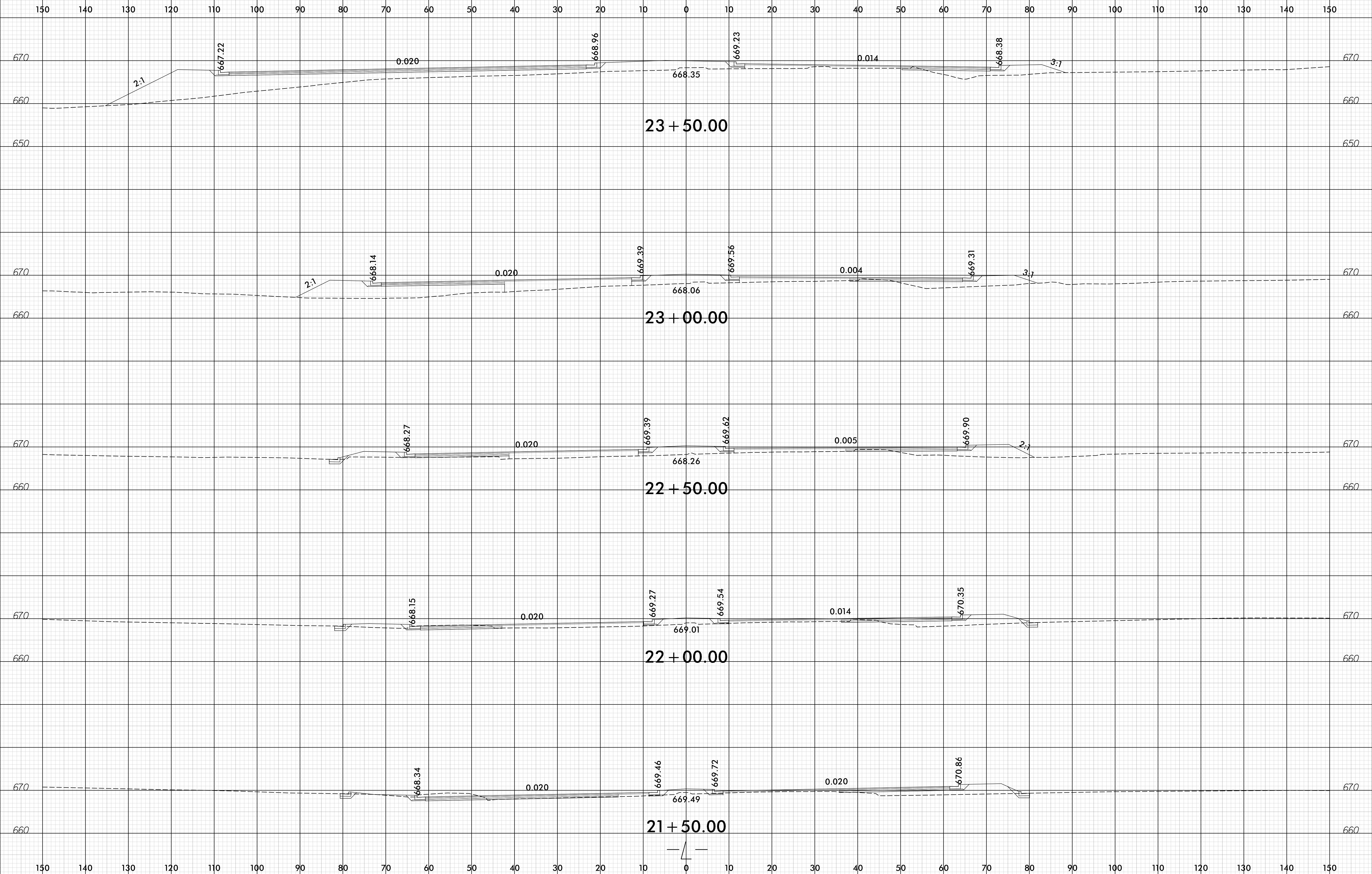

I:\2016\2016\I-5711\RDY_XPL.L.dgn

6/23/16



PROJ. REFERENCE NO.	SHEET NO.
I-5711	X-3

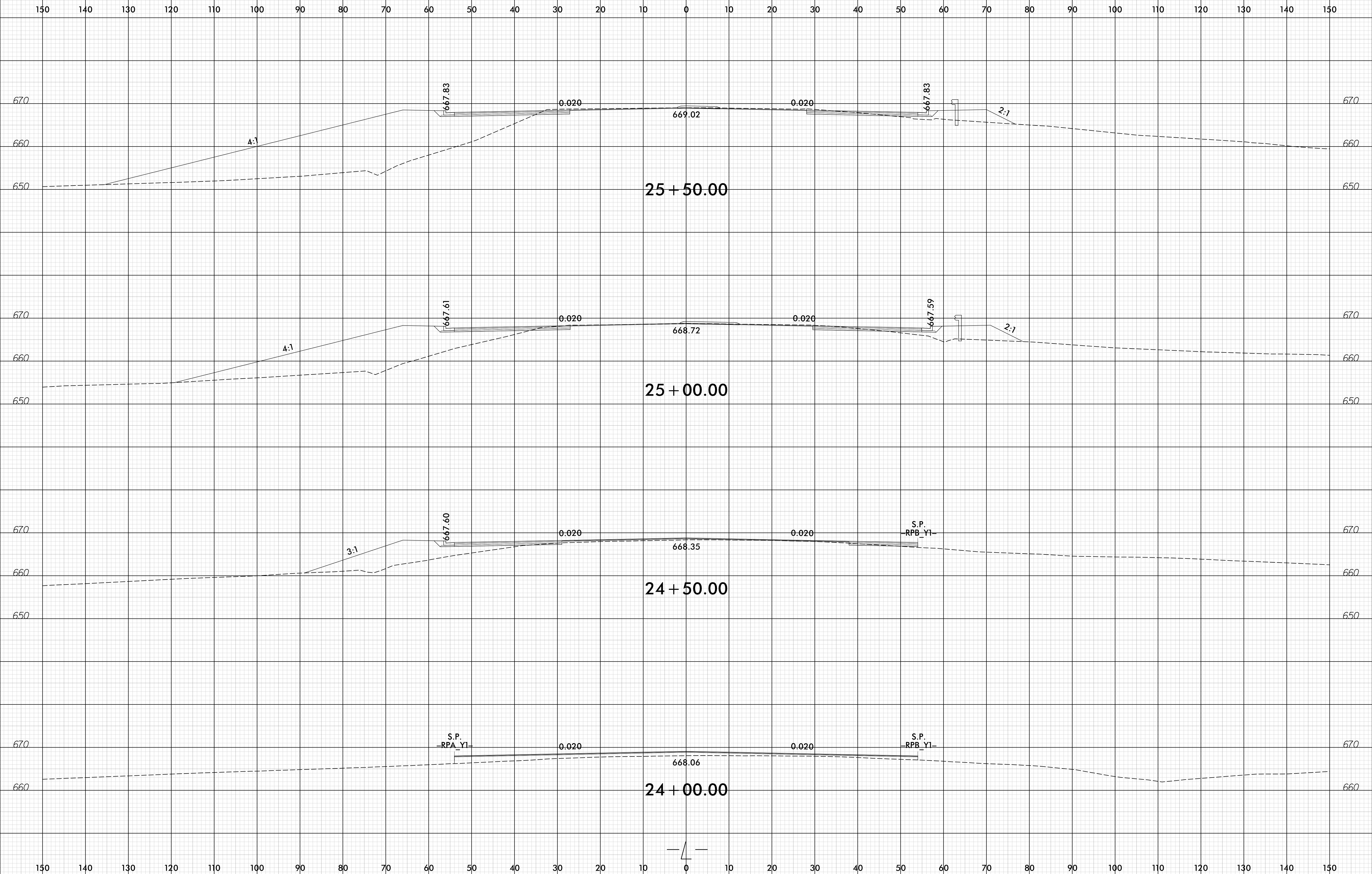

I:\2016\16\I-5711\RDY_XPL.L.dgn

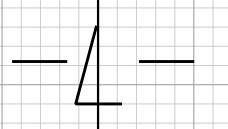

6/23/16

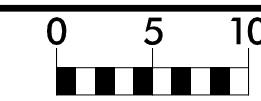

PROJ. REFERENCE NO.	SHEET NO.
I-5711	X-4

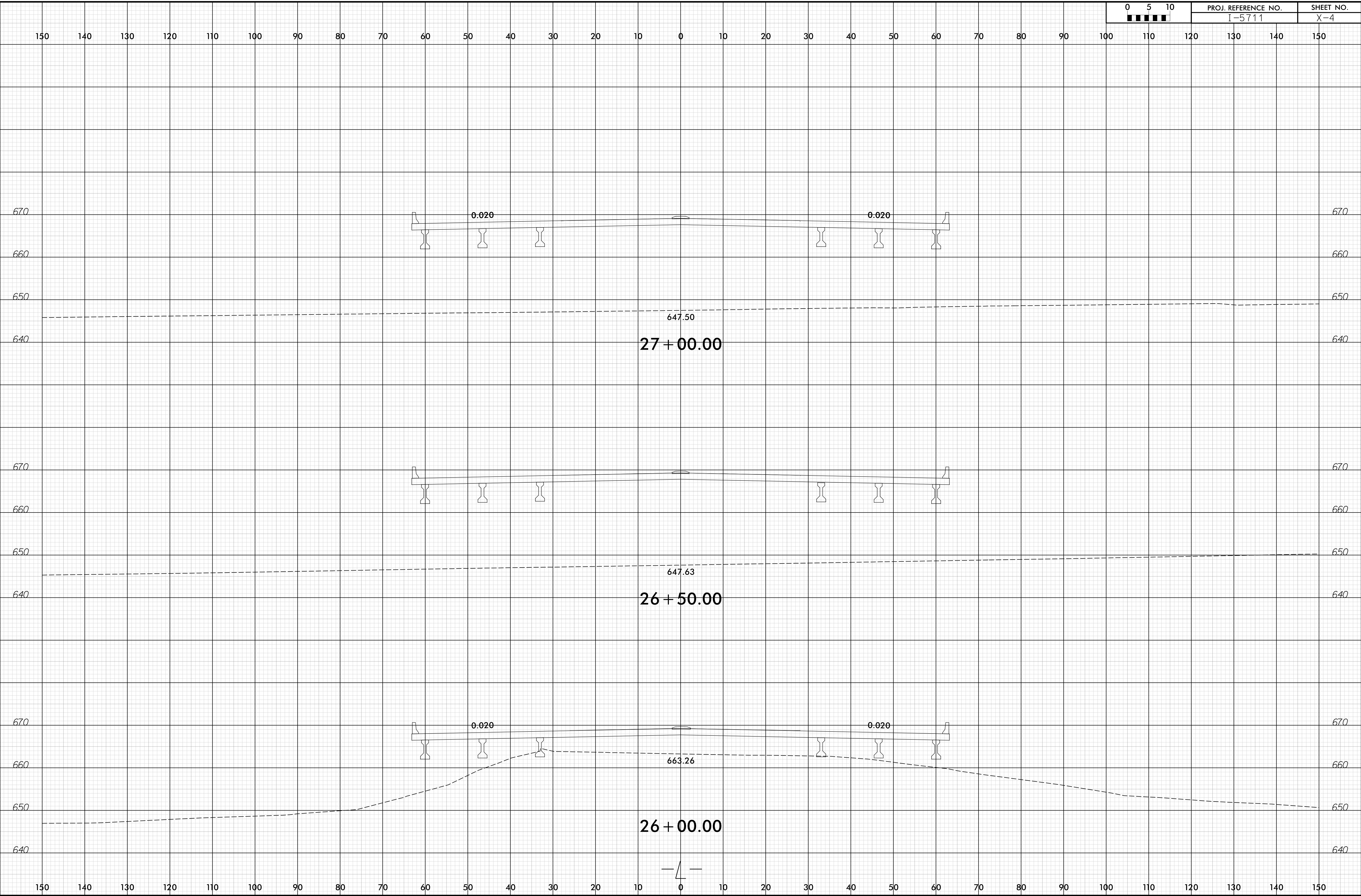

I:\2016\2016\I-5711\RDY_XPL.L.dgn

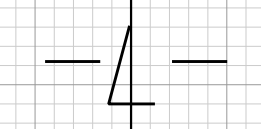

6/23/16

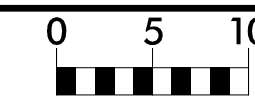

PROJ. REFERENCE NO.	SHEET NO.
I-5711	X-5

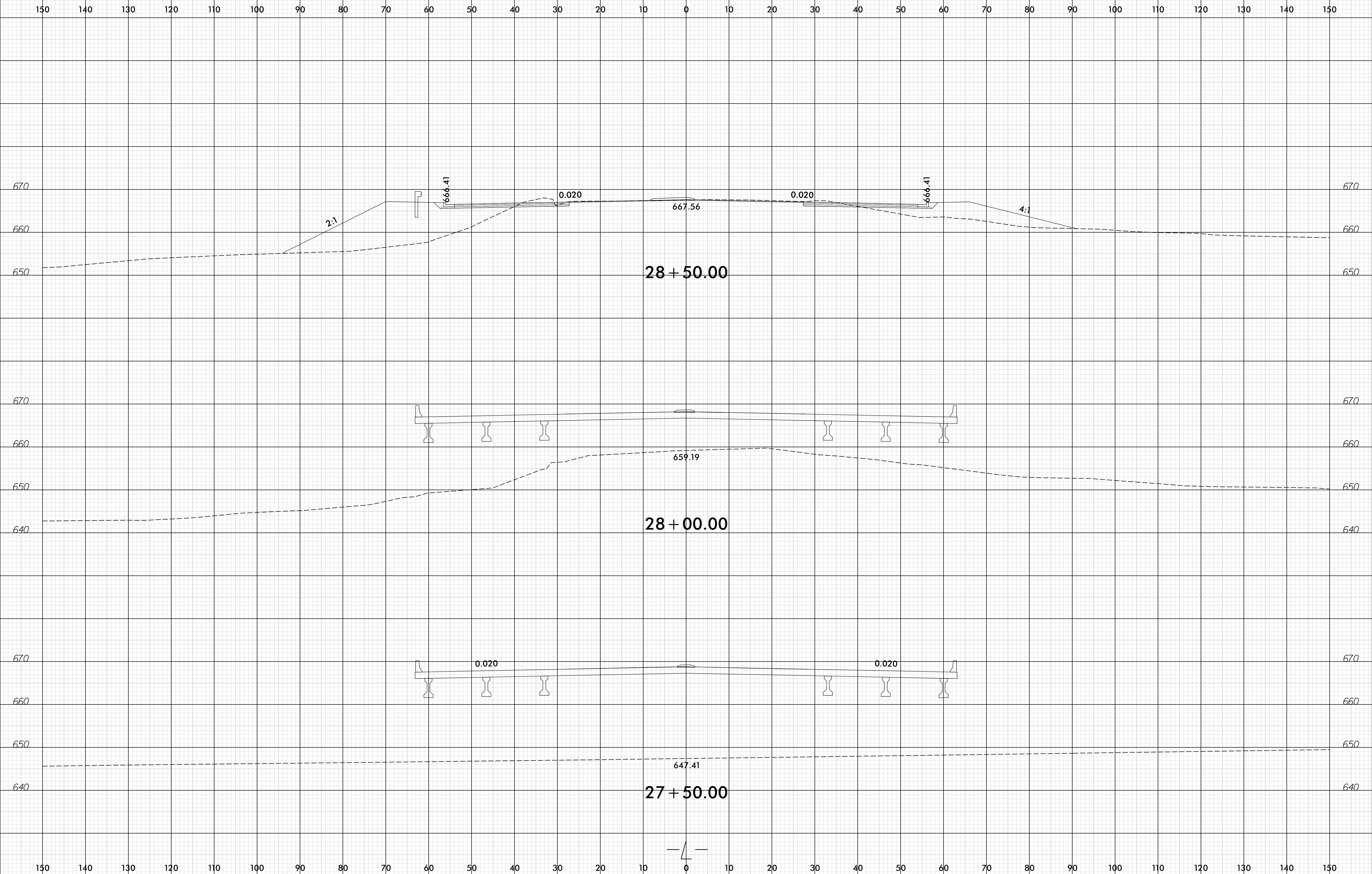

I:\2016\16\I-5711\RDY_XPL.L.dgn

6/23/16

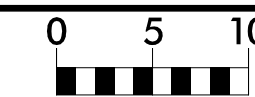

PROJ. REFERENCE NO.	SHEET NO.
I-5711	X-6

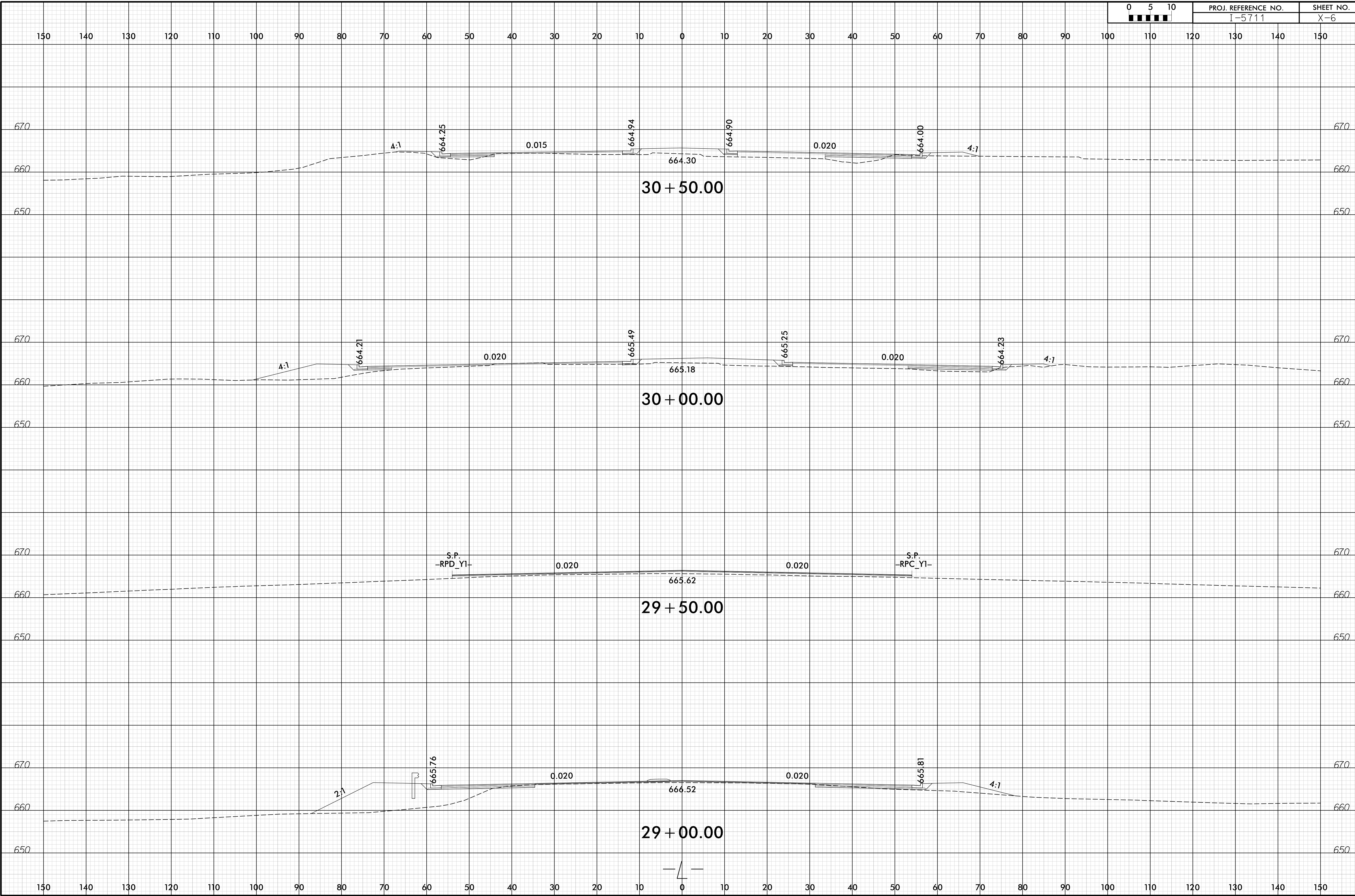

I:\2016\16\I-5711\RDY_XPL.L.dgn

6/23/16

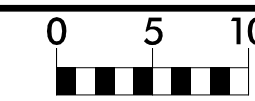

PROJ. REFERENCE NO.	SHEET NO.
I-5711	X-7

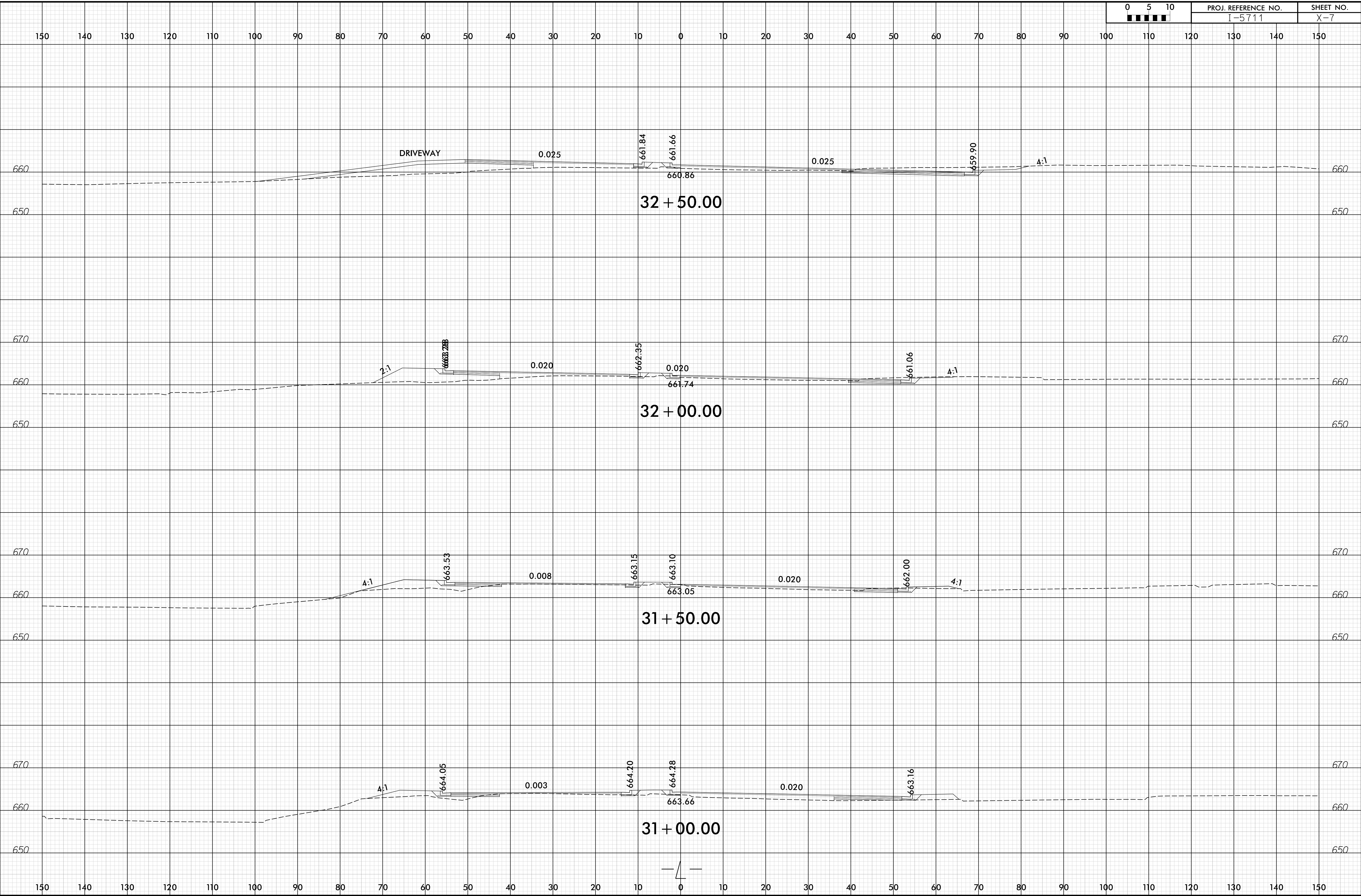

I:\2016\160621\160621-01\160621-01.dgn

6/23/16

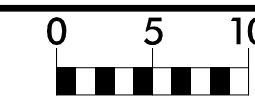

PROJ. REFERENCE NO.	SHEET NO.
I-5711	X-8

150 140 130 120 110 100 90 80 70 60 50 40 30 20 10 0 10 20 30 40 50 60 70 80 90 100 110 120 130 140 150

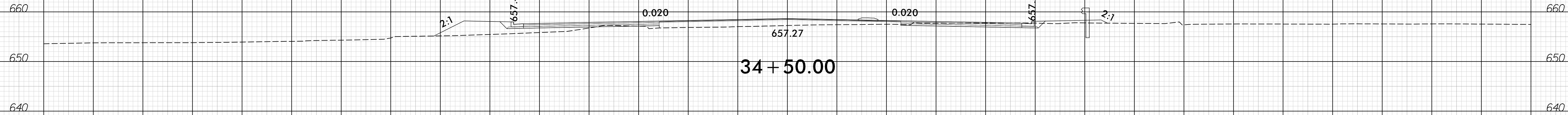

34 + 50.00



34 + 00.00

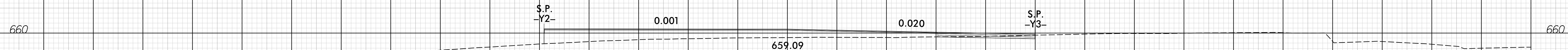

33 + 50.00

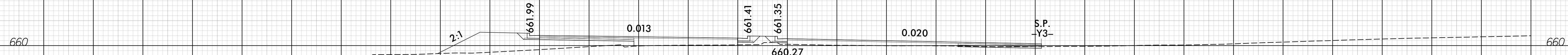

33 + 00.00

I:\2016\12\21\2016 I-5711 RDY_XPL.L.dgn

6/23/16

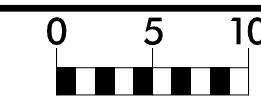

PROJ. REFERENCE NO.	SHEET NO.
I-5711	X-9

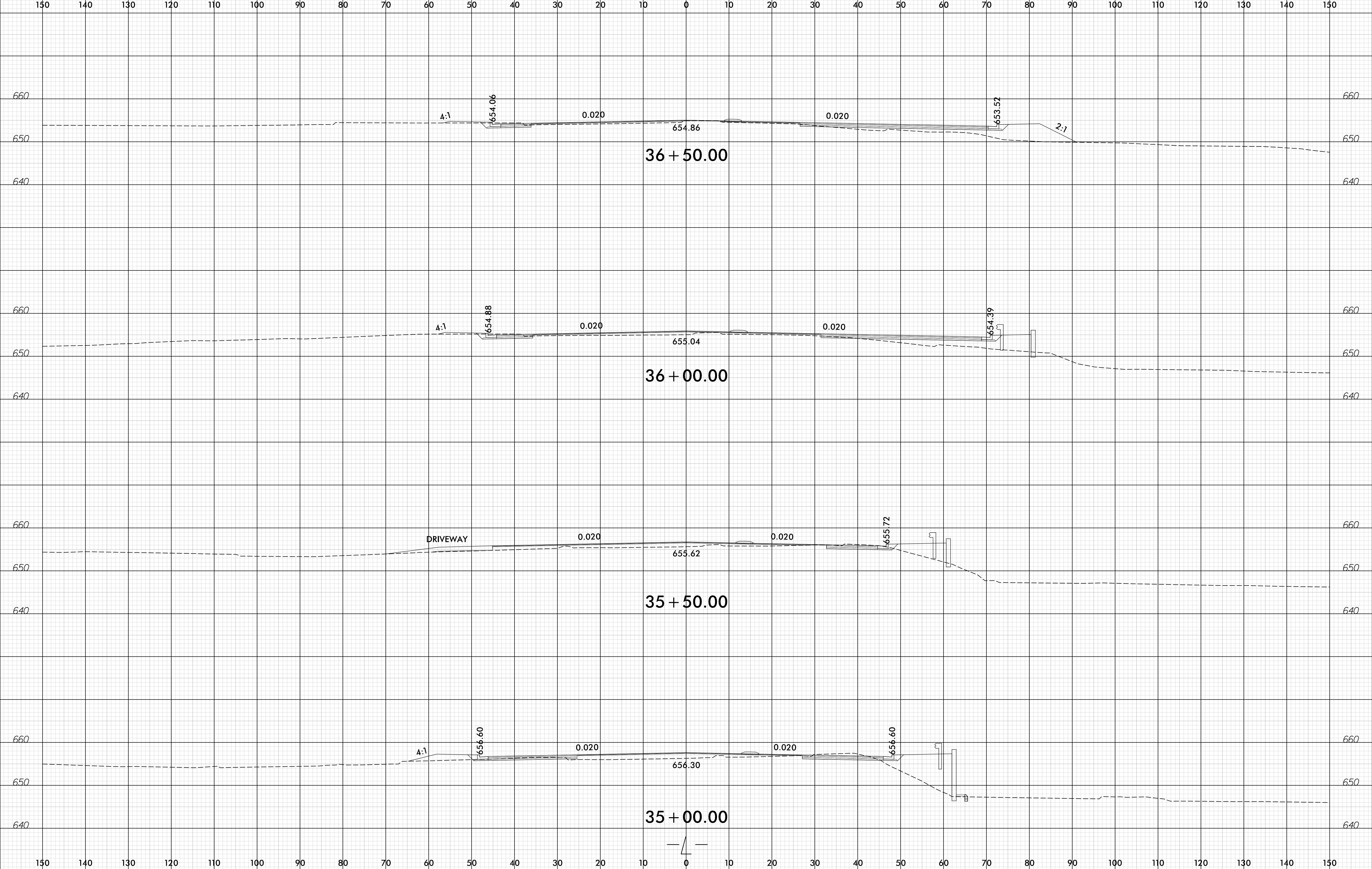

I:\2016\12\21\2016\I-5711\RDY_XPL.L.dgn

6/23/16

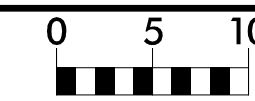

PROJ. REFERENCE NO.	SHEET NO.
I-5711	X-10

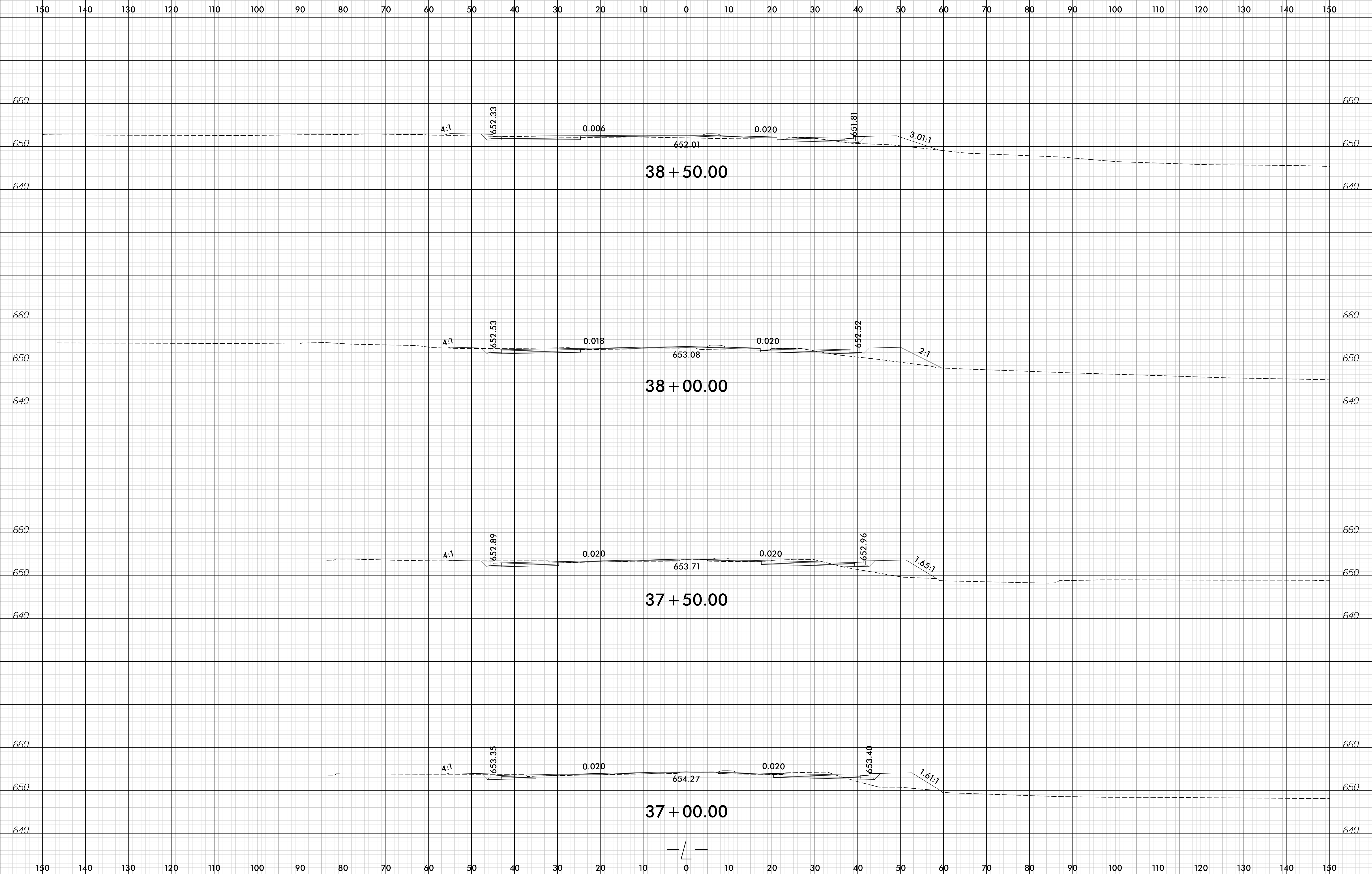

I:\2016\160623\160623.dgn

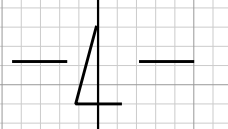

6/23/16

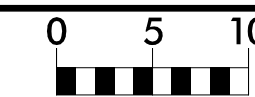

PROJ. REFERENCE NO.	SHEET NO.
I-5711	X-11

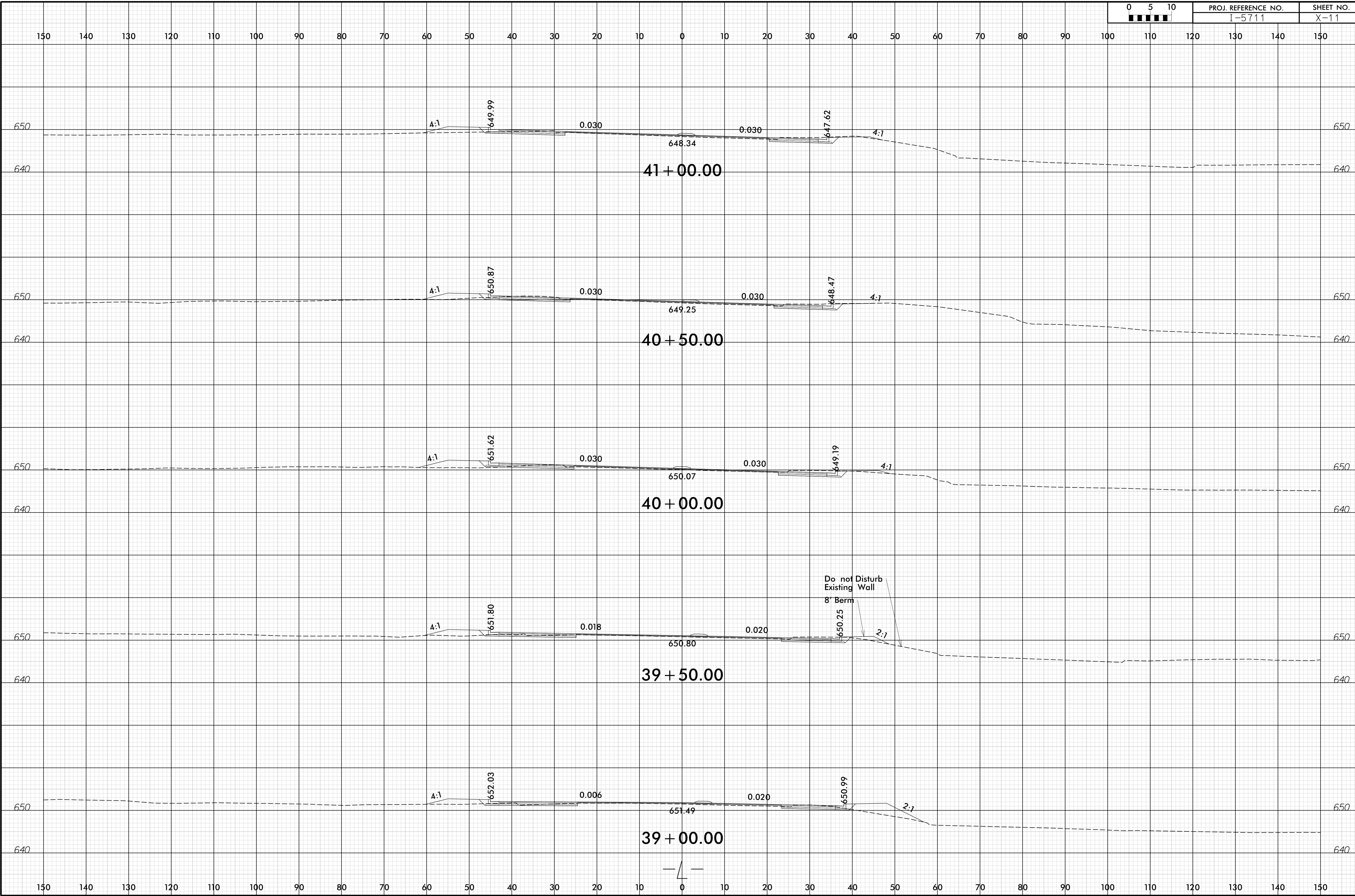

I:\2017\2018\I-5711\RDY_XPL.L.dgn

6/23/16

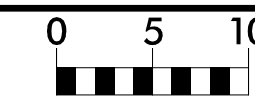

PROJ. REFERENCE NO.	SHEET NO.
I-5711	X-12

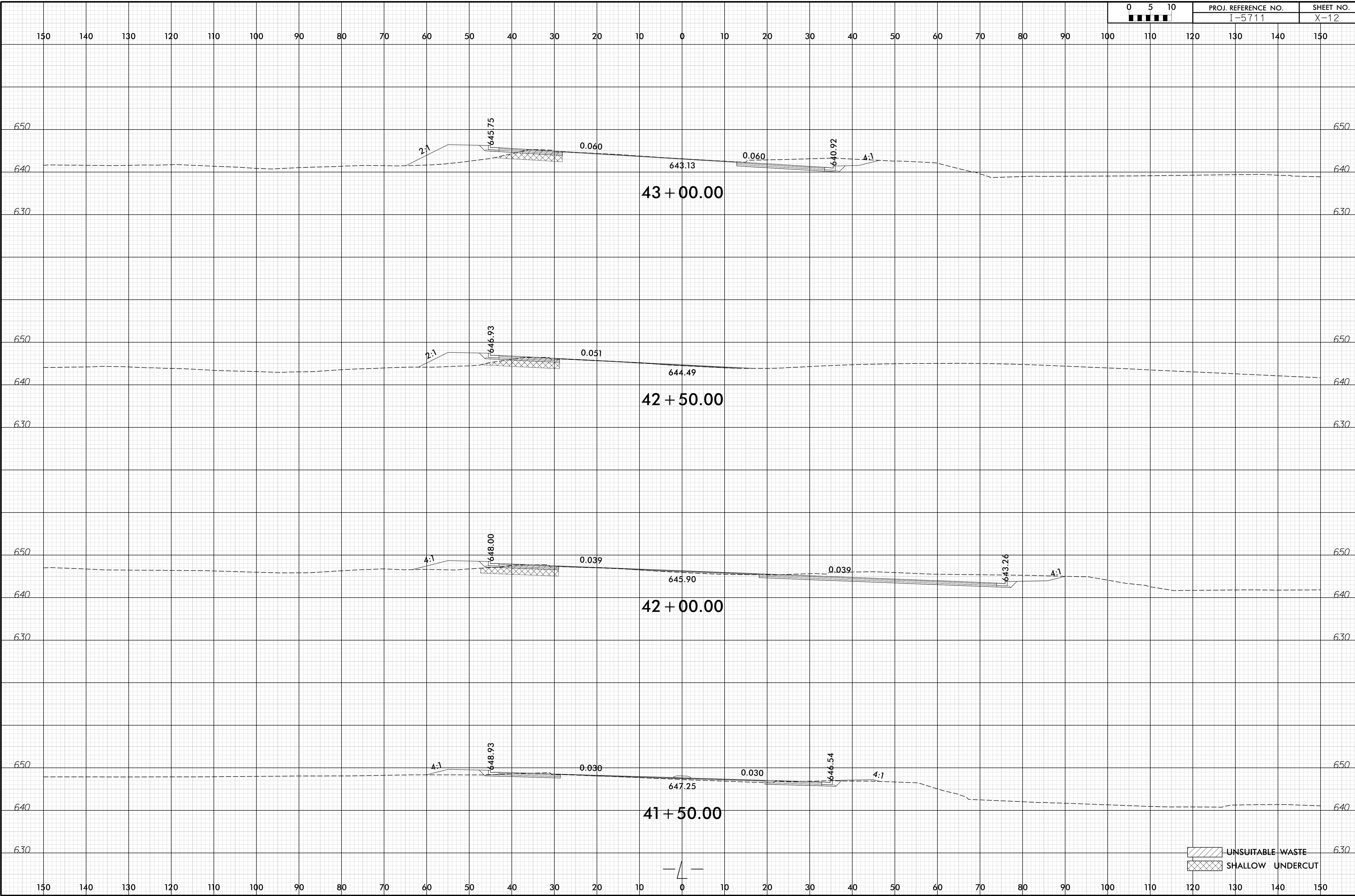

I:\5711\RDY_XPL.L.dgn

UNSUITABLE WASTE
 SHALLOW UNDERCUT

6/23/16

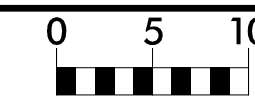

PROJ. REFERENCE NO.	SHEET NO.
I-5711	X-13

150 140 130 120 110 100 90 80 70 60 50 40 30 20 10 0 10 20 30 40 50 60 70 80 90 100 110 120 130 140 150

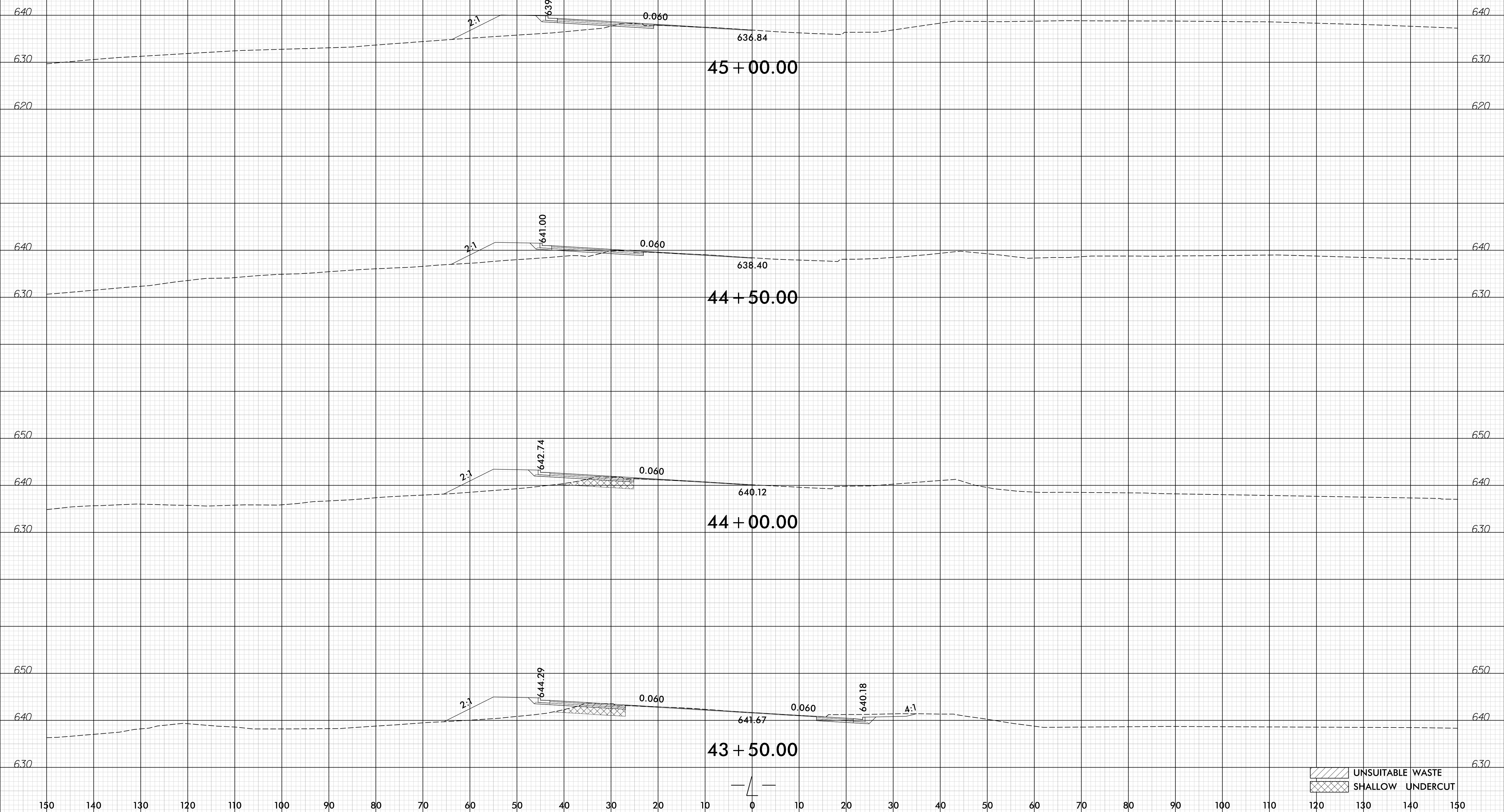

- UNSUITABLE WASTE
- SHALLOW UNDERCUT

I:\5711\RDY_XPL.L.dgn

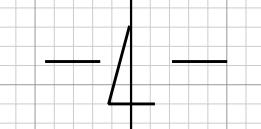

150 140 130 120 110 100 90 80 70 60 50 40 30 20 10 0 10 20 30 40 50 60 70 80 90 100 110 120 130 140 150

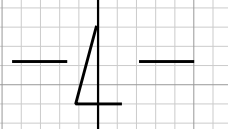
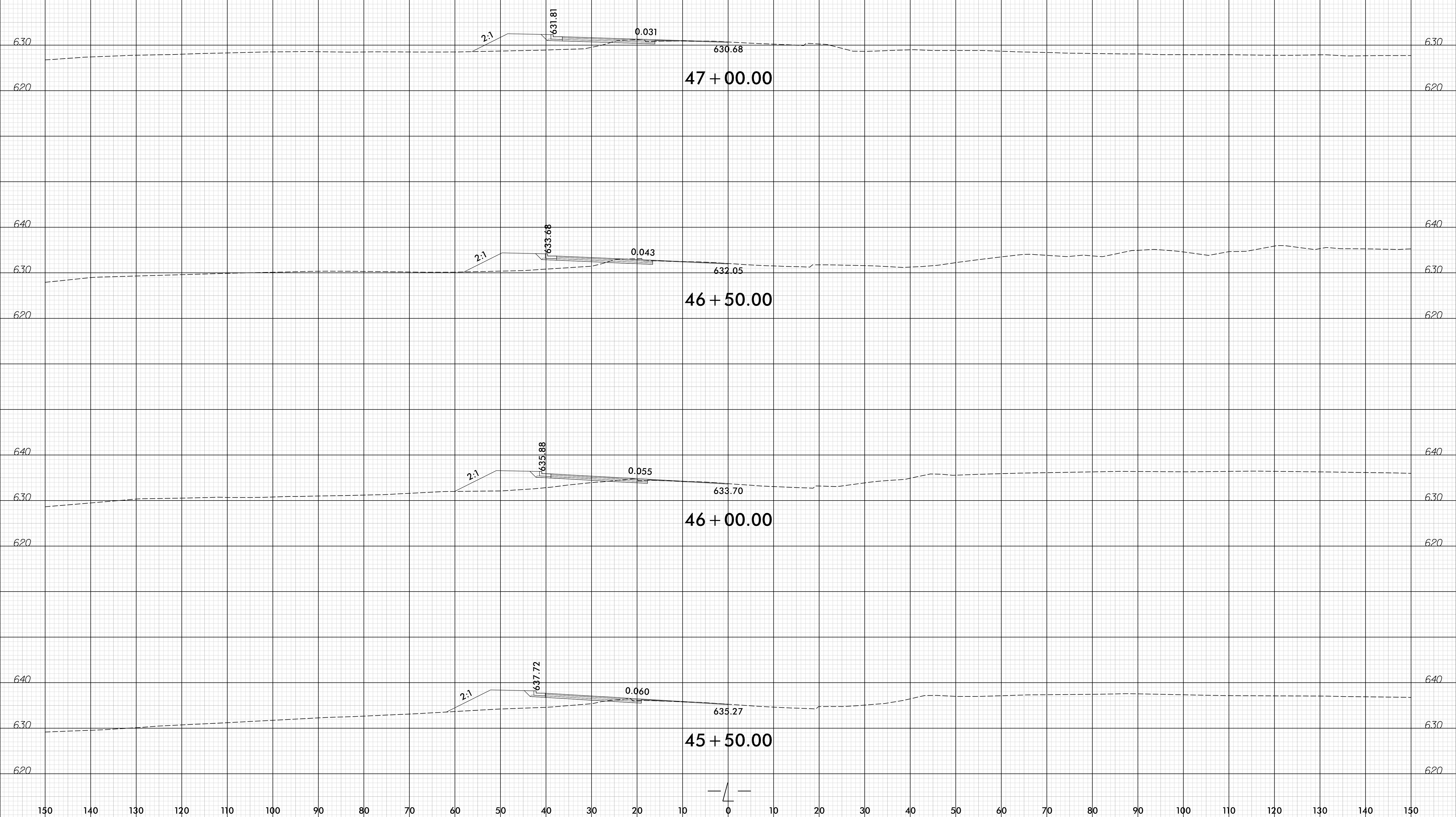

6/23/16

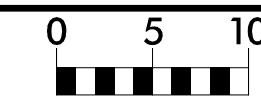

PROJ. REFERENCE NO.	SHEET NO.
I-5711	X-15

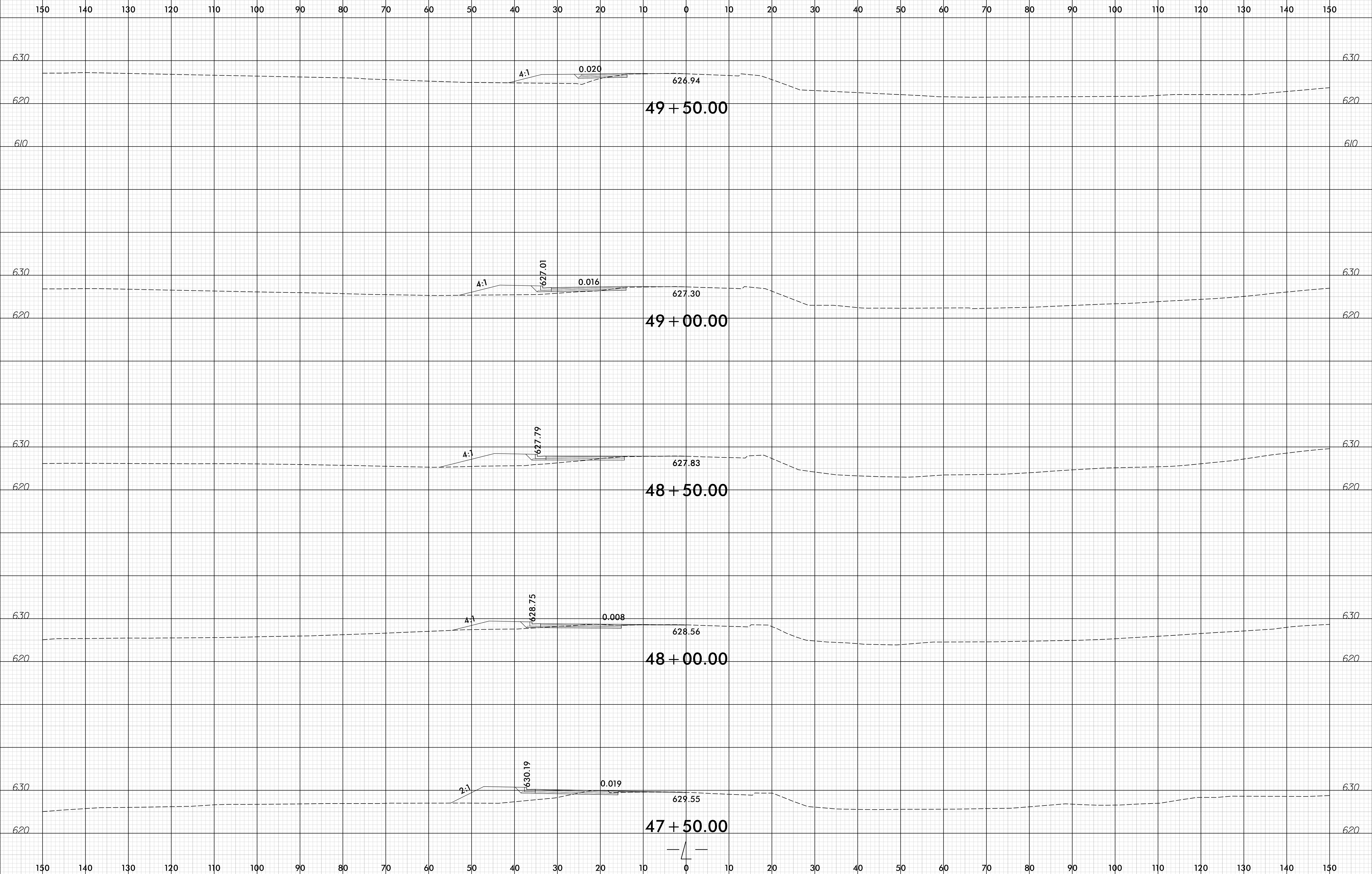

I:\2016\16\I-5711\RDY_XPL.L.dgn

6/23/16

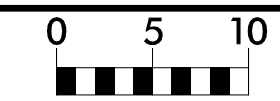

PROJ. REFERENCE NO.
I-5711

SHEET NO.
X-16

150 140 130 120 110 100 90 80 70 60 50 40 30 20 10 0 10 20 30 40 50 60 70 80 90 100 110 120 130 140 150

END PROJECT I-5711
-L- STA. 50+00.00

626.61

50 + 00.00

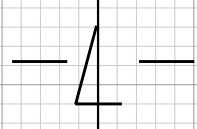

620

610

620

610

150 140 130 120 110 100 90 80 70 60 50 40 30 20 10 0 10 20 30 40 50 60 70 80 90 100 110 120 130 140 150

I:\2016\2016\I-5711\RDY_XPL.L.dgn

6/23/16

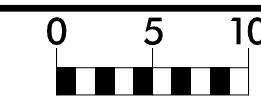

PROJ. REFERENCE NO.	SHEET NO.
I-5711	X-17

150 140 130 120 110 100 90 80 70 60 50 40 30 20 10 0 10 20 30 40 50 60 70 80 90 100 110 120 130 140 150

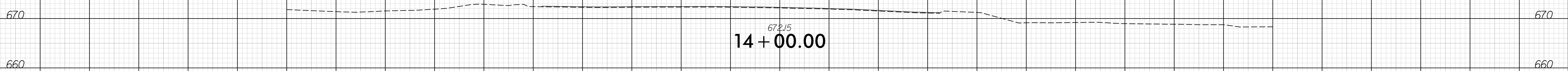
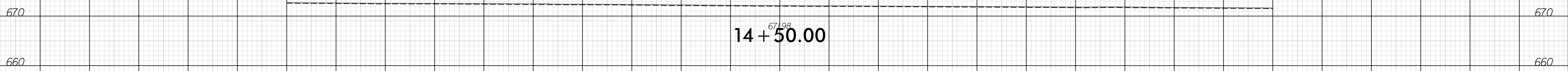

BEGIN CONSTRUCTION
-Y- STA. 13+72.47

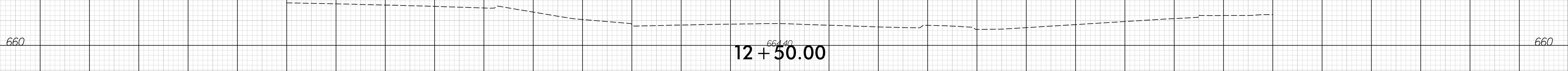
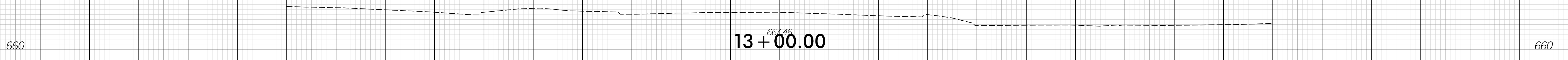
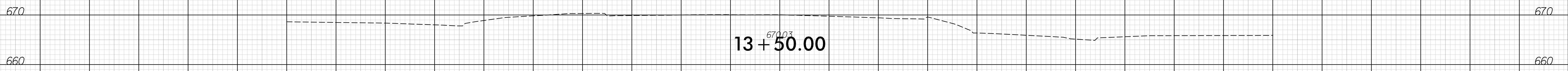

-Y-

I:\2016\12\23\2016\I-5711\RDY_XPL_Y.dgn

150 140 130 120 110 100 90 80 70 60 50 40 30 20 10 0 10 20 30 40 50 60 70 80 90 100 110 120 130 140 150

6/23/16

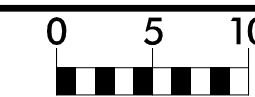

PROJ. REFERENCE NO.	SHEET NO.
I-5711	X-18

150 140 130 120 110 100 90 80 70 60 50 40 30 20 10 0 10 20 30 40 50 60 70 80 90 100 110 120 130 140 150

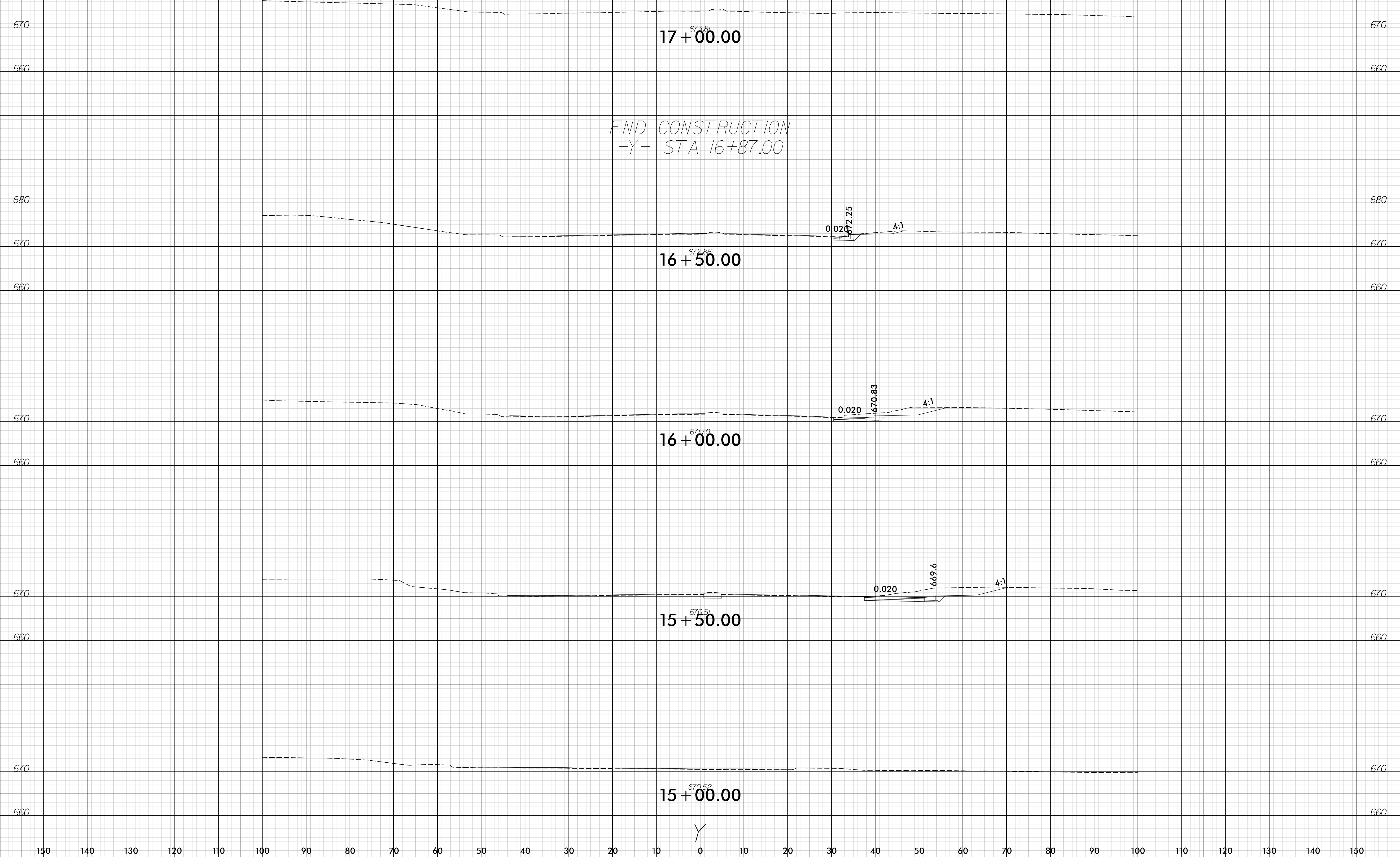

17 + 00.00

END CONSTRUCTION
-Y- STA 16+87.00

16 + 50.00

16 + 00.00

15 + 50.00

15 + 00.00

-Y-

I:\2016\16\I-5711\RDY_XPL_Y.dgn

150 140 130 120 110 100 90 80 70 60 50 40 30 20 10 0 10 20 30 40 50 60 70 80 90 100 110 120 130 140 150

6/23/16

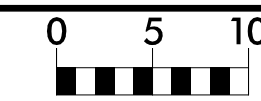

PROJ. REFERENCE NO.	SHEET NO.
I-5711	X-19

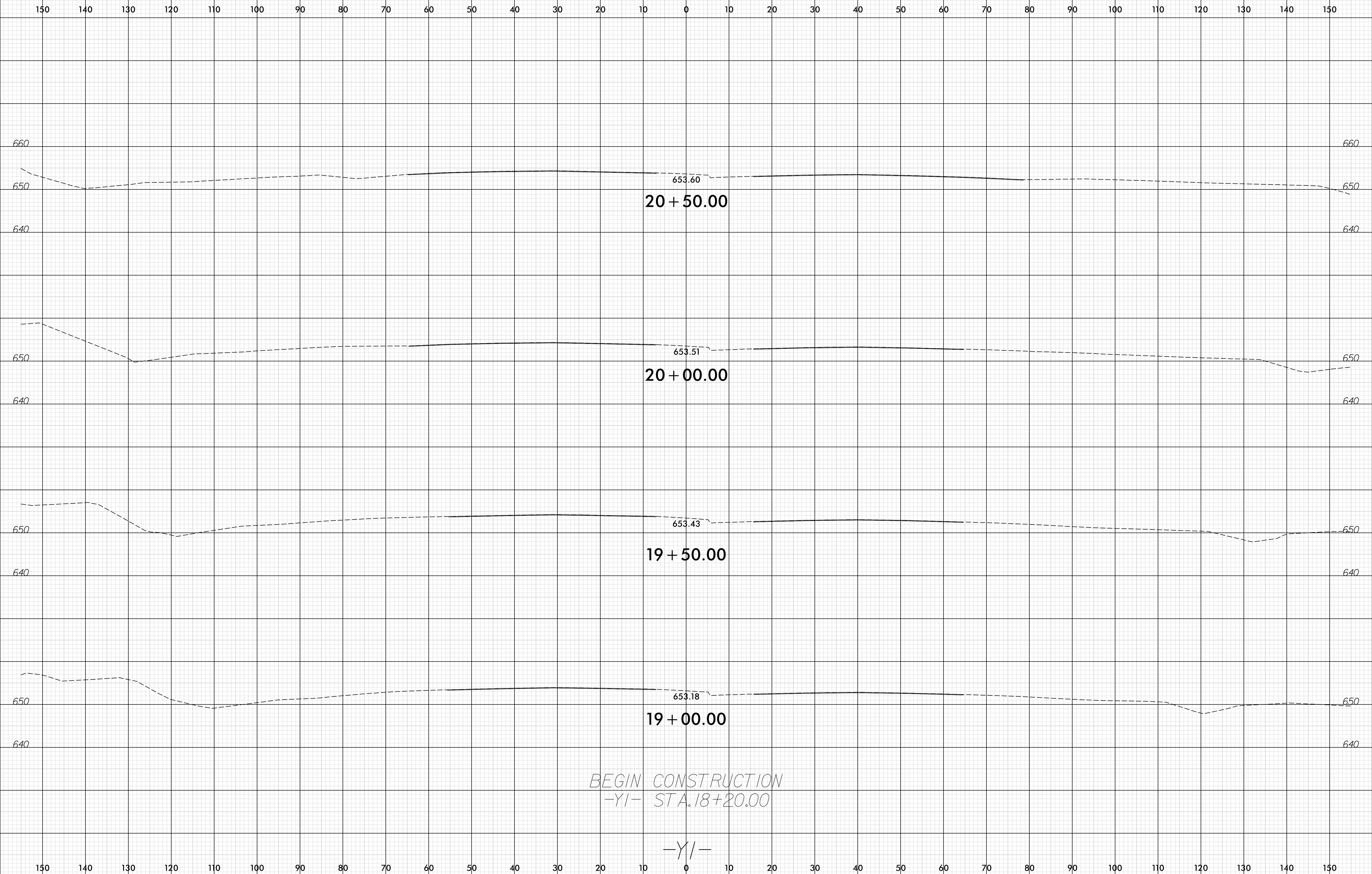

I:\2016\2016\I-5711\RDY_XPL_Y1.dgn

6/23/16

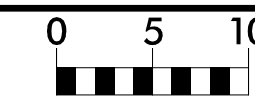

PROJ. REFERENCE NO.	SHEET NO.
I-5711	X-20

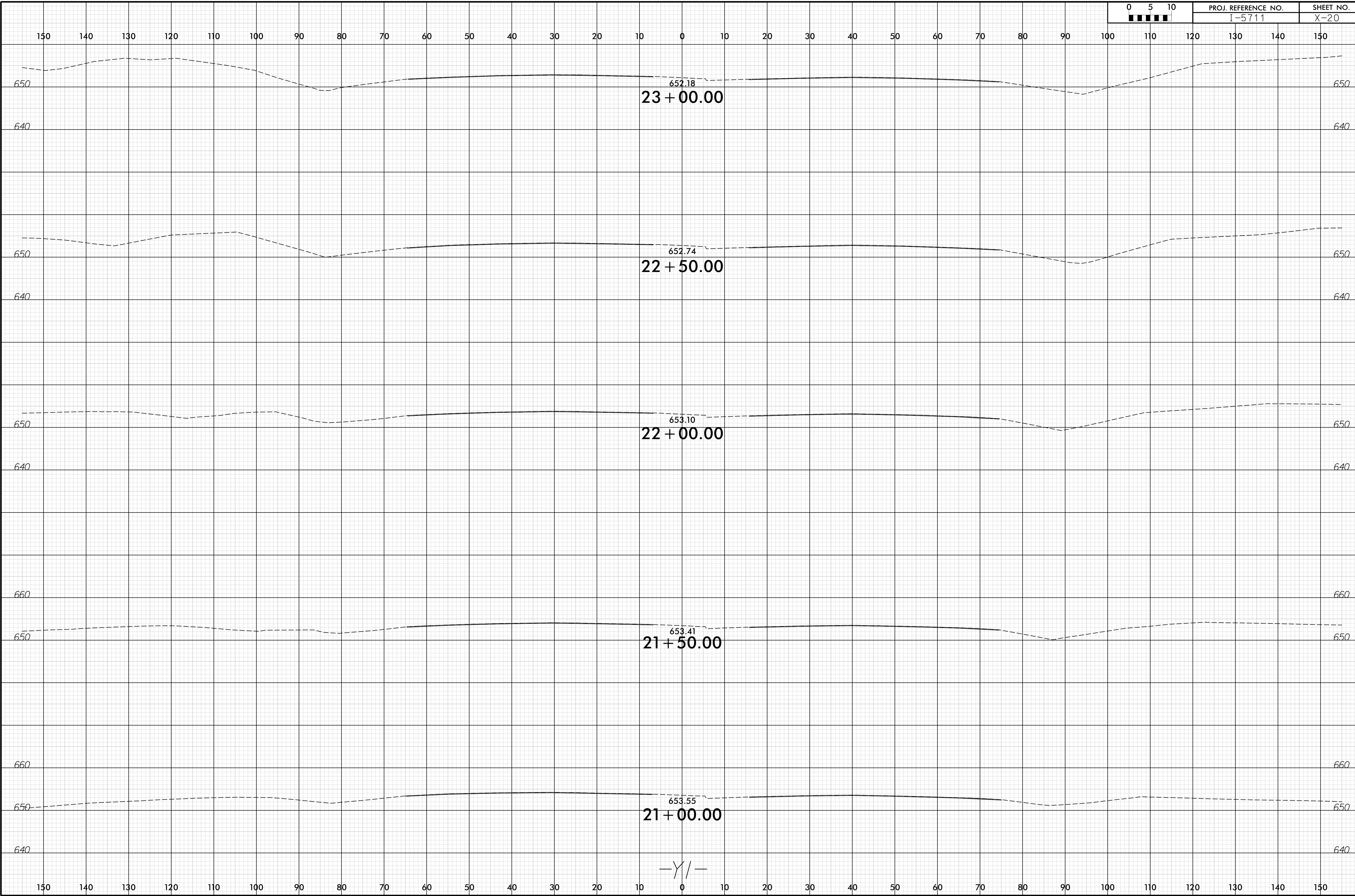

I:\2016\2016\I-5711\RDY_XPL_Y1.dgn
 6/23/16

—Y/—

6/23/16

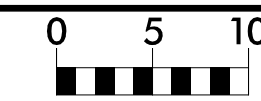

PROJ. REFERENCE NO.	SHEET NO.
I-5711	X-22

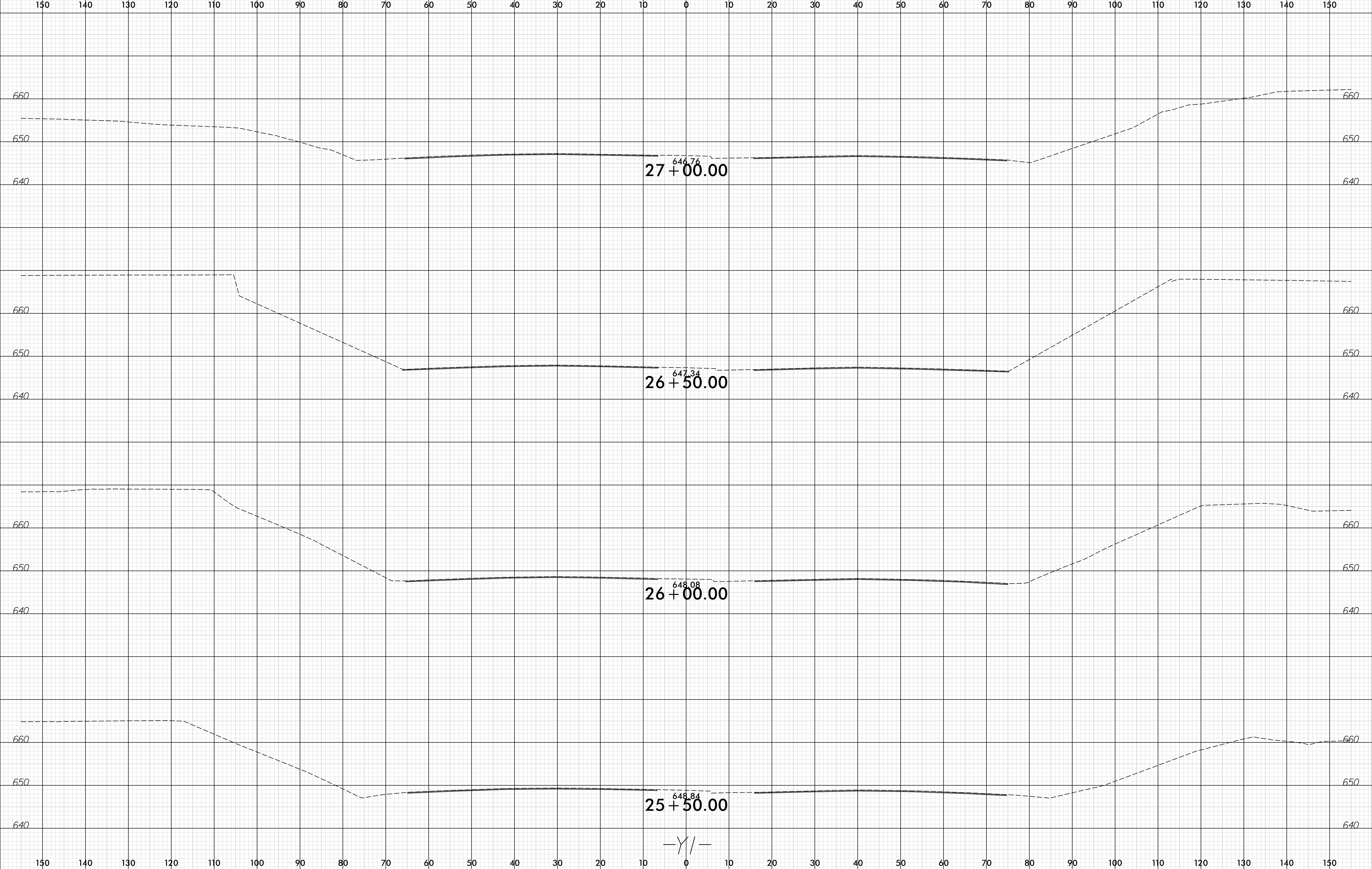

I:\2016\16\I-5711\RDY_XPL_Y1.dgn

-Y/-

6/23/16

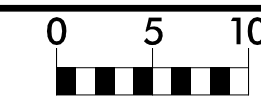

PROJ. REFERENCE NO.	SHEET NO.
I-5711	X-24

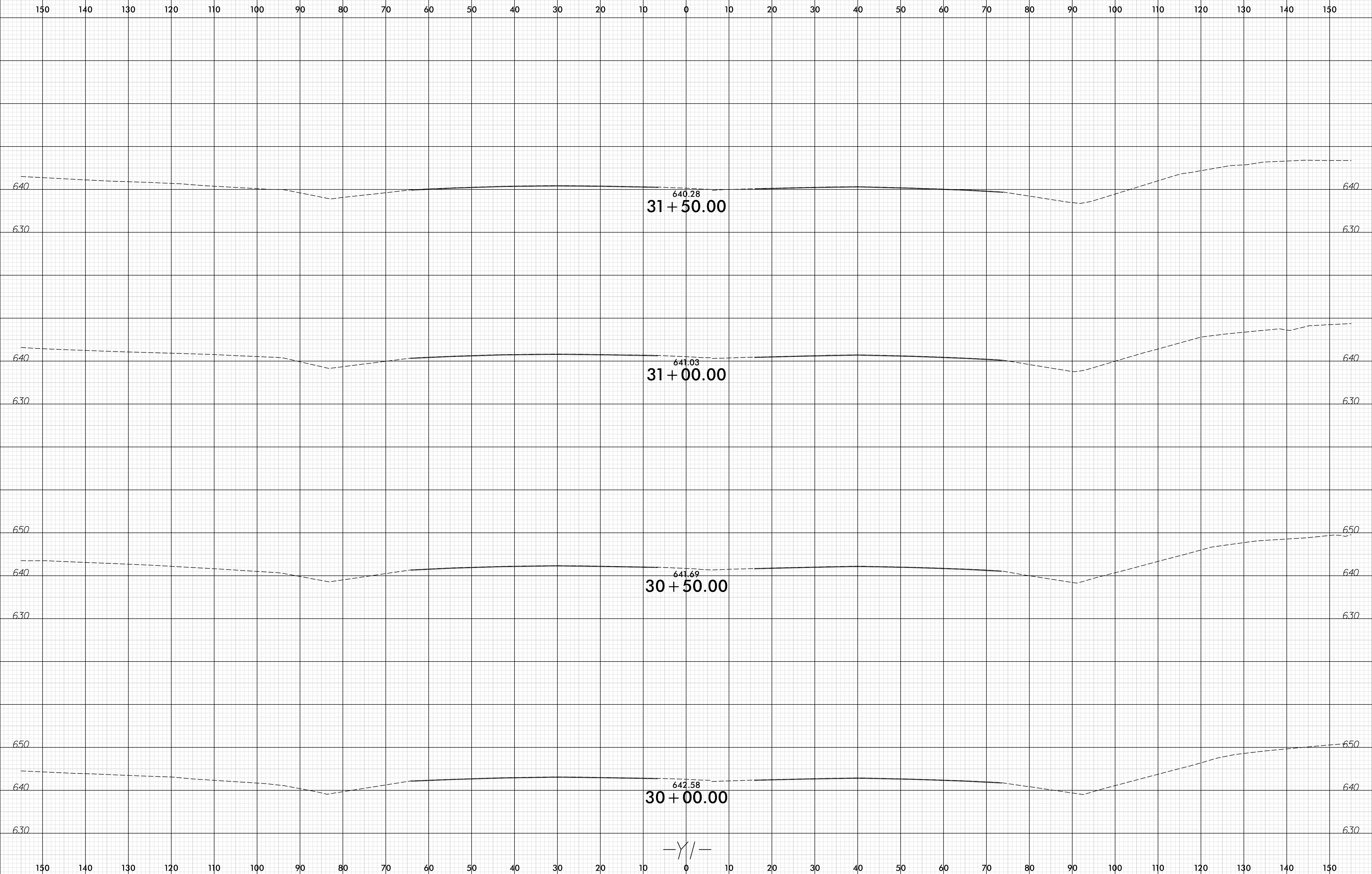

I:\2016\12\21\2016\I-5711\RDY_XPL_Y1.dgn

-Y/-

6/23/16

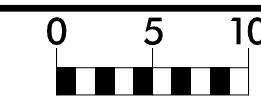

PROJ. REFERENCE NO.	SHEET NO.
I-5711	X-25

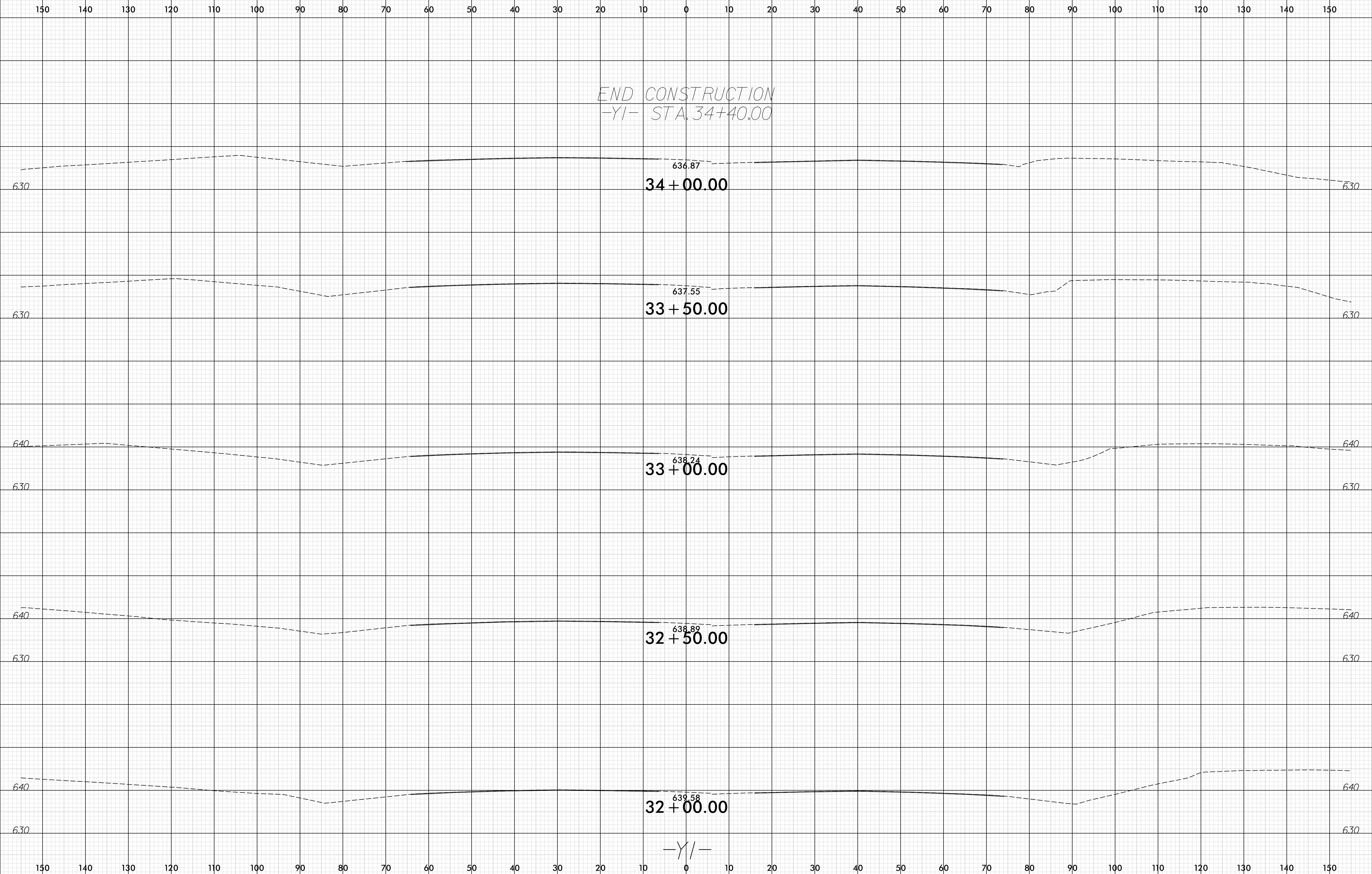

I:\2016\12\21\2016 I-5711 RDY - XPL - Y1.dgn

-YI-

6/23/16

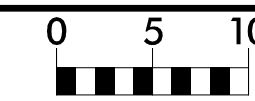

PROJ. REFERENCE NO.	SHEET NO.
I-5711	X-26

150 140 130 120 110 100 90 80 70 60 50 40 30 20 10 0 10 20 30 40 50 60 70 80 90 100 110 120 130 140 150

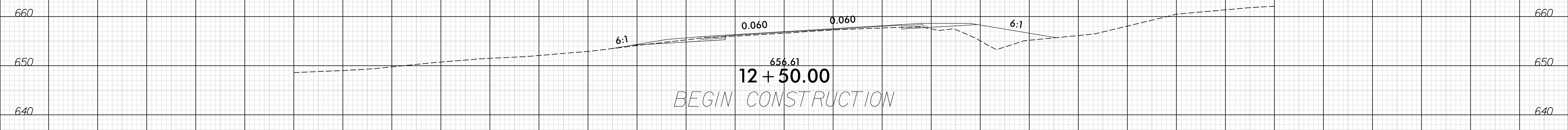
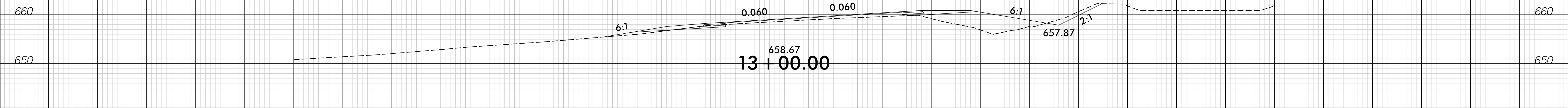
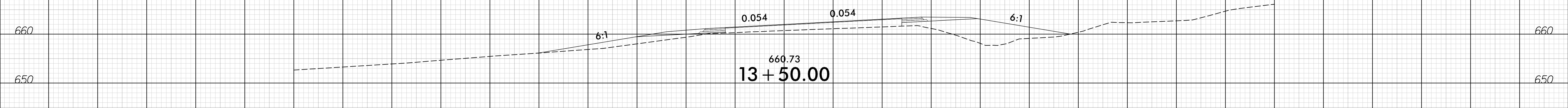
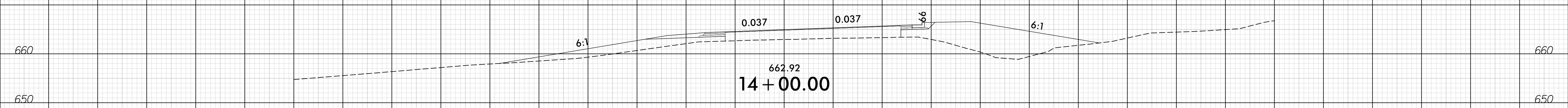

-RPA_YI-

I:\2016\2016\1-5711\RDY_XPL_RPA_YI.dgn

150 140 130 120 110 100 90 80 70 60 50 40 30 20 10 0 10 20 30 40 50 60 70 80 90 100 110 120 130 140 150

6/23/16

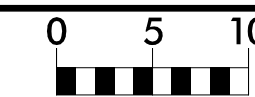

PROJ. REFERENCE NO.
I-5711

SHEET NO.
X-27

150 140 130 120 110 100 90 80 70 60 50 40 30 20 10 0 10 20 30 40 50 60 70 80 90 100 110 120 130 140 150

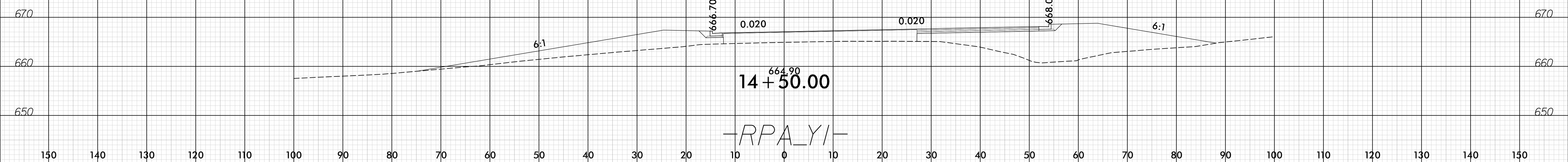

150 140 130 120 110 100 90 80 70 60 50 40 30 20 10 0 10 20 30 40 50 60 70 80 90 100 110 120 130 140 150

I:\2016\16\I-5711\RDY_XPL_RPA_YI.dgn

6/23/16

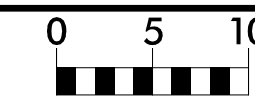

PROJ. REFERENCE NO.	SHEET NO.
I-5711	X-28

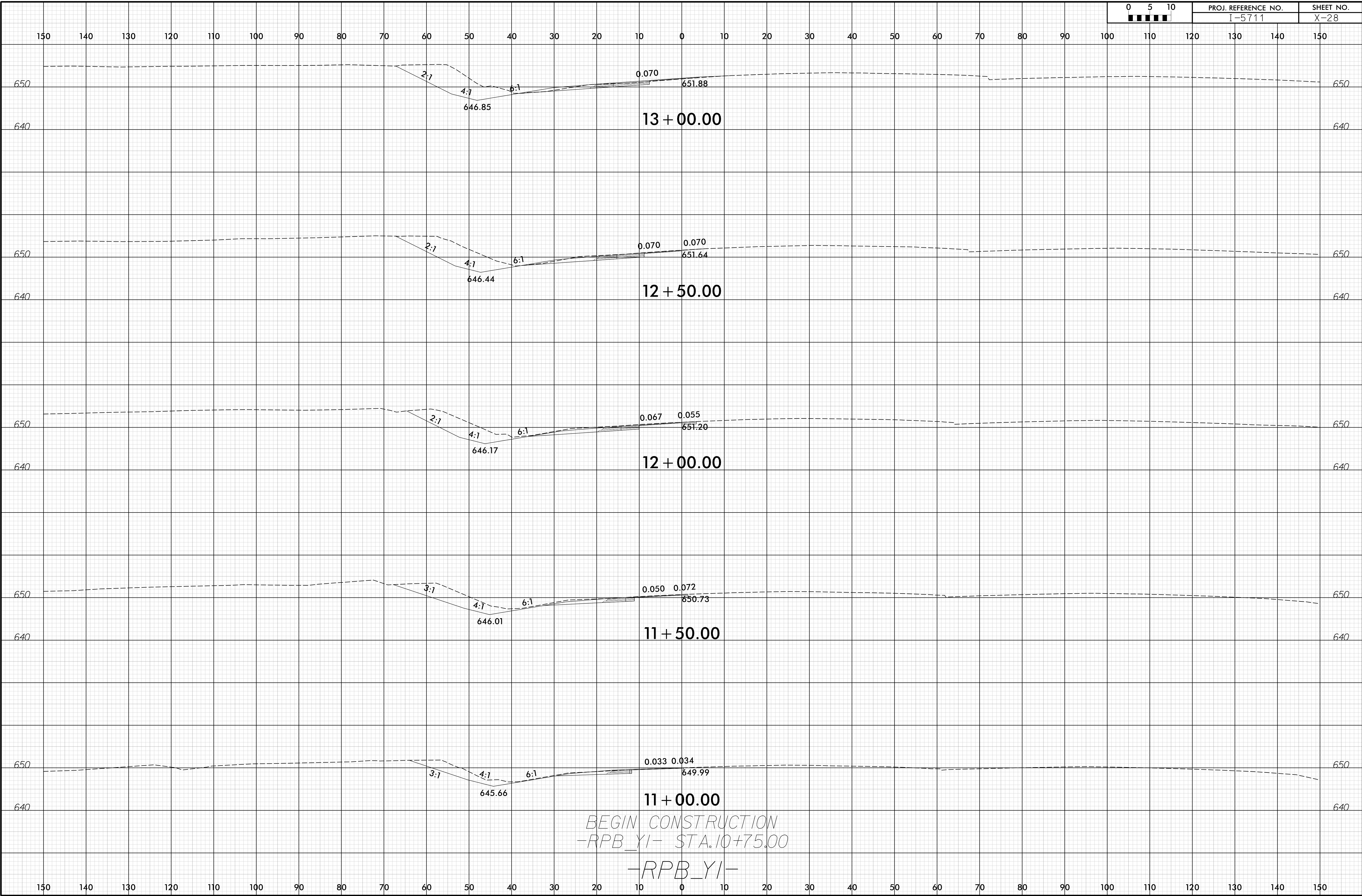

BEGIN CONSTRUCTION
 -RPB_YI- STA.10+75.00
 -RPB_YI-

I:\2016\12\23\16\I-5711\RDY_XPL_RPB_YI.dgn

6/23/16

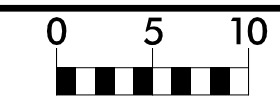

PROJ. REFERENCE NO.	I-5711
---------------------	--------

SHEET NO.	X-29
-----------	------

150 140 130 120 110 100 90 80 70 60 50 40 30 20 10 0 10 20 30 40 50 60 70 80 90 100 110 120 130 140 150

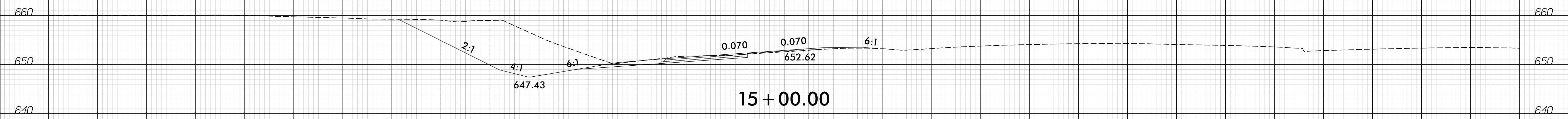

15 + 00.00

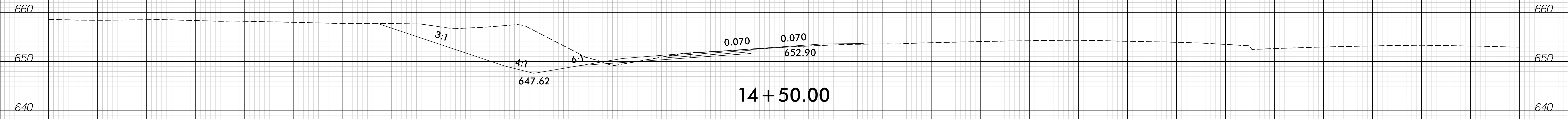

14 + 50.00

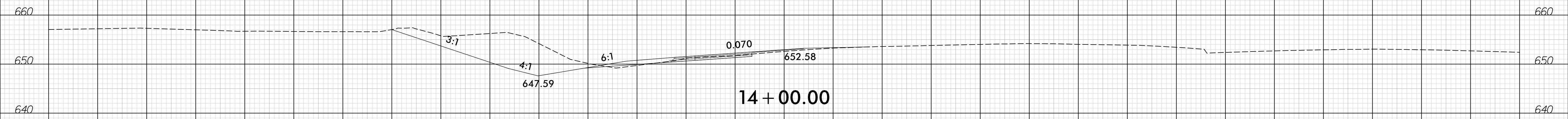

14 + 00.00

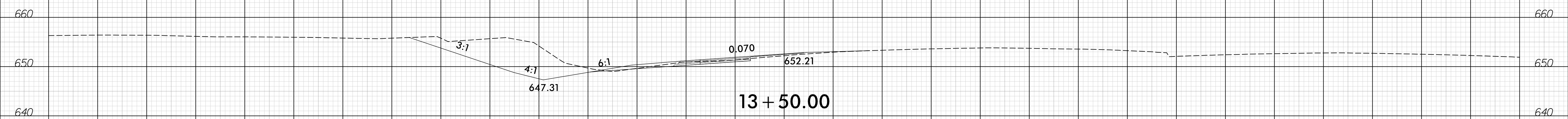

13 + 50.00

-RPB_YI-

I:\2016\12\21\2016\1-5711\RDY_XPL_RPB_YI.dgn
 2/21/2016 10:00:00 AM

6/23/16

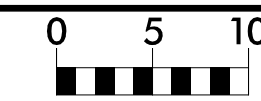

PROJ. REFERENCE NO.	SHEET NO.
I-5711	X-30

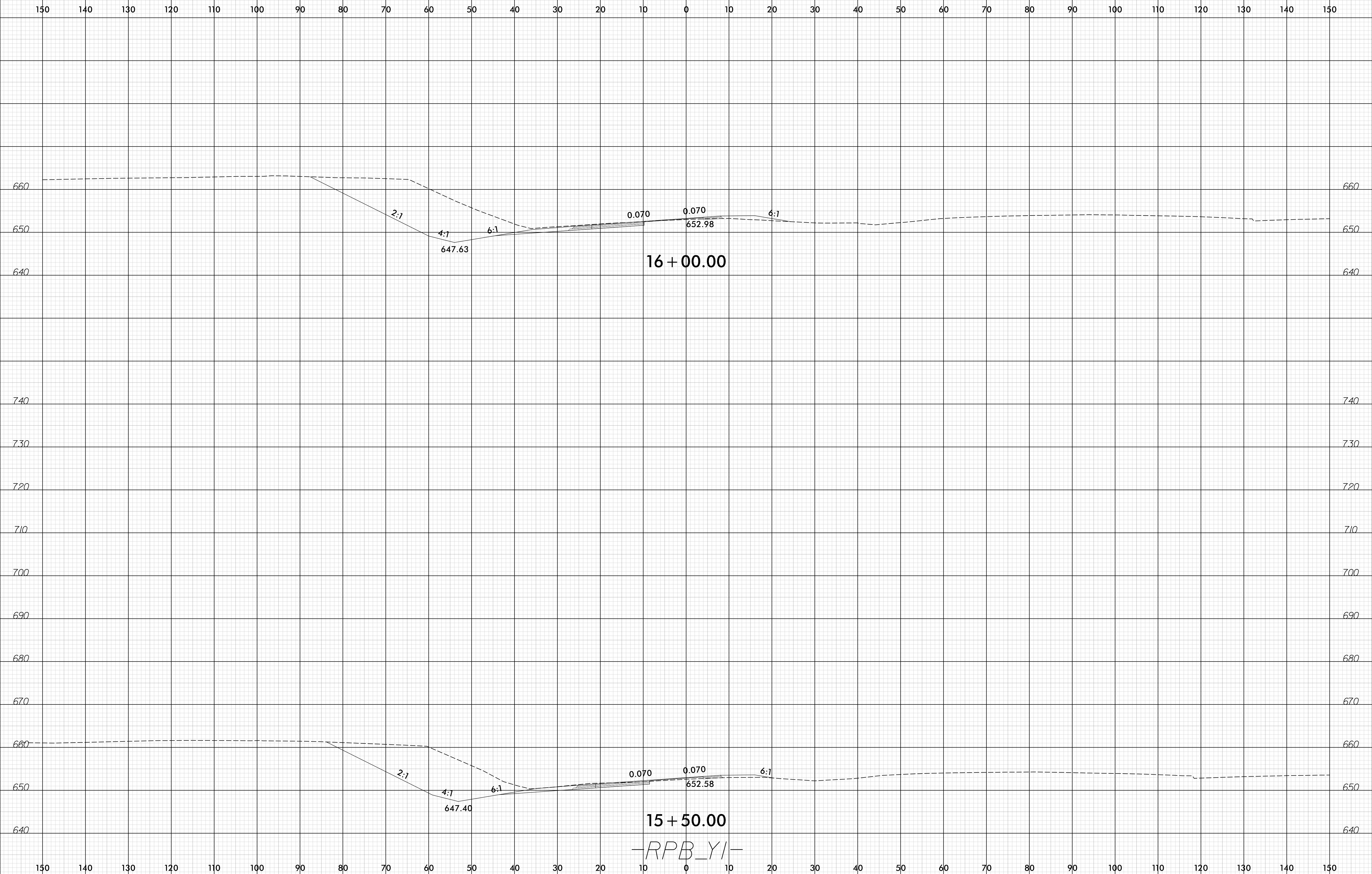

16 + 00.00

15 + 50.00

-RPB_YI-

I:\2016\16\I-5711\RDY_XPL_RPB_YI.dgn

6/23/16

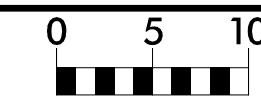

PROJ. REFERENCE NO.	SHEET NO.
I-5711	X-31

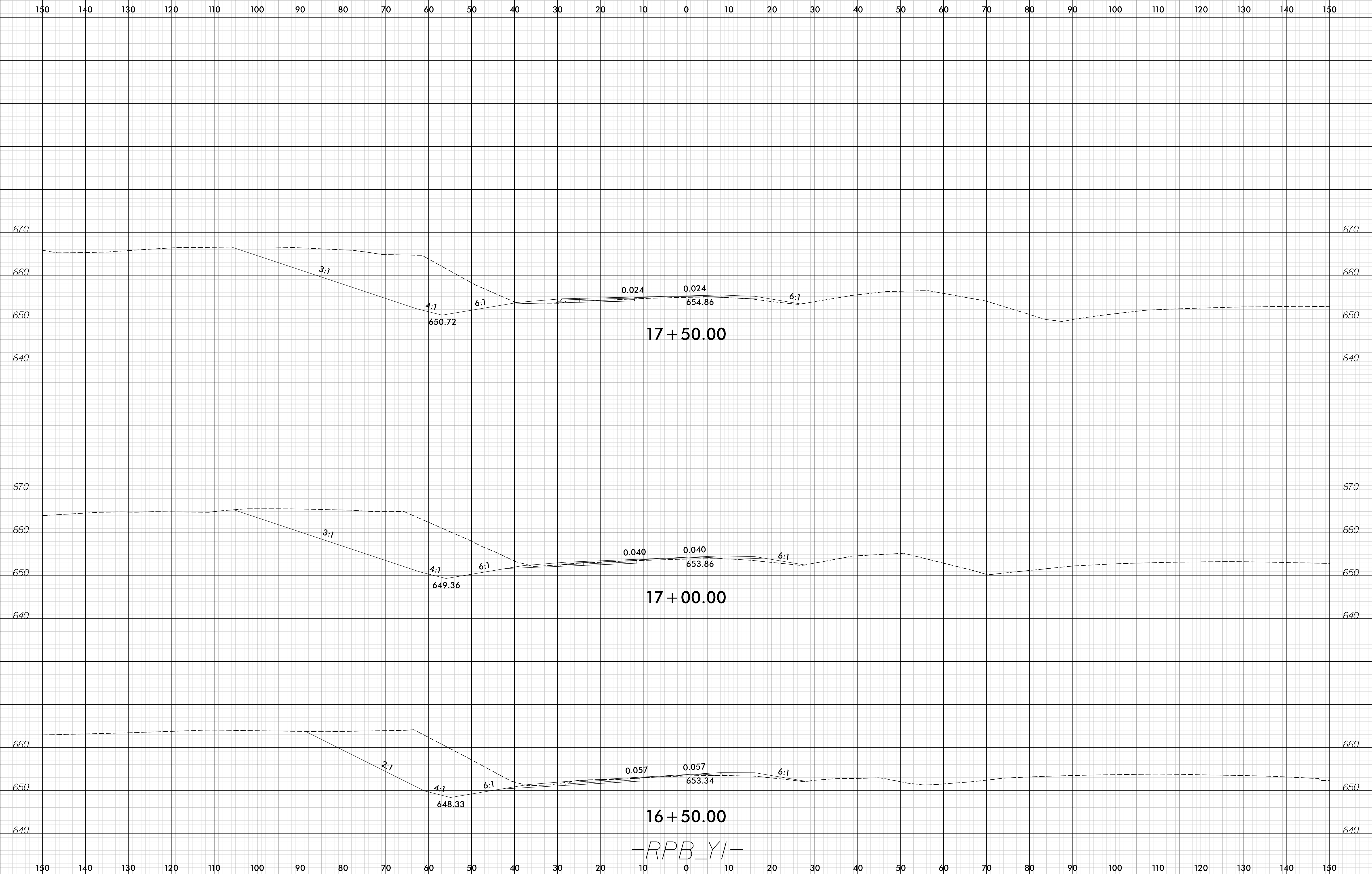

-RPB_YI-

I:\2016\2016\I-5711\RDY_XPL_RPB_YI.dgn

6/23/16

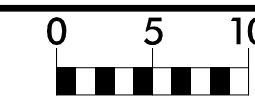

PROJ. REFERENCE NO.	SHEET NO.
I-5711	X-32

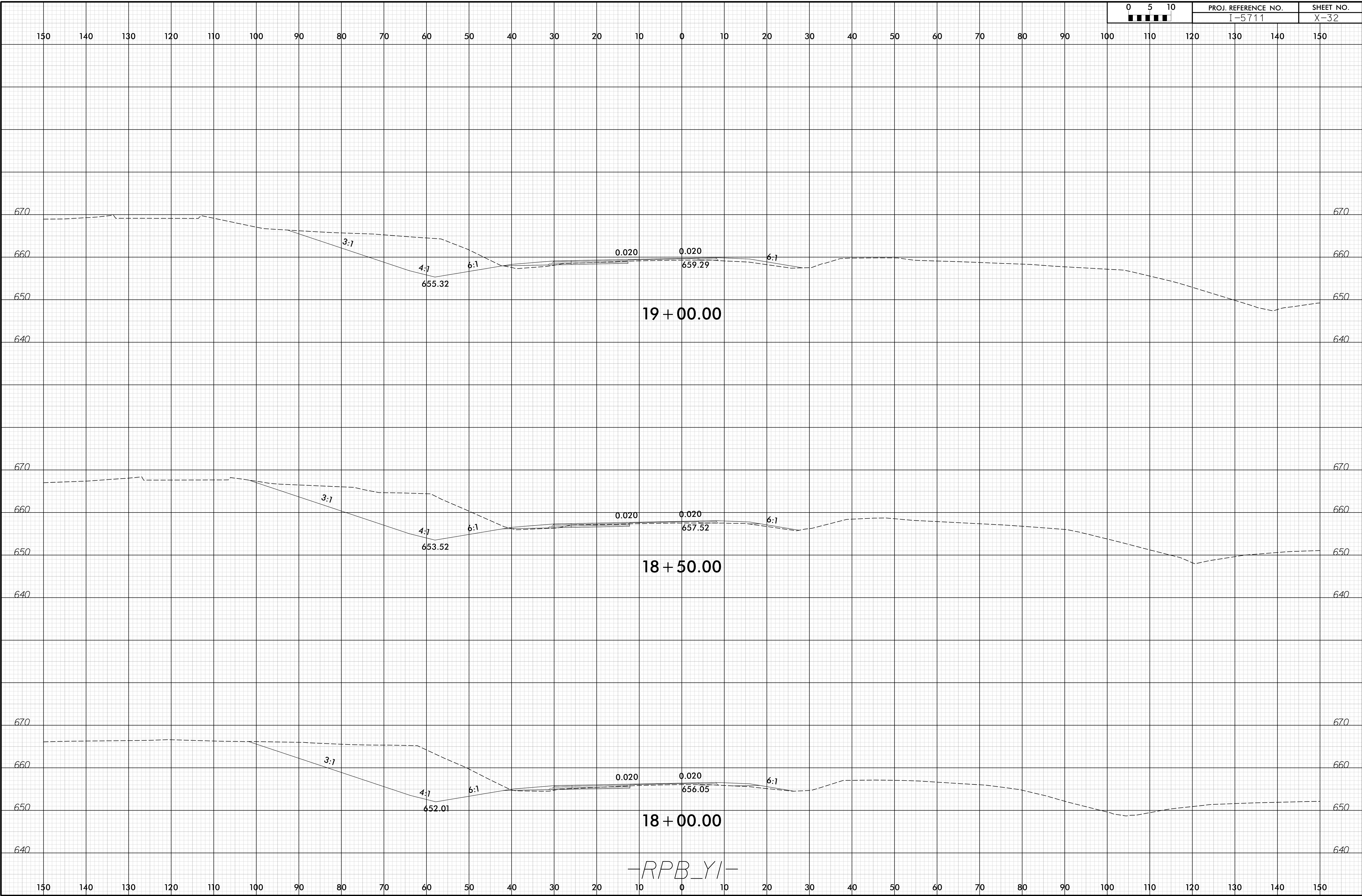

19 + 00.00

18 + 50.00

18 + 00.00

-RPB_YI-

I:\2016\16\I-5711\RDY_XPL_RPB_YI.dgn

6/23/16

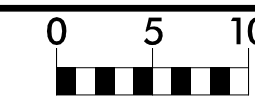

PROJ. REFERENCE NO.	SHEET NO.
I-5711	X-33

150 140 130 120 110 100 90 80 70 60 50 40 30 20 10 0 10 20 30 40 50 60 70 80 90 100 110 120 130 140 150

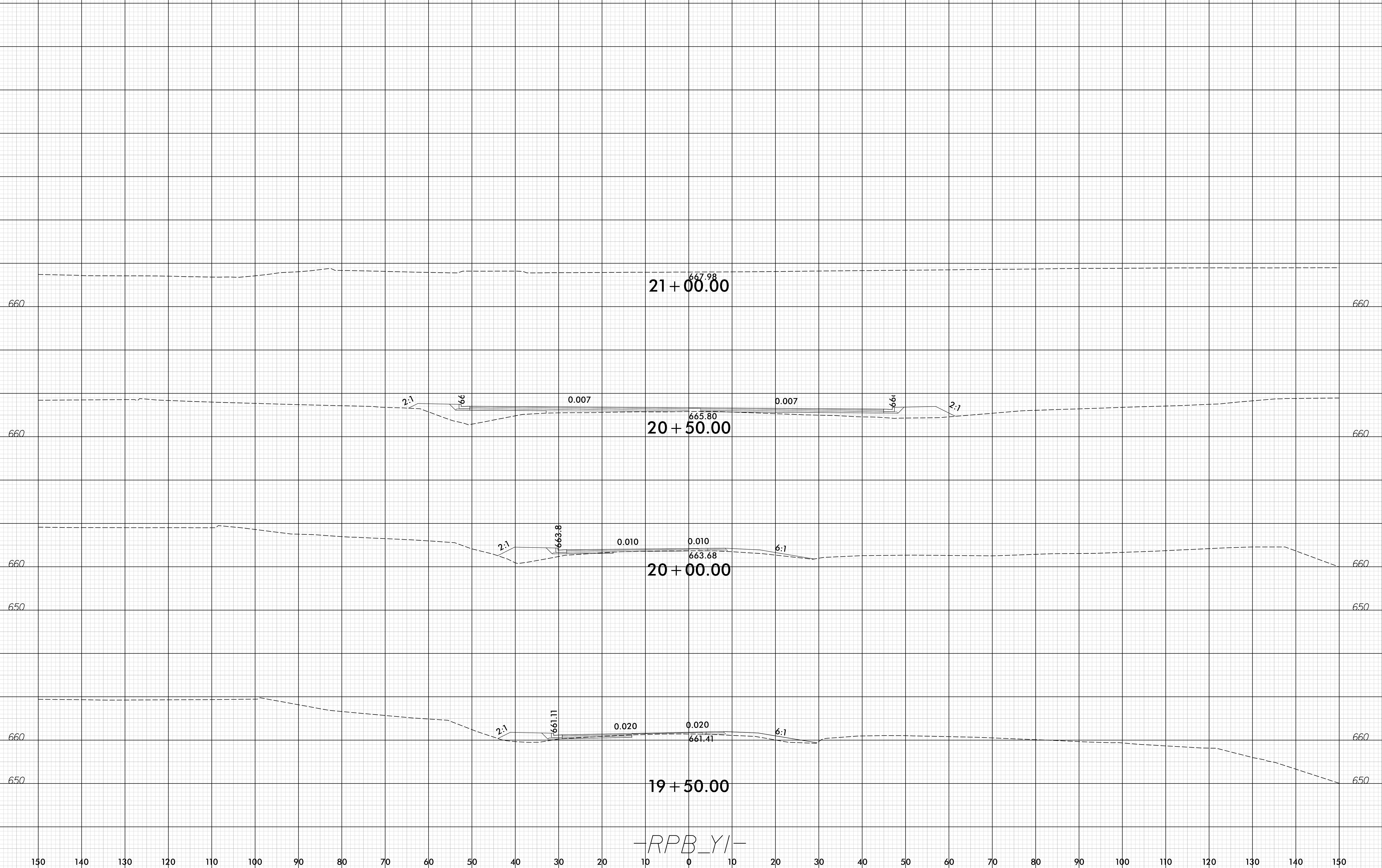

-RPB_YI-

I:\2016\2016\I-5711\RDY_XPL_RPB_YI.dgn
6/23/16

6/23/16

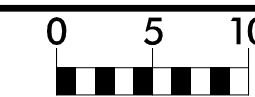

PROJ. REFERENCE NO.
I-5711

SHEET NO.
X-34

150 140 130 120 110 100 90 80 70 60 50 40 30 20 10 0 10 20 30 40 50 60 70 80 90 100 110 120 130 140 150

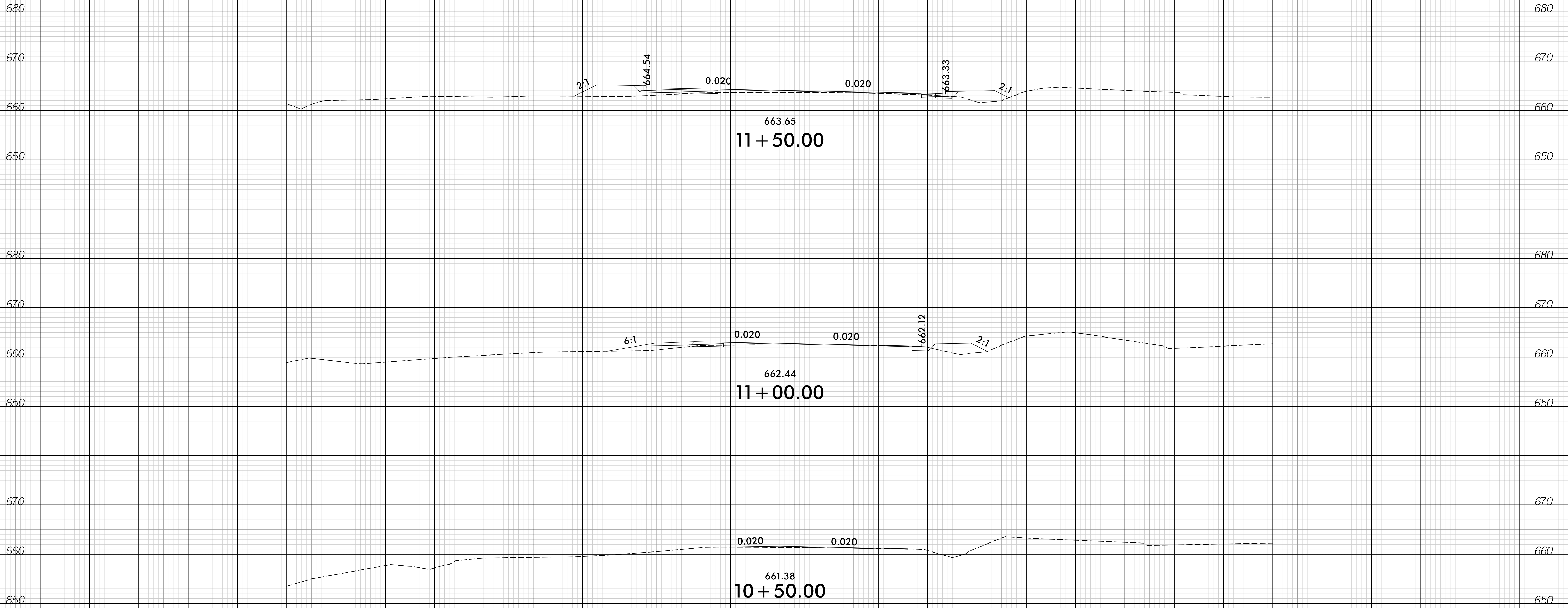

BEGIN CONSTRUCTION

-RPC_YI-

I:\2016\2016\I-5711\RDY_XPL_RPC_YI.dgn
6/23/16

150 140 130 120 110 100 90 80 70 60 50 40 30 20 10 0 10 20 30 40 50 60 70 80 90 100 110 120 130 140 150

6/23/16

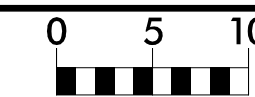

PROJ. REFERENCE NO.	SHEET NO.
I-5711	X-35

150 140 130 120 110 100 90 80 70 60 50 40 30 20 10 0 10 20 30 40 50 60 70 80 90 100 110 120 130 140 150

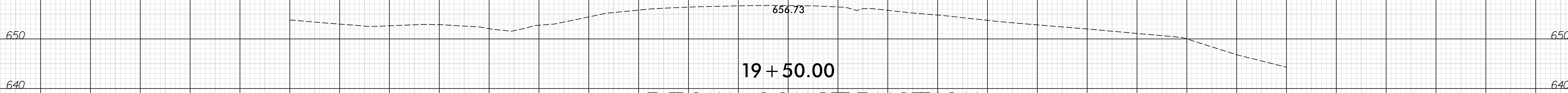
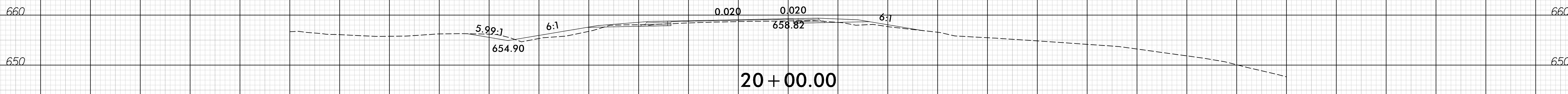
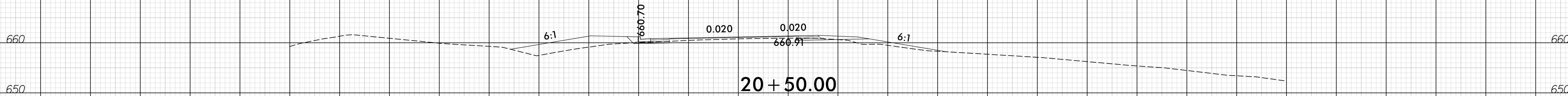
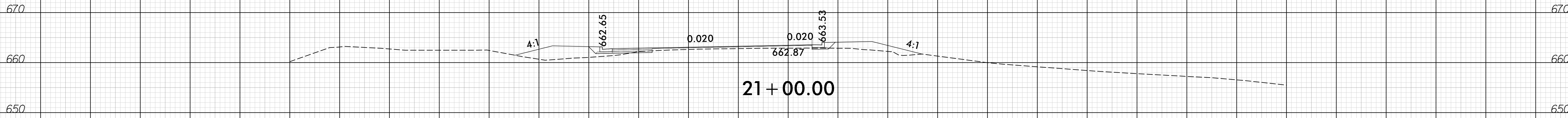

BEGIN CONSTRUCTION
 -RPD_YI- STA. 12+00.00
 1.5" OVERLAY FROM 12+00.00 TO 19+80.00

-RPD_YI-

150 140 130 120 110 100 90 80 70 60 50 40 30 20 10 0 10 20 30 40 50 60 70 80 90 100 110 120 130 140 150

I:\2016\12\23\16\I-5711\RDY_XPL_RPD_YI.dgn

6/23/16

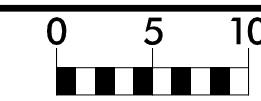

PROJ. REFERENCE NO.
I-5711

SHEET NO.
X-36

150 140 130 120 110 100 90 80 70 60 50 40 30 20 10 0 10 20 30 40 50 60 70 80 90 100 110 120 130 140 150

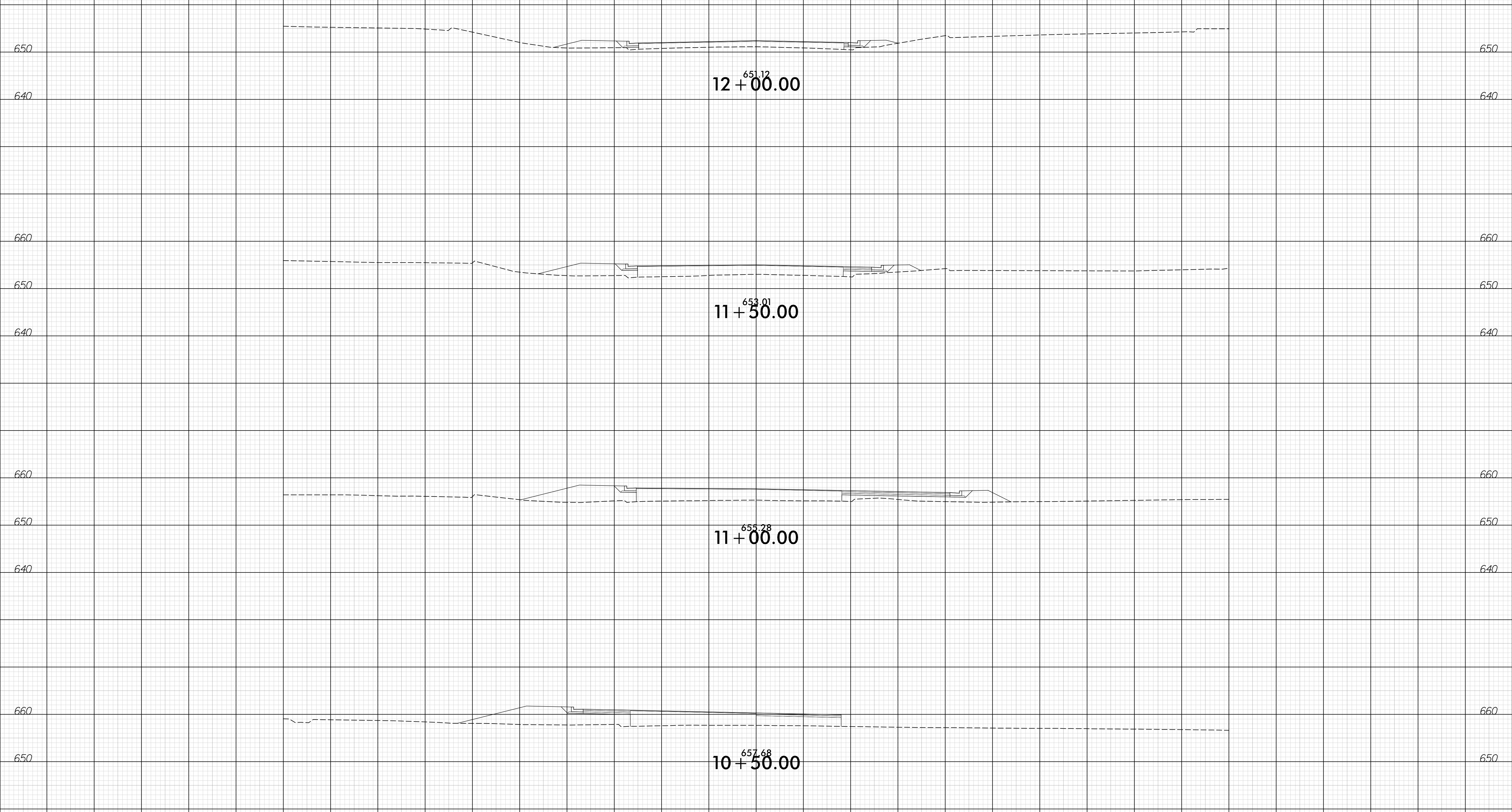

-Y2-

I:\2016\12\23\2016\I-5711\RDY_XPL_Y2.dgn

150 140 130 120 110 100 90 80 70 60 50 40 30 20 10 0 10 20 30 40 50 60 70 80 90 100 110 120 130 140 150

6/23/16

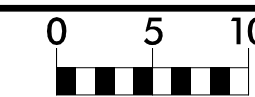

PROJ. REFERENCE NO.
I-5711

SHEET NO.
X-37

150 140 130 120 110 100 90 80 70 60 50 40 30 20 10 0 10 20 30 40 50 60 70 80 90 100 110 120 130 140 150

END CONSTRUCTION
-Y2- STA. 13+05.00

DRIVEWAY

647.88
13+00.00

649.52
12+50.00

-Y2-

I:\2016\2016\I-5711\RDY_XPL_Y2.dgn
6/23/16

6/23/16

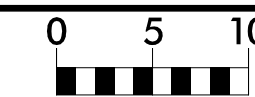

PROJ. REFERENCE NO.	SHEET NO.
I-5711	X-38

150 140 130 120 110 100 90 80 70 60 50 40 30 20 10 0 10 20 30 40 50 60 70 80 90 100 110 120 130 140 150

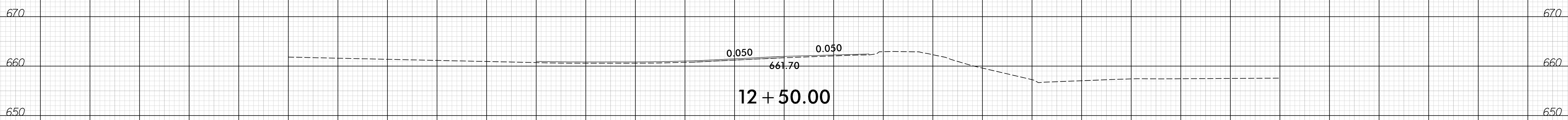
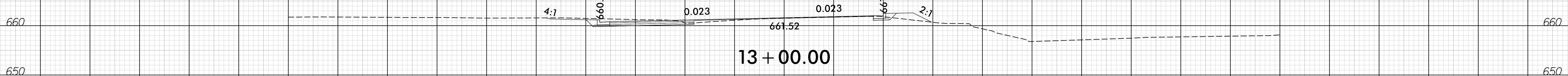
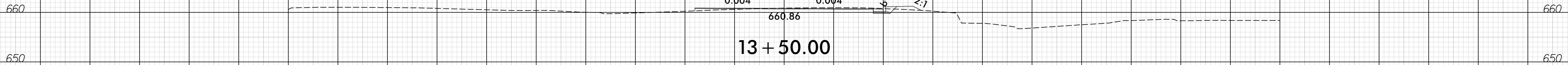

BEGIN CONSTRUCTION
-Y3- STA. 12+10.00
-Y3-

150 140 130 120 110 100 90 80 70 60 50 40 30 20 10 0 10 20 30 40 50 60 70 80 90 100 110 120 130 140 150

I:\2016\12\23\16\I-5711\RDY_XPL_Y3.dgn
C:\Users\jgibson\OneDrive\Documents\I-5711\RDY_XPL_Y3.dgn

6/23/16

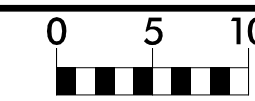

PROJ. REFERENCE NO.
I-5711

SHEET NO.
X-39

150 140 130 120 110 100 90 80 70 60 50 40 30 20 10 0 10 20 30 40 50 60 70 80 90 100 110 120 130 140 150

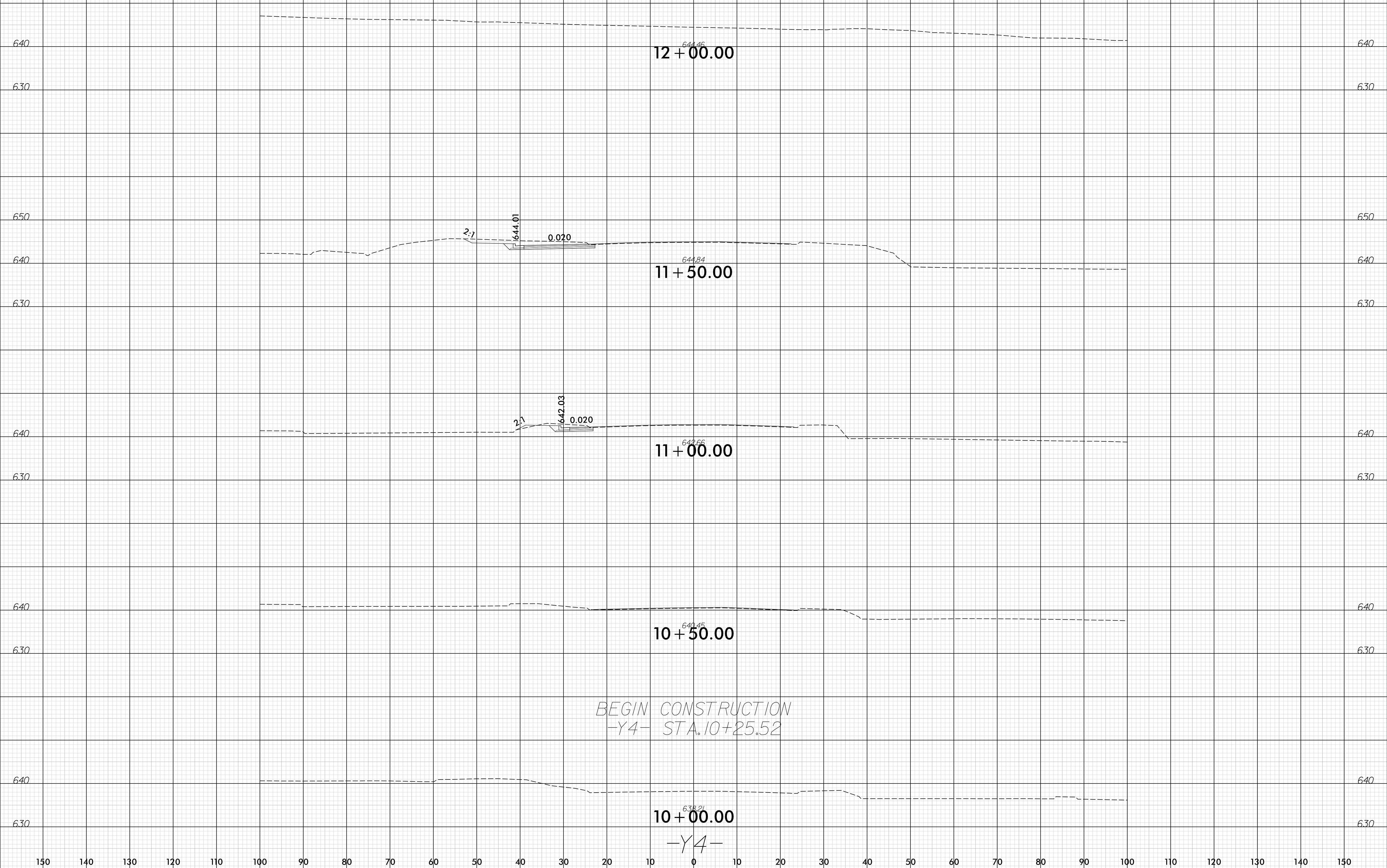

BEGIN CONSTRUCTION
-Y4- STA. 10+25.52

-Y4-

I:\2016\12\23\2016\I-5711\RDY_XPL_Y4.dgn
E:\cpl\eyl

150 140 130 120 110 100 90 80 70 60 50 40 30 20 10 0 10 20 30 40 50 60 70 80 90 100 110 120 130 140 150