

**This electronic collection of documents is provided
for the convenience of the user
and is Not a Certified Document –**

**The documents contained herein were originally issued
and sealed by the individuals whose names and license
numbers appear on each page, on the dates appearing
with their signature on that page.**

**This file or an individual page
shall not be considered a certified document.**



I2/11/18 P:\A\1\p\h\dr-useas01\HDR_US_East_01\Documents\3322\10001376\10052612\6.0_CAD_BIM\6.2_Work_In_Progress\Traffic\Signing\CADD\Signing Layout\Plans\U2530B_S-2.dgn

NUMBER	SIGN			ROADWAY STATION	NUMBER OF SUPPORTS	BEAM SECTION	SUPPORT TYPE BA or S	OMNI COUPLER	ATTACHMENT METHOD	MOUNTING METHOD	HORIZONTAL CLEARANCE* (ft.)	SUPPORT SPACING	LENGTH (ft)			LEFT SUPPORT (ft)			CENTER SUPPORT (ft)			RIGHT SUPPORT (ft)			SUPPORT WEIGHTS		FOOTINGS				Curb & Gutter	
	TYPE	SIZE (in.)											SNS HT	MTG HT	EMBED-MENT	S	L	LENGTH	S	L	LENGTH	S	L	LENGTH	B/A (lbs.)	SIMPLE (lbs.)	DIAMETER (ft.)	DEPTH (ft.)	REINFORCED (c.y.)	PLAIN (c.y.)		
		w	x																													h
101	B	120	x	42	L-STA 36+87	2	S3x5.7	BA	N/A	N/A	N/A	13.50	5.86	3.50	7.00	2.5	0.82	11.32	13.82	0.00	0.00	0.00	1.35	11.85	14.35	196.57	0	1.0	3	0.00	0.17	Curb & Gutter
102	A	114	x	54	Y-Sta 25+00	2	S4x7.7	BA	N/A	N/A	N/A	18.00	5.57	4.50	7.00	3.0	1.40	12.90	15.90	0.00	0.00	0.00	3.00	14.50	17.50	297.18	0	1.0	3.5	0.00	0.20	Curb & Gutter
103	A	96	x	54	-L-STA 146+46	2	S4x7.7	BA	N/A	N/A	N/A	30.00	4.69	4.50	7.00	2.5	3.69	15.19	17.69	0.00	0.00	0.00	3.53	15.03	17.53	311.19	0	1.0	3	0.00	0.17	Curb & Gutter
104	A	96	x	54	-L-STA 160+36	2	S3x5.7	BA	N/A	N/A	N/A	30.00	4.69	4.50	7.00	2.5	3.16	14.66	17.16	0.00	0.00	0.00	1.40	12.90	15.40	221.59	0	1.0	3	0.00	0.17	
105	B	108	x	36	L- STA 331+79	2	S3x5.7	S	N/A	N/A	N/A	16.00	5.27	3.00	7.00	2.5	1.84	11.84	14.34	0.00	0.00	0.00	2.50	12.50	15.00	0.00	167.238	1.0	3	0.00	0.17	
106	A	96	x	78	-L- STA 335+15	2	S4x7.7	S	N/A	N/A	N/A	18.00	4.69	6.50	7.00	3.0	2.13	15.63	18.63	0.00	0.00	0.00	2.80	16.30	19.30	0.00	292.061	1.0	3.5	0.00	0.20	
107	A	108	x	78	L-STA. 347+14	2	W6x12	S	N/A	N/A	N/A	16.00	5.27	6.50	7.00	3.0	5.80	19.30	22.30	0.00	0.00	0.00	7.70	21.20	24.20	0.00	558	1.5	3.5	0.46	0.00	
108	A	96	x	78	L-STA. 346+93	2	W6x9	BA	N/A	N/A	N/A	30.00	4.69	6.50	7.00	3.0	4.60	18.10	21.10	0.00	0.00	0.00	4.70	18.20	21.20	444.70	0	1.5	3.5	0.46	0.00	
109	B	108	x	36	L-STA. 350+38	2	S3x5.7	S	N/A	N/A	N/A	12.00	5.27	3.00	7.00	2.5	4.65	14.65	17.15	0.00	0.00	0.00	5.17	15.17	17.67	0.00	198.474	1.0	3	0.00	0.17	
																	TOTAL	TOTAL					TOTAL	TOTAL								
																	1471.24	1215.77					0.92	1.28								
																	USE:	1472.00	1216.00					1.00	2.00							

NOTES

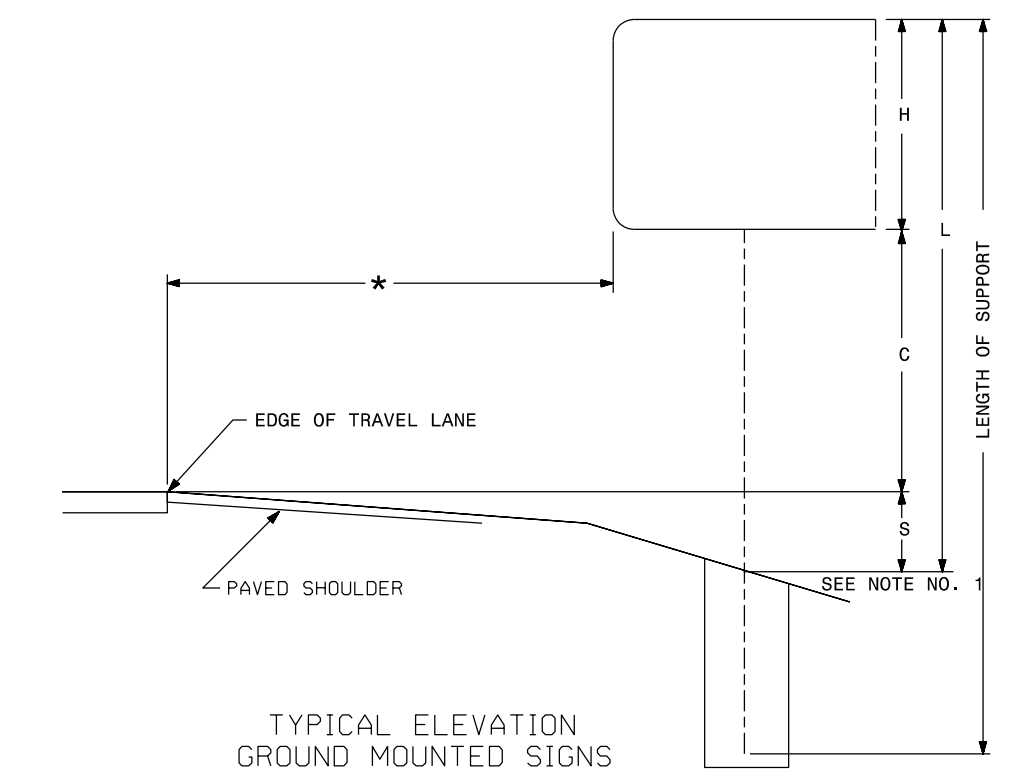
- DIMENSION "S" REPRESENTS AN INCREASE (+), OR A DECREASE (-) IN POLE LENGTH, RELATIVE TO THE ELEVATION OF THE EDGE OF TRAVEL LANE.
- FIELD VERIFICATIONS SHALL BE REQUIRED FOR ALL SUPPORTS, SEE (*) ARTICLE 903-3. FABRICATORS SHALL BE AISC CERTIFIED IN CATEGORY 1, SEE (*) ARTICLE 1072-1. (*) = N.C.D.O.T. STANDARD SPECIFICATIONS FOR ROADS AND STRUCTURES
- PLAN LOCATIONS FOR EXISTING UTILITIES ARE BASED ON THE BEST AVAILABLE INFORMATION AND, THEREFORE MAY NOT BE PRECISELY ACCURATE. THEREFORE, IT IS INCUMBENT UPON THE CONTRACTOR TO DETERMINE THE EXACT LOCATION OF UTILITIES BEFORE BEGINNING WORK IN A LOCATION.



APPROVED: <i>R. King</i> DATE: 12/13/2018	TYPE "A" and "B" GROUND MOUNTED SIGN	
	SCALE: NTS	
	DATE: 12/11/18	
	DWG. BY: K HECTOR	
	DESIGN BY: K HECTOR	
REVIEWED BY: R KING	REVISIONS	

PROJ. REFERENCE NO.	SHEET NO.
R-2530B	SIGN-3
DOCUMENT NOT CONSIDERED FINAL UNLESS ALL SIGNATURES COMPLETED	
 HDR Engineering, Inc. of the Carolinas 555 Fayetteville St, Suite 900 Raleigh, N.C. 27601 N.C.B.E.L.S. License Number: F-0116	

SIGN NUMBER: 101
 TYPE: B
 QUANTITY: 1
 SIGN WIDTH: 10'-0"
 HEIGHT: 3'-6"
 TOTAL AREA: 35.0 Sq.Ft.
 BORDER TYPE: FLUSH
 RECESS: 0"
 WIDTH: 0.75"
 RADII: 3"
 NO. Z BARS: 2
 LENGTH: 112.0

SYMBOL	X	Y	WID	HT
AR_Type D	7.9	25.3	6	9
AR_Type D	91.5	4.7	6	9

DESIGN BY: K Hector
 CHECKED BY: R. Drayton
 PROJECT ID: R-2530_B-4974
 Oct 16, 2018
 DIV: 10

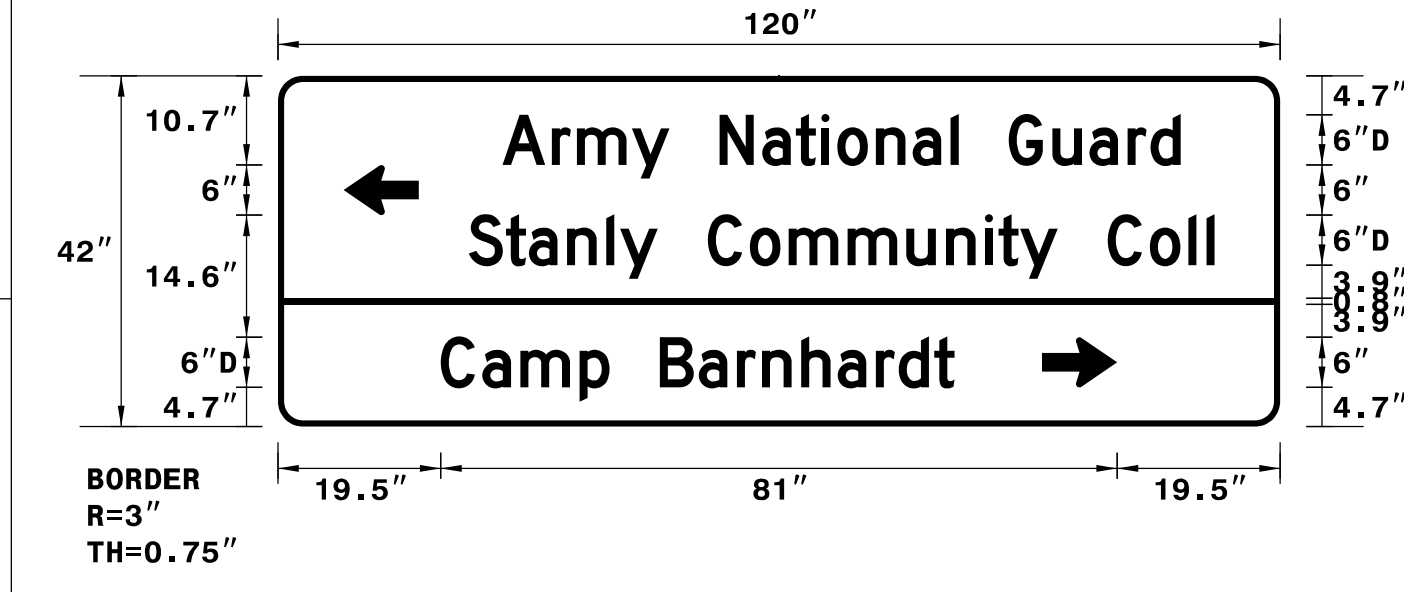

USE NOTES: 1,2
 1. Legend and border(except those that are colored black) shall be direct applied Grade C sheeting.
 2. Background shall be Grade C reflective sheeting.

SIGN NUMBER: 308
 TYPE: D
 QUANTITY: 1
 SIGN WIDTH: 7'-0"
 HEIGHT: 3'-0"
 TOTAL AREA: 21.0 Sq.Ft.
 BORDER TYPE: FLUSH
 RECESS: 0"
 WIDTH: 1"
 RADII: 3"
 NO. Z BARS:
 LENGTH:

SYMBOL	X	Y	WID	HT

DESIGN BY: K Hector
 CHECKED BY: R KING
 PROJECT ID: R-2530_B-4974
 Dec 03, 2018
 DIV: 10

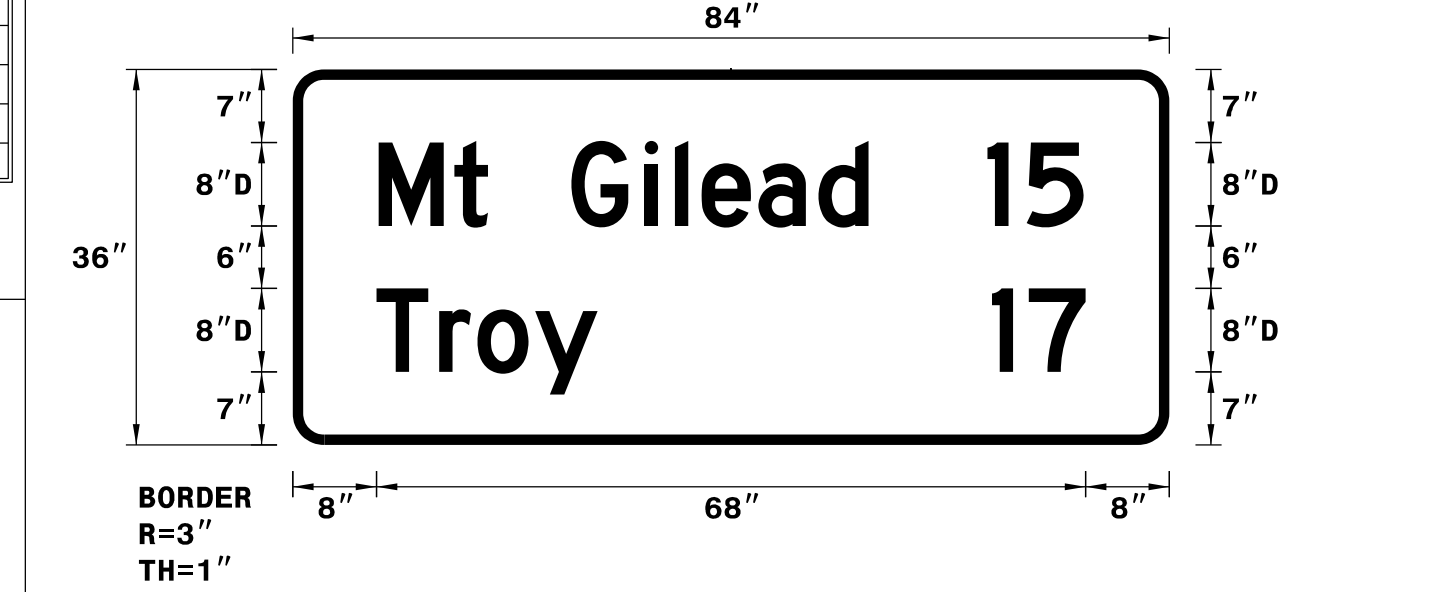

USE NOTES: 1,2
 1. Legend and border(except those that are colored black) shall be direct applied Grade C sheeting.
 2. Background shall be Grade C reflective sheeting.

LETTER POSITIONS

Letter spacings are to start of next letter															Series/Size								
															Text Length								
26.9	5.9	3	6.6	4.5	6	5.1	4	3.1	1.9	4.6	4.4	4.6	1	6	5.2	4.4	4.6	2.8	3.6	11.9	D 2000		
A r m y N a t i o n a l G u a r d															81.2								
22.9	4.4	2.8	4.6	4.7	1.7	4.5	6	5	4.6	7.1	7	4.7	4.7	1.6	2.6	4.5	6	5	4.6	2.2	1	7.9	D 2000
S t a n l y C o m m u n i t y C o l l															89.3								
19.5	5	4.6	7.1	3.6	6	4.7	4.6	3	4.7	4.4	4.6	2.8	4.3	2.4	39	D 2000							
C a m p B a r n h a r d t															61.5								

FILENAME: Guidsign_English_8-2-13 NORTH CAROLINA D.O.T. SIGN DETAIL

LETTER POSITIONS

Letter spacings are to start of next letter															Series/Size
															Text Length
8.2	7.3	3.2	8	7	2.9	2.6	5.4	5.8	4.8	11.4	3.8	5.4	8.2	D 2000	
M t G i l e a d 1 5															67.6
8	6	3.7	5.5	6	37.8	3.5	5.4	8	D 2000						
T r o y 1 7															68

FILENAME: Guidsign_English_8-2-13 NORTH CAROLINA D.O.T. SIGN DETAIL

SIGN NUMBER: 103
 TYPE: A
 QUANTITY: 1
 SIGN WIDTH: 8'-0"
 HEIGHT: 4'-6"
 TOTAL AREA: 36.0 Sq.Ft.
 BORDER TYPE: FLUSH
 RECESS: 0"
 WIDTH: 1"
 RADII: 6"
 NO. Z BARS: 2
 LENGTH: 88.0

SYMBOL	X	Y	WID	HT
AR_Type D	8	32.7	8	12
AR_Type D	25	6.3	8	12

DESIGN BY: K Hector
 CHECKED BY: R Drayton
 PROJECT ID: R-2530_B-4974
 Oct 26, 2018
 DIV: 10

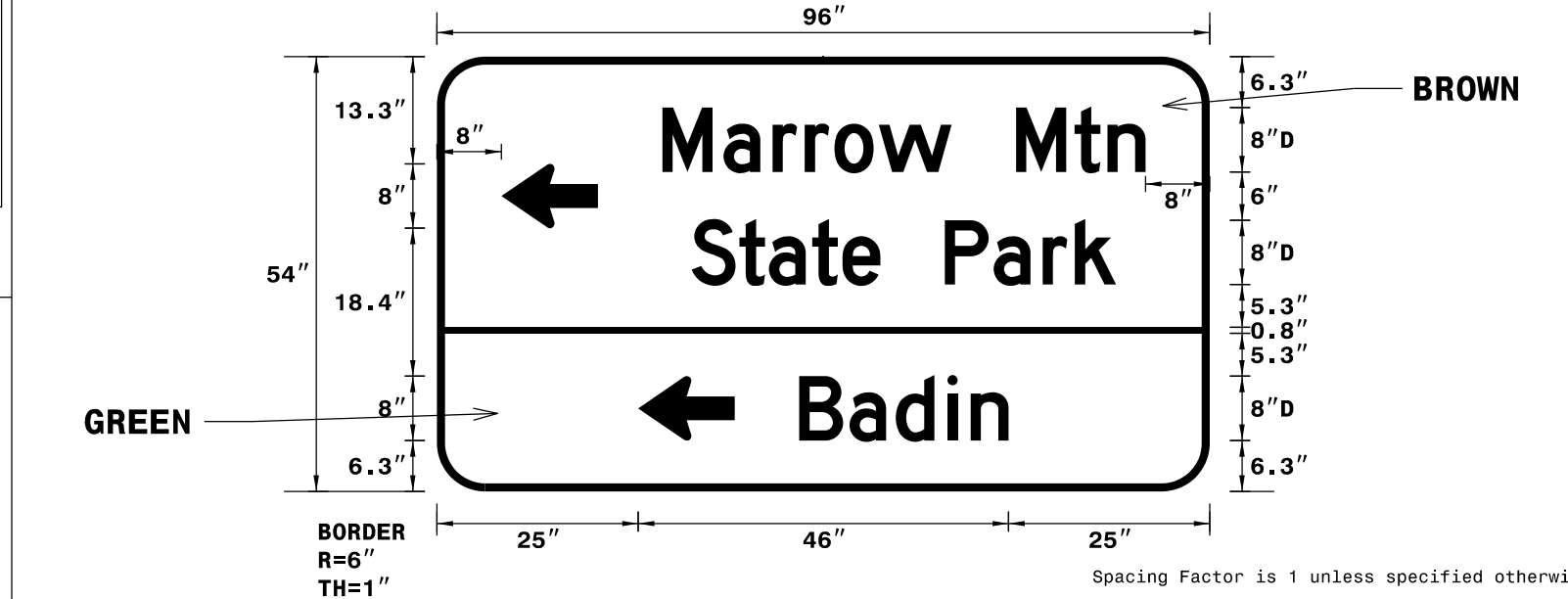

LETTER POSITIONS

Letter spacings are to start of next letter															Series/Size
															Text Length
28	7.6	6.1	4	3.7	5.5	9	8	7.3	4.1	4.7	8	D 2000			
M a r r o w M t n															60
31.6	5.9	3.7	5.4	3.8	4.7	8	6.1	6.1	4	5.1	11.6	D 2000			
S t a t e P a r k															52.7
45	6.2	5.8	6.4	2.9	4.7	25	D 2000								
B a d i n															26

FILENAME: Guidsign_English_8-2-13 NORTH CAROLINA D.O.T. SIGN DETAIL

SIGN NUMBER: 104
 TYPE: A
 QUANTITY: 1
 SIGN WIDTH: 8'-0"
 HEIGHT: 4'-6"
 TOTAL AREA: 36.0 Sq.Ft.
 BORDER TYPE: FLUSH
 RECESS: 0"
 WIDTH: 1"
 RADII: 6"
 NO. Z BARS: 2
 LENGTH: 88.0

SYMBOL	X	Y	WID	HT
AR_Type D	76	32.7	8	12
AR_Type D	59	6.3	8	12

DESIGN BY: K Hector
 CHECKED BY: R Drayton
 PROJECT ID: R-2530_B-4974
 Oct 26, 2018
 DIV: 10

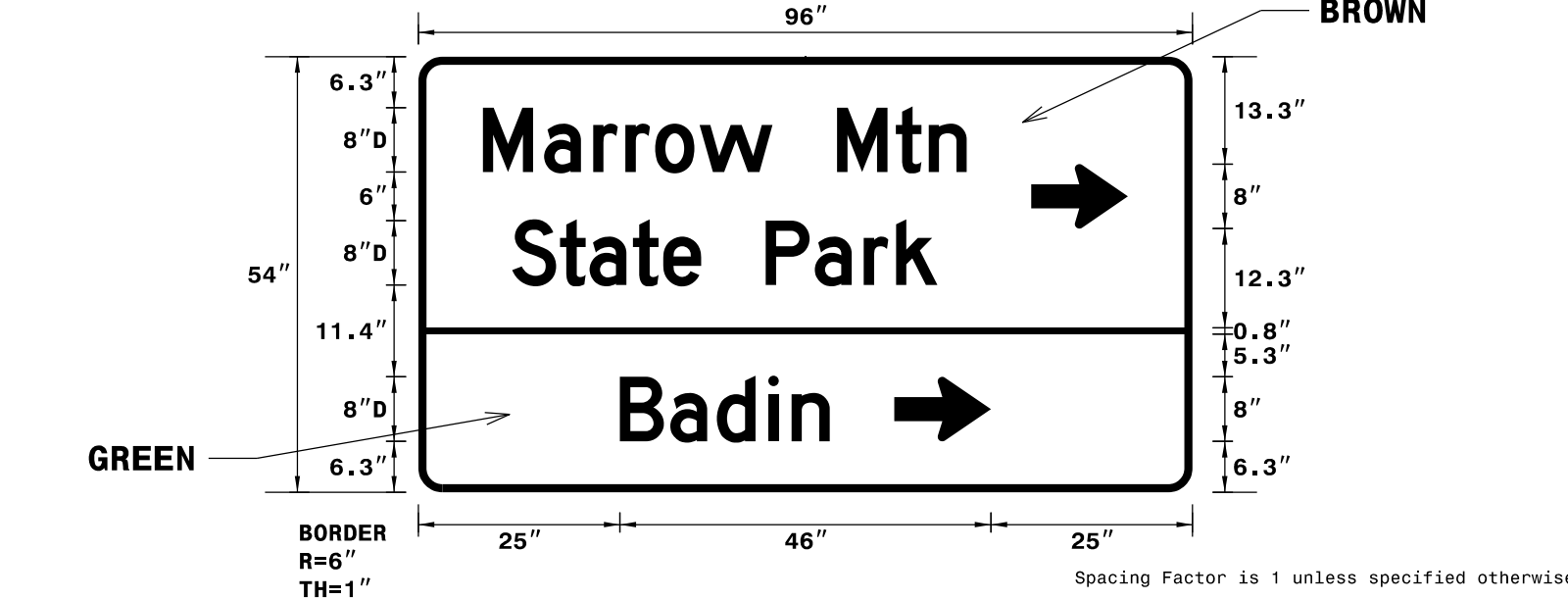

LETTER POSITIONS

Letter spacings are to start of next letter															Series/Size
															Text Length
8	7.6	6.1	4	3.7	5.5	9	8	7.3	4.1	4.7	8	D 2000			
M a r r o w M t n															60
11.6	5.9	3.7	5.4	3.8	4.7	8	6.1	6.1	4	5.1	31.6	D 2000			
S t a t e P a r k															52.7
25	6.2	5.8	6.4	2.9	4.7	45	D 2000								
B a d i n															26

FILENAME: Guidsign_English_8-2-13 NORTH CAROLINA D.O.T. SIGN DETAIL

PLOT DRIVER: pdfplotfcg
 USER: KHECTOR
 DATE: 12/05/18
 SCALE: 1:48.3408
 TIME: 15:45:05
 FILE: NCDOT\2015.NCDOT_TMSD.Limited.Ser.Vices.Contract.M.7000016704\NCDOT-R2530B.B4974.IT03.c.\6.0.CAD.BTM.V6.2.Work.In.Progress\Traffic\Signing\CADD\Signing_Layout_Plans\U2530B_Signing_S-3.dgn

APPROVED: *Ron King* DATE: 12/13/2018

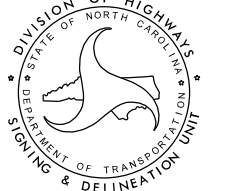

SIGN DESIGNS

SCALE:	NTS		REVISIONS _____ _____ _____
DATE:	12/05/18		
DWG. BY:	K HECTOR		
DESIGN BY:	K HECTOR		
REVIEWED BY:	R KING	CADD FILE	

SIGN NUMBER: 106
 TYPE: A
 QUANTITY: 1
 SIGN WIDTH: 8'-0"
 HEIGHT: 6'-6"
 TOTAL AREA: 52.0 Sq.Ft.
 BORDER TYPE: FLUSH
 RECESS: 0"
 WIDTH: 1"
 RADII: 9"
 NO. Z BARS: 2
 LENGTH: 88.0

SYMBOL	X	Y	WID	HT

DESIGN BY: K HECTOR
 CHECKED BY: R KING
 Nov 30, 2018
 DIV: 10
 PROJECT ID: R-2530_B-4974

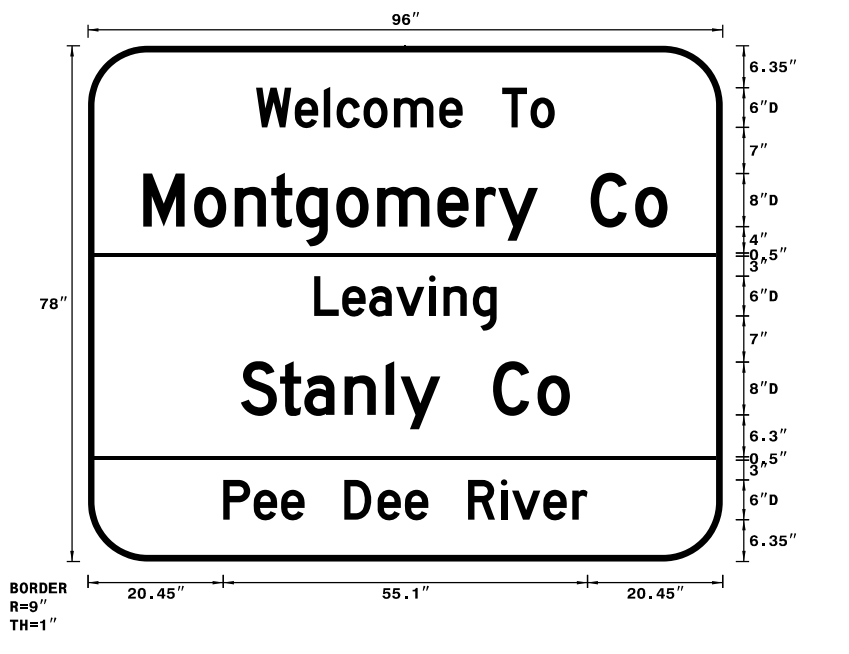

USE NOTES: 1 & 2
 1. Legend and border(except those that are colored black) shall be direct applied Grade C sheeting.
 2. Background shall be Grade C reflective sheeting.
 3. Shields; A, B, and C type arrows shall be on 0.032" (0.8mm) aluminum and demountable.

SIGN NUMBER: 108
 TYPE: A
 QUANTITY: 1
 SIGN WIDTH: 8'-0"
 HEIGHT: 6'-6"
 TOTAL AREA: 52.0 Sq.Ft.
 BORDER TYPE: FLUSH
 RECESS: 0"
 WIDTH: 1"
 RADII: 9"
 NO. Z BARS: 2
 LENGTH: 88.0

SYMBOL	X	Y	WID	HT

DESIGN BY: K HECTOR
 CHECKED BY: R KING
 Nov 30, 2018
 DIV: 10
 PROJECT ID: R-2530_B-4974

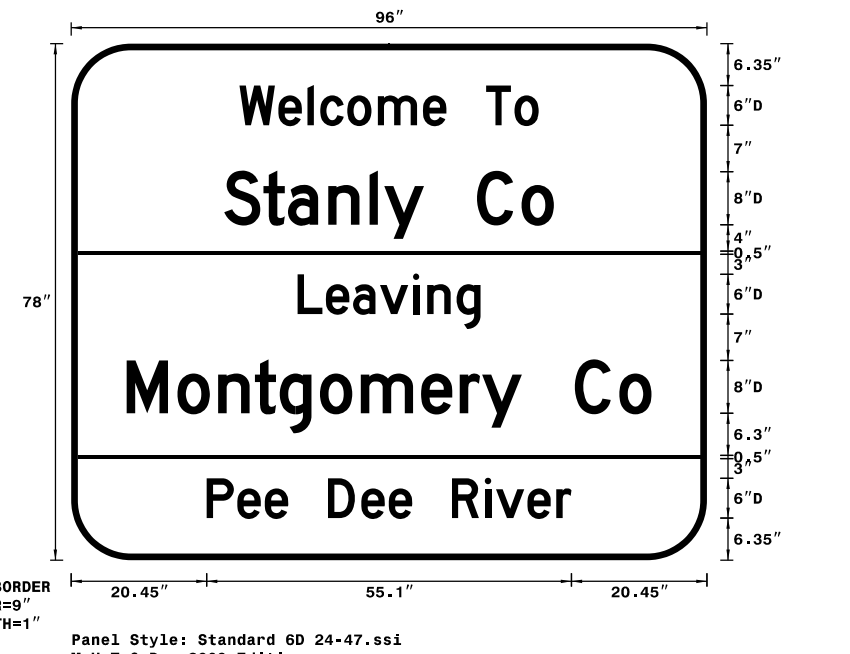

USE NOTES: 1 & 2
 1. Legend and border(except those that are colored black) shall be direct applied Grade C sheeting.
 2. Background shall be Grade C reflective sheeting.
 3. Shields; A, B, and C type arrows shall be on 0.032" (0.8mm) aluminum and demountable.

PROJ. REFERENCE NO.	SHEET NO.
R-2530B	SIGN-3A
DOCUMENT NOT CONSIDERED FINAL UNLESS ALL SIGNATURES COMPLETED	
 HDR Engineering, Inc. of the Carolinas 555 Fayetteville St, Suite 900 Raleigh, N.C. 27601 N.C.B.E.L.S. License Number: F-0116	

LETTER POSITIONS

Letter spacings are to start of next letter													Series/Size	
													Text Length	
25.4	5.9	4.4	1.9	4.1	4.6	6.8	3.5	6	4.3	3.7	25.4		D 2000	
W e l c o m e T o													45.2	
8.4	7.7	6.2	5.5	3.8	6.1	6.2	9.1	5.8	3.4	6	8	6.7	4.9	8.4
M o n t g o m e r y C o													D 2000	
L e a v i n g													79.3	
34.2	4.3	4.1	4.1	5	2.2	4.4	3.6	34.2					D 2000	
S t a n l y C o													27.6	
23.1	5.9	3.7	6.1	6.2	2.2	6	8	6.7	4.9	23.1			D 2000	
P e e D e e R i v e r													49.8	
20.5	4.6	4.1	3.5	6	5	4.1	3.5	6	5	1.7	4.7	4.4	2.3	20.5
P e e D e e R i v e r													D 2000	
													55.1	

FILENAME: Guidesign_English_8-2-13 NORTH CAROLINA D.O.T. SIGN DETAIL

LETTER POSITIONS

Letter spacings are to start of next letter													Series/Size	
													Text Length	
25.4	5.9	4.4	1.9	4.1	4.6	6.8	3.5	6	4.3	3.7	25.4		D 2000	
W e l c o m e T o													45.2	
23.1	5.9	3.7	6.1	6.2	2.2	6	8	6.7	4.9	23.1			D 2000	
S t a n l y C o													49.8	
34.2	4.3	4.1	4.1	5	2.2	4.4	3.6	34.2					D 2000	
L e a v i n g													27.6	
8.4	7.7	6.2	5.5	3.8	6.1	6.2	9.1	5.8	3.4	6	8	6.7	4.9	8.4
M o n t g o m e r y C o													D 2000	
P e e D e e R i v e r													79.3	
20.5	4.6	4.1	3.5	6	5	4.1	3.5	6	5	1.7	4.7	4.4	2.3	20.5
P e e D e e R i v e r													D 2000	
													55.1	

FILENAME: Guidesign_English_8-2-13 NORTH CAROLINA D.O.T. SIGN DETAIL

SIGN NUMBER: 107
 TYPE: A
 QUANTITY: 1
 SIGN WIDTH: 9'-0"
 HEIGHT: 6'-6"
 TOTAL AREA: 58.5 Sq.Ft.
 BORDER TYPE: FLUSH
 RECESS: 0"
 WIDTH: 1"
 RADII: 9"
 NO. Z BARS: 2
 LENGTH: 100.0

SYMBOL	X	Y	WID	HT
AR_Type D	35.4	59.7	8	12
AR_Type D	75.5	40	8	12
AR_Type D	85.7	13.3	8	12

DESIGN BY: K HECTOR
 CHECKED BY: R KING
 Nov 30, 2018
 DIV: 10
 PROJECT ID: R-2530_B-4974

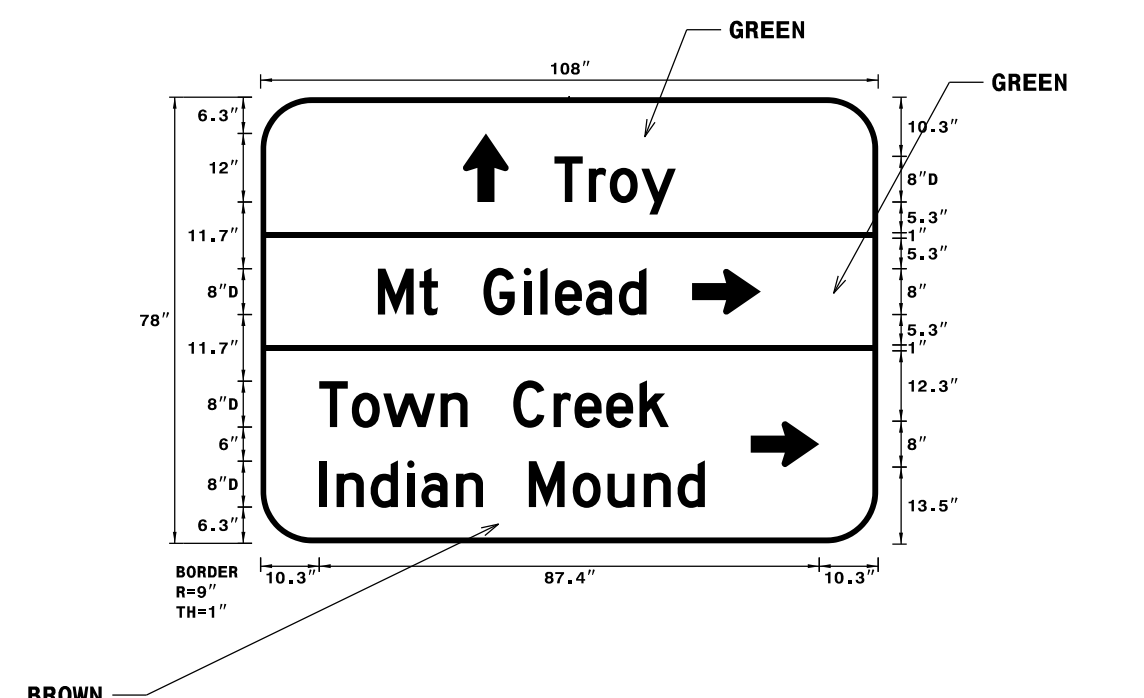

USE NOTES: 1 & 2
 1. Legend and border(except those that are colored black) shall be direct applied Grade C sheeting.
 2. Background shall be Grade C reflective sheeting.
 3. Shields; A, B, and C type arrows shall be on 0.032" (0.8mm) aluminum and demountable.

SIGN NUMBER: 105 & 109
 TYPE: B
 QUANTITY: 2
 SIGN WIDTH: 9'-0"
 HEIGHT: 3'-0"
 TOTAL AREA: 27.0 Sq.Ft.
 BORDER TYPE: FLUSH
 RECESS: 0"
 WIDTH: 1"
 RADII: 3"
 NO. Z BARS: 2
 LENGTH: 100.0

SYMBOL	X	Y	WID	HT

DESIGN BY: K Hector
 CHECKED BY: R Drayton
 Oct 26, 2018
 DIV: 10
 PROJECT ID: R-2530_B-4974

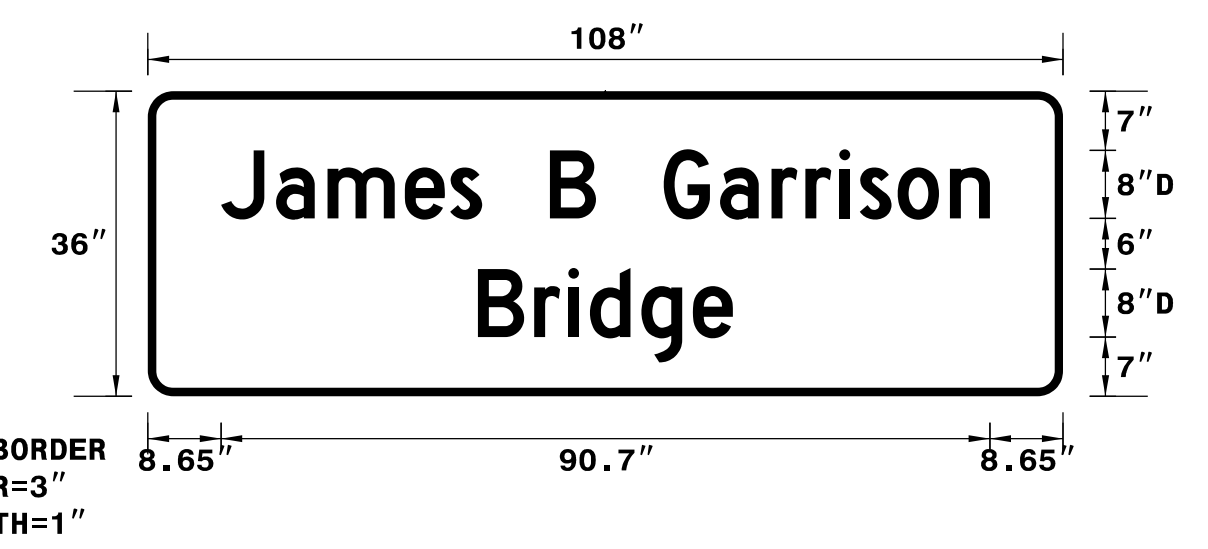

USE NOTES: 1,2
 1. Legend and border(except those that are colored black) shall be direct applied Grade C sheeting.
 2. Background shall be Grade C reflective sheeting.

LETTER POSITIONS

Letter spacings are to start of next letter													Series/Size	
													Text Length	
51.4	6	3.7	5.5	6	35.4							D 2000		
T r o y													21.2	
20.5	7.3	3.2	8	7	2.9	2.6	5.4	5.8	4.8	40.5			D 2000	
M t G i l e a d													47	
10.3	5.7	5.5	10	4.7	8	7	3.7	5.5	5.8	5.1	36.6			D 2000
T o w n C r e e k													61.1	
10.3	3	5.9	6.4	2.5	6.1	4.7	8	7.7	6.1	6.3	5.9	4.8	30.3	
I n d i a n M o u n d													D 2000	
													67.4	

FILENAME: Guidesign_English_8-2-13 NORTH CAROLINA D.O.T. SIGN DETAIL

LETTER POSITIONS

Letter spacings are to start of next letter													Series/Size				
													Text Length				
8.6	6.5	6.1	9.1	5.4	3.8	8	5.4	8	6.6	6.1	4	4	2.4	4.5	6.2	4.7	8.6
J a m e s B G a r r i s o n													D 2000				
39	6.6	4	2.6	6.1	6.1	4.7	39									D 2000	
B r i d g e													30.1				

FILENAME: Guidesign_English_8-2-13 NORTH CAROLINA D.O.T. SIGN DETAIL

PLOT DRIVER: pdfplotcfcg
 USER: KHECTOR
 FILE: NCDOT\2015.NCDOT_TMSD.Limited.Services.Contract.M.7000016704\NCDOT-R2530B.B4974.IT03.c.\6.0.CAD.BTM\6.2.Work.In.Progress\Traffic\Signing\CADD\Signing_Layout_Plans\U2530B_Signing_S-3a.dgn
 PENTABLE: NCDOT_Signing.tbl
 TIME: 15:46:42
 SCALE: 1:48.3408
 DATE: 12/05/18
 REVISIONS

APPROVED: *Ron King* DATE: 12/13/2018

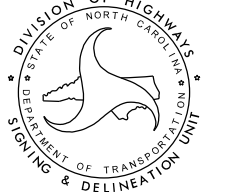

SIGN DESIGNS

SCALE:	NTS		<table border="1"> <tr><th colspan="2">REVISIONS</th></tr> <tr><td> </td><td> </td></tr> <tr><td> </td><td> </td></tr> <tr><td> </td><td> </td></tr> </table>	REVISIONS							
REVISIONS											
DATE:	12/05/18										
DWG. BY:	K HECTOR										
DESIGN BY:	K HECTOR										
REVIEWED BY:	R KING	CADD FILE									

PROJ. REFERENCE NO.	SHEET NO.
R-2530B	SIGN-3C
DOCUMENT NOT CONSIDERED FINAL UNLESS ALL SIGNATURES COMPLETED	
 HDR Engineering, Inc. of the Carolinas 555 Fayetteville St, Suite 900 Raleigh, N.C. 27601 N.C.B.E.L.S. License Number: F-0116	

SIGN NUMBER: 301
 TYPE: D
 QUANTITY: 1
 SIGN WIDTH: 5'-0"
 HEIGHT: 3'-6"
 TOTAL AREA: 17.5 Sq.Ft.
 BORDER TYPE: FLUSH
 RECESS: 0"
 WIDTH: 0.75"
 RADII: 3"
 NO. Z BARS: LENGTH:

SYMBOL	X	Y	WID	HT
AR_Type D	6.5	25.3	6	9
AR_Type D	38.3	4.7	6	9

BACKG COLOR: Green/Green
 COPY COLOR: White
 MAT'L: 0.125" (3.2 mm) ALUMINUM

DESIGN BY: R DRAYTON
 CHECKED BY: R KING
 Nov 30, 2018
 PROJECT ID: R-2530_B-4974
 DIV: 10

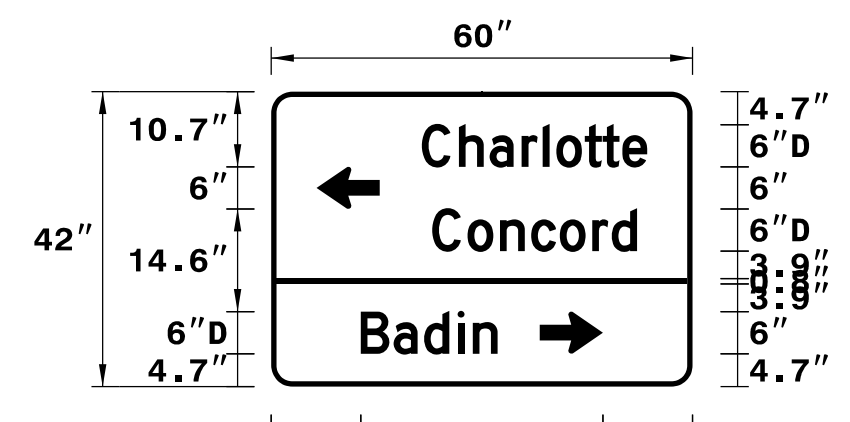

BORDER R=3" TH=0.75"

Spacing Factor is 1 unless specified otherwise

USE NOTES: 1 & 2

- Legend and border(except those that are colored black) shall be direct applied Grade C sheeting.
- Background shall be Grade C reflective sheeting.
- Shields; A, B, and C type arrows shall be on 0.032" (0.8mm) aluminum and demountable.

LETTER POSITIONS

Letter spacings are to start of next letter											Series/Size
											Text Length
C	h	a	r	l	o	t	t	e			D 2000
21.5	5.3	4.4	4.6	3	1.9	4.1	2.5	2.8	3.5	6.5	32.1
C	o	n	c	o	r	d					D 2000
22.9	5	4.6	4.4	4.1	4.6	2.8	3.6	7.9			29.2
B	a	d	i	n							D 2000
12.7	4.7	4.3	4.8	2.2	3.5	27.8					19.5

FILENAME: Guidesign_Engl1sh_8-2-13 NORTH CAROLINA D.O.T. SIGN DETAIL

SIGN NUMBER: 305
 TYPE: D
 QUANTITY: 1
 SIGN WIDTH: 5'-0"
 HEIGHT: 3'-6"
 TOTAL AREA: 17.5 Sq.Ft.
 BORDER TYPE: FLUSH
 RECESS: 0"
 WIDTH: 0.75"
 RADII: 3"
 NO. Z BARS: LENGTH:

SYMBOL	X	Y	WID	HT
AR_Type D	8	23.8	6	9
AR_Type D	11.3	4.7	6	9

BACKG COLOR: Green/Green
 COPY COLOR: White
 MAT'L: 0.125" (3.2 mm) ALUMINUM

DESIGN BY: K Hector
 CHECKED BY: R Drayton
 Oct 26, 2018
 PROJECT ID: R-2530_B-4974
 DIV: 10

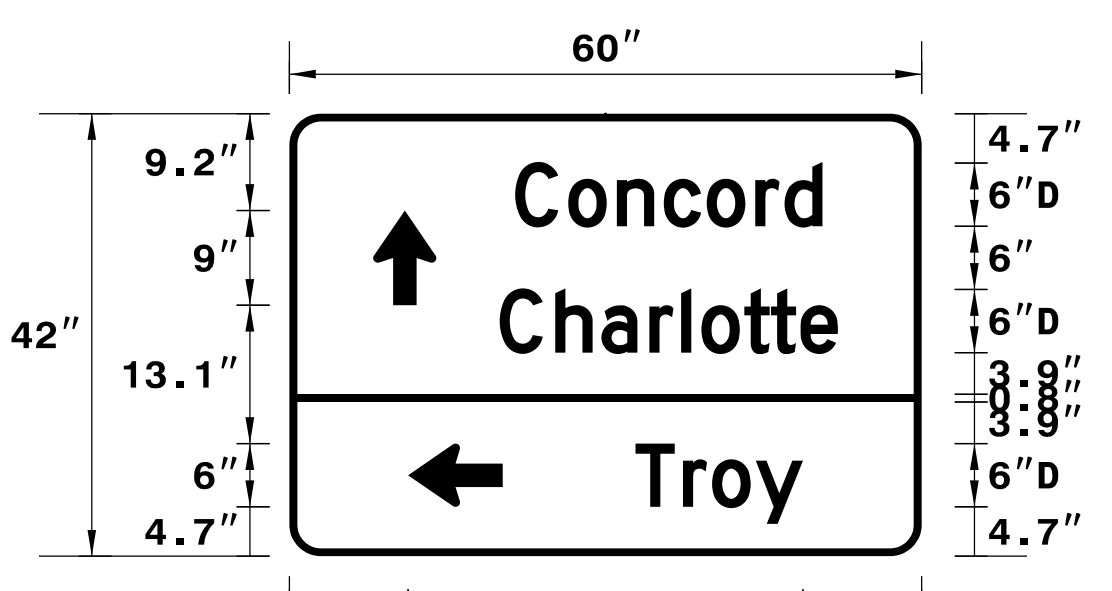

BORDER R=3" TH=0.75"

Spacing Factor is 1 unless specified otherwise

USE NOTES: 1 & 2

- Legend and border(except those that are colored black) shall be direct applied Grade C sheeting.
- Background shall be Grade C reflective sheeting.

LETTER POSITIONS

Letter spacings are to start of next letter											Series/Size
											Text Length
C	o	n	c	o	r	d					D 2000
21.4	5	4.6	4.4	4.1	4.6	2.8	3.6	9.4			29.2
C	h	a	r	l	o	t	t	e			D 2000
20	5.3	4.4	4.6	3	1.9	4.1	2.5	2.8	3.5	8	32.1
T	r	o	y								D 2000
32.9	4.5	2.8	4.1	4.5	11.3						15.9

FILENAME: Guidesign_Engl1sh_8-2-13 NORTH CAROLINA D.O.T. SIGN DETAIL

SIGN NUMBER: 302
 TYPE: D
 QUANTITY: 1
 SIGN WIDTH: 8'-6"
 HEIGHT: 3'-0"
 TOTAL AREA: 25.5 Sq.Ft.
 BORDER TYPE: FLUSH
 RECESS: 0"
 WIDTH: 1"
 RADII: 3"
 NO. Z BARS: LENGTH:

SYMBOL	X	Y	WID	HT
--------	---	---	-----	----

BACKG COLOR: Green
 COPY COLOR: White
 MAT'L: 0.125" (3.2 mm) ALUMINUM

DESIGN BY: K HECTOR
 CHECKED BY: R KING
 Nov 30, 2018
 PROJECT ID: R-2530_B-4974
 DIV: 10



BORDER R=3" TH=1"

Spacing Factor is 1 unless specified otherwise

USE NOTES: 1,2

- Legend and border(except those that are colored black) shall be direct applied Grade C sheeting.
- Background shall be Grade C reflective sheeting.

LETTER POSITIONS

Letter spacings are to start of next letter											Series/Size					
											Text Length					
R	o	g	e	r	F	S	n	y	d	e	r	D 2000				
10	6.3	5.8	6.1	5.8	3	8	5	8	6.6	5.6	6.6	6.1	5.8	3	10	81.9
H	i	g	h	w	a	y										D 2000
29.6	7.2	2.6	6.4	5.6	9.6	5.4	6	29.6								42.8

FILENAME: Guidesign_Engl1sh_8-2-13 NORTH CAROLINA D.O.T. SIGN DETAIL

SIGN NUMBER: 312
 TYPE: D
 QUANTITY: 1
 SIGN WIDTH: 6'-6"
 HEIGHT: 3'-0"
 TOTAL AREA: 19.5 Sq.Ft.
 BORDER TYPE: FLUSH
 RECESS: 0"
 WIDTH: 1"
 RADII: 3"
 NO. Z BARS: LENGTH:

SYMBOL	X	Y	WID	HT
--------	---	---	-----	----

BACKG COLOR: Green
 COPY COLOR: White
 MAT'L: 0.125" (3.2 mm) ALUMINUM

DESIGN BY: K HECTOR
 CHECKED BY: R KING
 Nov 28, 2018
 PROJECT ID: R-2530_B-4974
 DIV: 10

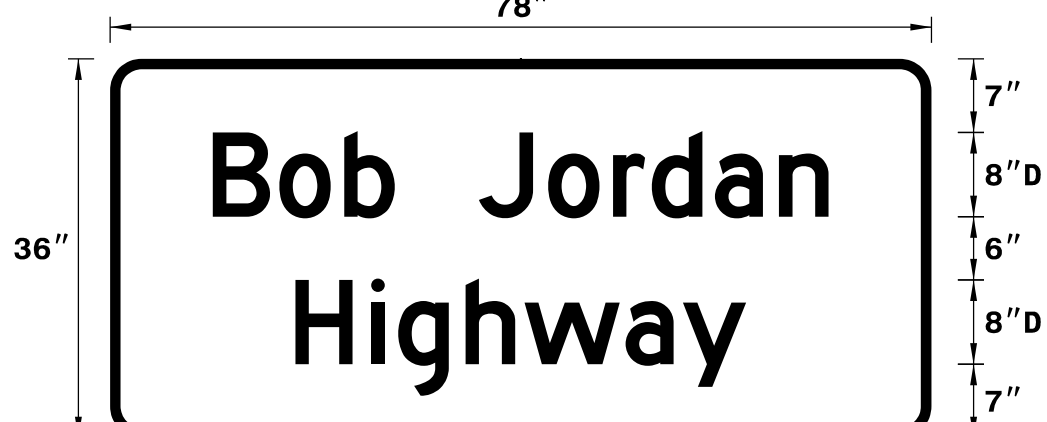

BORDER R=3" TH=1"

Spacing Factor is 1 unless specified otherwise

USE NOTES: 1 & 2

- Legend and border(except those that are colored black) shall be direct applied Grade C sheeting.
- Background shall be Grade C reflective sheeting.
- Shields; A, B, and C type arrows shall be on 0.032" (0.8mm) aluminum and demountable.

LETTER POSITIONS

Letter spacings are to start of next letter											Series/Size	
											Text Length	
B	o	b	J	o	r	d	a	n			D 2000	
9.8	6.3	6.2	4.8	8	6.6	6.2	3.7	6	6.1	4.7	9.8	58.5
H	i	g	h	w	a	y						D 2000
17.6	7.2	2.6	6.4	5.6	9.6	5.4	6	17.6				42.8

FILENAME: Guidesign_Engl1sh_8-2-13 NORTH CAROLINA D.O.T. SIGN DETAIL

PLOT DRIVER: pdfplotter
 USER: KHECTOR
 DATE: 12/05/18
 TIME: 15:54:04
 SCALE: 1:48.3408
 FILE: NCDOT\2015.NCDOT_TMSD.Limited.Ser.Vices.Contract.M.7000016704\NCDOT-R2530B.B4974_103.c..6.0.CAD.BTM.6.2.Work.In.Progess\Traffic\Signing\CADD\Signing_Layout_Plans\U2530B_Signing_S-3c.dgn

APPROVED: *Ron King* DATE: 12/13/2018



SIGN DESIGNS

SCALE:	NTS
DATE:	12/05/18
DWG. BY:	K HECTOR
DESIGN BY:	K HECTOR
REVIEWED BY:	R KING

REVISIONS	
CADD FILE	

PROJ. REFERENCE NO.	SHEET NO.
R-2530B	SIGN-3D
DOCUMENT NOT CONSIDERED FINAL UNLESS ALL SIGNATURES COMPLETED	
 HDR Engineering, Inc. of the Carolinas 555 Fayetteville St, Suite 900 Raleigh, N.C. 27601 N.C.B.E.L.S. License Number: F-0116	

SIGN NUMBER: 307
 TYPE: D
 QUANTITY: 1
 SIGN WIDTH: 5'-6"
 HEIGHT: 3'-0"
 TOTAL AREA: 16.5 Sq.Ft.

BACKG COLOR: Green
 COPY COLOR: White

SYMBOL	X	Y	WID	HT

MAT'L: 0.125" (3.2 mm) ALUMINUM

BORDER TYPE: FLUSH
 RECESS: 0"
 WIDTH: 1"
 RADII: 3"

NO. Z BARS:
 LENGTH:

DESIGN BY: none
 CHECKED BY:
 Nov 08, 2018
 PROJECT ID: ID
 DIV: DIV

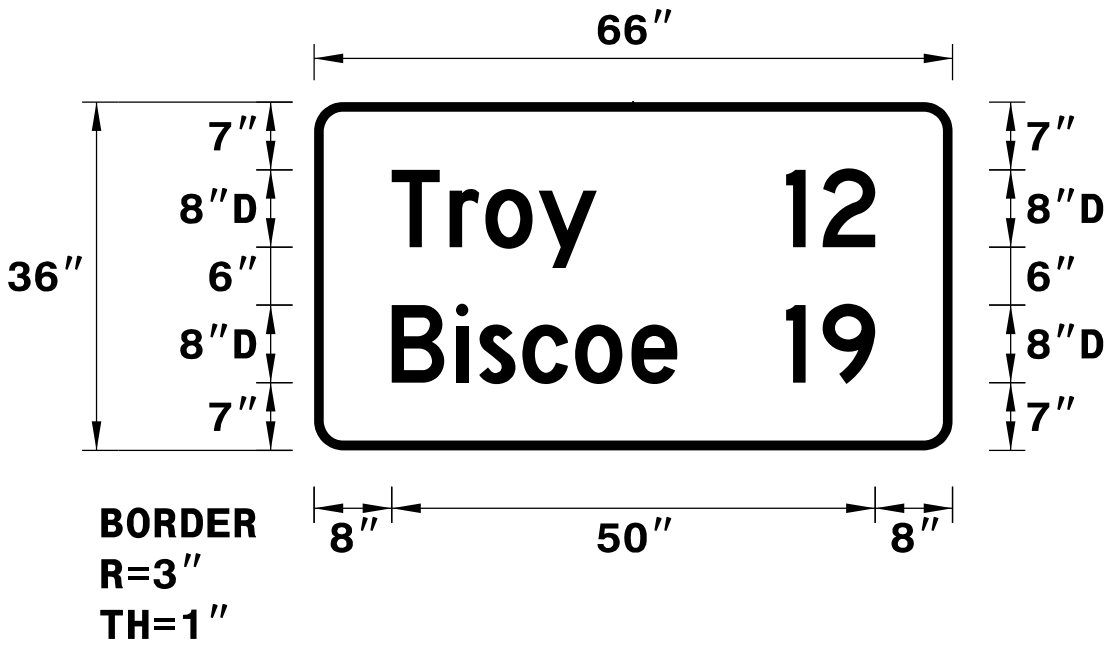

USE NOTES: 1,2

- Legend and border(except those that are colored black) shall be direct applied Grade C sheeting.
- Background shall be Grade C reflective sheeting.

LETTER POSITIONS

Letter spacings are to start of next letter

Series/Size	Text Length
D 2000	50
D 2000	50

FILENAME: Guidesign_English_8-2-13 NORTH CAROLINA D.O.T. SIGN DETAIL

SIGN NUMBER: 309
 TYPE: D
 QUANTITY: 1
 SIGN WIDTH: 5'-6"
 HEIGHT: 3'-6"
 TOTAL AREA: 19.3 Sq.Ft.

BACKG COLOR: Green/Green
 COPY COLOR: White

SYMBOL	X	Y	WID	HT
AR_Type D	17.3	29	6	9
AR_Type D	49.1	10	6	9

MAT'L: 0.125" (3.2 mm) ALUMINUM

BORDER TYPE: FLUSH
 RECESS: 0"
 WIDTH: 0.75"
 RADII: 6"

NO. Z BARS:
 LENGTH:

DESIGN BY: R DRAYTON
 CHECKED BY: R KING
 Nov 30, 2018
 PROJECT ID: R-2530_B-4974
 DIV: 10

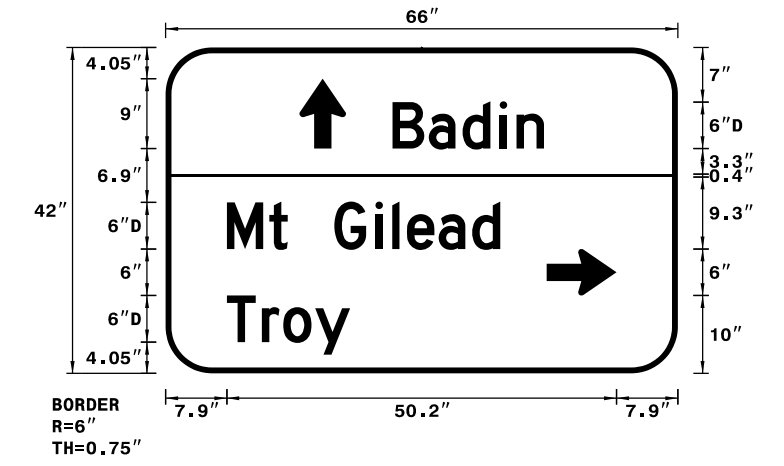

USE NOTES: 1 & 2

- Legend and border(except those that are colored black) shall be direct applied Grade C sheeting.
- Background shall be Grade C reflective sheeting.
- Shields; A, B, and C type arrows shall be on 0.032" (0.8mm) aluminum and demountable.

LETTER POSITIONS

Letter spacings are to start of next letter

Series/Size	Text Length
D 2000	19.5
D 2000	35.2
D 2000	15.9

FILENAME: Guidesign_English_8-2-13 NORTH CAROLINA D.O.T. SIGN DETAIL

SIGN NUMBER: 310
 TYPE: D
 QUANTITY: 1
 SIGN WIDTH: 8'-0"
 HEIGHT: 3'-0"
 TOTAL AREA: 24.0 Sq.Ft.

BACKG COLOR: Green
 COPY COLOR: White

SYMBOL	X	Y	WID	HT
AR_Type D	8	13.7	8	12

MAT'L: 0.125" (3.2 mm) ALUMINUM

BORDER TYPE: FLUSH
 RECESS: 0"
 WIDTH: 1"
 RADII: 3"

NO. Z BARS:
 LENGTH:

DESIGN BY: K Hector
 CHECKED BY: R Drayton
 Oct 26, 2018
 PROJECT ID: R-2530_B-4974
 DIV: 10

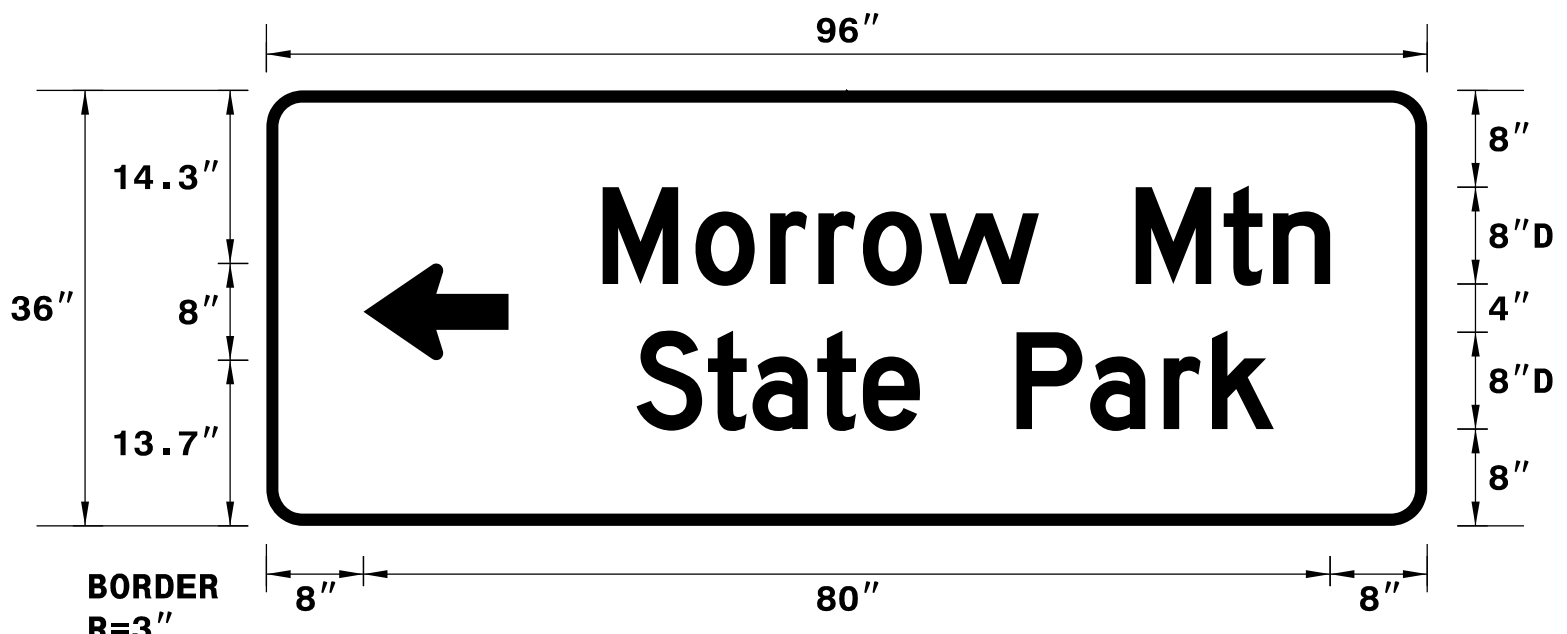

USE NOTES: 1,2

- Legend and border(except those that are colored black) shall be direct applied Grade C sheeting.
- Background shall be Grade C reflective sheeting.

LETTER POSITIONS

Letter spacings are to start of next letter

Series/Size	Text Length
D 2000	60.2
D 2000	52.7

FILENAME: Guidesign_English_8-2-13 NORTH CAROLINA D.O.T. SIGN DETAIL

APPROVED: *Ron King* DATE: 12/13/2018

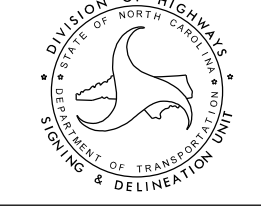

SIGN DESIGNS

SCALE: NTS		REVISIONS _____ _____ _____
DATE: 12/05/18		
DWG. BY: K HECTOR		
DESIGN BY: K HECTOR		
REVIEWED BY: R KING	CADD FILE	

PLOT DRIVER: pdfplotter
 USER: KHECTOR
 FILE: NCDOT\2015.NCDOT_TMSD.Limited.Ser.Vices.Contract.M.7000016704\NCDOT-R2530B.B4974_103.c.\6.0.CAD.BTM\6.2.Work\In_Progress\Traffic\Signing\CADD\Signing_Layout_Plans\U2530B_Signing_S-3d.dgn
 PENTABLE: NCDOT_Signing.tbl
 TIME: 15:55:50
 SCALE: 1:48.3408
 DATE: 12/05/18

REVISIONS

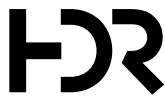
PROJ. REFERENCE NO.	SHEET NO.
R-2530B	SIGN-3E
DOCUMENT NOT CONSIDERED FINAL UNLESS ALL SIGNATURES COMPLETED	
 HDR Engineering, Inc. of the Carolinas 555 Fayetteville St, Suite 900 Raleigh, N.C. 27601 N.C.B.E.L.S. License Number: F-0116	

SIGN NUMBER: 311 BACKG COLOR: Green/Green
 TYPE: D COPY COLOR: White

QUANTITY: 1

SYMBOL	X	Y	WID	HT
AR_Type D	9.6	25.3	8	12
AR_Type D	8.5	6.8	8	12

SIGN WIDTH: 7'-0"
 HEIGHT: 3'-6"
 TOTAL AREA: 24.5 Sq.Ft.

BORDER TYPE: FLUSH
 RECESS: 0"
 WIDTH: 1"
 RADII: 3"

NO. Z BARS:
 LENGTH:

MAT'L: 0.125" (3.2 mm) ALUMINUM

DESIGN BY: K Hector CHECKED BY: R Drayton Oct 26, 2018
 PROJECT ID: R-2530_B-4974 DIV: 10

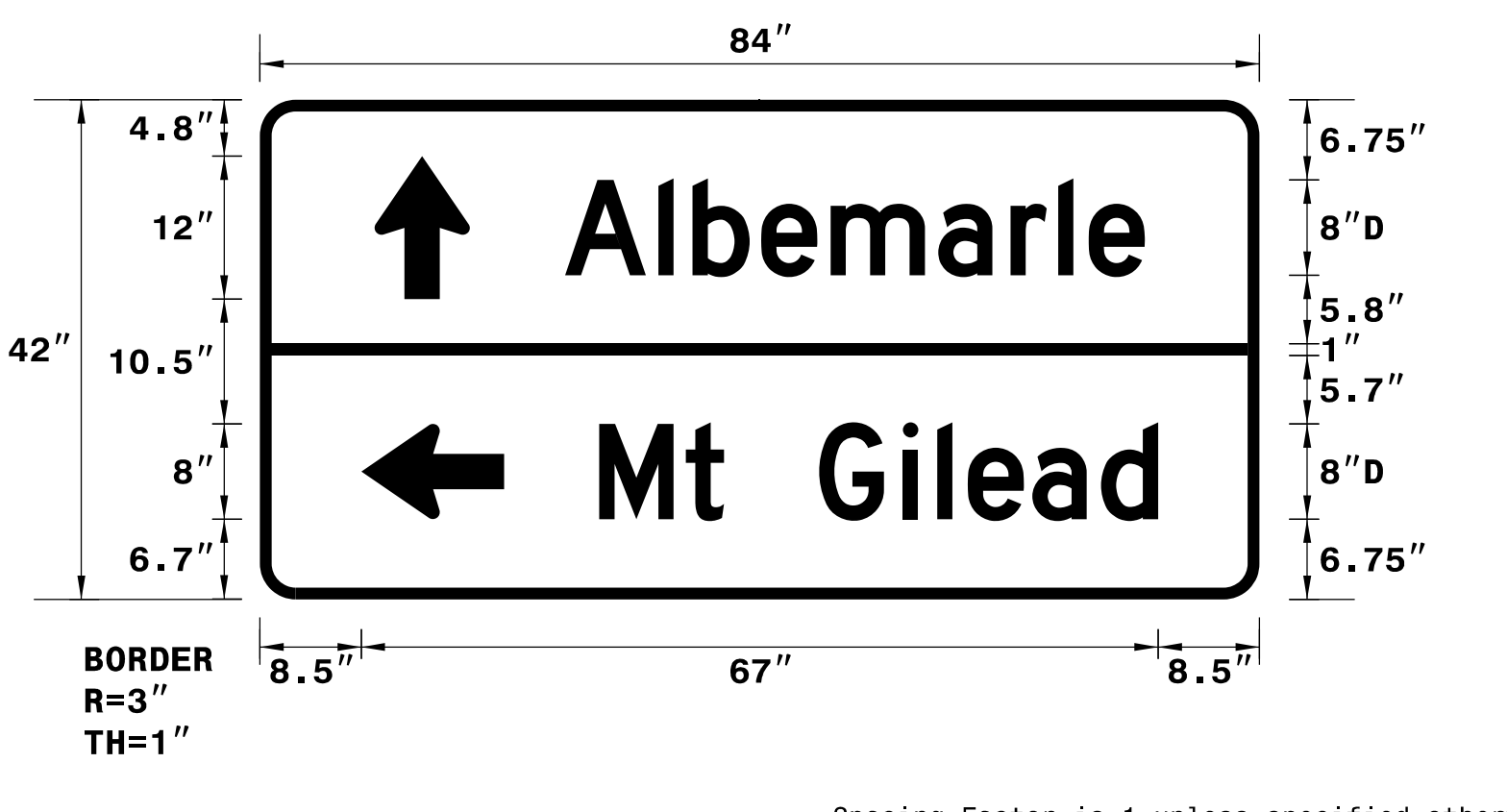

BORDER R=3" TH=1"

Spacing Factor is 1 unless specified otherwise

USE NOTES: 1,2

- Legend and border(except those that are colored black) shall be direct applied Grade C sheeting.
- Background shall be Grade C reflective sheeting.

LETTER POSITIONS

Letter spacings are to start of next letter

Letter spacings are to start of next letter												Series/Size Text Length
25.6	7.8	2.9	5.8	5.8	9	6.1	4	2.6	4.7	9.6		D 2000 48.7
28.5	7.3	3.2	8	7	2.9	2.6	5.4	5.8	4.8	8.5		D 2000 47

FILENAME: Guidesign_English_8-2-13 NORTH CAROLINA D.O.T. SIGN DETAIL

SIGN NUMBER: 303 BACKG COLOR: Green
 TYPE: D COPY COLOR: White

QUANTITY: 1

SYMBOL	X	Y	WID	HT
AR_Type D	61.3	8	8	12

SIGN WIDTH: 7'-0"
 HEIGHT: 2'-0"
 TOTAL AREA: 14.0 Sq.Ft.

BORDER TYPE: FLUSH
 RECESS: 0"
 WIDTH: 1"
 RADII: 3"

NO. Z BARS:
 LENGTH:

MAT'L: 0.125" (3.2 mm) ALUMINUM

DESIGN BY: K Hector CHECKED BY: R Drayton Oct 26, 2018
 PROJECT ID: R-2530_B-4974 DIV: 10

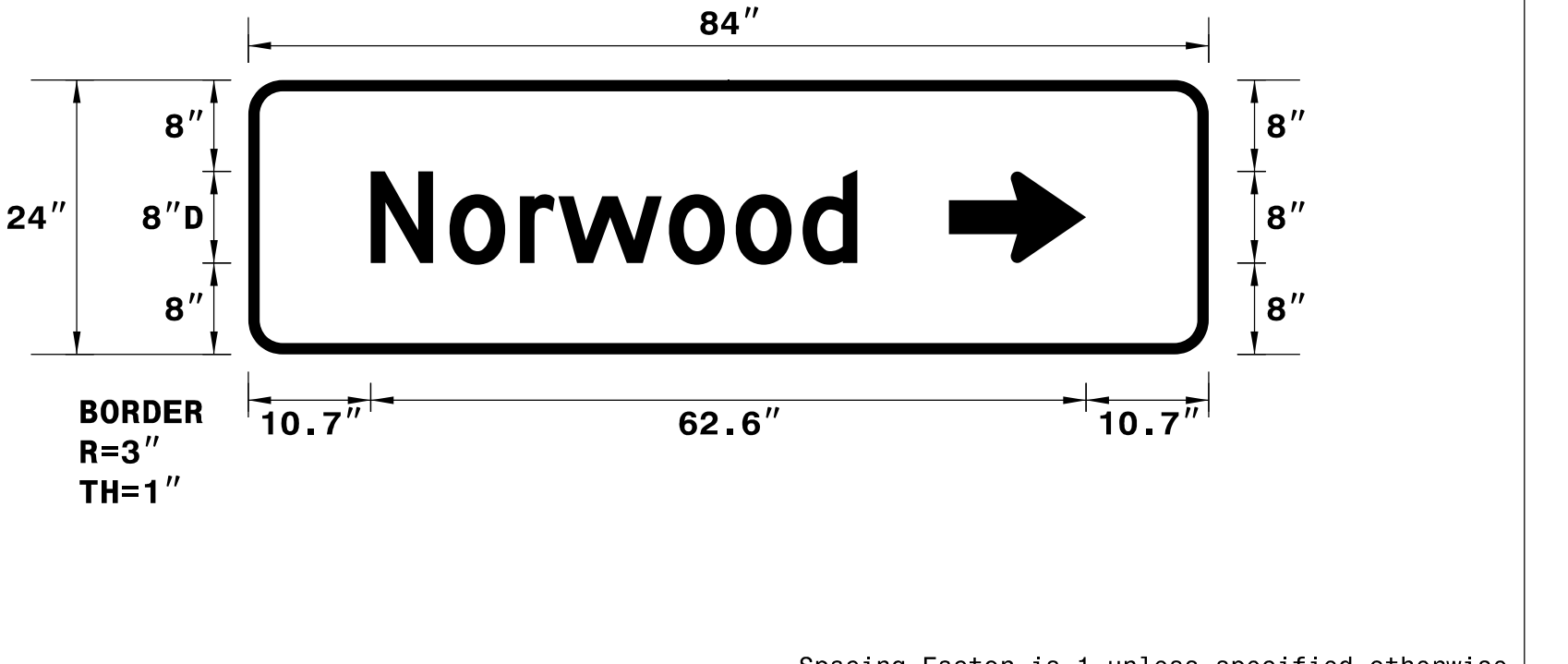

BORDER R=3" TH=1"

Spacing Factor is 1 unless specified otherwise

USE NOTES: 1,2

- Legend and border(except those that are colored black) shall be direct applied Grade C sheeting.
- Background shall be Grade C reflective sheeting.

LETTER POSITIONS

Letter spacings are to start of next letter

Letter spacings are to start of next letter											Series/Size Text Length
10.7	6.9	6.2	3.4	9.7	5.8	5.8	4.8	30.7			D 2000 42.6

FILENAME: Guidesign_English_8-2-13 NORTH CAROLINA D.O.T. SIGN DETAIL

SIGN NUMBER: 304 BACKG COLOR: Green
 TYPE: D COPY COLOR: White

QUANTITY: 1

SYMBOL	X	Y	WID	HT
AR_Type D	10.7	8	8	12

SIGN WIDTH: 7'-0"
 HEIGHT: 2'-0"
 TOTAL AREA: 14.0 Sq.Ft.

BORDER TYPE: FLUSH
 RECESS: 0"
 WIDTH: 1"
 RADII: 3"

NO. Z BARS:
 LENGTH:

MAT'L: 0.125" (3.2 mm) ALUMINUM

DESIGN BY: K Hector CHECKED BY: R Drayton Oct 26, 2018
 PROJECT ID: R-2530_B-4974 DIV: 10

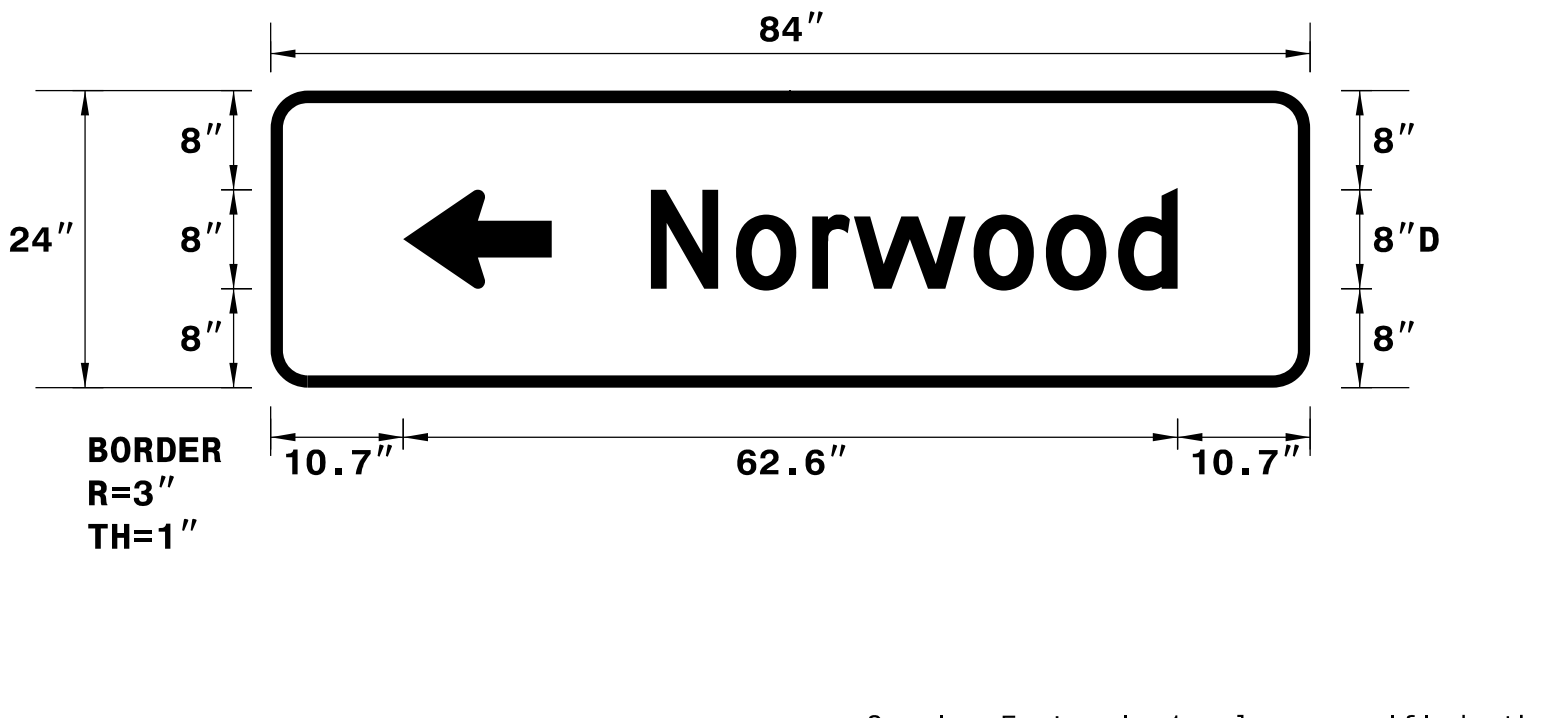

BORDER R=3" TH=1"

Spacing Factor is 1 unless specified otherwise

USE NOTES: 1,2

- Legend and border(except those that are colored black) shall be direct applied Grade C sheeting.
- Background shall be Grade C reflective sheeting.

LETTER POSITIONS

Letter spacings are to start of next letter

Letter spacings are to start of next letter											Series/Size Text Length
30.7	6.9	6.2	3.4	9.7	5.8	5.8	4.8	10.7			D 2000 42.6

FILENAME: Guidesign_English_8-2-13 NORTH CAROLINA D.O.T. SIGN DETAIL

PLOT DRIVER: pdfplotter DATE: 12/05/18 SCALE: 1:48.3408
 USER: KHECTOR TIME: 15:57:23
 FILE: NCDOT\2015.NCDOT_TMSD.Limited.Services.Contract.M.7000016704\NCDOT-R2530B.B4974.IT03.c.\6.0.CAD.BTMX.6.2.Work.In.Progress\Traffic\Signing\CADD\Signing_Layout_Plans\U2530B_Signing_S-3e.dgn

APPROVED: *Ronald W. King* DATE: 12/13/2018



SIGN DESIGNS

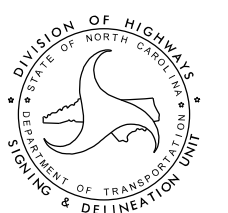

SCALE: NTS	REVISIONS
DATE: 12/05/18	
DWG. BY: K HECTOR	
DESIGN BY: K HECTOR	
REVIEWED BY: R KING	

PLOT DRIVER: pdfplotter; USER: KHECTOR; DATE: 12/12/18; TIME: 10:15:33; SCALE: 1:7.99999; PENTABLE: NCDOT_Signing.tbl; FILE: NCDOT\2015.NCDOT_TMSD.Limited.Ser.Vices.Contract.M.7000016704\NCDOT-R2530B.B4974_1.T03.c.\6.0.CAD.BTM\6.2.Work.In.Progess\Traffic\Signing\CADD\Signing_Layout_Plans\U2530B_SGN_Esigns.dgn

REVISIONS

401 QUANTITY REQ'D 36

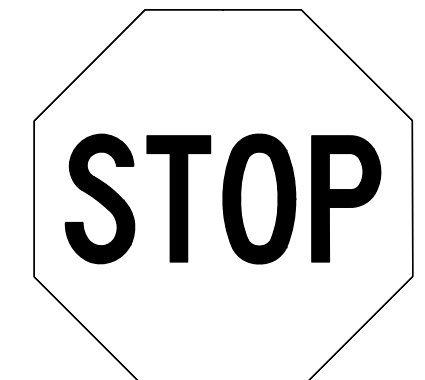

36 X 36
R1-1

MOUNTED BACK TO BACK WITH SIGN 402 IN 1 INSTALLATION
MOUNTED UNDER SIGN #409 IN 27 INSTALLATIONS
ONE "U POST" PER SIGN

406 QUANTITY REQ'D 1



36 X 36
W1-2L

ONE "U POST"

411 QUANTITY REQ'D 8

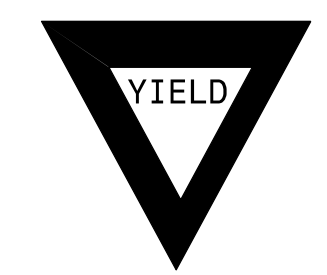

30 X 30 X 30
R1-2

ONE "U POST" PER SIGN

416 QUANTITY REQ'D 4

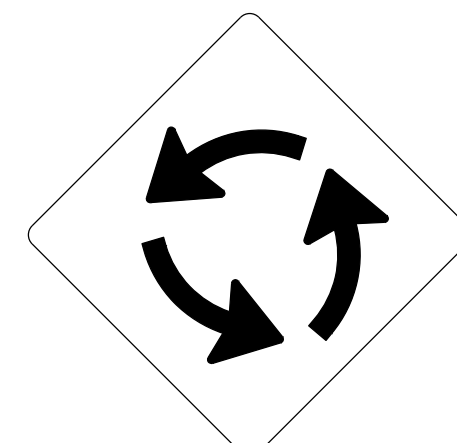

30 X 30
W2-6

ONE "U POST" PER SIGN

421 QUANTITY REQ'D 24



54 X 18
R6-1L

MOUNTED BACK TO BACK WITH SIGN 453 IN 3 INSTALLATION
TWO "U POSTS" PER SIGN

426 QUANTITY REQ'D 2

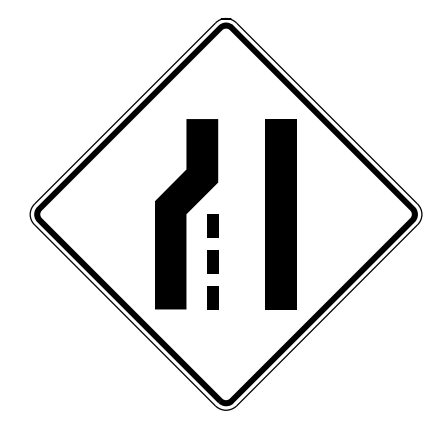

48 X 48
W4-2L

ONE "U POST" PER SIGN

402 QUANTITY REQ'D 6



36 X 36
R5-1

MOUNTED BACK TO BACK WITH SIGN 401 IN 1 INSTALLATION
ONE "U POST" PER SIGN

407 QUANTITY REQ'D 27

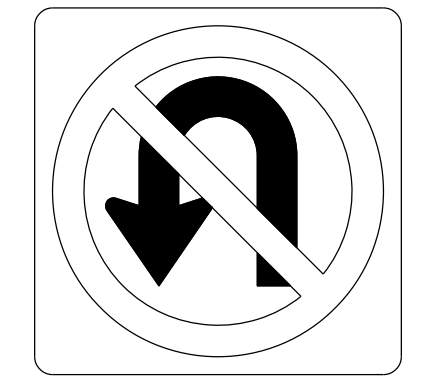

R3-4
36 X 36

ONE "U POST" PER SIGN

412 QUANTITY REQ'D 9



36 X 36
W11-2

ONE "U POST" PER SIGN

417 QUANTITY REQ'D 2

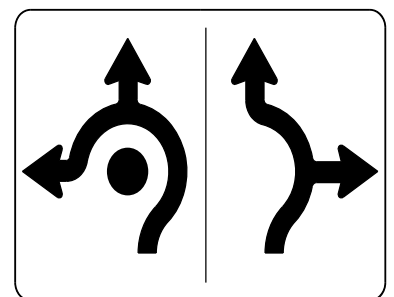

36 X 36
R3-8RA

ONE "U POST" PER SIGN

422 QUANTITY REQ'D 6

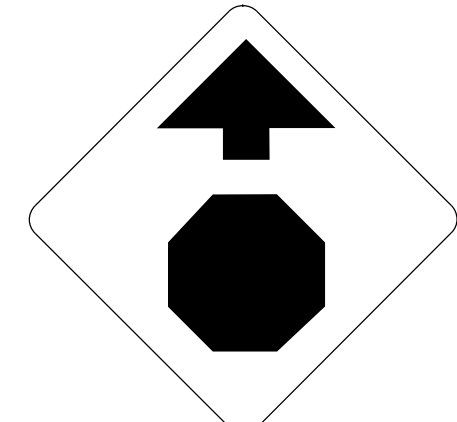

30 X 30
W3-1

ONE "U POST" PER SIGN

427 QUANTITY REQ'D 1

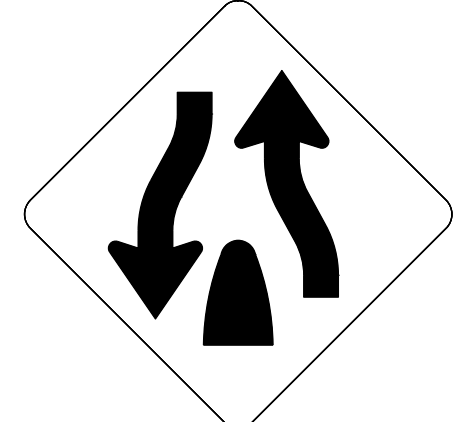

36 X 36
W6-2

ONE "U POST"

PROJ. REFERENCE NO. R-2530B	SHEET NO. SIGN-4
DOCUMENT NOT CONSIDERED FINAL UNLESS ALL SIGNATURES COMPLETED	
 HDR Engineering, Inc. of the Carolinas 555 Fayetteville St, Suite 900 Raleigh, N.C. 27601 N.C.B.E.L.S. License Number: F-0116	

NOTE:
THIS DRAWING IS DIMENSIONED IN INCHES UNLESS OTHERWISE DEPICTED WITHIN THE DRAWING.

403 QUANTITY REQ'D 12

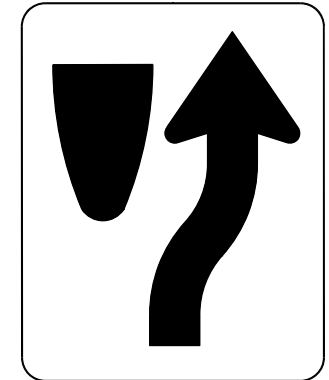

24 X 30
R4-7

ONE "U POST" PER SIGN

408 QUANTITY REQ'D 1



24 X 30
R4-1

ONE "U POST" PER SIGN

413 QUANTITY REQ'D 9



21 X 15
M6-2A(L)

MOUNTED UNDER SIGN #414 IN 7 INSTALLATIONS

418 QUANTITY REQ'D 2

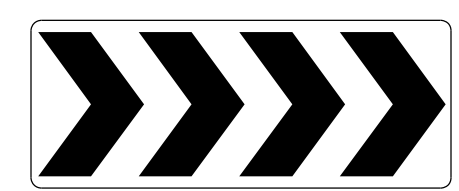

60 X 24
R6-4B

TWO "U POSTS" PER SIGN

423 QUANTITY REQ'D 1



48 X 48
W9-1

TWO "U POSTS" PER SIGN

428 QUANTITY REQ'D 1

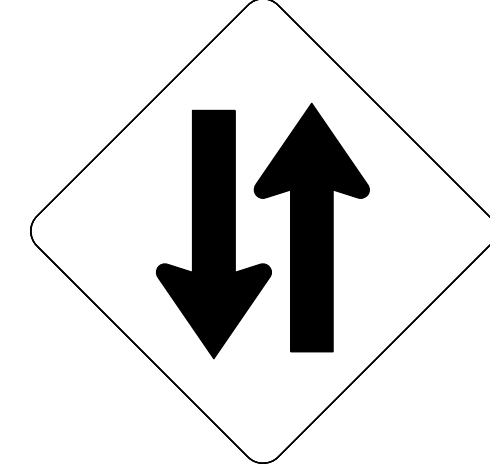

36 X 36
W6-3

ONE "U POST"

431 QUANTITY REQ'D 1

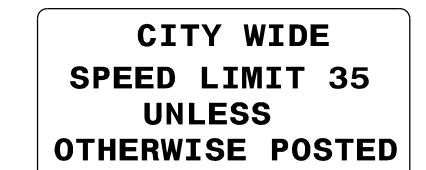

42 X 30
R2-27

ONE "U POST"

404 QUANTITY REQ'D 12

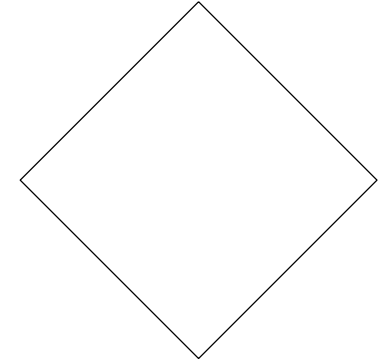

18 X 18
OM4-3

MOUNTED UNDER SIGN #403 IN 12 INSTALLATIONS

409 QUANTITY REQ'D 27



36 X 12
R6-1R

MOUNTED TO SIGN #401

414 QUANTITY REQ'D 8

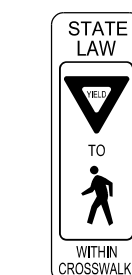

12 X 36
R1-6B

ONE "U POST" PER SIGN

419 QUANTITY REQ'D 2

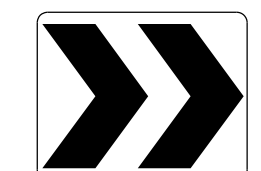

30 X 24
R6-4

TWO "U POSTS" PER SIGN

424 QUANTITY REQ'D 3

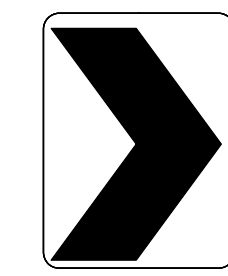

18 X 24
W1-8R

ONE "U POST" PER SIGN

429 QUANTITY REQ'D 11

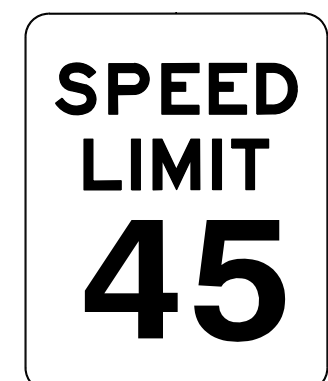

30 X 36
R2-1

ONE "U POST" PER SIGN

405 QUANTITY REQ'D 1

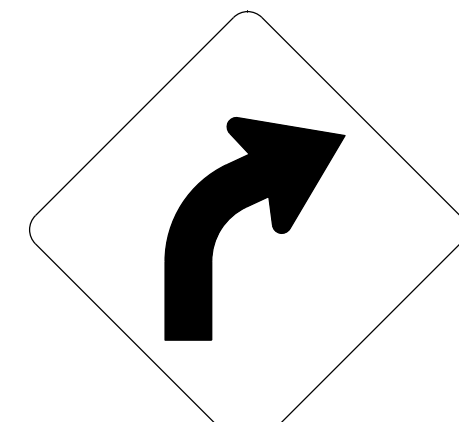

36 X 36
W1-2R

ONE "U POST"

410 QUANTITY REQ'D 32

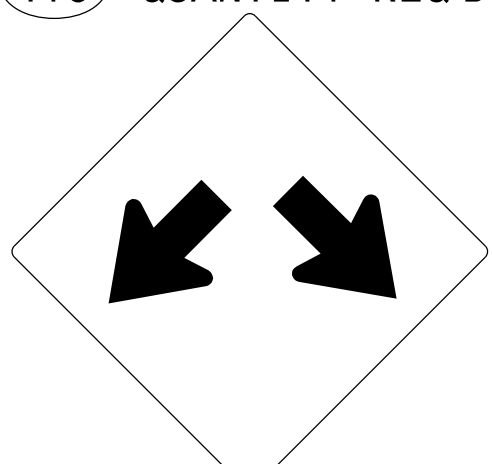

36 X 36
W12-1

ONE "U POST" PER SIGN

430 QUANTITY REQ'D 15



30 X 36
R2-1

TWO "U POSTS" PER SIGN

420 QUANTITY REQ'D 36

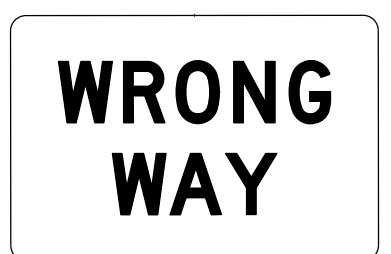

36 X 24
R5-1a

ONE "U POST" PER SIGN

APPROVED: *Ronald W. King* DATE: 12/13/2018



TYPE "E" SIGNS

SCALE: NTS		REVISIONS	
DATE: 12/12/18			
DWG. BY: K HECTOR			
DESIGN BY: K HECTOR			
REVIEWED BY: R KING			

CADD FILE

PLOT DRIVER: pdfplotter
USER: KHECTOR
FILE: NCDOT\2015.NCDOT_TMSD.Limited.Ser.Vices.Contract.M.7000016704\NCDOT-R2530B.B4974.103.c.\6.0.CAD.BTM.6.2.Work.In.Progess.Traffic.Signing\CADD\Signing_Layout_Plans\U2530B_SCN_EsignsB.dgn
PENTABLE: NCDOT_Signing.tbl
TIME: 10:11:18
SCALE: 1:7.99999
DATE: 12/12/18
REVISIONS

432 QUANTITY REQ'D 1

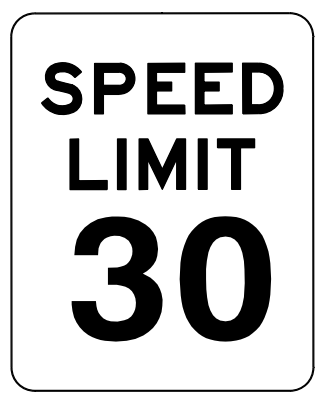

30 X 36
R2-1

ONE "U POST"

437 QUANTITY REQ'D 3



36 X 36
W14-2

ONE "U POST" PER SIGN

442 QUANTITY REQ'D 2

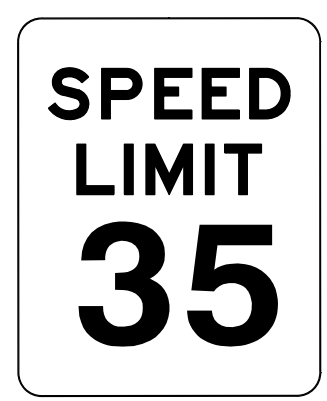

30 X 36
R2-1

ONE "U POST"

447 QUANTITY REQ'D 1

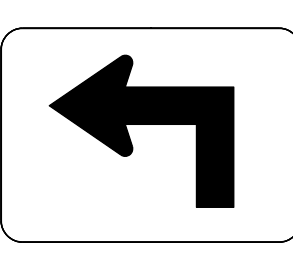

21 X 15
M5-1

MOUNTED UNDER SIGN #444
IN 1 INSTALLATION

452 QUANTITY REQ'D 2



24 X 30
R20-3

ONE "U POST"

433 QUANTITY REQ'D 1

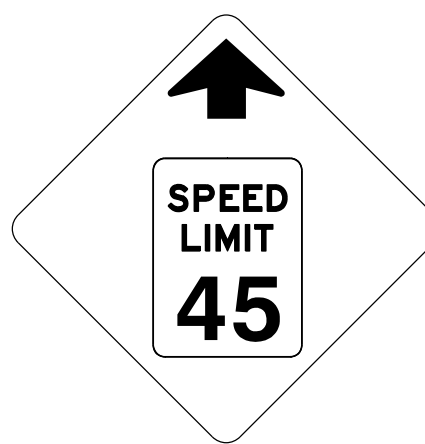

36 X 36
W3-5

ONE "U POST"

438 QUANTITY REQ'D 1



W11-10
36 X 36

ONE "U POST"

443 QUANTITY REQ'D 2



36 X 36
R3-7L

ONE "U POST" PER SIGN

448 QUANTITY REQ'D 1

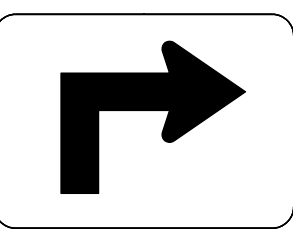

21 X 15
M5-1

MOUNTED UNDER SIGN #446
IN 1 INSTALLATION

453 QUANTITY REQ'D 3



54 X 18
R6-1R

MOUNTED BACK TO BACK WITH
SIGN 421 IN 3 INSTALLATION

434 QUANTITY REQ'D 1



36 X 36
S4-5

ONE "U POST"

439 QUANTITY REQ'D 1

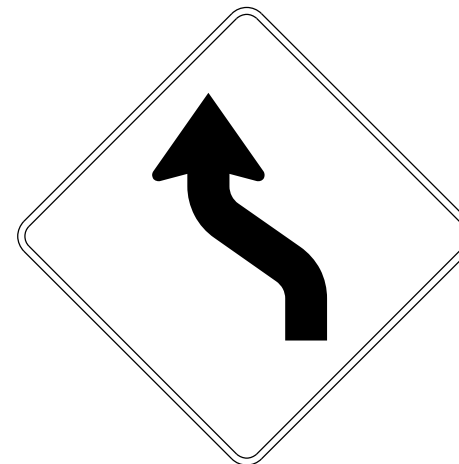

30 X 30
W1-4

ONE "U POST"

444 QUANTITY REQ'D 2

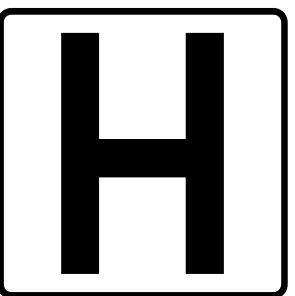

24 X 24
D9-2

ONE "U POST" PER SIGN

449 QUANTITY REQ'D 3

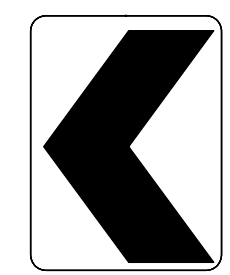

18 X 24
W1-8L

ONE "U POST" PER SIGN

435 QUANTITY REQ'D 1

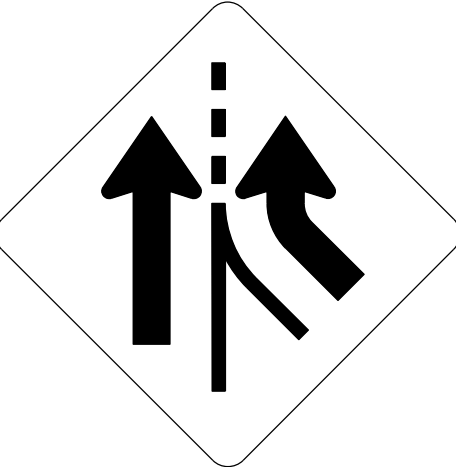

48 X 48
W4-3

TWO "U POSTS"

440 QUANTITY REQ'D 1



24 X 24
W13-1P

MOUNT UNDER SIGN 439
IN 1 INSTALLATION

445 QUANTITY REQ'D 1



21 X 15
M6-3

MOUNTED UNDER SIGN #444
IN 1 INSTALLATION

450 QUANTITY REQ'D 1



21 X 15
M6-2A(R)

MOUNTED UNDER SIGN #414
IN 1 INSTALLATIONS

436 QUANTITY REQ'D 2



36 X 36
W11-8

ONE "U POST" PER SIGN

441 QUANTITY REQ'D 2



24 X 24
W13-1P

MOUNT UNDER SIGN 405
IN 1 INSTALLATION
MOUNT UNDER SIGN 406
IN 1 INSTALLATION

446 QUANTITY REQ'D 1

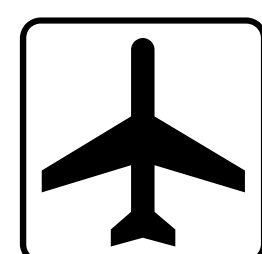

24 X 24
I-5

ONE "U POST"

451 QUANTITY REQ'D 1

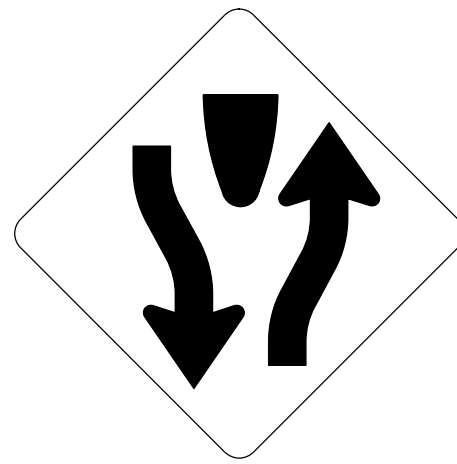

36 X 36
W6-1

ONE "U POST"

PROJ. REFERENCE NO.	SHEET NO.
R-2530B	SIGN-4A
DOCUMENT NOT CONSIDERED FINAL UNLESS ALL SIGNATURES COMPLETED	
 HDR Engineering, Inc. of the Carolinas 555 Fayetteville St, Suite 900 Raleigh, N.C. 27601 N.C.B.E.L.S. License Number: F-0116	

NOTE:
THIS DRAWING IS DIMENSIONED
IN INCHES UNLESS OTHERWISE
DEPICTED WITHIN THE DRAWING.

APPROVED: *Ronald W. King* DATE: 12/13/2018



SEAL
022959
RONALD W. KING
ENGINEER

TYPE "E" SIGNS

SCALE:	NTS
DATE:	12/12/18
DESIGN BY:	K HECTOR
REVIEWED BY:	R KING



REVISIONS	

CADD FILE

PLOT DRIVER: pdfplotcf9
USER: KHECTOR
FILE: NCDOT\2015.NCDOT_TMSD.Limited.Ser.Vices.Contract.M.7000016704\NCDOT-R2530B.B4974_103.c_.\6.0.CAD.BTM.6.2.Work.In.Progress\Traffic\Signing\CADD\Signing_Layout_Plans\U2530B_SGN_F_Signs.dgn
PENTABLE: NCDOT_Signing.tbl
SCALE: 1:7.99999
DATE: 12/11/18
TIME: 16:21:35
REVISIONS

501

2 - 21 X 15
2 - 24 X 24
2 - 24 X 24

TWO "U" POSTS

506

2 - 24 X 12
2 - 24 X 12
2 - 24 X 24
2 - 21 X 15

TWO "U" POSTS

521 527 564

1 - 24 X 12
2 - 24 X 12
2 - 24 X 24
2 - 24 X 24
2 - 24 X 24
2 - 21 X 15

TWO "U" POSTS PER SIGN

569

1 - 24 X 12
1 - 24 X 24
1 - 24 X 24

ONE "U" POST

560

1 - 21 X 15
1 - 24 X 24

ONE "U" POST

515

1 - 24 X 12
1 - 24 X 24
1 - 21 X 15

ONE "U" POST

502

2 - 24 X 12
2 - 24 X 24
2 - 24 X 24
1 - 24 X 12
3 - 24 X 24
3 - 21 X 15

THREE "U" POSTS

507

1 - 24 X 12
1 - 24 X 24
1 - 24 X 12
2 - 24 X 24
2 - 21 X 15

TWO "U" POSTS

528 541

1 - 24 X 12
2 - 24 X 12
2 - 24 X 24
2 - 24 X 24
2 - 24 X 24
2 - 21 X 15

TWO "U" POST PER SIGN

554

1 - 24 X 12
1 - 24 X 24
2 - 24 X 12
2 - 24 X 24
2 - 21 X 15

TWO "U" POSTS

561

1 - 24 X 12
1 - 24 X 24

ONE "U" POST

533

1 - 24 X 12
2 - 24 X 24
1 - 24 X 12
2 - 24 X 24
2 - 21 X 15

TWO "U" POSTS

509

2 - 24 X 12
2 - 24 X 24
2 - 24 X 24
2 - 24 X 24
2 - 21 X 15

TWO "U" POST

508

2 - 24 X 12
2 - 24 X 24
2 - 24 X 24
2 - 24 X 24
2 - 21 X 15

TWO "U" POST

517 519 536 537 542 545 552 525 531

1 - 24 X 12
1 - 24 X 24
1 - 24 X 24
1 - 24 X 24

ONE "U" POST PER SIGN

555

2 - 24 X 12
2 - 24 X 24
2 - 24 X 24
2 - 21 X 15

TWO "U" POSTS

562

2 - 24 X 12
2 - 24 X 24
2 - 21 X 15

TWO "U" POST

504

1 - 24 X 12
1 - 24 X 24

ONE "U" POST

510 518 529 534 539 543 550 522 568

1 - 24 X 12
1 - 24 X 24
1 - 24 X 24
1 - 24 X 24
1 - 21 X 15

ONE "U" POST PER SIGN

513 520 524 526 532 538 540 546

1 - 24 X 12
1 - 24 X 24
1 - 24 X 24
1 - 24 X 24
1 - 21 X 15

ONE "U" POST PER SIGN

557

1 - 24 X 12
1 - 24 X 24
1 - 24 X 12
2 - 24 X 24

TWO "U" POSTS

548

1 - 24 X 12
1 - 24 X 12
1 - 24 X 24
1 - 24 X 12
2 - 24 X 24
2 - 21 X 15

TWO "U" POST

505

1 - 24 X 12
1 - 24 X 24
1 - 24 X 24
1 - 24 X 12
2 - 24 X 24
2 - 21 X 15

TWO "U" POSTS

511 530 535 544 549 523 567 570 571 572 573

1 - 24 X 12
1 - 24 X 24
1 - 24 X 24
1 - 24 X 24

ONE "U" POST PER SIGN

547

1 - 24 X 12
1 - 24 X 24
2 - 24 X 24
2 - 21 X 15

TWO "U" POSTS

559

1 - 24 X 12
1 - 24 X 12
1 - 24 X 24
2 - 21 X 15

ONE "U" POST

THIS DRAWING IS DIMENSIONED IN INCHES UNLESS OTHERWISE DEPICTED WITHIN THE DRAWING.

APPROVED: *Ronald W. King* DATE: 12/13/2018

TYPE "F" SIGNS

SCALE: NTS
DATE: 12/11/18
DWG. BY: K HECTOR
DESIGN BY: K HECTOR
REVIEWED BY: R KING

PROFESSIONAL SEAL
SEAL 022959
ENGINEER
RONALD W. KING

REVISIONS

CADD FILE

PROJ. REFERENCE NO. R-2530B SHEET NO. SIGN-4B

DOCUMENT NOT CONSIDERED FINAL UNLESS ALL SIGNATURES COMPLETED

HDR HDR Engineering, Inc. of the Carolinas
555 Fayetteville St, Suite 900 Raleigh, N.C. 27601
N.C.B.E.L.S. License Number: F-0116

PROJ. REFERENCE NO.	SHEET NO.
R-2530B	SIGN-5
DOCUMENT NOT CONSIDERED FINAL UNLESS ALL SIGNATURES COMPLETED	
 HDR Engineering, Inc. of the Carolinas 555 Fayetteville St, Suite 900 Raleigh, N.C. 27601 N.C.B.E.L.S. License Number: F-0116	

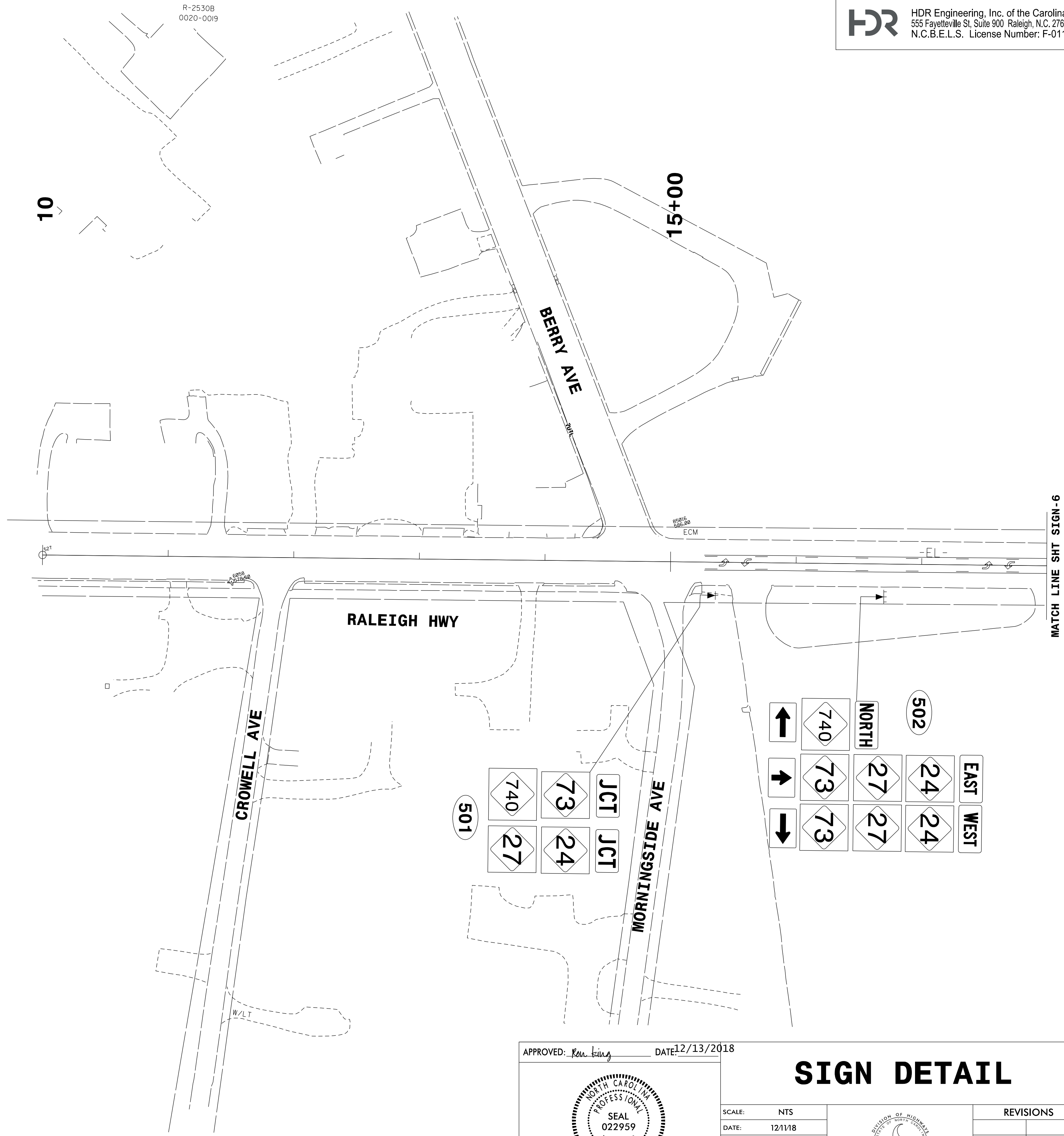

REVISIONS

PLOT DRIVER: pdfplotcf9
 USER: KHECTOR
 FILE: NCDOT\2015.NCDOT_TMSD.Limited.Services.Contract.M.7000016704\NCDOT-R2530B.B4974.T03.c.\6.0.CAD.BTM.6.2.Work.In.Progress\Traffic\Signing\CADD\Signing_Layout_Plans\U2530B_Signing_Sht_1.dgn

PENTABLE: NCDOT_Signing.tbl
 TIME: 16:27:54
 SCALE: 1:48.3408

DATE: 12/11/18
 DATE: 12/13/2018

APPROVED: *Ronald W. King* DATE: 12/13/2018



SIGN DETAIL

SCALE: NTS		REVISIONS	
DATE: 12/11/18			
DWG. BY: K HECTOR			
DESIGN BY: K HECTOR			
REVIEWED BY: R KING			

CADD FILE

PROJ. REFERENCE NO. R-2530B	SHEET NO. SIGN-6
DOCUMENT NOT CONSIDERED FINAL UNLESS ALL SIGNATURES COMPLETED	
 HDR Engineering, Inc. of the Carolinas 555 Fayetteville St, Suite 900 Raleigh, N.C. 27601 N.C.B.E.L.S. License Number: F-0116	

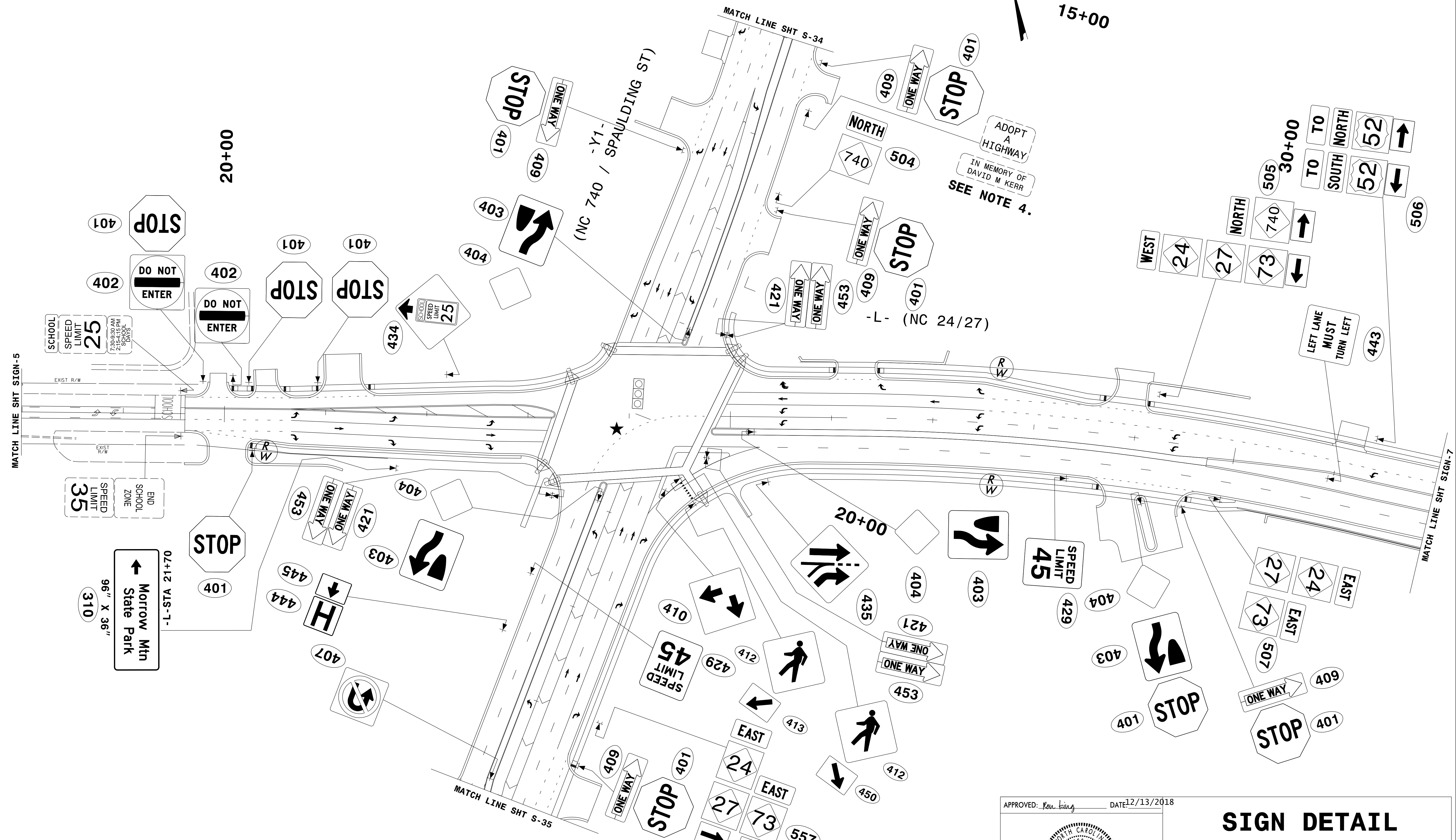

APPROVED: *Ron King* DATE: 12/13/2018

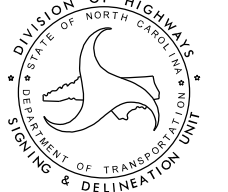

SIGN DETAIL

SCALE: NTS		REVISIONS
DATE: 12/12/18		
DWG. BY: K HECTOR		
DESIGN BY: K HECTOR		
REVIEWED BY: R KING		

PLOT DRIVER: pdfplotter
 USER: KHECTOR
 FILE: NCDOT\2015.NCDOT_TMSD.Limited.Services.Contract.M.7000016704.NCDOT-R2530B.B4974.1.T03.c.\6.0.CAD.BTM\6.2.Work.In.Progress\Traffic\Signing\CADD\Signing_Layout_Plans\U2530B_Signing_Sht_2.dgn
 PENTABLE: NCDOT_Signing.tbl
 TIME: 08:29:36
 SCALE: 1:48.3408
 DATE: 12/12/18
 REVISIONS

PROJ. REFERENCE NO. R-2530B	SHEET NO. SIGN-6A
DOCUMENT NOT CONSIDERED FINAL UNLESS ALL SIGNATURES COMPLETED	
 HDR Engineering, Inc. of the Carolinas 555 Fayetteville St, Suite 900 Raleigh, N.C. 27601 N.C.B.E.L.S. License Number: F-0116	

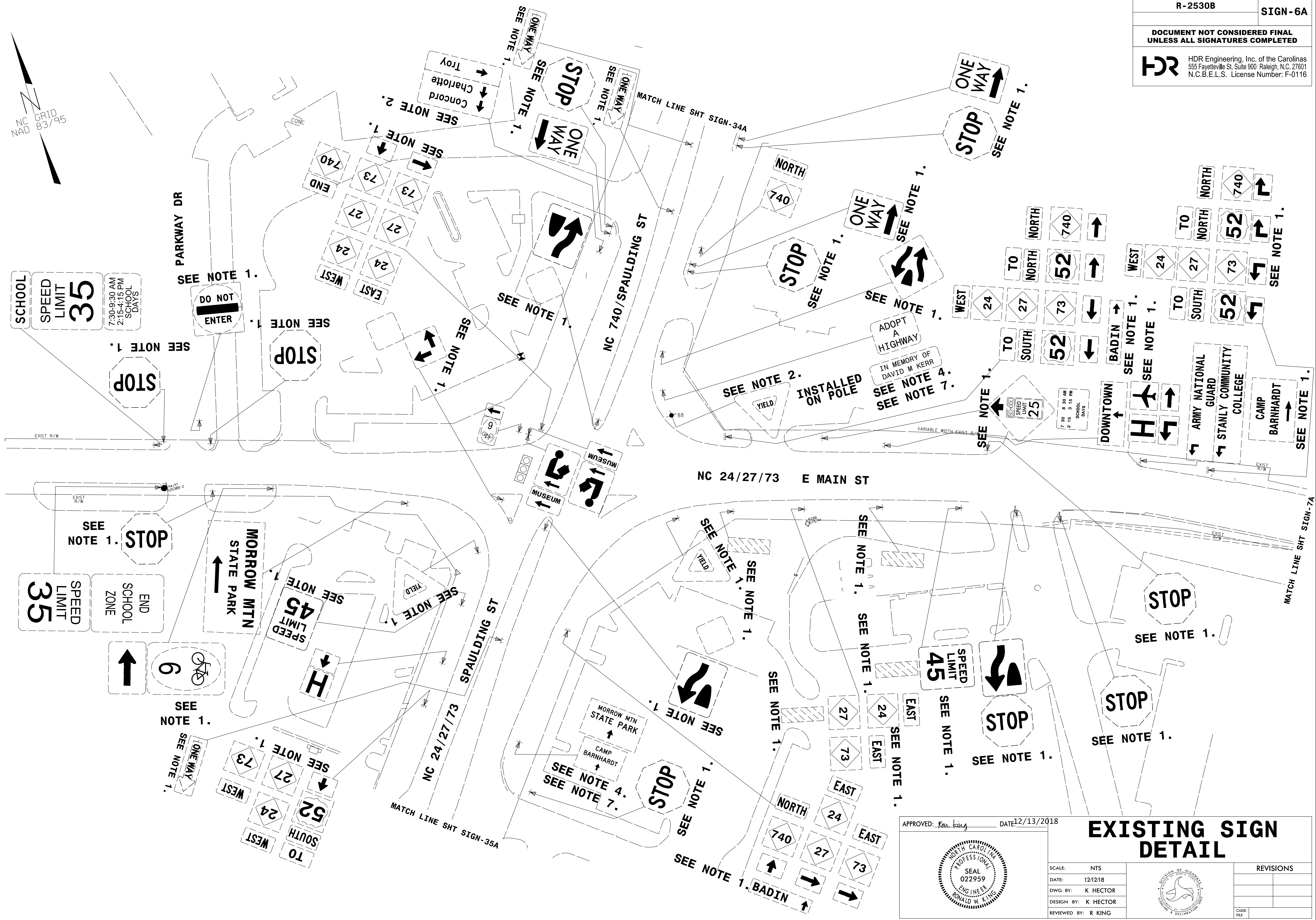

PLOT DRIVER: pdfplotter
 USER: KHECTOR
 FILE: NCDOT\2015.NCDOT_TMSD.Limited.Ser.Vices.Contract.M.7000016704\NCDOT-R2530B.B4974.103.c.\6.0.CAD.BTM.6.2.Work.In.Progress\Traffic\Signing\CADD\Signing_Layout_Plans\U2530B_Signing_Sht_EX2.dgn
 PENTABLE: NCDOT_Signing.tbl
 TIME: 13:49:39
 SCALE: 1:48.3408
 DATE: 12/12/18
 REVISIONS

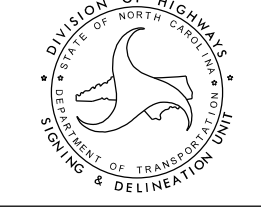

APPROVED: <i>Ron King</i> 	DATE: 12/13/2018 	EXISTING SIGN DETAIL	<table border="1"> <tr><th>REVISIONS</th></tr> <tr><td> </td></tr> <tr><td> </td></tr> <tr><td> </td></tr> <tr><td> </td></tr> </table>	REVISIONS											
REVISIONS															
SCALE: NTS DATE: 12/12/18 DWG. BY: K HECTOR DESIGN BY: K HECTOR REVIEWED BY: R KING	<table border="1"> <tr><td> </td></tr> <tr><td> </td></tr> <tr><td> </td></tr> <tr><td> </td></tr> </table>					<table border="1"> <tr><td> </td></tr> <tr><td> </td></tr> <tr><td> </td></tr> <tr><td> </td></tr> </table>					<table border="1"> <tr><td> </td></tr> <tr><td> </td></tr> <tr><td> </td></tr> <tr><td> </td></tr> </table>				

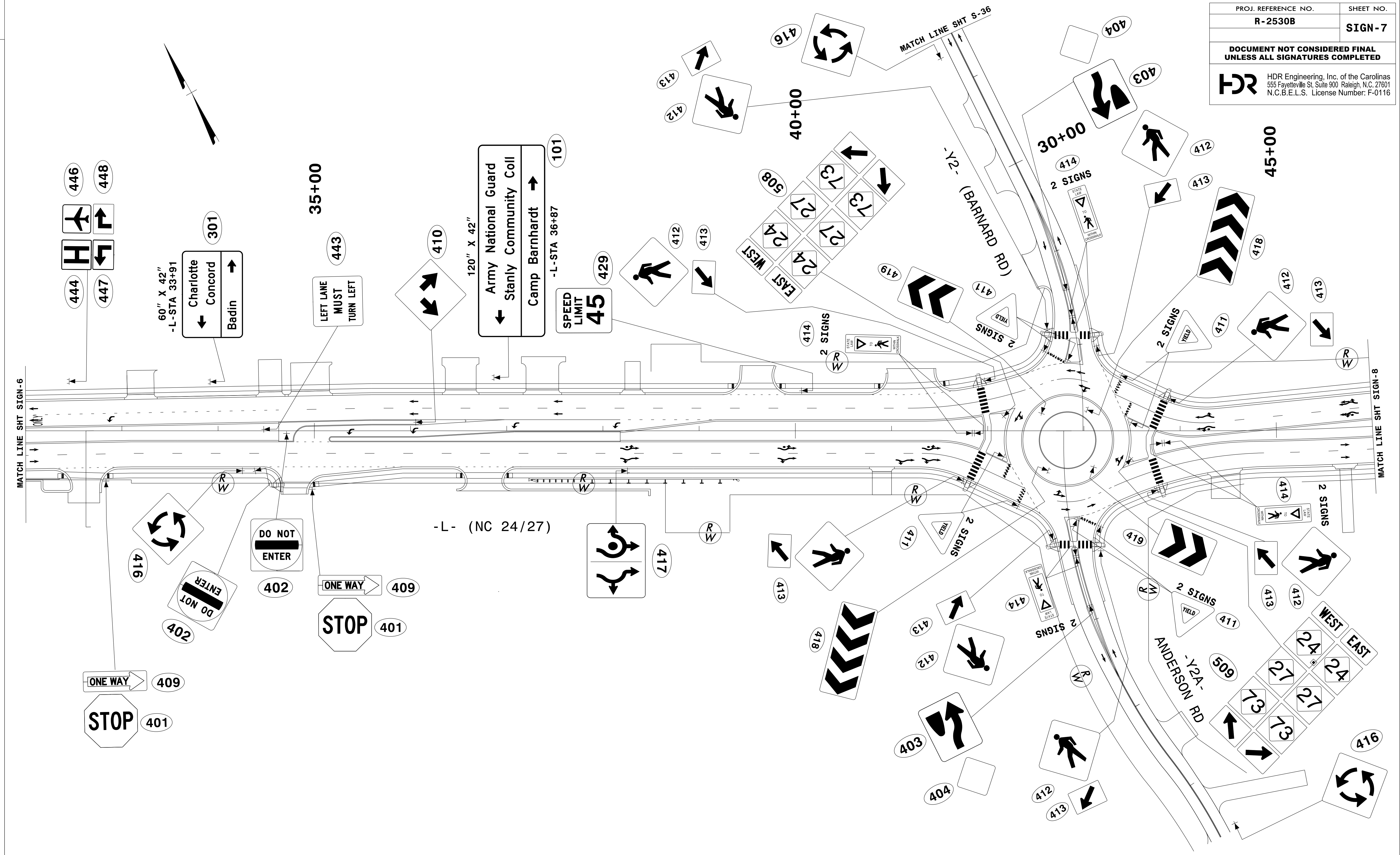
PROJ. REFERENCE NO. R-2530B	SHEET NO. SIGN-7
DOCUMENT NOT CONSIDERED FINAL UNLESS ALL SIGNATURES COMPLETED	
 HDR Engineering, Inc. of the Carolinas 555 Fayetteville St, Suite 900 Raleigh, N.C. 27601 N.C.B.E.L.S. License Number: F-0116	



PLOT DRIVER: pdfplotter
 USER: KHECTOR
 FILE: NCDOT\2015.NCDOT_TMSD.Limited.Services.Contract.M.7000016704.NCDOT-R2530B.B4974.103.c.6.0.CAD.BTM.6.2.Work.In.Progress\Traffic\Signing\CADD\Signing_Layout_Plans\U2530B_Signing_Sht_3.dgn
 PENTABLE: NCDOT_Signing.tbl
 TIME: 16:29:35
 DATE: 12/11/18
 SCALE: 1:48.3408

REVISIONS

APPROVED: <i>Ron King</i>	DATE: 12/13/2018			SIGN DETAIL							
SCALE: NTS	DATE: 12/11/18			<table border="1"> <thead> <tr> <th colspan="2">REVISIONS</th> </tr> </thead> <tbody> <tr> <td> </td> <td> </td> </tr> <tr> <td> </td> <td> </td> </tr> <tr> <td> </td> <td> </td> </tr> </tbody> </table>		REVISIONS					
REVISIONS											
DESIGN BY: K HECTOR	REVIEWED BY: R KING	<table border="1"> <tr> <td>CADD FILE</td> <td> </td> </tr> </table>		CADD FILE							
CADD FILE											

PLOT DRIVER: pdfplotcf9
USER: KHECTOR
FILE: NCDOT\2015.NCDOT_TMSD.Limited_Services.Contract.M.7000016704\NCDOT-R2530B.B4974.T03.c.16.0.CAD.BTM.6.2.Work.In.Progress\Traffic\Signing\CADD\Signing_Layout_Plans\U2530B_Signing_Sht_EX3.dgn
PENTABLE: NCDOT_Signing.tbl
SCALE: 1:48.3408
DATE: 12/06/18
TIME: 13:49:57
CONTRACT: M.7000016704

REVISIONS

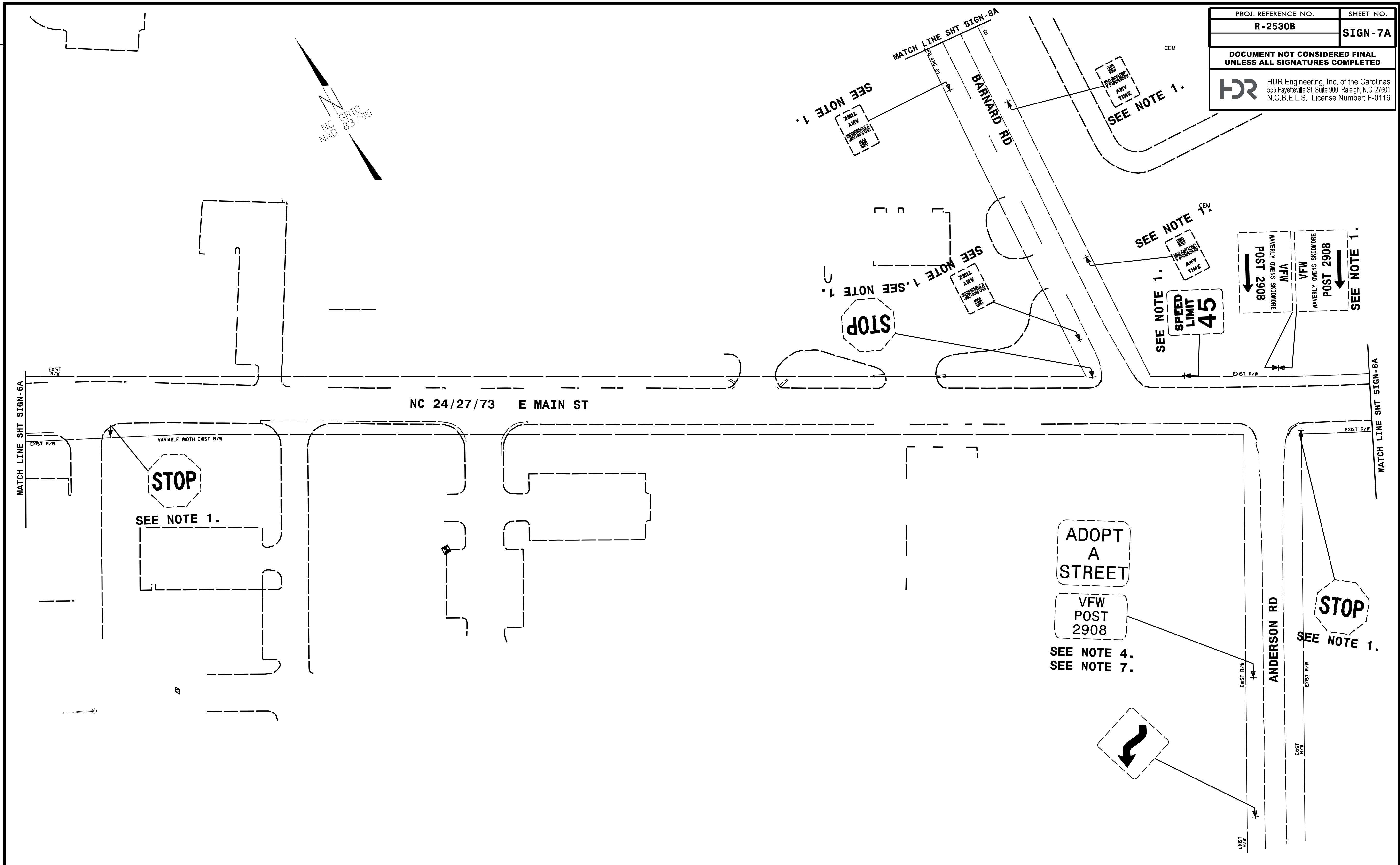

PROJ. REFERENCE NO. R-2530B	SHEET NO. SIGN-7A
DOCUMENT NOT CONSIDERED FINAL UNLESS ALL SIGNATURES COMPLETED	
 HDR Engineering, Inc. of the Carolinas 555 Fayetteville St, Suite 900 Raleigh, N.C. 27601 N.C.B.E.L.S. License Number: F-0116	

APPROVED: <i>Ronald W. King</i> DATE: 12/13/2018	<h2>EXISTING SIGN DETAIL</h2>	SCALE: NTS		REVISIONS
DATE: 12/06/18		DATE: 12/06/18		
DESIGN BY: K HECTOR	DESIGN BY: K HECTOR			
REVIEWED BY: R KING	REVIEWED BY: R KING			

PROJ. REFERENCE NO.	SHEET NO.
R-2530B	SIGN-8
DOCUMENT NOT CONSIDERED FINAL UNLESS ALL SIGNATURES COMPLETED	
 HDR Engineering, Inc. of the Carolinas 555 Fayetteville St, Suite 900 Raleigh, N.C. 27601 N.C.B.E.L.S. License Number: F-0116	

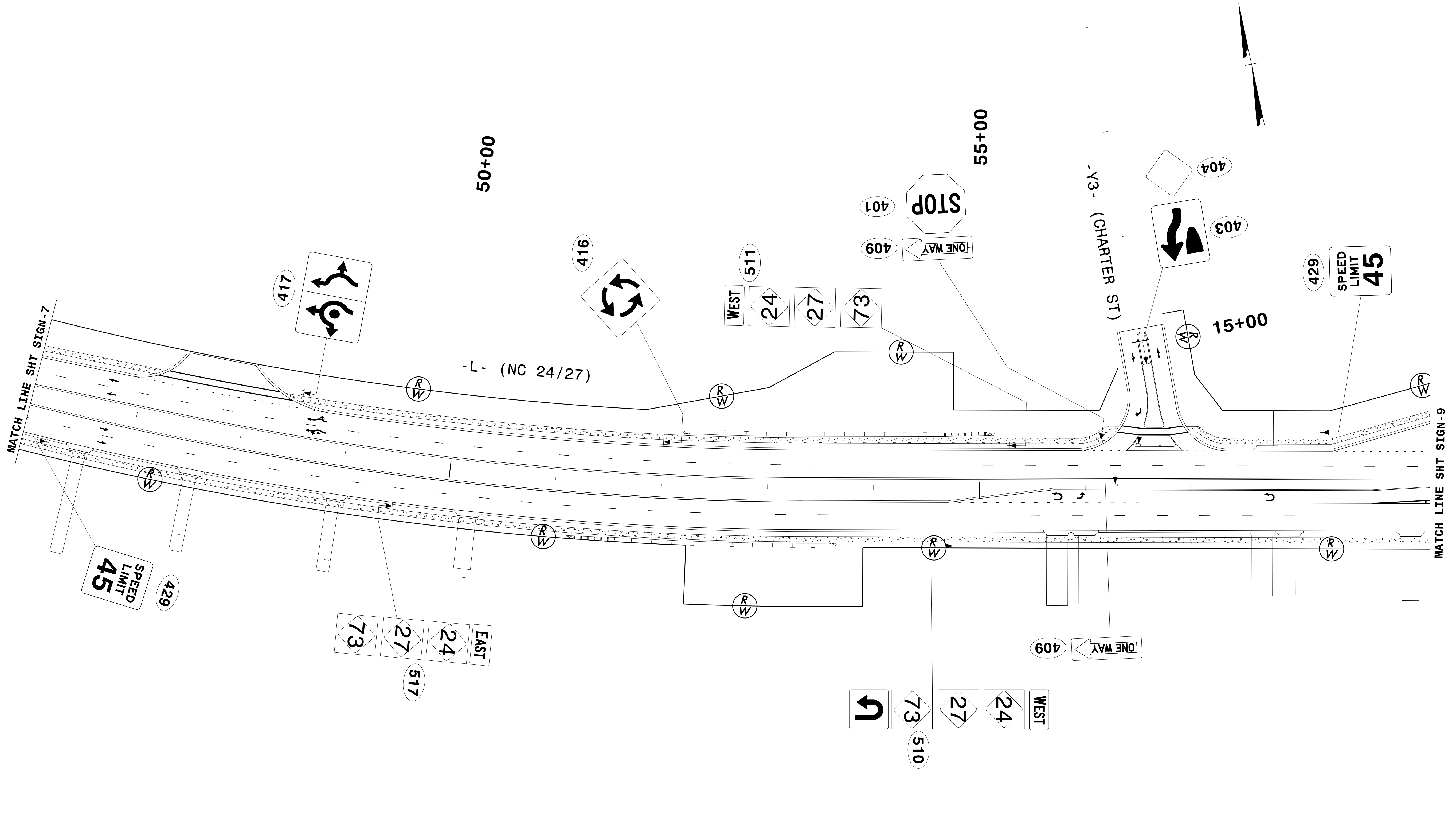



REVISIONS

PLOT DRIVER: \$PLTDVRS\$
 USER: \$USER\$
 FILE: \$PWVAVAUULTPATHDESIG\$

PENTABLE: \$PENTBL\$
 TIME: \$TIME\$
 SCALE: \$SCALE\$

DATE: \$DATE\$

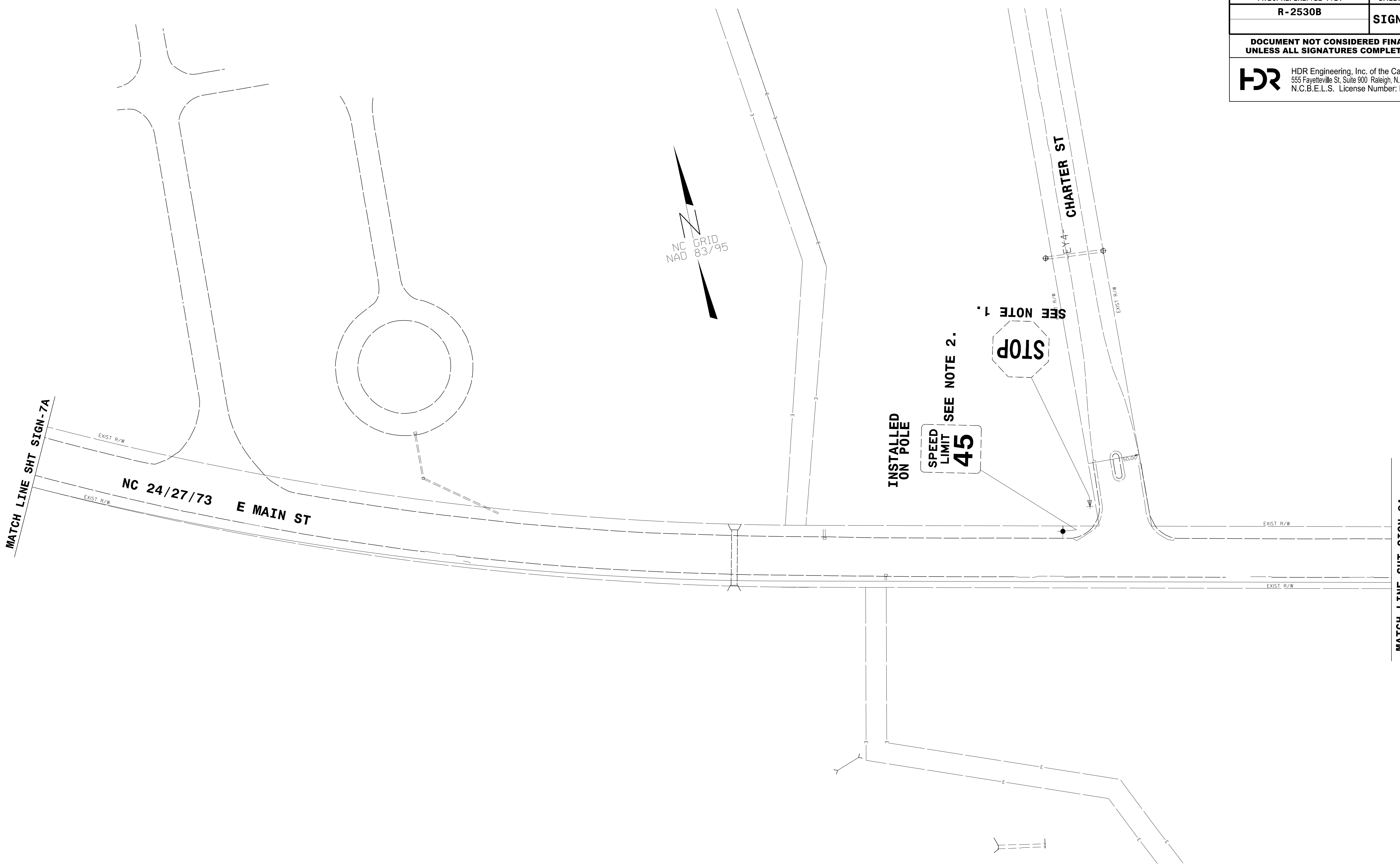

APPROVED: <i>Ron King</i>	DATE: 12/13/2018			SIGN DETAIL			
SCALE: NTS DATE: \$DATES\$ DWG. BY: K HECTOR DESIGN BY: K HECTOR REVIEWED BY: R KING	REVISIONS <table border="1"> <tr><td> </td><td> </td></tr> <tr><td> </td><td> </td></tr> <tr><td> </td><td> </td></tr> </table>						

PROJ. REFERENCE NO.	SHEET NO.
R-2530B	SIGN-8A
DOCUMENT NOT CONSIDERED FINAL UNLESS ALL SIGNATURES COMPLETED	
 HDR Engineering, Inc. of the Carolinas 555 Fayetteville St, Suite 900 Raleigh, N.C. 27601 N.C.B.E.L.S. License Number: F-0116	



REVISIONS

PLOT DRIVER: \$PLTDVRS\$ PENTABLE: \$PENTBL\$
 USER: \$USER\$ DATE: \$DATE\$ TIME: \$TIME\$ SCALE: \$SCALE\$
 FILE: \$PWWARVAULTPATHDESC\$

APPROVED: <i>Ron King</i> DATE: 12/13/2018		SIGN DETAIL								
SCALE: NTS DATE: \$DATES\$ DWG. BY: K HECTOR DESIGN BY: K HECTOR REVIEWED BY: R KING			REVISIONS <table border="1"> <tr><td> </td><td> </td></tr> <tr><td> </td><td> </td></tr> <tr><td> </td><td> </td></tr> <tr><td> </td><td> </td></tr> </table>							

PROJ. REFERENCE NO.	SHEET NO.
R-2530B	SIGN-9
DOCUMENT NOT CONSIDERED FINAL UNLESS ALL SIGNATURES COMPLETED	
 HDR Engineering, Inc. of the Carolinas 555 Fayetteville St, Suite 900 Raleigh, N.C. 27601 N.C.B.E.L.S. License Number: F-0116	

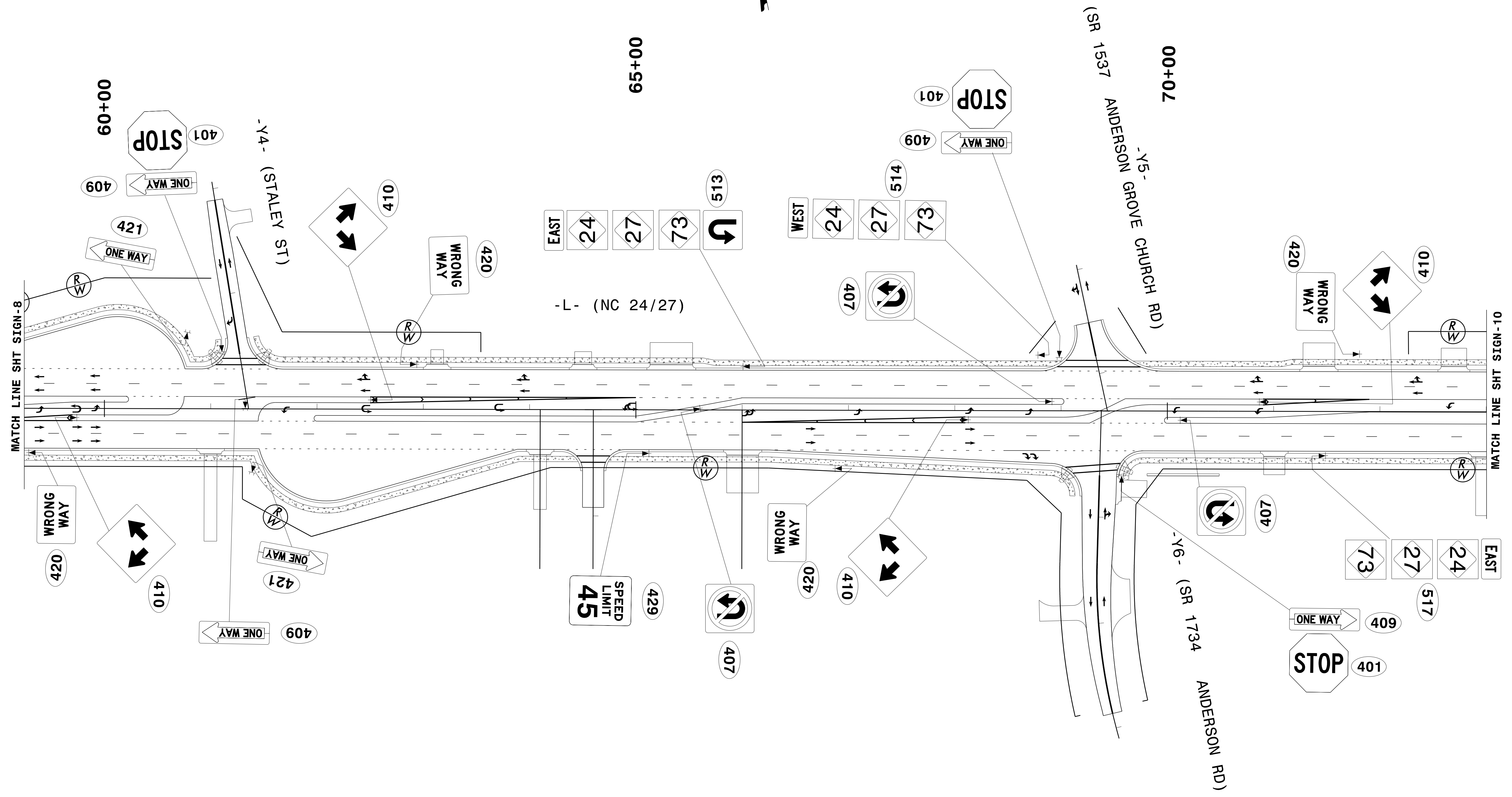

REVISIONS

PLOT DRIVER: \$PLTDRV\$
 USER: \$USER\$
 FILE: \$PWVARVAULTPATHDESIG\$
 DATE: \$DATE\$
 TIME: \$TIME\$
 SCALE: \$SCALESHORT\$
 PENTABLE: \$PENTBL\$

APPROVED: *Ron King* DATE: 12/13/2018

PROFESSOR OF ENGINEERING
 SEAL
 022959
 ENGINEER
 RONALD W. KING



SIGN DETAIL

SCALE: NTS		REVISIONS
DATE: \$DATES\$		
DWG. BY: K HECTOR		
DESIGN BY: K HECTOR		
REVIEWED BY: R KING		

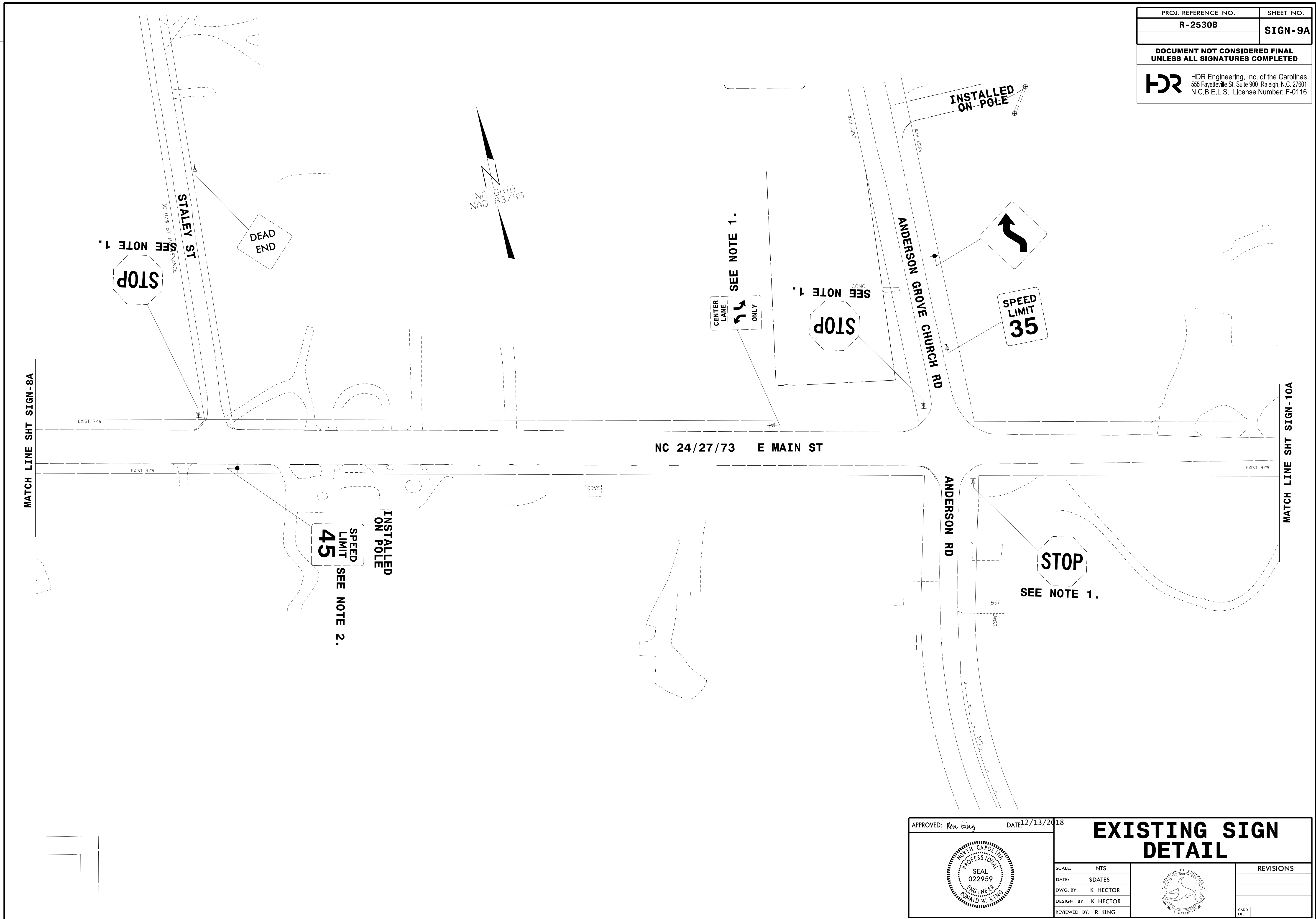
PROJ. REFERENCE NO. R-2530B	SHEET NO. SIGN-9A
DOCUMENT NOT CONSIDERED FINAL UNLESS ALL SIGNATURES COMPLETED	
 HDR Engineering, Inc. of the Carolinas 555 Fayetteville St, Suite 900 Raleigh, N.C. 27601 N.C.B.E.L.S. License Number: F-0116	



PLOT DRIVER: \$PLTDVRS\$
 USER: \$USER\$
 FILE: \$PWVARVAULTPATHDESC\$
 PENTABLE: \$PENTBL\$
 TIME: \$TIME\$
 DATE: \$DATE\$
 SCALE: \$SCALES\$
 REVISIONS

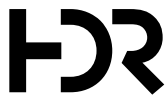

APPROVED: <i>Ron King</i> DATE: 12/13/2018 	<h2>EXISTING SIGN DETAIL</h2>	<table border="1"> <tr><th colspan="2">REVISIONS</th></tr> <tr><td> </td><td> </td></tr> <tr><td> </td><td> </td></tr> <tr><td> </td><td> </td></tr> <tr><td> </td><td> </td></tr> </table>	REVISIONS									
REVISIONS												
SCALE: NTS DATE: \$DATES\$ DWG. BY: K HECTOR DESIGN BY: K HECTOR REVIEWED BY: R KING		<table border="1"> <tr><td> </td><td> </td></tr> <tr><td> </td><td> </td></tr> <tr><td> </td><td> </td></tr> <tr><td> </td><td> </td></tr> </table>										

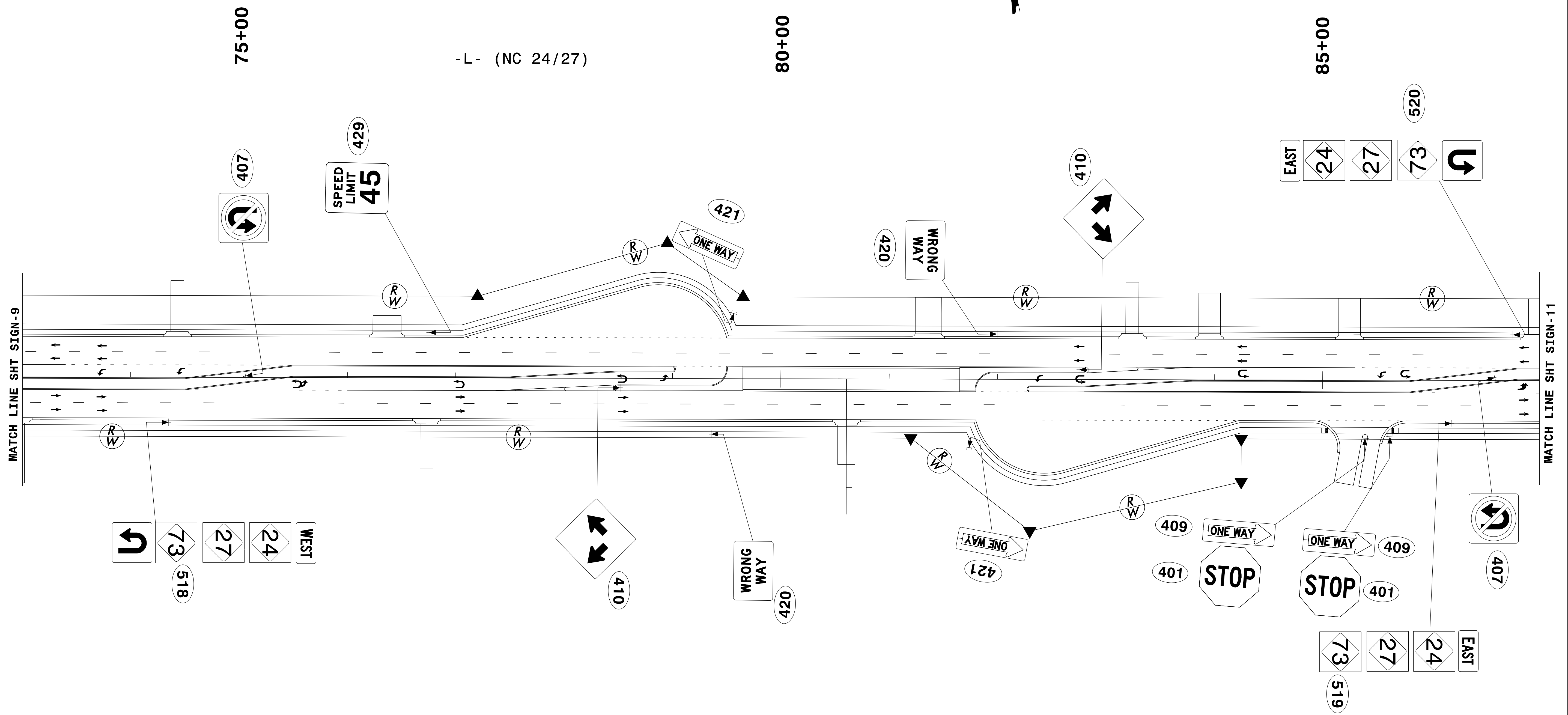
PROJ. REFERENCE NO.	SHEET NO.
R-2530B	SIGN - 10
DOCUMENT NOT CONSIDERED FINAL UNLESS ALL SIGNATURES COMPLETED	
 HDR Engineering, Inc. of the Carolinas 555 Fayetteville St, Suite 900 Raleigh, N.C. 27601 N.C.B.E.L.S. License Number: F-0116	



PLOT DRIVER: pdfplotter
 USER: KHECTOR
 FILE: NCDOT\2015.NCDOT_TMSD.Limited.Services.Contract.M.7000016704.NCDOT-R2530B.B4974.T03.c.6.0.CAD.BTM.6.2.Work.In.Progress\Traffic\Signing\CADD\Signing_Layout_Plans\U2530B_Signing_Sht.6.dgn
 PENTABLE: NCDOT_Signing.tbl
 DATE: 12/12/18
 TIME: 10:07:36
 SCALE: 1:48.3408

REVISIONS

APPROVED: <i>Ron King</i>	DATE: 12/13/2018	<h2>SIGN DETAIL</h2>			SCALE: NTS	<table border="1"> <thead> <tr> <th colspan="2">REVISIONS</th> </tr> </thead> <tbody> <tr><td> </td><td> </td></tr> <tr><td> </td><td> </td></tr> <tr><td> </td><td> </td></tr> </tbody> </table>	REVISIONS							
REVISIONS														
DATE: 12/12/18	DWG. BY: K HECTOR													
DESIGN BY: K HECTOR	REVIEWED BY: R KING													
CADD FILE														

PROJ. REFERENCE NO.	SHEET NO.
R-2530B	SIGN-10A
DOCUMENT NOT CONSIDERED FINAL UNLESS ALL SIGNATURES COMPLETED	
 HDR Engineering, Inc. of the Carolinas 555 Fayetteville St, Suite 900 Raleigh, N.C. 27601 N.C.B.E.L.S. License Number: F-0116	



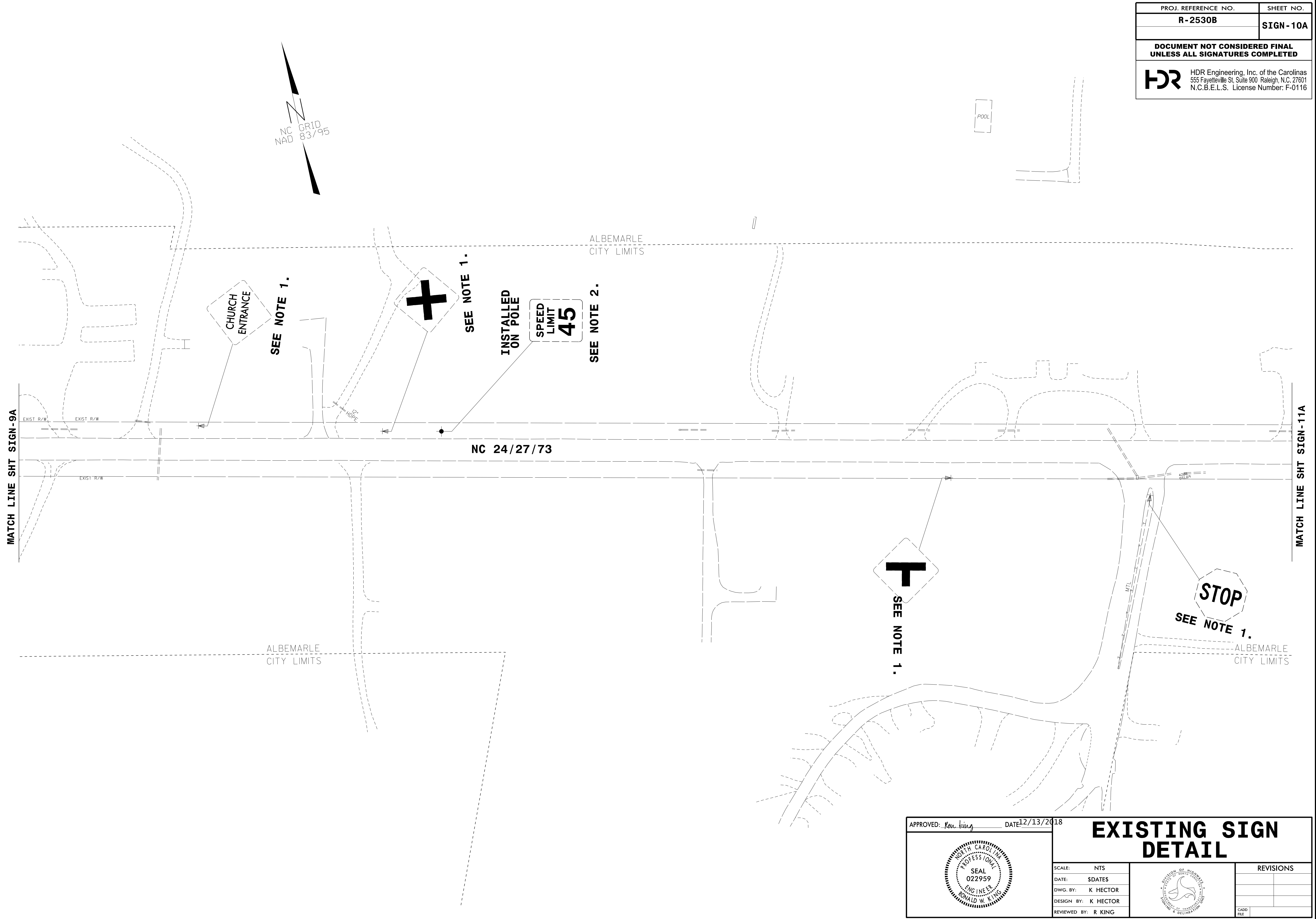

POOL



REVISIONS

PLOT DRIVER: \$PLTDVRS\$ PENTABLE: \$PENTBL\$
 USER: \$USER\$ DATE: \$DATE\$ TIME: \$TIME\$ SCALE: \$SCALE\$
 FILE: \$P\W\AR\VAULT\PATHDESIG\$

APPROVED: <i>Ron King</i> DATE: 12/13/2018	<h2 style="text-align: center;">EXISTING SIGN DETAIL</h2>		REVISIONS						
				<table border="1"> <tr><td> </td><td> </td></tr> <tr><td> </td><td> </td></tr> <tr><td> </td><td> </td></tr> </table>					
SCALE: NTS	DATE: \$DATES\$	DESIGN BY: K HECTOR	REVIEWED BY: R KING	CADD FILE					

PROJ. REFERENCE NO.	SHEET NO.
R-2530B	SIGN-11
DOCUMENT NOT CONSIDERED FINAL UNLESS ALL SIGNATURES COMPLETED	
 HDR Engineering, Inc. of the Carolinas 555 Fayetteville St, Suite 900 Raleigh, N.C. 27601 N.C.B.E.L.S. License Number: F-0116	

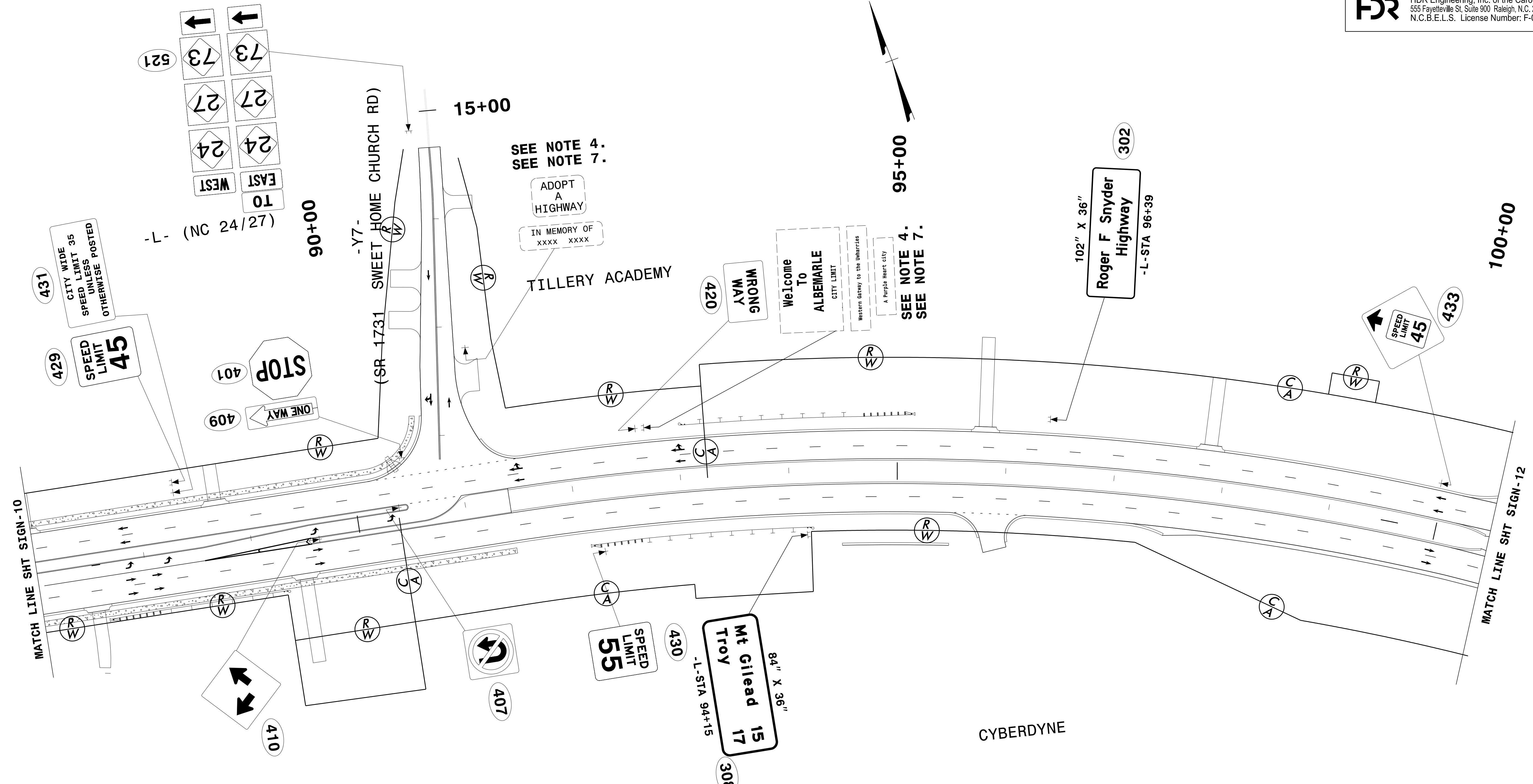

REVISIONS

PLOT DRIVER: \$PLTDRV\$
 USER: \$USER\$
 FILE: \$PWVARVAULTPATHDESIG\$
 DATE: \$DATE\$
 TIME: \$TIME\$
 SCALE: \$SCALESHORT\$

APPROVED: *Ron King* DATE: 12/13/2018

NO. 107 CAROLINA
 PROFESSIONAL
 SEAL
 022959
 ENGINEER
 RONALD W. KING

SIGN DETAIL

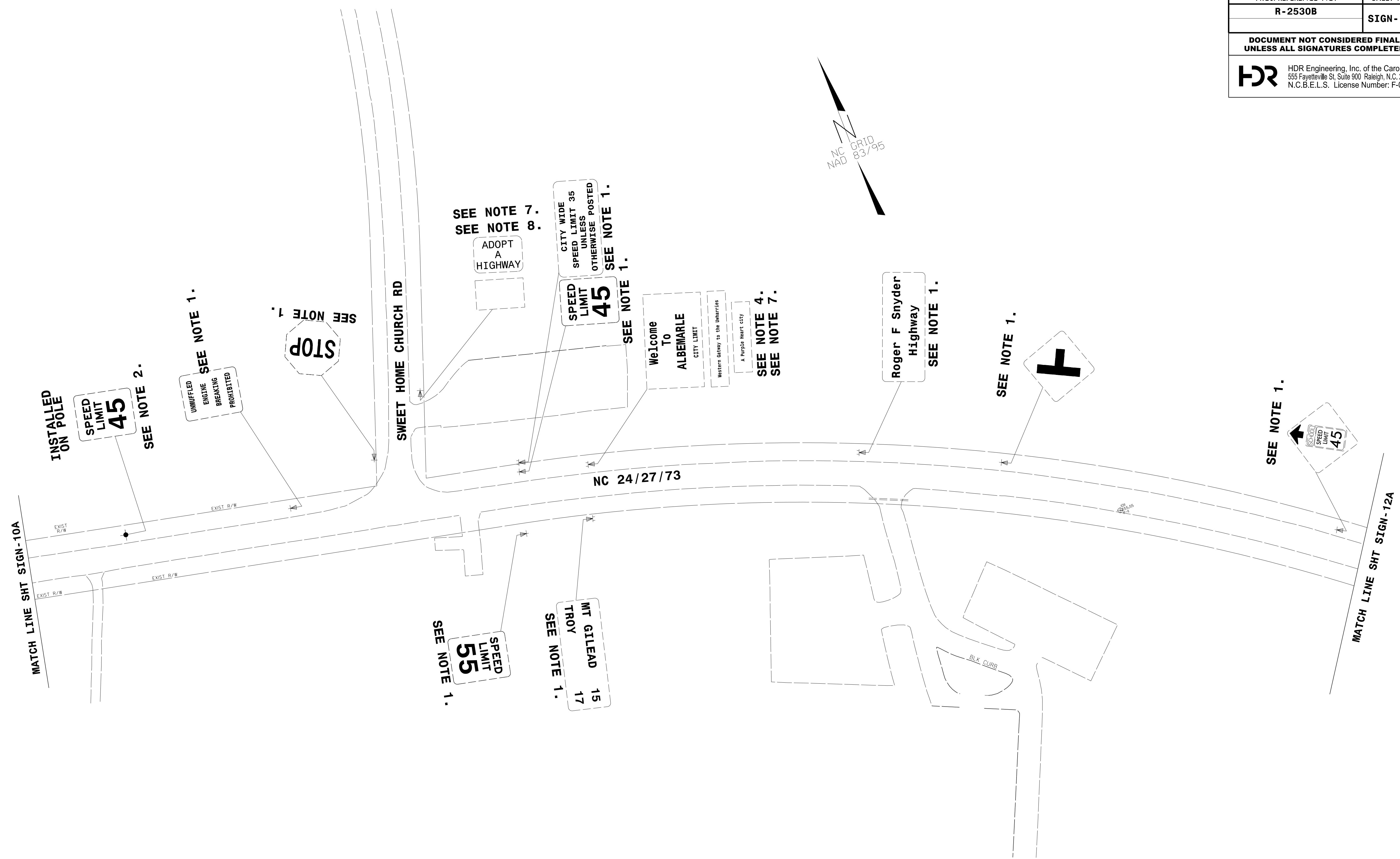

SCALE: NTS		REVISIONS
DATE: \$DATES		
DESIGN BY: K HECTOR		
REVIEWED BY: R KING		

PROJ. REFERENCE NO.	SHEET NO.
R-2530B	SIGN-11A
DOCUMENT NOT CONSIDERED FINAL UNLESS ALL SIGNATURES COMPLETED	
 HDR Engineering, Inc. of the Carolinas 555 Fayetteville St, Suite 900 Raleigh, N.C. 27601 N.C.B.E.L.S. License Number: F-0116	



REVISIONS



PLOT DRIVER: \$PLTDVRS\$
 USER: \$USER\$
 FILE: \$PWVARVAULTPATHDESIG\$
 DATE: \$DATE\$
 SCALE: \$SCALESHORT\$
 PENTABLE: \$PENTBL\$
 TIME: \$TIME\$

APPROVED: <i>Ron King</i>	DATE: 12/13/2018	<h2>EXISTING SIGN DETAIL</h2>		SCALE: NTS		REVISIONS
DATE: \$DATES\$	DWG. BY: K HECTOR					
DESIGN BY: K HECTOR	REVIEWED BY: R KING					

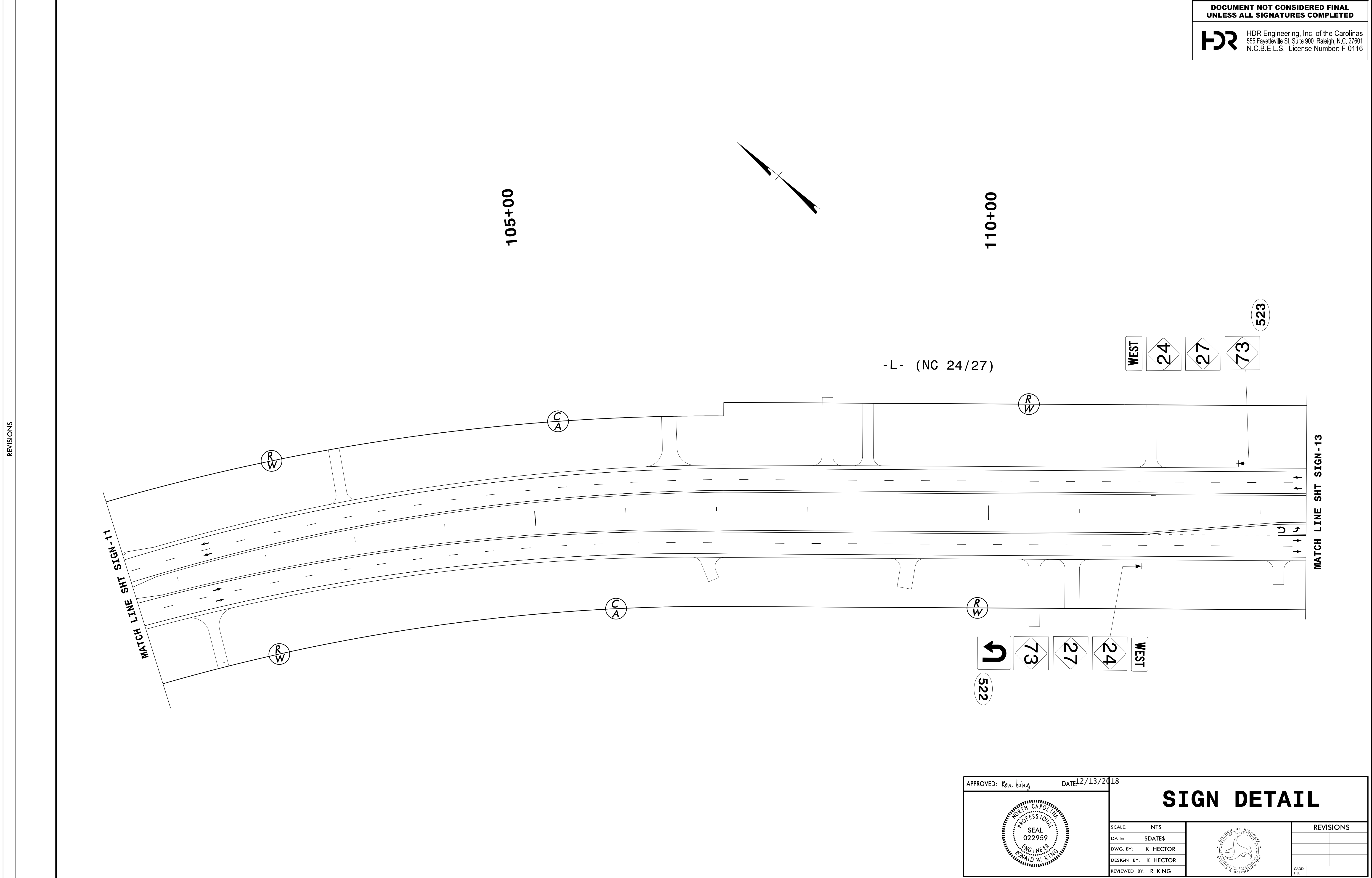
PROJ. REFERENCE NO.	SHEET NO.
R-2530B	SIGN - 12
DOCUMENT NOT CONSIDERED FINAL UNLESS ALL SIGNATURES COMPLETED	
 HDR Engineering, Inc. of the Carolinas 555 Fayetteville St, Suite 900 Raleigh, N.C. 27601 N.C.B.E.L.S. License Number: F-0116	



PLOT DRIVER: \$PLTDRV\$
 USER: \$USER\$
 FILE: \$PWVAVAU\TPATH\DESIG\$
 PENTABLE: \$PENTBL\$
 TIME: \$TIME\$
 SCALE: \$SCALE\$
 DATE: \$DATE\$
 REVISIONS

APPROVED: <i>Ron King</i>	DATE: 12/13/2018			SIGN DETAIL					
SCALE: NTS DATE: \$DATES\$ DWG. BY: K HECTOR DESIGN BY: K HECTOR REVIEWED BY: R KING	<table border="1"> <tr> <th colspan="2">REVISIONS</th> </tr> <tr> <td> </td> <td> </td> </tr> <tr> <td> </td> <td> </td> </tr> <tr> <td> </td> <td> </td> </tr> </table>			REVISIONS					
REVISIONS									

PROJ. REFERENCE NO.	SHEET NO.
R-2530B	SIGN-12A
DOCUMENT NOT CONSIDERED FINAL UNLESS ALL SIGNATURES COMPLETED	
 HDR Engineering, Inc. of the Carolinas 555 Fayetteville St, Suite 900 Raleigh, N.C. 27601 N.C.B.E.L.S. License Number: F-0116	

NC GRID
MAD 83/7/95





MATCH LINE SHT 111-NGIS SEE NOTE 1

MATCH LINE SHT SIGN-13A

NC 24/27/73

SEE NOTE 1.
45
M.P.H.

TRUCKS
ENTERING
HIGHWAY

APPROVED: <i>Ron King</i>	DATE: 12/13/2018	<h2 style="text-align: center;">EXISTING SIGN DETAIL</h2>			REVISIONS					
SCALE: NTS DATE: \$DATES DWG. BY: K HECTOR DESIGN BY: K HECTOR REVIEWED BY: R KING					<table border="1"> <tr><td> </td><td> </td></tr> <tr><td> </td><td> </td></tr> <tr><td> </td><td> </td></tr> <tr><td> </td><td> </td></tr> </table>					

PLOT DRIVER: \$PLTDVRS\$ PENTABLE: \$PENTBL\$
 USER: \$USER\$ TIME: \$TIME\$ SCALE: \$SCALESHT\$
 DATE: \$DATE\$ FILE: \$PWVARVAULTPATHDESC\$

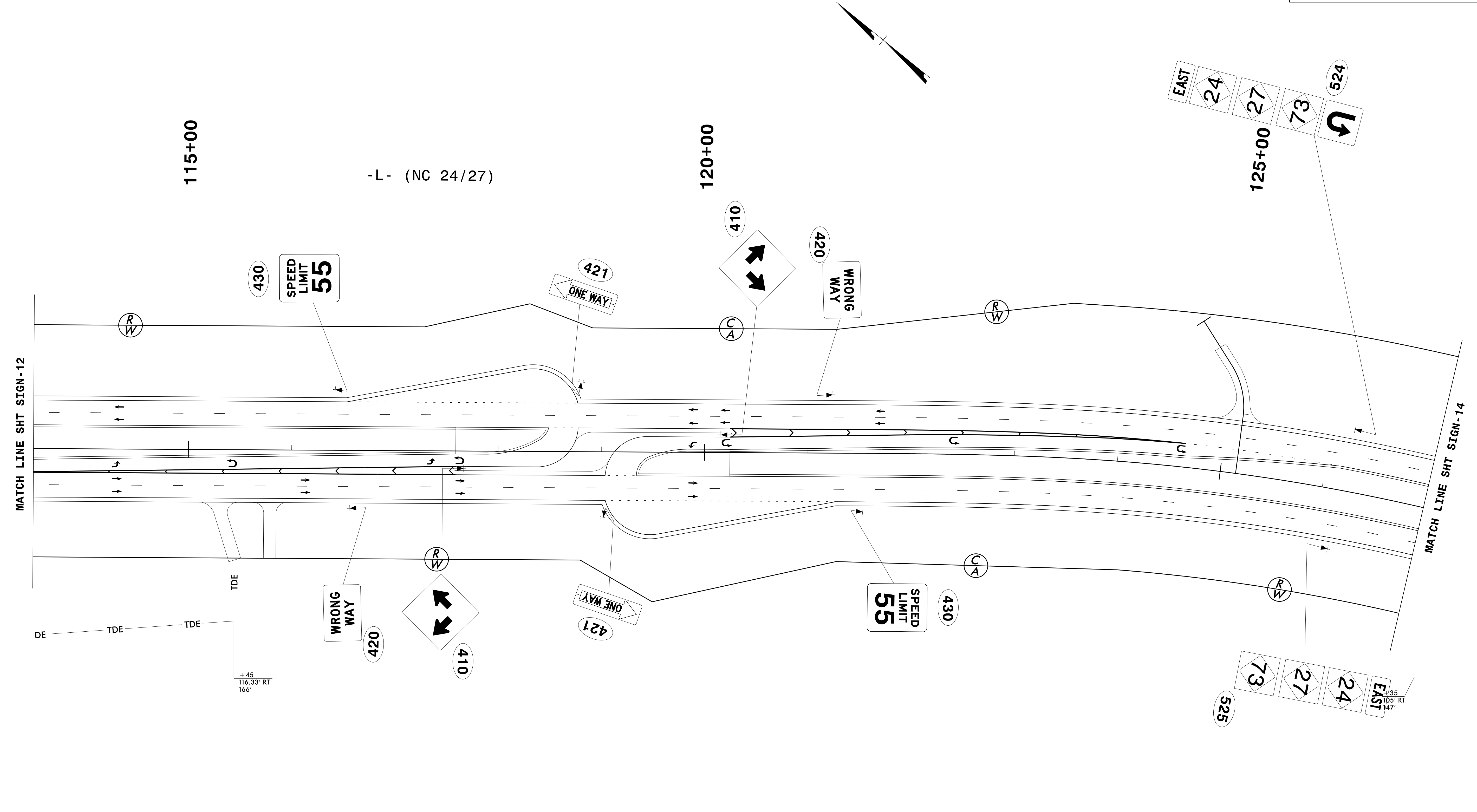

REVISIONS

PROJ. REFERENCE NO.	SHEET NO.
R-2530B	SIGN- 13
DOCUMENT NOT CONSIDERED FINAL UNLESS ALL SIGNATURES COMPLETED	
 HDR Engineering, Inc. of the Carolinas 555 Fayetteville St, Suite 900 Raleigh, N.C. 27601 N.C.B.E.L.S. License Number: F-0116	



REVISIONS

PLOT DRIVER: \$PLTDVRS\$
 USER: \$USER\$
 FILE: \$PWVARVAULTPATHDESIG\$
 DATE: \$DATE\$
 SCALE: \$SCALESHORT\$
 TIME: \$TIME\$
 PENTABLE: \$PENTBL\$

APPROVED: <i>Ron King</i>	DATE: 12/13/2018	<h2>SIGN DETAIL</h2>								
										
SCALE: NTS	DATE: \$DATES\$	<table border="1"> <thead> <tr> <th colspan="2">REVISIONS</th> </tr> </thead> <tbody> <tr><td> </td><td> </td></tr> <tr><td> </td><td> </td></tr> <tr><td> </td><td> </td></tr> </tbody> </table>	REVISIONS							
REVISIONS										
DWG. BY: K HECTOR	DESIGN BY: K HECTOR									
REVIEWED BY: R KING										
										

PROJ. REFERENCE NO.	SHEET NO.
R-2530B	SIGN-13A
DOCUMENT NOT CONSIDERED FINAL UNLESS ALL SIGNATURES COMPLETED	
 HDR Engineering, Inc. of the Carolinas 555 Fayetteville St, Suite 900 Raleigh, N.C. 27601 N.C.B.E.L.S. License Number: F-0116	

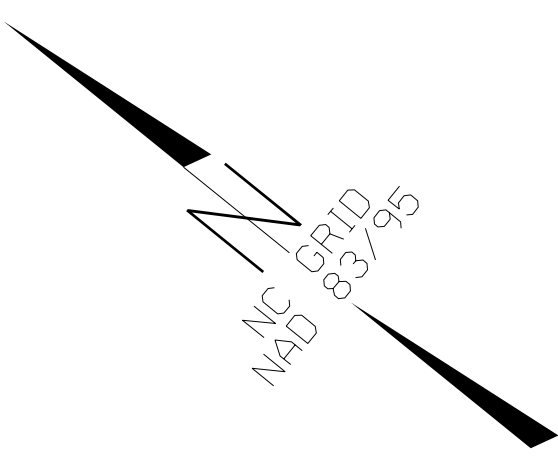

MATCH LINE SHT SIGN-12A

MATCH LINE SHT SIGN-14A

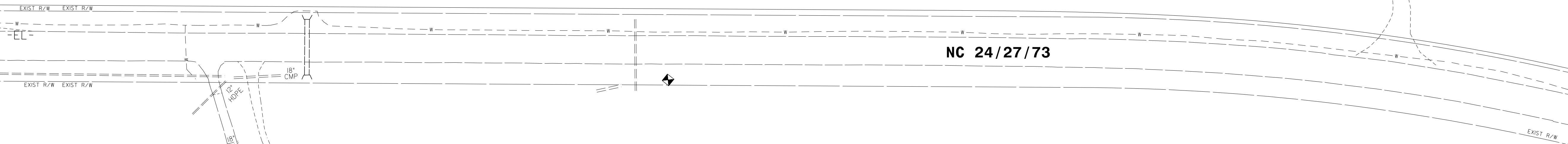

TRUCKS
ENTERING
HIGHWAY



45
M.P.H.

SEE NOTE 1.

NC 24/27/73

REVISIONS

PLOT DRIVER: \$PLTDRV\$ PENTABLE: \$PENTBL\$ SCALE: \$SCALESHT\$
 USER: \$USER\$ DATE: \$DATE\$ TIME: \$TIME\$
 FILE: \$PWWARVAULTPATHDESIG\$

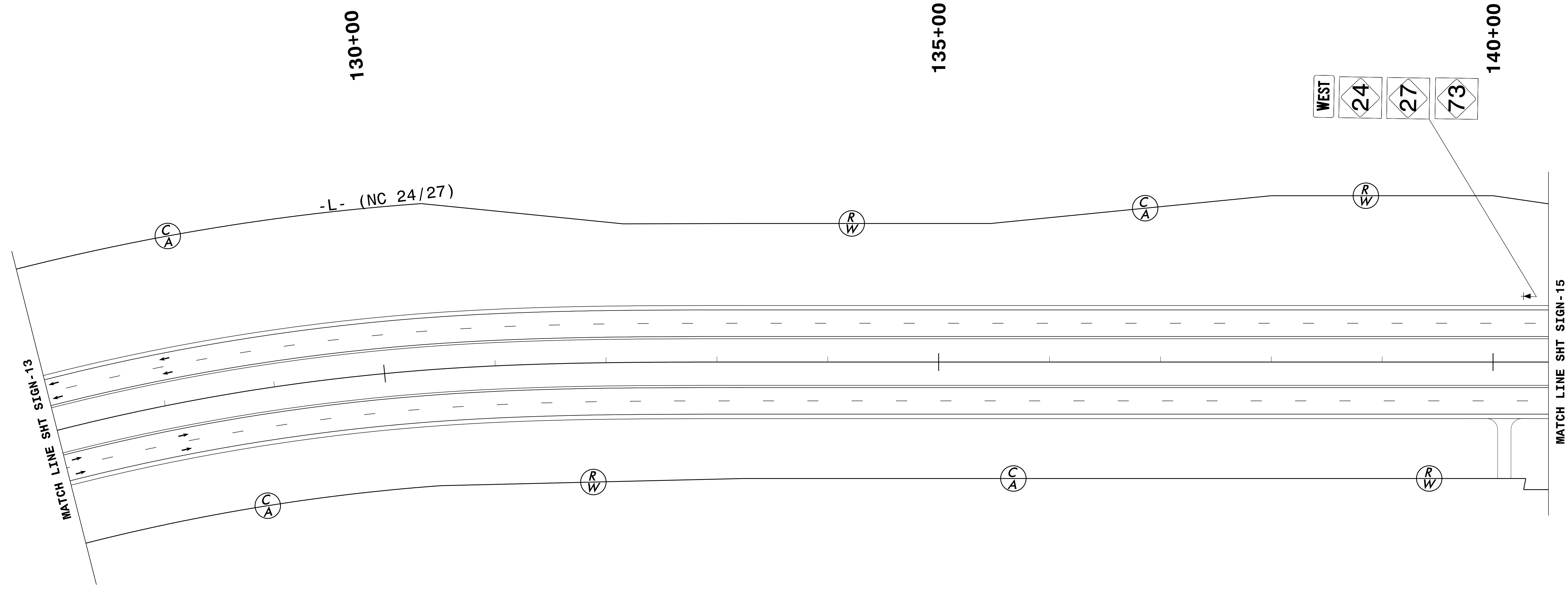

APPROVED: <i>Ron King</i> DATE: 12/13/2018			REVISIONS								
EXISTING SIGN DETAIL			<table border="1"> <tr><td>SCALE:</td><td>NTS</td></tr> <tr><td>DATE:</td><td>\$DATES</td></tr> <tr><td>DWG. BY:</td><td>K HECTOR</td></tr> <tr><td>DESIGN BY:</td><td>K HECTOR</td></tr> <tr><td>REVIEWED BY:</td><td>R KING</td></tr> </table>	SCALE:	NTS	DATE:	\$DATES	DWG. BY:	K HECTOR	DESIGN BY:	K HECTOR
SCALE:	NTS										
DATE:	\$DATES										
DWG. BY:	K HECTOR										
DESIGN BY:	K HECTOR										
REVIEWED BY:	R KING										

PROJ. REFERENCE NO.	SHEET NO.
R-2530B	SIGN- 14
DOCUMENT NOT CONSIDERED FINAL UNLESS ALL SIGNATURES COMPLETED	
 HDR Engineering, Inc. of the Carolinas 555 Fayetteville St, Suite 900 Raleigh, N.C. 27601 N.C.B.E.L.S. License Number: F-0116	



REVISIONS

PLOT DRIVER: \$PLTDVRS\$ PENTABLE: \$PENTBL\$
 USER: \$USER\$ DATE: \$DATE\$ TIME: \$TIME\$ SCALE: \$SCALE\$
 FILE: \$PWVARVAULTPATHDESC\$

APPROVED: <i>Ron King</i> DATE: 12/13/2018		SIGN DETAIL						
SCALE: NTS DATE: \$DATES\$ DWG. BY: K HECTOR DESIGN BY: K HECTOR REVIEWED BY: R KING			REVISIONS <table border="1"> <tr><td> </td><td> </td></tr> <tr><td> </td><td> </td></tr> <tr><td> </td><td> </td></tr> </table>					

PROJ. REFERENCE NO.	SHEET NO.
R-2530B	SIGN-14A
DOCUMENT NOT CONSIDERED FINAL UNLESS ALL SIGNATURES COMPLETED	
 HDR Engineering, Inc. of the Carolinas 555 Fayetteville St, Suite 900 Raleigh, N.C. 27601 N.C.B.E.L.S. License Number: F-0116	

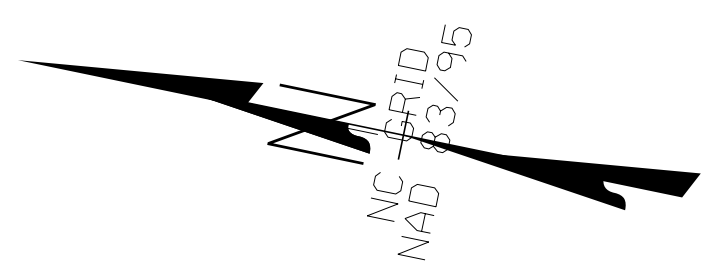

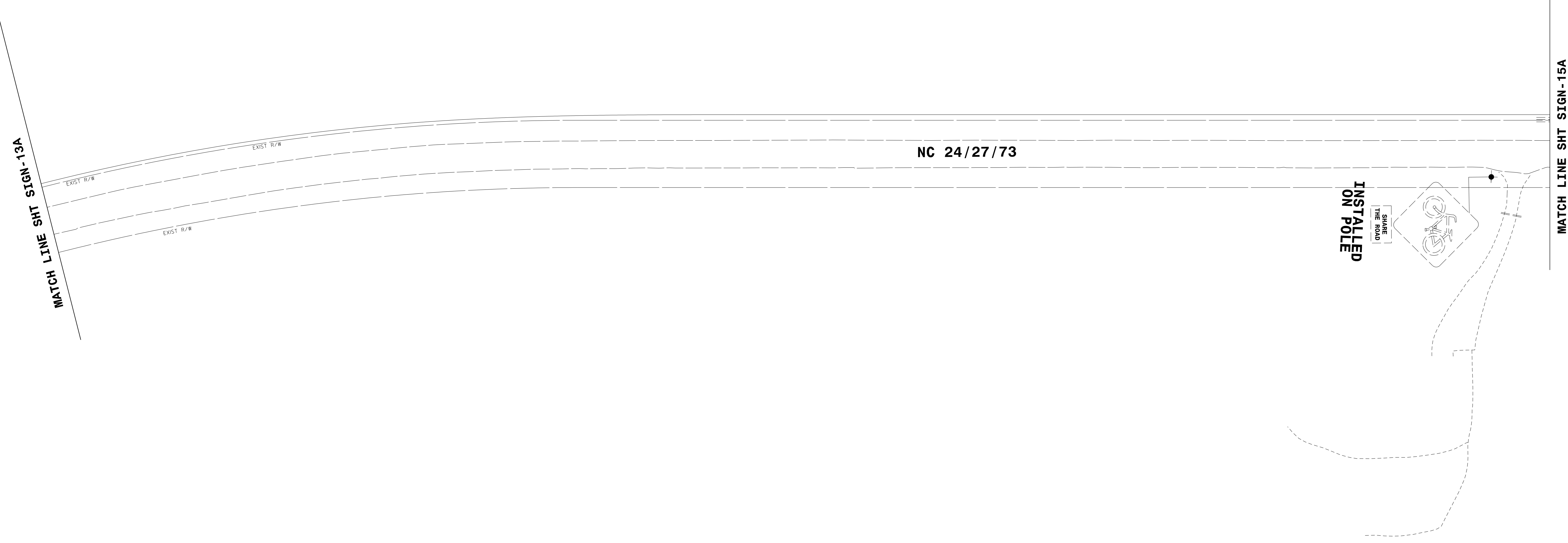

NC
 GRID
 NAD 83/95



REVISIONS

PLOT DRIVER: \$PLTDRV\$ PENTABLE: \$PENTBL\$
 USER: \$USER\$ DATE: \$DATE\$ TIME: \$TIME\$
 FILE: \$PWWARVAULTPATHDESC\$ SCALE: \$SCALE\$ SHORTS

APPROVED: <i>Ron King</i> DATE: 12/13/2018		EXISTING SIGN DETAIL																				
<table border="1"> <tr> <td>SCALE:</td> <td>NTS</td> </tr> <tr> <td>DATE:</td> <td>\$DATES</td> </tr> <tr> <td>DWG. BY:</td> <td>K HECTOR</td> </tr> <tr> <td>DESIGN BY:</td> <td>K HECTOR</td> </tr> <tr> <td>REVIEWED BY:</td> <td>R KING</td> </tr> </table>		SCALE:	NTS	DATE:	\$DATES	DWG. BY:	K HECTOR	DESIGN BY:	K HECTOR	REVIEWED BY:	R KING		<table border="1"> <tr> <th colspan="2">REVISIONS</th> </tr> <tr> <td> </td> <td> </td> </tr> <tr> <td> </td> <td> </td> </tr> <tr> <td> </td> <td> </td> </tr> <tr> <td> </td> <td> </td> </tr> </table>	REVISIONS								
SCALE:	NTS																					
DATE:	\$DATES																					
DWG. BY:	K HECTOR																					
DESIGN BY:	K HECTOR																					
REVIEWED BY:	R KING																					
REVISIONS																						

PROJ. REFERENCE NO.	SHEET NO.
R-2530B	SIGN-15A
DOCUMENT NOT CONSIDERED FINAL UNLESS ALL SIGNATURES COMPLETED	
 HDR Engineering, Inc. of the Carolinas 555 Fayetteville St, Suite 900 Raleigh, N.C. 27601 N.C.B.E.L.S. License Number: F-0116	

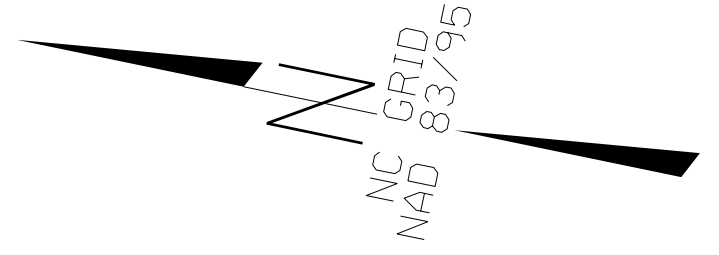

MATCH LINE SHT SIGN-14A

MATCH LINE SHT SIGN-16A

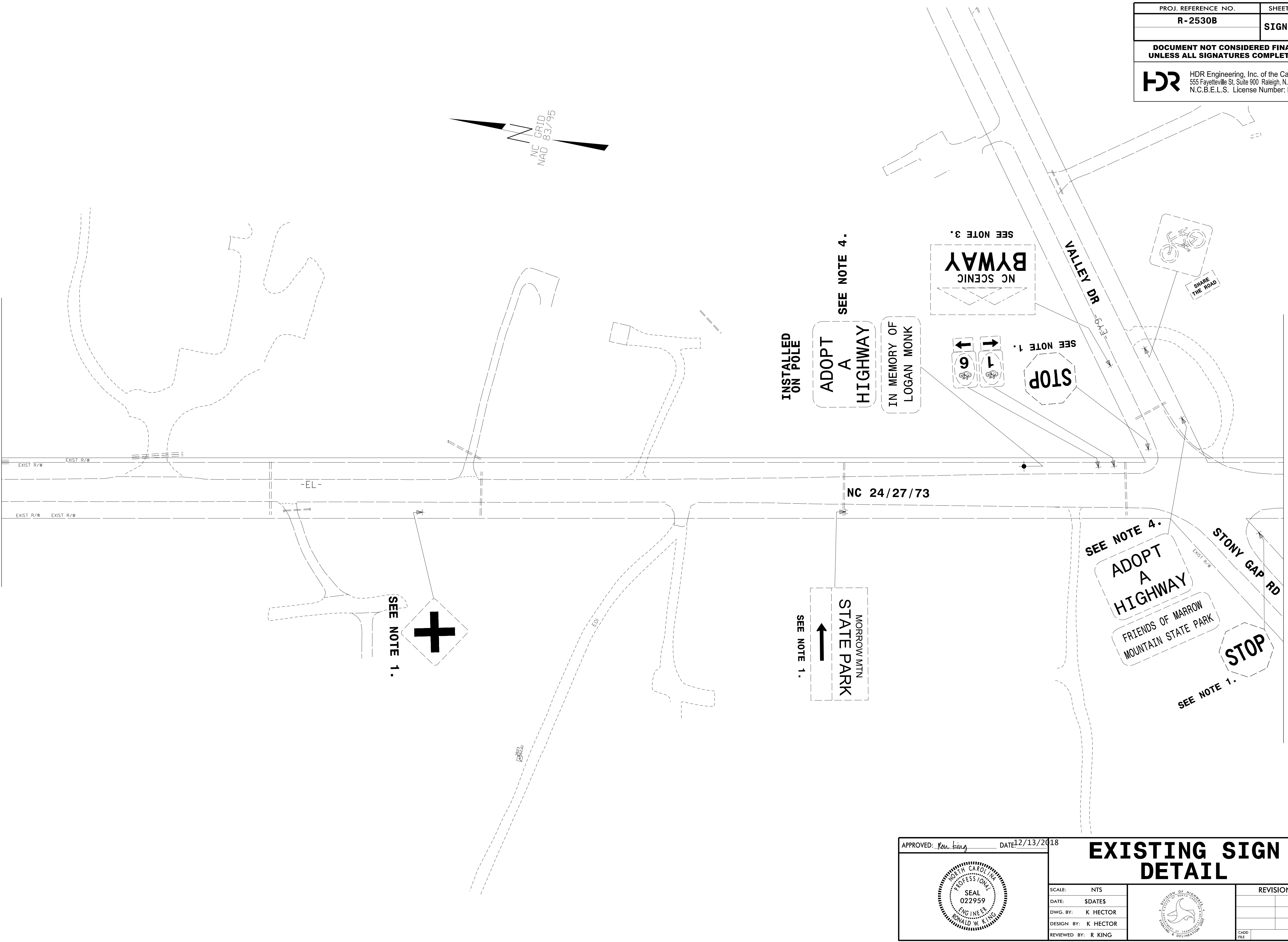

REVISIONS

PLOT DRIVER: \$PLTDRV\$
 USER: \$USER\$
 FILE: \$PWVARVAULTPATHDESIG\$
 DATE: \$DATE\$
 PENTABLE: \$PENTBL\$
 TIME: \$TIME\$
 SCALE: \$SCALESHORT\$

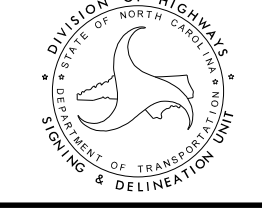
APPROVED: <i>Ron King</i> DATE: 12/13/2018		<h2 style="text-align: center;">EXISTING SIGN DETAIL</h2>	
			
SCALE:	NTS		REVISIONS
DATE:	\$DATES		
DWG. BY:	K HECTOR		
DESIGN BY:	K HECTOR		
REVIEWED BY:	R KING		CADD FILE

PROJ. REFERENCE NO.	SHEET NO.
R-2530B	SIGN - 16
DOCUMENT NOT CONSIDERED FINAL UNLESS ALL SIGNATURES COMPLETED	
 HDR Engineering, Inc. of the Carolinas 555 Fayetteville St, Suite 900 Raleigh, N.C. 27601 N.C.B.E.L.S. License Number: F-0116	

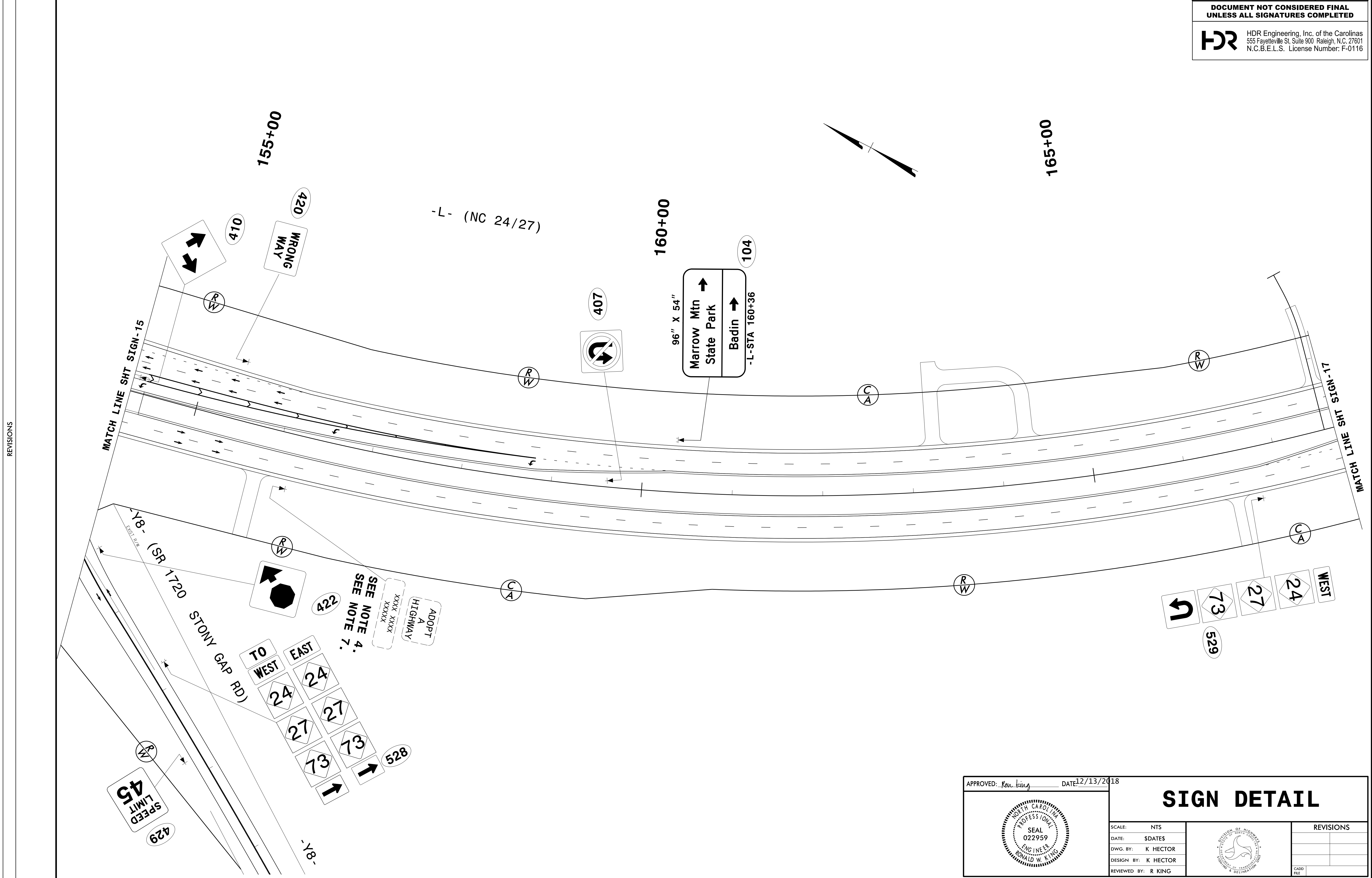

PLOT DRIVER: \$PLTDVRS\$
 USER: \$USER\$
 FILE: \$PWVARVAULTPATHDESIG\$
 PENTABLE: \$PENTBL\$
 TIME: \$TIME\$
 SCALE: \$SCALESHORT\$

REVISIONS

APPROVED: *Ron King* DATE: 12/13/2018

PROFESSIONAL SEAL
 SEAL 022959
 ENGINEER
 RONALD W. KING

SIGN DETAIL

SCALE: NTS		<table border="1"> <tr><th colspan="2">REVISIONS</th></tr> <tr><td> </td><td> </td></tr> <tr><td> </td><td> </td></tr> <tr><td> </td><td> </td></tr> </table>	REVISIONS							
REVISIONS										
DATE: \$DATES										
DWG. BY: K HECTOR										
DESIGN BY: K HECTOR										
REVIEWED BY: R KING	CADD FILE									

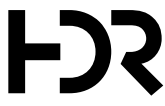
PROJ. REFERENCE NO.	SHEET NO.
R-2530B	SIGN-16A
DOCUMENT NOT CONSIDERED FINAL UNLESS ALL SIGNATURES COMPLETED	
 HDR Engineering, Inc. of the Carolinas 555 Fayetteville St, Suite 900 Raleigh, N.C. 27601 N.C.B.E.L.S. License Number: F-0116	

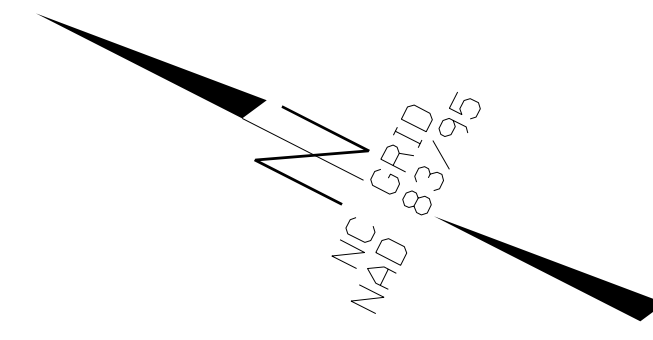

MORROW MTN
STATE PARK
SEE NOTE 1.

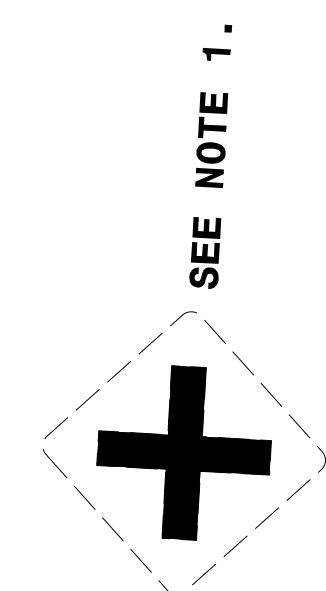

MATCH LINE SHT SIGN-15A

MATCH LINE SHT SIGN-17A

ADOPT
A
HIGHWAY
SEE NOTE 4.
INSTALLED
ON POLE

NC 24/27/73

SEE NOTE 1.
SPEED
LIMIT
45

STONY GAP RD

REVISIONS

PLOT DRIVER: \$PLTDRV\$ PENTABLE: \$PENTBL\$ SCALE: \$SCALESHT\$
 USER: \$USER\$ DATE: \$DATE\$ TIME: \$TIME\$
 FILE: \$PWVARVAULTPATHDESIG\$

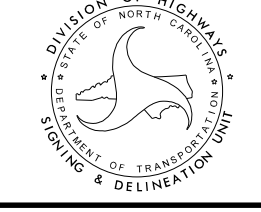

APPROVED: <i>Ron King</i> DATE: 12/13/2018		EXISTING SIGN DETAIL						
SCALE: NTS DATE: \$DATES\$ DWG. BY: K HECTOR DESIGN BY: K HECTOR REVIEWED BY: R KING			REVISIONS <table border="1"> <tr><td> </td><td> </td></tr> <tr><td> </td><td> </td></tr> <tr><td> </td><td> </td></tr> </table>					

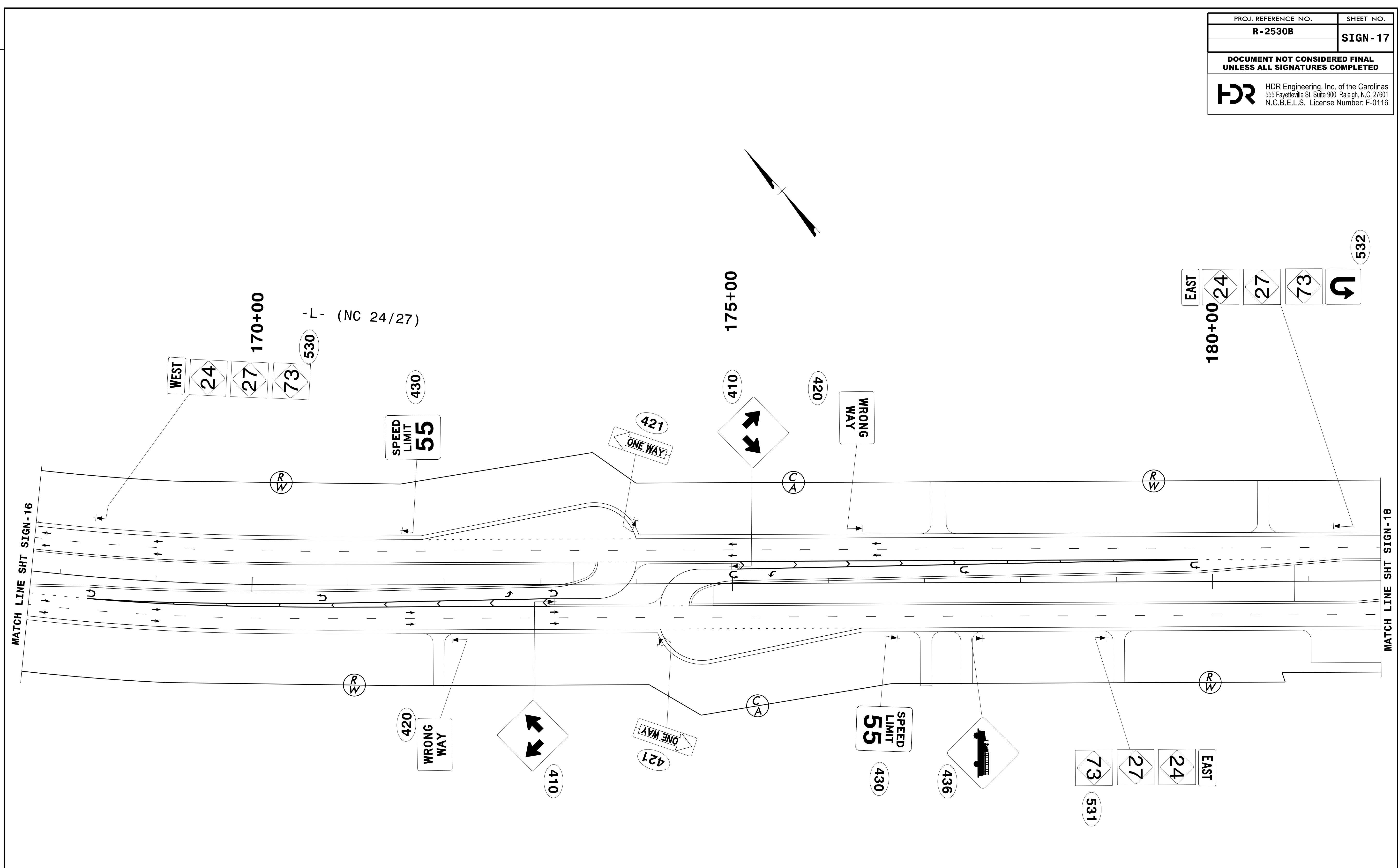
PROJ. REFERENCE NO.	SHEET NO.
R-2530B	SIGN - 17
DOCUMENT NOT CONSIDERED FINAL UNLESS ALL SIGNATURES COMPLETED	
 HDR Engineering, Inc. of the Carolinas 555 Fayetteville St, Suite 900 Raleigh, N.C. 27601 N.C.B.E.L.S. License Number: F-0116	



REVISIONS

PLOT DRIVER: \$PLTDVRS\$
 USER: \$USER\$
 FILE: \$PWVAVVAULTPATHDESIG\$
 PENTABLE: \$PENTBL\$
 TIME: \$TIME\$
 SCALE: \$SCALE\$
 DATE: \$DATE\$

APPROVED: <i>Ron King</i>	DATE: 12/13/2018	<h2>SIGN DETAIL</h2>								
										
SCALE: NTS	DATE: \$DATES\$	<table border="1"> <thead> <tr> <th colspan="2">REVISIONS</th> </tr> </thead> <tbody> <tr> <td> </td> <td> </td> </tr> <tr> <td> </td> <td> </td> </tr> <tr> <td> </td> <td> </td> </tr> </tbody> </table>	REVISIONS							
REVISIONS										
DWG. BY: K HECTOR	DESIGN BY: K HECTOR									
REVIEWED BY: R KING										

PROJ. REFERENCE NO.	SHEET NO.
R-2530B	SIGN-17A
DOCUMENT NOT CONSIDERED FINAL UNLESS ALL SIGNATURES COMPLETED	
 HDR Engineering, Inc. of the Carolinas 555 Fayetteville St, Suite 900 Raleigh, N.C. 27601 N.C.B.E.L.S. License Number: F-0116	

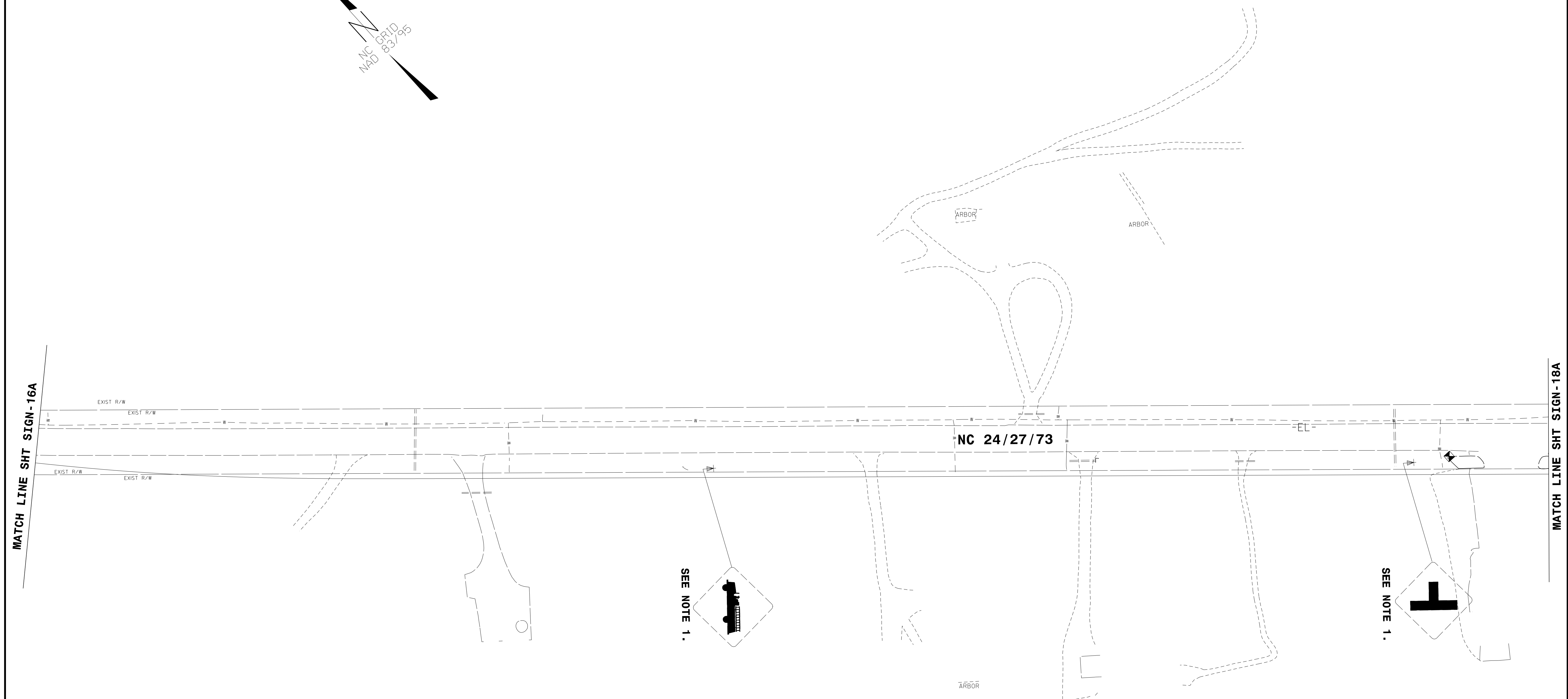
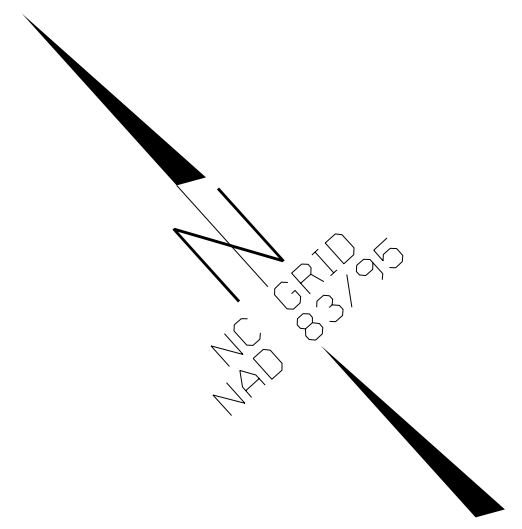

MATCH LINE SHT SIGN-16A



MATCH LINE SHT SIGN-18A

SEE NOTE 1.

SEE NOTE 1.

REVISIONS

PLOT DRIVER: \$PLTDVRS\$ PENTABLE: \$PENTBL\$ SCALE: \$SCALESHT\$
 USER: \$USER\$ DATE: \$DATE\$ TIME: \$TIME\$
 FILE: \$PWVARVAULTPATHDESC\$

APPROVED: <i>Ron King</i> DATE: 12/13/2018		EXISTING SIGN DETAIL						
SCALE: NTS DATE: \$DATES\$ DWG. BY: K HECTOR DESIGN BY: K HECTOR REVIEWED BY: R KING			REVISIONS <table border="1"> <tr><td> </td><td> </td></tr> <tr><td> </td><td> </td></tr> <tr><td> </td><td> </td></tr> </table>					

PROJ. REFERENCE NO.	SHEET NO.
R-2530B	SIGN - 18
DOCUMENT NOT CONSIDERED FINAL UNLESS ALL SIGNATURES COMPLETED	
 HDR Engineering, Inc. of the Carolinas 555 Fayetteville St, Suite 900 Raleigh, N.C. 27601 N.C.B.E.L.S. License Number: F-0116	

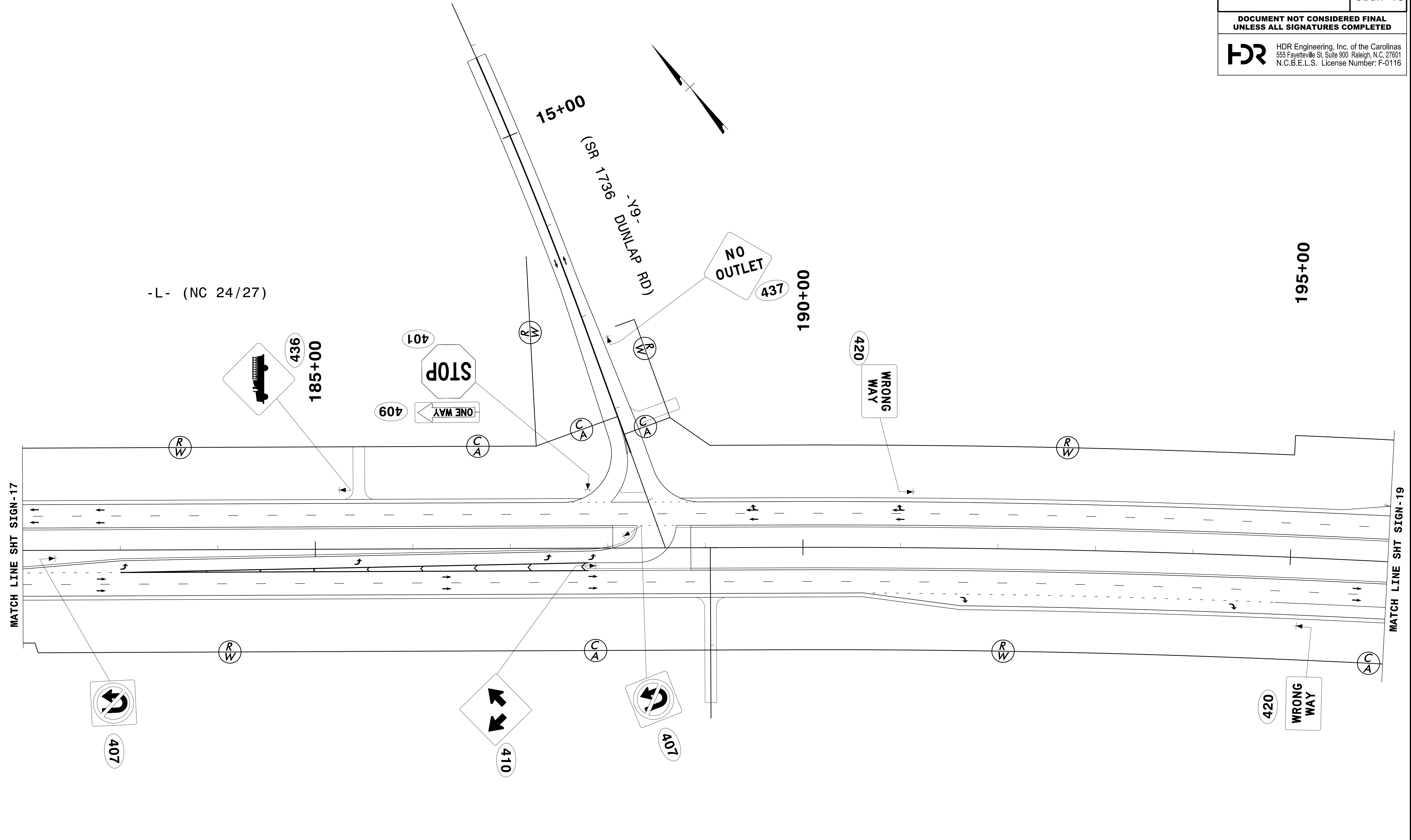



REVISIONS

MATCH LINE SHT SIGN-17

MATCH LINE SHT SIGN-19

PLOT DRIVER: \$PLTDVRS\$
 USER: \$USER\$
 FILE: \$PWVARVAULTPATHDESIG\$
 PENTABLE: \$PENTBL\$
 TIME: \$TIME\$
 SCALE: \$SCALESHORT\$
 DATE: \$DATE\$

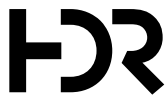

APPROVED: <i>Ron King</i>	DATE: 12/13/2018	<h1>SIGN DETAIL</h1>								
										
SCALE: NTS	DATE: \$DATES\$	<table border="1"> <thead> <tr> <th colspan="2">REVISIONS</th> </tr> </thead> <tbody> <tr><td> </td><td> </td></tr> <tr><td> </td><td> </td></tr> <tr><td> </td><td> </td></tr> </tbody> </table>	REVISIONS							
REVISIONS										
DWG. BY: K HECTOR	DESIGN BY: K HECTOR									
REVIEWED BY: R KING										
										

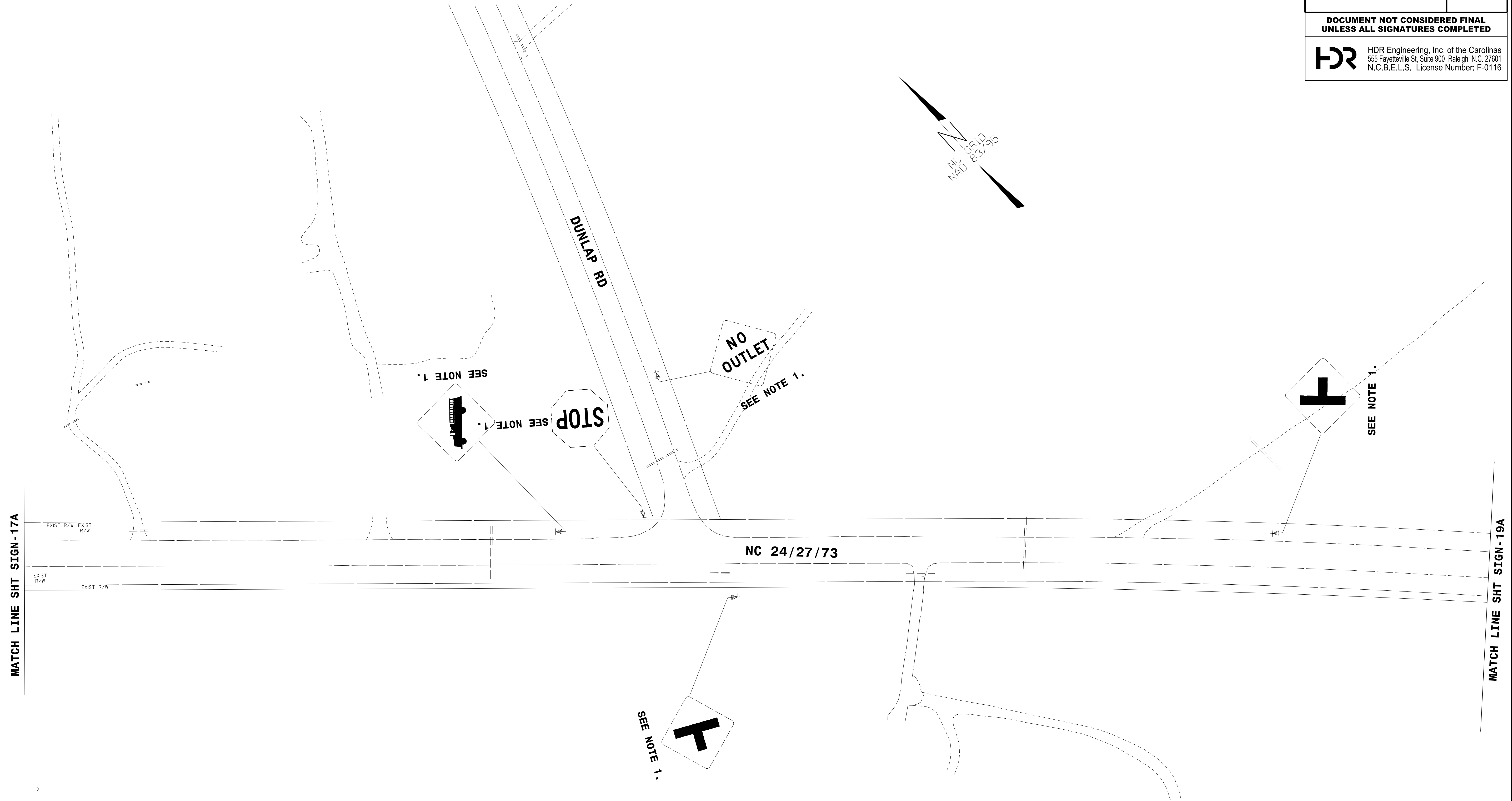
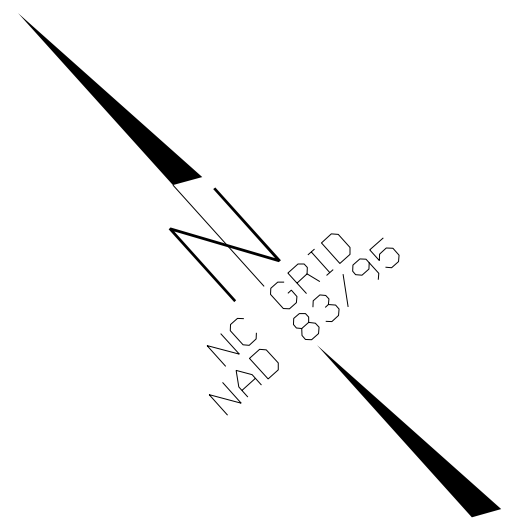
PROJ. REFERENCE NO.	SHEET NO.
R-2530B	SIGN-18A
DOCUMENT NOT CONSIDERED FINAL UNLESS ALL SIGNATURES COMPLETED	
 HDR Engineering, Inc. of the Carolinas 555 Fayetteville St, Suite 900 Raleigh, N.C. 27601 N.C.B.E.L.S. License Number: F-0116	



PLOT DRIVER: \$PLTDRV\$ PENTABLE: \$PENTBL\$ SCALE: \$SCALESHT\$
 USER: \$USER\$ DATE: \$DATE\$ TIME: \$TIME\$
 FILE: \$PWVARVAULTPATHDESIG\$

REVISIONS

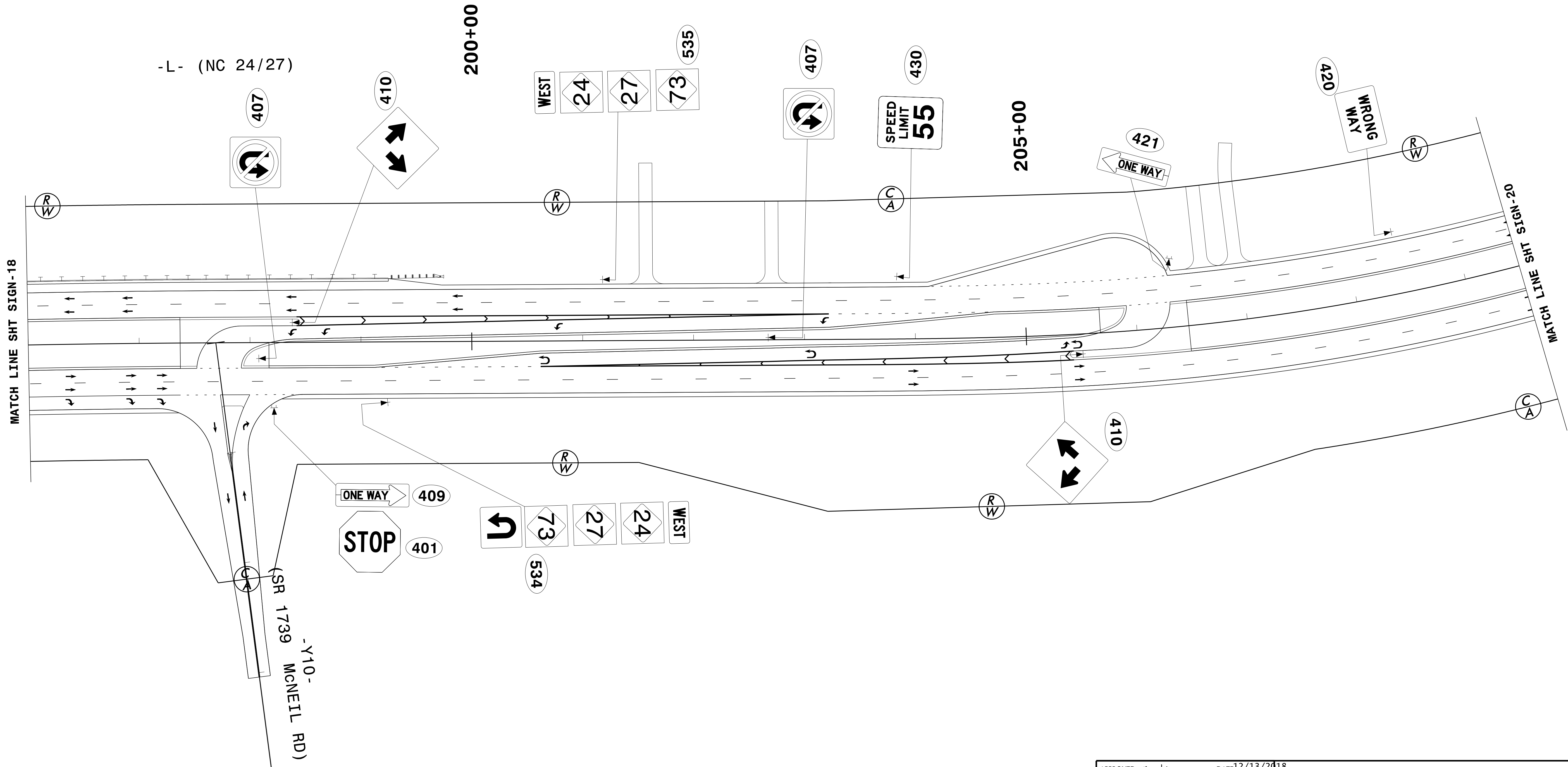

APPROVED: <i>Ron King</i>	DATE: 12/13/2018	<h2 style="text-align: center;">EXISTING SIGN DETAIL</h2>			<table border="1"> <tr><th colspan="2">REVISIONS</th></tr> <tr><td> </td><td> </td></tr> <tr><td> </td><td> </td></tr> <tr><td> </td><td> </td></tr> </table>	REVISIONS							
REVISIONS													
<table border="1"> <tr><td>SCALE:</td><td>NTS</td></tr> <tr><td>DATE:</td><td>\$DATES</td></tr> <tr><td>DWG. BY:</td><td>K HECTOR</td></tr> <tr><td>DESIGN BY:</td><td>K HECTOR</td></tr> <tr><td>REVIEWED BY:</td><td>R KING</td></tr> </table>		SCALE:	NTS	DATE:	\$DATES	DWG. BY:	K HECTOR	DESIGN BY:	K HECTOR	REVIEWED BY:	R KING	CADD FILE	
SCALE:	NTS												
DATE:	\$DATES												
DWG. BY:	K HECTOR												
DESIGN BY:	K HECTOR												
REVIEWED BY:	R KING												

PROJ. REFERENCE NO.	SHEET NO.
R-2530B	SIGN-19
DOCUMENT NOT CONSIDERED FINAL UNLESS ALL SIGNATURES COMPLETED	
 HDR Engineering, Inc. of the Carolinas 555 Fayetteville St, Suite 900 Raleigh, N.C. 27601 N.C.B.E.L.S. License Number: F-0116	



REVISIONS

PLOT DRIVER: \$PLTDVRS\$ PENTABLE: \$PENTBL\$
 USER: \$USER\$ TIME: \$TIME\$
 DATE: \$DATE\$ SCALE: \$SCALE\$
 FILE: \$PWWARVAULTPATHDESIG\$

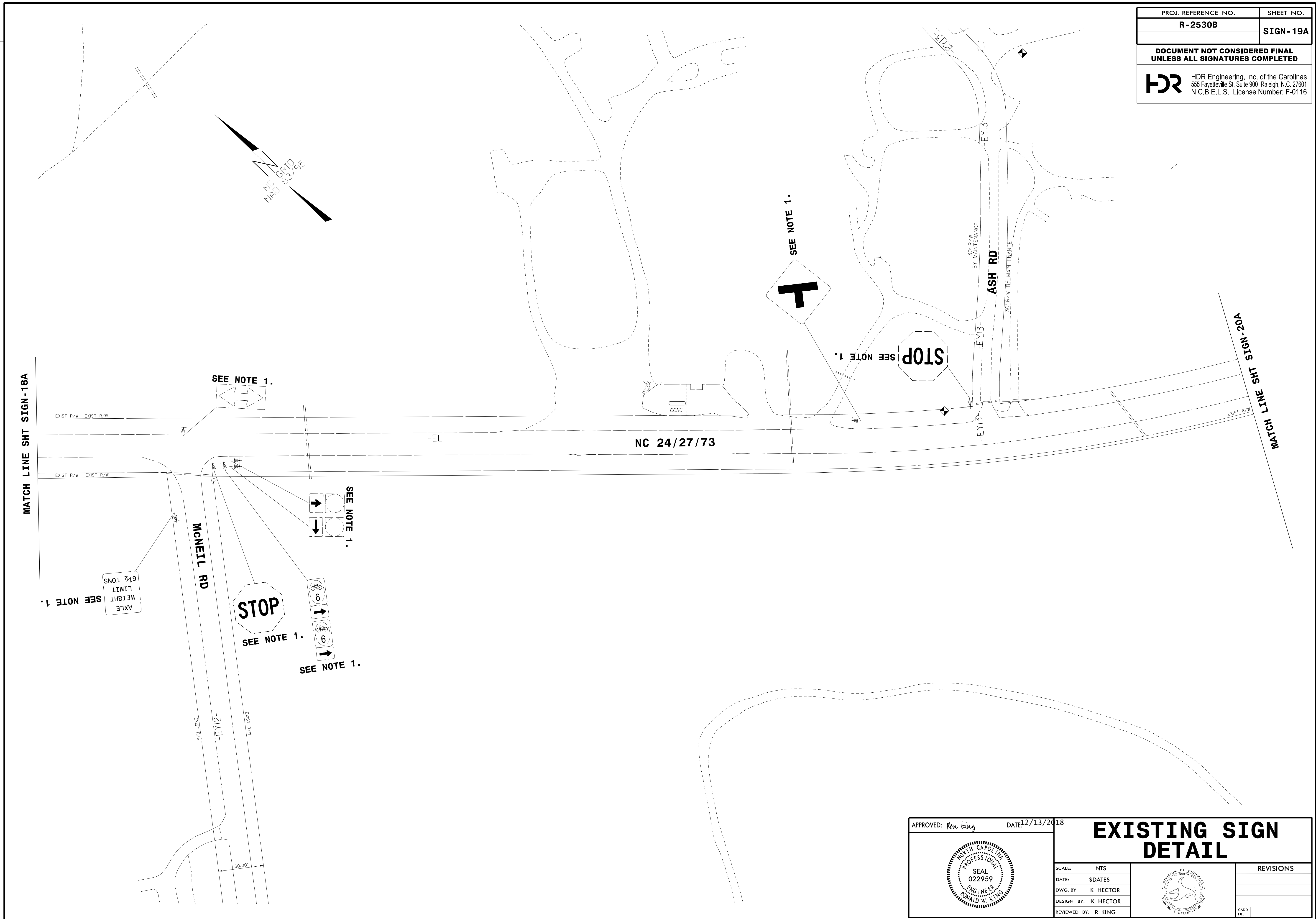

APPROVED: <i>Ronald W. King</i> DATE: 12/13/2018		SIGN DETAIL						
SCALE: NTS DATE: \$DATES\$ DWG. BY: K HECTOR DESIGN BY: K HECTOR REVIEWED BY: R KING			REVISIONS <table border="1"> <tr><td> </td><td> </td></tr> <tr><td> </td><td> </td></tr> <tr><td> </td><td> </td></tr> </table>					

PROJ. REFERENCE NO.	SHEET NO.
R-2530B	SIGN-19A
DOCUMENT NOT CONSIDERED FINAL UNLESS ALL SIGNATURES COMPLETED	
 HDR Engineering, Inc. of the Carolinas 555 Fayetteville St, Suite 900 Raleigh, N.C. 27601 N.C.B.E.L.S. License Number: F-0116	



REVISIONS

PLOT DRIVER: \$PLTDVRS\$ PENTABLE: \$PENTBL\$ SCALE: \$SCALES\$
 USER: \$USER\$ DATE: \$DATE\$ TIME: \$TIME\$
 FILE: \$PWVARVAULTPATHDESC\$

APPROVED: <i>Ron King</i> DATE: 12/13/2018		EXISTING SIGN DETAIL						
SCALE: NTS DATE: \$DATES\$ DWG. BY: K HECTOR DESIGN BY: K HECTOR REVIEWED BY: R KING			REVISIONS <table border="1"> <tr><td> </td><td> </td></tr> <tr><td> </td><td> </td></tr> <tr><td> </td><td> </td></tr> </table>					

PROJ. REFERENCE NO.	SHEET NO.
R-2530B	SIGN-20
DOCUMENT NOT CONSIDERED FINAL UNLESS ALL SIGNATURES COMPLETED	
 HDR Engineering, Inc. of the Carolinas 555 Fayetteville St, Suite 900 Raleigh, N.C. 27601 N.C.B.E.L.S. License Number: F-0116	

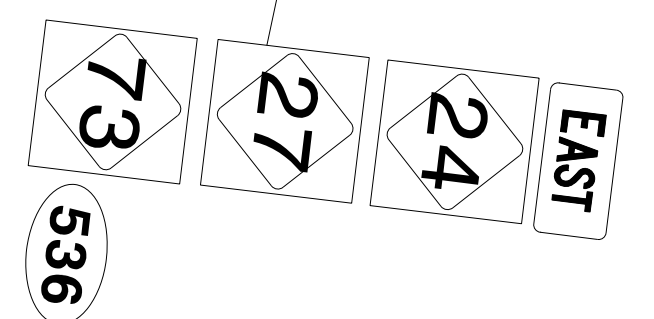
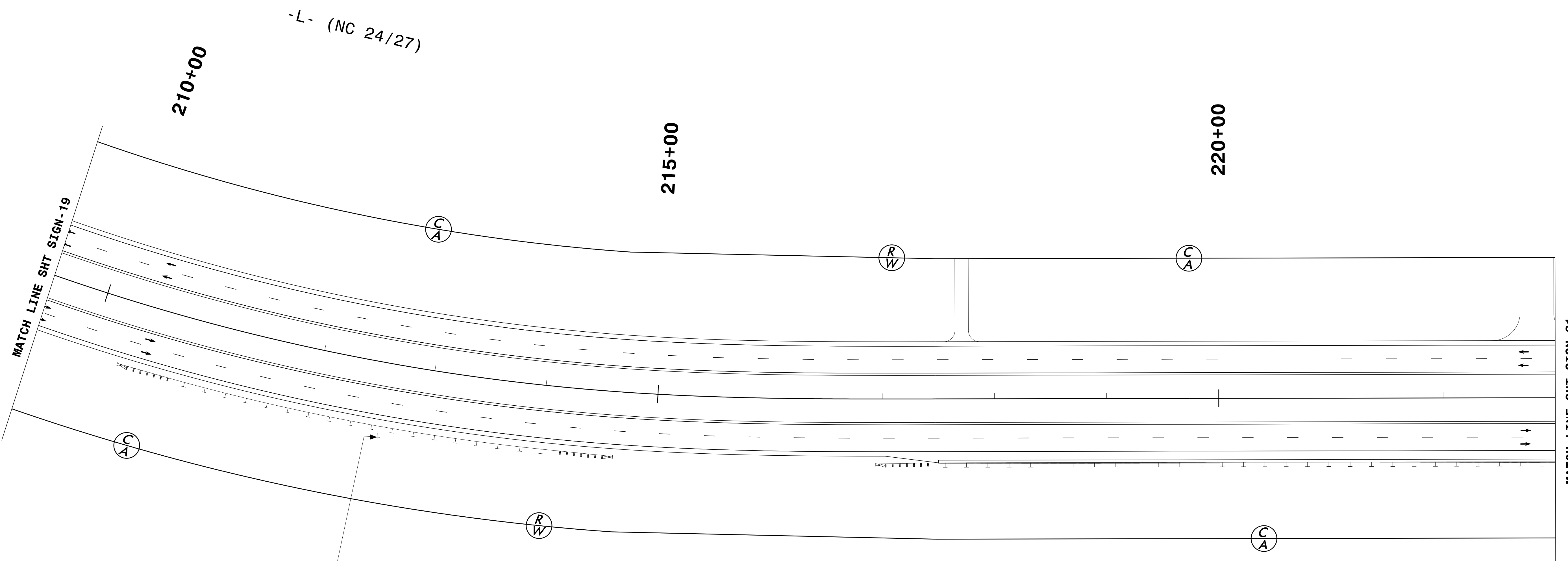

REVISIONS

PLOT DRIVER: \$PLTDVRS\$ PENTABLE: \$PENTBL\$
 USER: \$USER\$ DATE: \$DATE\$ TIME: \$TIME\$
 FILE: \$PWVARVAULTPATHDESIG\$ SCALE: \$SCALESHORT\$

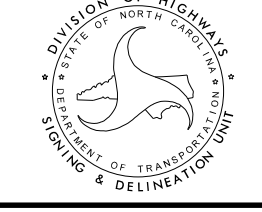

APPROVED: <i>Ron King</i> DATE: 12/13/2018			<table border="1"> <tr><th colspan="2">REVISIONS</th></tr> <tr><td> </td><td> </td></tr> <tr><td> </td><td> </td></tr> <tr><td> </td><td> </td></tr> <tr><td> </td><td> </td></tr> </table>	REVISIONS									
REVISIONS													
<table border="1"> <tr><td>SCALE:</td><td>NTS</td></tr> <tr><td>DATE:</td><td>\$DATES</td></tr> <tr><td>DWG. BY:</td><td>K HECTOR</td></tr> <tr><td>DESIGN BY:</td><td>K HECTOR</td></tr> <tr><td>REVIEWED BY:</td><td>R KING</td></tr> </table>	SCALE:	NTS	DATE:	\$DATES	DWG. BY:	K HECTOR	DESIGN BY:	K HECTOR	REVIEWED BY:	R KING	<h2 style="text-align: center;">SIGN DETAIL</h2>		
SCALE:	NTS												
DATE:	\$DATES												
DWG. BY:	K HECTOR												
DESIGN BY:	K HECTOR												
REVIEWED BY:	R KING												

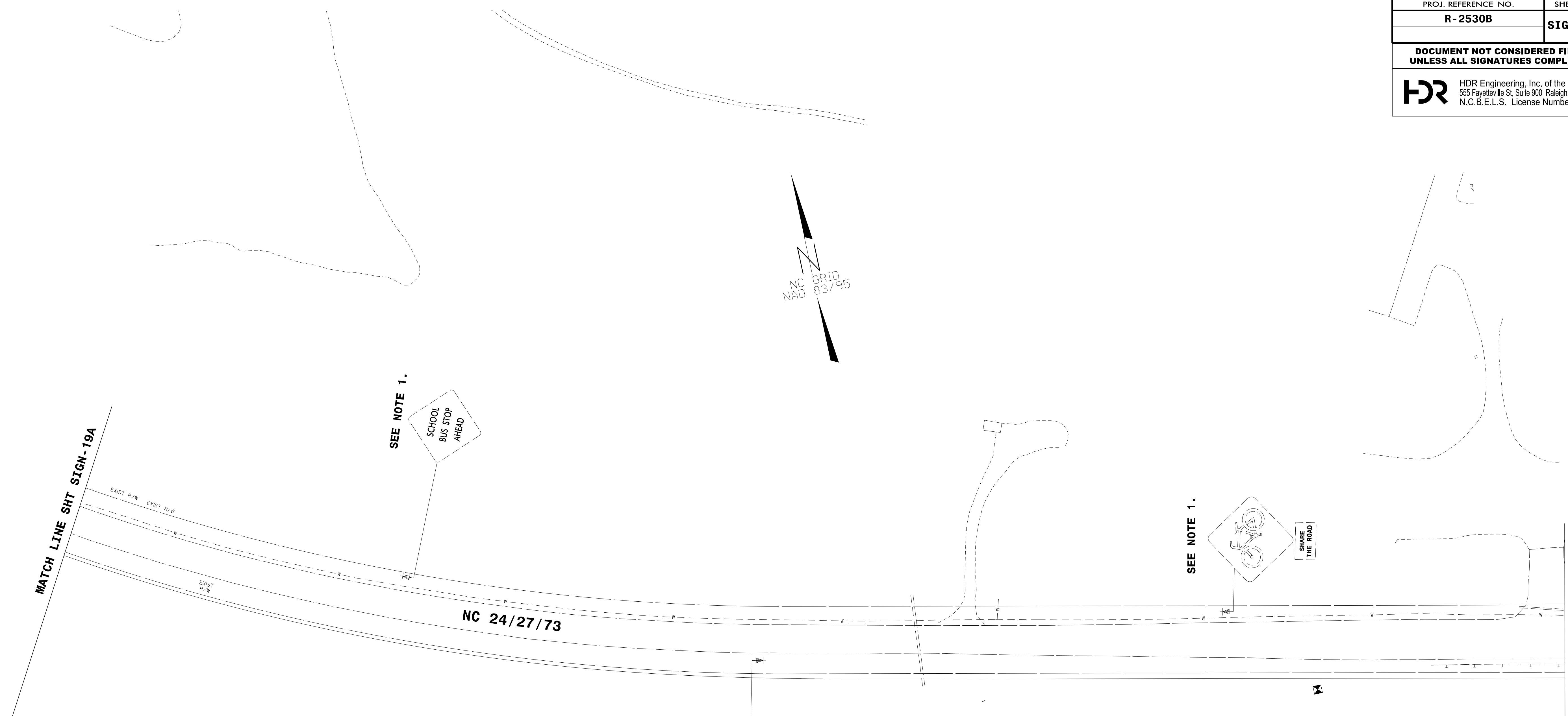
PROJ. REFERENCE NO.	SHEET NO.
R-2530B	SIGN-20A
DOCUMENT NOT CONSIDERED FINAL UNLESS ALL SIGNATURES COMPLETED	
 HDR Engineering, Inc. of the Carolinas 555 Fayetteville St, Suite 900 Raleigh, N.C. 27601 N.C.B.E.L.S. License Number: F-0116	



REVISIONS

PLOT DRIVER: \$PLTDRV\$ PENTABLE: \$PENTBL\$
 USER: \$USER\$ DATE: \$DATE\$ TIME: \$TIME\$
 FILE: \$PWVAVULTPATHDESIG\$ SCALE: \$SCALESHORT\$

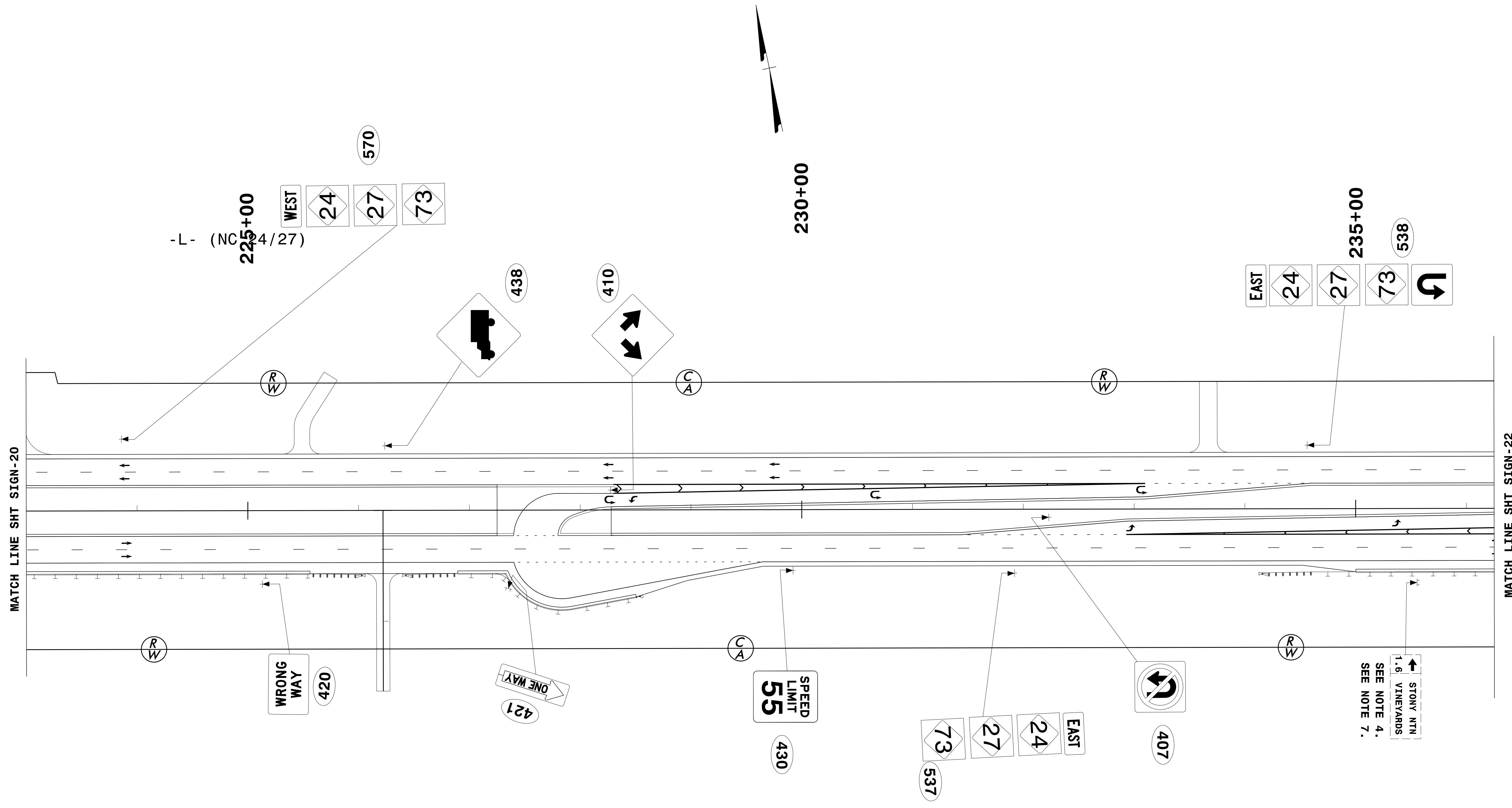

APPROVED: <i>Ron King</i> DATE: 12/13/2018		EXISTING SIGN DETAIL								
SCALE: NTS DATE: \$DATES\$ DWG. BY: K HECTOR DESIGN BY: K HECTOR REVIEWED BY: R KING			REVISIONS <table border="1"> <tr><td> </td><td> </td></tr> <tr><td> </td><td> </td></tr> <tr><td> </td><td> </td></tr> <tr><td> </td><td> </td></tr> </table>							

PROJ. REFERENCE NO.	SHEET NO.
R-2530B	SIGN-21
DOCUMENT NOT CONSIDERED FINAL UNLESS ALL SIGNATURES COMPLETED	
 HDR Engineering, Inc. of the Carolinas 555 Fayetteville St, Suite 900 Raleigh, N.C. 27601 N.C.B.E.L.S. License Number: F-0116	



REVISIONS

PLOT DRIVER: \$PLTDVRS\$ PENTABLE: \$PENTBL\$
 USER: \$USER\$ TIME: \$TIME\$
 DATE: \$DATE\$ SCALE: \$SCALE\$
 FILE: \$PWWARVAULTPATHDESIG\$

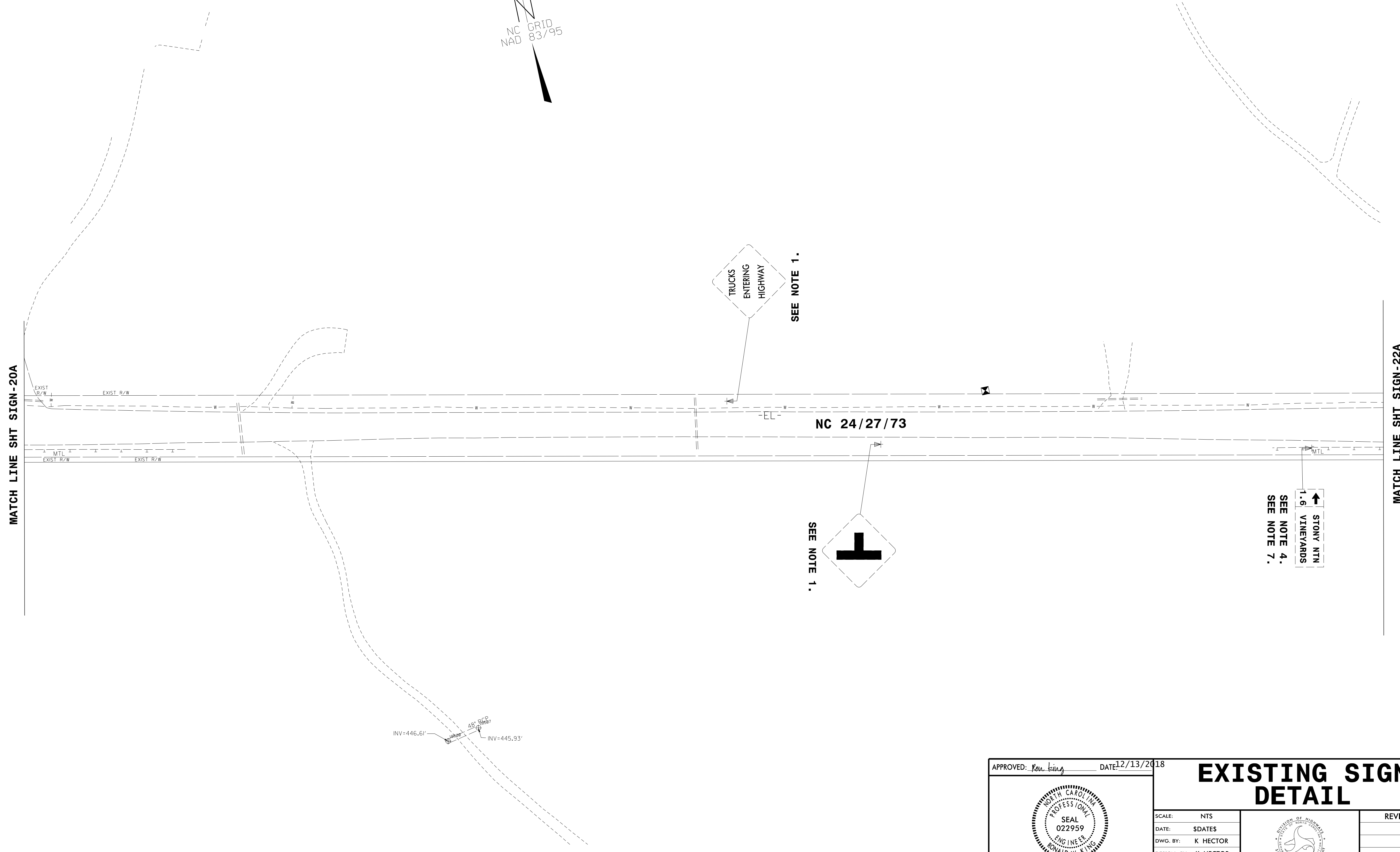

APPROVED: <i>Ron King</i> DATE: 12/13/2018		SIGN DETAIL				
SCALE: NTS DATE: \$DATES\$ DWG. BY: K HECTOR DESIGN BY: K HECTOR REVIEWED BY: R KING			REVISIONS <table border="1" style="width: 100%; height: 40px;"> <tr><td> </td><td> </td></tr> <tr><td> </td><td> </td></tr> </table>			

PROJ. REFERENCE NO.	SHEET NO.
R-2530B	SIGN-21A
DOCUMENT NOT CONSIDERED FINAL UNLESS ALL SIGNATURES COMPLETED	
 HDR Engineering, Inc. of the Carolinas 555 Fayetteville St, Suite 900 Raleigh, N.C. 27601 N.C.B.E.L.S. License Number: F-0116	



REVISIONS

PLOT DRIVER: \$PLTDVRS\$ PENTABLE: \$PENTBL\$ SCALE: \$SCALESHT\$
 USER: \$USER\$ DATE: \$DATE\$ TIME: \$TIME\$
 FILE: \$PWVARVAULTPATHDESC\$

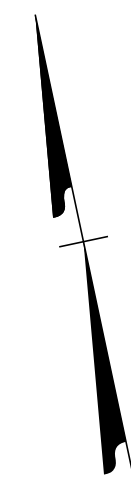
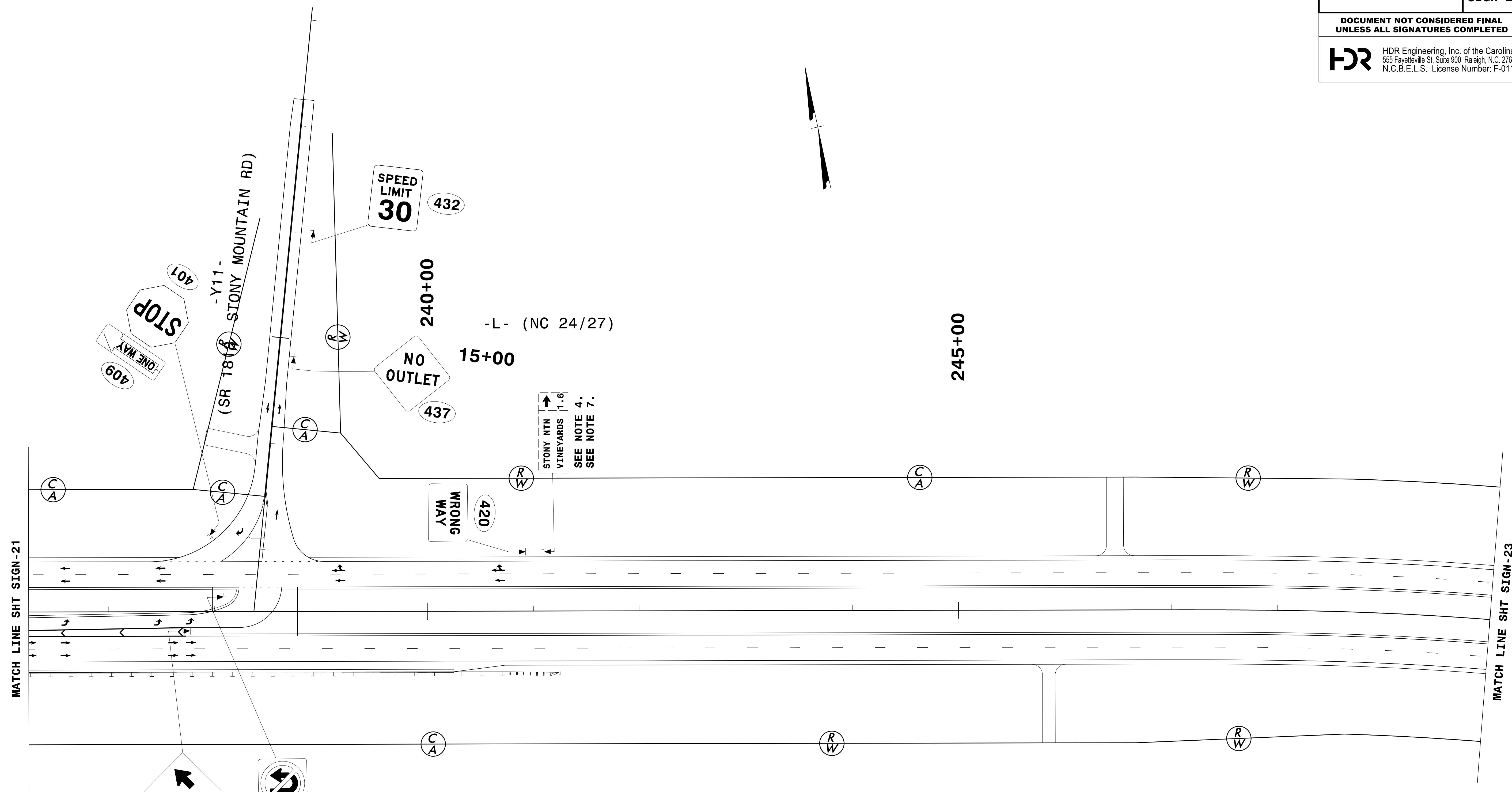

APPROVED: <i>Ron King</i> DATE: 12/13/2018			<table border="1"> <tr><th colspan="2">REVISIONS</th></tr> <tr><td> </td><td> </td></tr> <tr><td> </td><td> </td></tr> <tr><td> </td><td> </td></tr> <tr><td> </td><td> </td></tr> </table>	REVISIONS									
REVISIONS													
<p>EXISTING SIGN DETAIL</p> <p>SCALE: NTS DATE: \$DATES\$ DWG. BY: K HECTOR DESIGN BY: K HECTOR REVIEWED BY: R KING</p>	CADD FILE												

PROJ. REFERENCE NO.	SHEET NO.
R-2530B	SIGN-22
DOCUMENT NOT CONSIDERED FINAL UNLESS ALL SIGNATURES COMPLETED	
 HDR Engineering, Inc. of the Carolinas 555 Fayetteville St, Suite 900 Raleigh, N.C. 27601 N.C.B.E.L.S. License Number: F-0116	



REVISIONS

PLOT DRIVER: \$PLTDVRS\$
 USER: \$USER\$
 FILE: \$PWVARVAULTPATHDESIG\$
 DATE: \$DATE\$
 TIME: \$TIME\$
 SCALE: \$SCALESHORT\$
 PENTABLE: \$PENTBL\$

APPROVED: <i>Ron King</i>	DATE: 12/13/2018			SIGN DETAIL	
SCALE: NTS	DATE: \$DATES\$			REVISIONS	
DWG. BY: K HECTOR	DESIGN BY: K HECTOR	REVIEWED BY: R KING		CADD FILE	

PROJ. REFERENCE NO.	SHEET NO.
R-2530B	SIGN-22A
DOCUMENT NOT CONSIDERED FINAL UNLESS ALL SIGNATURES COMPLETED	
 HDR Engineering, Inc. of the Carolinas 555 Fayetteville St, Suite 900 Raleigh, N.C. 27601 N.C.B.E.L.S. License Number: F-0116	

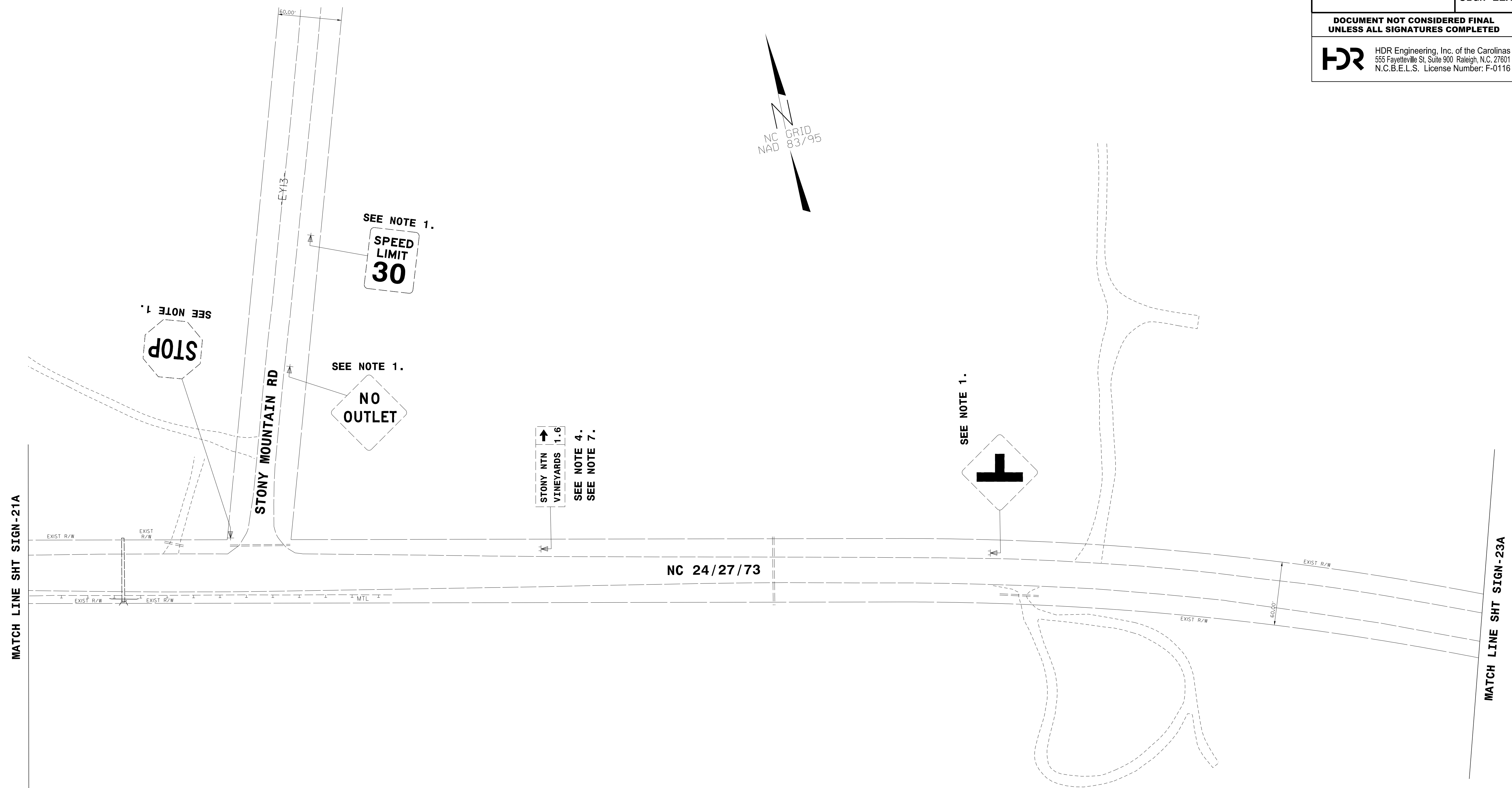

SEE NOTE 1.
STOP

SEE NOTE 1.
SPEED
LIMIT
30



SEE NOTE 1.
NO
OUTLET

STONY NTN
VINEYARDS 1.6
SEE NOTE 4.
SEE NOTE 7.

SEE NOTE 1.
T-junction sign

REVISIONS

PLOT DRIVER: \$PLTDRV\$
 USER: \$USER\$
 FILE: \$PWVARVAULTPATHDESC\$
 PENTABLE: \$PENTBL\$
 TIME: \$TIME\$
 DATE: \$DATE\$
 SCALE: \$SCALESHORT\$



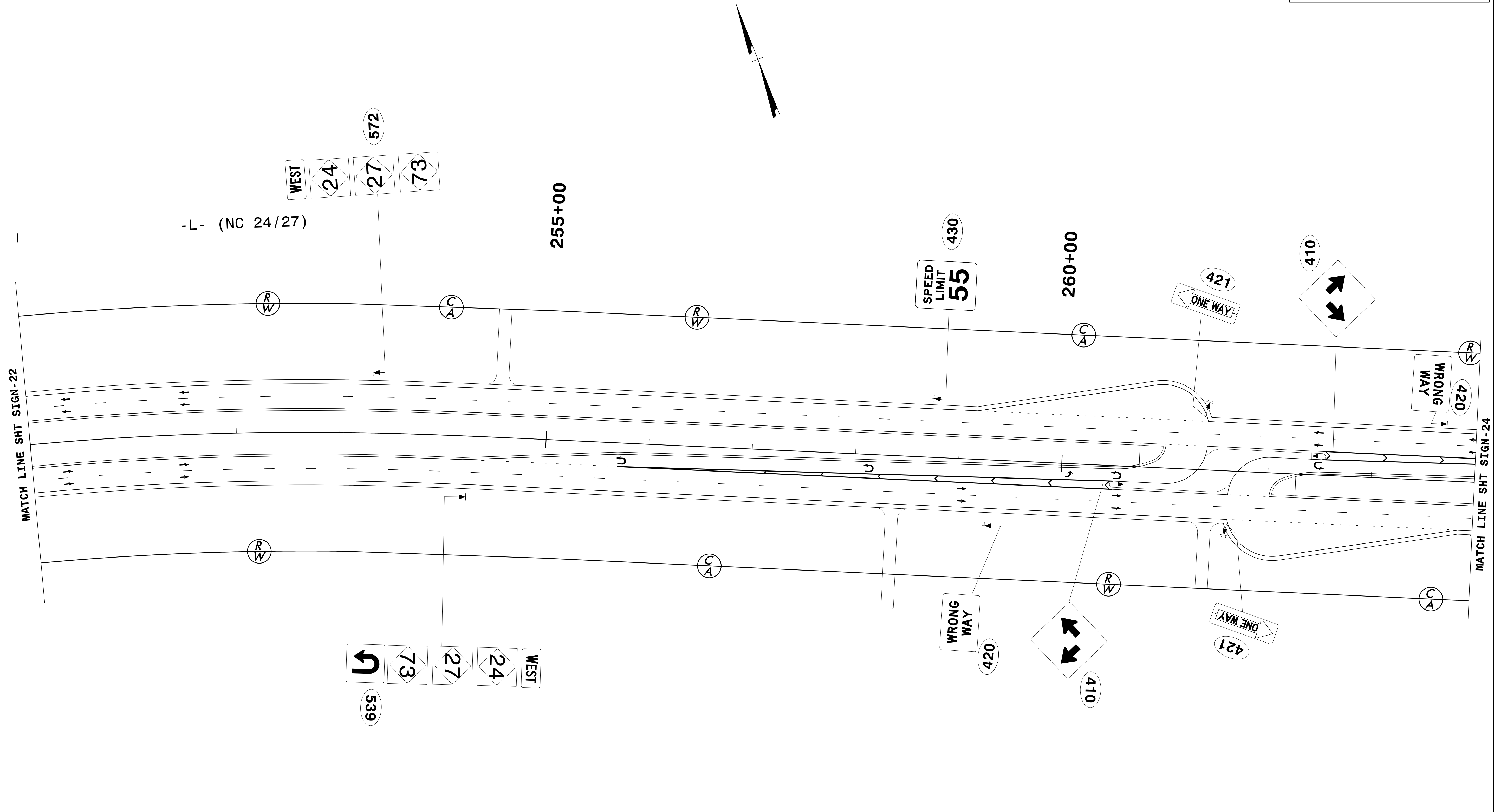

APPROVED: <i>Ron King</i>	DATE: 12/13/2018	<h2 style="text-align: center;">EXISTING SIGN DETAIL</h2>			REVISIONS
SCALE: NTS	DATE: \$DATES				
DESIGN BY: K HECTOR					
REVIEWED BY: R KING					

PROJ. REFERENCE NO.	SHEET NO.
R-2530B	SIGN-23
DOCUMENT NOT CONSIDERED FINAL UNLESS ALL SIGNATURES COMPLETED	
 HDR Engineering, Inc. of the Carolinas 555 Fayetteville St, Suite 900 Raleigh, N.C. 27601 N.C.B.E.L.S. License Number: F-0116	



REVISIONS

PLOT DRIVER: \$PLTDVRS\$ PENTABLE: \$PENTBL\$
 USER: \$USER\$ TIME: \$TIME\$ SCALE: \$SCALE\$
 DATE: \$DATE\$ FILE: \$PWVARVAULTPATHDESC\$

APPROVED: <i>Ron King</i> DATE: 12/13/2018		SIGN DETAIL																
<table border="1"> <tr> <td>SCALE: NTS</td> <td rowspan="4">  </td> <td colspan="2">REVISIONS</td> </tr> <tr> <td>DATE: \$DATES\$</td> <td></td> <td></td> </tr> <tr> <td>DWG. BY: K HECTOR</td> <td></td> <td></td> </tr> <tr> <td>DESIGN BY: K HECTOR</td> <td></td> <td></td> </tr> <tr> <td>REVIEWED BY: R KING</td> <td></td> <td></td> </tr> </table>		SCALE: NTS		REVISIONS		DATE: \$DATES\$			DWG. BY: K HECTOR			DESIGN BY: K HECTOR			REVIEWED BY: R KING			
SCALE: NTS		REVISIONS																
DATE: \$DATES\$																		
DWG. BY: K HECTOR																		
DESIGN BY: K HECTOR																		
REVIEWED BY: R KING																		

PROJ. REFERENCE NO.	SHEET NO.
R-2530B	SIGN-23A
DOCUMENT NOT CONSIDERED FINAL UNLESS ALL SIGNATURES COMPLETED	
 HDR Engineering, Inc. of the Carolinas 555 Fayetteville St, Suite 900 Raleigh, N.C. 27601 N.C.B.E.L.S. License Number: F-0116	



POND

MATCH LINE SHT SIGN-22A

MATCH LINE SHT SIGN-24A

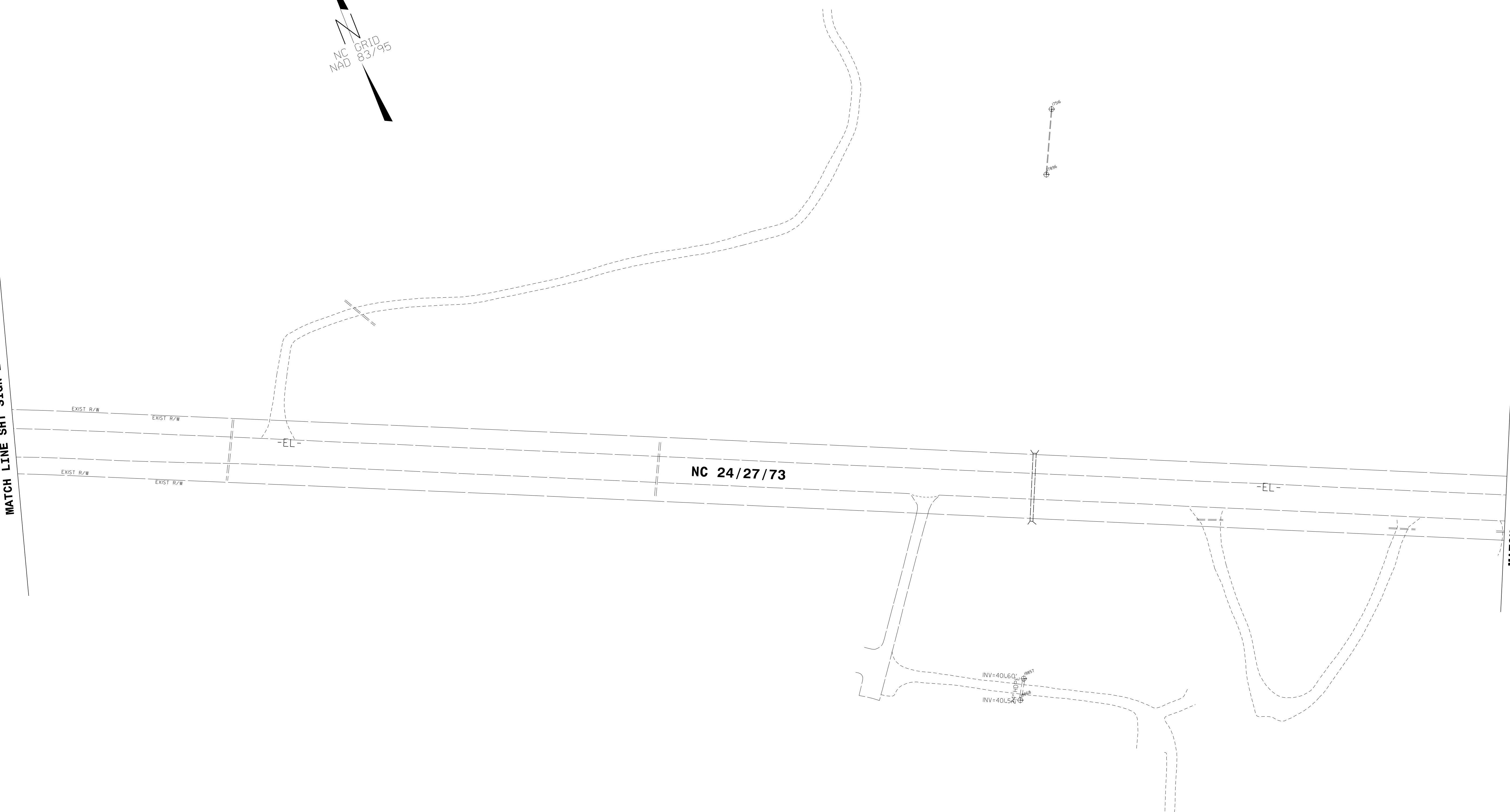



PLOT DRIVER: \$PLTDVRS\$
 USER: \$USER\$
 FILE: \$PWVARVAULTPATHDESC\$

PENTABLE: \$PENTBLS\$
 TIME: \$TIME\$
 SCALE: \$SCALESHORT\$

DATE: \$DATE\$

REVISIONS

APPROVED: <i>Ron King</i>	DATE: 12/13/2018	<h2 style="text-align: center;">EXISTING SIGN DETAIL</h2>			<table border="1"> <thead> <tr> <th colspan="2">REVISIONS</th> </tr> </thead> <tbody> <tr><td> </td><td> </td></tr> <tr><td> </td><td> </td></tr> <tr><td> </td><td> </td></tr> <tr><td> </td><td> </td></tr> </tbody> </table>	REVISIONS									
REVISIONS															
<table border="1"> <tr> <td>SCALE:</td> <td>NTS</td> </tr> <tr> <td>DATE:</td> <td>\$DATES</td> </tr> <tr> <td>DWG. BY:</td> <td>K HECTOR</td> </tr> <tr> <td>DESIGN BY:</td> <td>K HECTOR</td> </tr> <tr> <td>REVIEWED BY:</td> <td>R KING</td> </tr> </table>		SCALE:	NTS	DATE:	\$DATES	DWG. BY:	K HECTOR	DESIGN BY:	K HECTOR	REVIEWED BY:	R KING	<table border="1"> <tr> <td>CADD FILE</td> <td> </td> </tr> </table>	CADD FILE		
SCALE:	NTS														
DATE:	\$DATES														
DWG. BY:	K HECTOR														
DESIGN BY:	K HECTOR														
REVIEWED BY:	R KING														
CADD FILE															

PROJ. REFERENCE NO.	SHEET NO.
R-2530B	SIGN-24A
DOCUMENT NOT CONSIDERED FINAL UNLESS ALL SIGNATURES COMPLETED	
 HDR Engineering, Inc. of the Carolinas 555 Fayetteville St, Suite 900 Raleigh, N.C. 27601 N.C.B.E.L.S. License Number: F-0116	

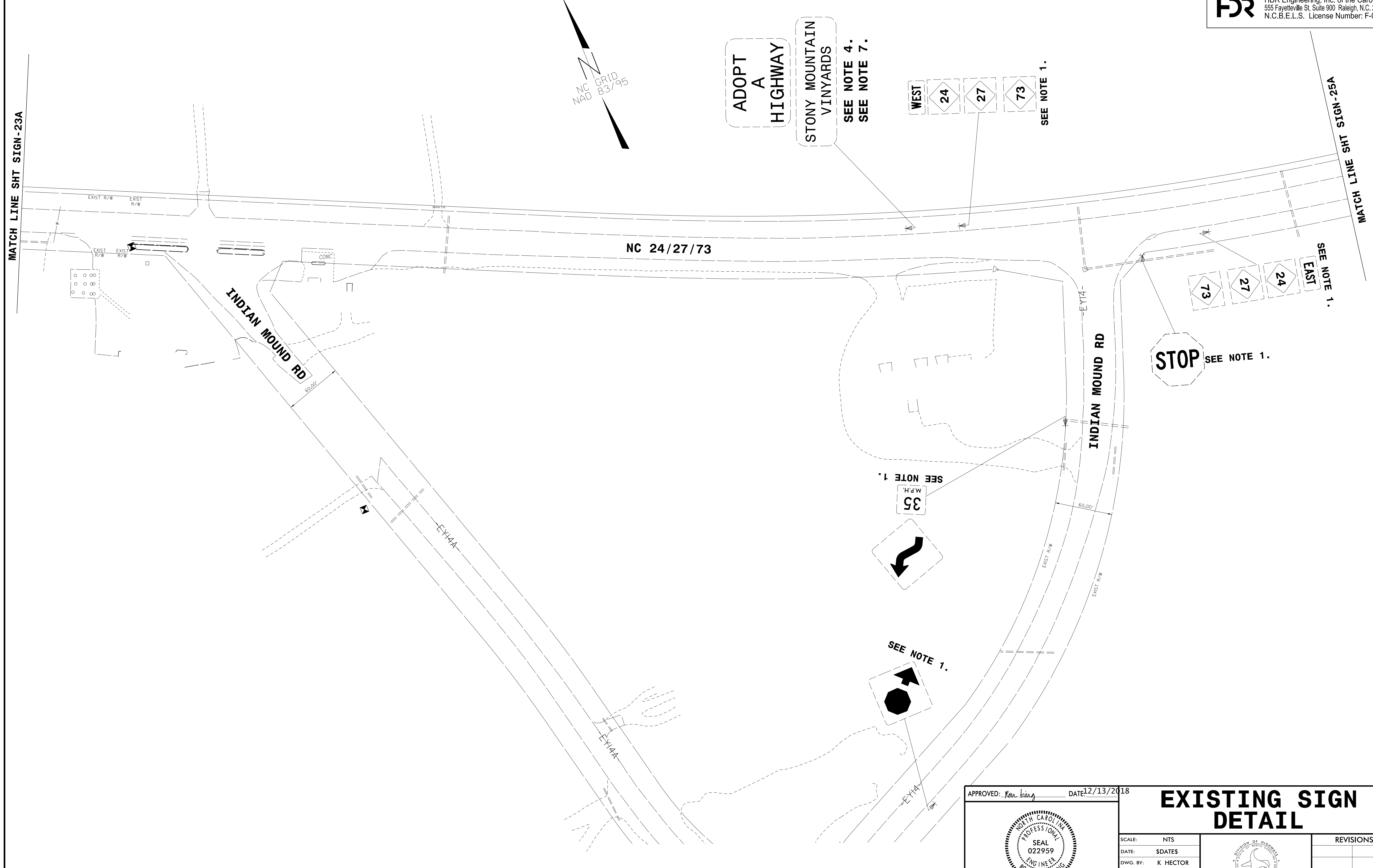

PLOT DRIVER: \$PLTDVRS\$ PENTABLE: \$PENTBLS\$
 USER: \$USER\$ DATE: \$DATE\$ TIME: \$TIME\$ SCALE: \$SCALESHORTS\$
 FILE: \$PWVARVAULTPATHDESIG\$

	APPROVED: <i>Ron King</i> DATE: 12/13/2018	
	EXISTING SIGN DETAIL	
	SCALE: NTS	REVISIONS
	DATE: \$DATES\$	
DWG. BY: K HECTOR		
DESIGN BY: K HECTOR		
REVIEWED BY: R KING		

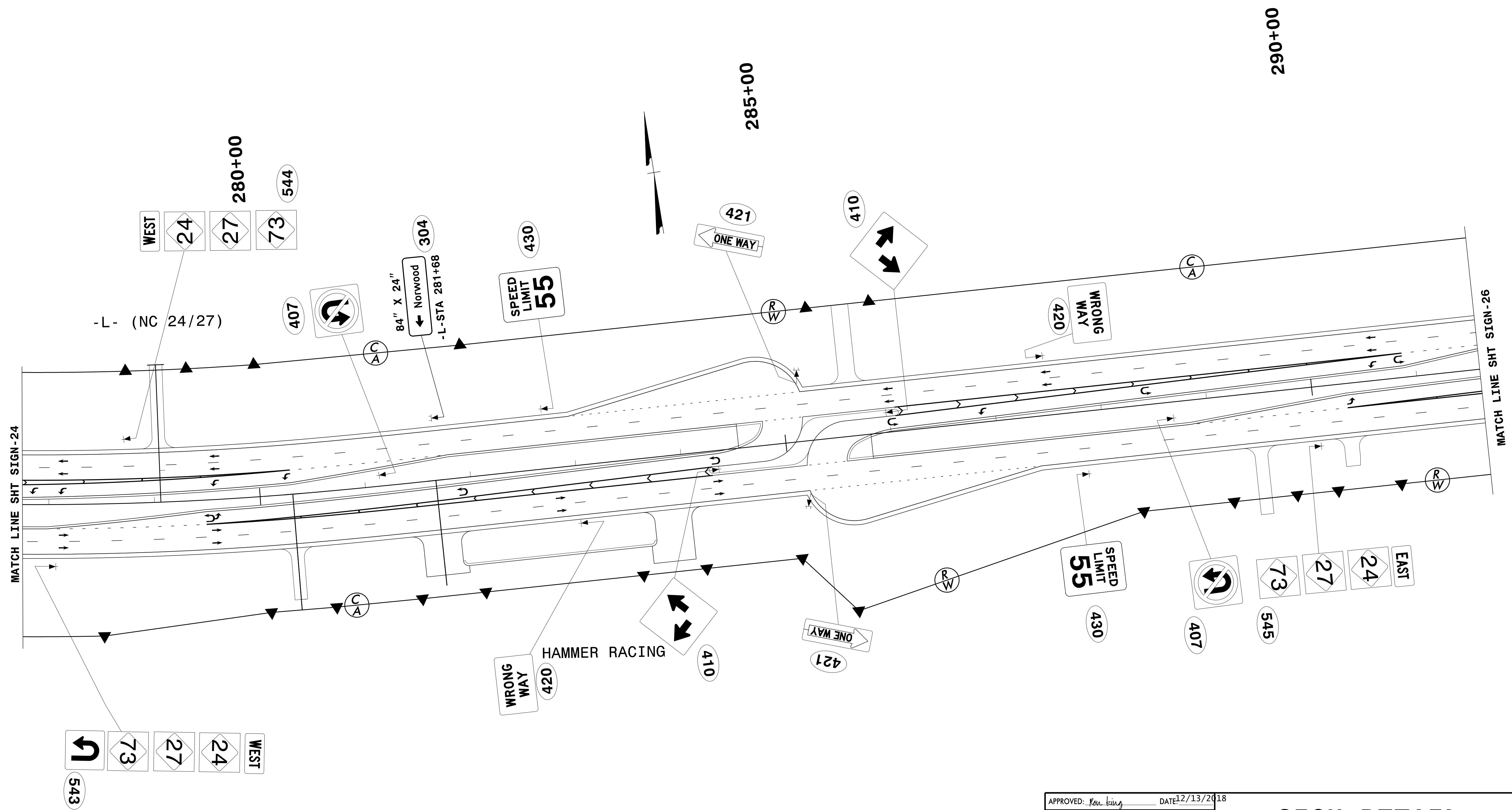

REVISIONS

PROJ. REFERENCE NO.	SHEET NO.
R-2530B	SIGN-25
DOCUMENT NOT CONSIDERED FINAL UNLESS ALL SIGNATURES COMPLETED	
 HDR Engineering, Inc. of the Carolinas 555 Fayetteville St, Suite 900 Raleigh, N.C. 27601 N.C.B.E.L.S. License Number: F-0116	



REVISIONS

PLOT DRIVER: \$PLTDRV\$
 USER: \$USER\$
 FILE: \$PWVARVAULTPATHDESIG\$
 DATE: \$DATE\$
 TIME: \$TIME\$
 SCALE: \$SCALESHORT\$
 PENTABLE: \$PENTBL\$

APPROVED: <i>Ron King</i>	DATE: 12/13/2018			SIGN DETAIL			
SCALE: NTS DATE: \$DATES\$ DWG. BY: K HECTOR DESIGN BY: K HECTOR REVIEWED BY: R KING	REVISIONS <table border="1"> <tr><td> </td><td> </td></tr> <tr><td> </td><td> </td></tr> <tr><td> </td><td> </td></tr> </table>						

PROJ. REFERENCE NO.	SHEET NO.
R-2530B	SIGN-25A
DOCUMENT NOT CONSIDERED FINAL UNLESS ALL SIGNATURES COMPLETED	
 HDR Engineering, Inc. of the Carolinas 555 Fayetteville St, Suite 900 Raleigh, N.C. 27601 N.C.B.E.L.S. License Number: F-0116	



MATCH LINE SHT SIGN-24A

MATCH LINE SHT SIGN-26A

NORWOOD

NC 24/27/73

SEE NOTE 1.

SEE NOTE 1.

12" HDPE
 INV=386.63'
 INV=387.38'

15" HDPE

60.0' EXIST R/W

60.0'

60.0' EXIST R/W

EXIST R/W

EXIST R/W

EXIST R/W

EXIST R/W

CONC

CONC

PLOT DRIVER: \$PLTDRV\$
 USER: \$USER\$
 FILE: \$PWVARVAULTPATHDESIG\$
 PENTABLE: \$PENTBL\$
 TIME: \$TIME\$
 DATE: \$DATE\$
 SCALE: \$SCALESHORT\$

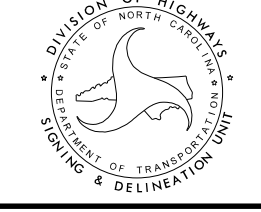
APPROVED: <i>Ron King</i>	DATE: 12/13/2018			<table border="1"> <tr><th colspan="2">REVISIONS</th></tr> <tr><td> </td><td> </td></tr> <tr><td> </td><td> </td></tr> <tr><td> </td><td> </td></tr> <tr><td> </td><td> </td></tr> </table>	REVISIONS									
REVISIONS														
<h2 style="text-align: center;">EXISTING SIGN DETAIL</h2>		<table border="1"> <tr><td>SCALE:</td><td>NTS</td></tr> <tr><td>DATE:</td><td>\$DATES</td></tr> <tr><td>DWG. BY:</td><td>K HECTOR</td></tr> <tr><td>DESIGN BY:</td><td>K HECTOR</td></tr> <tr><td>REVIEWED BY:</td><td>R KING</td></tr> </table>	SCALE:	NTS	DATE:	\$DATES	DWG. BY:	K HECTOR	DESIGN BY:	K HECTOR	REVIEWED BY:	R KING		
SCALE:	NTS													
DATE:	\$DATES													
DWG. BY:	K HECTOR													
DESIGN BY:	K HECTOR													
REVIEWED BY:	R KING													

PROJ. REFERENCE NO.	SHEET NO.
R-2530B	SIGN-26
DOCUMENT NOT CONSIDERED FINAL UNLESS ALL SIGNATURES COMPLETED	
 HDR Engineering, Inc. of the Carolinas 555 Fayetteville St, Suite 900 Raleigh, N.C. 27601 N.C.B.E.L.S. License Number: F-0116	

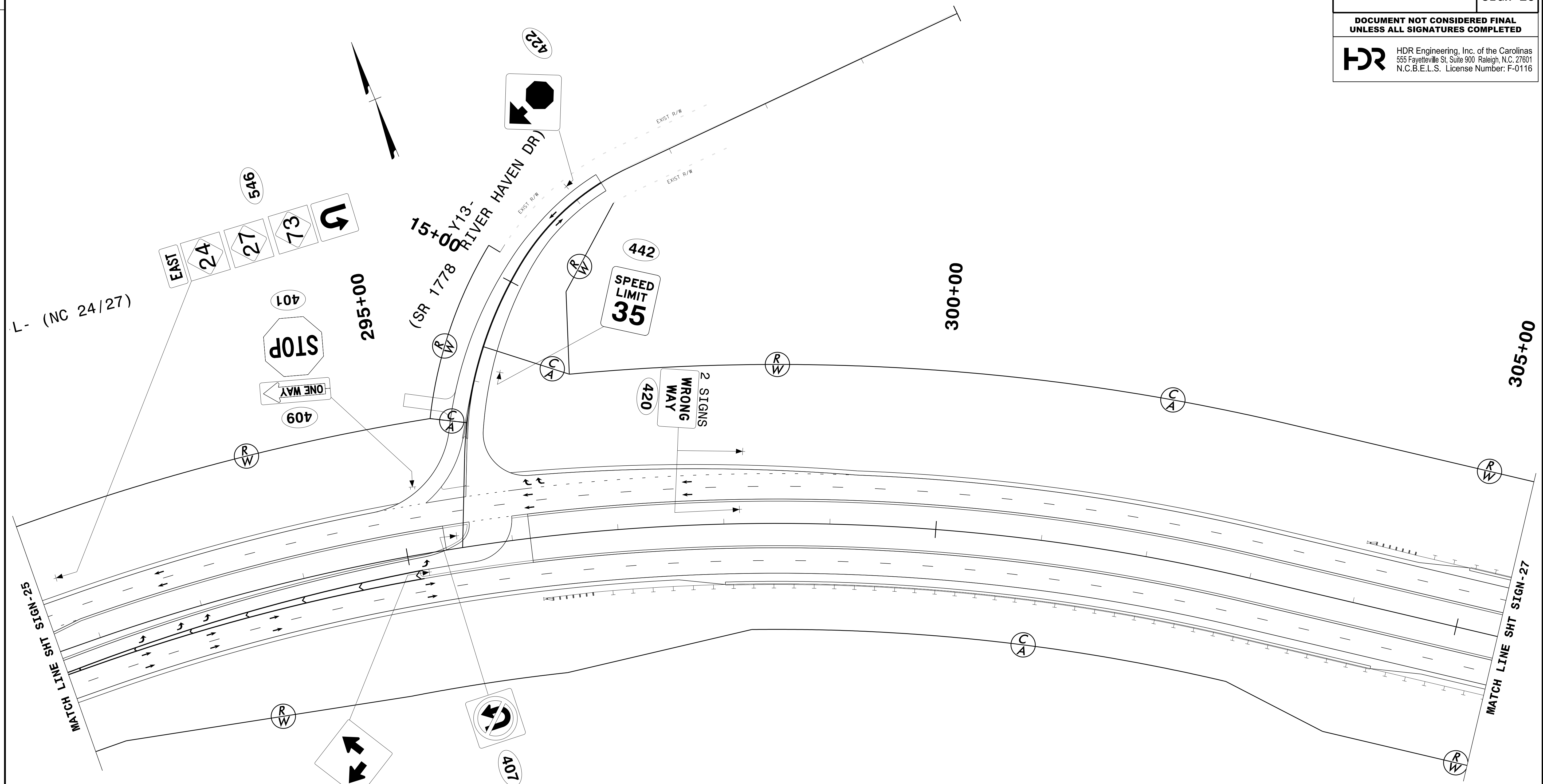

REVISIONS

PLOT DRIVER: \$PLTDRV\$
 USER: \$USER\$
 FILE: \$PWVARVAULTPATHDESIG\$
 DATE: \$DATE\$
 TIME: \$TIME\$
 SCALE: \$SCALESHORT\$

APPROVED: *Ron King* DATE: 12/13/2018

STATE OF NORTH CAROLINA
 PROFESSIONAL SEAL
 022959
 ENGINEER
 RONALD W. KING

SIGN DETAIL

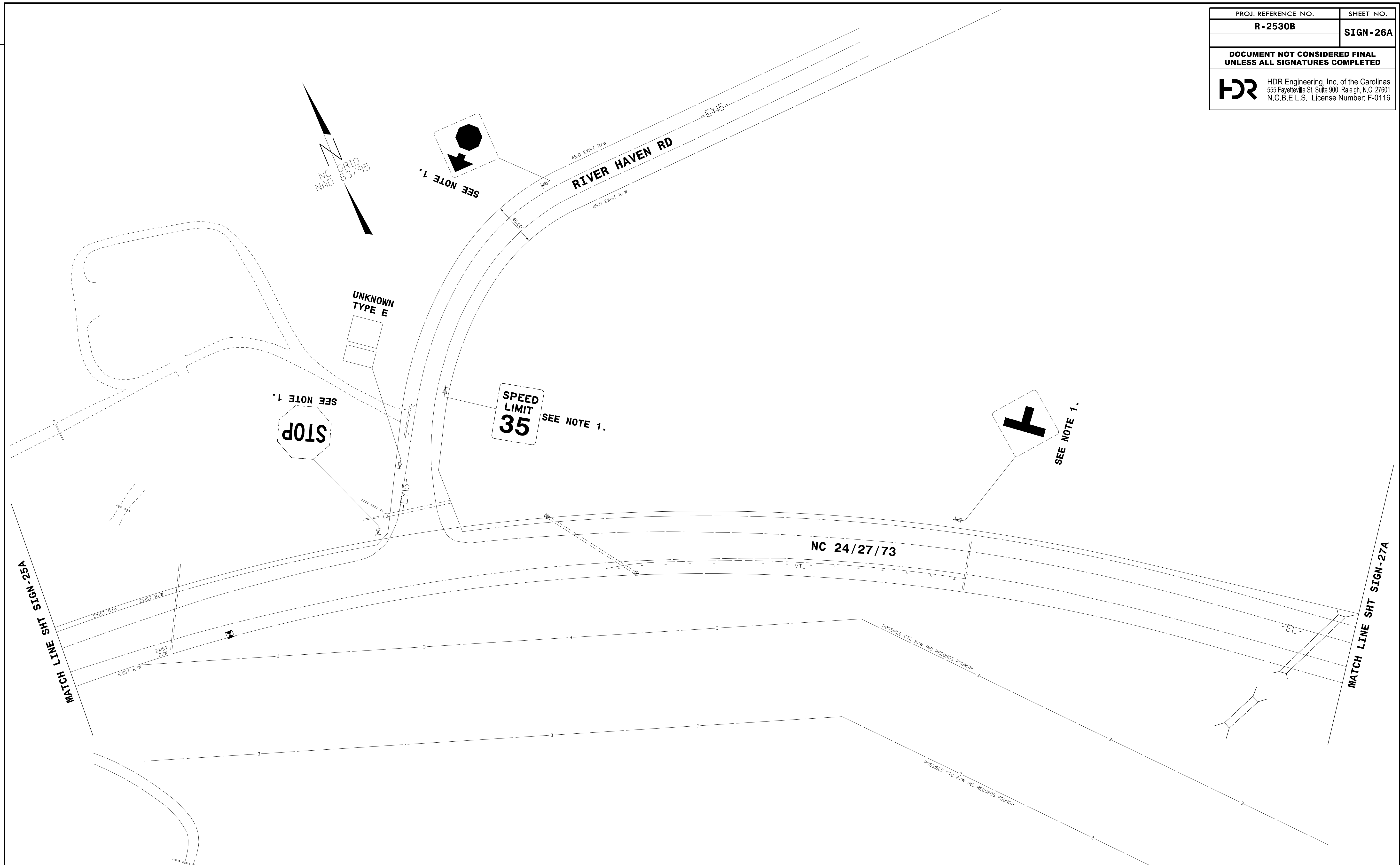

SCALE:	NTS		REVISIONS
DATE:	\$DATES		
DWG. BY:	K HECTOR		
DESIGN BY:	K HECTOR		
REVIEWED BY:	R KING		

PROJ. REFERENCE NO.	SHEET NO.
R-2530B	SIGN-26A
DOCUMENT NOT CONSIDERED FINAL UNLESS ALL SIGNATURES COMPLETED	
 HDR Engineering, Inc. of the Carolinas 555 Fayetteville St, Suite 900 Raleigh, N.C. 27601 N.C.B.E.L.S. License Number: F-0116	



REVISIONS

PLOT DRIVER: \$PLTDRV\$ PENTABLE: \$PENTBL\$
 USER: \$USER\$ DATE: \$DATE\$ TIME: \$TIME\$
 FILE: \$PWVARVAULTPATHDESIG\$ SCALE: \$SCALESHORT\$



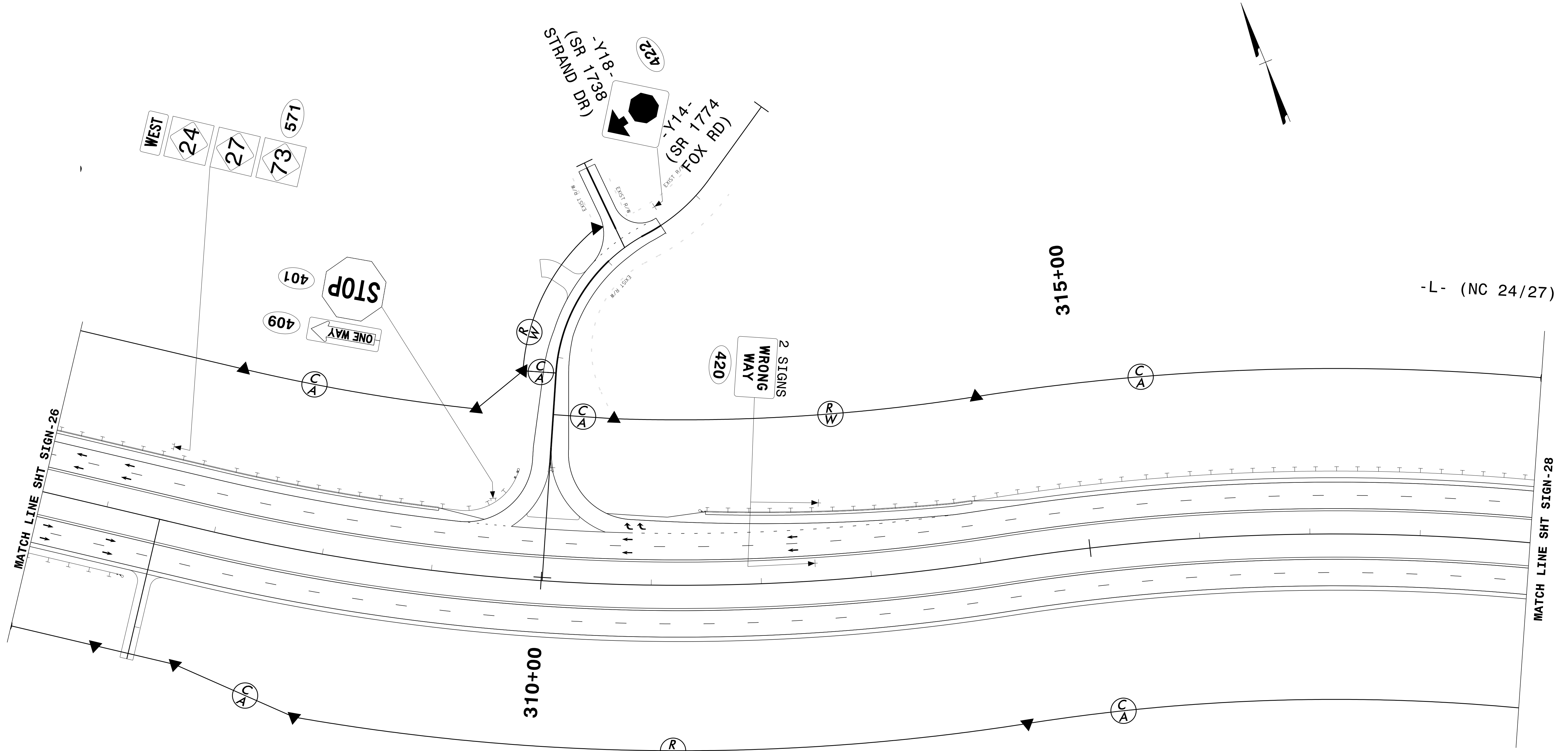

APPROVED: <i>Ron King</i> DATE: 12/13/2018		<h2 style="text-align: center;">EXISTING SIGN DETAIL</h2>		REVISIONS	
SCALE: NTS DATE: \$DATES\$ DWG. BY: K HECTOR DESIGN BY: K HECTOR REVIEWED BY: R KING					CADD FILE

PROJ. REFERENCE NO.	SHEET NO.
R-2530B	SIGN-27
DOCUMENT NOT CONSIDERED FINAL UNLESS ALL SIGNATURES COMPLETED	
 HDR Engineering, Inc. of the Carolinas 555 Fayetteville St, Suite 900 Raleigh, N.C. 27601 N.C.B.E.L.S. License Number: F-0116	



REVISIONS

PLOT DRIVER: \$PLTDVRS\$ PENTABLE: \$PENTBL\$
 USER: \$USER\$ DATE: \$DATE\$ TIME: \$TIME\$
 FILE: \$PWWARVAULTPATHDESIG\$ SCALE: \$SCALE\$ SHORTS

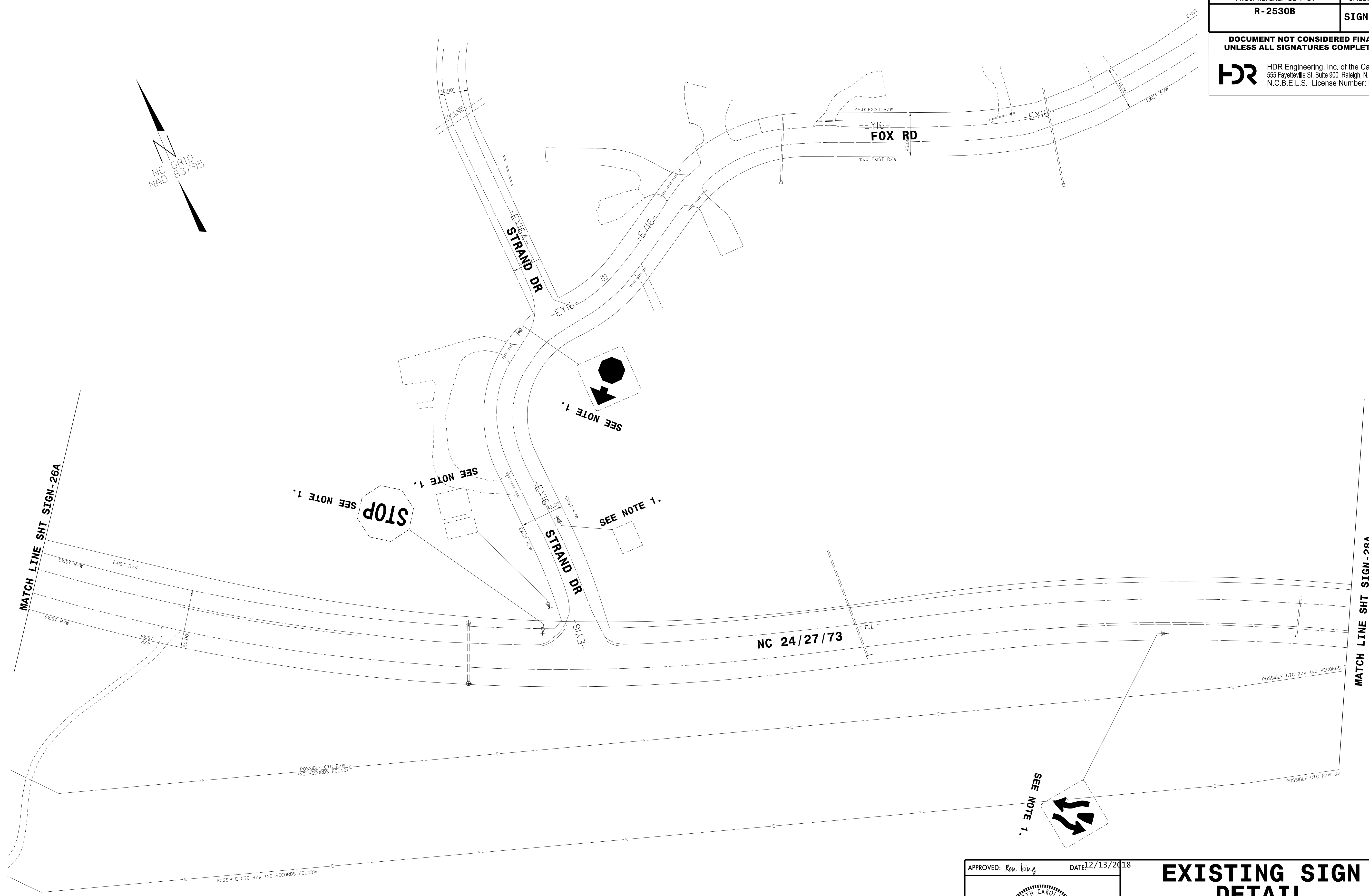

APPROVED: <i>Ron King</i> DATE: 12/13/2018		SIGN DETAIL															
<table border="1"> <tr> <td>SCALE: NTS</td> <td rowspan="4">  </td> <td colspan="2" rowspan="4"> <table border="1"> <tr><th colspan="2">REVISIONS</th></tr> <tr><td> </td><td> </td></tr> <tr><td> </td><td> </td></tr> <tr><td> </td><td> </td></tr> </table> </td> </tr> <tr> <td>DATE: \$DATES\$</td> </tr> <tr> <td>DWG. BY: K HECTOR</td> </tr> <tr> <td>DESIGN BY: K HECTOR</td> </tr> <tr> <td>REVIEWED BY: R KING</td> <td>CADD FILE</td> </tr> </table>		SCALE: NTS		<table border="1"> <tr><th colspan="2">REVISIONS</th></tr> <tr><td> </td><td> </td></tr> <tr><td> </td><td> </td></tr> <tr><td> </td><td> </td></tr> </table>		REVISIONS								DATE: \$DATES\$	DWG. BY: K HECTOR	DESIGN BY: K HECTOR	REVIEWED BY: R KING
SCALE: NTS		<table border="1"> <tr><th colspan="2">REVISIONS</th></tr> <tr><td> </td><td> </td></tr> <tr><td> </td><td> </td></tr> <tr><td> </td><td> </td></tr> </table>				REVISIONS											
REVISIONS																	
DATE: \$DATES\$																	
DWG. BY: K HECTOR																	
DESIGN BY: K HECTOR																	
REVIEWED BY: R KING	CADD FILE																

PROJ. REFERENCE NO.	SHEET NO.
R-2530B	SIGN-27A
DOCUMENT NOT CONSIDERED FINAL UNLESS ALL SIGNATURES COMPLETED	
 HDR Engineering, Inc. of the Carolinas 555 Fayetteville St, Suite 900 Raleigh, N.C. 27601 N.C.B.E.L.S. License Number: F-0116	



REVISIONS

PLOT DRIVER: \$PLTDVRS\$
 USER: \$USER\$
 FILE: \$PWVARVAULTPATHDESC\$
 PENTABLE: \$PENTBL\$
 TIME: \$TIME\$
 SCALE: \$SCALESHORT\$
 DATE: \$DATE\$

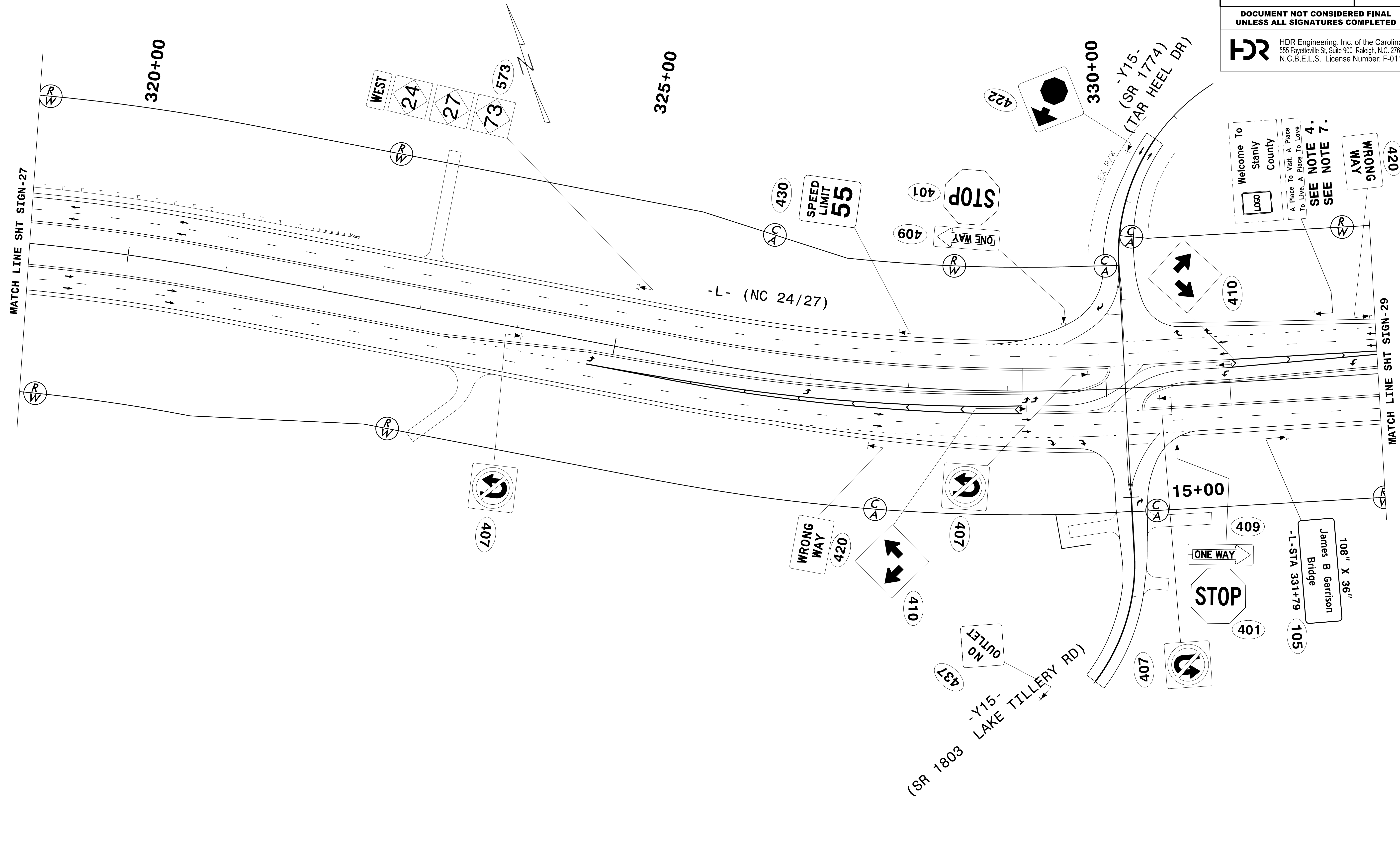

APPROVED: <i>Ron King</i>	DATE: 12/13/2018	<h2 style="text-align: center;">EXISTING SIGN DETAIL</h2>			REVISIONS
SCALE: NTS	DATE: \$DATES\$				
DESIGN BY: K HECTOR	REVIEWED BY: R KING				

PROJ. REFERENCE NO.	SHEET NO.
R-2530B	SIGN-28
DOCUMENT NOT CONSIDERED FINAL UNLESS ALL SIGNATURES COMPLETED	
 HDR Engineering, Inc. of the Carolinas 555 Fayetteville St, Suite 900 Raleigh, N.C. 27601 N.C.B.E.L.S. License Number: F-0116	



REVISIONS

PLOT DRIVER: \$PLTDRV\$ DATE: \$DATE\$ PENTABLE: \$PENTBL\$
 USER: \$USER\$ TIME: \$TIME\$ SCALE: \$SCALE\$
 FILE: \$PWVARVAULTPATHDESIG\$

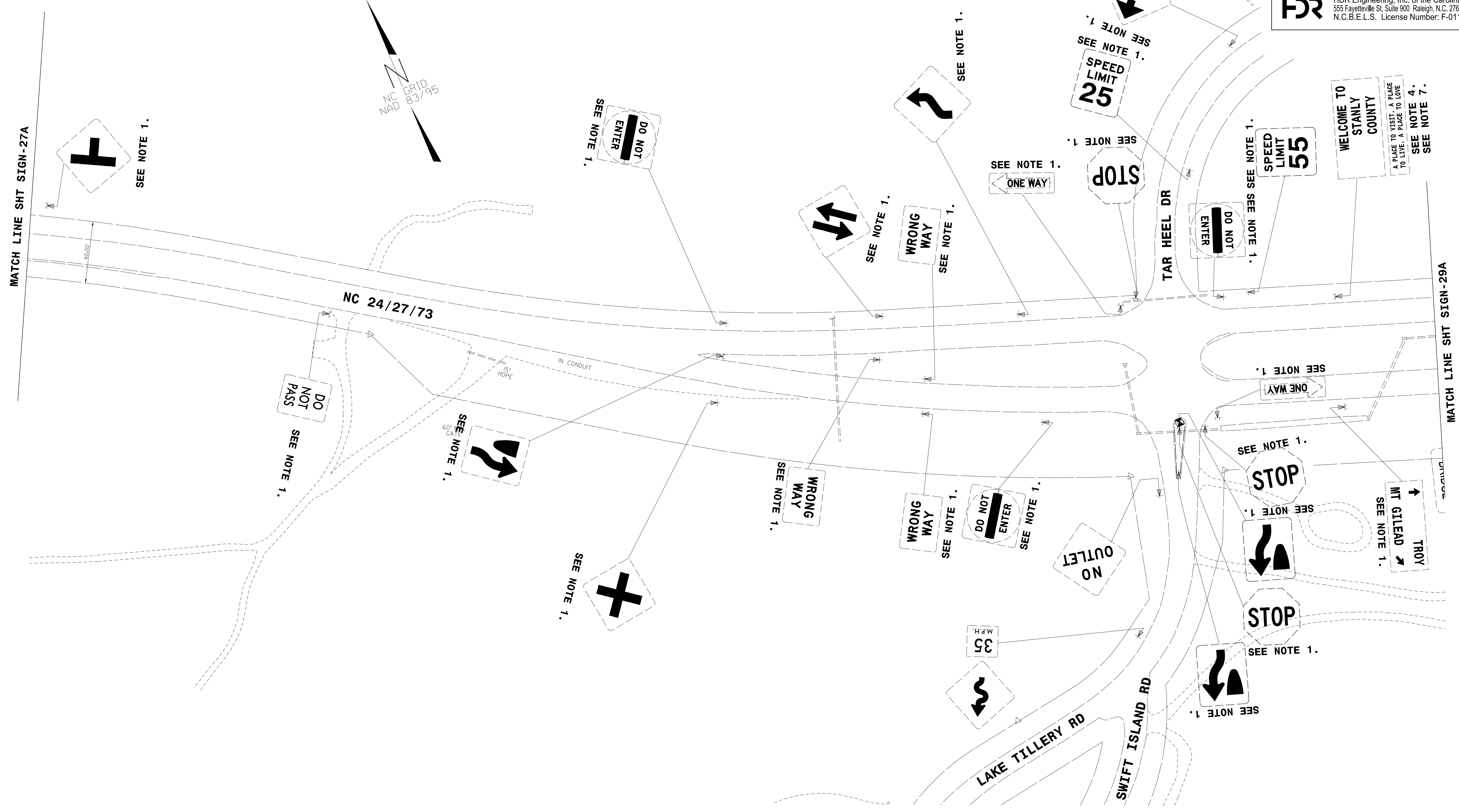

APPROVED: <i>Ron King</i>	DATE: 12/13/2018	<h1>SIGN DETAIL</h1>								
										
SCALE: NTS	DATE: \$DATES\$	<table border="1"> <thead> <tr> <th colspan="2">REVISIONS</th> </tr> </thead> <tbody> <tr><td> </td><td> </td></tr> <tr><td> </td><td> </td></tr> <tr><td> </td><td> </td></tr> </tbody> </table>	REVISIONS							
REVISIONS										
DWG. BY: K HECTOR	DESIGN BY: K HECTOR									
REVIEWED BY: R KING										
										

PROJ. REFERENCE NO.	SHEET NO.
R-2530B	SIGN-28A
DOCUMENT NOT CONSIDERED FINAL UNLESS ALL SIGNATURES COMPLETED	
 HDR Engineering, Inc. of the Carolinas 555 Fayetteville St, Suite 900 Raleigh, N.C. 27601 N.C.B.E.L.S. License Number: F-0116	



REVISIONS

PLOT DRIVER: \$PLTDRV\$ PENTABLE: \$PENTBL\$
 USER: \$USER\$ DATE: \$DATE\$ TIME: \$TIME\$ SCALE: \$SCALE\$
 FILE: \$PWVAVVAULTPATHDESIG\$

APPROVED: <i>Ron King</i> DATE: 12/13/2018		EXISTING SIGN DETAIL						
SCALE: NTS DATE: \$DATES\$ DWG. BY: K HECTOR DESIGN BY: K HECTOR REVIEWED BY: R KING			REVISIONS <table border="1"> <tr><td> </td><td> </td></tr> <tr><td> </td><td> </td></tr> <tr><td> </td><td> </td></tr> </table>					

PLOT DRIVER: pdfplotter
USER: KHECTOR
FILE: NCDOT\2015.NCDOT_TMSD.Limited.Services.Contract.M.7000016704.NCDOT-R2530B.B4974.T03.c.6.0.CAD.BTM.6.2.Work.In.Progress.Traffic.Signing.CADD.Signing.Layout.Plans\U2530B.Signing.Sht.25.dgn
PENTABLE: NCDOT_Signing.tbl
DATE: 12/12/18
TIME: 08:55:38
SCALE: 1:48.3408

REVISIONS

PROJ. REFERENCE NO.	SHEET NO.
R-2530B	SIGN-29
DOCUMENT NOT CONSIDERED FINAL UNLESS ALL SIGNATURES COMPLETED	
 HDR Engineering, Inc. of the Carolinas 555 Fayetteville St, Suite 900 Raleigh, N.C. 27601 N.C.B.E.L.S. License Number: F-0116	

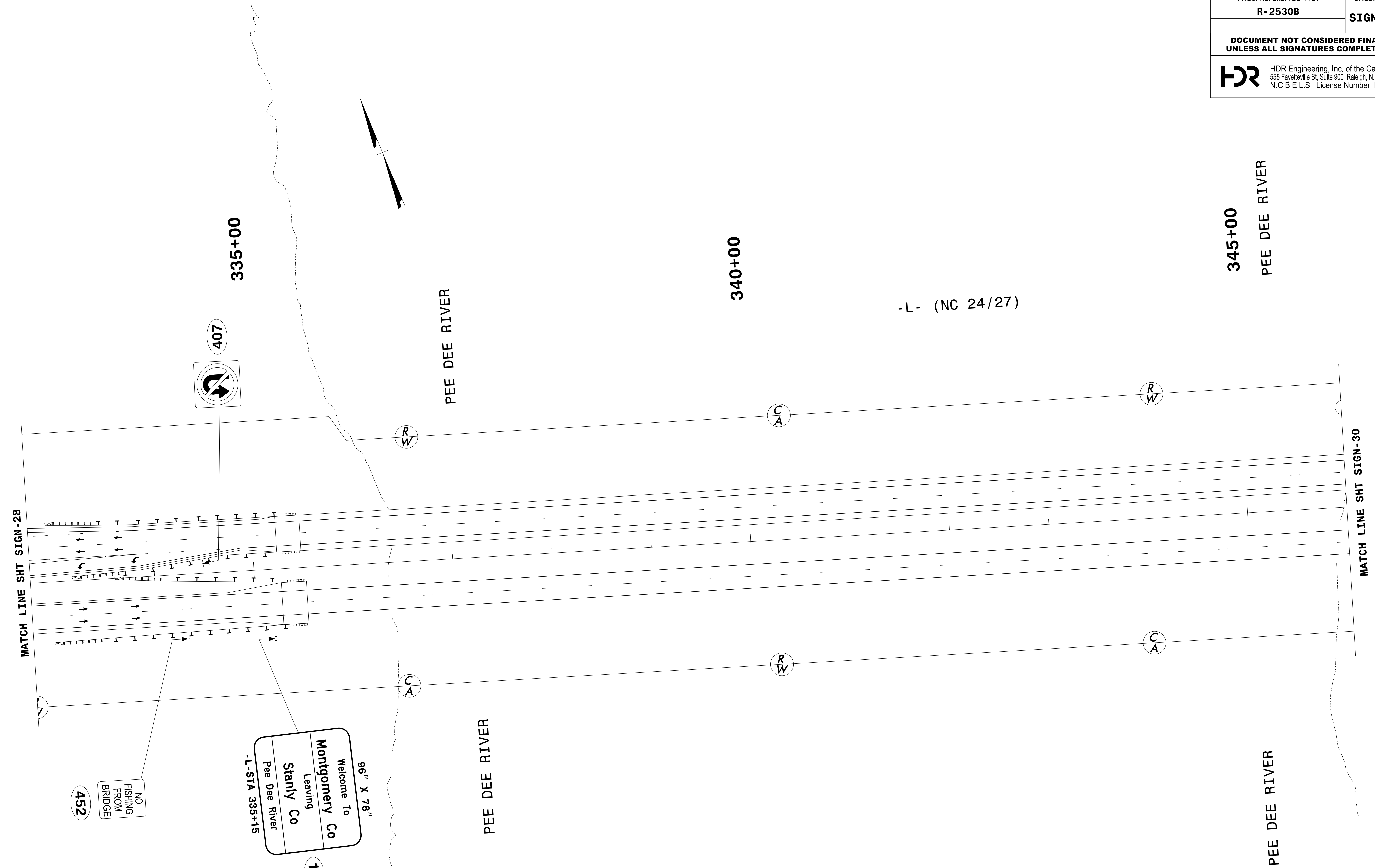

APPROVED: <i>Ron King</i>	DATE: 12/13/2018	<h1>SIGN DETAIL</h1>										
	SCALE: NTS											
	DATE: 12/12/18											
	DWG. BY: K HECTOR											
DESIGN BY: K HECTOR	REVIEWED BY: R KING	<table border="1"> <tr> <th colspan="2">REVISIONS</th> </tr> <tr> <td> </td> <td> </td> </tr> <tr> <td> </td> <td> </td> </tr> <tr> <td> </td> <td> </td> </tr> <tr> <td>CADD FILE</td> <td> </td> </tr> </table>	REVISIONS								CADD FILE	
REVISIONS												
CADD FILE												

PROJ. REFERENCE NO.	SHEET NO.
R-2530B	SIGN-29A
DOCUMENT NOT CONSIDERED FINAL UNLESS ALL SIGNATURES COMPLETED	
 HDR Engineering, Inc. of the Carolinas 555 Fayetteville St, Suite 900 Raleigh, N.C. 27601 N.C.B.E.L.S. License Number: F-0116	



PLOT DRIVER: pdfplotter
 USER: KHECTOR
 FILE: NCDOT\2015.NCDOT_TMSD.Limited.Ser.Vices.Contract.M.7000016704\NCDOT-R2530B.B4974_103.c_.\6.0.CAD.BTM\6.2.Work.In.Progress\Traffic\Signing\CADD\Signing_Layout_Plans\U2530B_Signing_Sht_EX25.dgn

PENTABLE: NCDOT_Signing.tbl
 TIME: 16:42:50
 SCALE: 1:48.3408

DATE: 12/05/18
 USER: KHECTOR
 FILE: NCDOT\2015.NCDOT_TMSD.Limited.Ser.Vices.Contract.M.7000016704\NCDOT-R2530B.B4974_103.c_.\6.0.CAD.BTM\6.2.Work.In.Progress\Traffic\Signing\CADD\Signing_Layout_Plans\U2530B_Signing_Sht_EX25.dgn

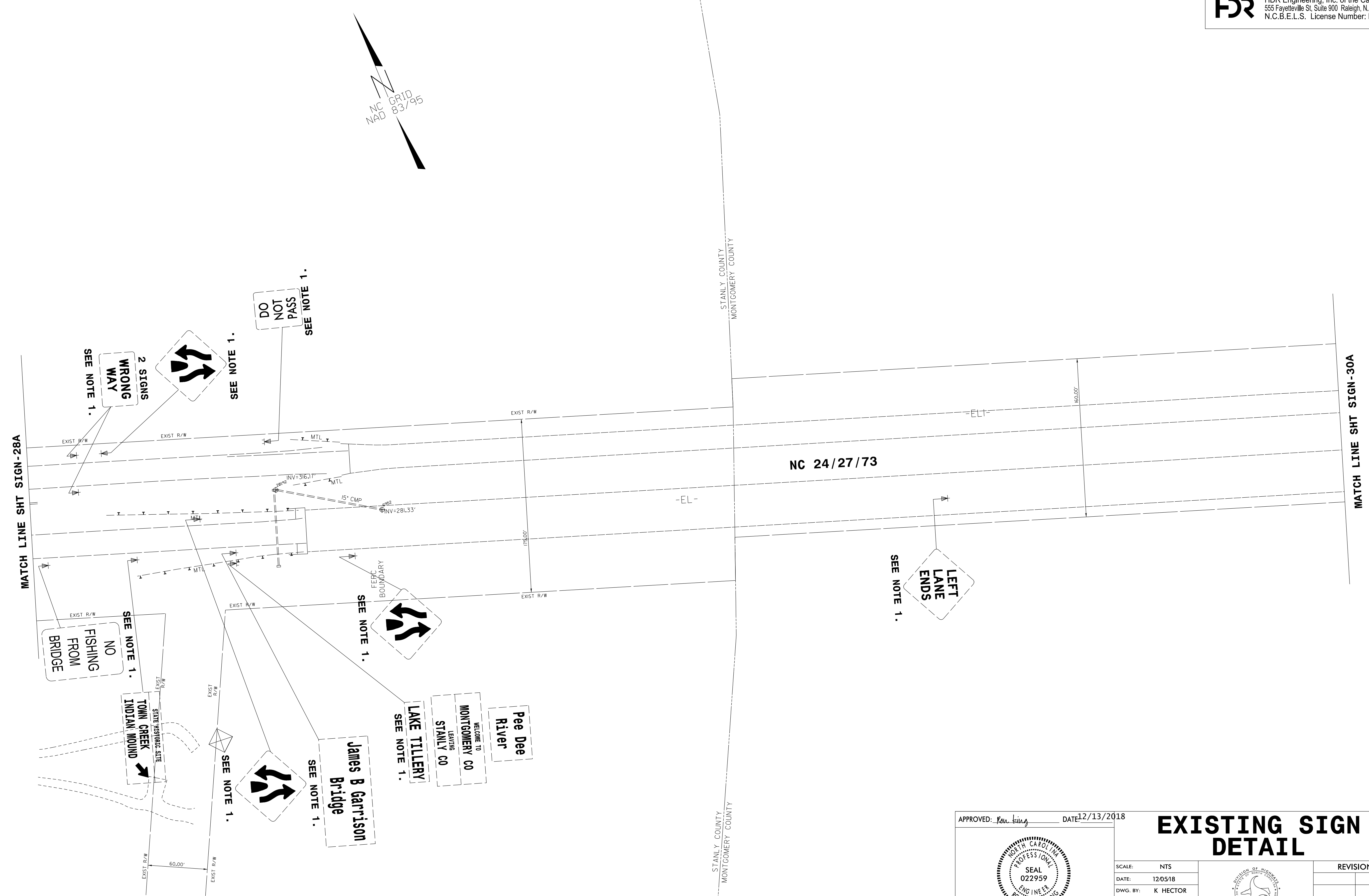
REVISIONS



APPROVED: <i>Ron King</i>	DATE: 12/13/2018	<h2 style="text-align: center;">EXISTING SIGN DETAIL</h2>			REVISIONS
SCALE: NTS	DATE: 12/05/18				
DESIGN BY: K HECTOR	REVIEWED BY: R KING				CADD FILE

PROJ. REFERENCE NO.	SHEET NO.
R-2530B	SIGN-30
DOCUMENT NOT CONSIDERED FINAL UNLESS ALL SIGNATURES COMPLETED	
 HDR Engineering, Inc. of the Carolinas 555 Fayetteville St, Suite 900 Raleigh, N.C. 27601 N.C.B.E.L.S. License Number: F-0116	

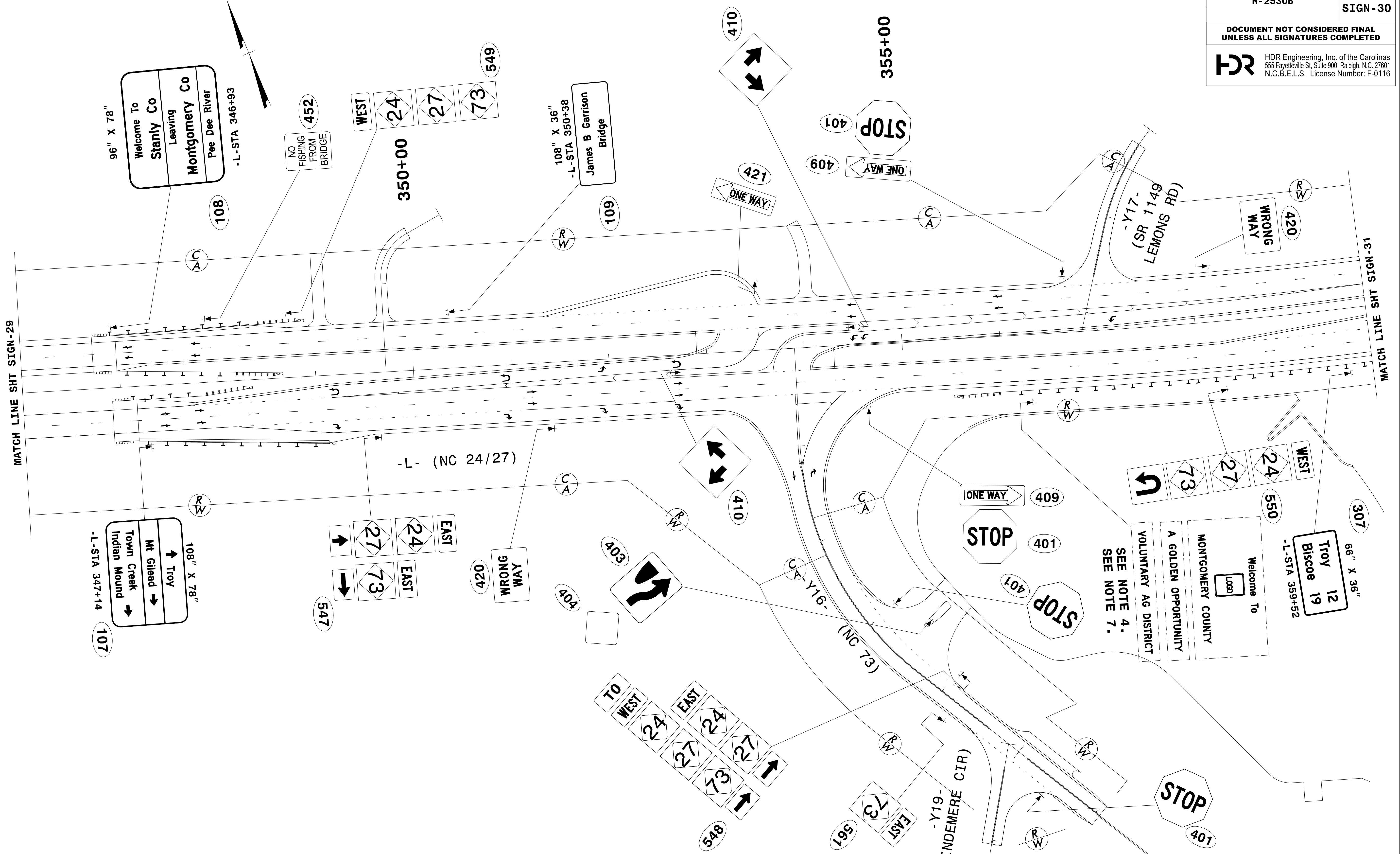

MATCH LINE SHT SIGN-29

MATCH LINE SHT SIGN-31

PLOT DRIVER: pdfplotter
 USER: KHECTOR
 FILE: NCDOT\2015.NCDOT_TMSD.Limited_Services.Contract.M.7000016704.NCDOT-R2530B.B4974.103.c.16.0.CAD.BTM.6.2.Work.In_Progress.Traffic.Signing.CADD.Signing_Layout_Plans\U2530B_Signing_Sht_26.dgn

PENTABLE: NCDOT_Signing.tbl
 TIME: 08:53:13
 SCALE: 1:48.3408

DATE: 12/12/18
 USER: KHECTOR
 FILE: NCDOT\2015.NCDOT_TMSD.Limited_Services.Contract.M.7000016704.NCDOT-R2530B.B4974.103.c.16.0.CAD.BTM.6.2.Work.In_Progress.Traffic.Signing_Layout_Plans\U2530B_Signing_Sht_26.dgn

REVISIONS

APPROVED: *Ronald W. King* DATE: 12/13/2018

SCALE:	NTS
DATE:	12/12/18
DWG. BY:	K HECTOR
DESIGN BY:	K HECTOR
REVIEWED BY:	R KING

REVISIONS	

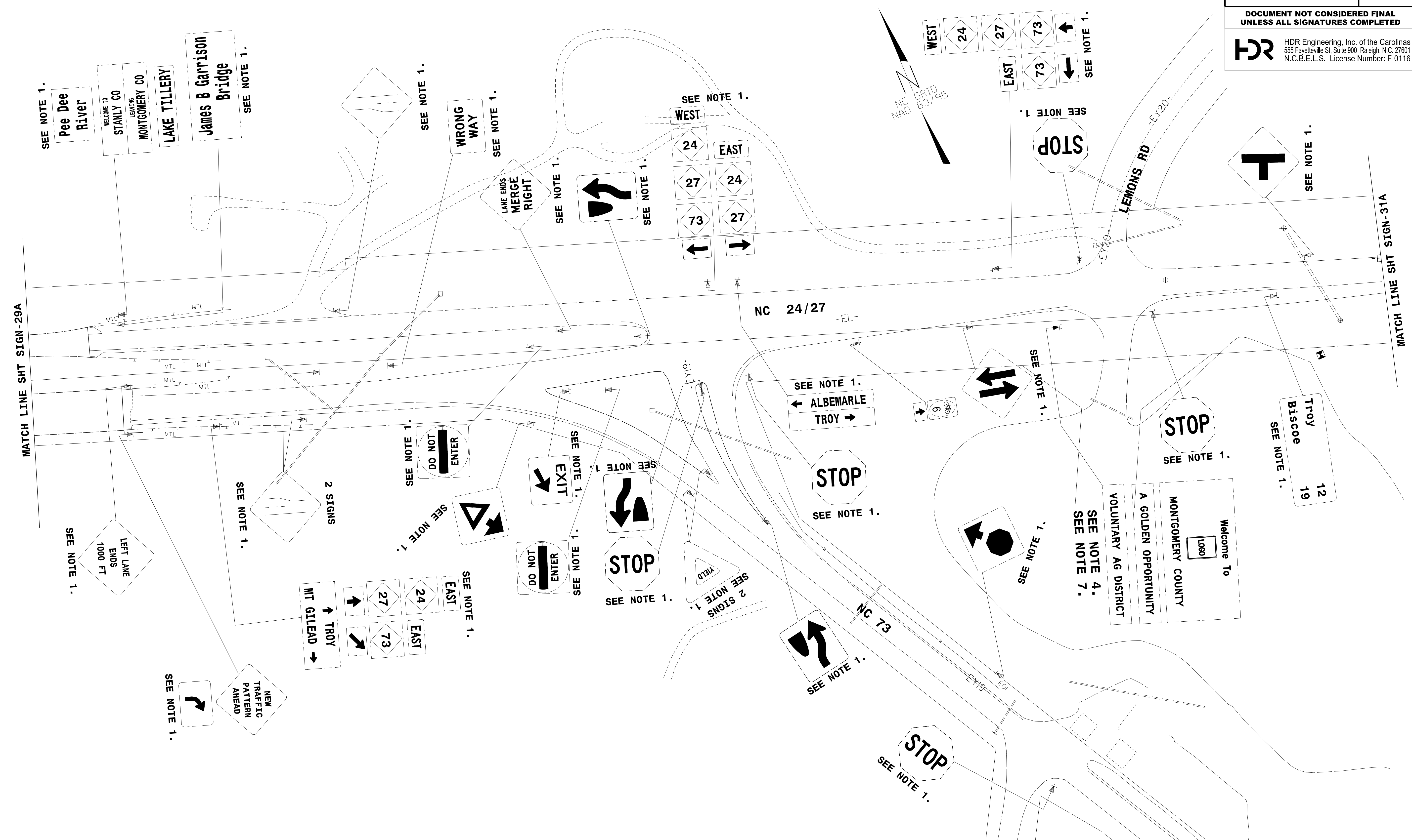

SIGN DETAIL

PROJ. REFERENCE NO.	SHEET NO.
R-2530B	SIGN-30A
DOCUMENT NOT CONSIDERED FINAL UNLESS ALL SIGNATURES COMPLETED	
 HDR Engineering, Inc. of the Carolinas 555 Fayetteville St, Suite 900 Raleigh, N.C. 27601 N.C.B.E.L.S. License Number: F-0116	



REVISIONS

PLOT DRIVER: \$PLTDRV\$
 USER: \$USER\$
 FILE: \$PWVARVAULTPATHDESIG\$
 PENTABLE: \$PENTBL\$
 TIME: \$TIME\$
 SCALE: \$SCALESHT\$
 DATE: \$DATE\$

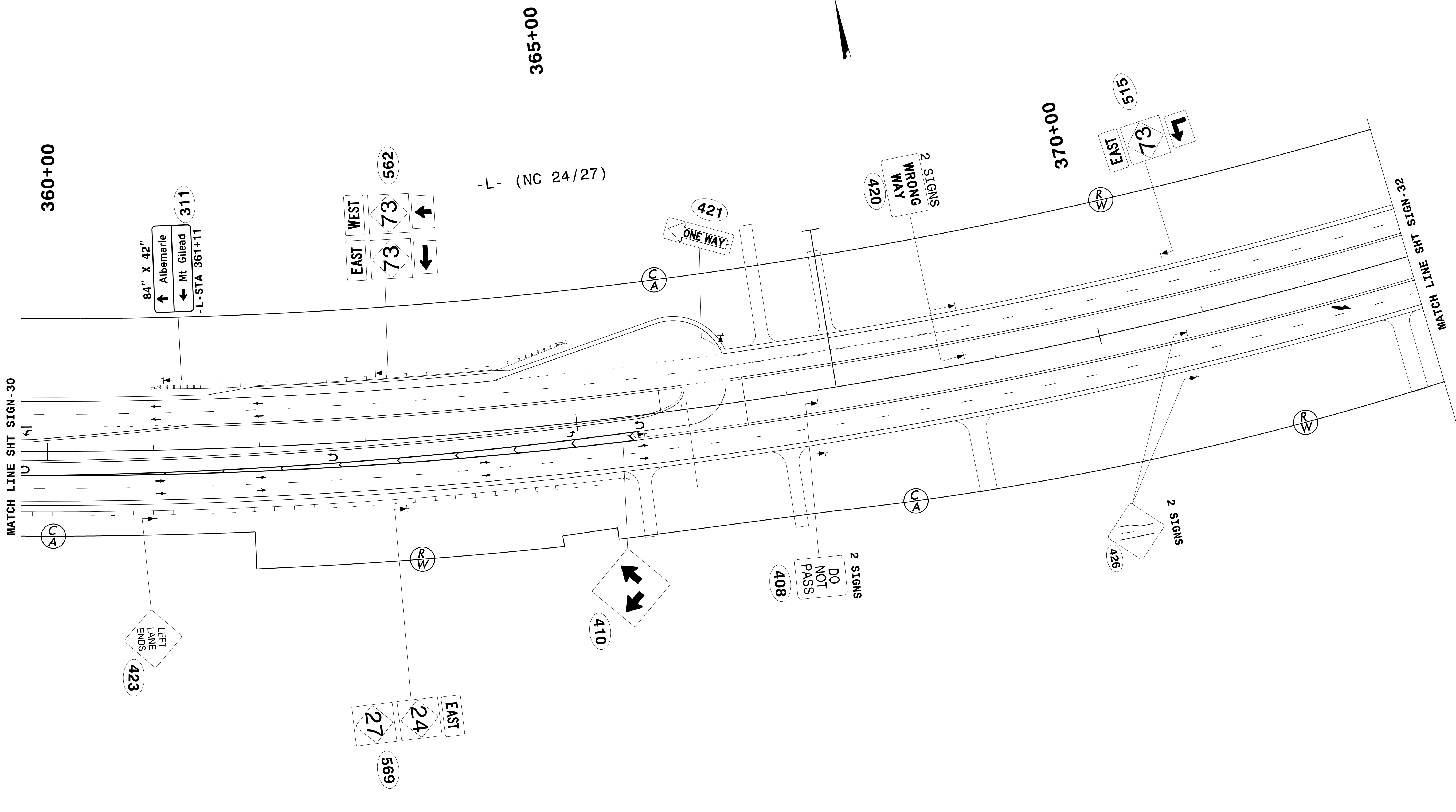

APPROVED: <i>Ronald W. King</i> DATE: 12/13/2018			<h2 style="text-align: center;">EXISTING SIGN DETAIL</h2>							
SCALE: NTS	DATE: \$DATES\$					REVISIONS				
DWG. BY: K HECTOR	DESIGN BY: K HECTOR	<table border="1"> <tr><td> </td><td> </td></tr> <tr><td> </td><td> </td></tr> <tr><td> </td><td> </td></tr> </table>								
REVIEWED BY: R KING		<table border="1"> <tr><td>CADD FILE</td><td> </td></tr> </table>		CADD FILE						
CADD FILE										

PROJ. REFERENCE NO.	SHEET NO.
R-2530B	SIGN-31
DOCUMENT NOT CONSIDERED FINAL UNLESS ALL SIGNATURES COMPLETED	
 HDR Engineering, Inc. of the Carolinas 555 Fayetteville St, Suite 900 Raleigh, N.C. 27601 N.C.B.E.L.S. License Number: F-0116	



REVISIONS

PLOT DRIVER: \$PLTDRV\$ PENTABLE: \$PENTBL\$
 USER: \$USER\$ TIME: \$TIME\$ SCALE: \$SCALES\$
 DATE: \$DATE\$ FILE: \$PWVAVVAULTPATHDESIG\$

APPROVED: <i>Ron King</i> DATE: 12/13/2018		SIGN DETAIL						
SCALE: NTS DATE: \$DATES\$ DWG. BY: K HECTOR DESIGN BY: K HECTOR REVIEWED BY: R KING			REVISIONS <table border="1"> <tr><td> </td><td> </td></tr> <tr><td> </td><td> </td></tr> <tr><td> </td><td> </td></tr> </table>					

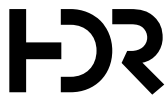
PROJ. REFERENCE NO.	SHEET NO.
R-2530B	SIGN-31A
DOCUMENT NOT CONSIDERED FINAL UNLESS ALL SIGNATURES COMPLETED	
 HDR Engineering, Inc. of the Carolinas 555 Fayetteville St, Suite 900 Raleigh, N.C. 27601 N.C.B.E.L.S. License Number: F-0116	

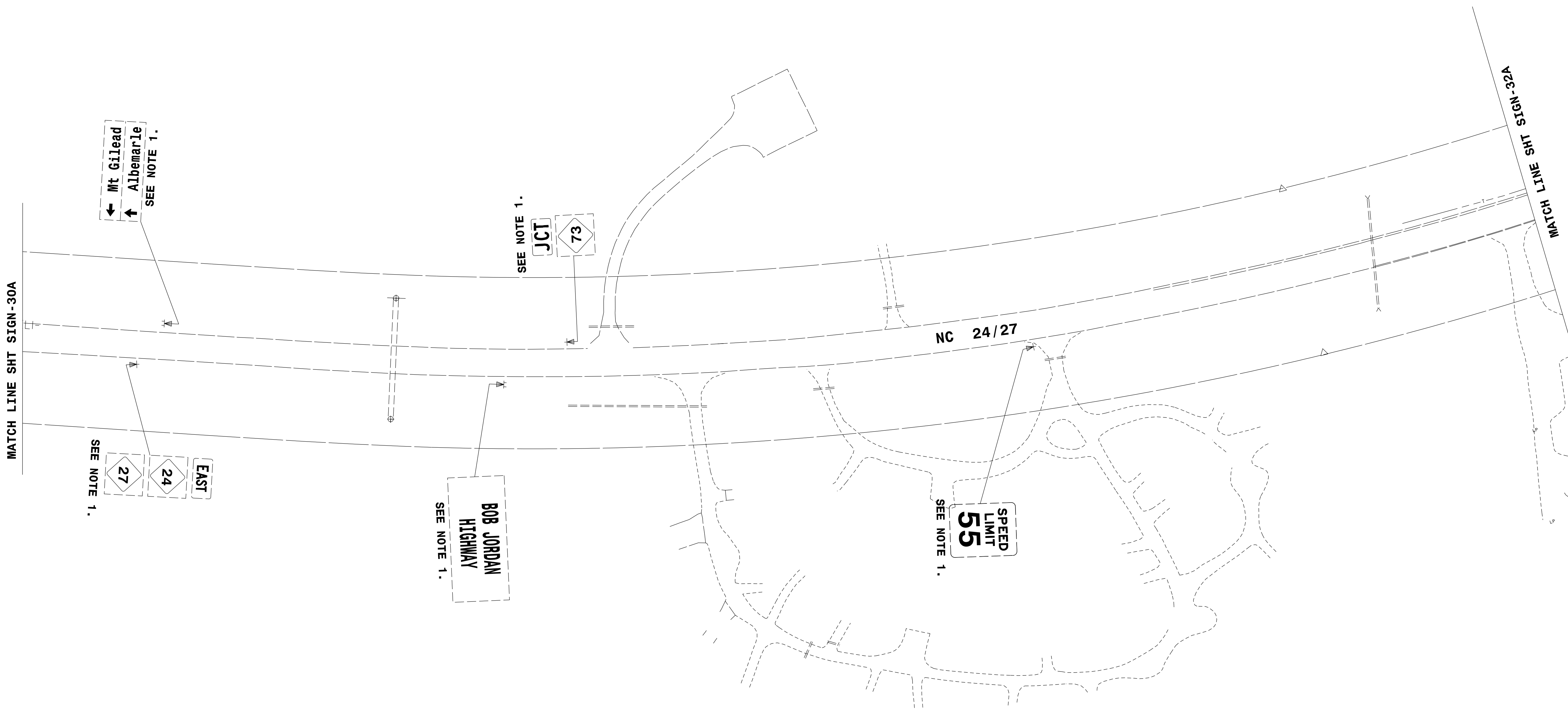
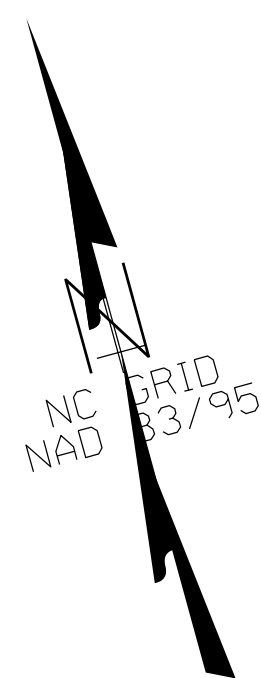

← Mt Gilead
 ↑ Albemarle
 SEE NOTE 1.

SEE NOTE 1.
 JCT
 73

NC 24/27

SEE NOTE 1.
 SPEED
 LIMIT
 55

SEE NOTE 1.
 BOB JORDAN
 HIGHWAY

SEE NOTE 1.
 27
 24
 EAST

MATCH LINE SHT SIGN-30A

MATCH LINE SHT SIGN-32A

REVISIONS

PLOT DRIVER: pdfplotter
 USER: KHECTOR
 FILE: NCDOT\2015.NCDOT_TMSD.Limited.Services.Contract.M.7000016704\NCDOT-R2530B.B4974.103.c.\6.0.CAD.BTM\6.2.Work.In.Progress\Traffic\Signing\CADD\Signing_Layout_Plans\U2530B_Signing_Sht_EX27.dgn
 PENTABLE: NCDOT_Signing.tbl
 TIME: 13:53:55
 DATE: 12/12/18
 SCALE: 1:48.3408

APPROVED: *Ron King* DATE: 12/13/2018



EXISTING SIGN DETAIL

SCALE:	NTS
DATE:	12/12/18
DESIGN BY:	K HECTOR
REVIEWED BY:	R KING

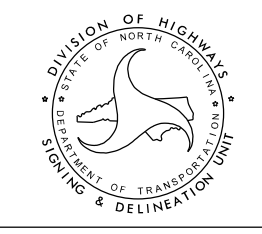

REVISIONS	



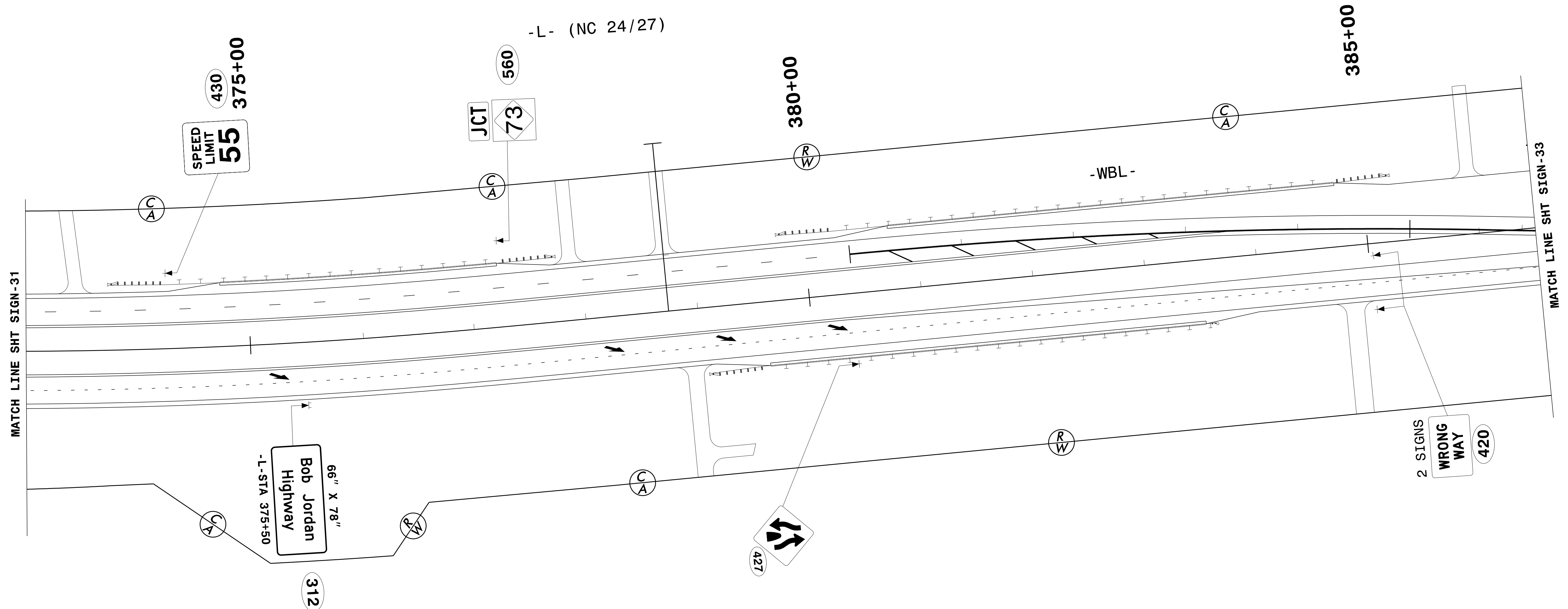
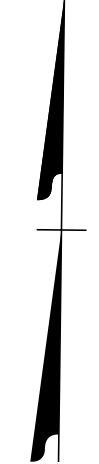

CADD FILE

PROJ. REFERENCE NO.	SHEET NO.
R-2530B	SIGN-32
DOCUMENT NOT CONSIDERED FINAL UNLESS ALL SIGNATURES COMPLETED	
 HDR Engineering, Inc. of the Carolinas 555 Fayetteville St, Suite 900 Raleigh, N.C. 27601 N.C.B.E.L.S. License Number: F-0116	



REVISIONS

PLOT DRIVER: \$PLTDRV\$ DATE: \$DATE\$ SCALE: \$SCALE\$ SHORTS: \$SHORTS\$
 USER: \$USER\$ TIME: \$TIME\$
 FILE: \$PWVARVAULTPATHDESIG\$

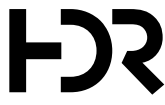

APPROVED: <i>Ron King</i> DATE: 12/13/2018		SIGN DETAIL																
<table border="1"> <tr> <td>SCALE: NTS</td> <td rowspan="4">  </td> <td colspan="2" rowspan="4"> <table border="1"> <tr> <th colspan="2">REVISIONS</th> </tr> <tr> <td> </td> <td> </td> </tr> <tr> <td> </td> <td> </td> </tr> <tr> <td> </td> <td> </td> </tr> </table> </td> </tr> <tr> <td>DATE: \$DATES\$</td> <td>DWG. BY: K HECTOR</td> </tr> <tr> <td>DESIGN BY: K HECTOR</td> <td>REVIEWED BY: R KING</td> </tr> <tr> <td>CADD FILE</td> <td> </td> </tr> </table>		SCALE: NTS		<table border="1"> <tr> <th colspan="2">REVISIONS</th> </tr> <tr> <td> </td> <td> </td> </tr> <tr> <td> </td> <td> </td> </tr> <tr> <td> </td> <td> </td> </tr> </table>		REVISIONS								DATE: \$DATES\$	DWG. BY: K HECTOR	DESIGN BY: K HECTOR	REVIEWED BY: R KING	CADD FILE
SCALE: NTS		<table border="1"> <tr> <th colspan="2">REVISIONS</th> </tr> <tr> <td> </td> <td> </td> </tr> <tr> <td> </td> <td> </td> </tr> <tr> <td> </td> <td> </td> </tr> </table>				REVISIONS												
REVISIONS																		
DATE: \$DATES\$	DWG. BY: K HECTOR																	
DESIGN BY: K HECTOR	REVIEWED BY: R KING																	
CADD FILE																		

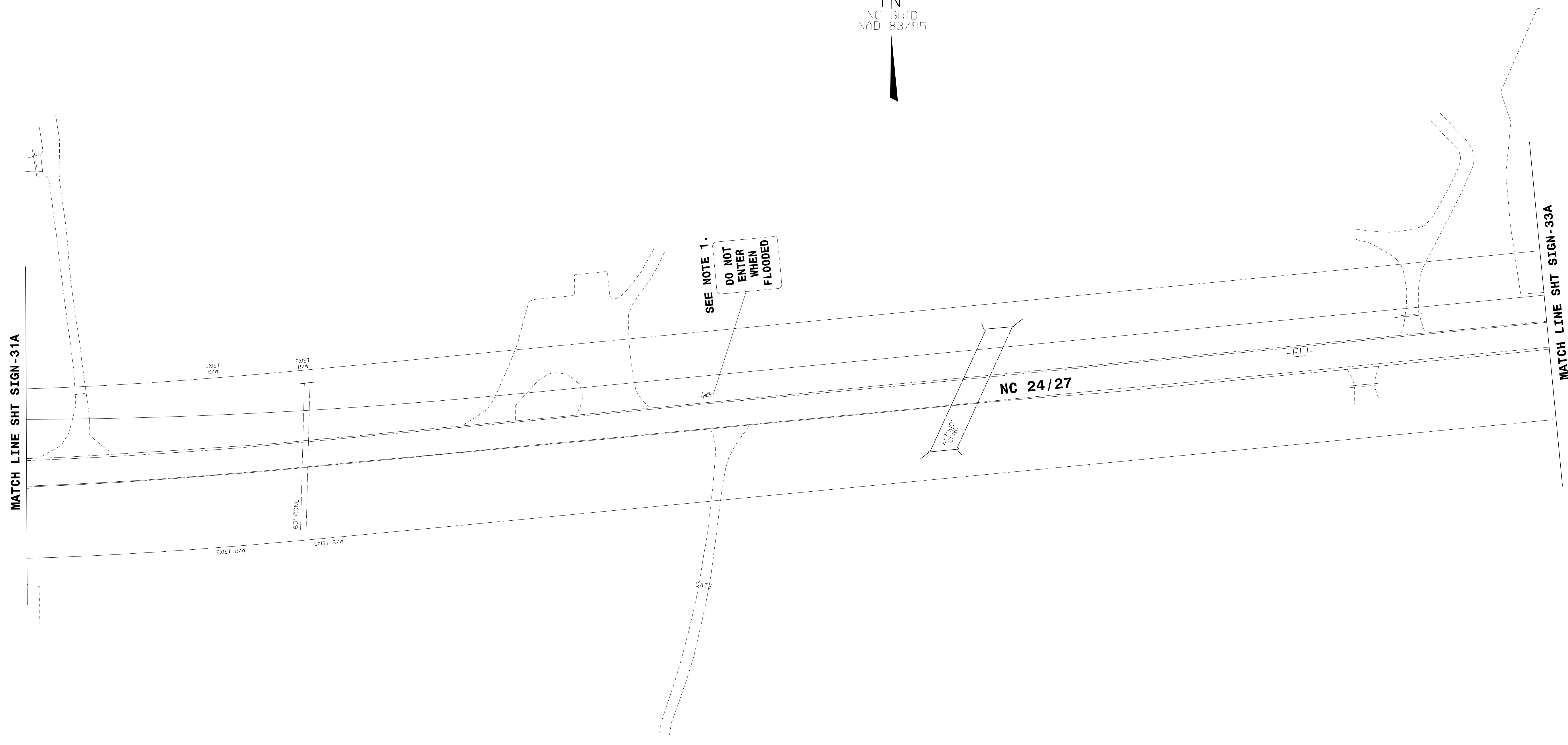
PROJ. REFERENCE NO.	SHEET NO.
R-2530B	SIGN-32A
DOCUMENT NOT CONSIDERED FINAL UNLESS ALL SIGNATURES COMPLETED	
 HDR Engineering, Inc. of the Carolinas 555 Fayetteville St, Suite 900 Raleigh, N.C. 27601 N.C.B.E.L.S. License Number: F-0116	



REVISIONS

PLOT DRIVER: \$PLTDVRS\$ PENTABLE: \$PENTBL\$
 USER: \$USER\$ DATE: \$DATE\$ SCALE: \$SCALE\$
 TIME: \$TIME\$ FILE: \$PWVARVAULTPATHDESIG\$

APPROVED: <i>Ron King</i> DATE: 12/13/2018			<table border="1"> <tr><th>REVISIONS</th></tr> <tr><td> </td></tr> <tr><td> </td></tr> <tr><td> </td></tr> <tr><td> </td></tr> </table>	REVISIONS							
REVISIONS											
<table border="1"> <tr><td>SCALE:</td><td>NTS</td></tr> <tr><td>DATE:</td><td>\$DATES</td></tr> <tr><td>DWG. BY:</td><td>K HECTOR</td></tr> <tr><td>DESIGN BY:</td><td>K HECTOR</td></tr> <tr><td>REVIEWED BY:</td><td>R KING</td></tr> </table>	SCALE:	NTS	DATE:	\$DATES	DWG. BY:	K HECTOR	DESIGN BY:	K HECTOR	REVIEWED BY:	R KING	CADD FILE
SCALE:	NTS										
DATE:	\$DATES										
DWG. BY:	K HECTOR										
DESIGN BY:	K HECTOR										
REVIEWED BY:	R KING										

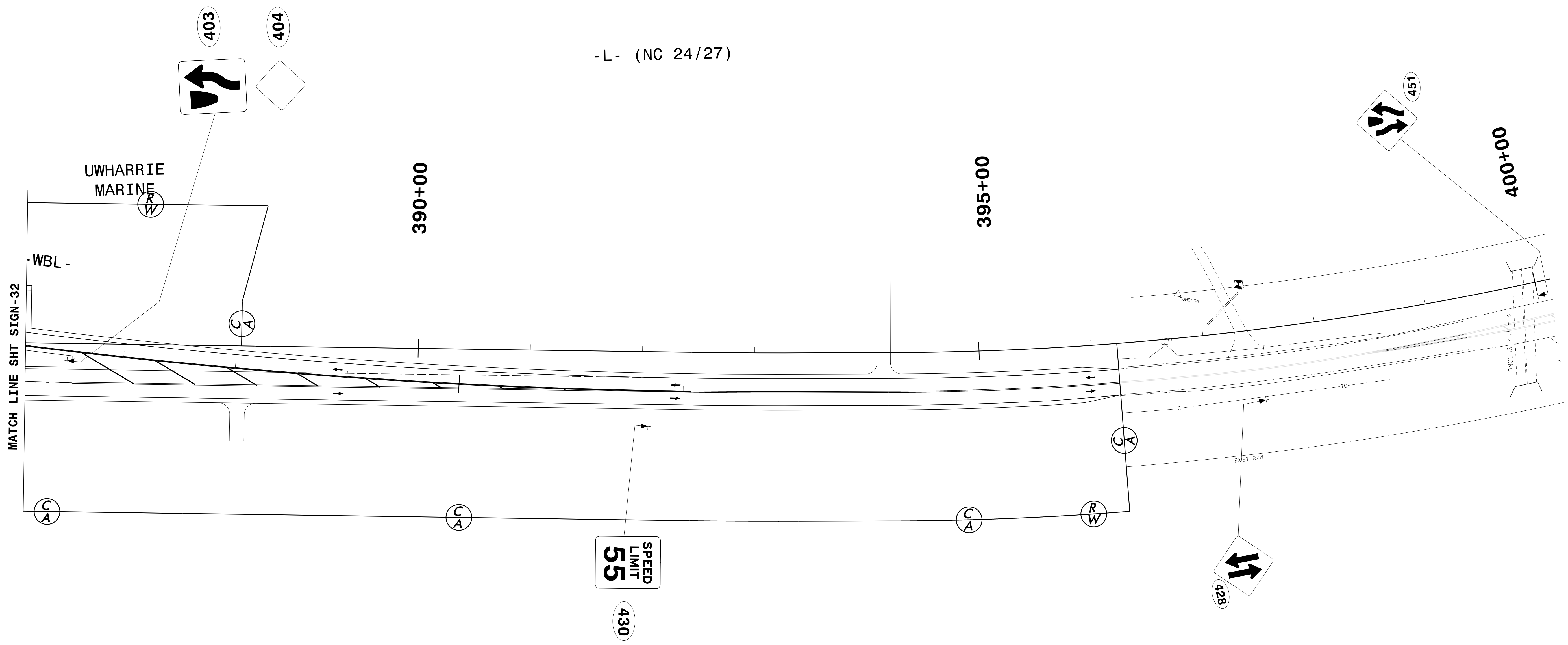
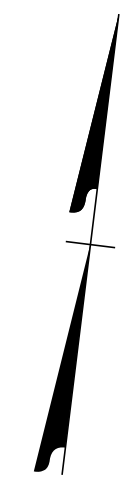

EXISTING SIGN DETAIL

PROJ. REFERENCE NO.	SHEET NO.
R-2530B	SIGN - 33
DOCUMENT NOT CONSIDERED FINAL UNLESS ALL SIGNATURES COMPLETED	
 HDR Engineering, Inc. of the Carolinas 555 Fayetteville St, Suite 900 Raleigh, N.C. 27601 N.C.B.E.L.S. License Number: F-0116	



REVISIONS

PLOT DRIVER: \$PLTDVRS\$ PENTABLE: \$PENTBL\$ SCALE: \$SCALESHT\$
 USER: \$USER\$ DATE: \$DATE\$ TIME: \$TIME\$
 FILE: \$PWVAVULTPATHDESC\$

APPROVED: <i>Ron King</i>	DATE: 12/13/2018	SIGN DETAIL	
			
SCALE: NTS	DATE: \$DATES\$		REVISIONS
DWG. BY: K HECTOR	DESIGN BY: K HECTOR		
REVIEWED BY: R KING			

PROJ. REFERENCE NO.	SHEET NO.
R-2530B	SIGN-33A
DOCUMENT NOT CONSIDERED FINAL UNLESS ALL SIGNATURES COMPLETED	
 HDR Engineering, Inc. of the Carolinas 555 Fayetteville St, Suite 900 Raleigh, N.C. 27601 N.C.B.E.L.S. License Number: F-0116	

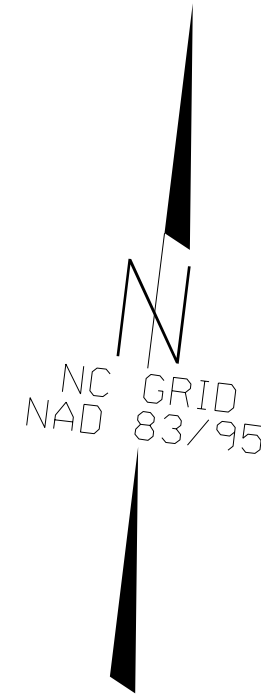

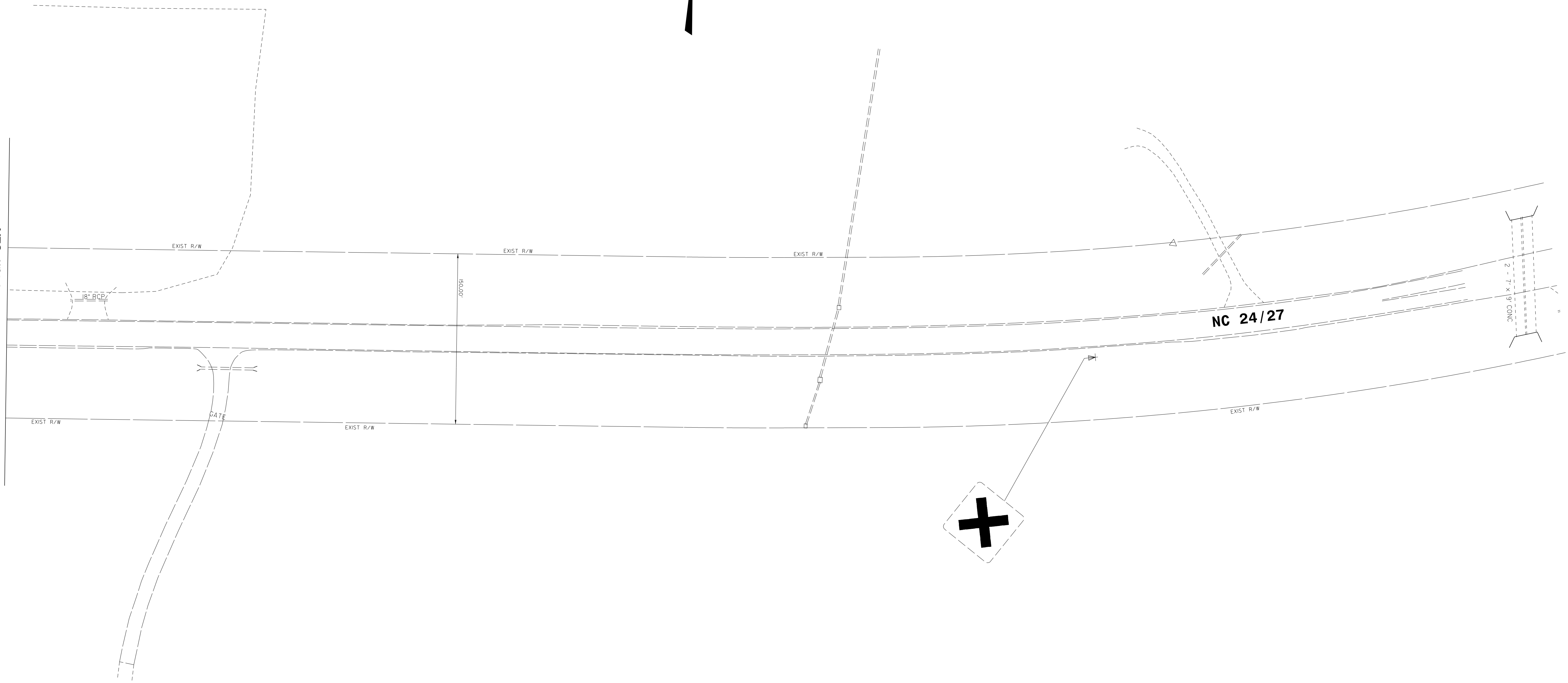

MATCH LINE SHT SIGN-32A



REVISIONS

PLOT DRIVER: \$PLTDRV\$ PENTABLE: \$PENTBL\$
 USER: \$USER\$ DATE: \$DATE\$ TIME: \$TIME\$ SCALE: \$SCALE\$
 FILE: \$PWVARVAULTPATHDESC\$

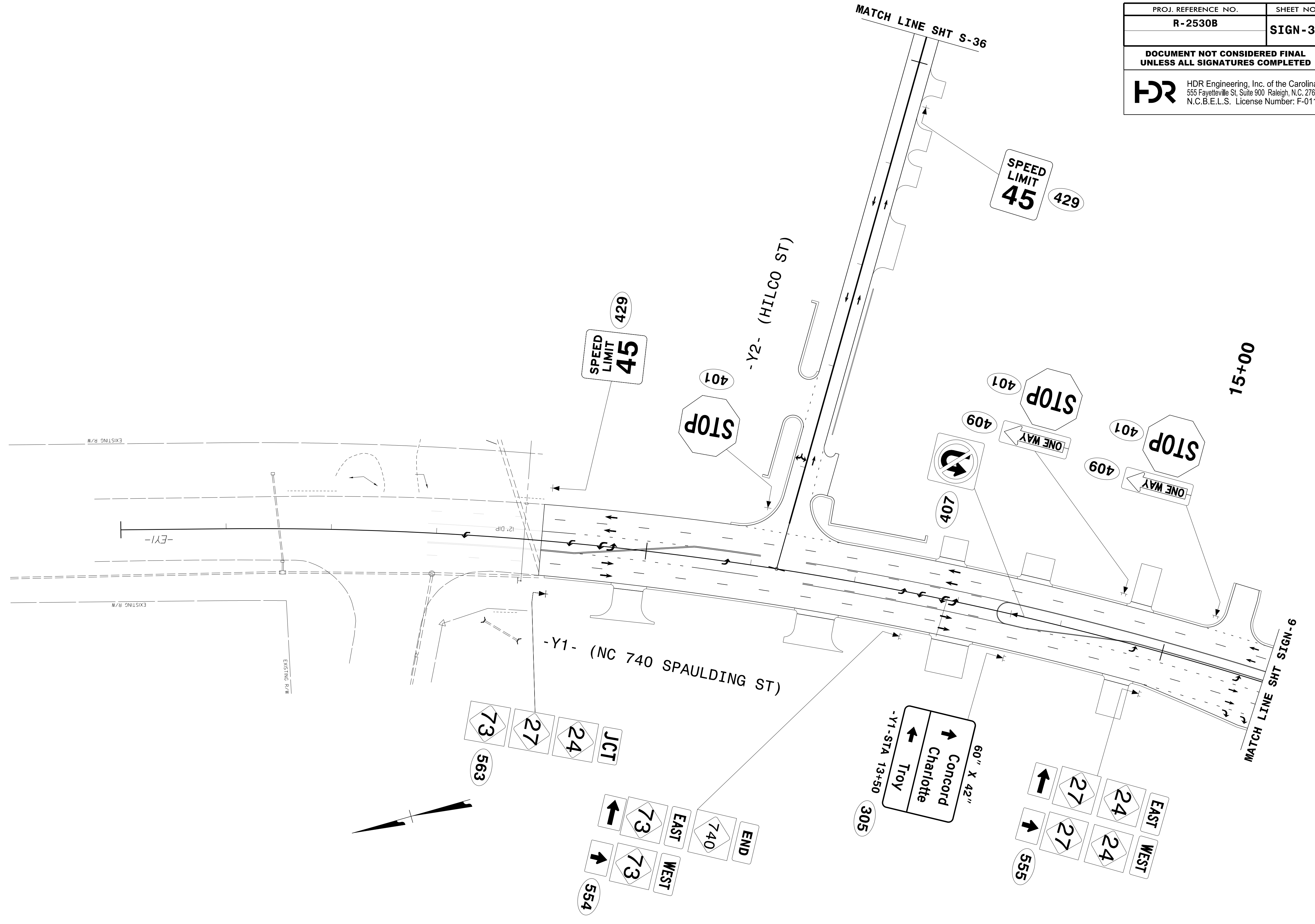

APPROVED: <i>Ron King</i>	DATE: 12/13/2018	<h2 style="text-align: center;">EXISTING SIGN DETAIL</h2>			REVISIONS
SCALE: NTS DATE: \$DATES\$ DWG. BY: K HECTOR DESIGN BY: K HECTOR REVIEWED BY: R KING					CADD FILE

PROJ. REFERENCE NO.	SHEET NO.
R-2530B	SIGN-34
DOCUMENT NOT CONSIDERED FINAL UNLESS ALL SIGNATURES COMPLETED	
 HDR Engineering, Inc. of the Carolinas 555 Fayetteville St, Suite 900 Raleigh, N.C. 27601 N.C.B.E.L.S. License Number: F-0116	



REVISIONS

PLOT DRIVER: \$PLTDVRS\$ PENTABLE: \$PENTBL\$ SCALE: \$SCALESHT\$
 USER: \$USER\$ TIME: \$TIME\$
 DATE: \$DATE\$
 FILE: \$PWVAVAU\$TPATHDESIG\$

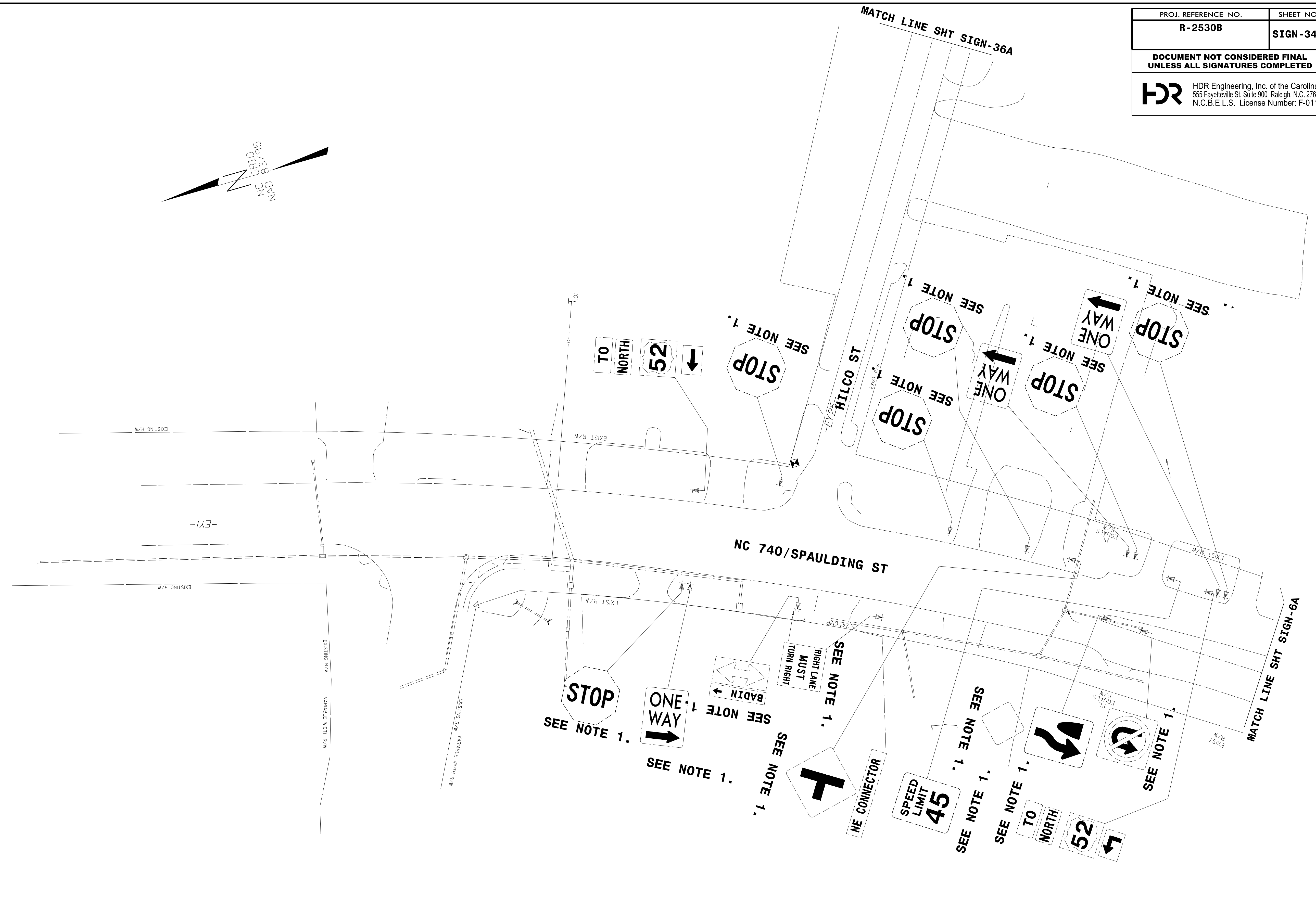
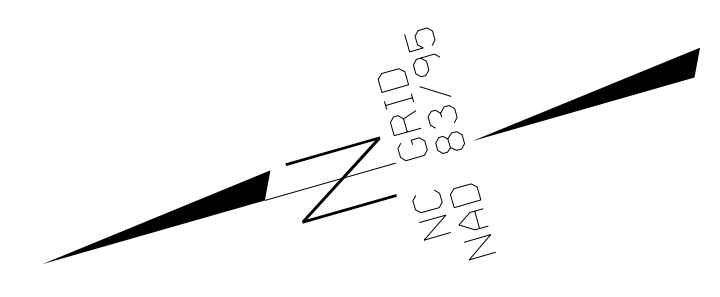

APPROVED: <i>Ron King</i> DATE: 12/13/2018		SIGN DETAIL						
SCALE: NTS DATE: \$DATES\$ DWG. BY: K HECTOR DESIGN BY: K HECTOR REVIEWED BY: R KING			REVISIONS <table border="1"> <tr><td> </td><td> </td></tr> <tr><td> </td><td> </td></tr> <tr><td> </td><td> </td></tr> </table>					

PROJ. REFERENCE NO.	SHEET NO.
R-2530B	SIGN-34A
DOCUMENT NOT CONSIDERED FINAL UNLESS ALL SIGNATURES COMPLETED	
 HDR Engineering, Inc. of the Carolinas 555 Fayetteville St, Suite 900 Raleigh, N.C. 27601 N.C.B.E.L.S. License Number: F-0116	



REVISIONS

PLOT DRIVER: \$PLTDRV\$
 USER: \$USER\$
 FILE: \$PWVARVAULTPATHDESIG\$
 DATE: \$DATE\$
 PENTABLE: \$PENTBL\$
 TIME: \$TIME\$
 SCALE: \$SCALESHT\$

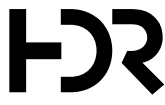

APPROVED: <i>Ron King</i>	DATE: 12/13/2018	<h2 style="text-align: center;">EXISTING SIGN DETAIL</h2>			REVISIONS
SCALE: NTS	DATE: \$DATES\$				
DWG. BY: K HECTOR					
DESIGN BY: K HECTOR					
REVIEWED BY: R KING					

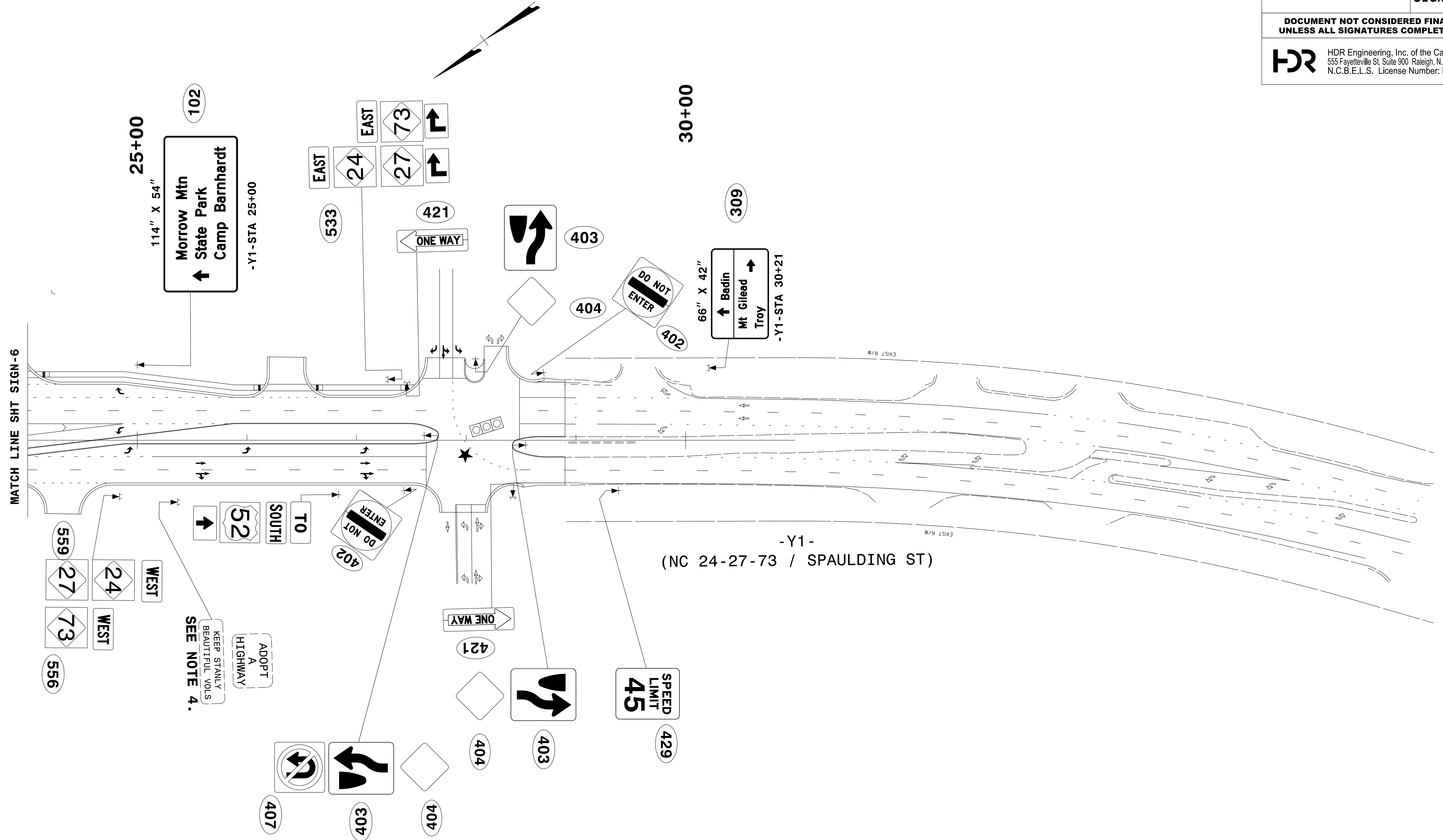
PROJ. REFERENCE NO.	SHEET NO.
R-2530B	SIGN-35
DOCUMENT NOT CONSIDERED FINAL UNLESS ALL SIGNATURES COMPLETED	
 HDR Engineering, Inc. of the Carolinas 555 Fayetteville St, Suite 900 Raleigh, N.C. 27601 N.C.B.E.L.S. License Number: F-0116	



PLOT DRIVER: pdfplotter
 USER: KHECTOR
 FILE: NCDOT\2015.NCDOT_TMSD.Limited.Services.Contract.M.7000016704\NCDOT-R2530B.B4974.103.c.6.0.CAD.BTM.6.2.Work.In.Progress\Traffic\Signing\CADD\Signing_Layout_Plans\U2530B_Signing_Sht_31.dgn
 PENTABLE: NCDOT_Signing.tbl
 DATE: 12/11/18
 TIME: 17:18:14
 SCALE: 1:48.3409

REVISIONS

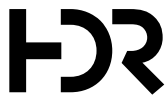

APPROVED: <i>Ron King</i>	DATE: 12/13/2018	<h2>SIGN DETAIL</h2>
		
SCALE: NTS	REVISIONS	
DATE: 12/11/18		
DESIGN BY: K HECTOR		
REVIEWED BY: R KING		
CADD FILE		

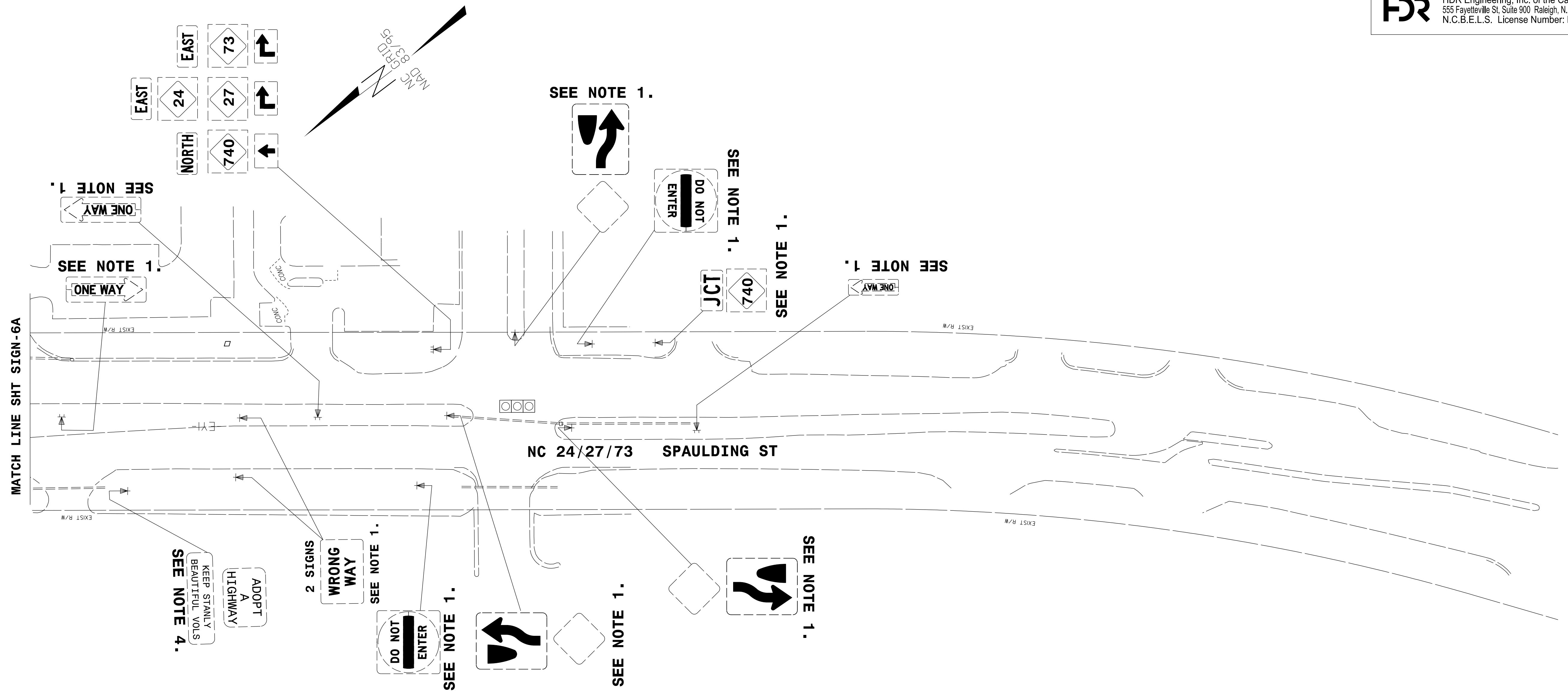
PROJ. REFERENCE NO.	SHEET NO.
R-2530B	SIGN-35A
DOCUMENT NOT CONSIDERED FINAL UNLESS ALL SIGNATURES COMPLETED	
 HDR Engineering, Inc. of the Carolinas 555 Fayetteville St, Suite 900 Raleigh, N.C. 27601 N.C.B.E.L.S. License Number: F-0116	



PLOT DRIVER: pdfplotcfgr
 USER: KHECTOR
 FILE: NCDOT\2015.NCDOT_TMSD.Limited.Services.Contract.M.7000016704\NCDOT-R2530B.B4974.103.c..6.0.CAD.BTM.6.2.Work.In.Progress\Traffic\Signing\CADD\Signing_Layout_Plans\U2530B_Signing_Sht_EX31.dgn

REVISIONS

APPROVED: <i>Ron King</i>	DATE: 12/13/2018	<h2 style="text-align: center;">EXISTING SIGN DETAIL</h2>			REVISIONS	
SCALE: NTS	DATE: 12/05/18					
DWG. BY: K HECTOR	DESIGN BY: K HECTOR					
REVIEWED BY: R KING						

PROJ. REFERENCE NO.	SHEET NO.
R-2530B	SIGN-36
DOCUMENT NOT CONSIDERED FINAL UNLESS ALL SIGNATURES COMPLETED	
 HDR Engineering, Inc. of the Carolinas 555 Fayetteville St, Suite 900 Raleigh, N.C. 27601 N.C.B.E.L.S. License Number: F-0116	

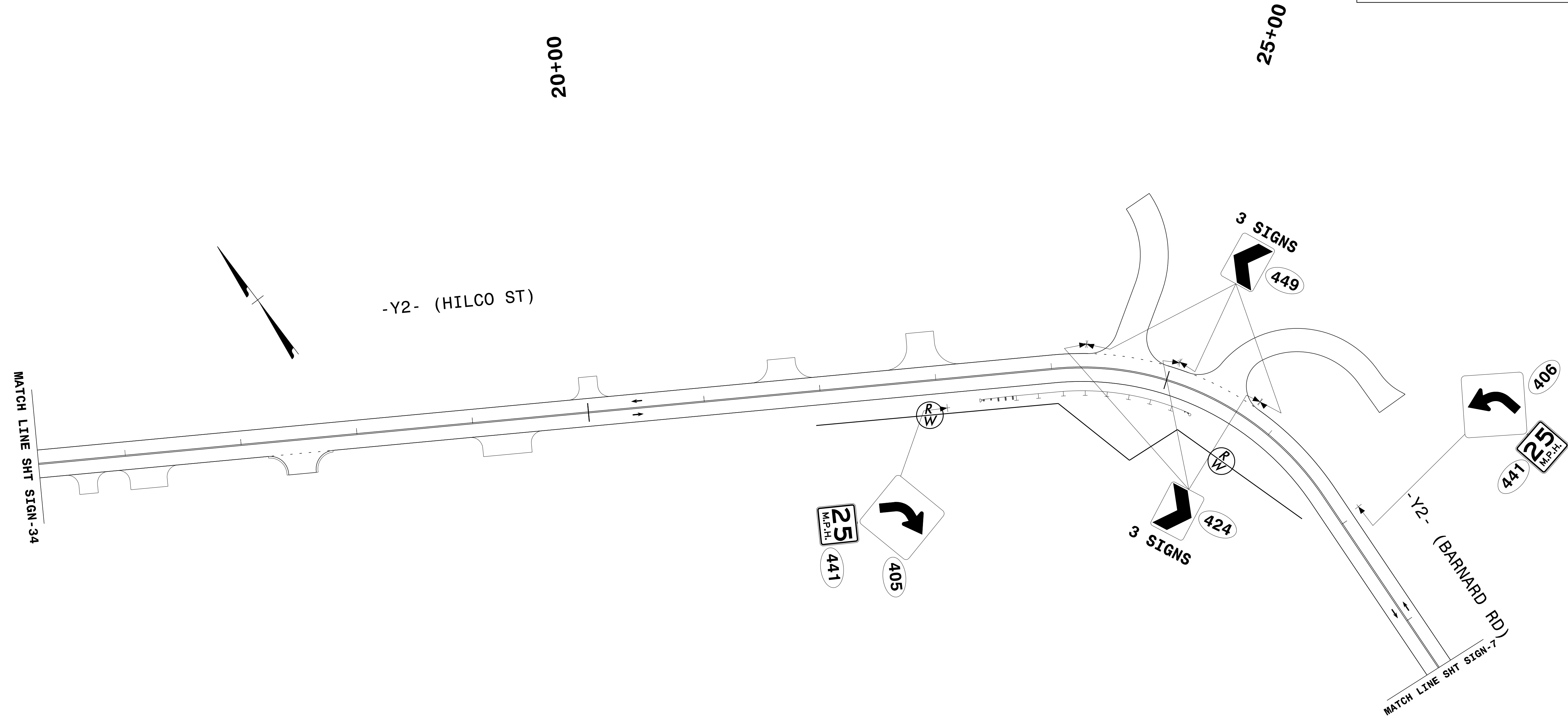



REVISIONS

PLOT DRIVER: \$PLTDRV\$
 USER: \$USER\$
 FILE: \$PWVARVAULTPATHDESC\$

PENTABLE: \$PENTBL\$
 TIME: \$TIME\$

DATE: \$DATE\$
 SCALE: \$SCALESHORT\$

APPROVED: <i>Ron King</i>	DATE: 12/13/2018	SIGN DETAIL								
										
SCALE: NTS	DATE: \$DATES									
DWG. BY: K HECTOR	DESIGN BY: K HECTOR									
REVIEWED BY: R KING										
		<table border="1"> <thead> <tr> <th colspan="2">REVISIONS</th> </tr> </thead> <tbody> <tr> <td> </td> <td> </td> </tr> <tr> <td> </td> <td> </td> </tr> <tr> <td> </td> <td> </td> </tr> </tbody> </table>	REVISIONS							
REVISIONS										
		CADD FILE								

