

**This electronic collection of documents is provided
for the convenience of the user
and is Not a Certified Document –**

**The documents contained herein were originally issued
and sealed by the individuals whose names and license
numbers appear on each page, on the dates appearing
with their signature on that page.**

**This file or an individual page
shall not be considered a certified document.**



130 140 130 120 110 100 90 80 70 60 50 40 30 20 10 0 10 20 30 40 50 60 70 80 90 100 110 120 130 140 150

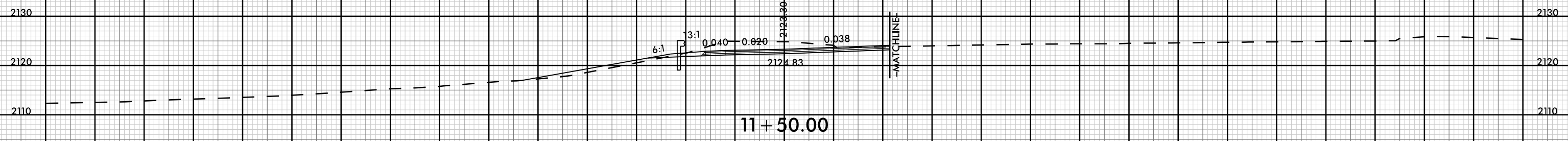
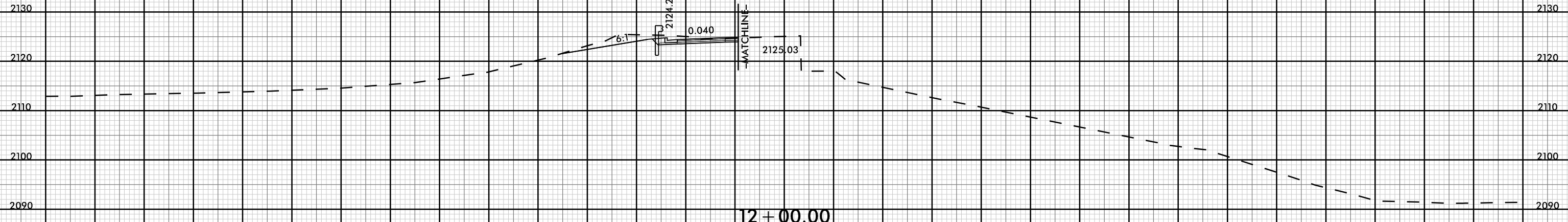

-Y10RPC SPUR_LT-

130 140 130 120 110 100 90 80 70 60 50 40 30 20 10 0 10 20 30 40 50 60 70 80 90 100 110 120 130 140 150



130 140 130 120 110 100 90 80 70 60 50 40 30 20 10 0 10 20 30 40 50 60 70 80 90 100 110 120 130 140 150

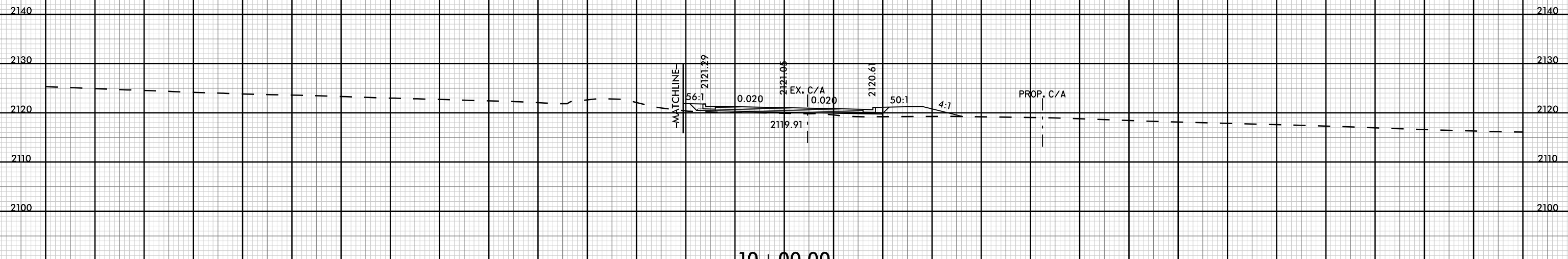
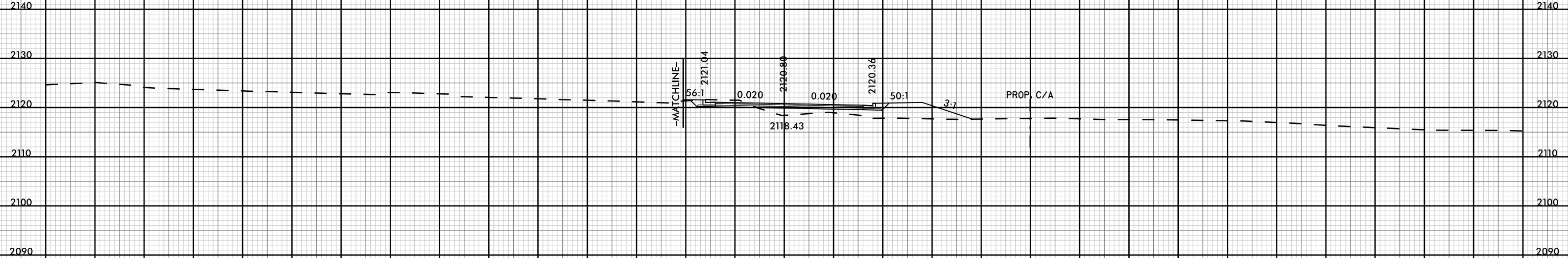

-Y10RPC SPUR RT-



130 140 130 120 110 100 90 80 70 60 50 40 30 20 10 0 10 20 30 40 50 60 70 80 90 100 110 120 130 140 150

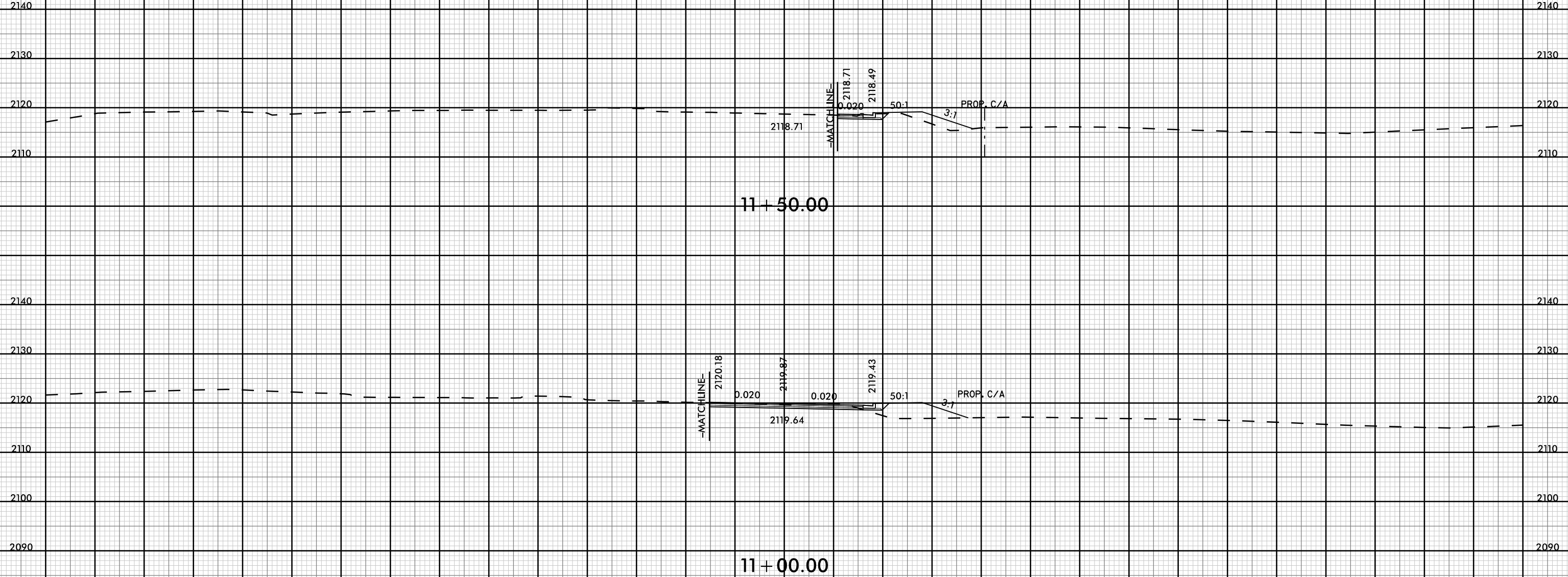

11 + 50.00

11 + 00.00

-Y10RPC SPUR RT-



130 140 130 120 110 100 90 80 70 60 50 40 30 20 10 0 10 20 30 40 50 60 70 80 90 100 110 120 130 140 150

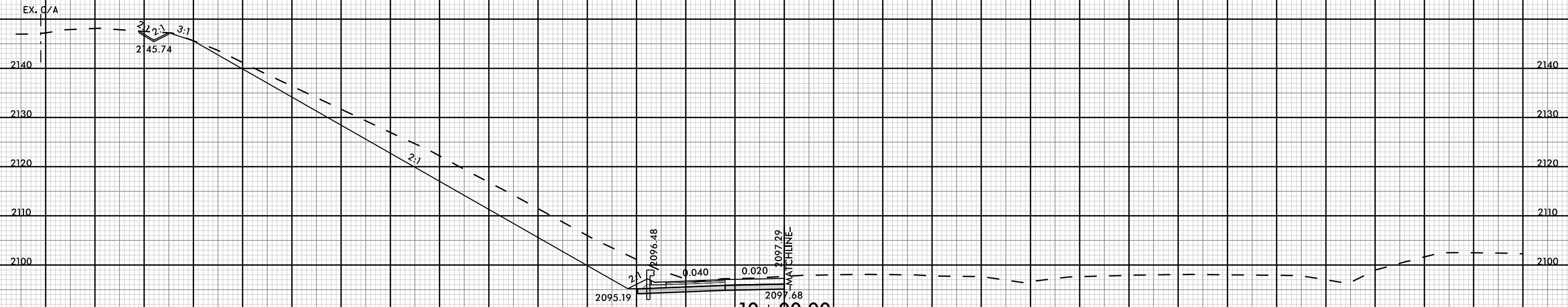
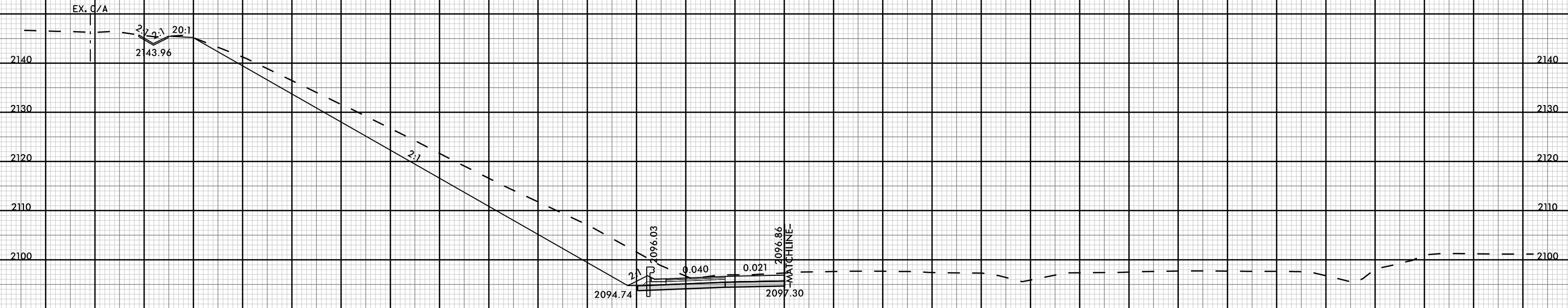

130 140 130 120 110 100 90 80 70 60 50 40 30 20 10 0 10 20 30 40 50 60 70 80 90 100 110 120 130 140 150

8/23/99

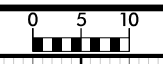

PROJ. REFERENCE NO.	SHEET NO.
I-4400C	Y-44

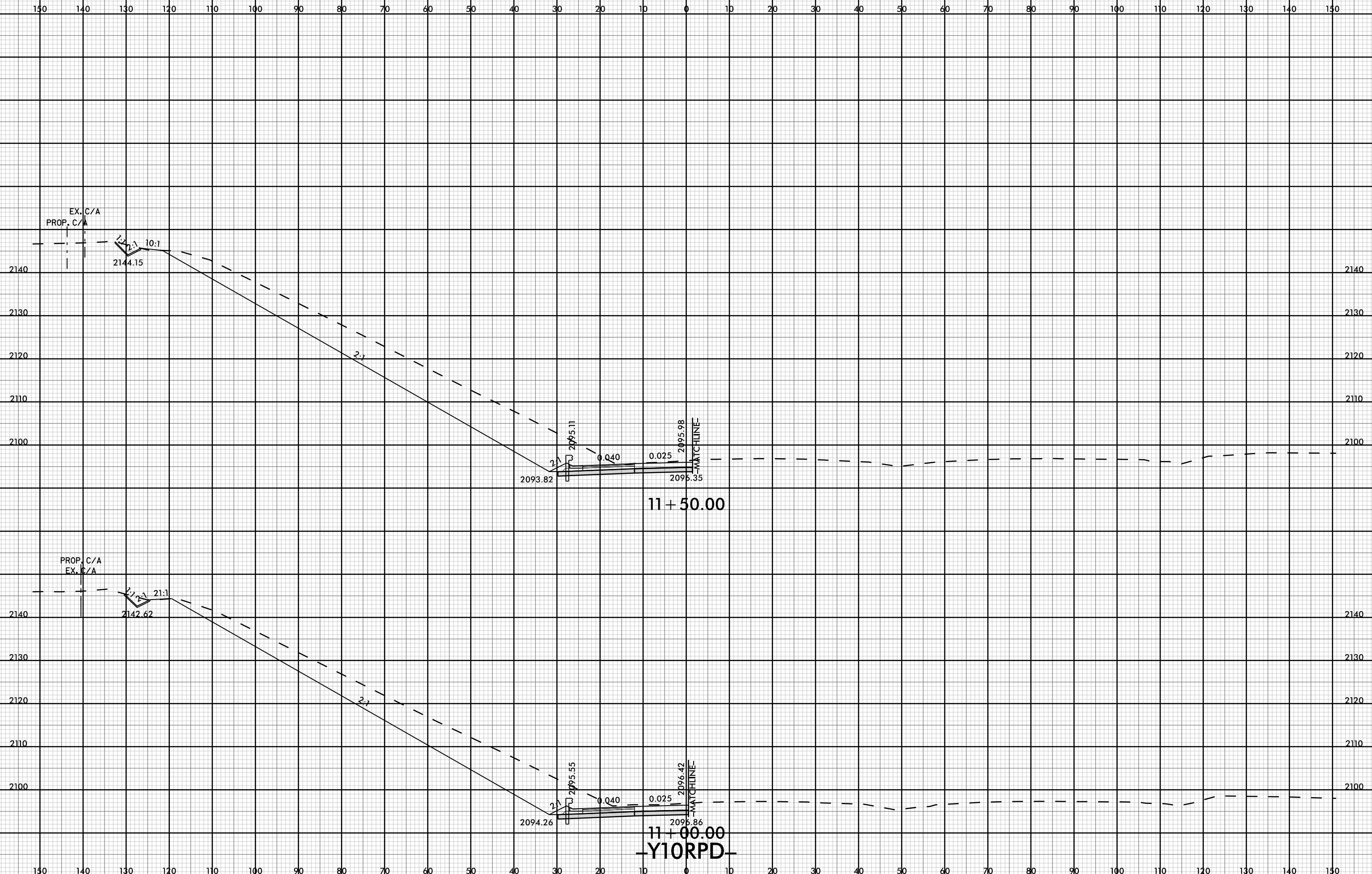

I:\MAY_2018_1557\Roadway\CorridorModeling\I4400C_RDY_XPL_Y10RPD.dgn
 J:\NFB\

Y10RPD

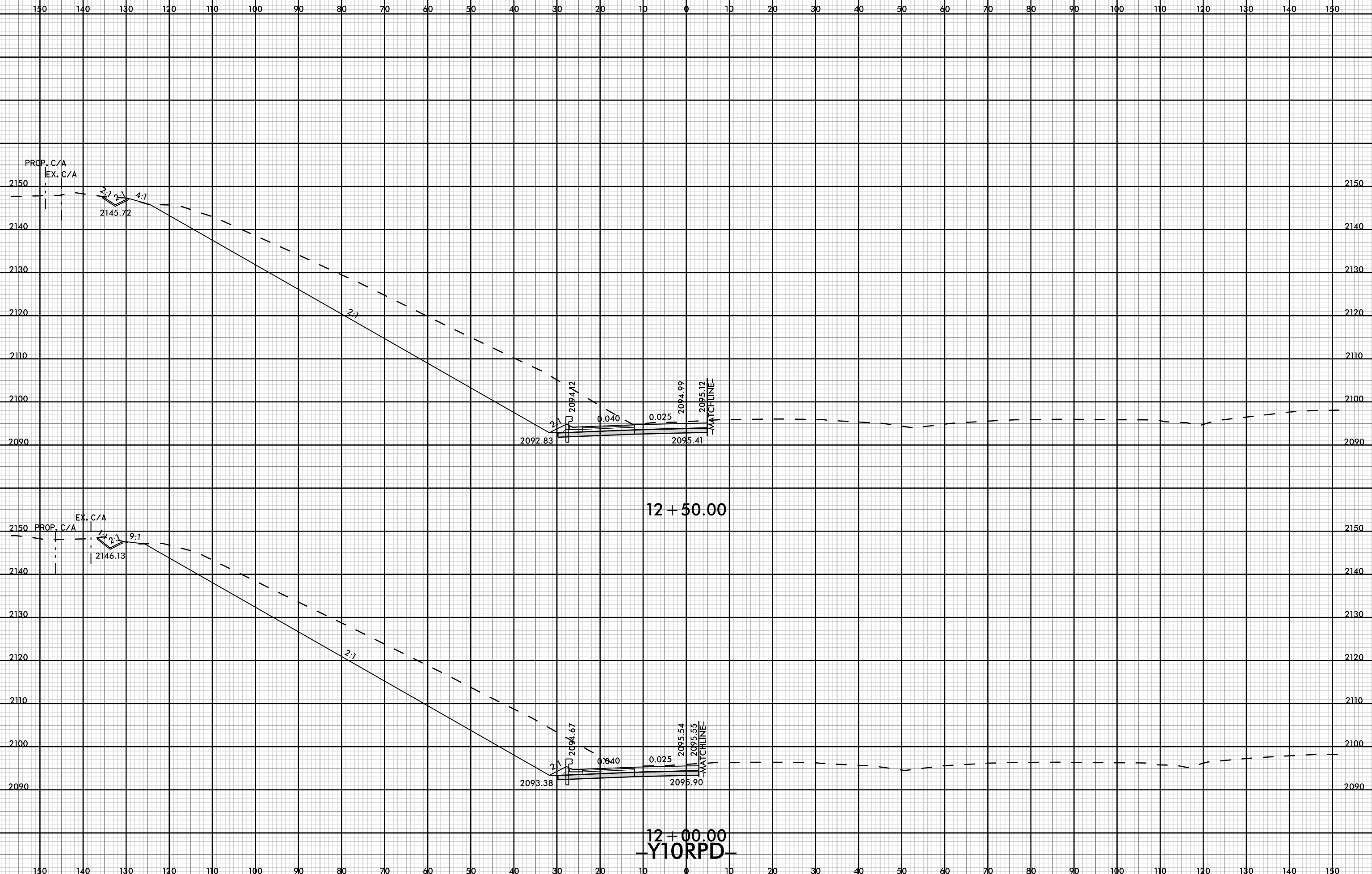



130 140 130 120 110 100 90 80 70 60 50 40 30 20 10 0 10 20 30 40 50 60 70 80 90 100 110 120 130 140 150

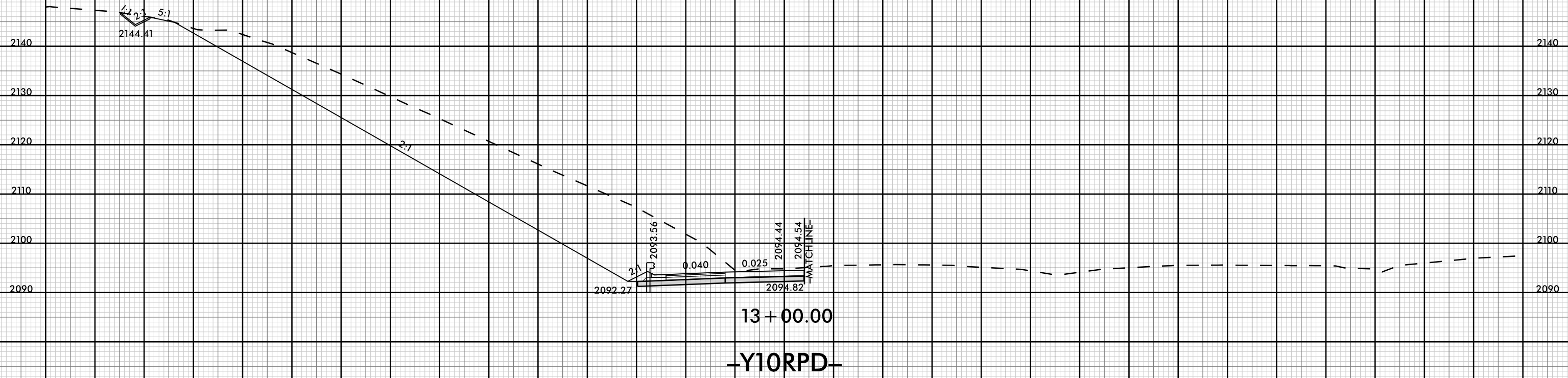
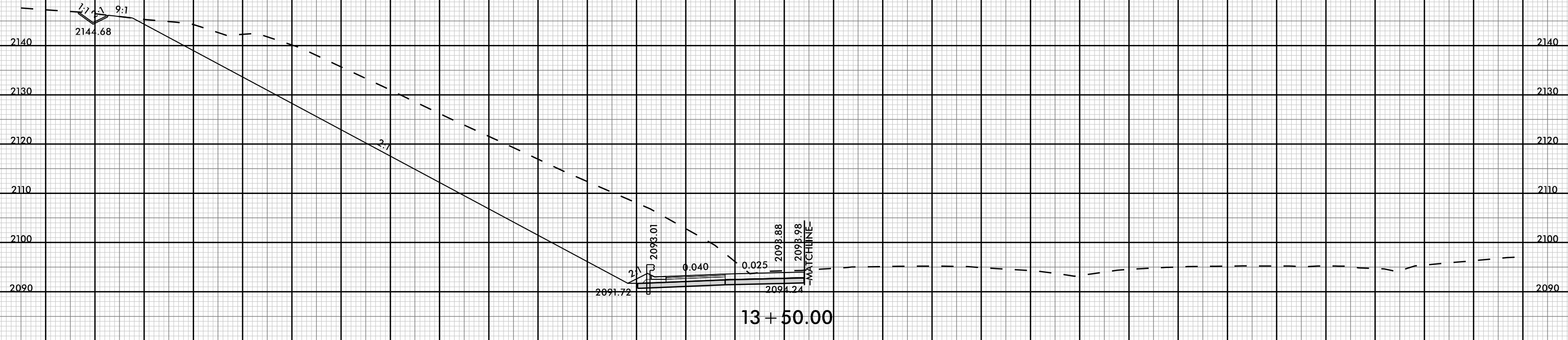

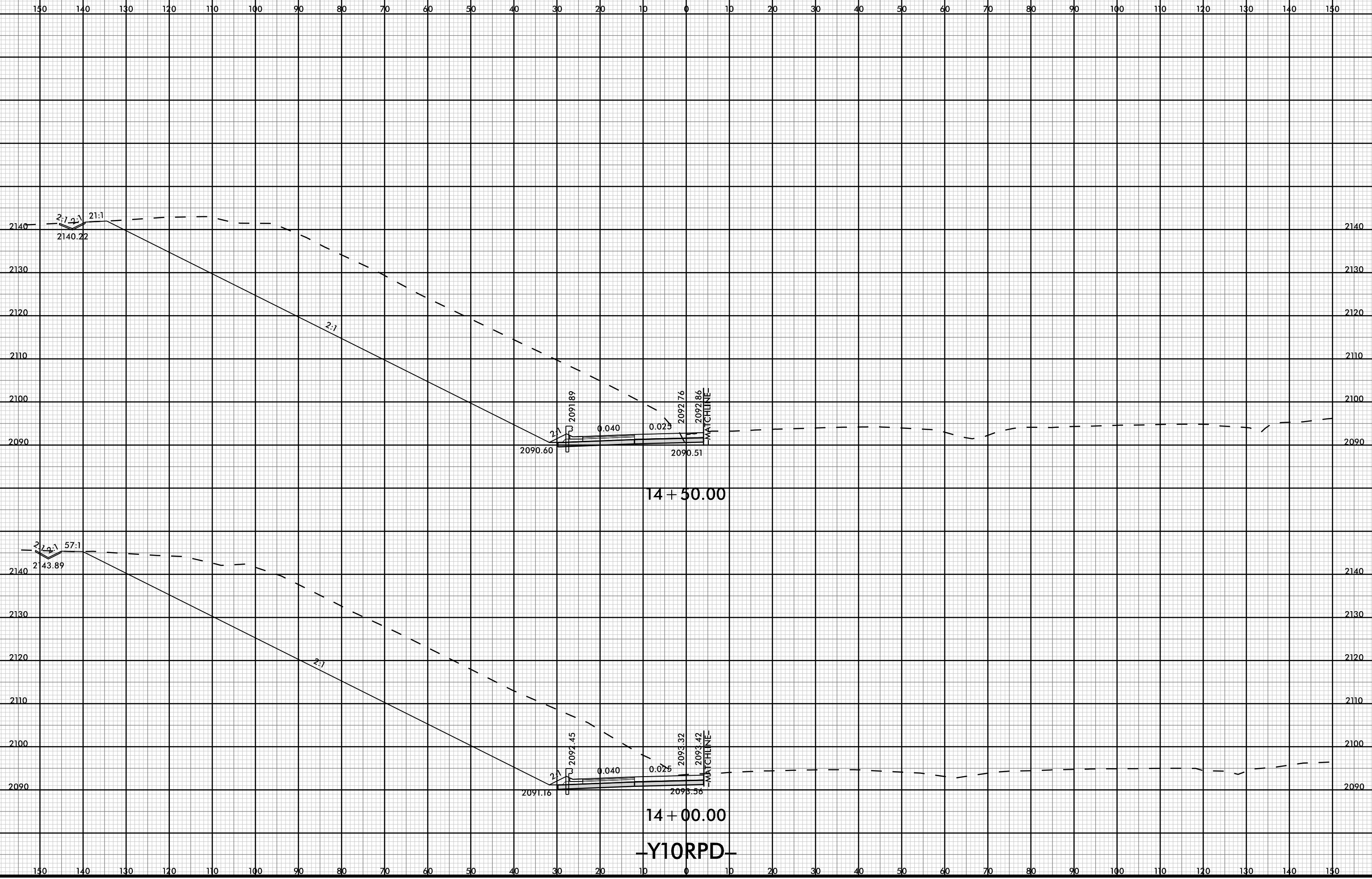

14 + 50.00

14 + 00.00

Y10RPD

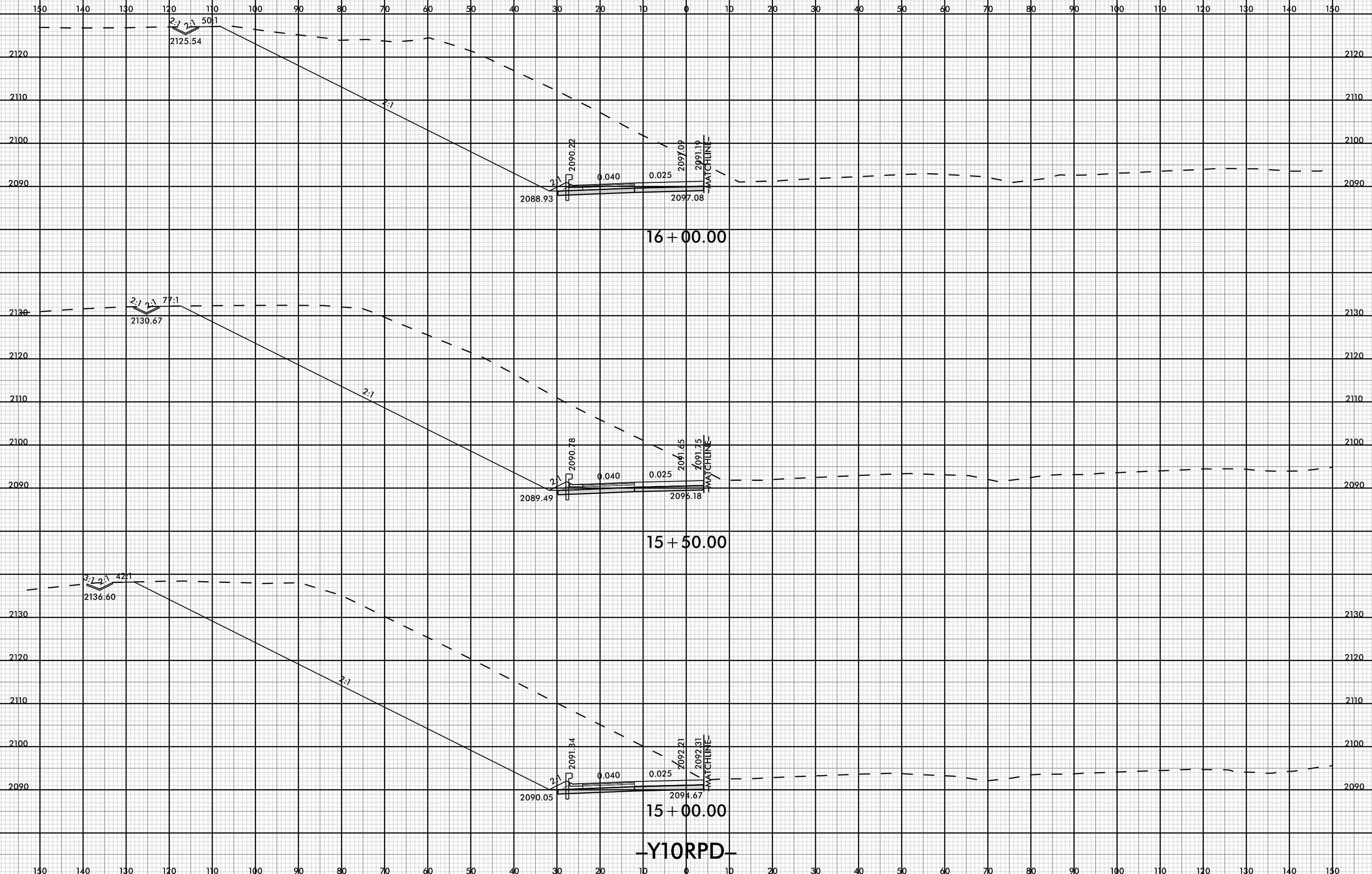

Y10RFD

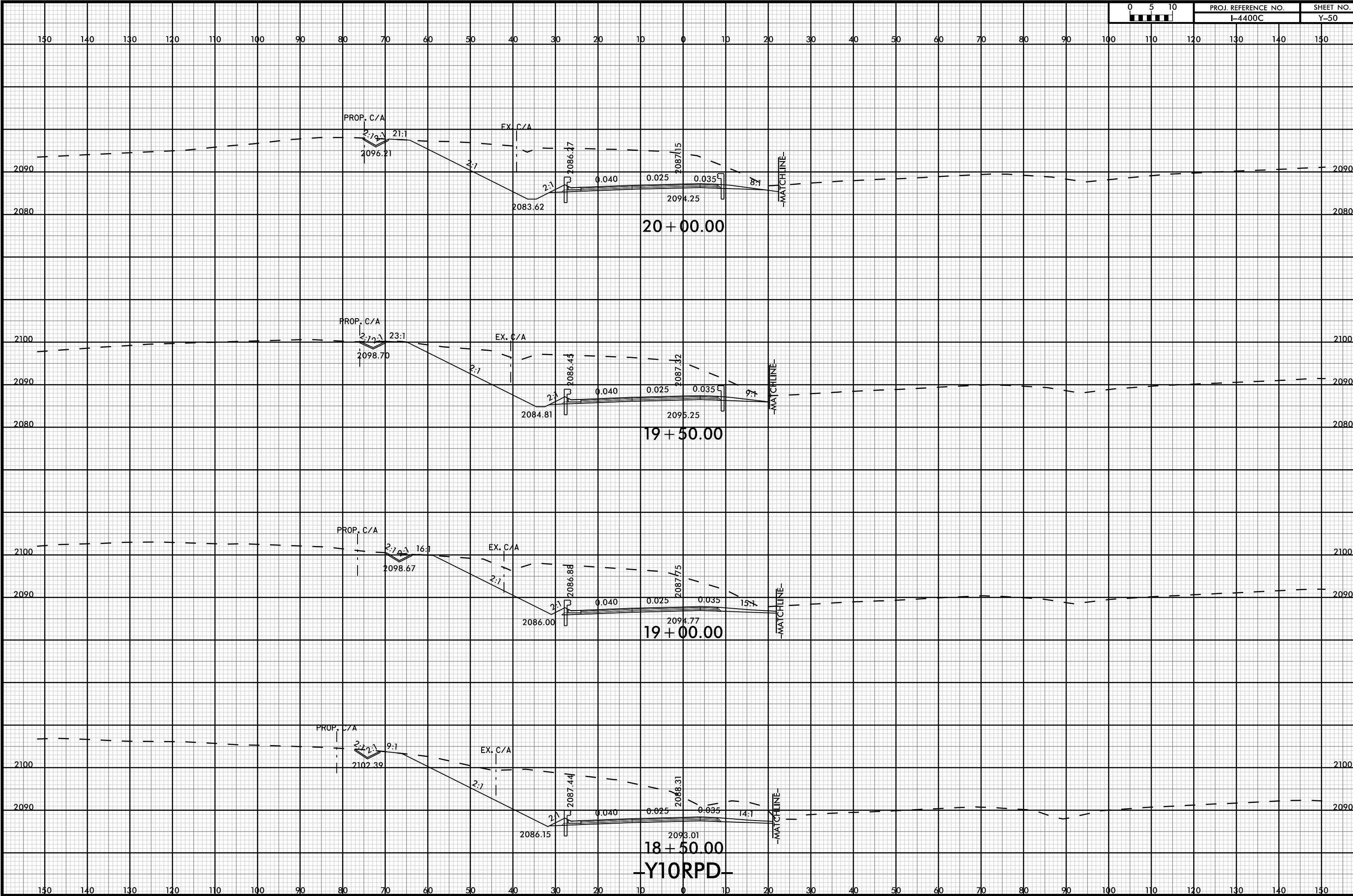

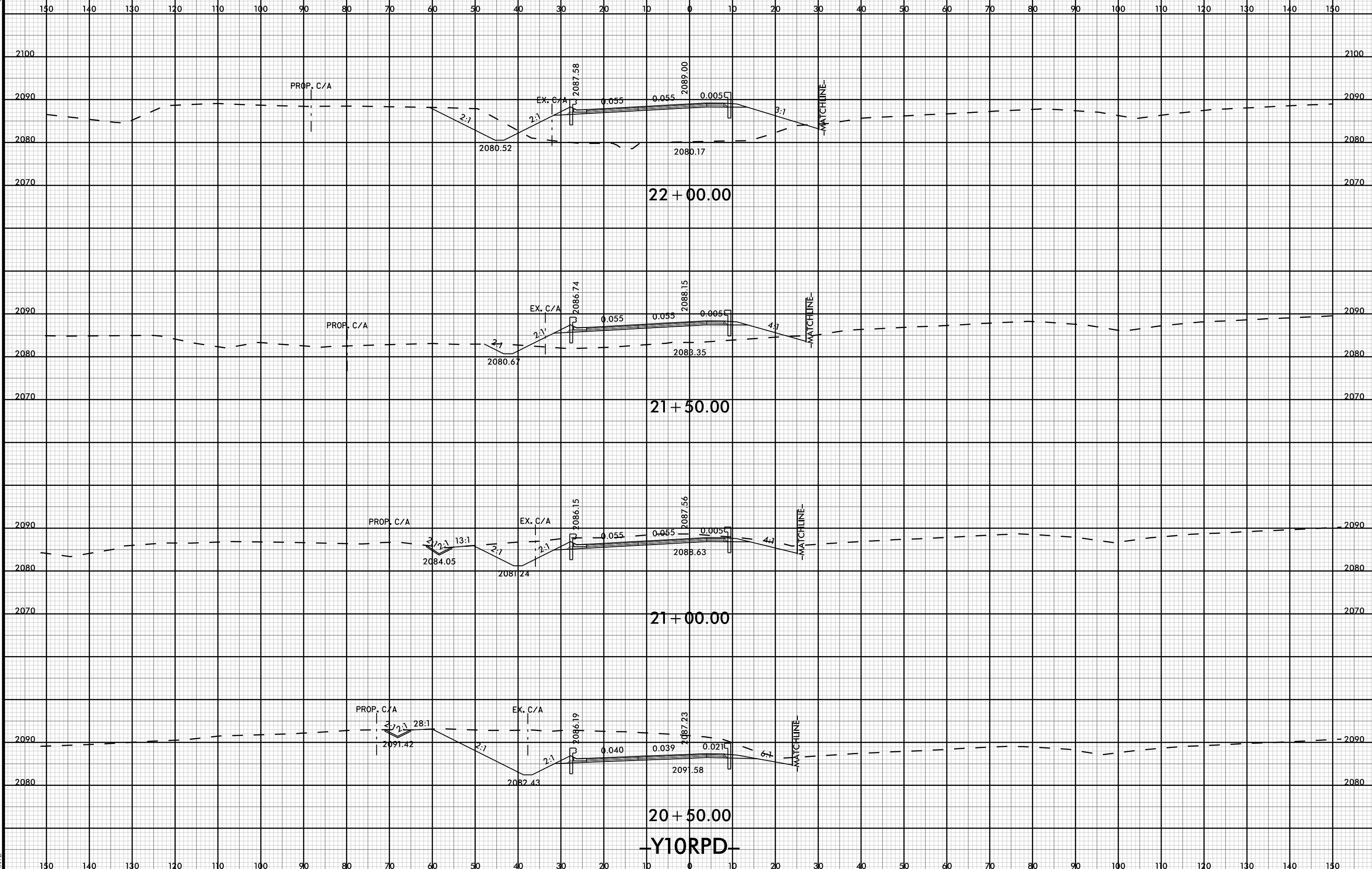

8/23/99

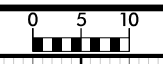

PROJ. REFERENCE NO.	SHEET NO.
I-4400C	Y-52

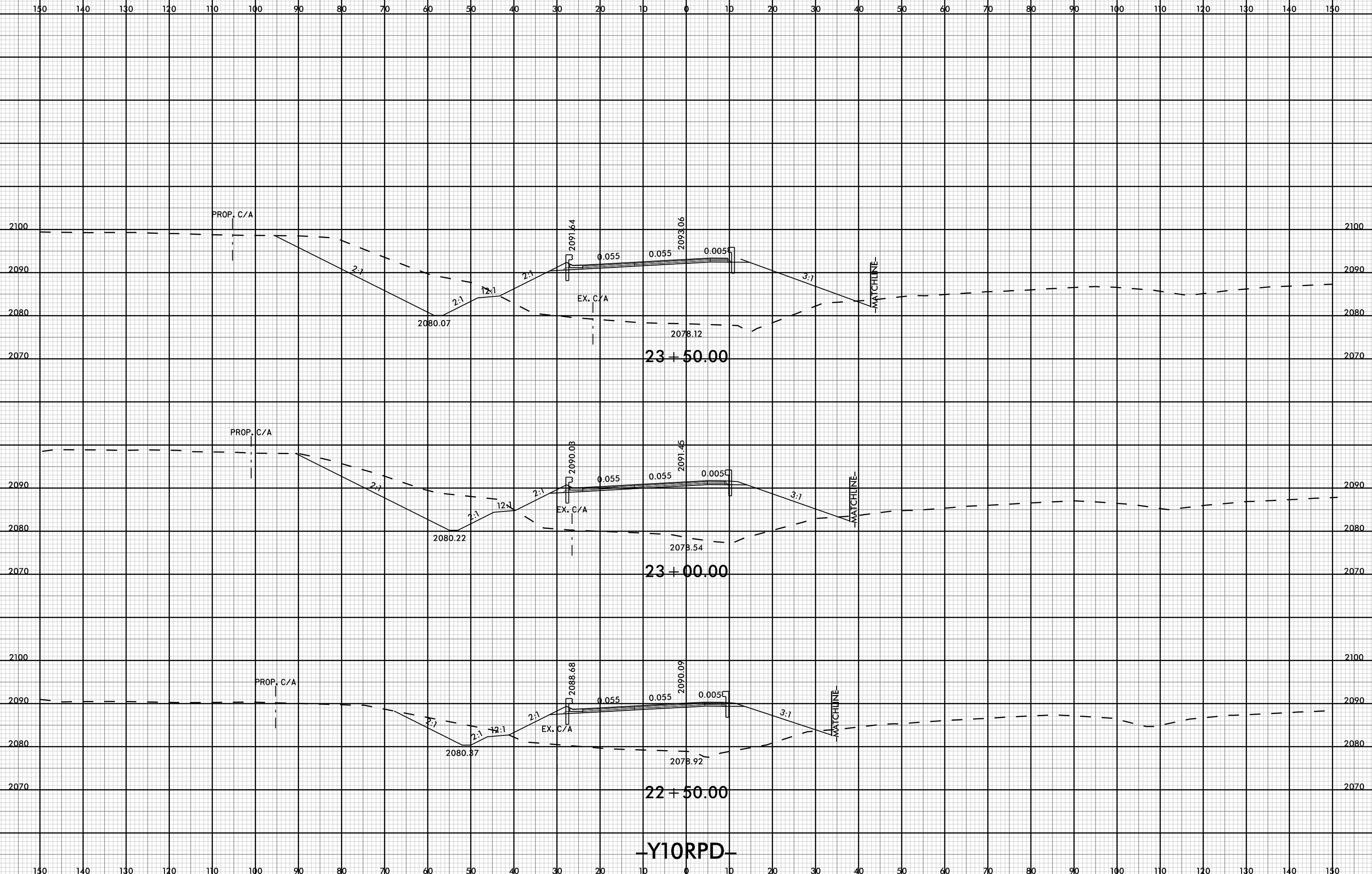

2-MAY-2018 15:57
 C:\Roadway\CorridorModeling\I4400C_RDY_XPL_Y10RPD.dgn
 JNF

Y10RPD

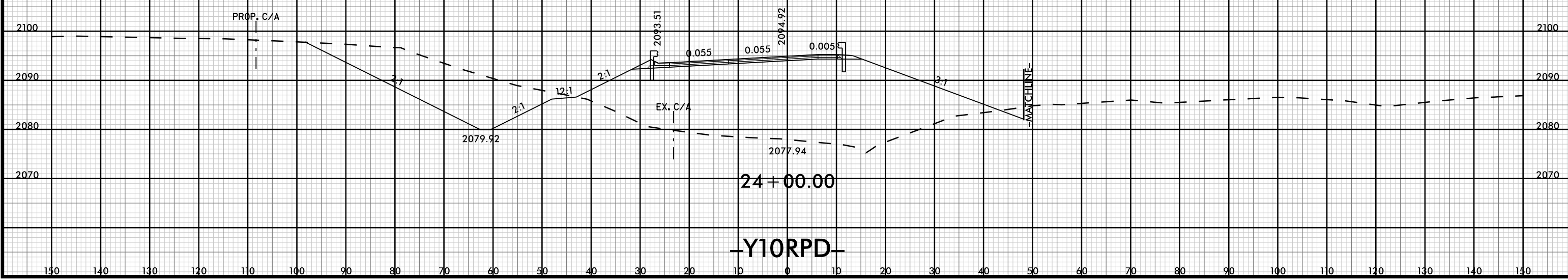
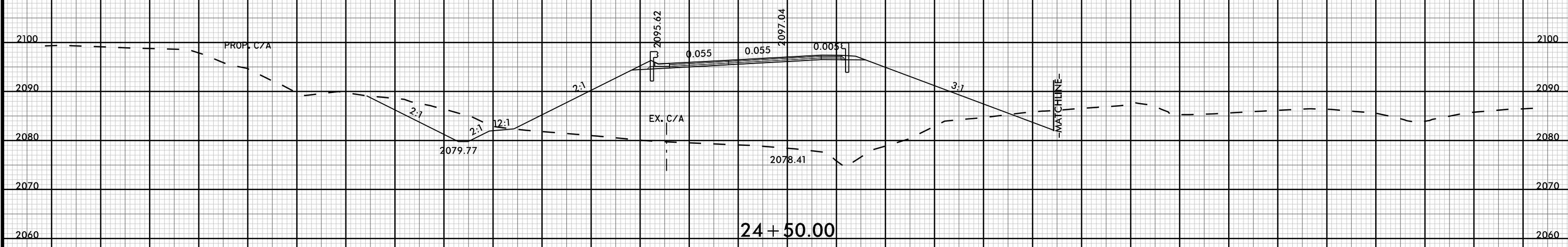
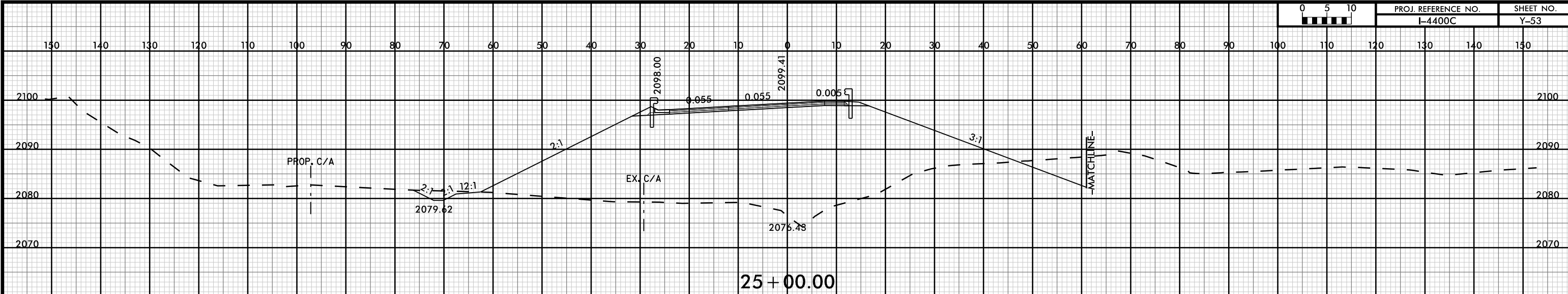

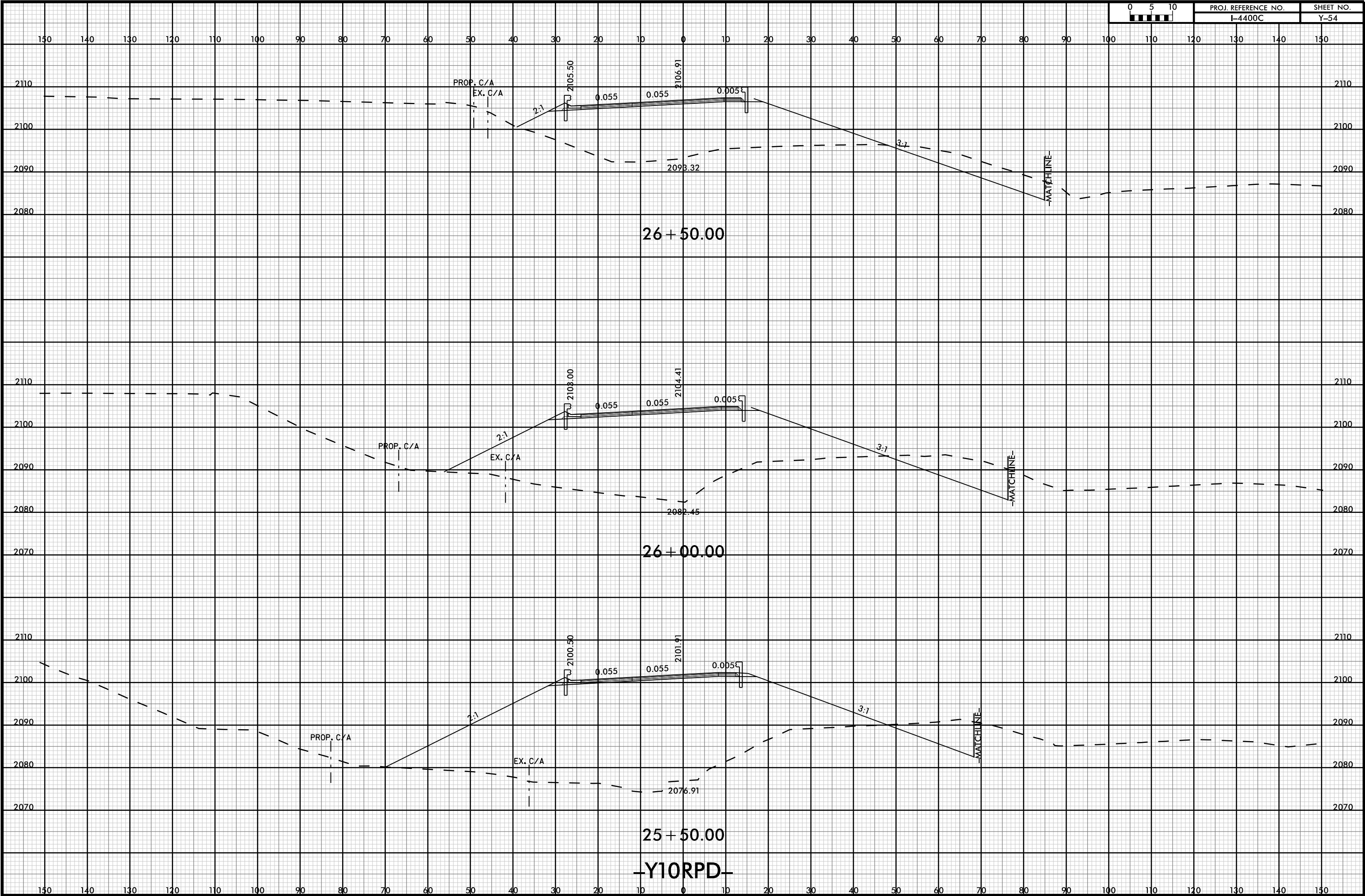

Y10RPD

8/23/99

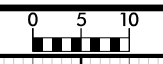

PROJ. REFERENCE NO. I-4400C	SHEET NO. Y-55
--------------------------------	-------------------

130 140 130 120 110 100 90 80 70 60 50 40 30 20 10 0 10 20 30 40 50 60 70 80 90 100 110 120 130 140 150

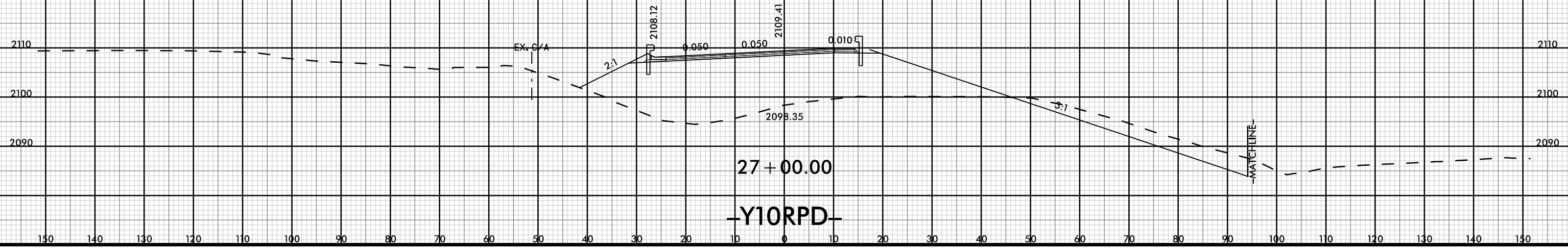

I:\MAY_2018_1557
 R\Fredway\CorridorModeling\I4400C_RDY_XPL_Y10RPD.dgn
 JNF

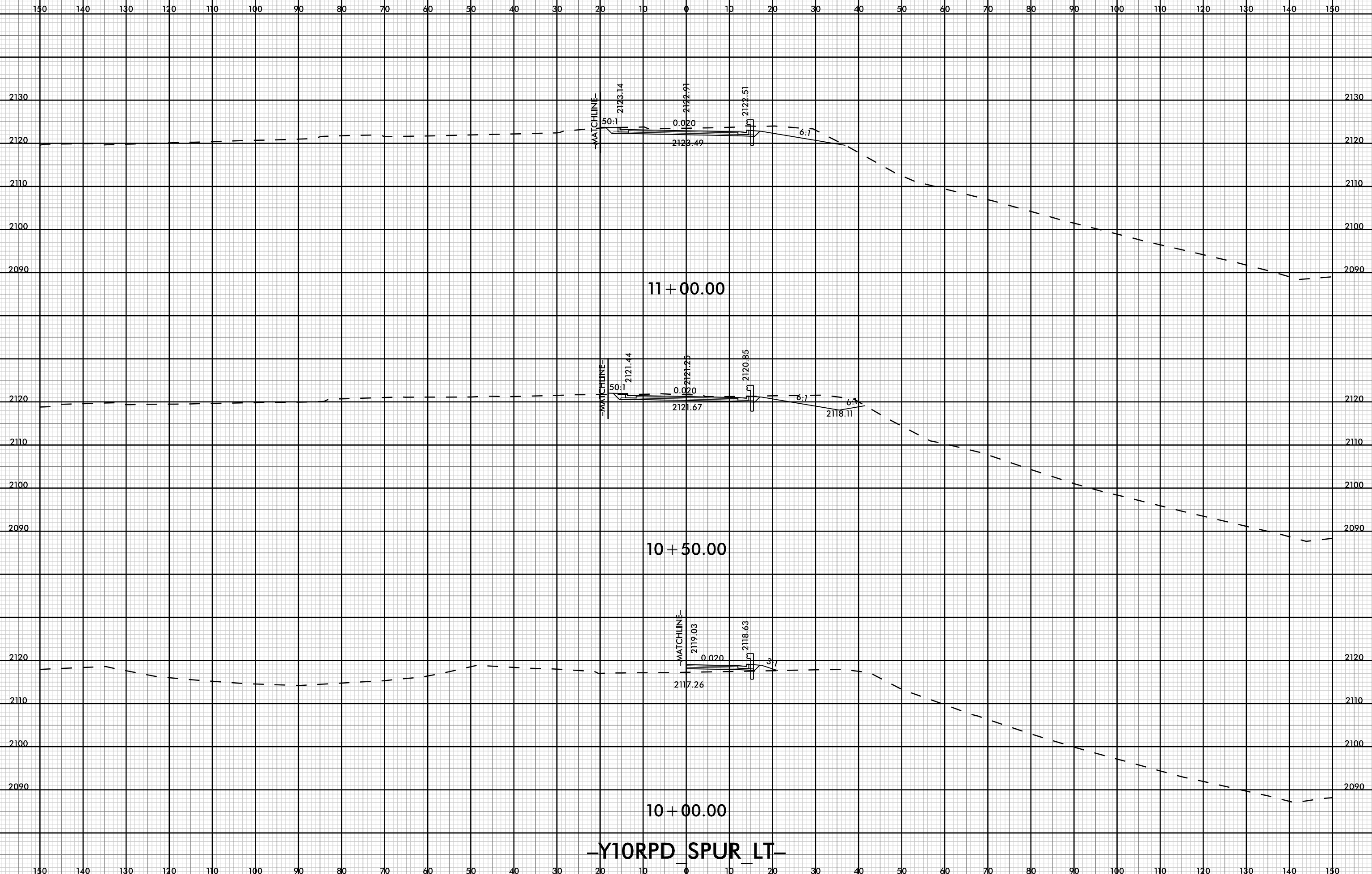

-Y10RPD_SPUR_LT-



130 140 130 120 110 100 90 80 70 60 50 40 30 20 10 0 10 20 30 40 50 60 70 80 90 100 110 120 130 140 150

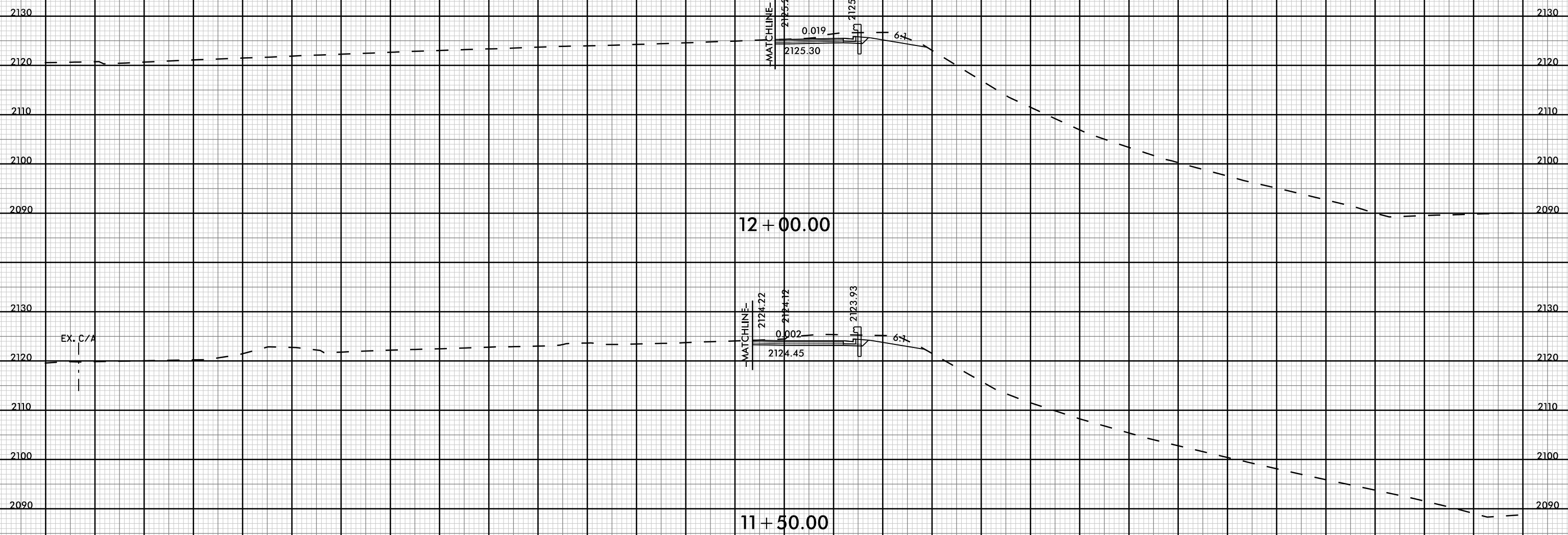

12 + 00.00

11 + 50.00

-Y10RPD_SPUR_LT-



150 140 130 120 110 100 90 80 70 60 50 40 30 20 10 0 10 20 30 40 50 60 70 80 90 100 110 120 130 140 150

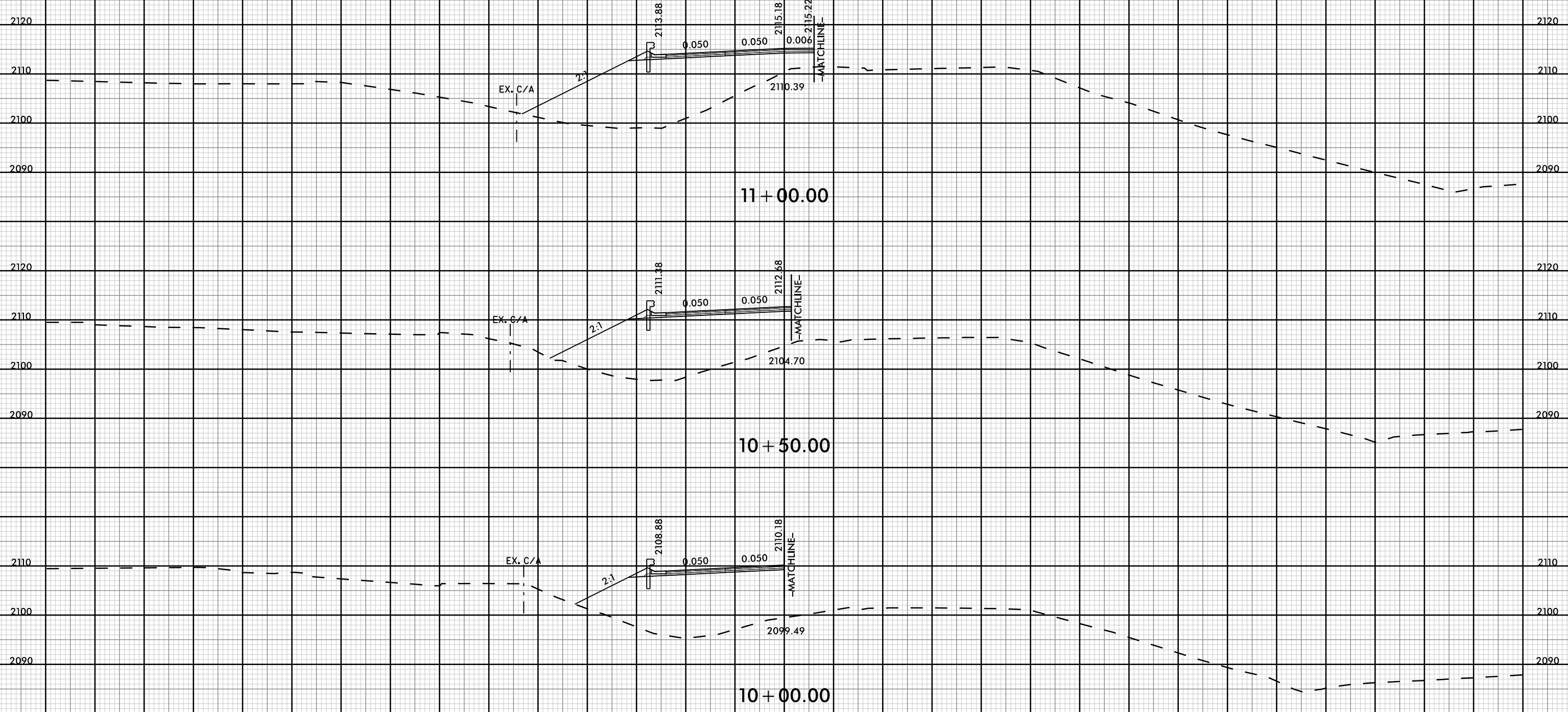

-Y10RPD SPUR RT-

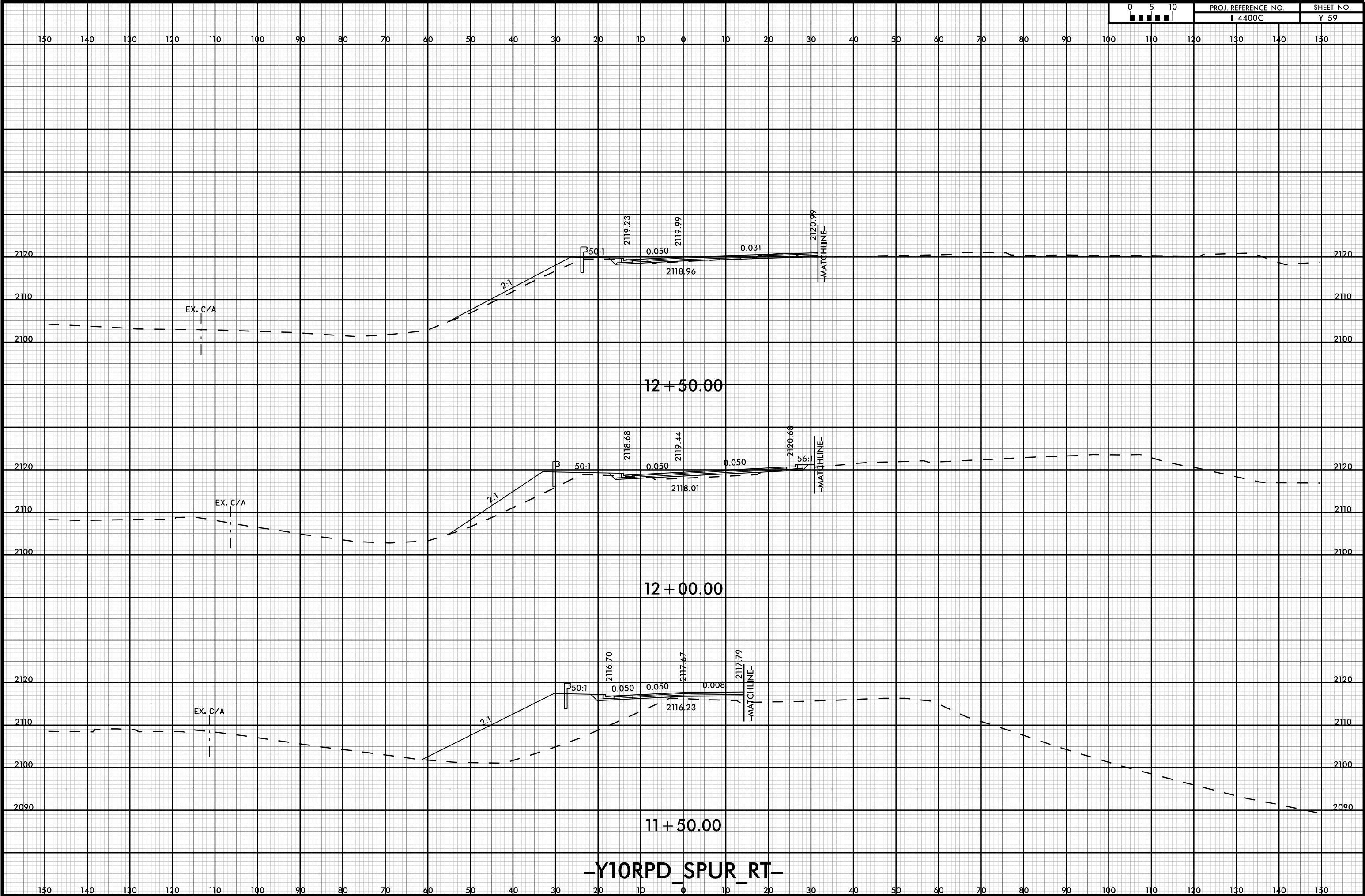

-Y1ORPD SPUR RT-



130 140 130 120 110 100 90 80 70 60 50 40 30 20 10 0 10 20 30 40 50 60 70 80 90 100 110 120 130 140 150

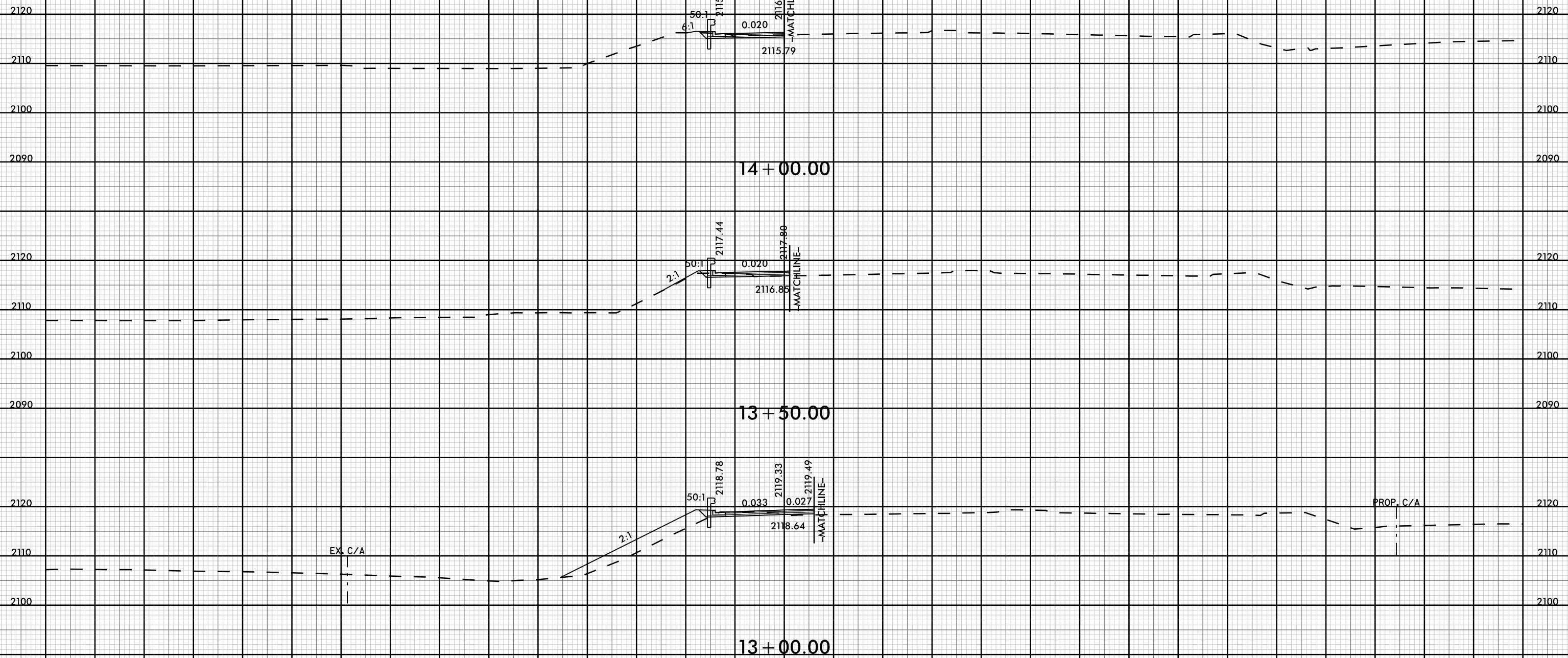

-Y10RPD SPUR RT-



150 140 130 120 110 100 90 80 70 60 50 40 30 20 10 0 10 20 30 40 50 60 70 80 90 100 110 120 130 140 150

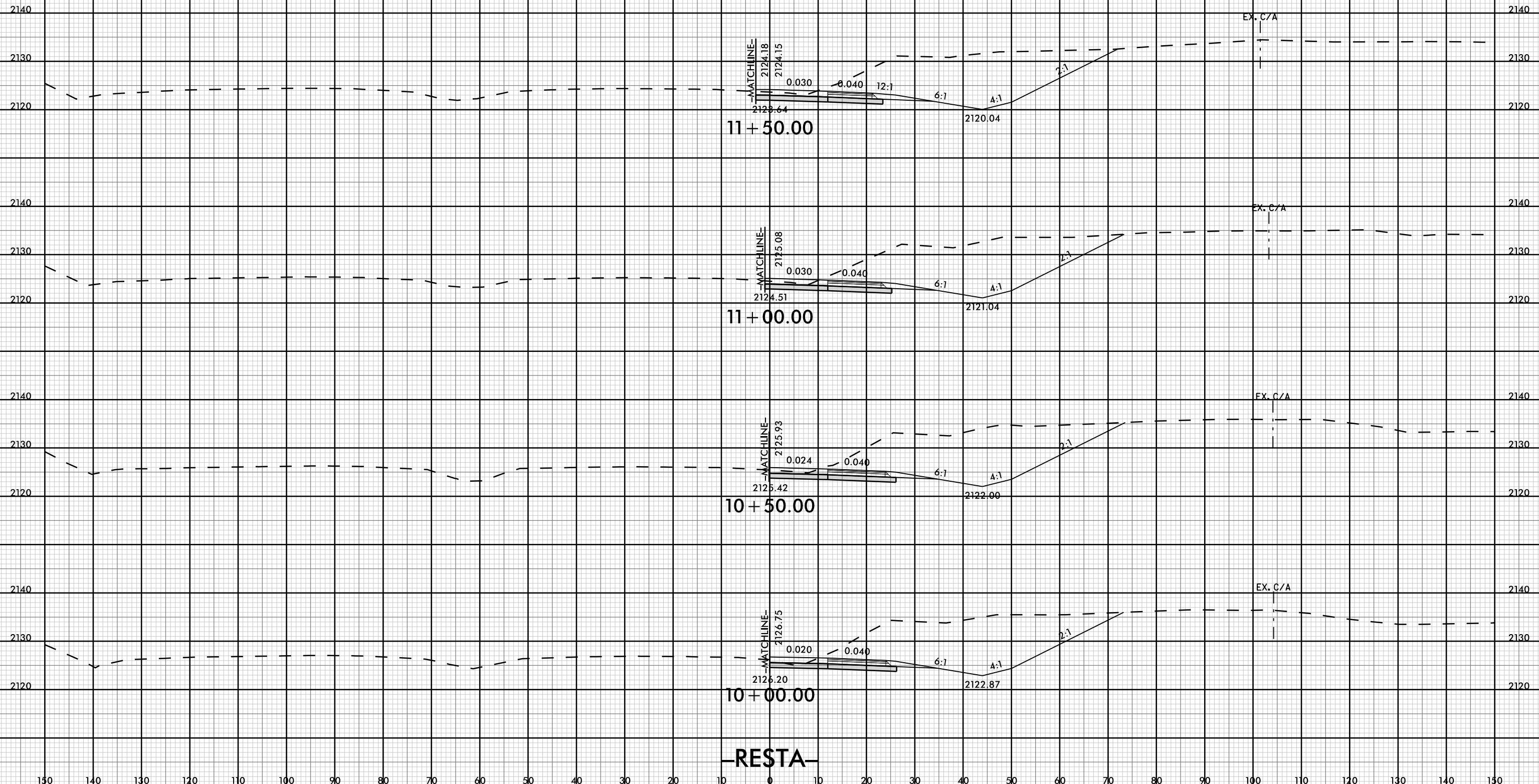

11 + 50.00

11 + 00.00

10 + 50.00

10 + 00.00

RESTA

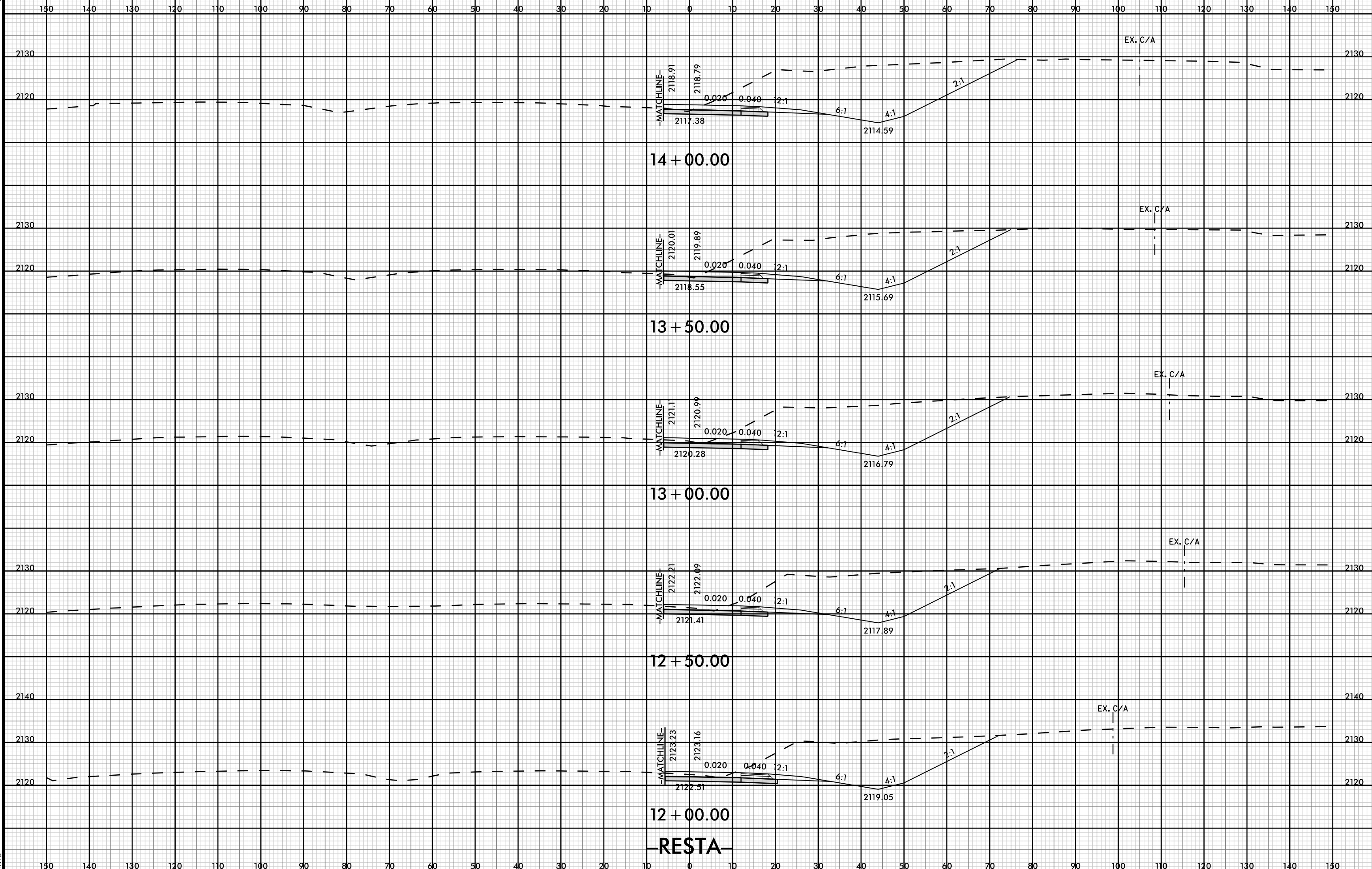

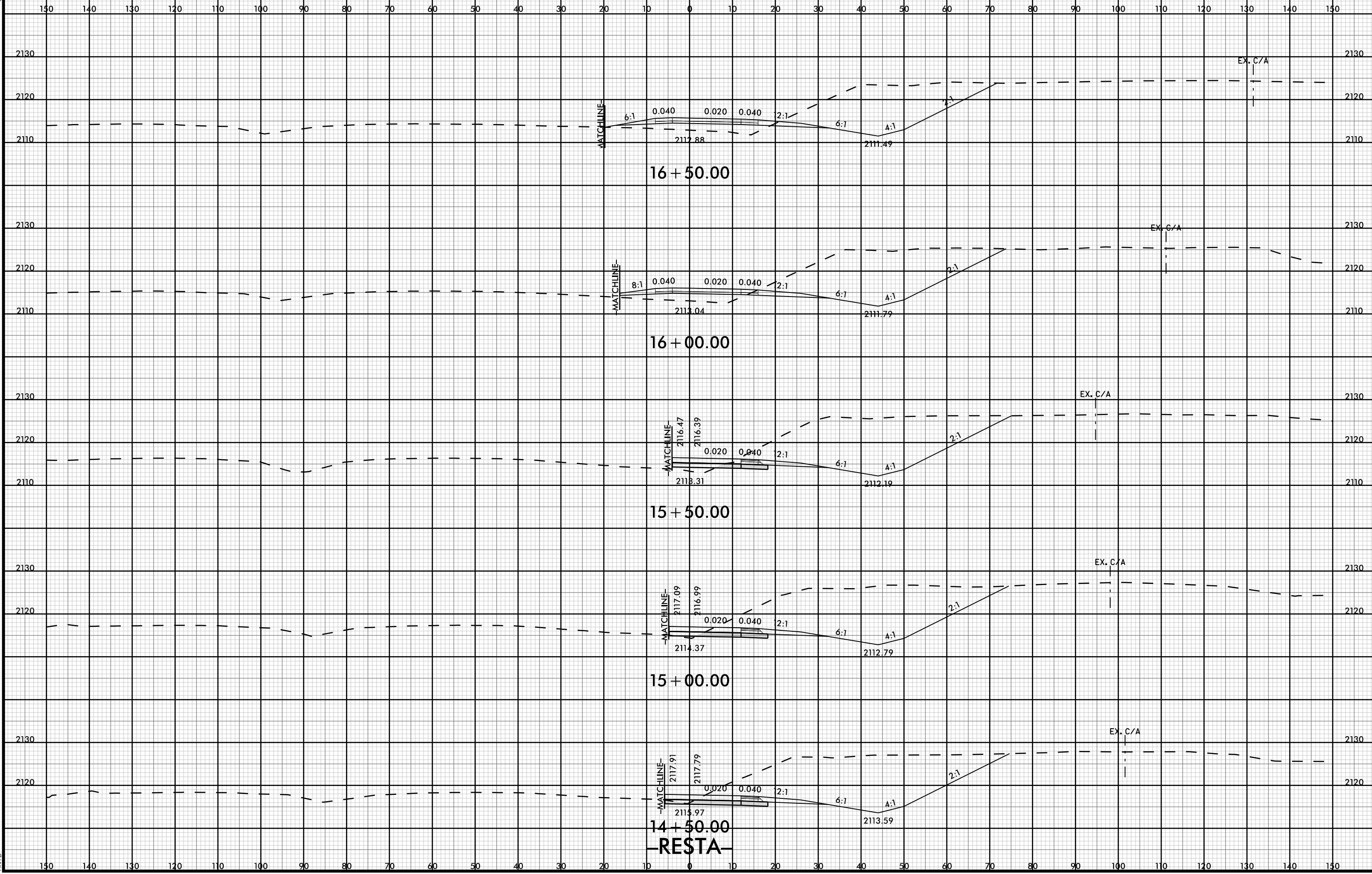



130 140 130 120 110 100 90 80 70 60 50 40 30 20 10 0 10 20 30 40 50 60 70 80 90 100 110 120 130 140 150

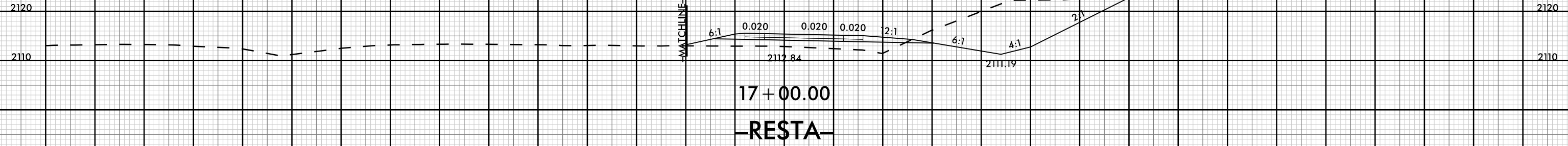

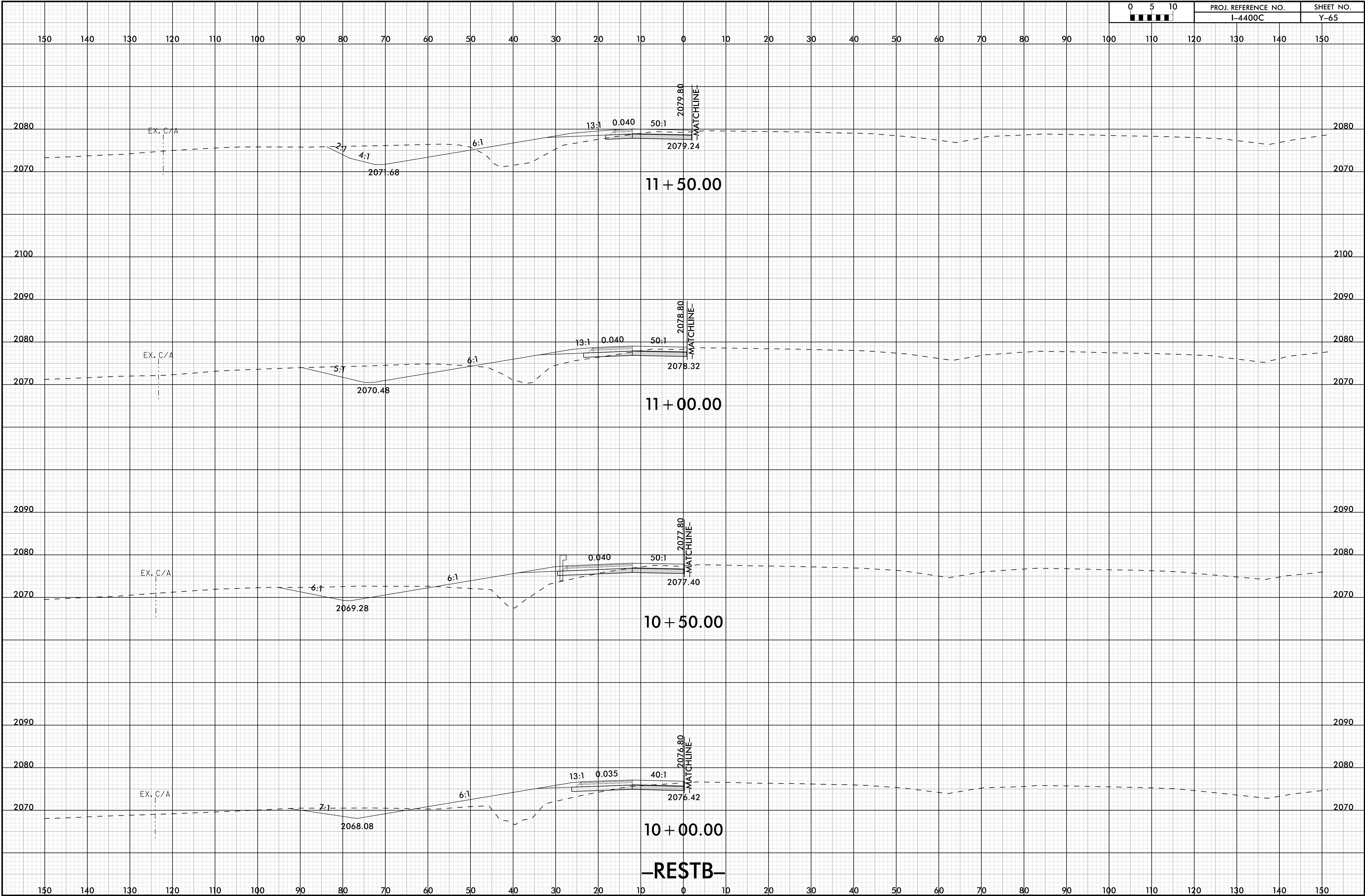
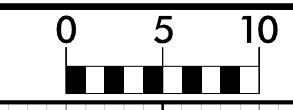

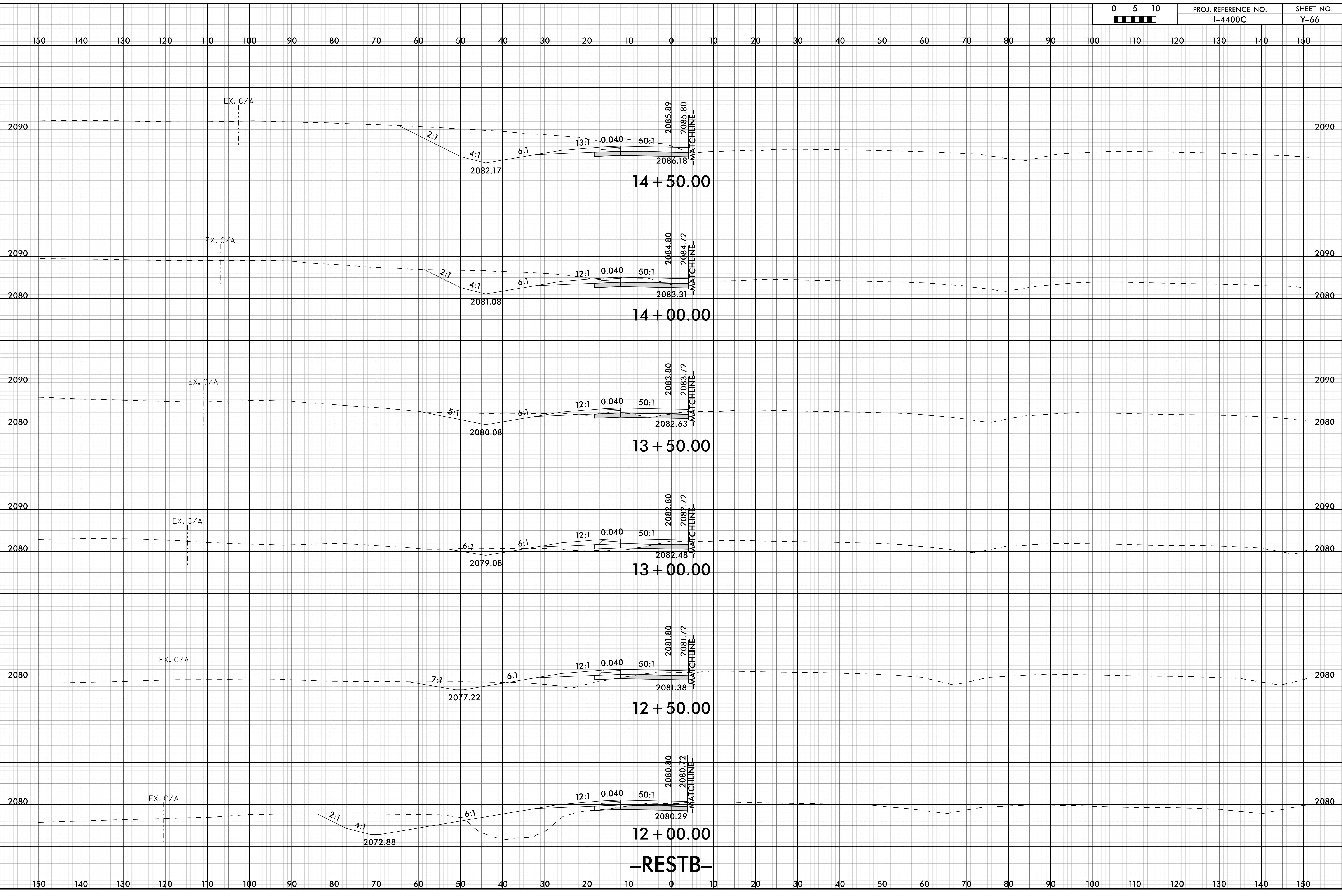

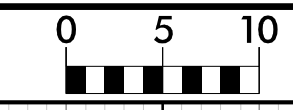

150 140 130 120 110 100 90 80 70 60 50 40 30 20 10 0 10 20 30 40 50 60 70 80 90 100 110 120 130 140 150

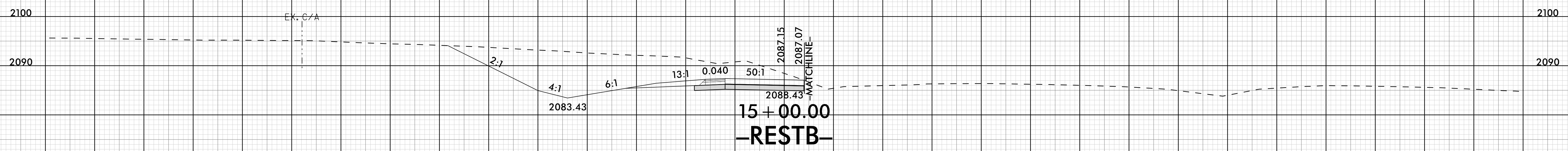
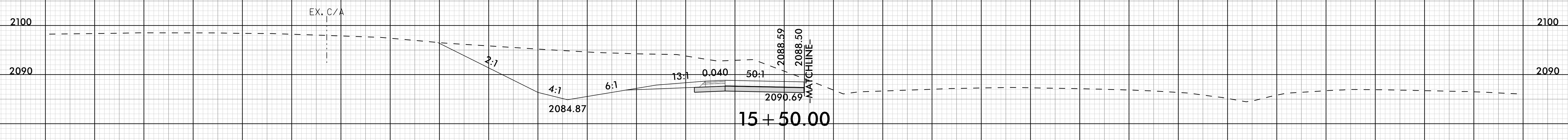
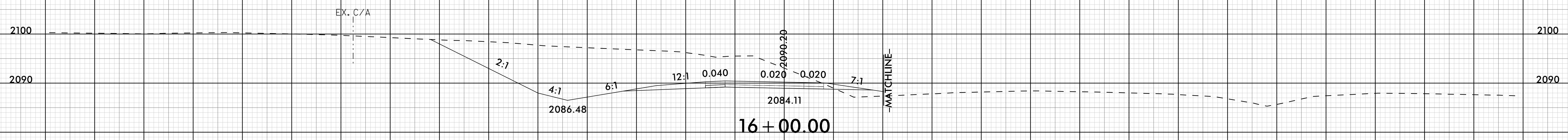
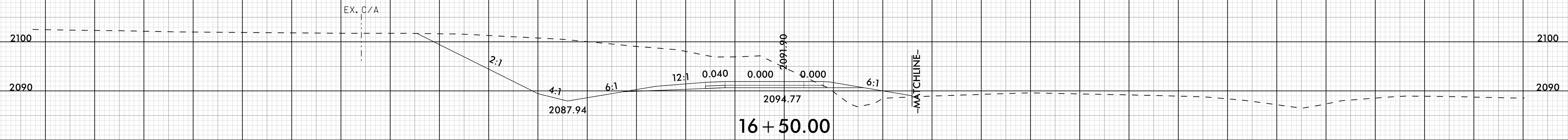

-RESTB-

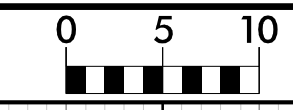

150 140 130 120 110 100 90 80 70 60 50 40 30 20 10 0 10 20 30 40 50 60 70 80 90 100 110 120 130 140 150

2130 2130

2120 2120

2110 2110

2100 2100

2090 2090

2080 2080

2070 2070

2130 2130

2120 2120

2110 2110

2100 2100

2090 2090

2080 2080

2070 2070

150 140 130 120 110 100 90 80 70 60 50 40 30 20 10 0 10 20 30 40 50 60 70 80 90 100 110 120 130 140 150

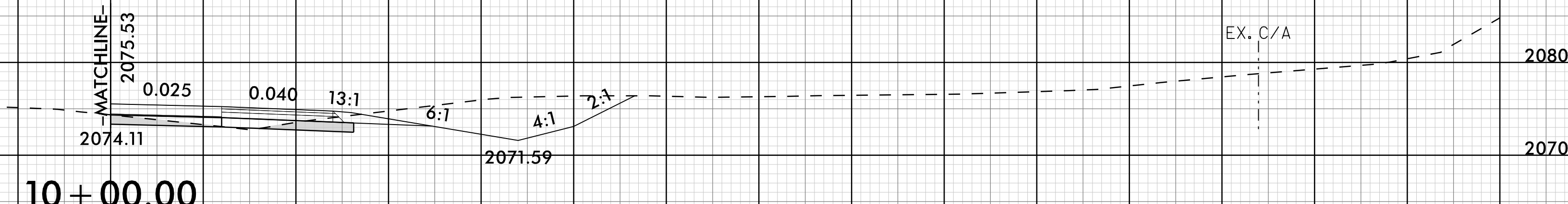
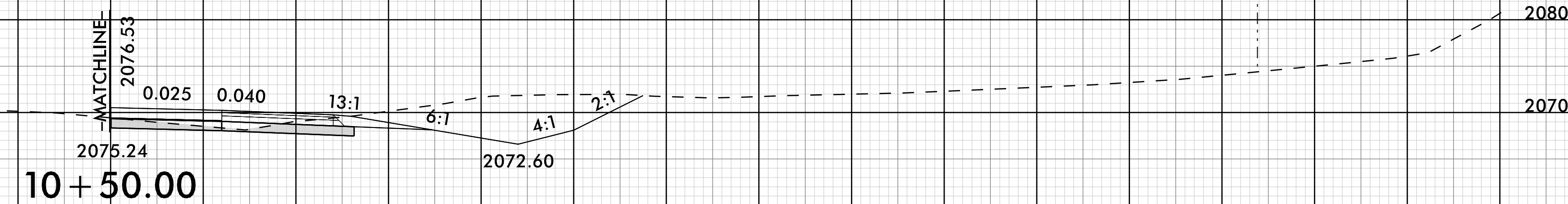

150 140 130 120 110 100 90 80 70 60 50 40 30 20 10 0 10 20 30 40 50 60 70 80 90 100 110 120 130 140 150

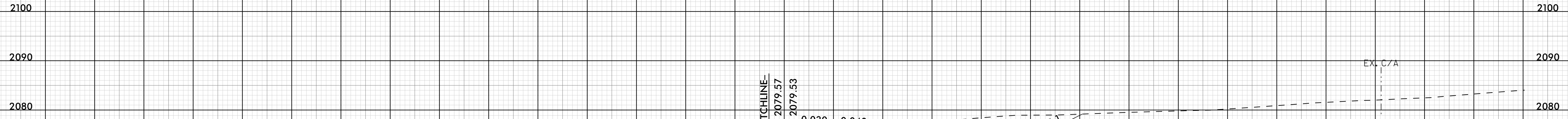

12 + 00.00

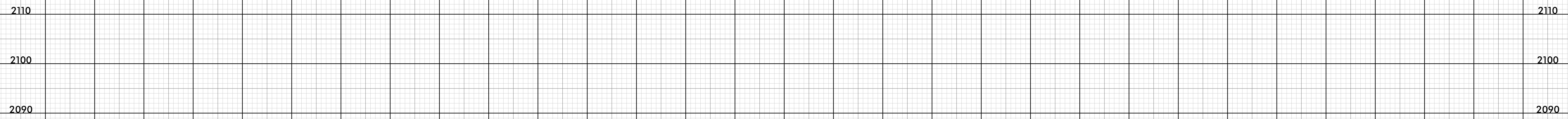

11 + 50.00

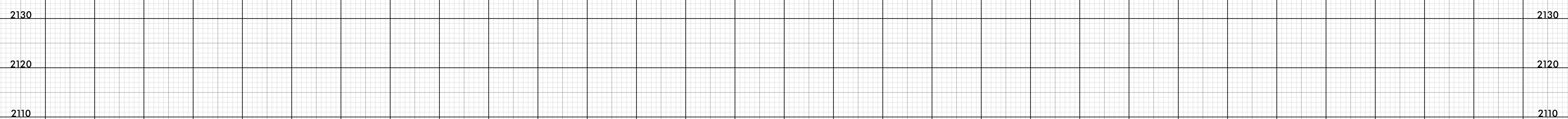

11 + 00.00

RESTC

150 140 130 120 110 100 90 80 70 60 50 40 30 20 10 0 10 20 30 40 50 60 70 80 90 100 110 120 130 140 150

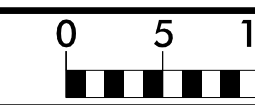

150 140 130 120 110 100 90 80 70 60 50 40 30 20 10 0 10 20 30 40 50 60 70 80 90 100 110 120 130 140 150

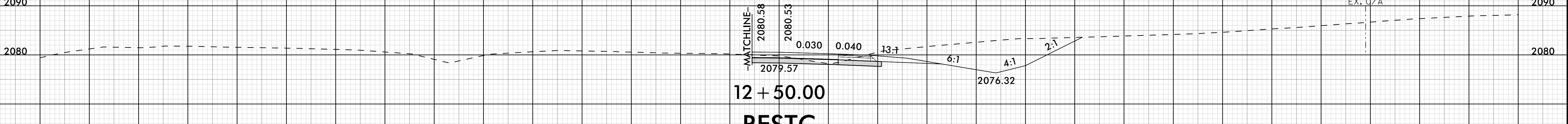
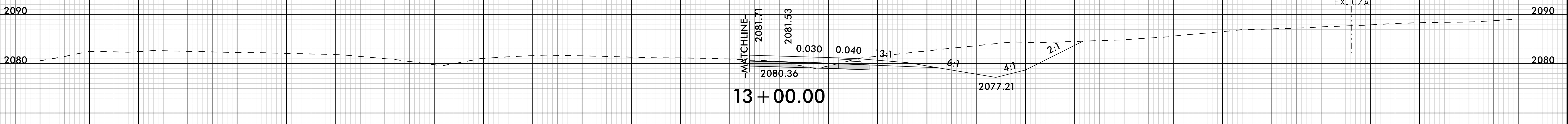
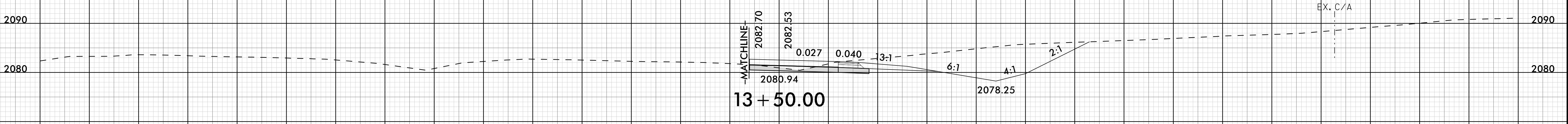
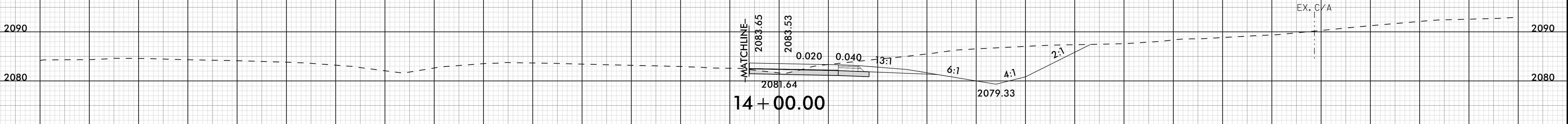
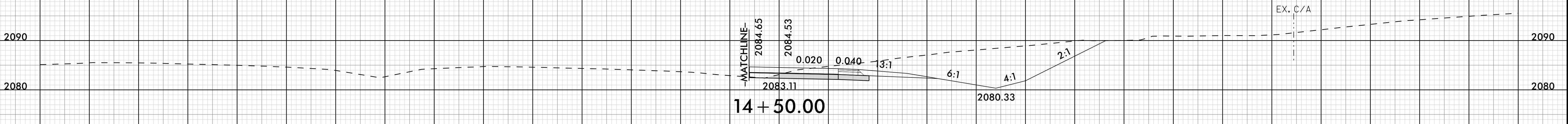
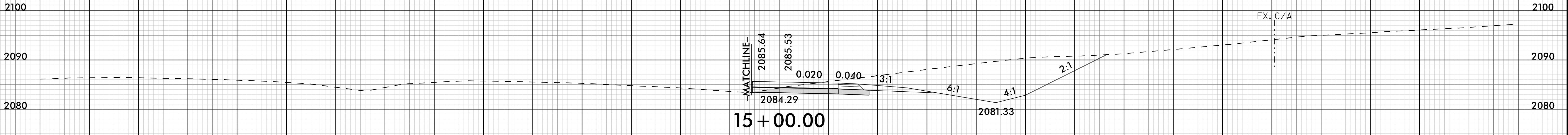

150 140 130 120 110 100 90 80 70 60 50 40 30 20 10 0 10 20 30 40 50 60 70 80 90 100 110 120 130 140 150

-RESTC-

150 140 130 120 110 100 90 80 70 60 50 40 30 20 10 0 10 20 30 40 50 60 70 80 90 100 110 120 130 140 150

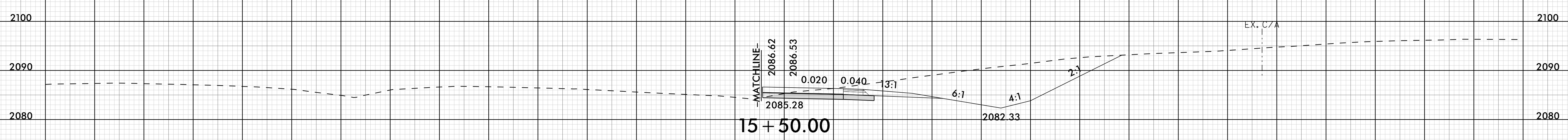
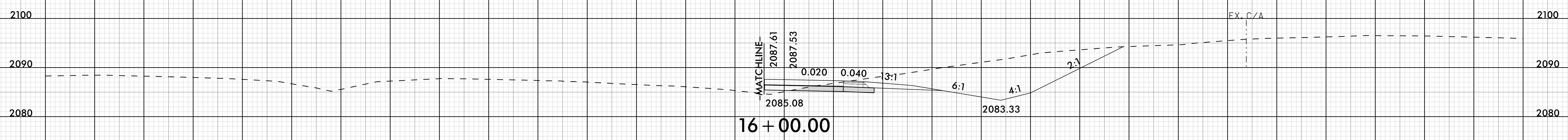
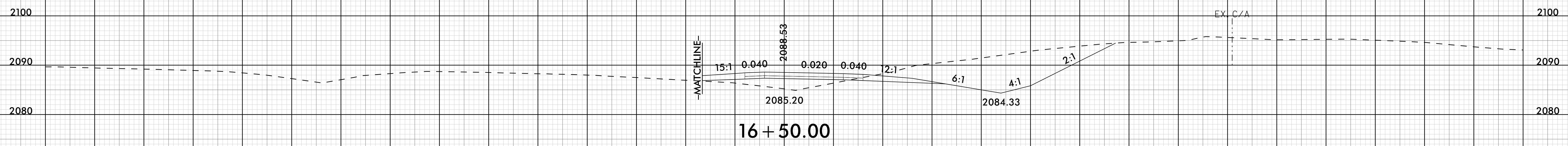
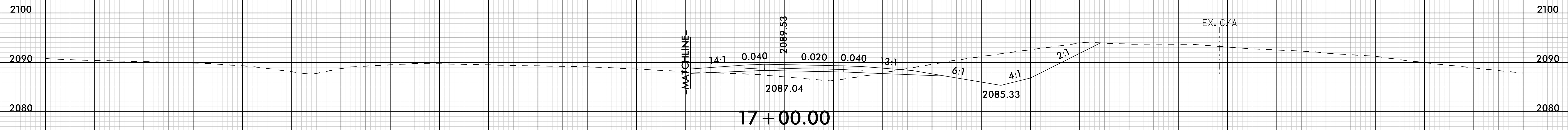

-RESTC-

150 140 130 120 110 100 90 80 70 60 50 40 30 20 10 0 10 20 30 40 50 60 70 80 90 100 110 120 130 140 150

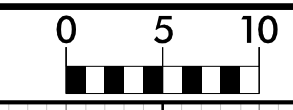

150 140 130 120 110 100 90 80 70 60 50 40 30 20 10 0 10 20 30 40 50 60 70 80 90 100 110 120 130 140 150

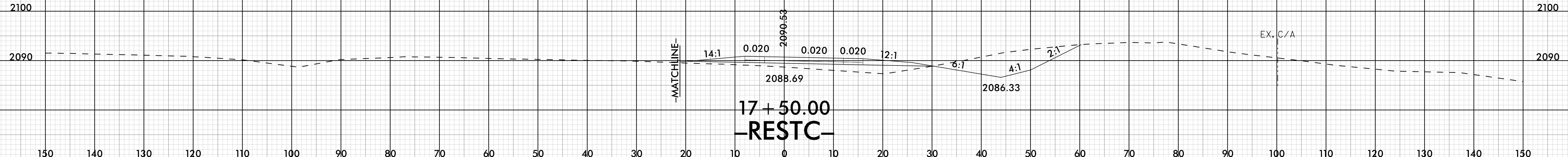

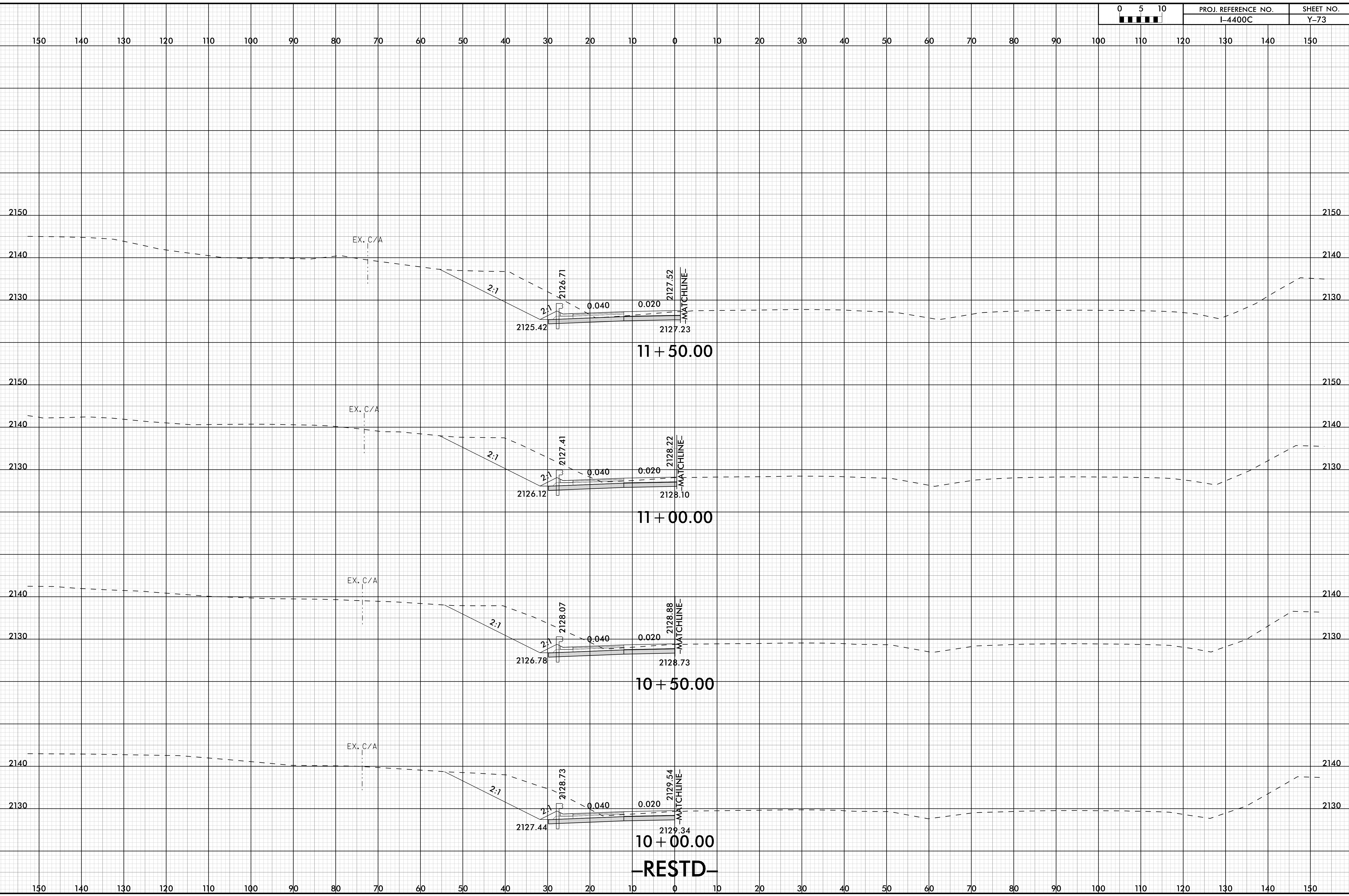
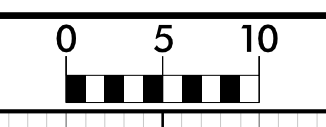

11 + 50.00

11 + 00.00

10 + 50.00

10 + 00.00

RESTD

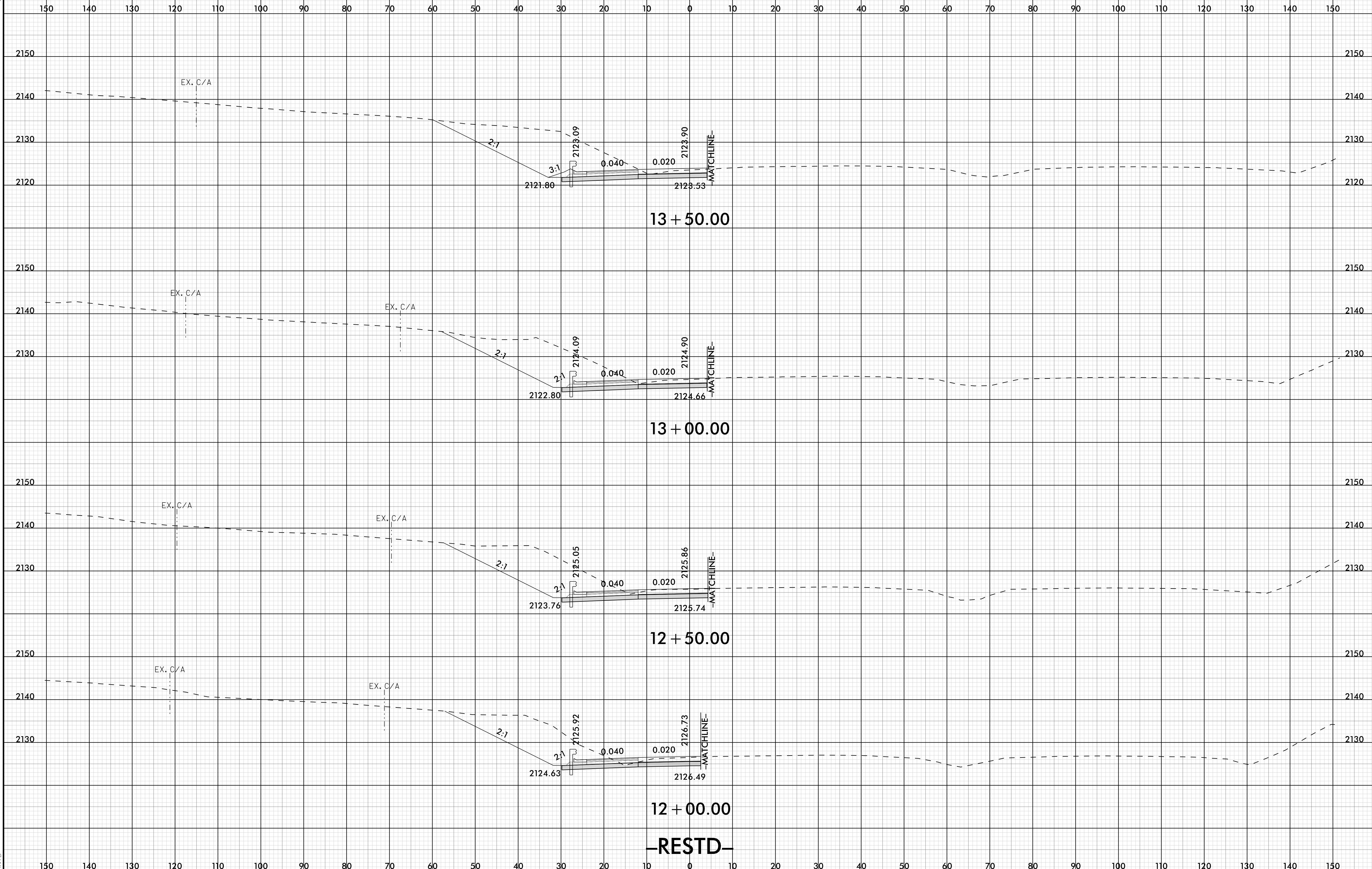
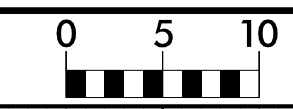

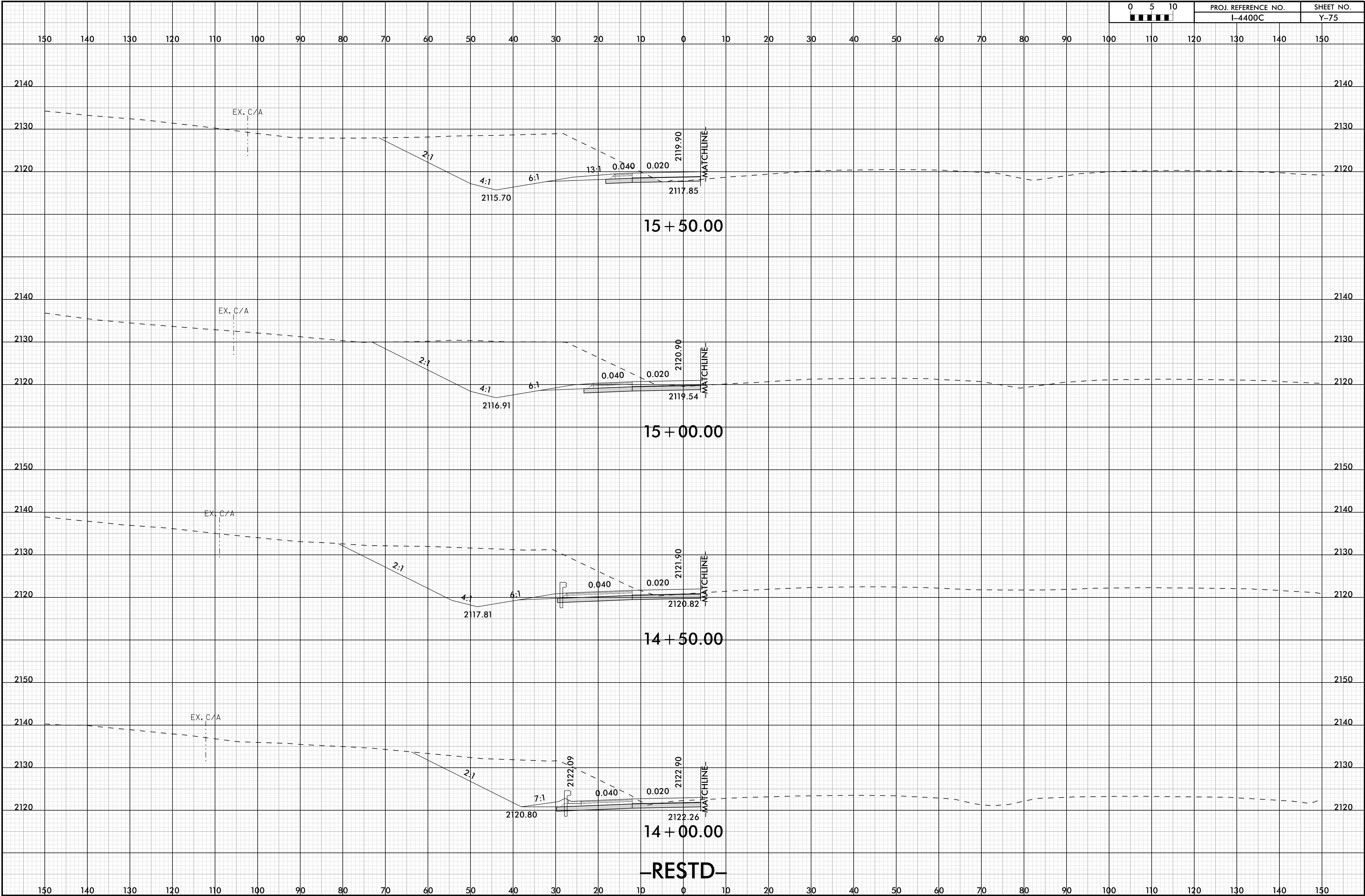

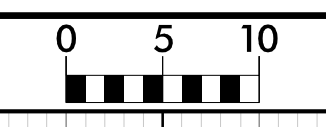

150 140 130 120 110 100 90 80 70 60 50 40 30 20 10 0 10 20 30 40 50 60 70 80 90 100 110 120 130 140 150

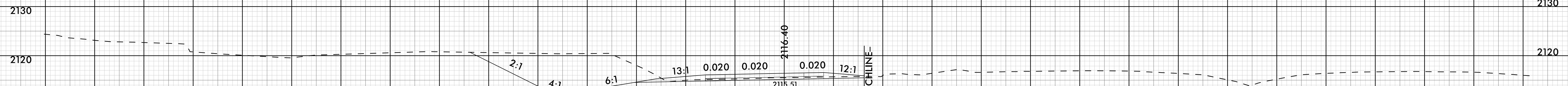

17 + 24.90

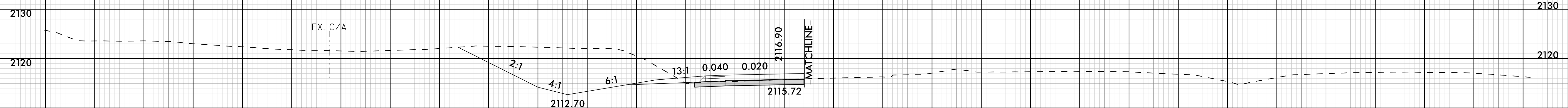

17 + 00.00

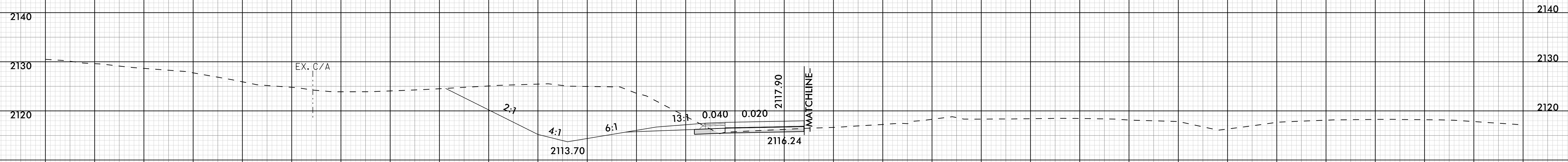

16 + 50.00

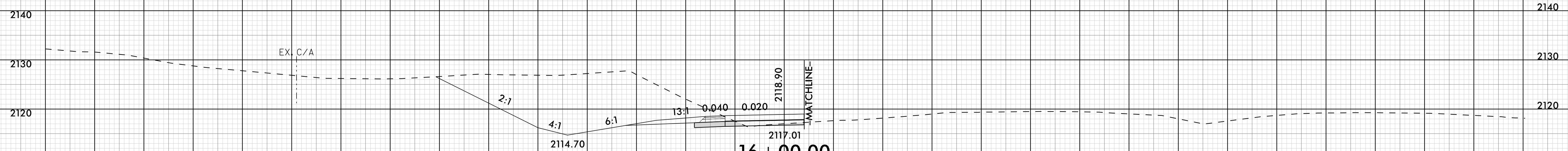

16 + 00.00

RESTD

150 140 130 120 110 100 90 80 70 60 50 40 30 20 10 0 10 20 30 40 50 60 70 80 90 100 110 120 130 140 150

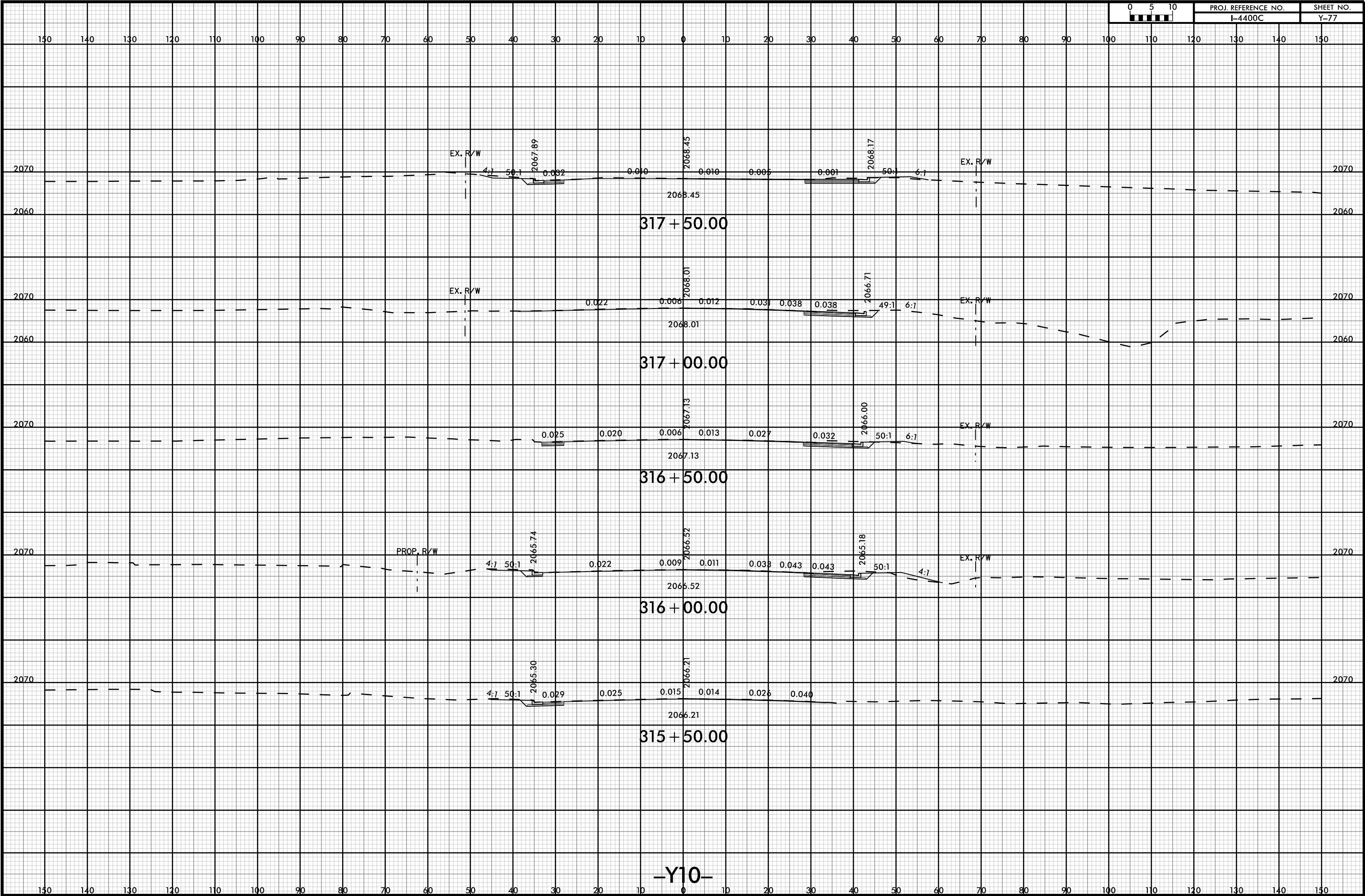

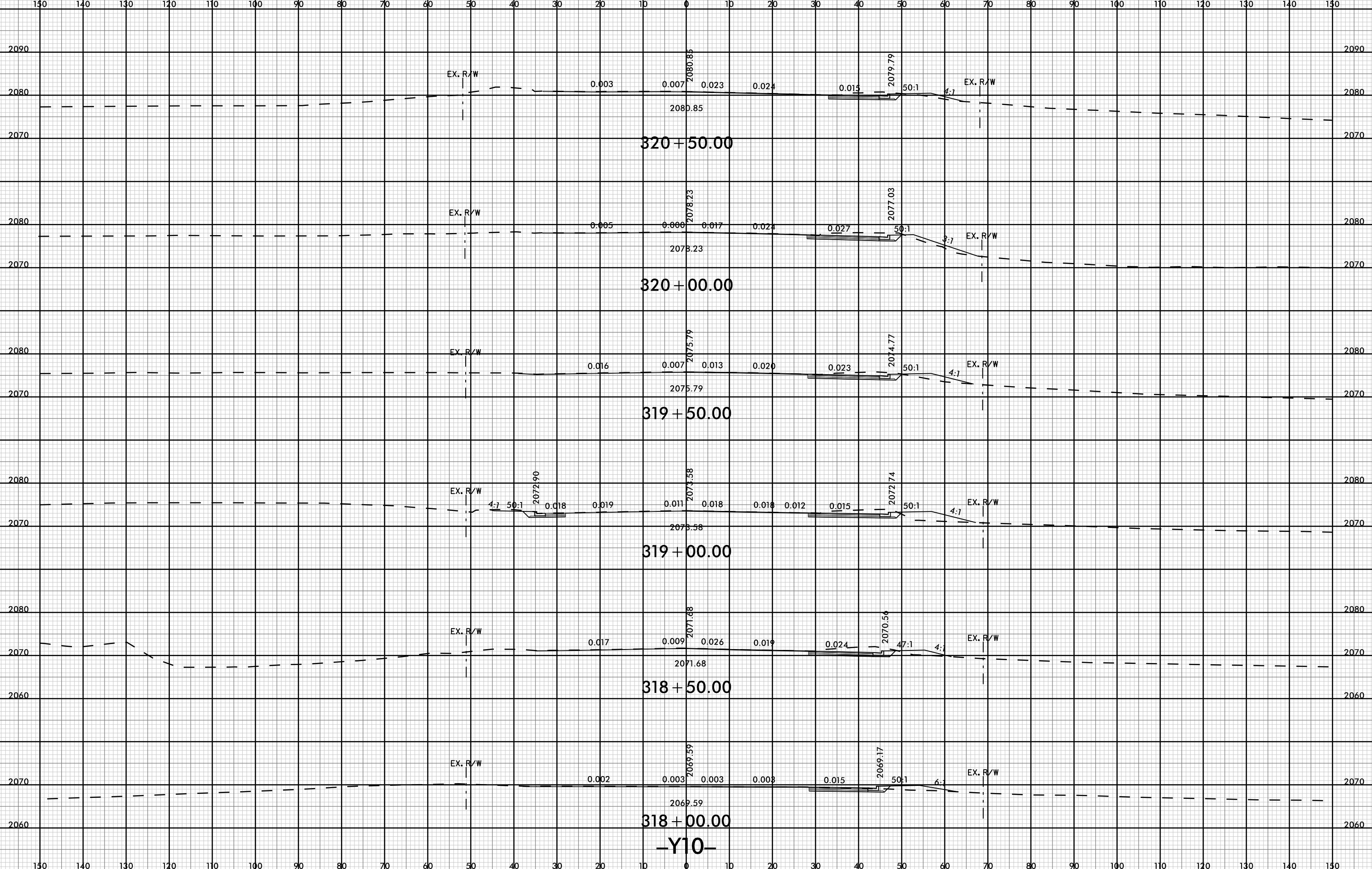
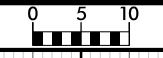

-Y10-

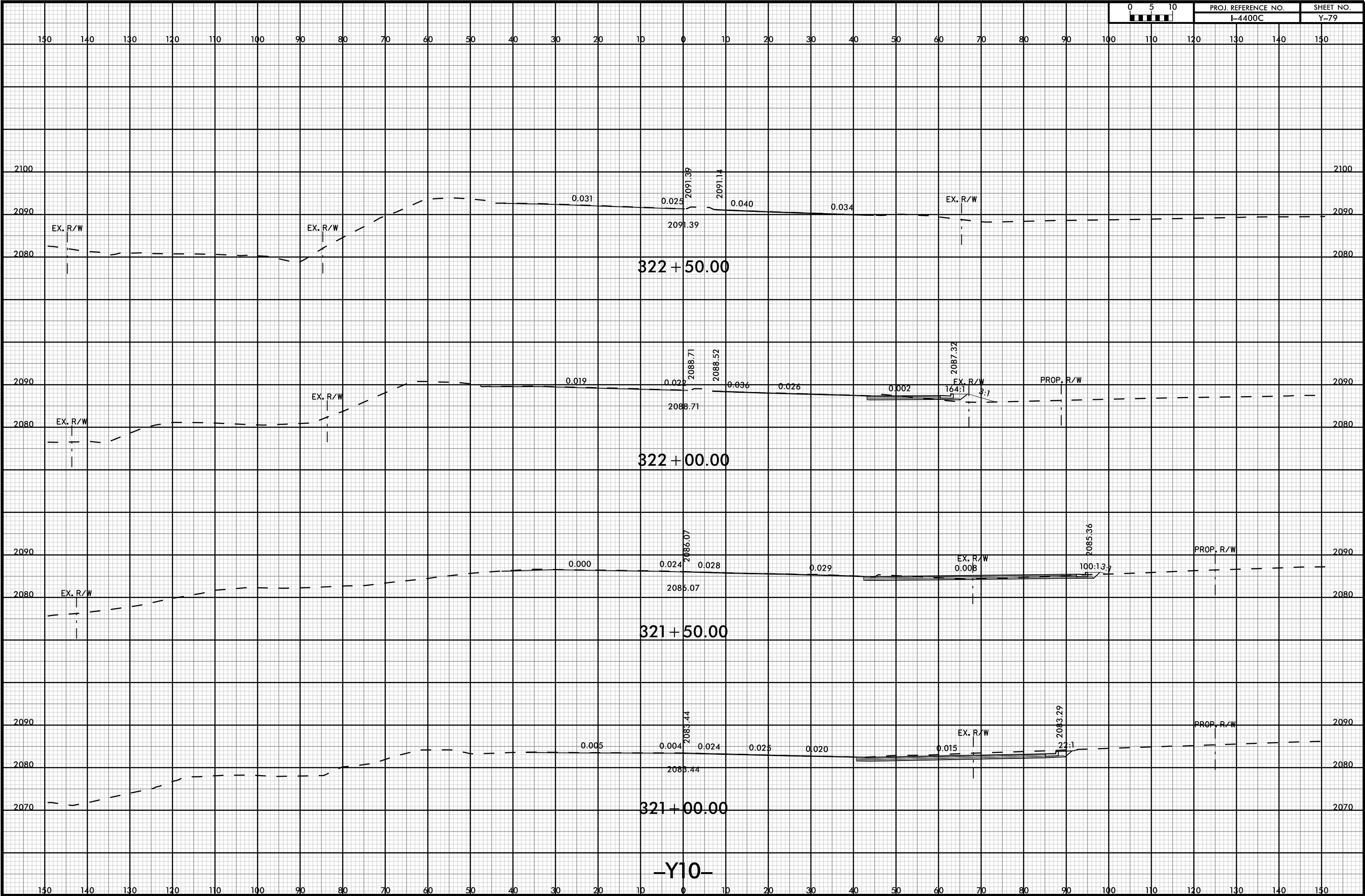

-Y10-

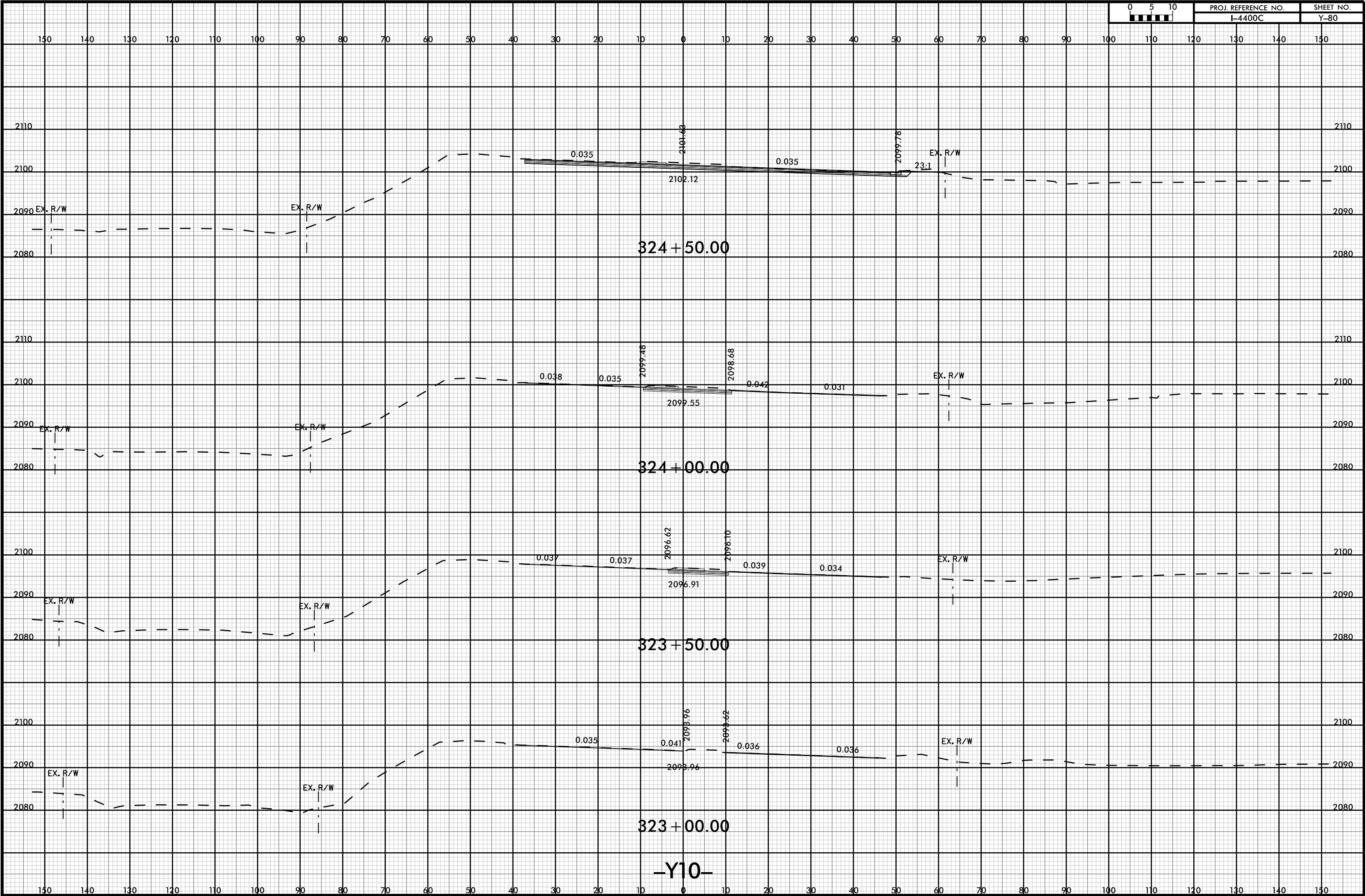

324 + 50.00

324 + 00.00

323 + 50.00

323 + 00.00

-Y10-

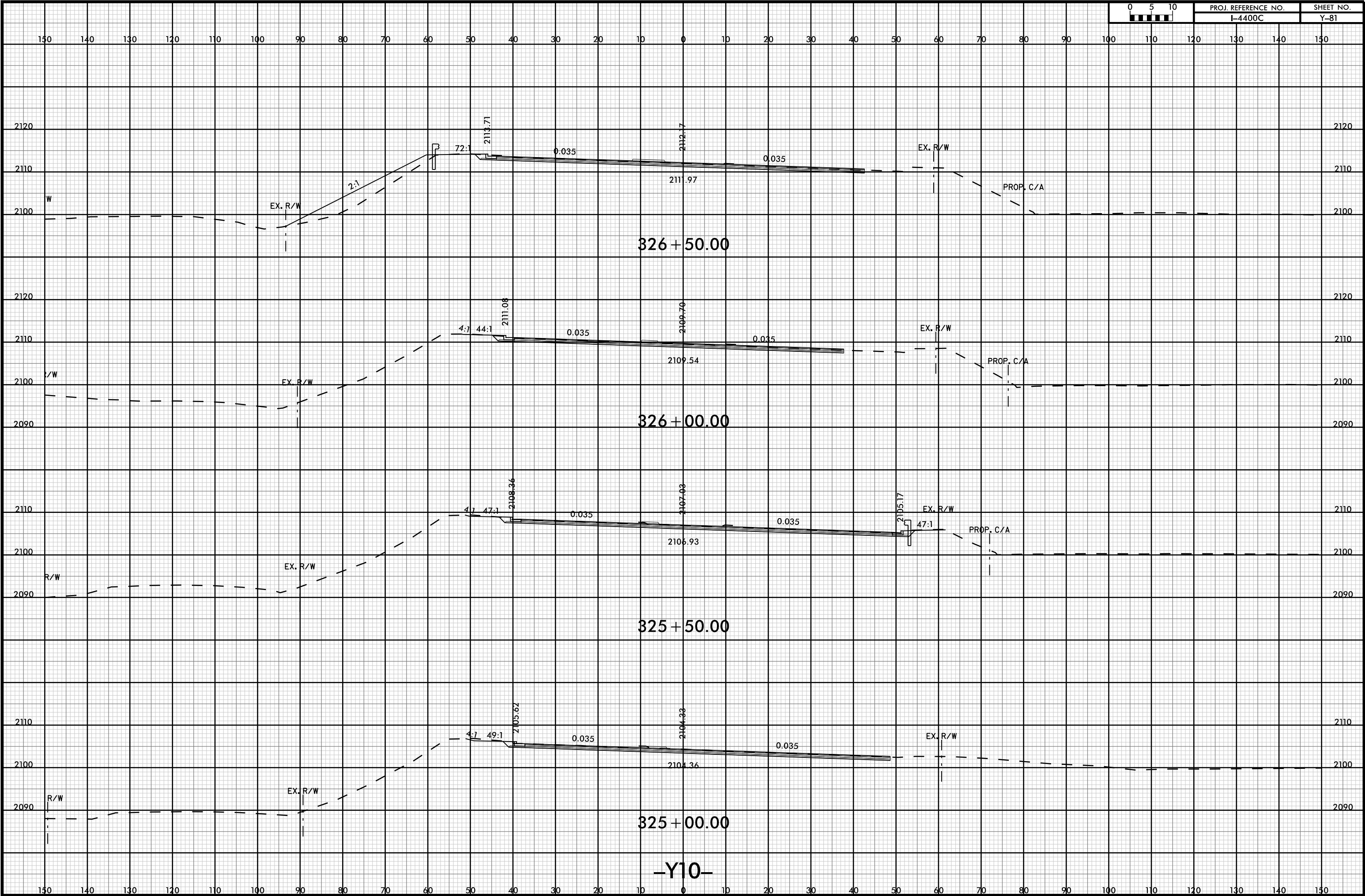

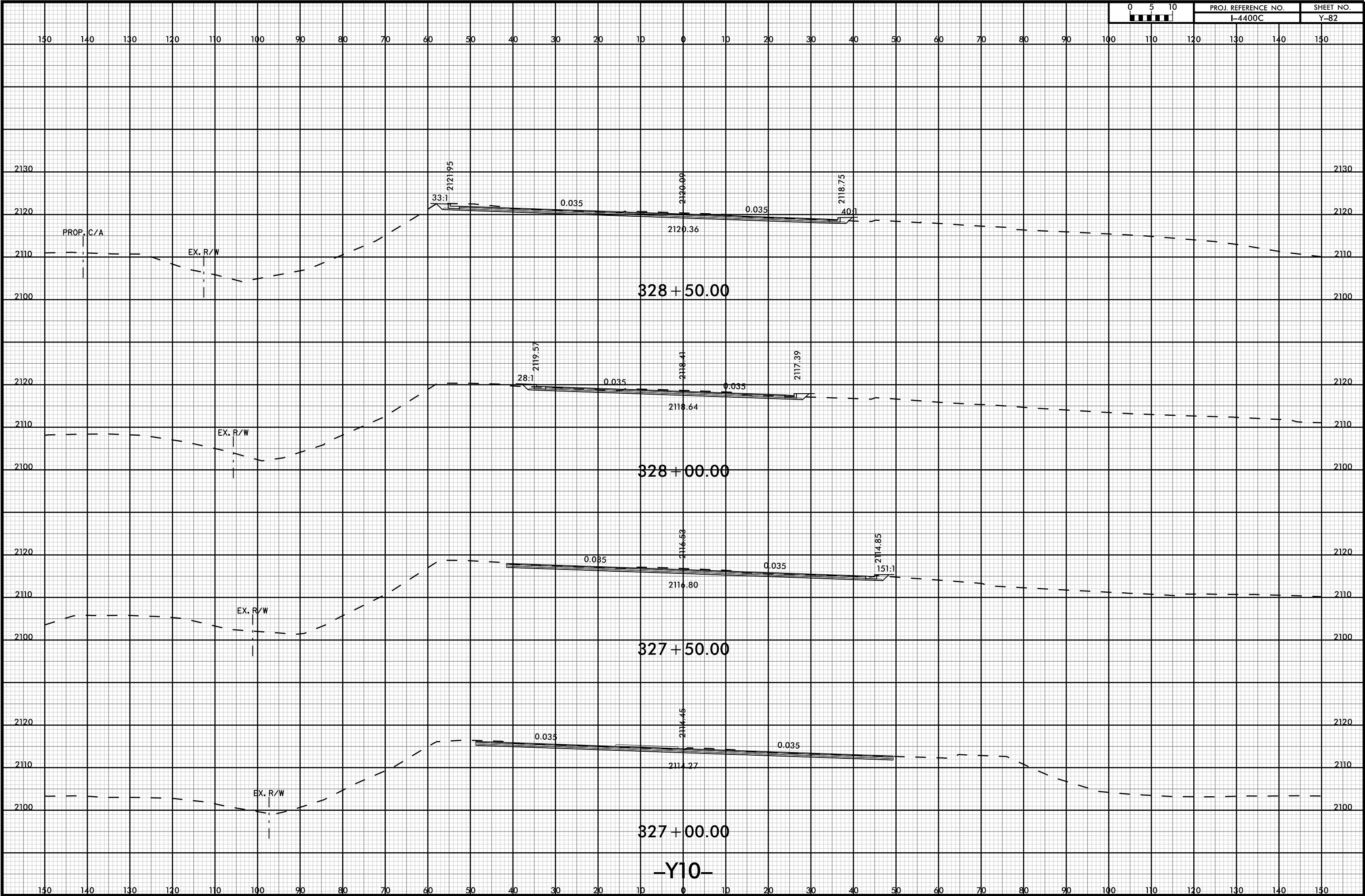

-Y10-

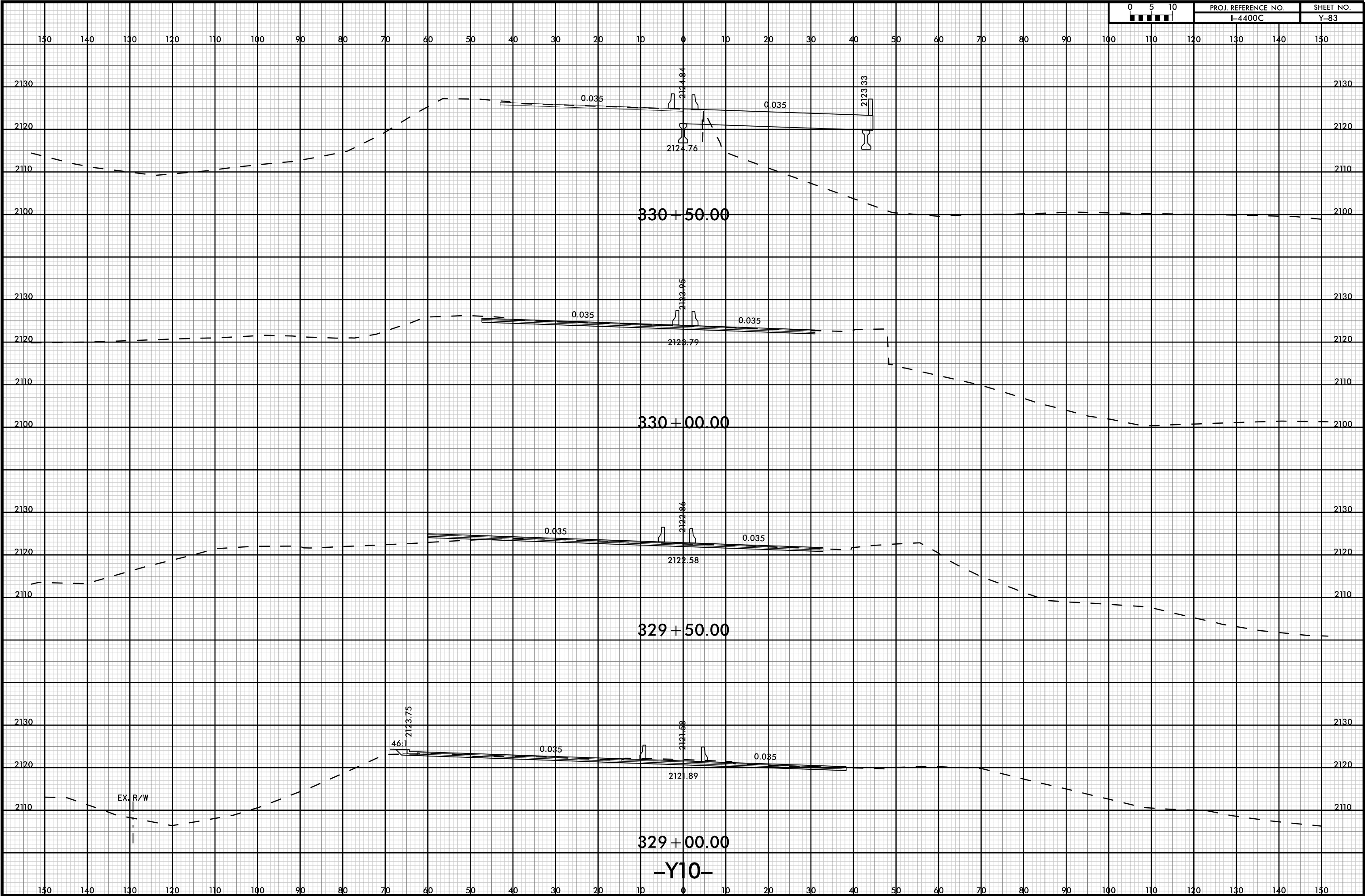

-Y10-

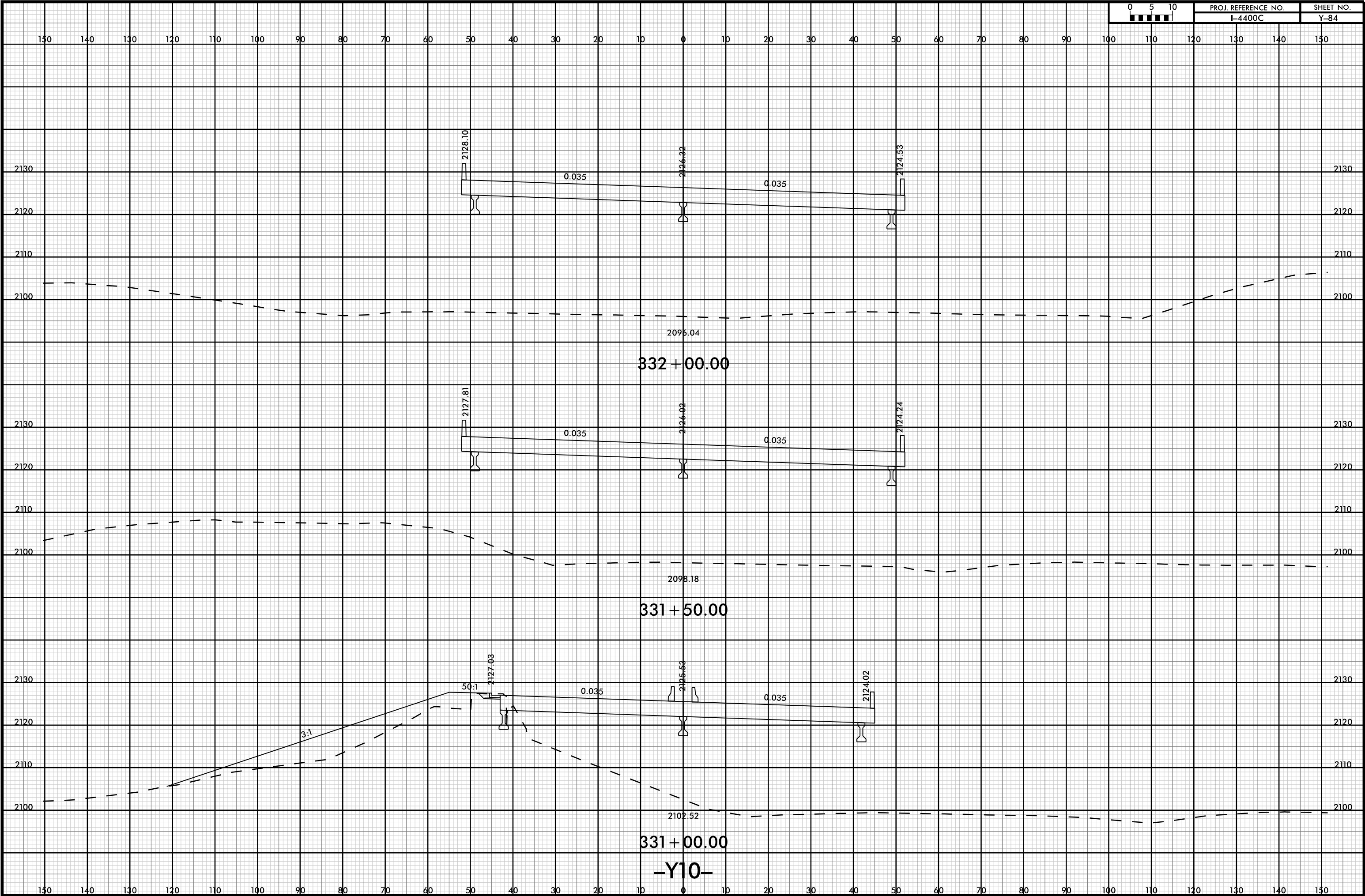

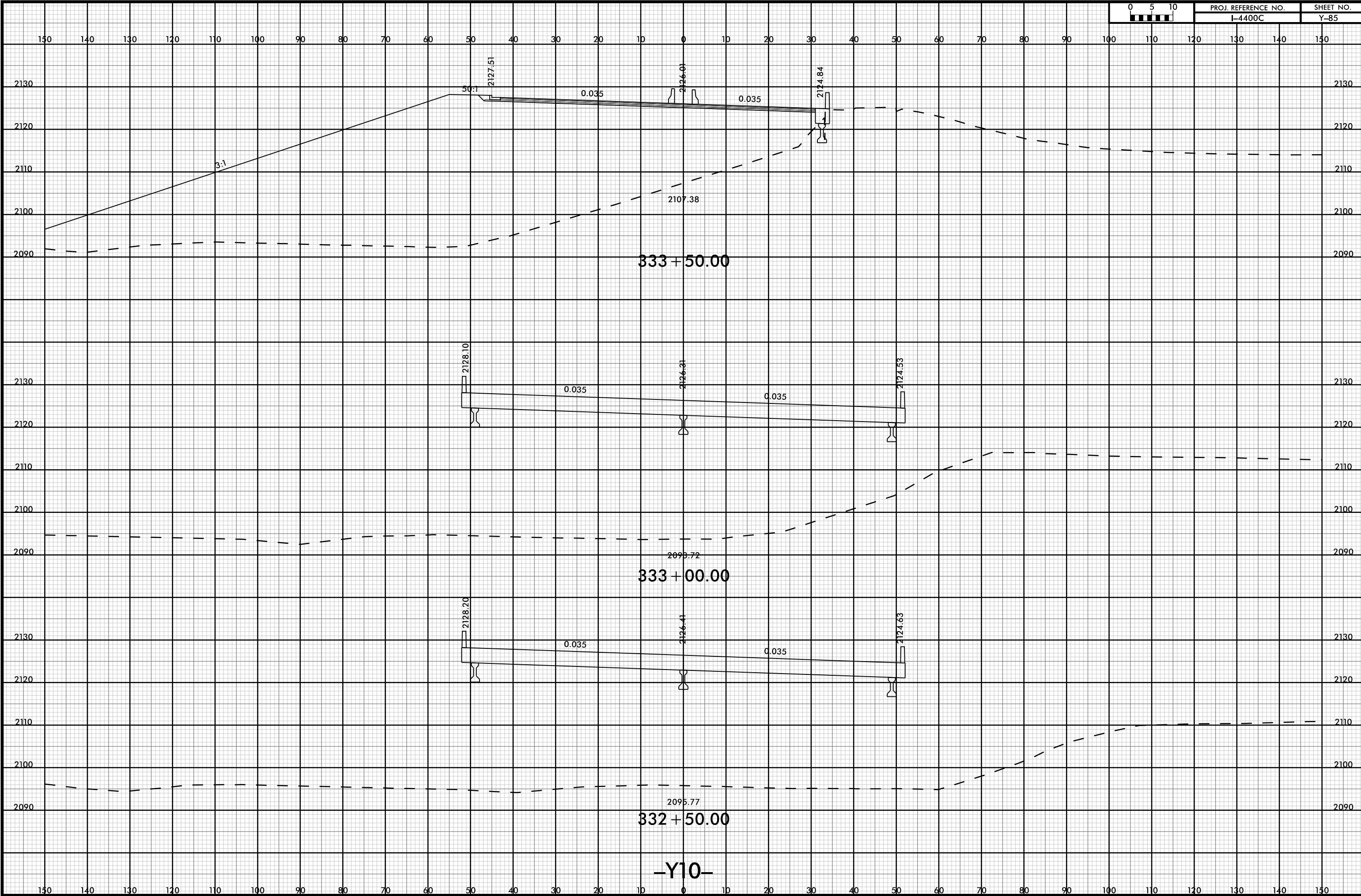

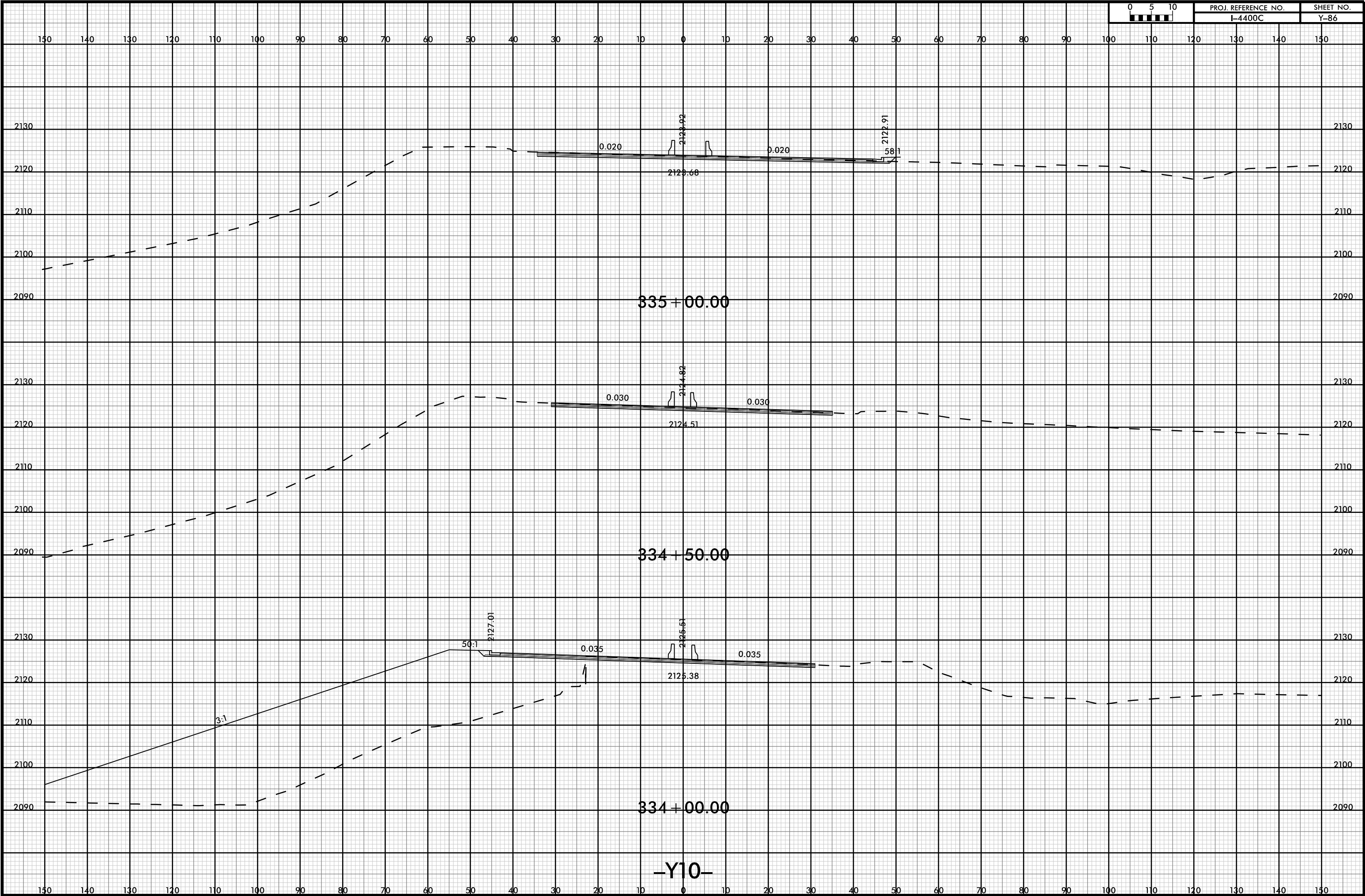
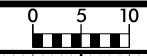

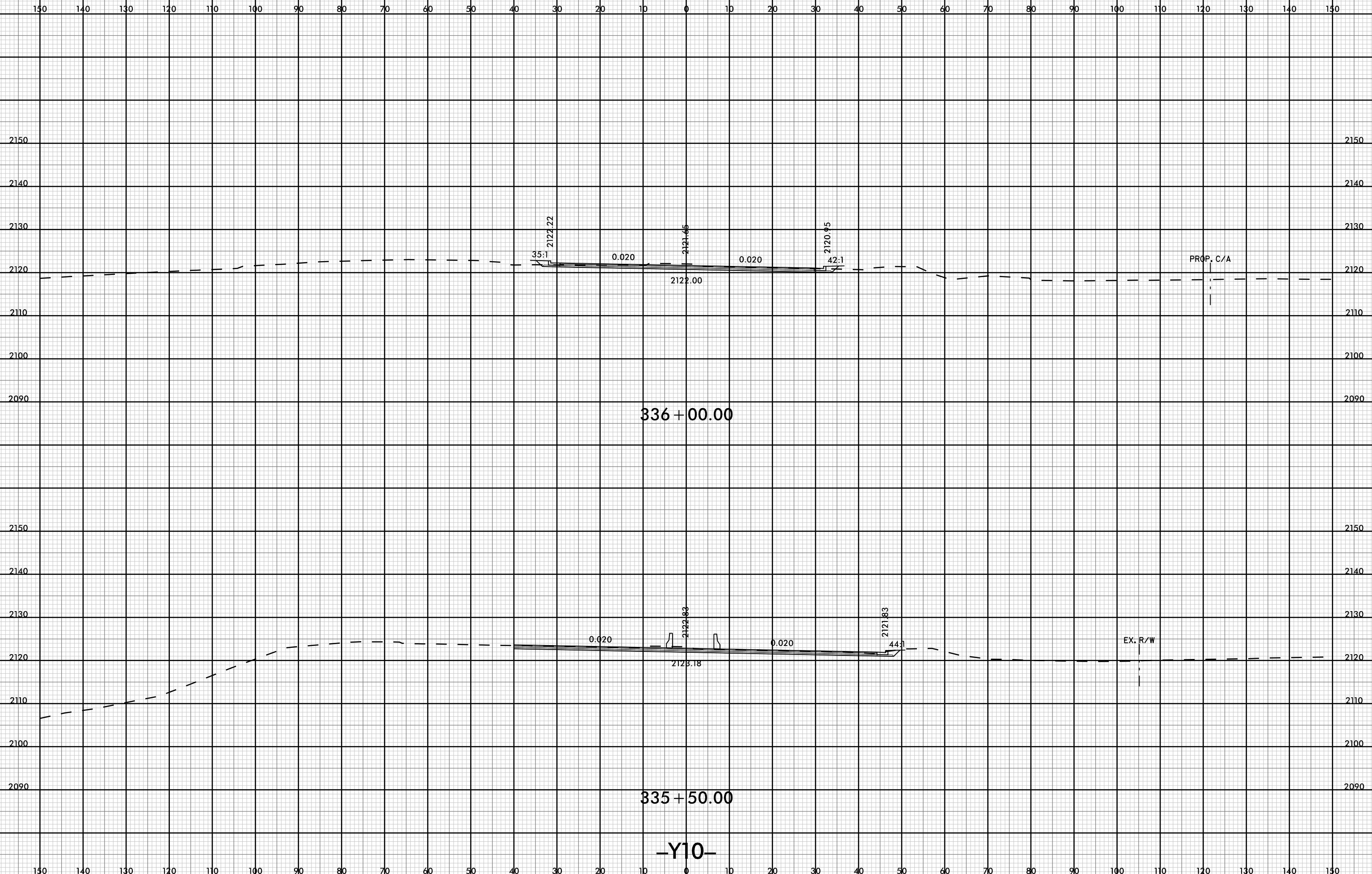

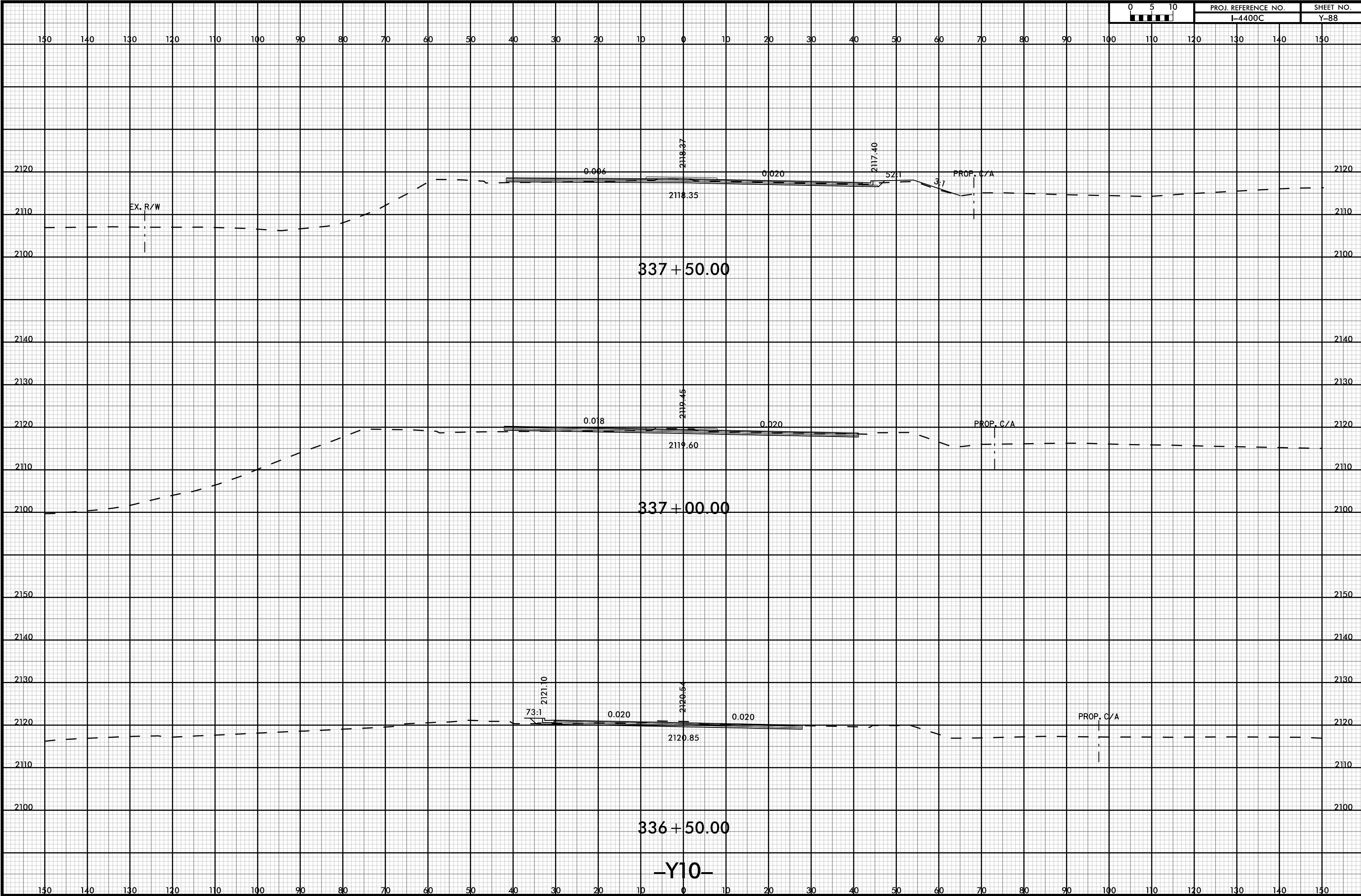

150 140 130 120 110 100 90 80 70 60 50 40 30 20 10 0 10 20 30 40 50 60 70 80 90 100 110 120 130 140 150

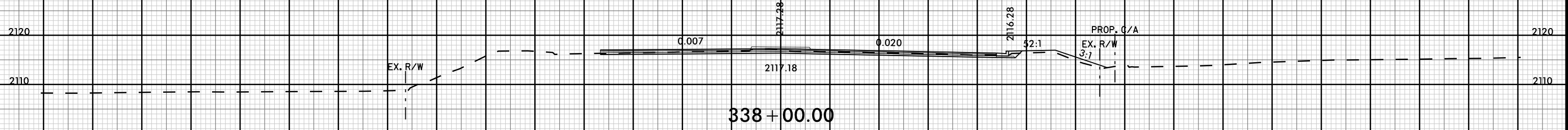
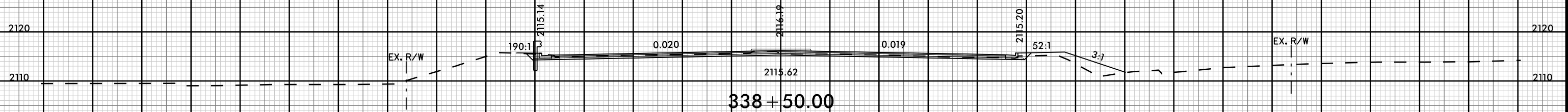
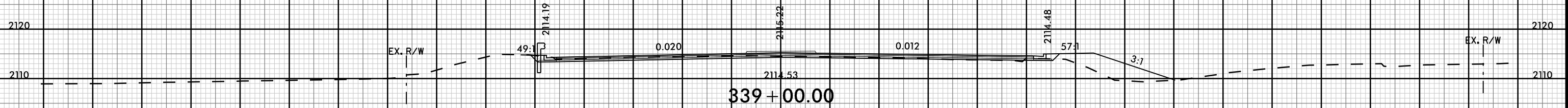
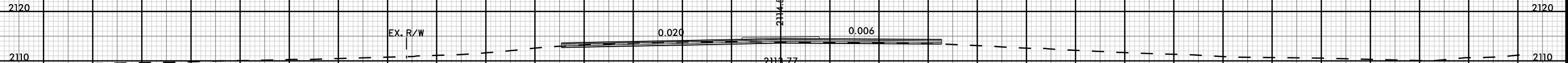

-Y10-

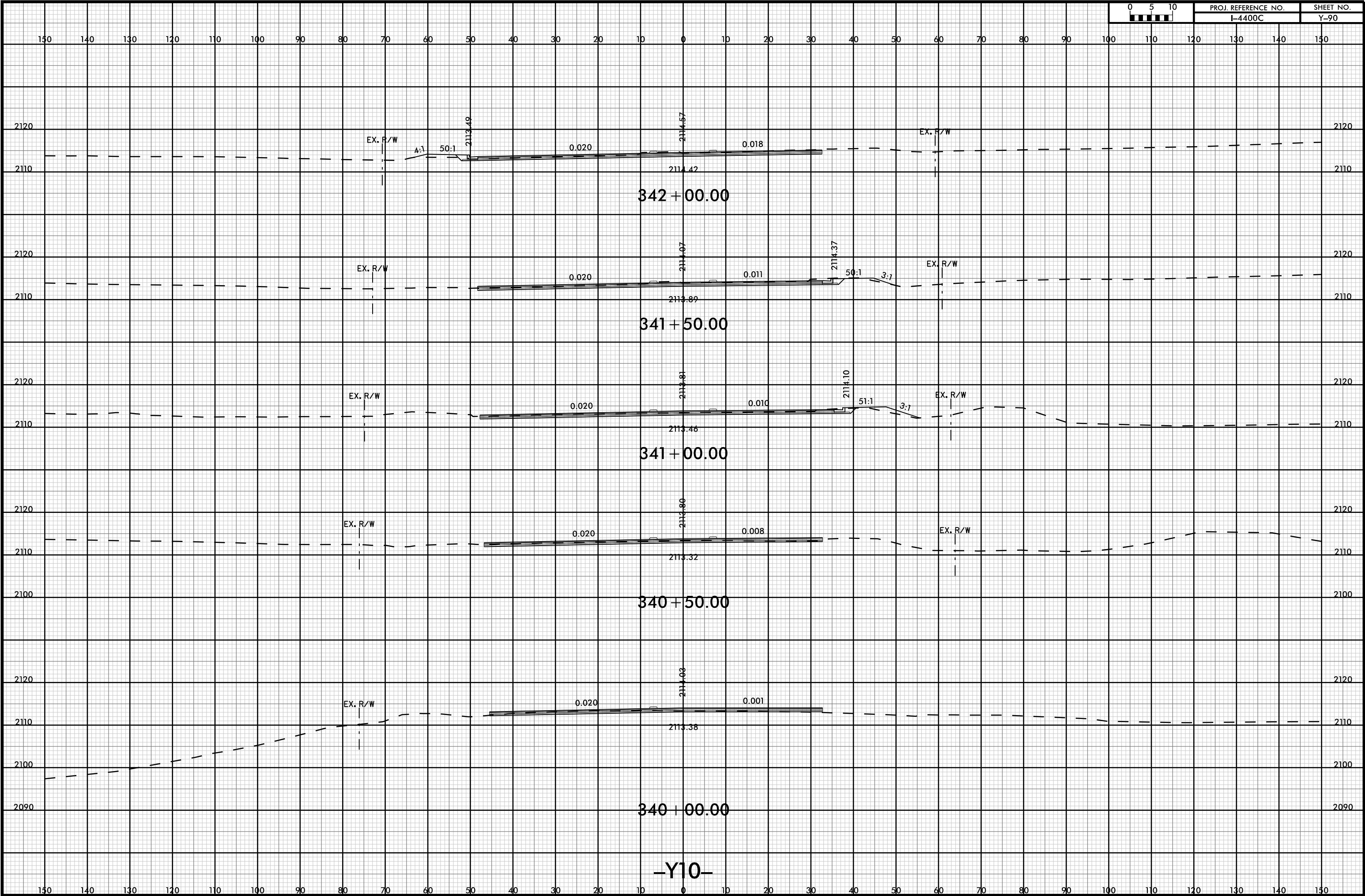



150 140 130 120 110 100 90 80 70 60 50 40 30 20 10 0 10 20 30 40 50 60 70 80 90 100 110 120 130 140 150

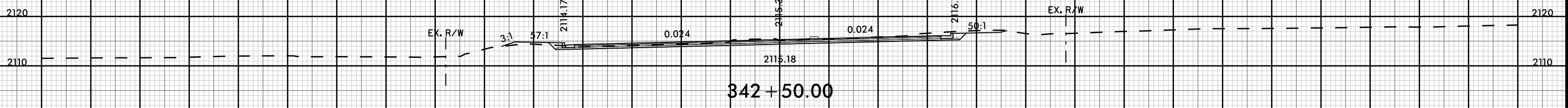
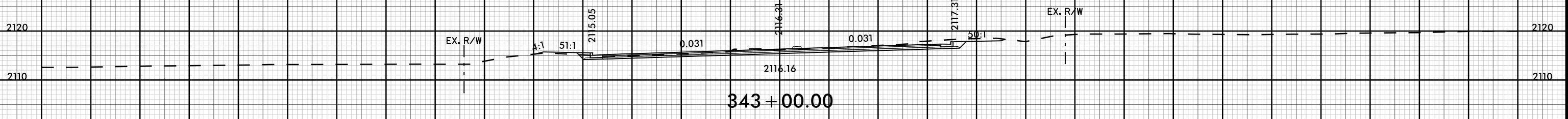
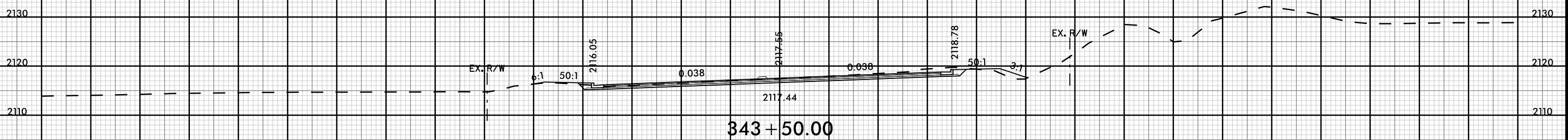
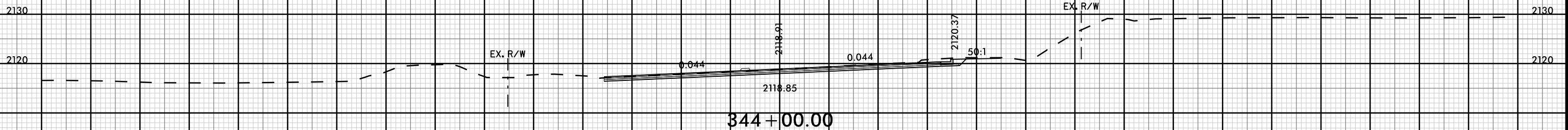
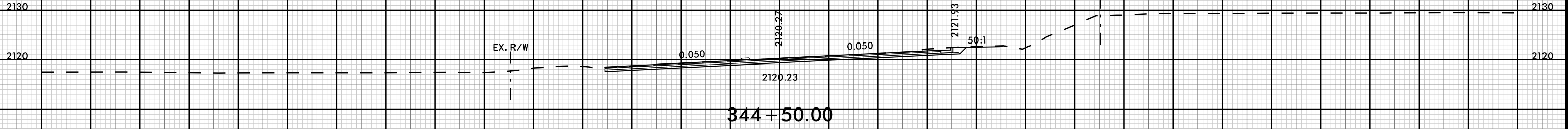

-Y10-

150 140 130 120 110 100 90 80 70 60 50 40 30 20 10 0 10 20 30 40 50 60 70 80 90 100 110 120 130 140 150

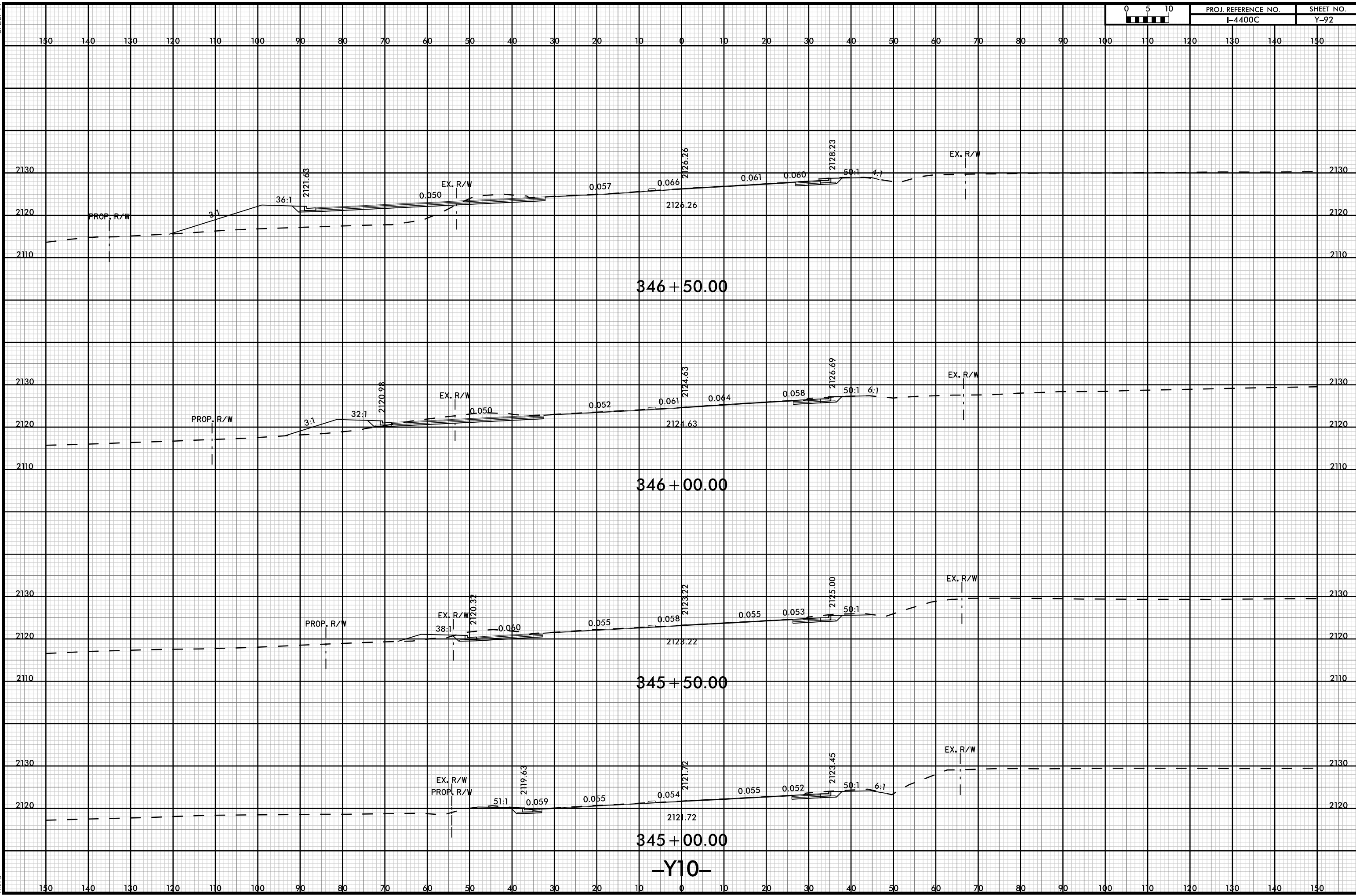

346 + 50.00

346 + 00.00

345 + 50.00

345 + 00.00

-Y10-

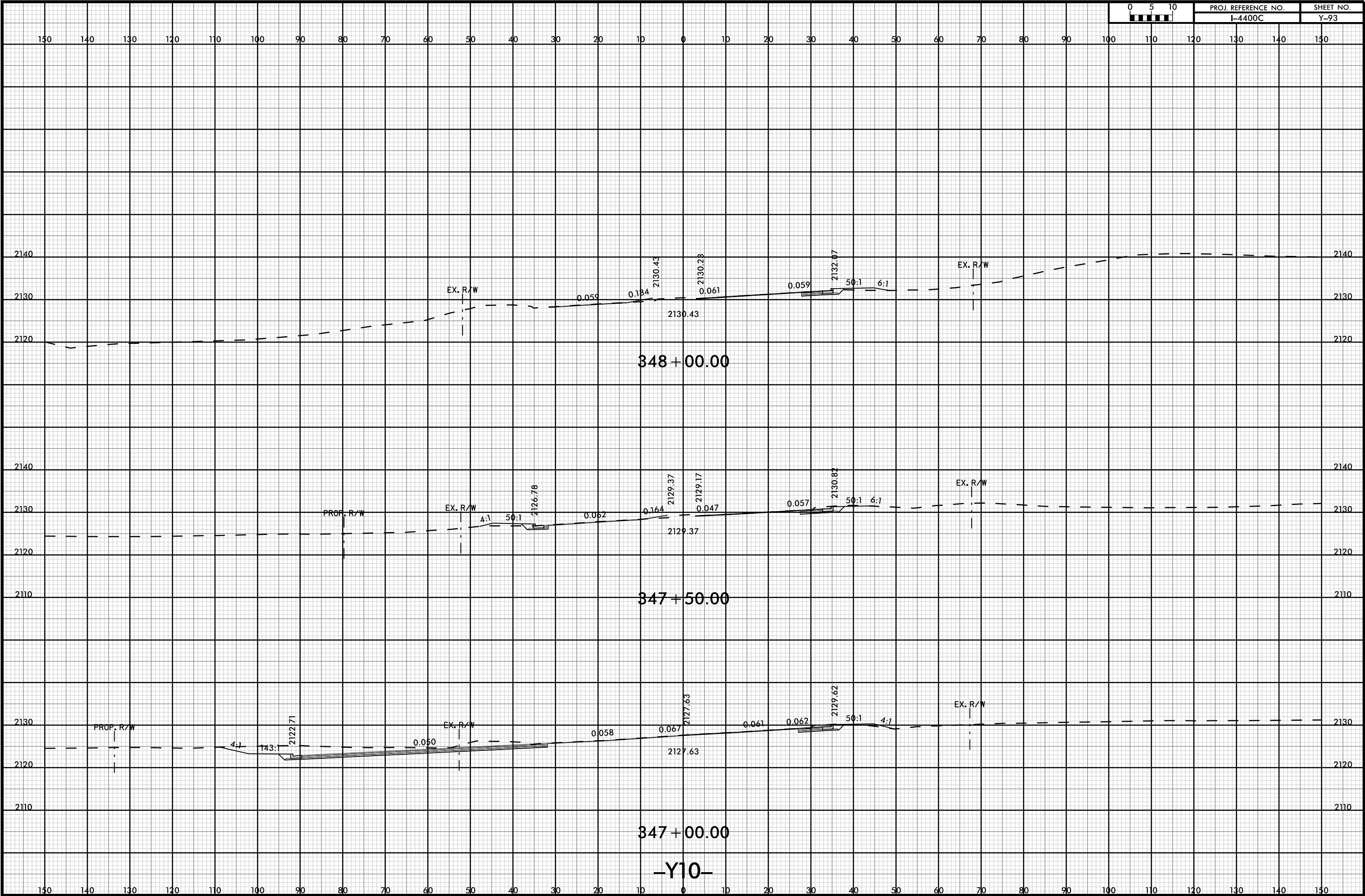

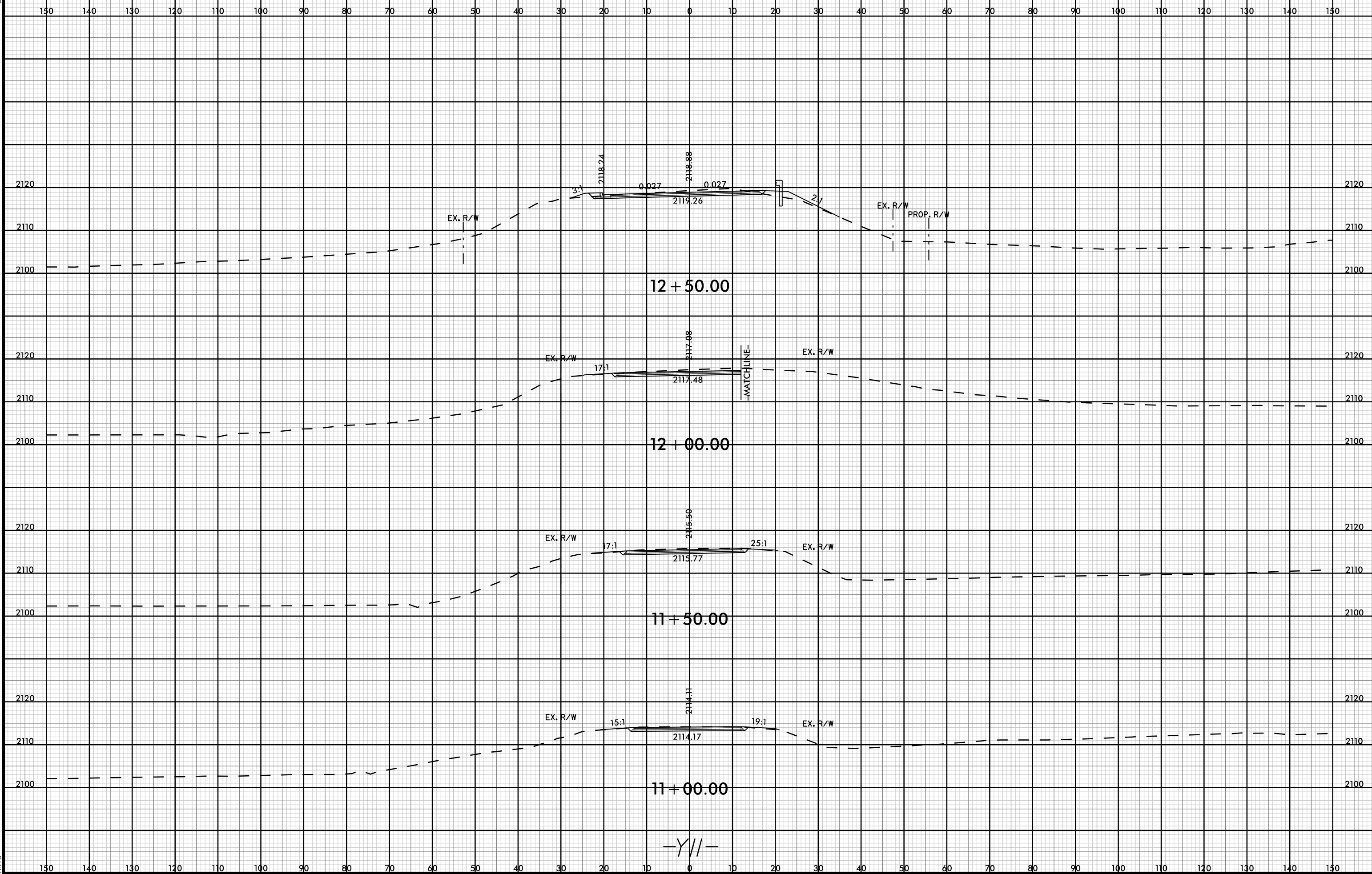

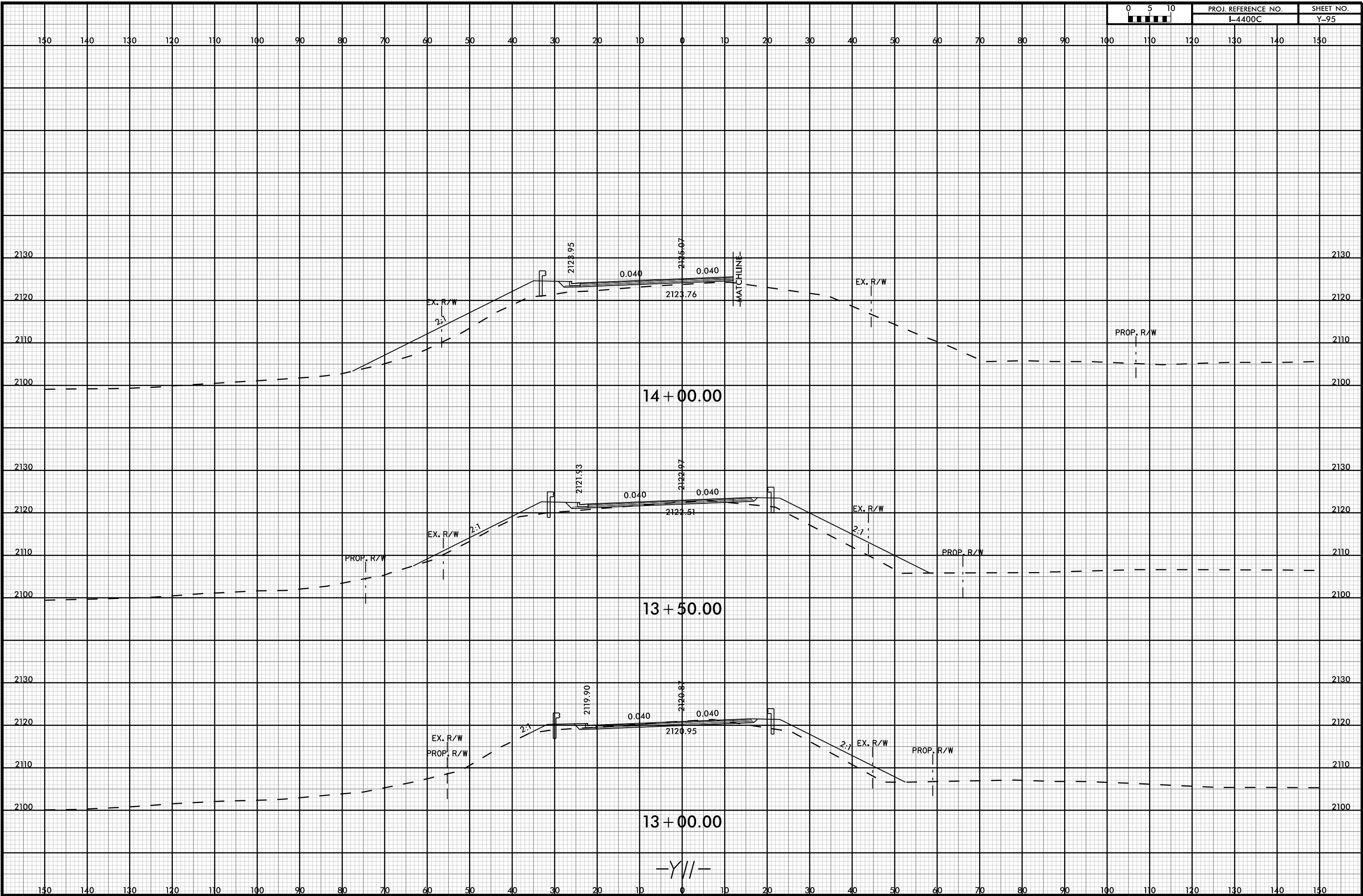

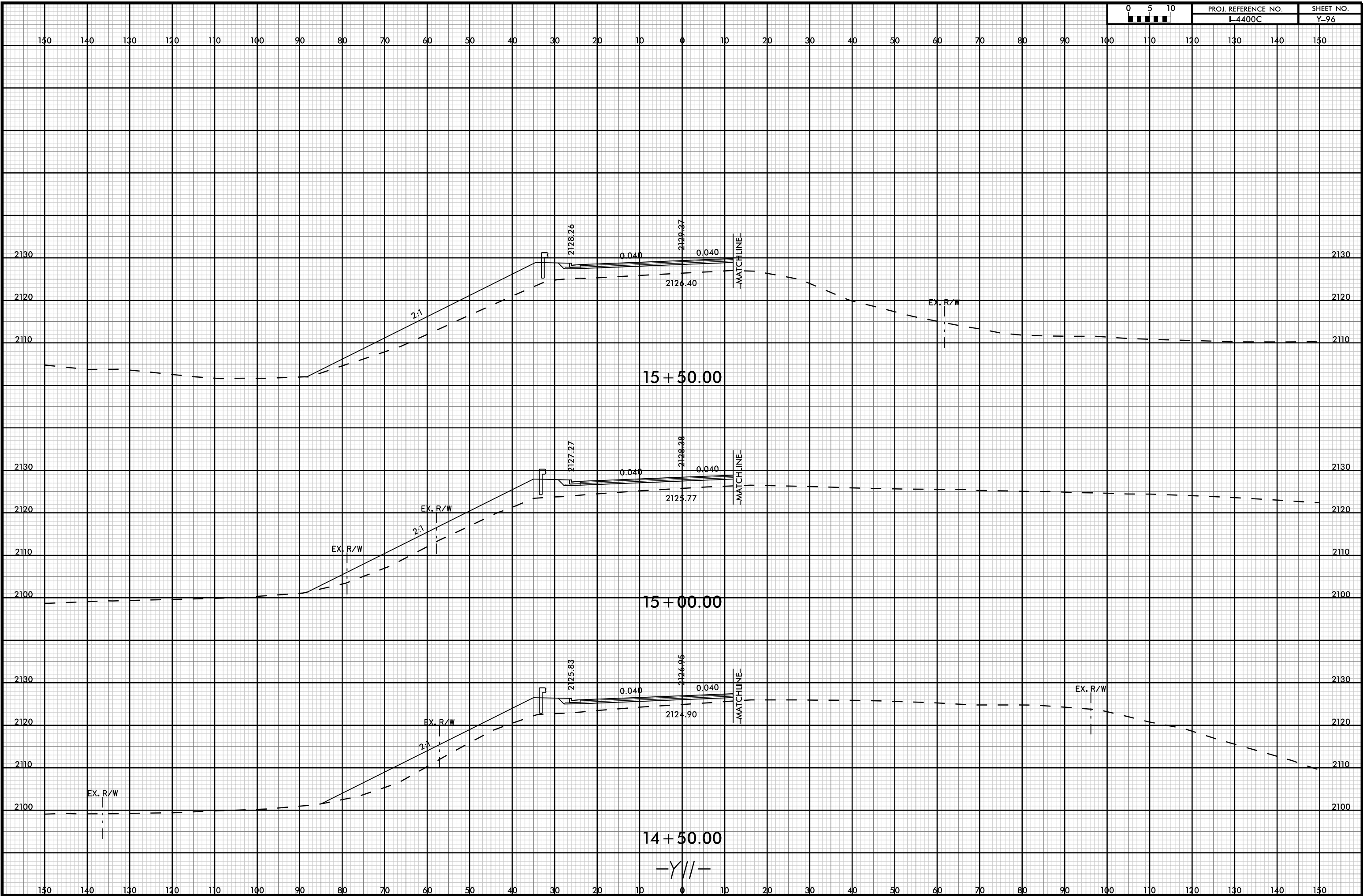



150 140 130 120 110 100 90 80 70 60 50 40 30 20 10 0 10 20 30 40 50 60 70 80 90 100 110 120 130 140 150

2140 2140

2130 2130

2120 2120

2110 2110

2100 2100

2103.19
17 + 00.00

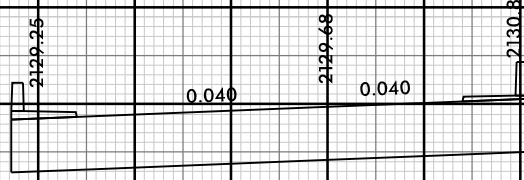

2140 2140

2130 2130

2120 2120

2110 2110

2104.84
16 + 50.00

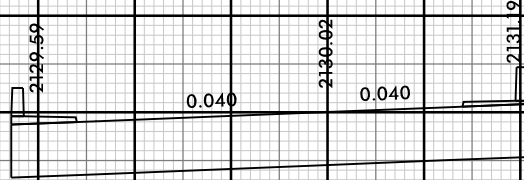

2140 2140

2130 2130

2120 2120

2110 2110

2120.11
16 + 00.00
-Y//-

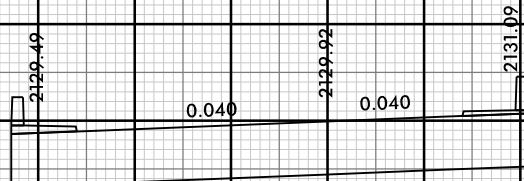

EX. R/W

150 140 130 120 110 100 90 80 70 60 50 40 30 20 10 0 10 20 30 40 50 60 70 80 90 100 110 120 130 140 150



150 140 130 120 110 100 90 80 70 60 50 40 30 20 10 0 10 20 30 40 50 60 70 80 90 100 110 120 130 140 150

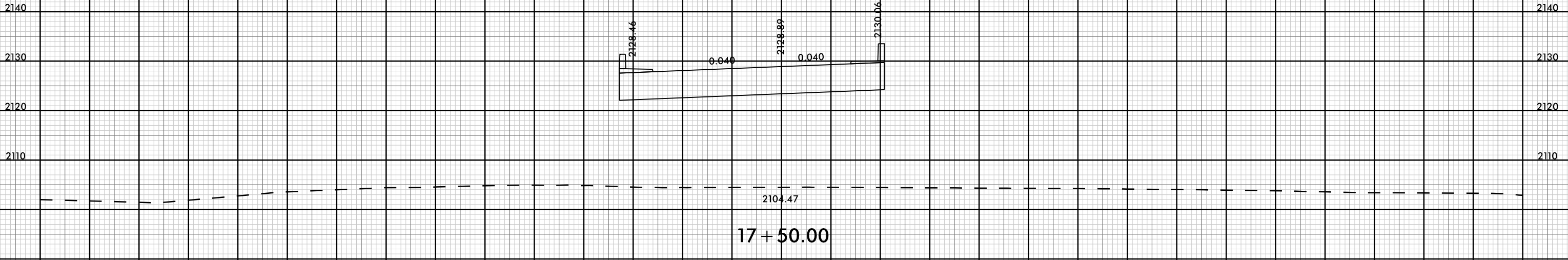
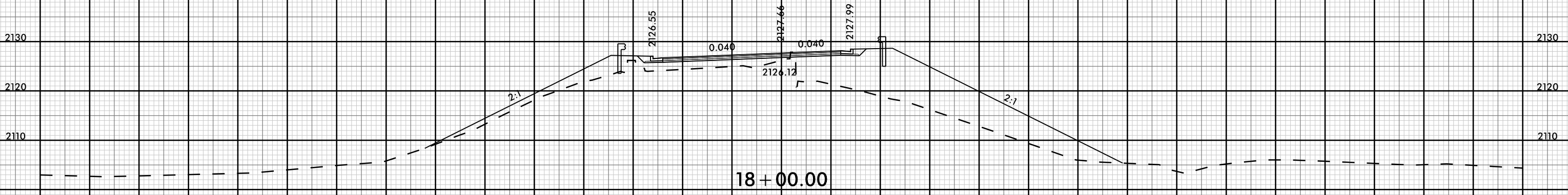
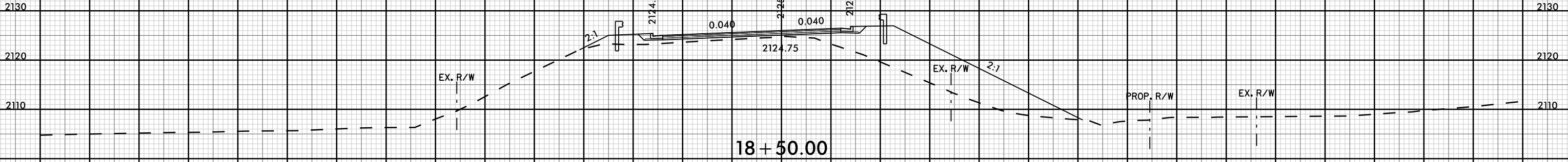

-Y//-

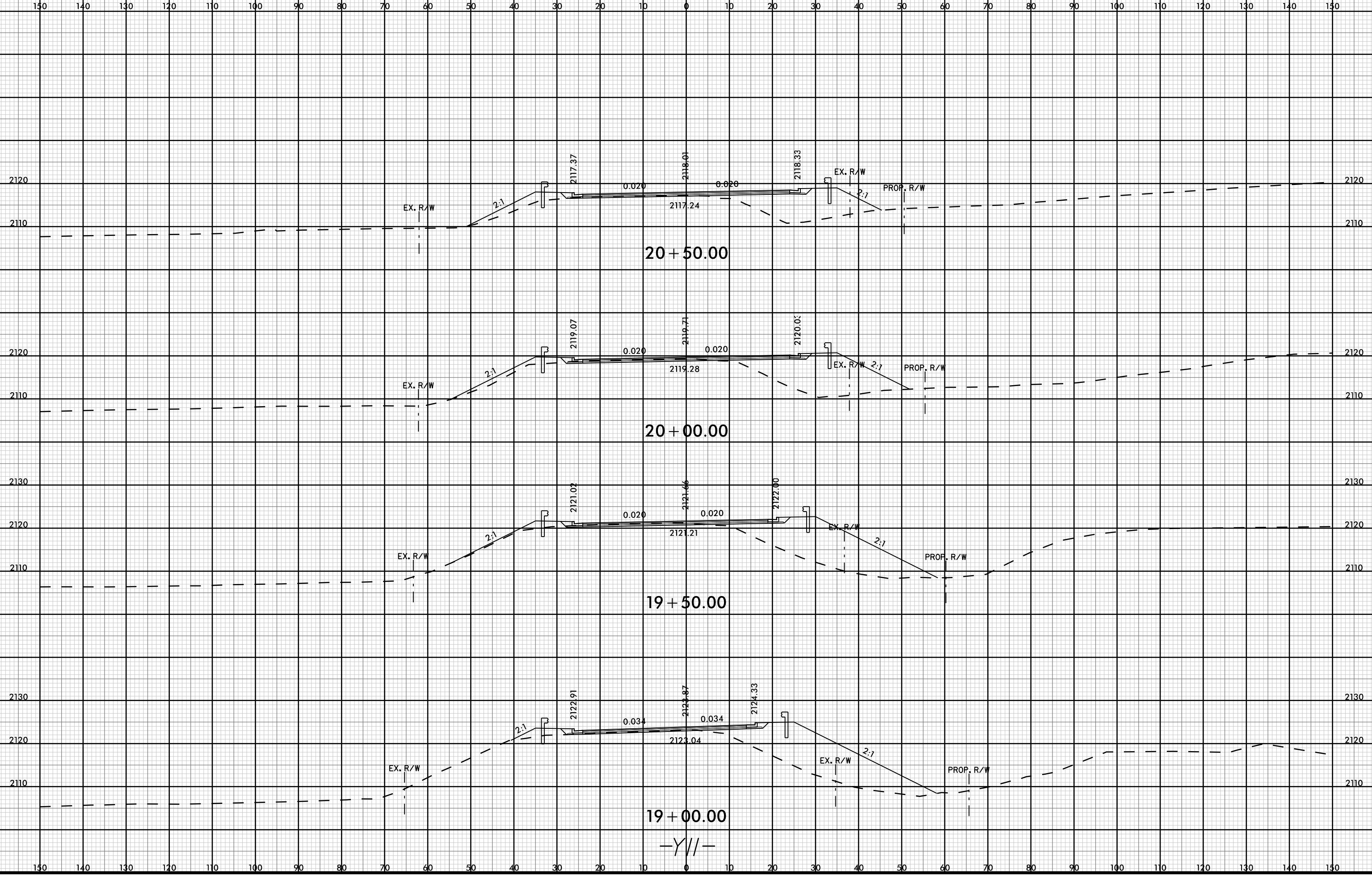

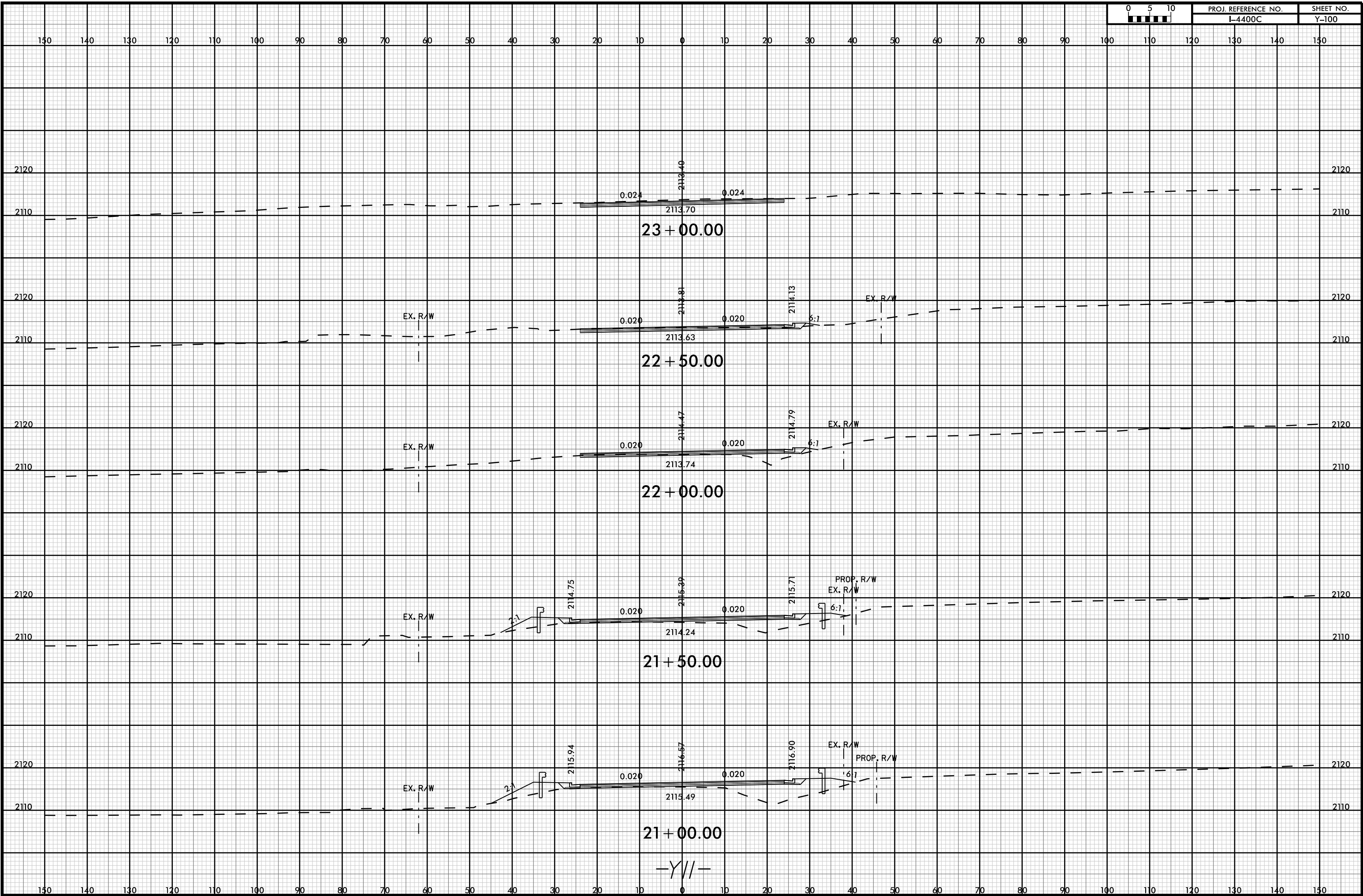

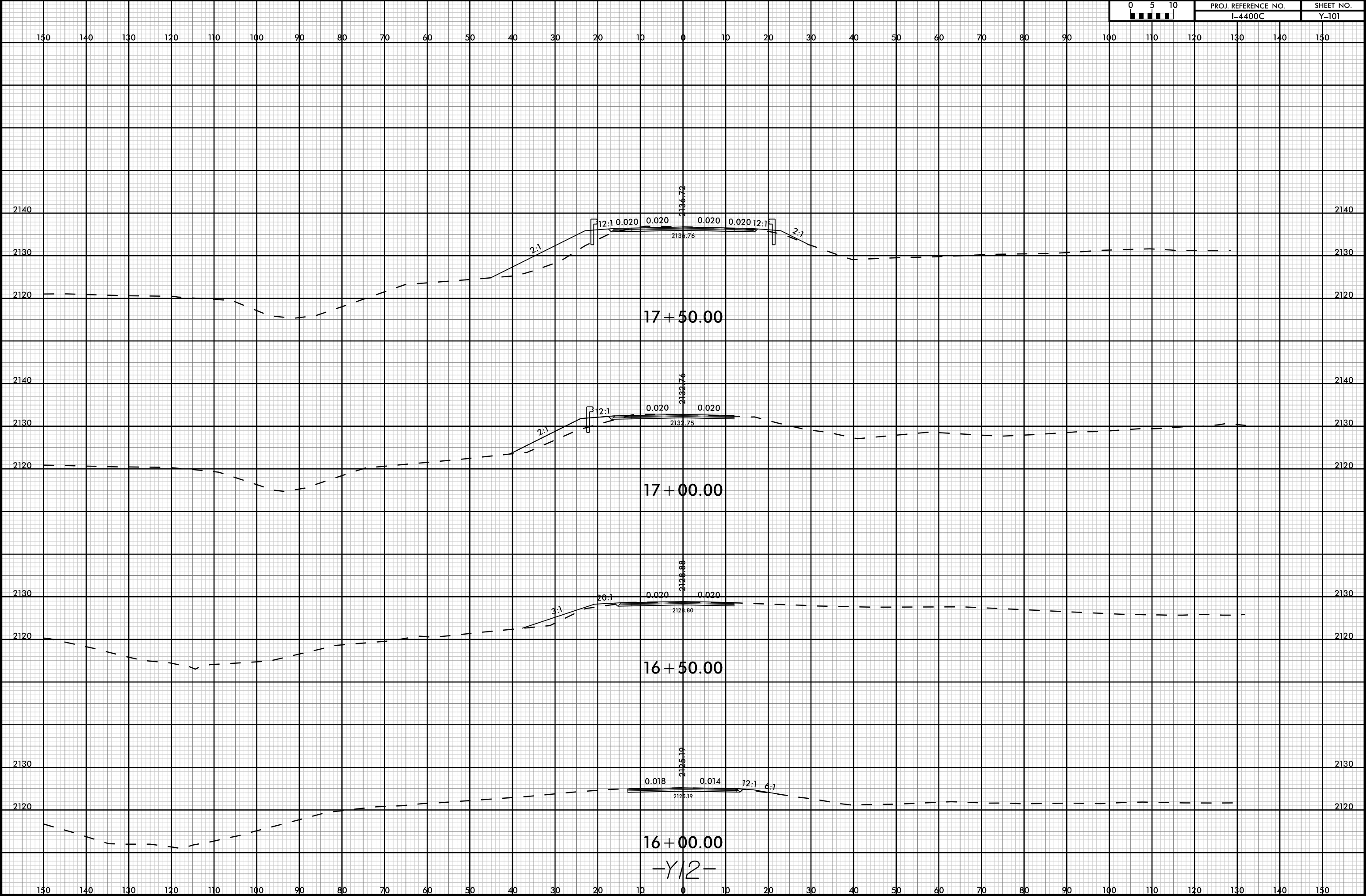

17+50.00

17+00.00

16+50.00

16+00.00

-Y/2-

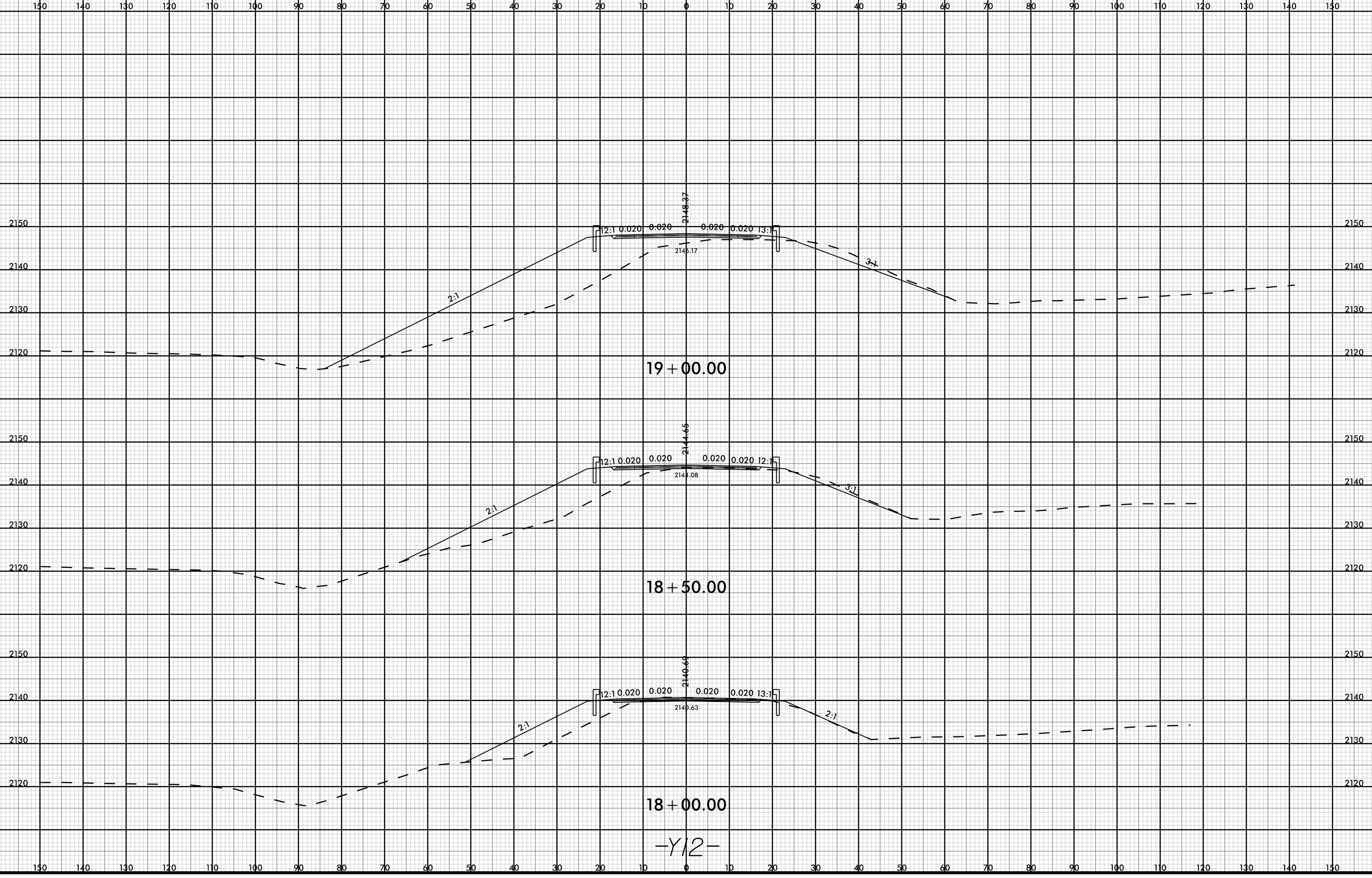

19 + 00.00

18 + 50.00

18 + 00.00

-Y/2-

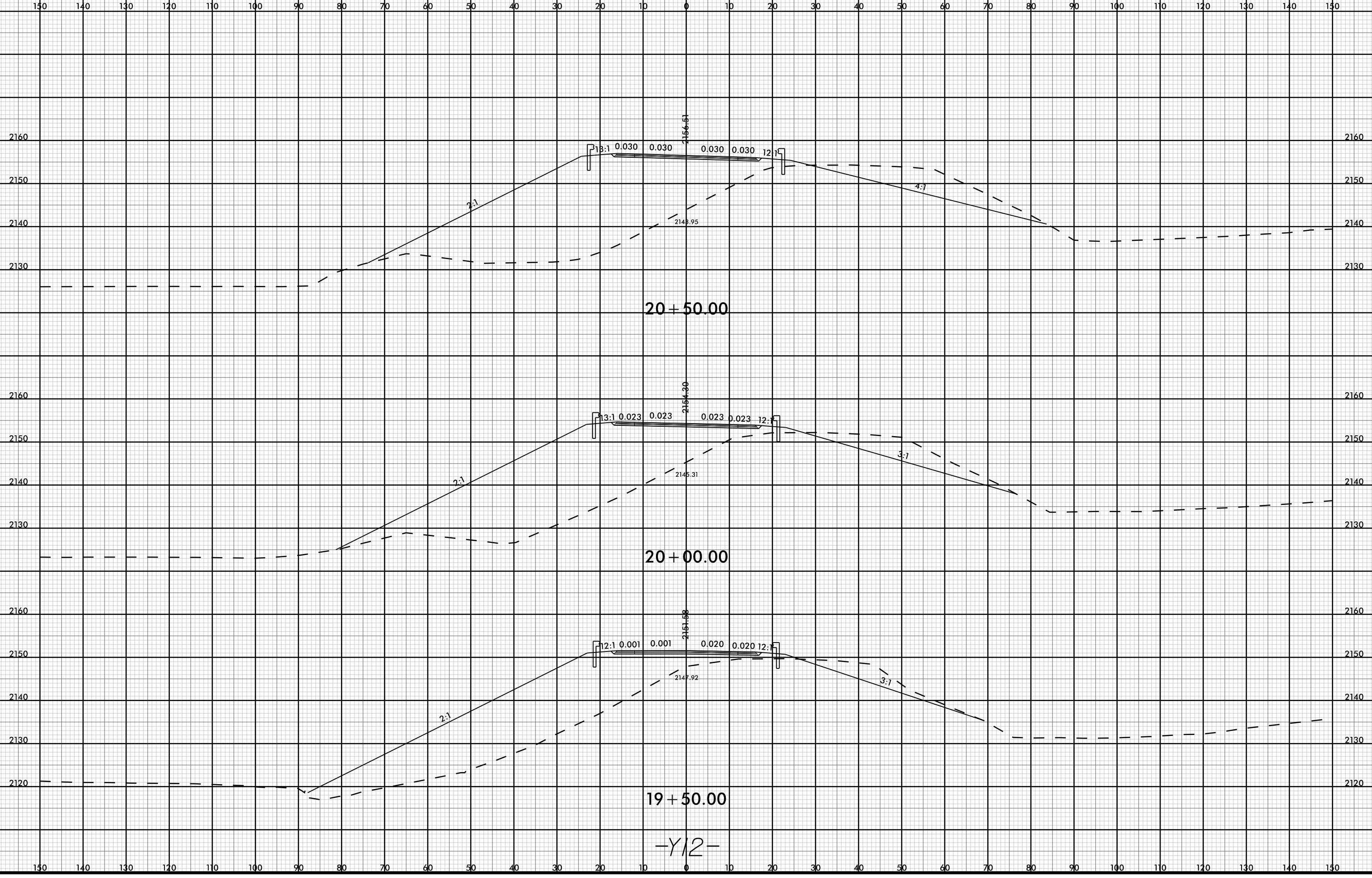

20+50.00

20+00.00

19+50.00

-Y/2-

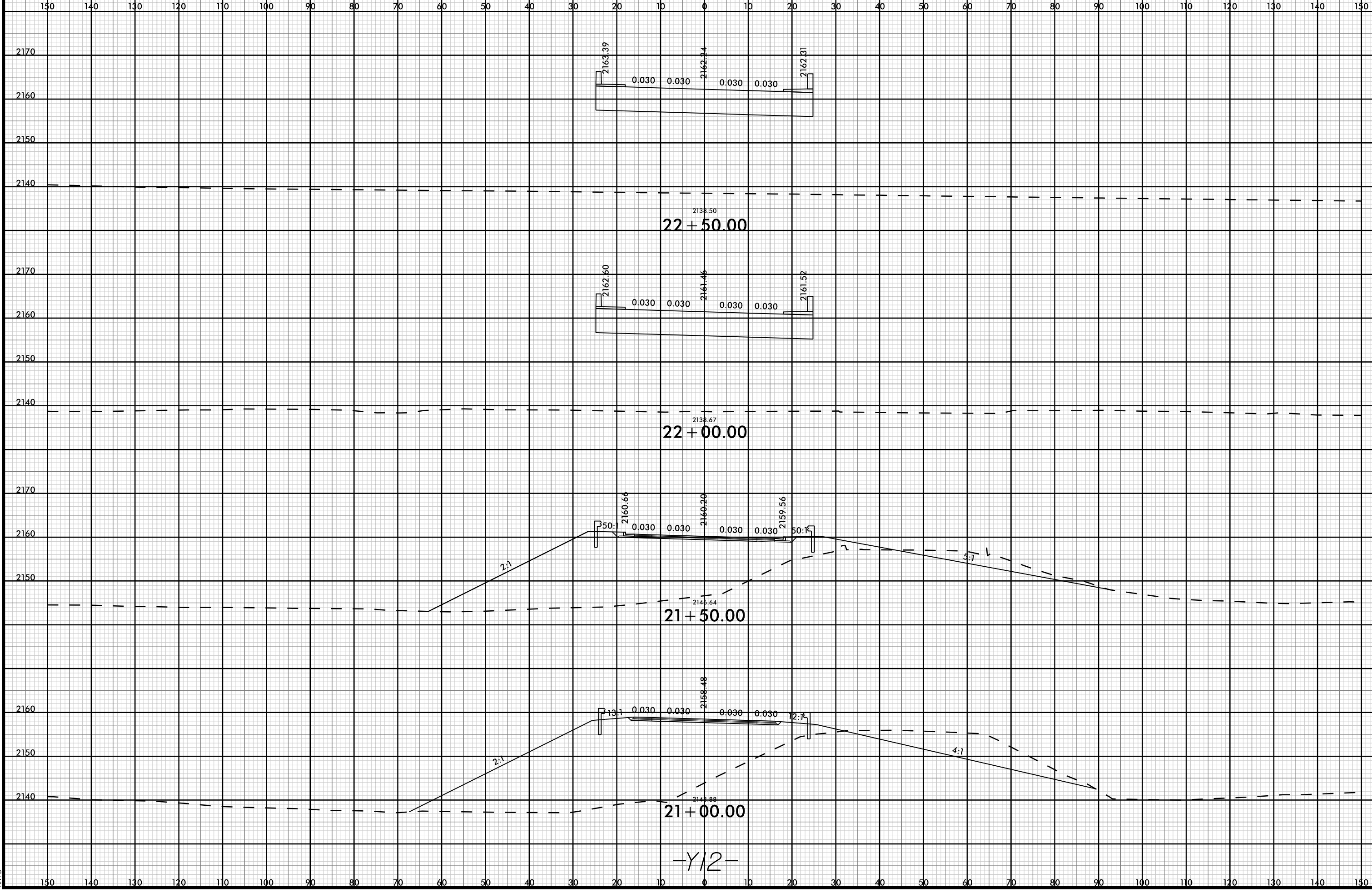

-Y12-

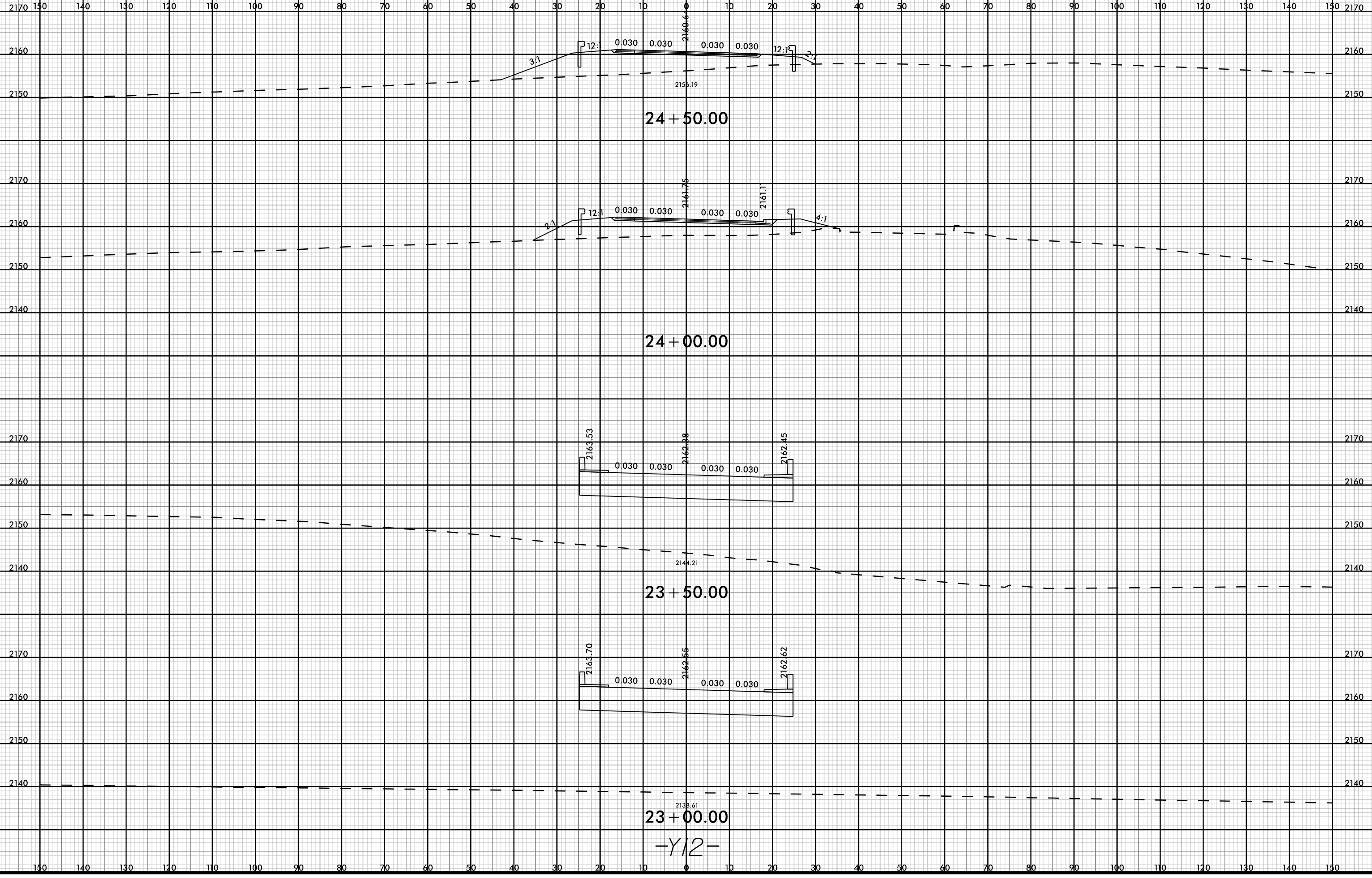

22-MAY-2016 06:54
C:\pwworking\CorridorModeling\14400C.RDY_XPL_Y12.dgn

23+00.00

-Y/2-

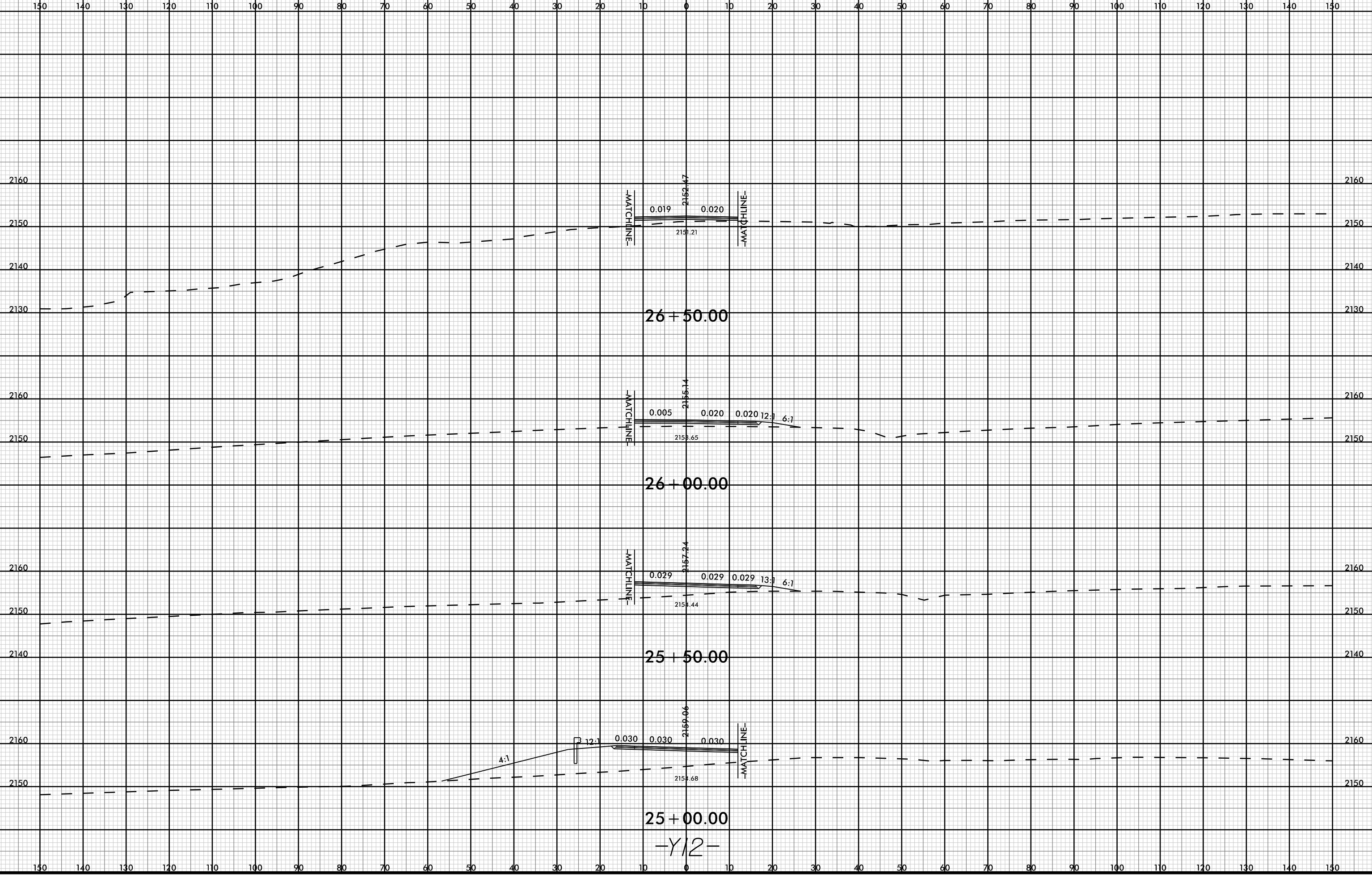

25 + 00.00
-Y/2-

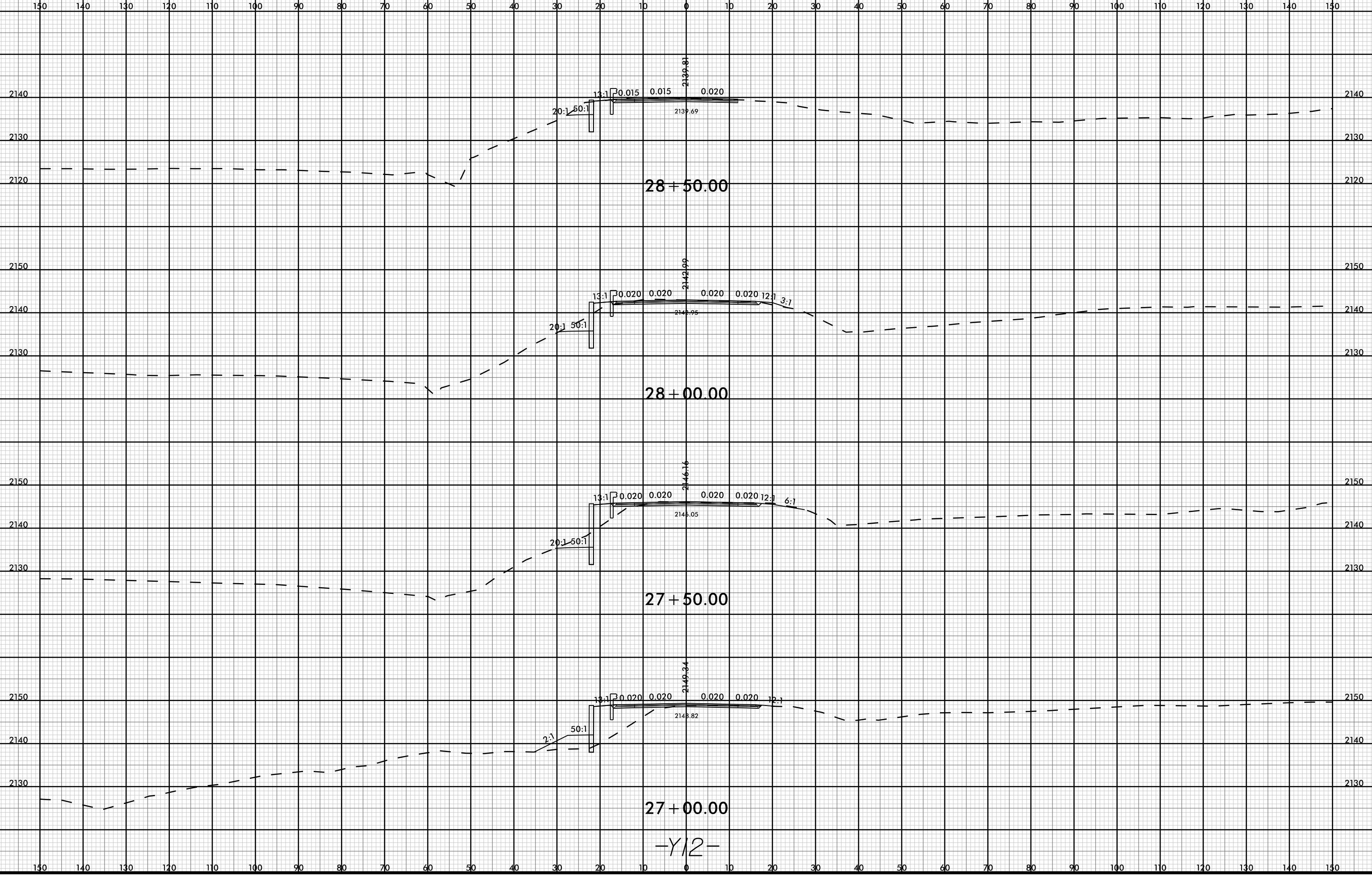

6/23/16

0 5 10	PROJ. REFERENCE NO.	SHEET NO.
	I-4400C	Y-108

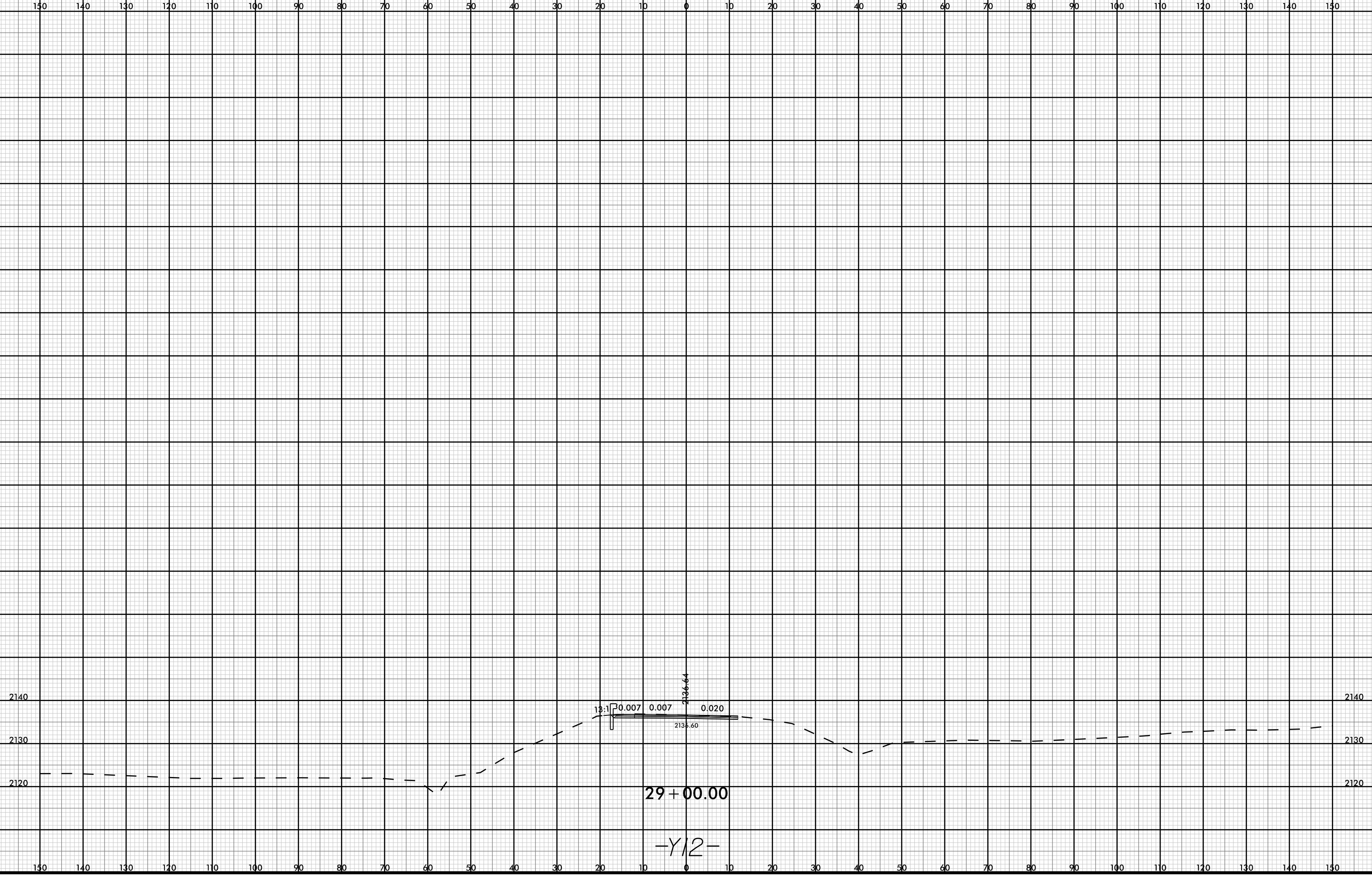

22-MAY-2016 06:54
 \\server\corridor\corridor\14400C.RDY_XPL_Y12.dgn

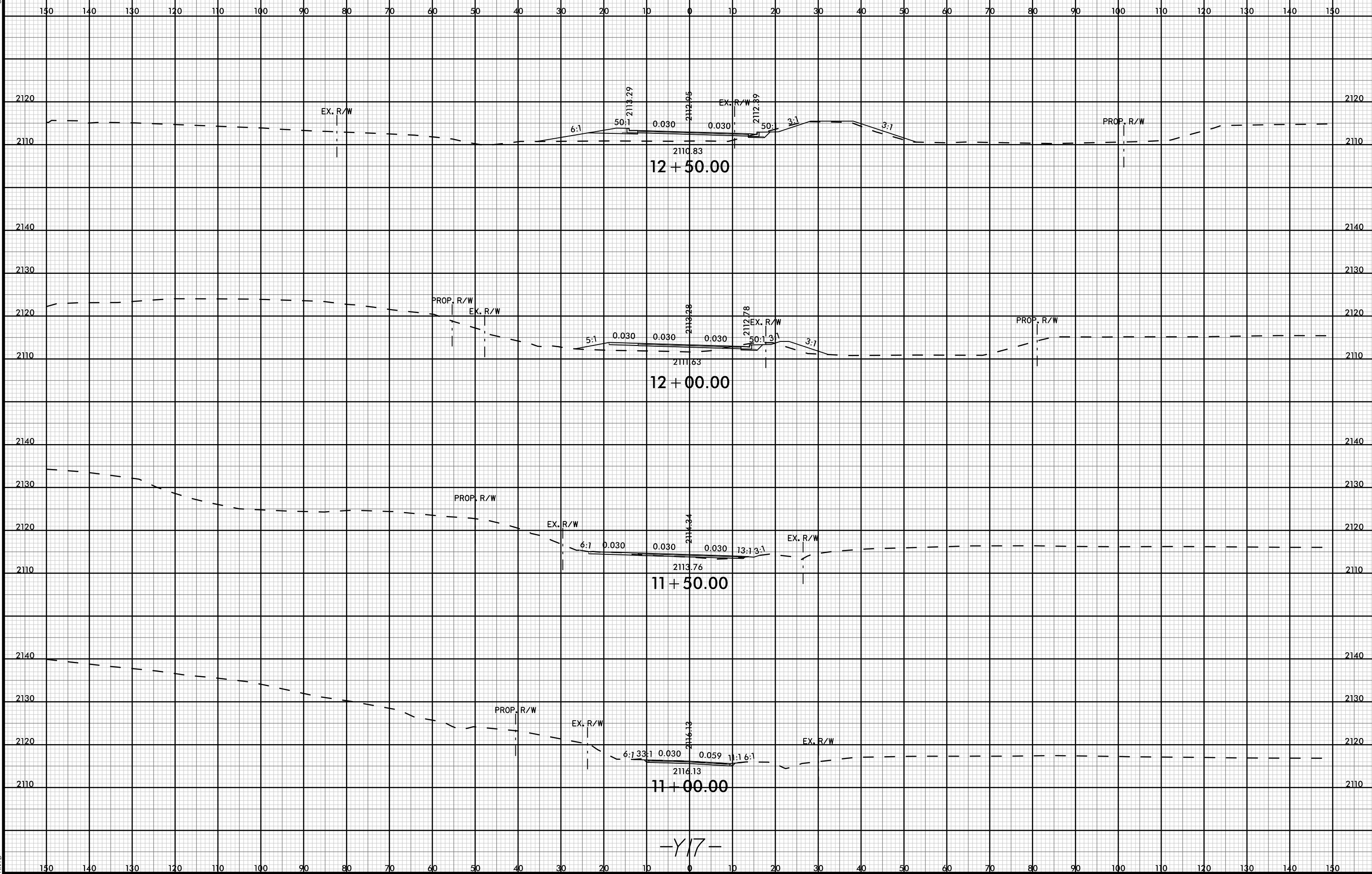

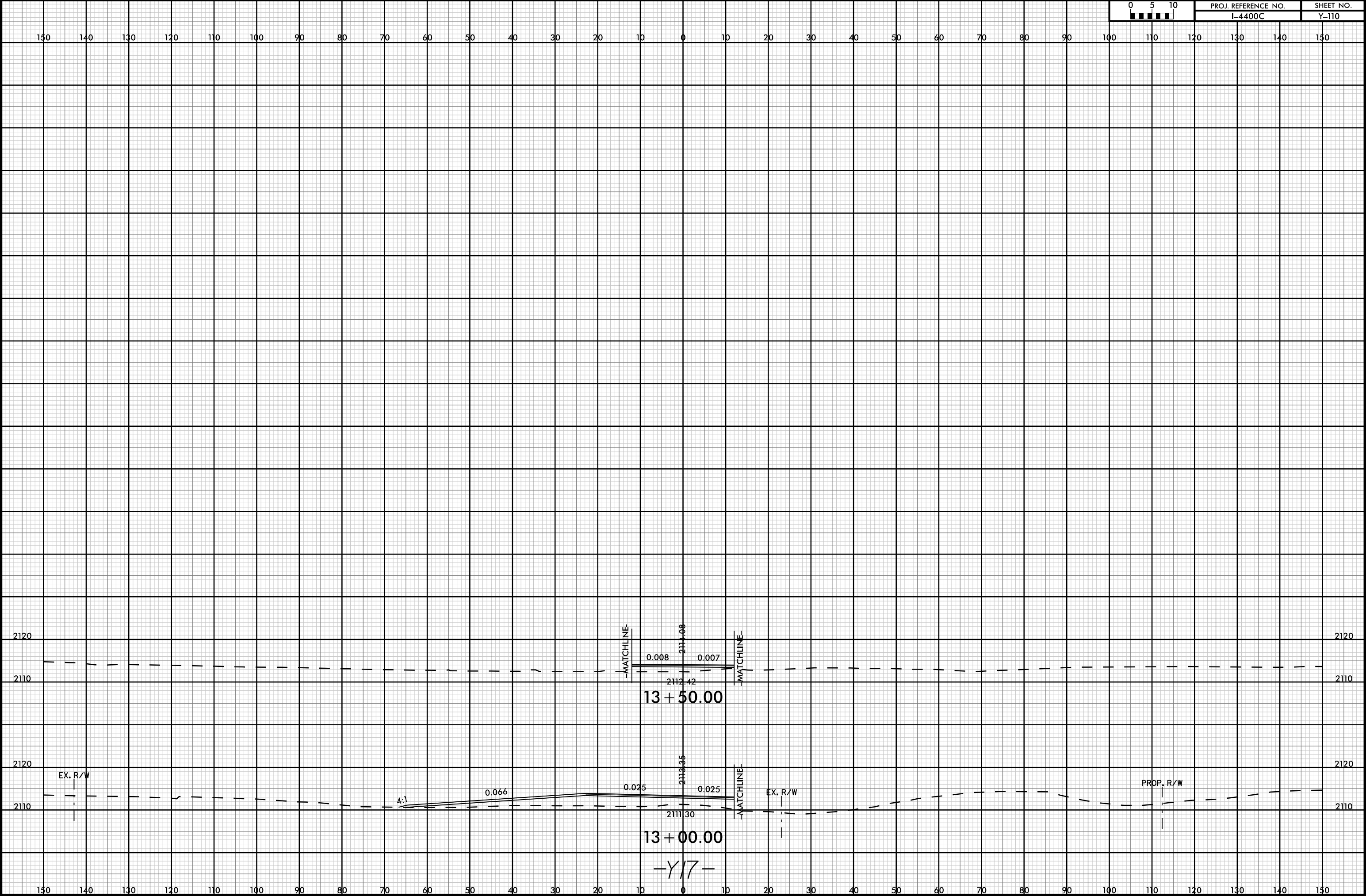

-Y17-

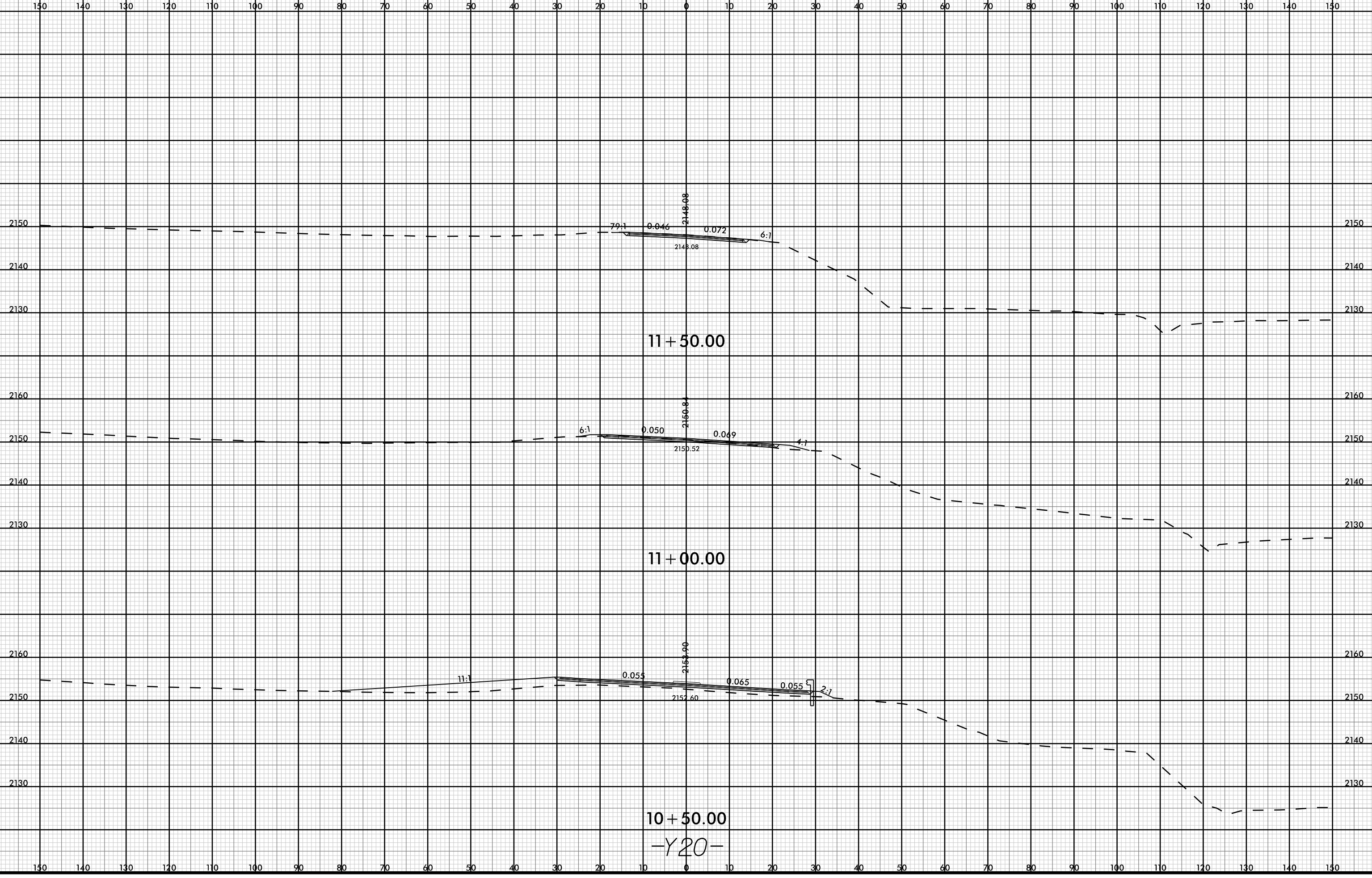

10 + 50.00
 -Y20-

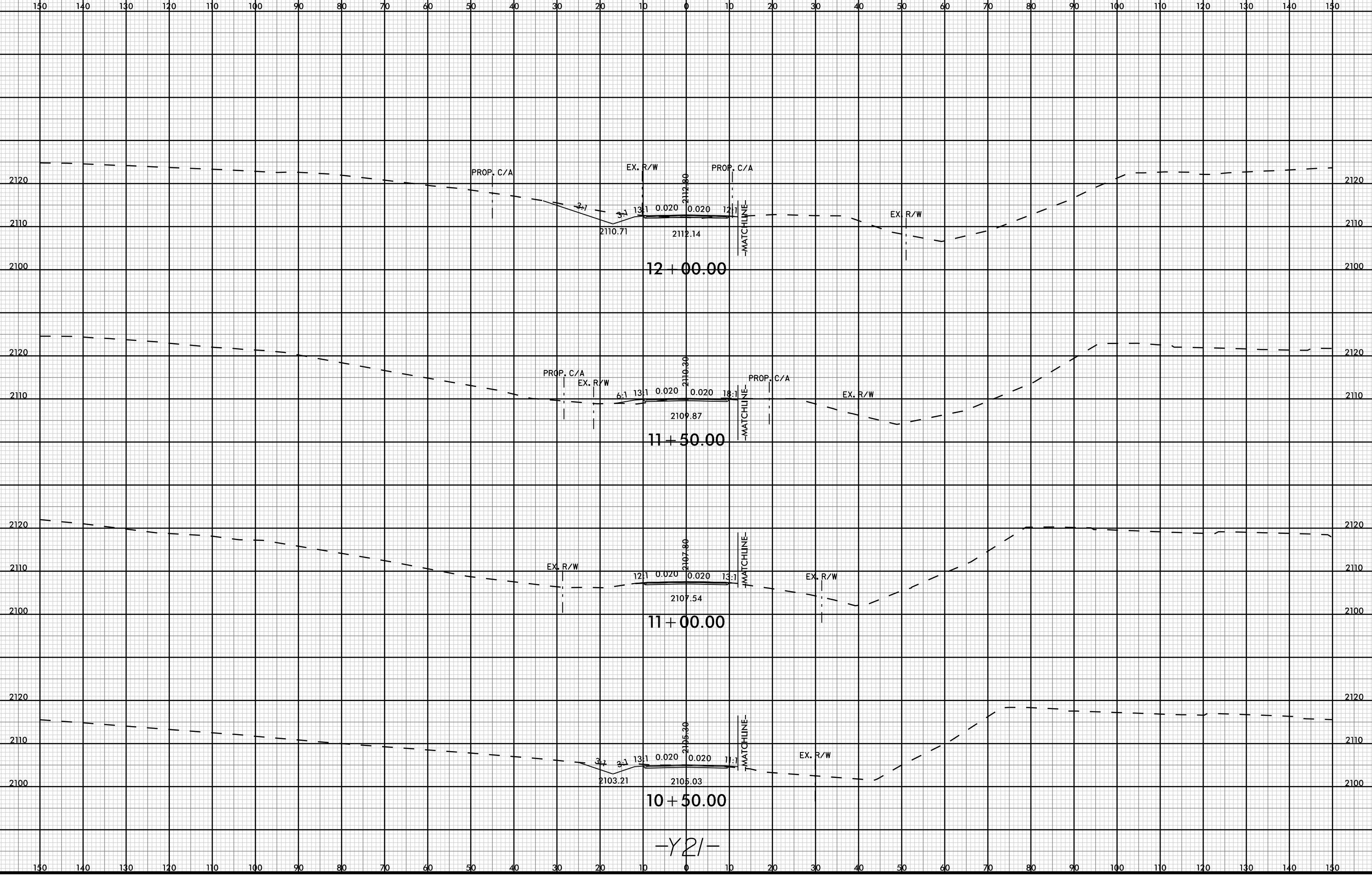

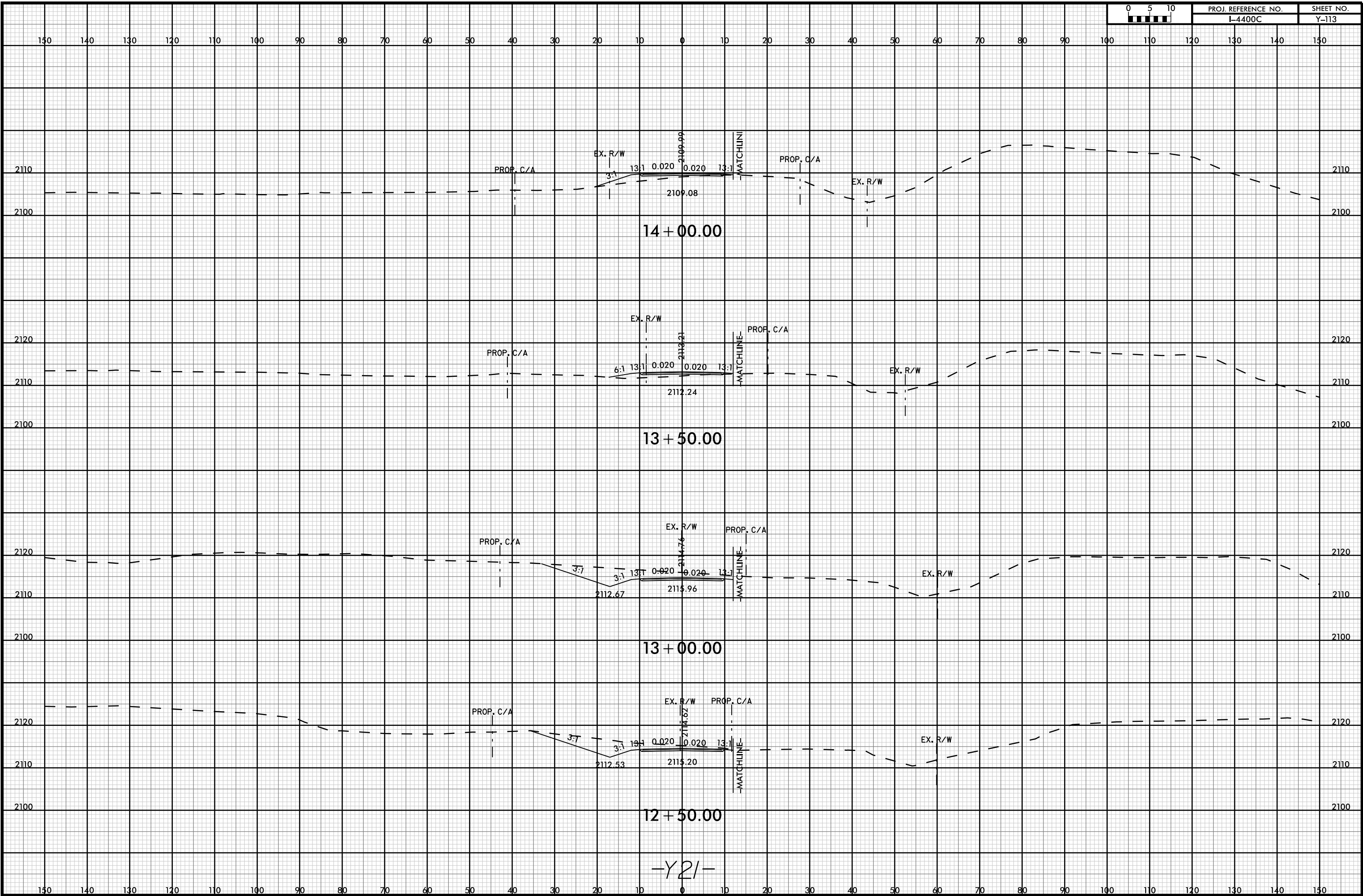

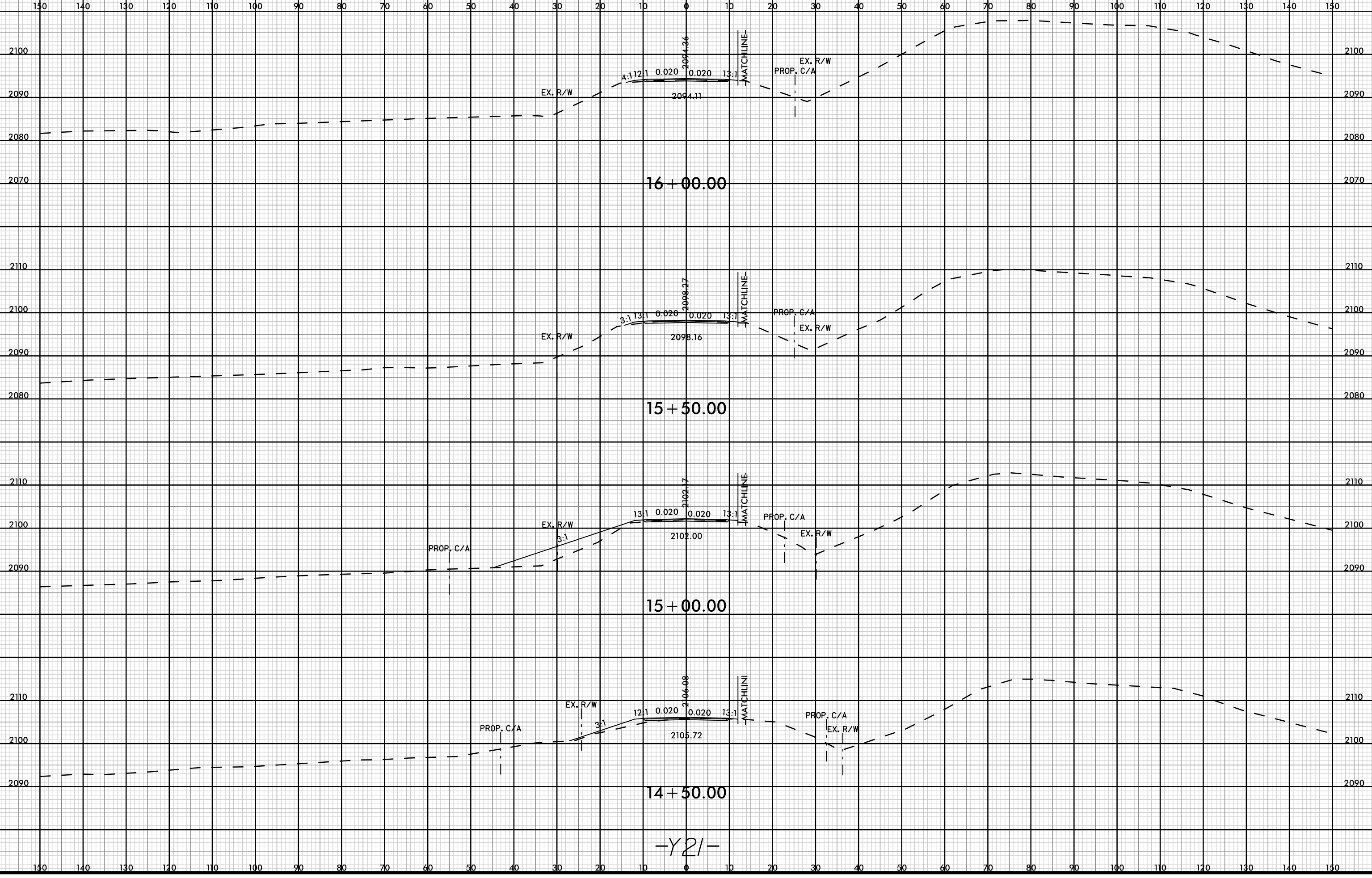

-Y21-

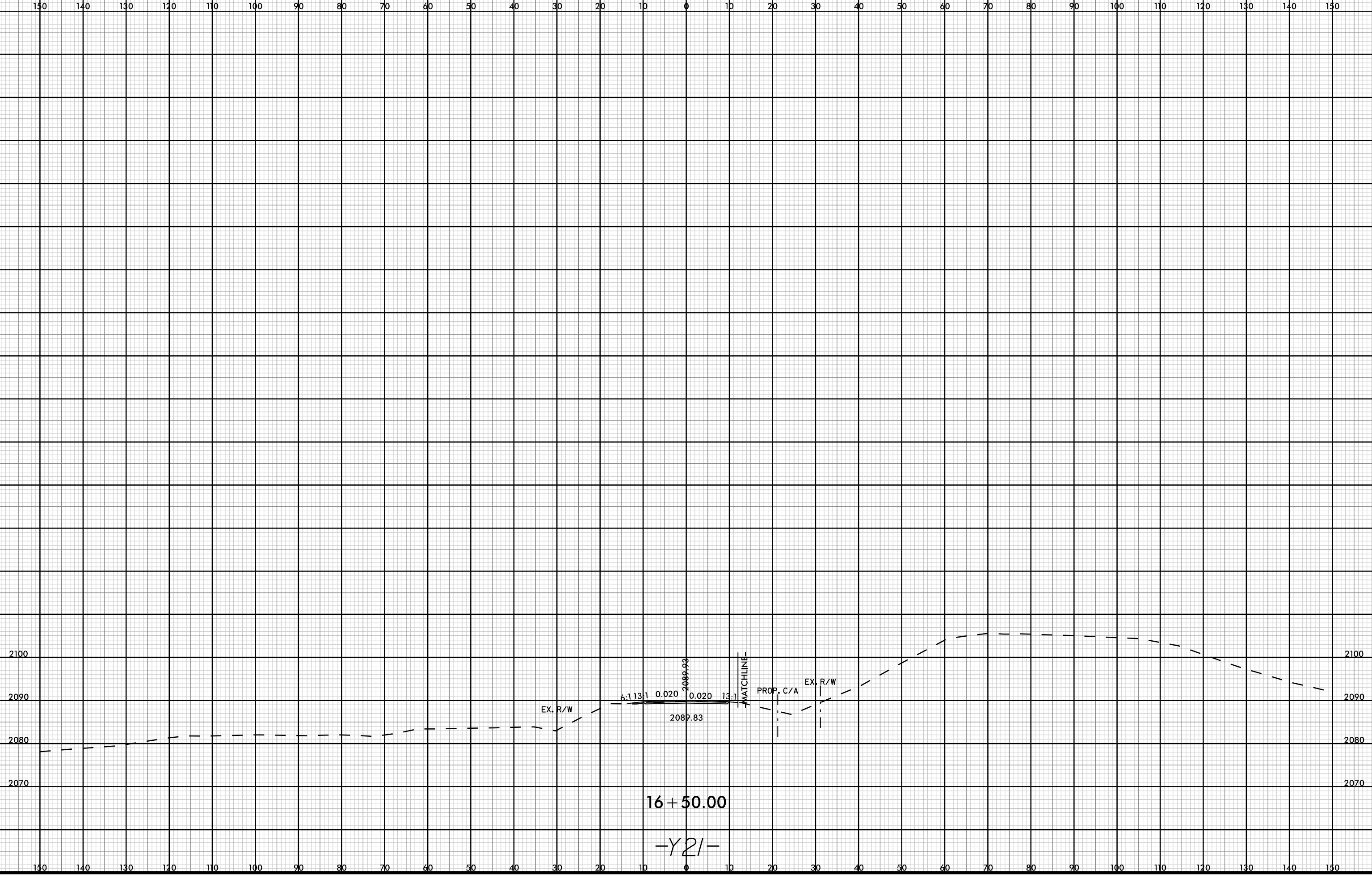

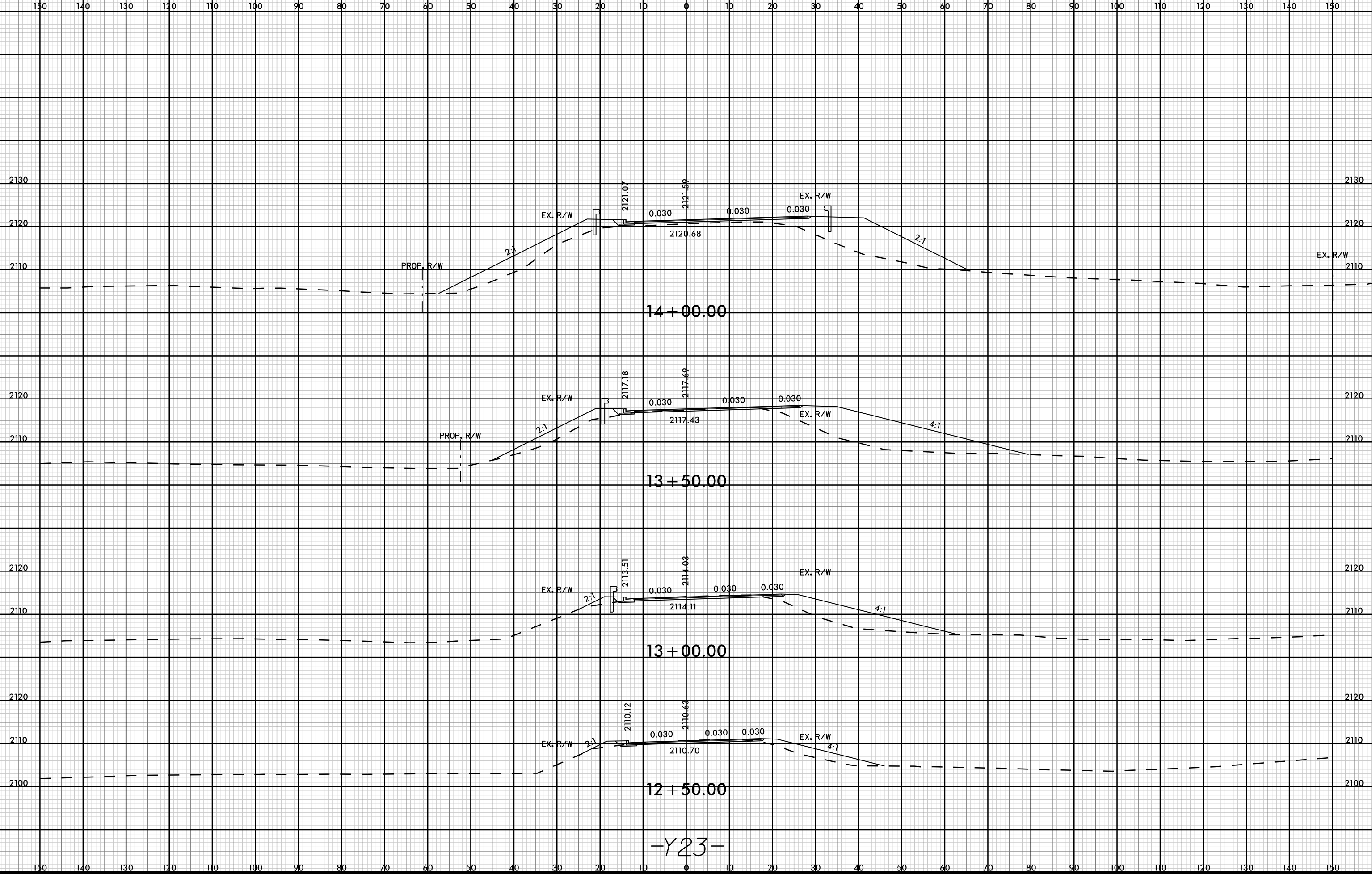

-Y23-



150 140 130 120 110 100 90 80 70 60 50 40 30 20 10 0 10 20 30 40 50 60 70 80 90 100 110 120 130 140 150

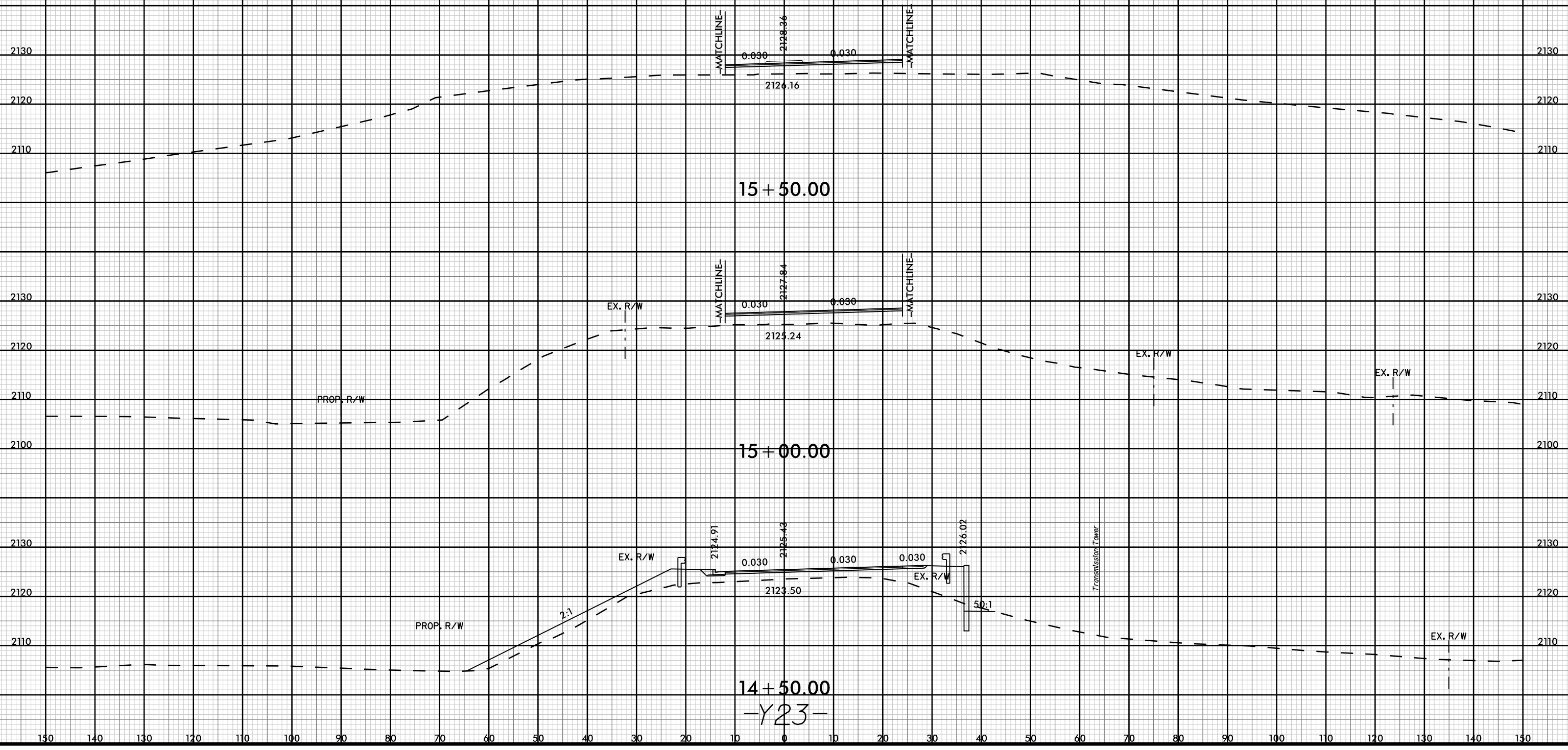

14+50.00
-Y23-