

**This electronic collection of documents is provided
for the convenience of the user
and is Not a Certified Document –**

**The documents contained herein were originally issued
and sealed by the individuals whose names and license
numbers appear on each page, on the dates appearing
with their signature on that page.**

**This file or an individual page
shall not be considered a certified document.**

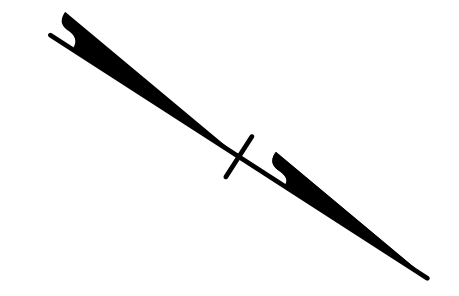
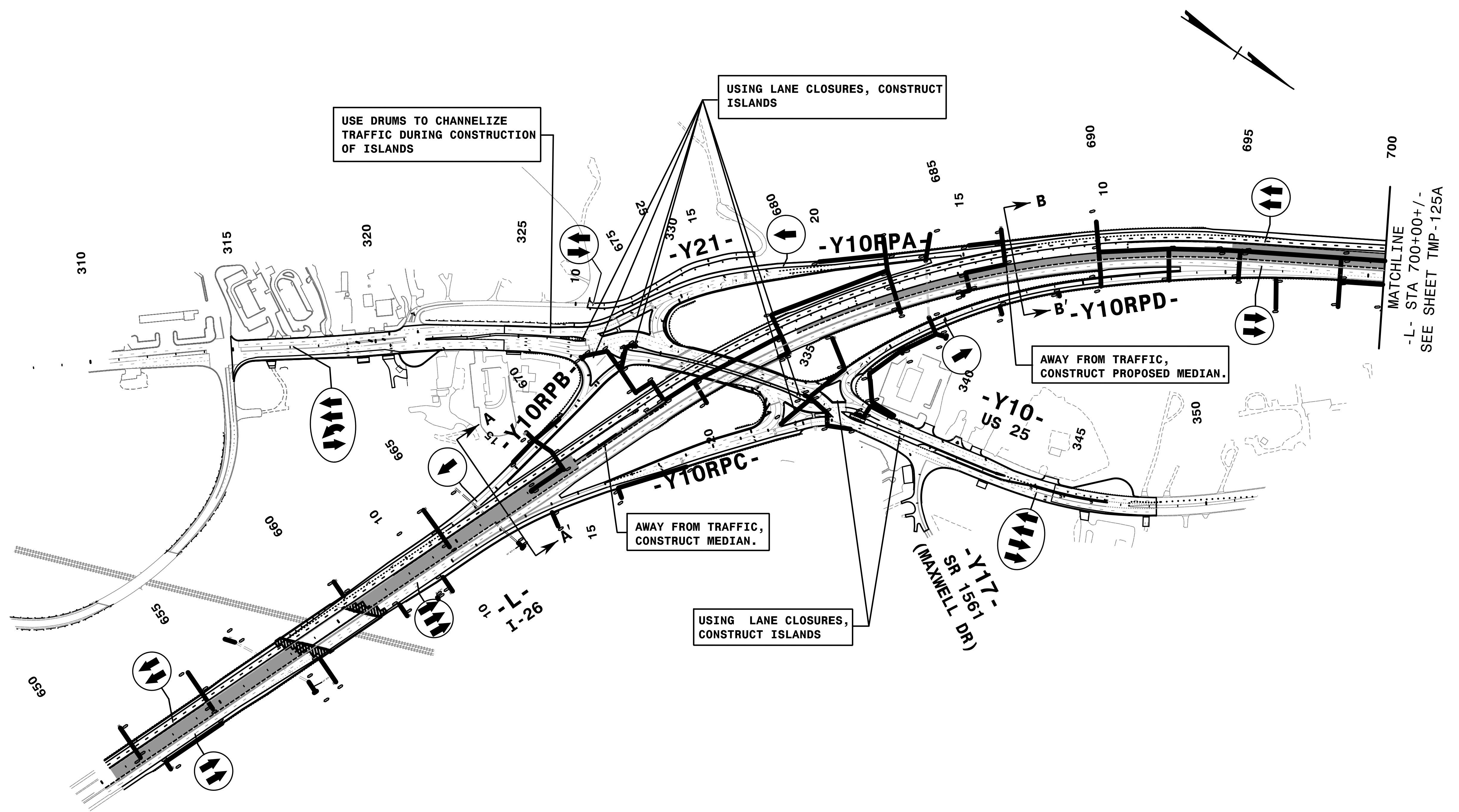

4:13:51 PM
 I:\CPN\4400C-1c_PHASE 5_OV.dgn
 9/3/2019

REFER TO SHEET TMP-XX FOR CUT SECTION(S).

HNTB
 HNTB NORTH CAROLINA, P.C.
 343 E. Six Forks Road, Suite 200
 Raleigh, North Carolina 27609
 NC License No: C-1554

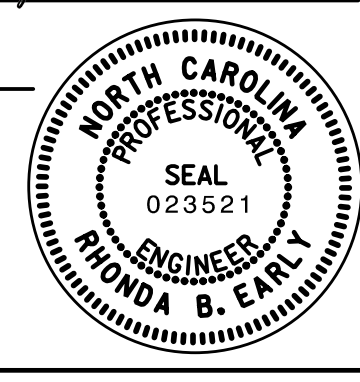
APPROVED: *Rhonda B. Early*
 DATE: 9/3/2019

DOCUMENT NOT CONSIDERED FINAL UNLESS ALL SIGNATURES COMPLETED

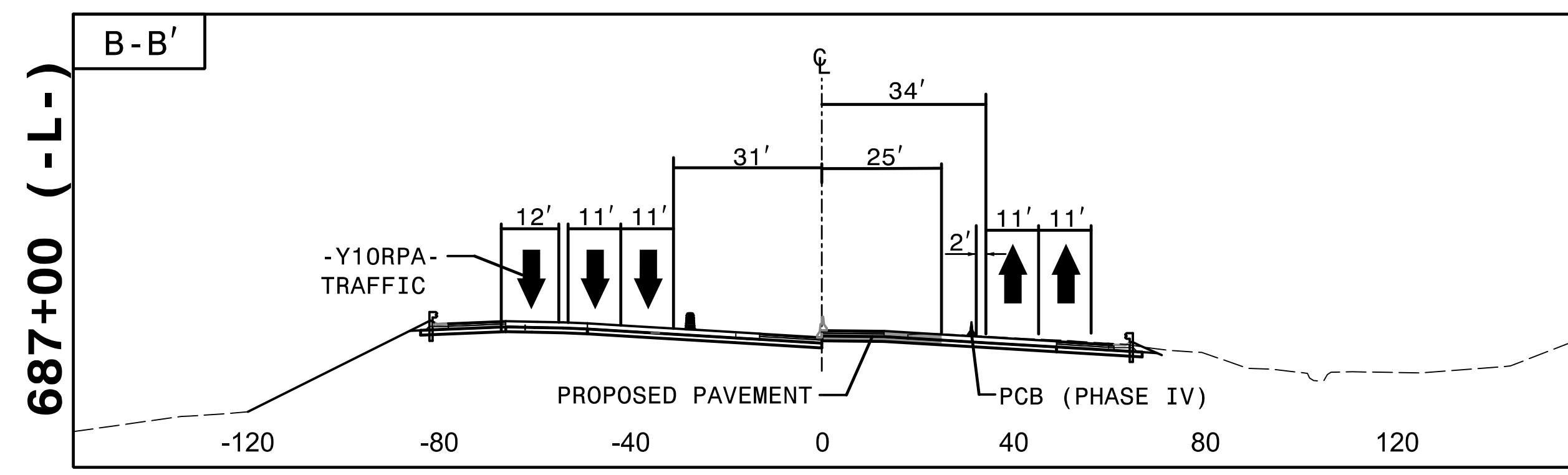
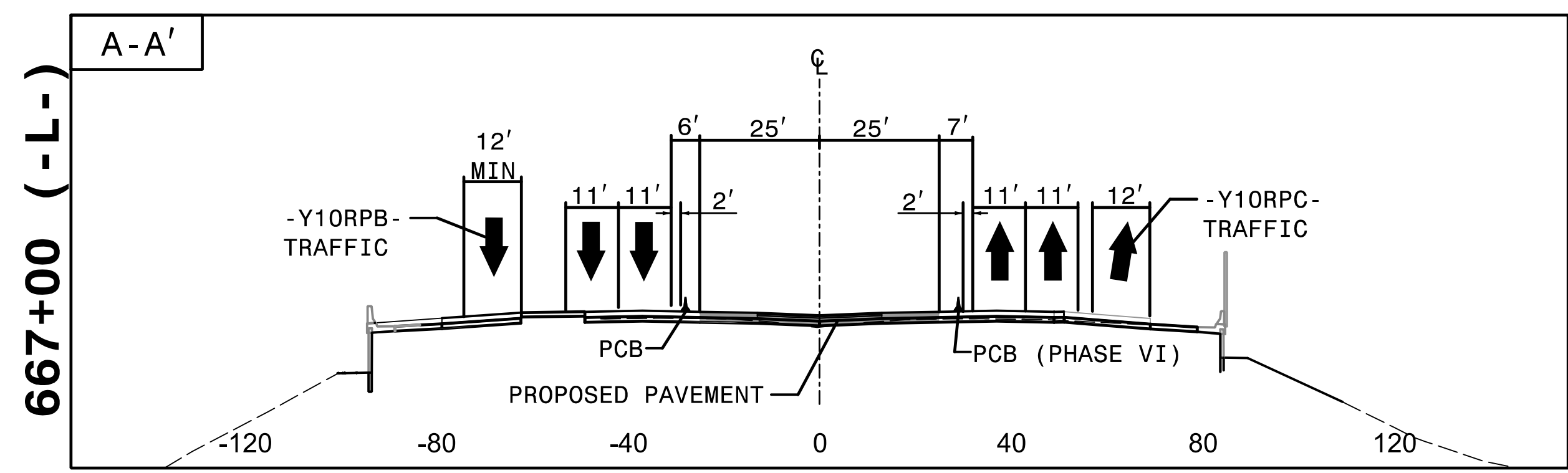

TRANSPORTATION
 MANAGEMENT PLAN

 PHASE V
 OVERVIEW



4:14:49 PM
TCN\4400C_fc_P5 CUTS.dgn
9/3/2019

HNTB HNTB NORTH CAROLINA, P.C.
343 E. Six Forks Road, Suite 200
Raleigh, North Carolina 27609
NC License No: C-1554

APPROVED: *Rhonda B. Early*
DATE: 9/3/2019

DocuSigned by:
F34CAF5AC6BFB48A

**DOCUMENT NOT CONSIDERED FINAL
UNLESS ALL SIGNATURES COMPLETED**

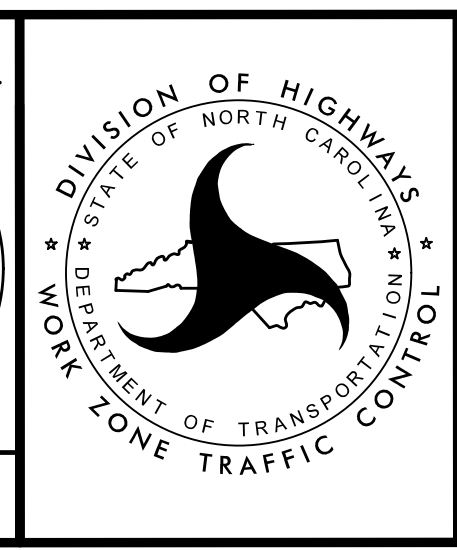

TRANSPORTATION
MANAGEMENT PLAN

**PHASE V
CUT SECTIONS**

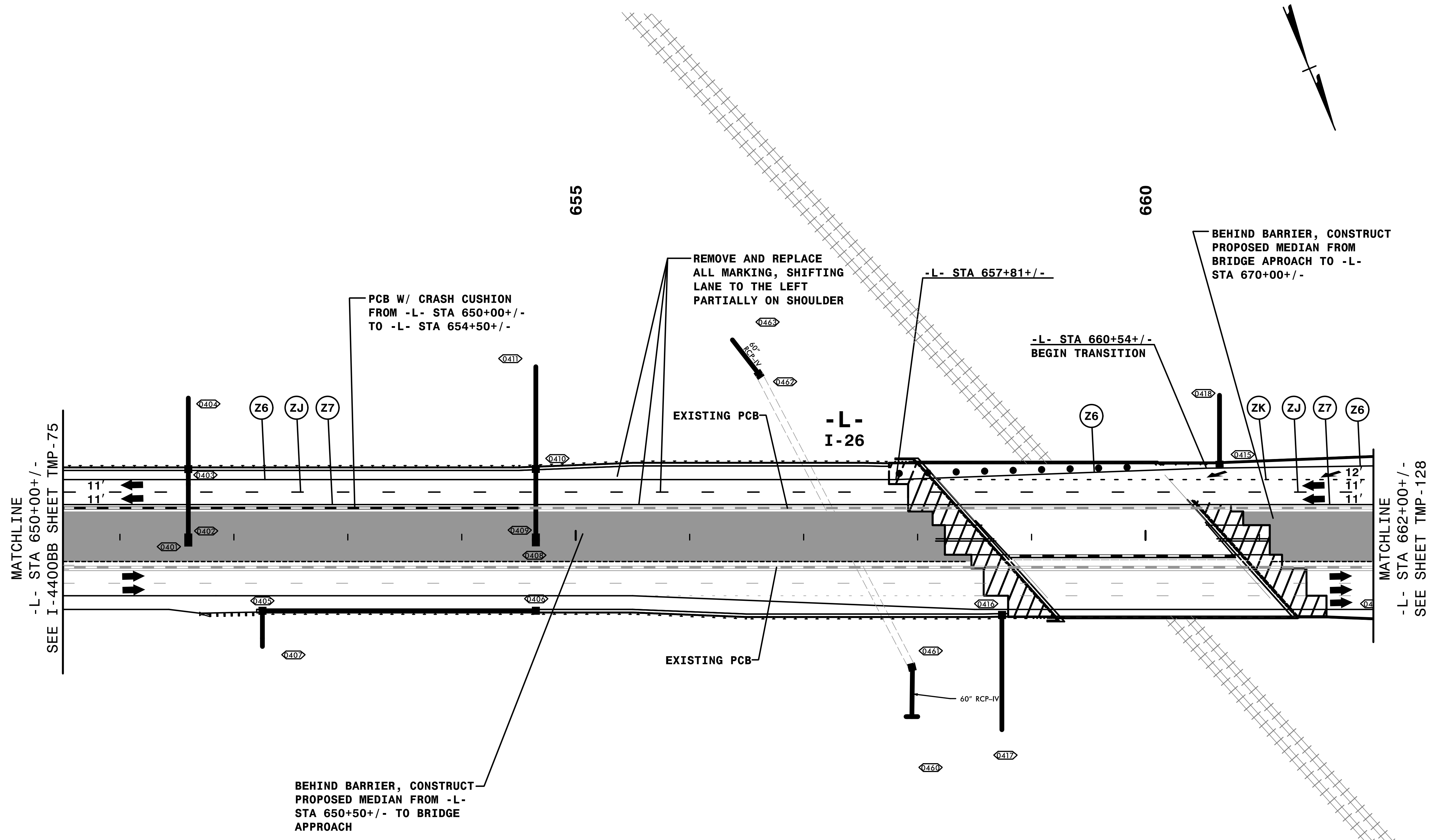

4:15:05 PM
I:\CP\4400C-1c_AL.P5d1.dgn
9/3/2019

HNTB
 HNTB NORTH CAROLINA, P.C.
 343 E. Six Forks Road, Suite 200
 Raleigh, North Carolina 27609
 NC License No: C-1554

DocuSigned by:
Rhonda B. Early
 F34CAF5A06BF48A...
 DATE: 9/3/2019

NORTH CAROLINA
 PROFESSIONAL
 SEAL
 023521
RHONDA B. EARLY
 ENGINEER

**DOCUMENT NOT CONSIDERED FINAL
 UNLESS ALL SIGNATURES COMPLETED**

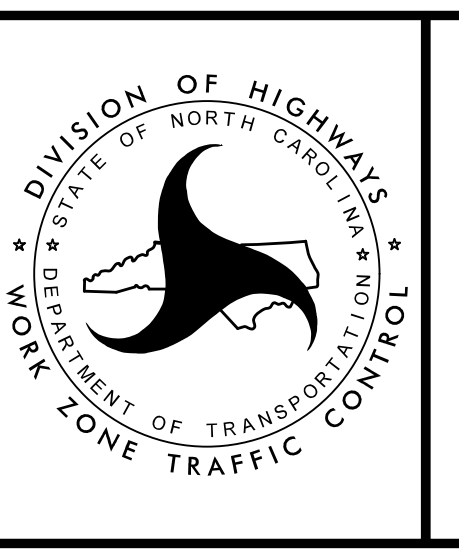

TRANSPORTATION
 MANAGEMENT PLAN

PHASE V
 DETAIL

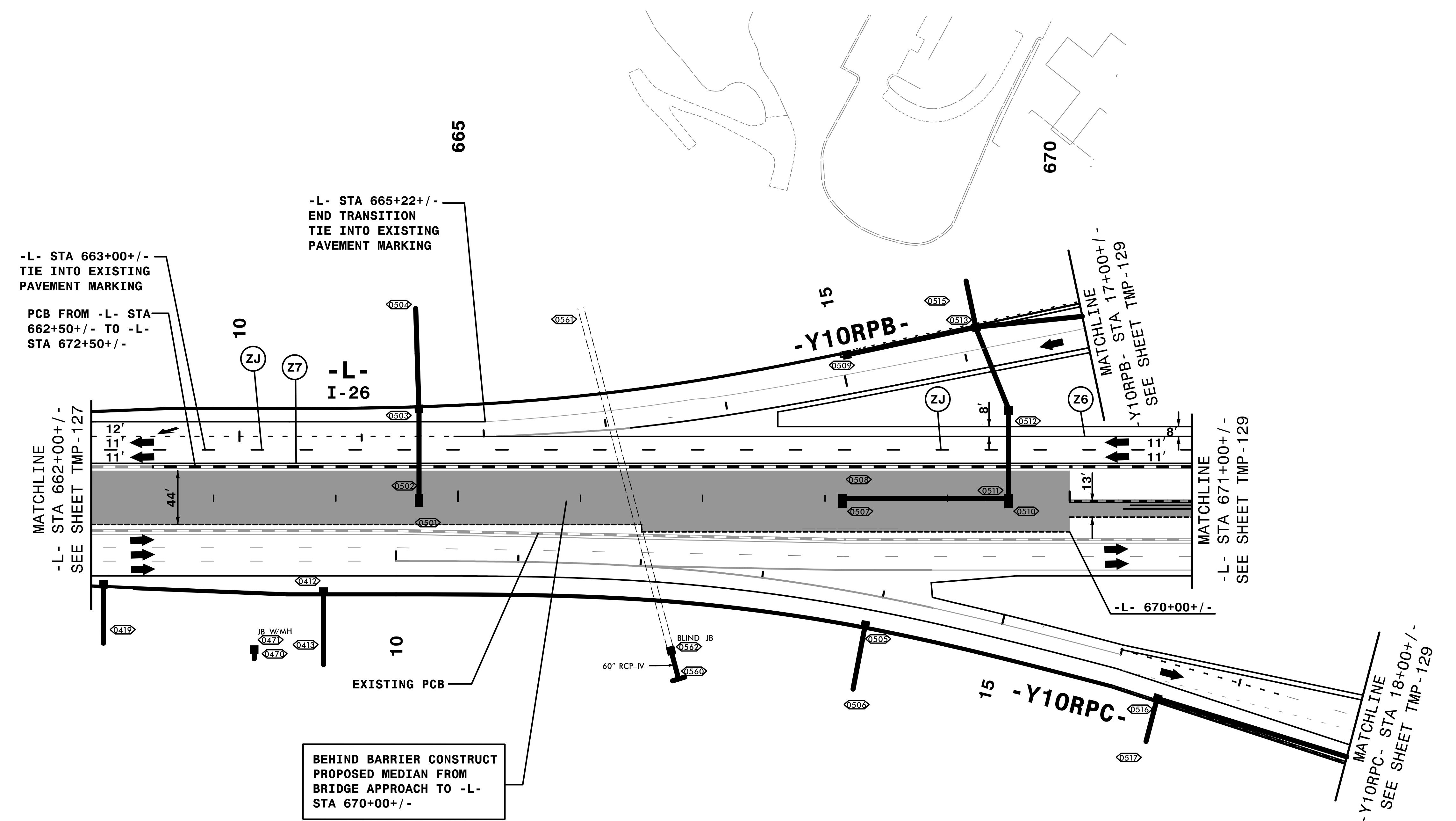

-L- STA 663+00+/-
TIE INTO EXISTING
PAVEMENT MARKING

PCB FROM -L- STA
662+50+/- TO -L-
STA 672+50+/-

-L- STA 665+22+/-
END TRANSITION
TIE INTO EXISTING
PAVEMENT MARKING

MATCHLINE
-L- STA 662+00+/-
SEE SHEET TMP-127

MATCHLINE
-L- STA 671+00+/-
SEE SHEET TMP-129

BEHIND BARRIER CONSTRUCT
PROPOSED MEDIAN FROM
BRIDGE APPROACH TO -L-
STA 670+00+/-

4:51:14 PM
I:\CP\4400C-1c_ALP5d2.dgn
9/3/2019

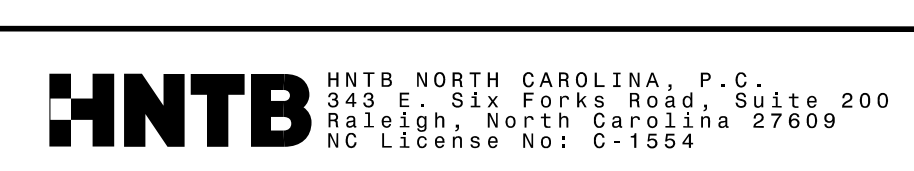

APPROVED: *Rhonda B. Early*
DATE: 9/3/2019

DocuSigned by:
Rhonda B. Early
F34CAF5A06BFB48A

NORTH CAROLINA
PROFESSIONAL
SEAL
023521
ENGINEER
RHONDA B. EARLY

**DOCUMENT NOT CONSIDERED FINAL
UNLESS ALL SIGNATURES COMPLETED**

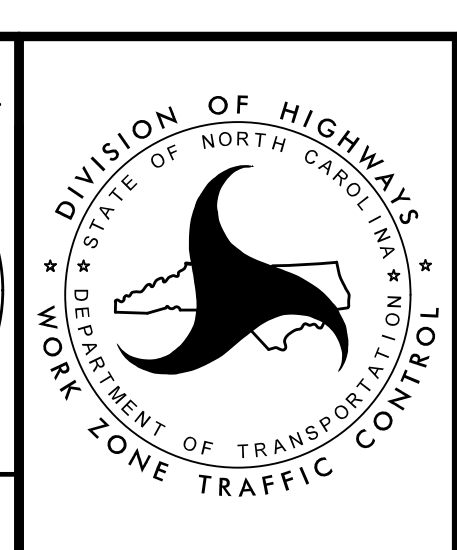

TRANSPORTATION
MANAGEMENT PLAN

PHASE V
DETAIL

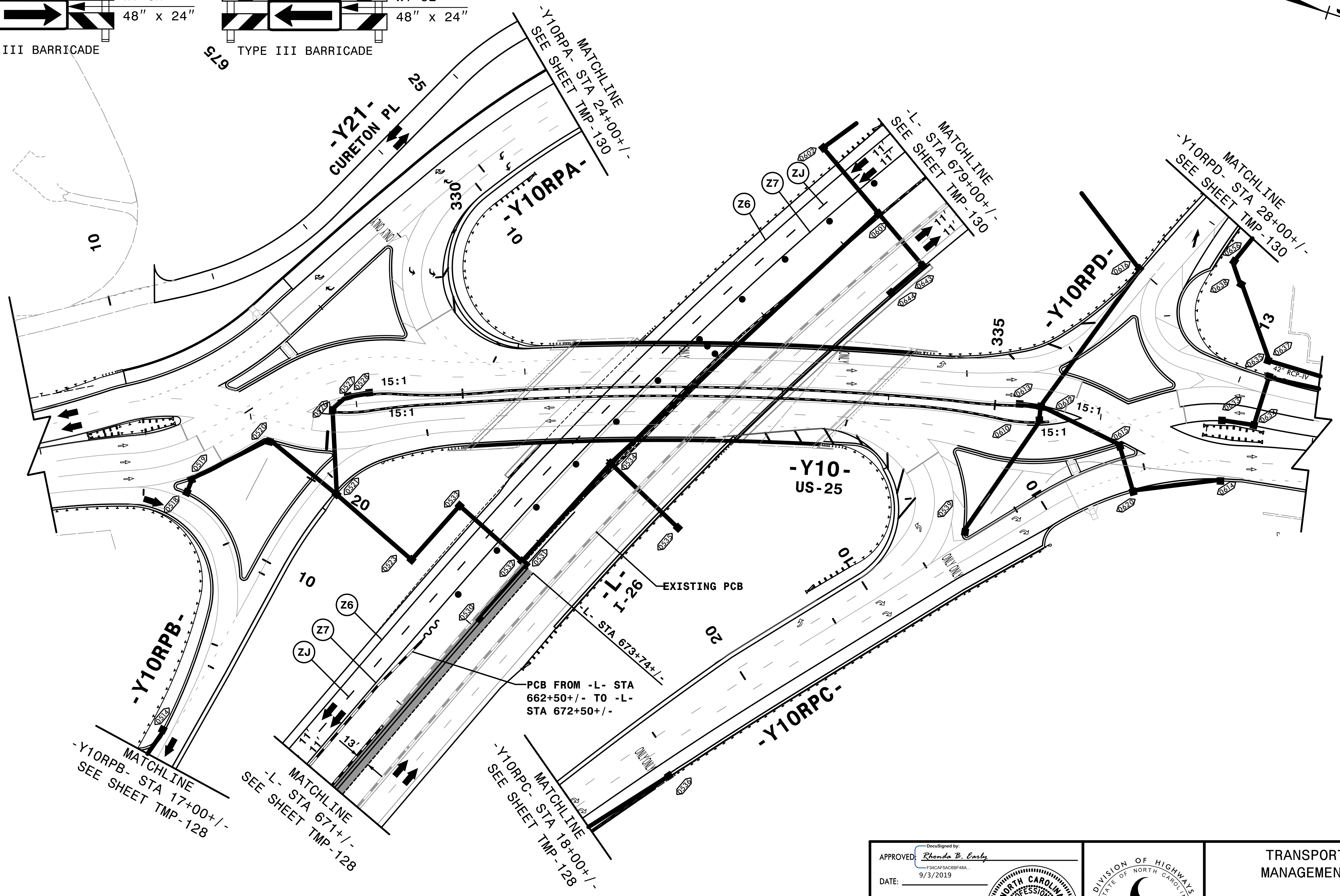
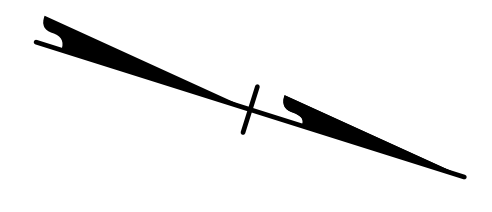
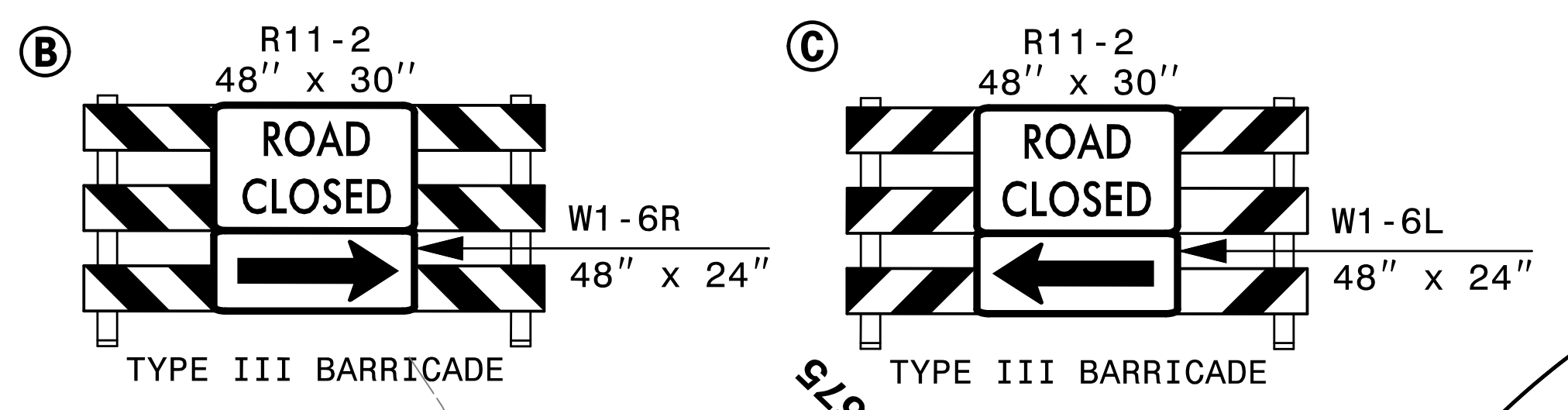

4/15/28 PM
 TCN\4400C-1c_ALP5d3.dgn
 9/3/2019

HNTB
 HNTB NORTH CAROLINA, P.C.
 343 E. Six Forks Road, Suite 200
 Raleigh, North Carolina 27609
 NC License No: C-1554

APPROVED: *Rhonda B. Early*
 DATE: 9/3/2019

**DOCUMENT NOT CONSIDERED FINAL
 UNLESS ALL SIGNATURES COMPLETED**



TRANSPORTATION
 MANAGEMENT PLAN

 PHASE V
 DETAIL

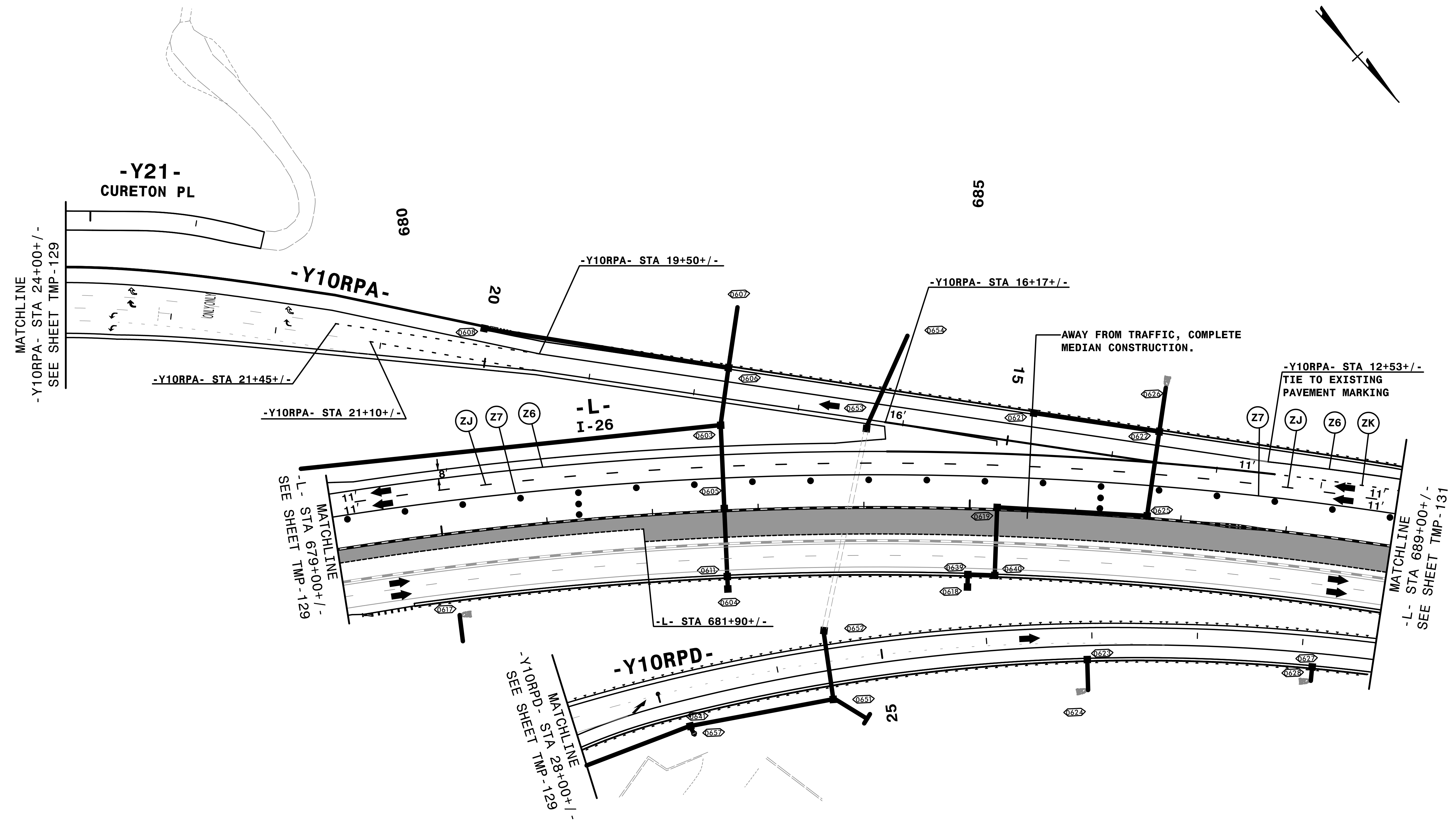

4:15:39 PM
\\TCN\4400C-TC-ALP5d4.dgn
9/3/2019

HNTB
 HNTB NORTH CAROLINA, P.C.
 343 E. Six Forks Road, Suite 200
 Raleigh, North Carolina 27609
 NC License No: C-1554

REMOVE TEMPORARY MEDIAN DRAIN.

APPROVED: *Rhonda B. Early*
 DATE: 9/3/2019

PROFESSIONAL ENGINEER
 NORTH CAROLINA
 SEAL
 023521
 RHONDA B. EARLY

**DOCUMENT NOT CONSIDERED FINAL
 UNLESS ALL SIGNATURES COMPLETED**

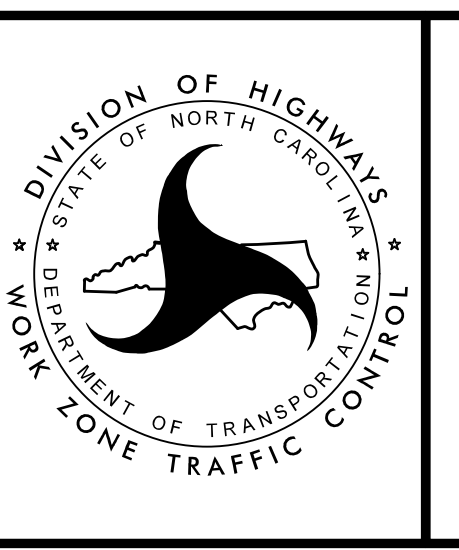

TRANSPORTATION
 MANAGEMENT PLAN

PHASE V
 DETAIL

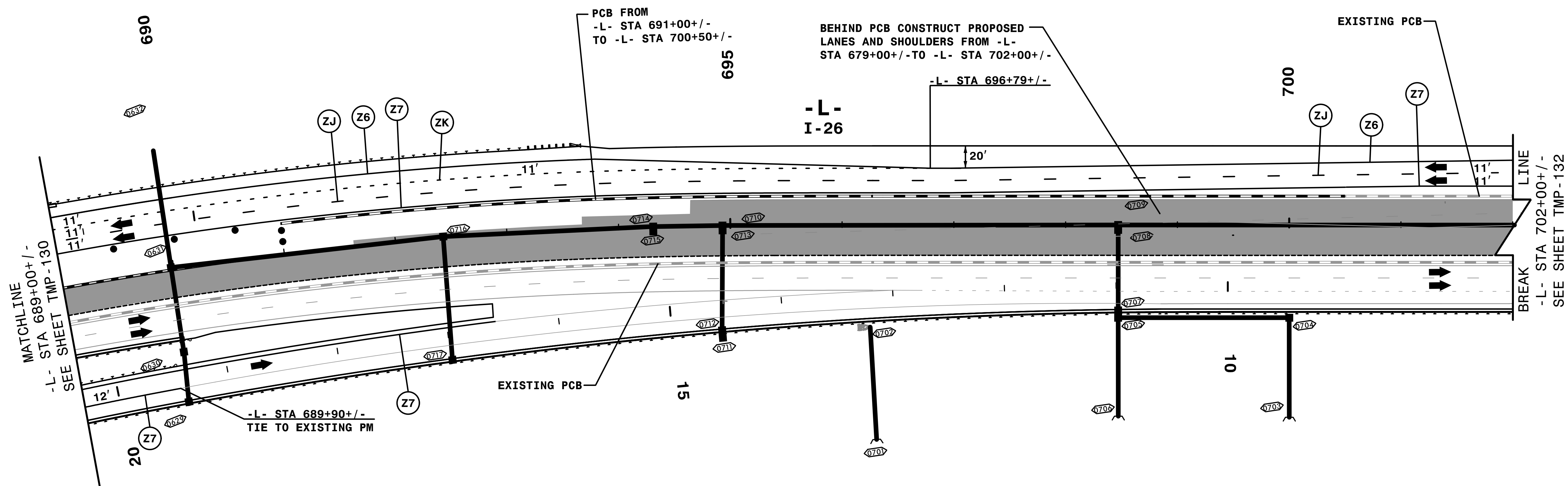
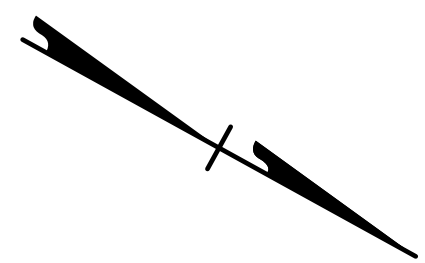

4:15:49 PM
I:\CP\4400C-1c_AL\PE5d5.dgn
9/3/2019

HNTB HNTB NORTH CAROLINA, P.C.
343 E. Six Forks Road, Suite 200
Raleigh, North Carolina 27609
NC License No: C-1554

DocuSigned by:
APPROVED: *Rhonda B. Early*
DATE: 9/3/2019

PROFESSIONAL ENGINEER
NORTH CAROLINA
SEAL
023521
RHONDA B. EARLY

**DOCUMENT NOT CONSIDERED FINAL
UNLESS ALL SIGNATURES COMPLETED**

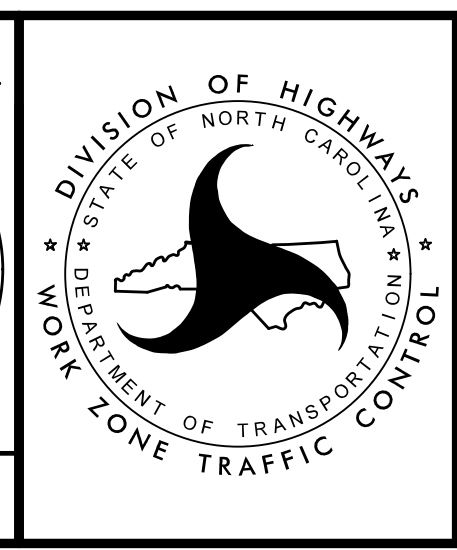

TRANSPORTATION
MANAGEMENT PLAN

PHASE V
DETAIL

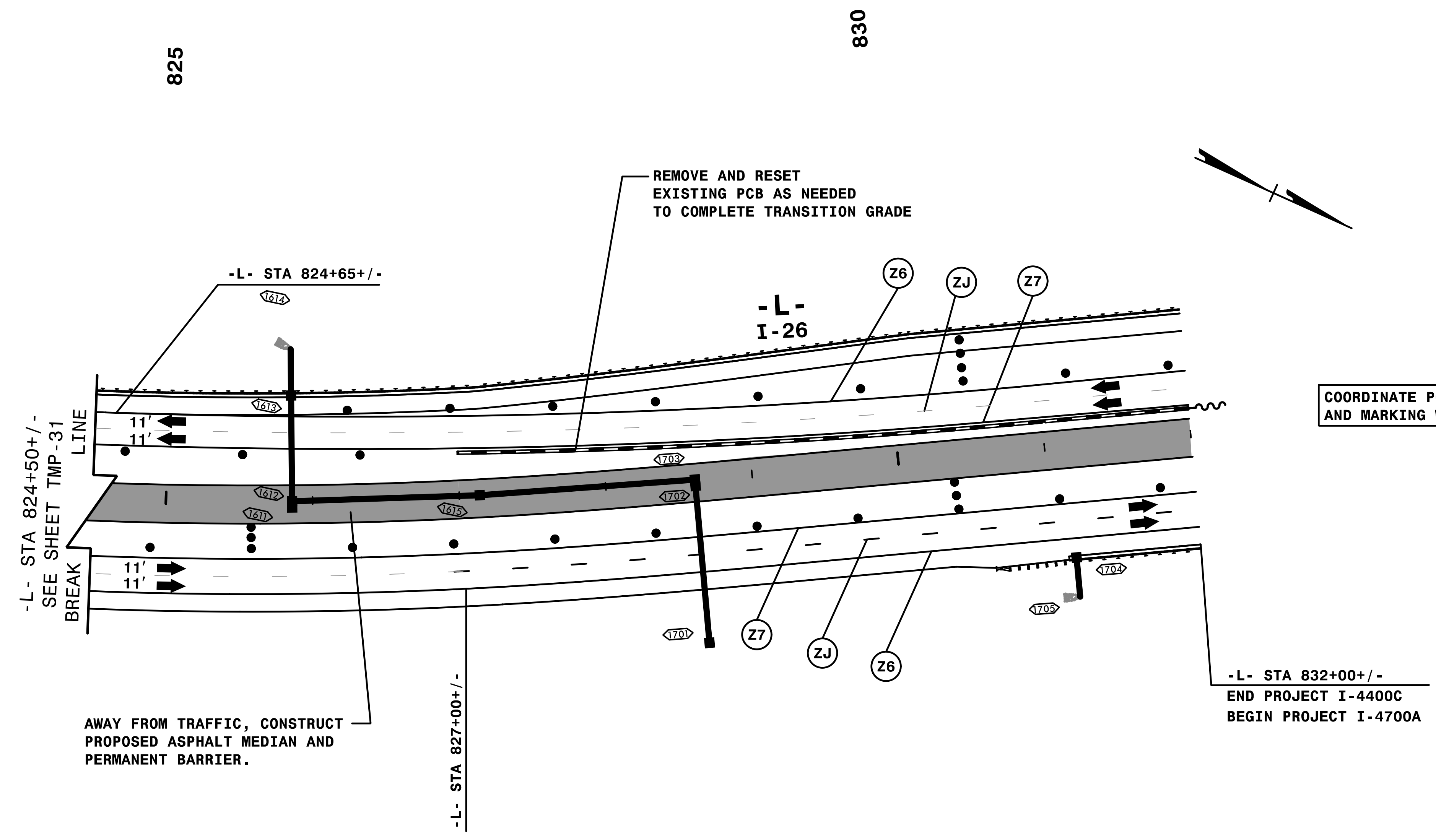

REMOVE CONFLICTING PAVEMENT MARKING.

HNTB HNTB NORTH CAROLINA, P.C.
343 E. Six Forks Road, Suite 200
Raleigh, North Carolina 27609
NC License No: C-1554

DocuSigned by:
APPROVED: *Rhonda B. Early*
F34C4F5A06BF48A...
DATE: 9/3/2019

SEAL
NORTH CAROLINA
PROFESSIONAL
ENGINEER
RHONDA B. EARLY
023521

**DOCUMENT NOT CONSIDERED FINAL
UNLESS ALL SIGNATURES COMPLETED**

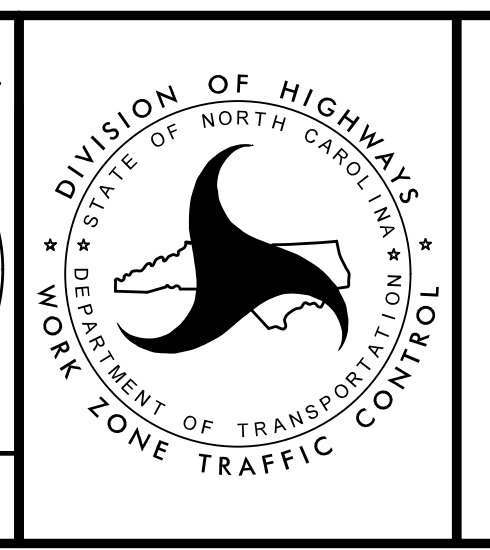

TRANSPORTATION
MANAGEMENT PLAN

PHASE V
DETAIL

9/3/2019
I:\CPN\4400C-1c-A4_P5d5.dgn
\$\$\$\$DATE\$\$\$\$