

NORTH CAROLINA DEPARTMENT OF TRANSPORTATION  
DIVISION OF HIGHWAYS  
GEOTECHNICAL ENGINEERING UNIT  
SUBSURFACE INVESTIGATION  
APPENDIX I  
CPT LOGS  
INVENTORY SECTION 5

REFERENCE: R-2582A

PROJECT: 34472

DS

/CB

INITIALS

3/11/2015

DATE



# Cone Penetration Test

C-1

Date: Apr. 9, 2013  
 Estimated Water Depth:  
 Rig/Operator: ATV/J. Brandsen

Total Depth: 8.0 ft  
 Termination Criteria: Target Depth  
 Cone Size:

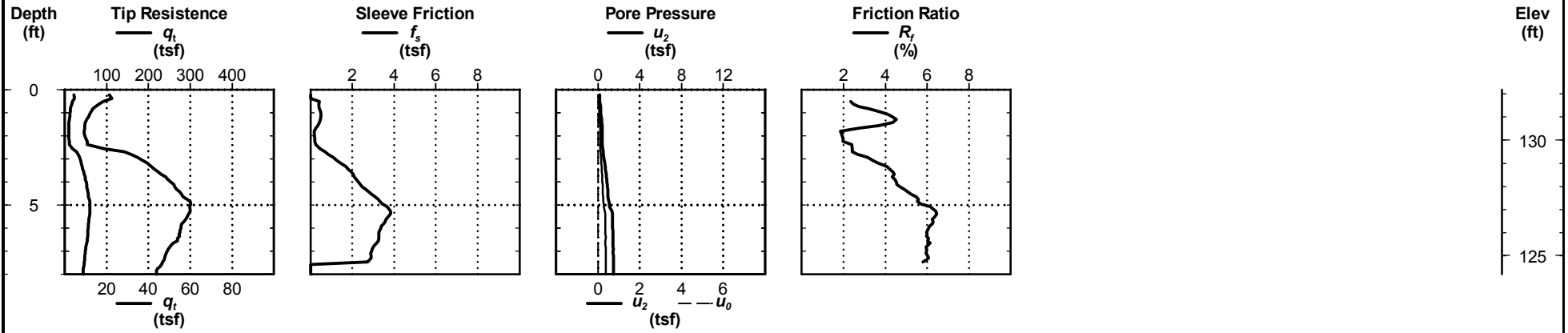

C-1



# Cone Penetration Test

C-2

Date: Apr. 9, 2013  
 Estimated Water Depth:  
 Rig/Operator: ATV/J. Brandsen

Total Depth: 10.0 ft  
 Termination Criteria: Target Depth  
 Cone Size:

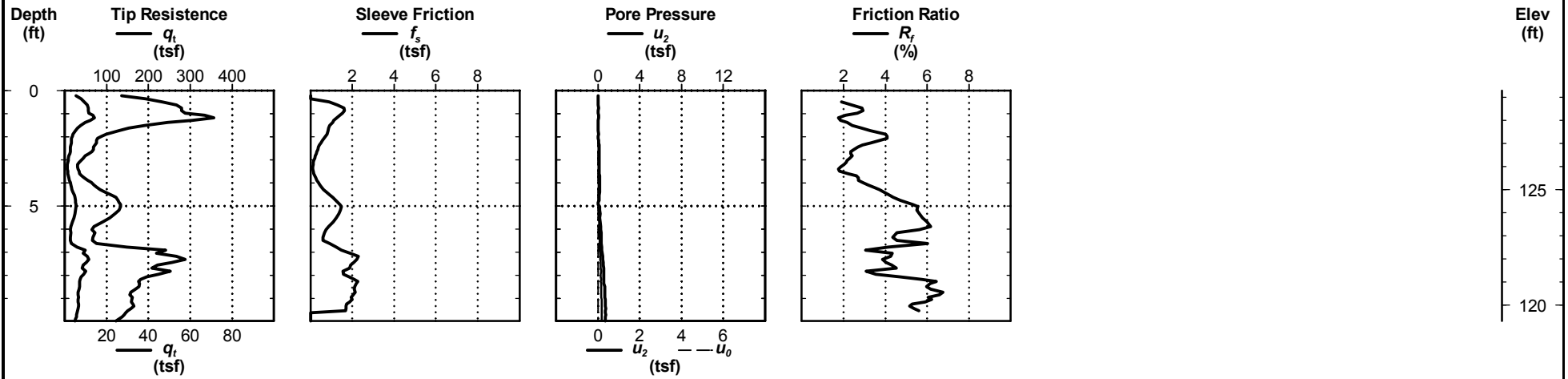

CPT REPORT - STANDARD R2582A\_GEO\_RDWY\_NORTHAMPTON\_CPT\_GINT.GPJ\_CPT V3.0.GDT 2/16/15

C-2



# Cone Penetration Test

**C-3**

Date: Apr. 9, 2013  
 Estimated Water Depth:  
 Rig/Operator: ATV/J. Brandsen

Total Depth: 15.0 ft  
 Termination Criteria: Target Depth  
 Cone Size:

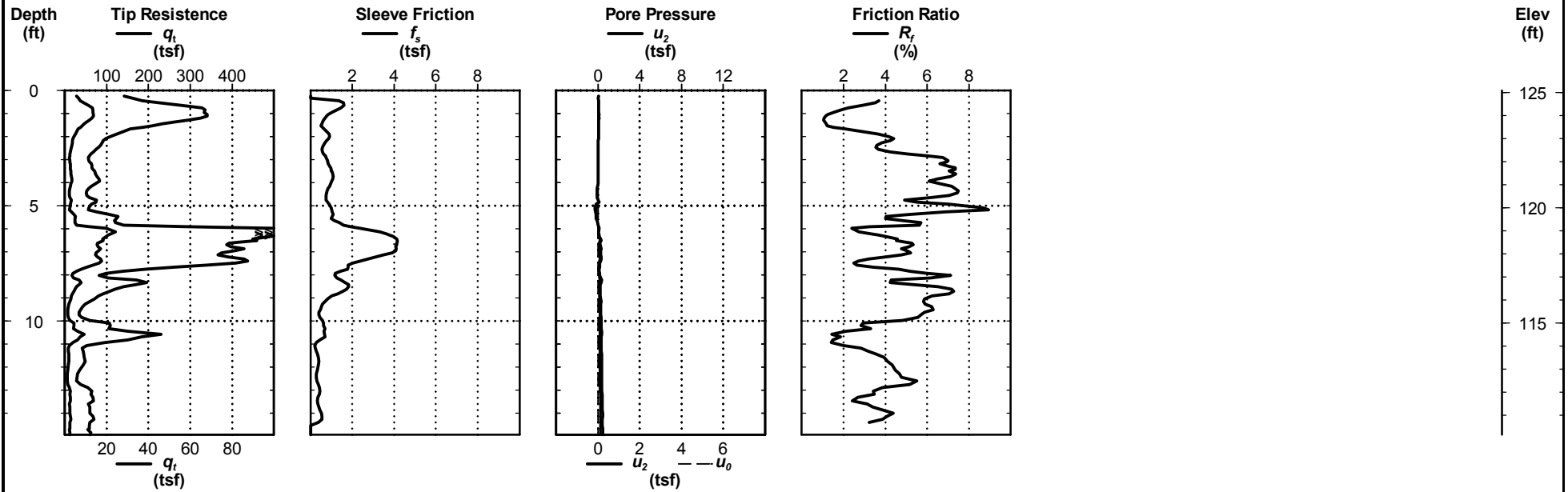

CPT REPORT - STANDARD R2582A\_GEO\_RDWY\_NORTHAMPTON\_CPT\_GINT.GPJ\_CPT\_V3.0.GDT 2/16/15

**C-3**



# Cone Penetration Test

**C-4**

Date: Apr. 9, 2013  
 Estimated Water Depth:  
 Rig/Operator: ATV/J. Brandsen

Total Depth: 8.0 ft  
 Termination Criteria: Target Depth  
 Cone Size:

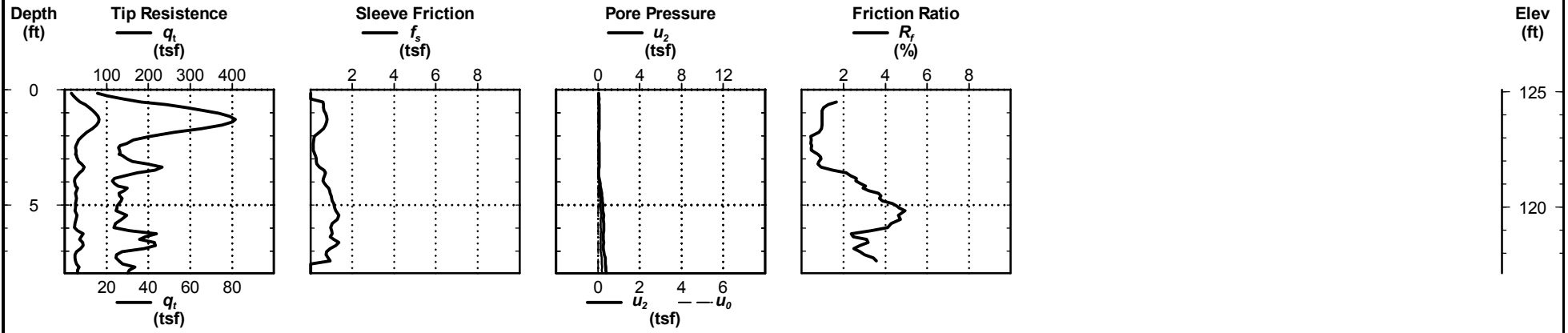

CPT REPORT - STANDARD R2582A\_GEO\_RDWY\_NORTHAMPTON\_CPT\_GINT.GPJ\_CPT V3.0.GDT 2/16/15

**C-4**



# Cone Penetration Test

**C-5**

Date: Apr. 9, 2013  
 Estimated Water Depth:  
 Rig/Operator: ATV/J. Brandsen

Total Depth: 8.1 ft  
 Termination Criteria: Target Depth  
 Cone Size:

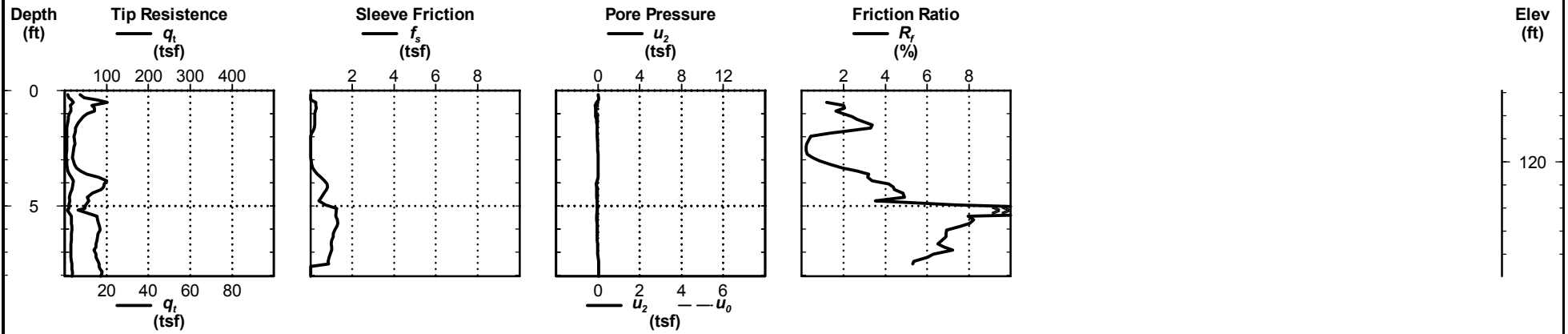

CPT REPORT - STANDARD R2582A\_GEO\_RDWY\_NORTHAMPTON\_CPT\_GINT.GPJ\_CPT V3.0.GDT 2/16/15

**C-5**



# Cone Penetration Test

**C-6**

Date: Apr. 9, 2013  
 Estimated Water Depth:  
 Rig/Operator: ATV/J. Brandsen

Total Depth: 8.0 ft  
 Termination Criteria: Target Depth  
 Cone Size:

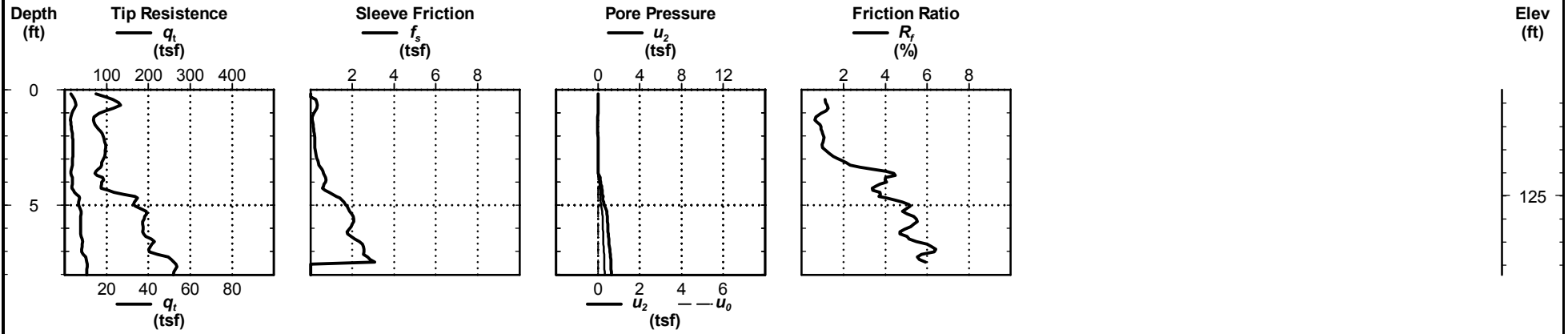

**C-6**



# Cone Penetration Test

**C-7**

Date: Apr. 9, 2013  
 Estimated Water Depth:  
 Rig/Operator: ATV/J. Brandsen

Total Depth: 7.9 ft  
 Termination Criteria: Target Depth  
 Cone Size:

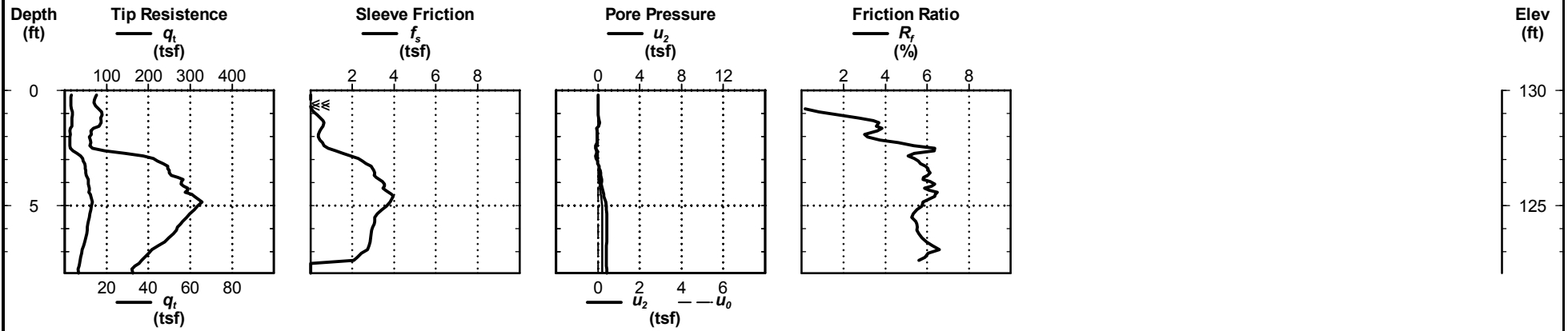

CPT REPORT - STANDARD R2582A\_GEO\_RDWY\_NORTHAMPTON\_CPT\_GINT.GPJ\_CPT\_V3.0.GDT 2/16/15

**C-7**





# Cone Penetration Test

C-8

Date: Apr. 9, 2013  
 Estimated Water Depth:  
 Rig/Operator: ATV/J. Brandsen

Total Depth: 10.0 ft  
 Termination Criteria: Target Depth  
 Cone Size:

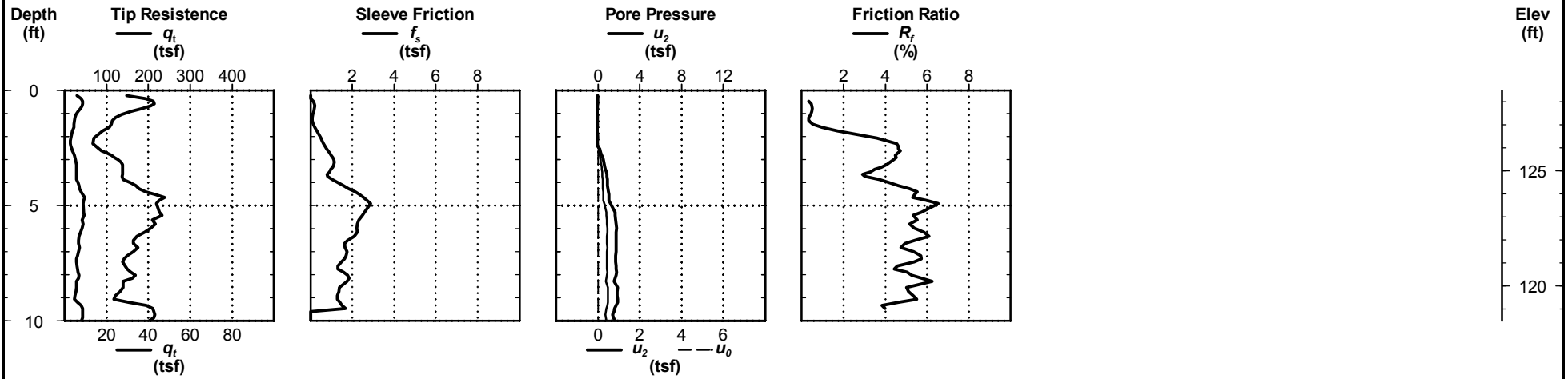

CPT REPORT - STANDARD R2582A\_GEO\_RDWY\_NORTHAMPTON\_CPT\_GINT.GPJ\_CPT\_V3.0.GDT 2/16/15

C-8



# Cone Penetration Test

**C-9**

Date: Apr. 9, 2013  
 Estimated Water Depth:  
 Rig/Operator: ATV/J. Brandsen

Total Depth: 10.0 ft  
 Termination Criteria: Target Depth  
 Cone Size:

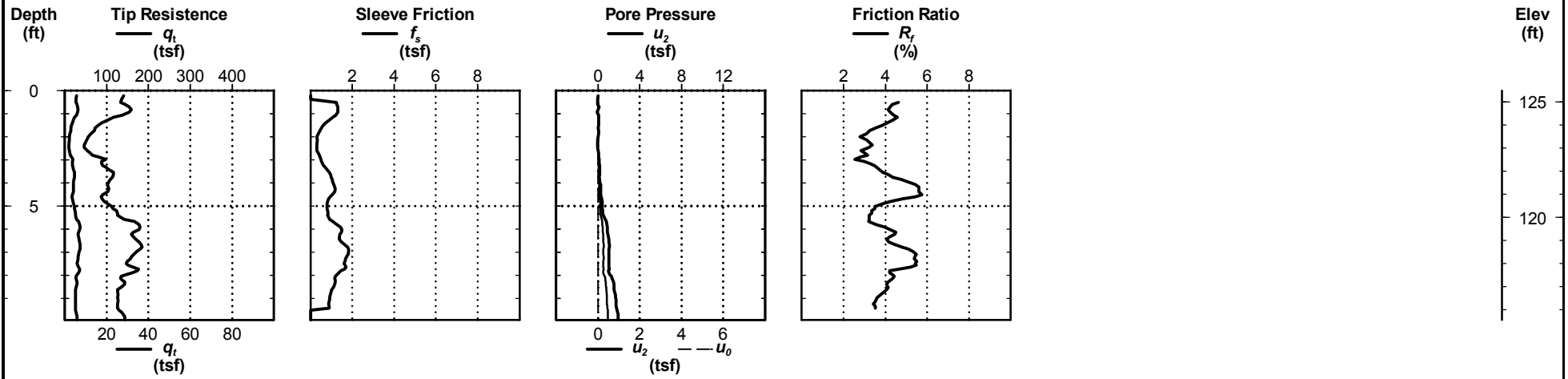

CPT REPORT - STANDARD R2582A\_GEO\_RDWY\_NORTHAMPTON\_CPT\_GINT.GPJ\_CPT\_V3.0.GDT 2/16/15

**C-9**



# Cone Penetration Test

**C-10**

Date: Apr. 9, 2013  
 Estimated Water Depth:  
 Rig/Operator: ATV/J. Brandsen

Total Depth: 10.8 ft  
 Termination Criteria: Target Depth  
 Cone Size:

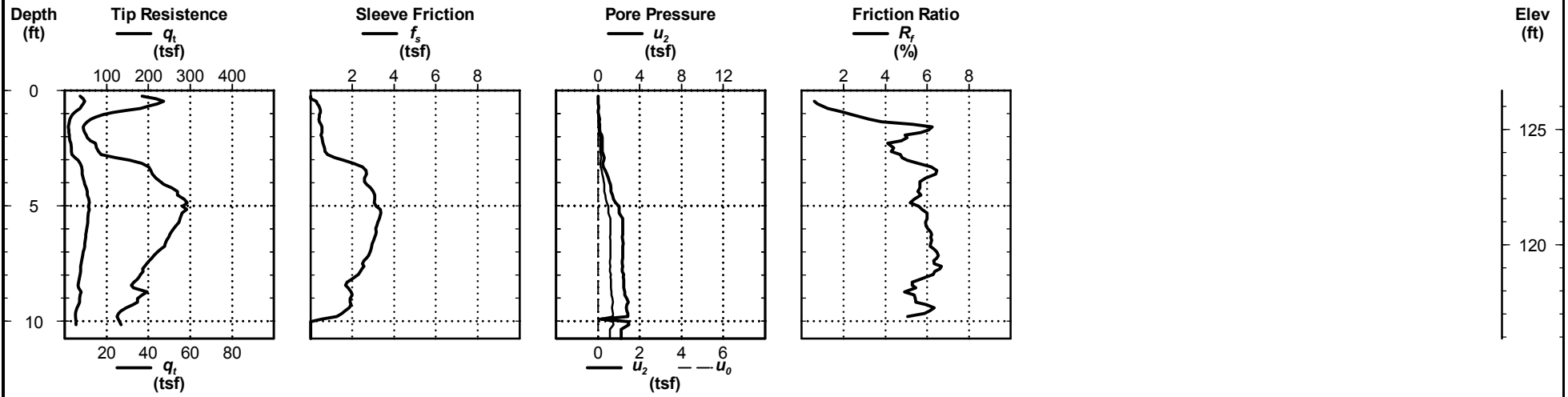

CPT REPORT - STANDARD R2582A\_GEO\_RDWY\_NORTHAMPTON\_CPT\_GINT.GPJ\_CPT\_V3.0.GDT 2/16/15

**C-10**



# Cone Penetration Test

**C-11**

Date: Apr. 9, 2013  
 Estimated Water Depth:  
 Rig/Operator: ATV/J. Brandsen

Total Depth: 10.0 ft  
 Termination Criteria: Target Depth  
 Cone Size:

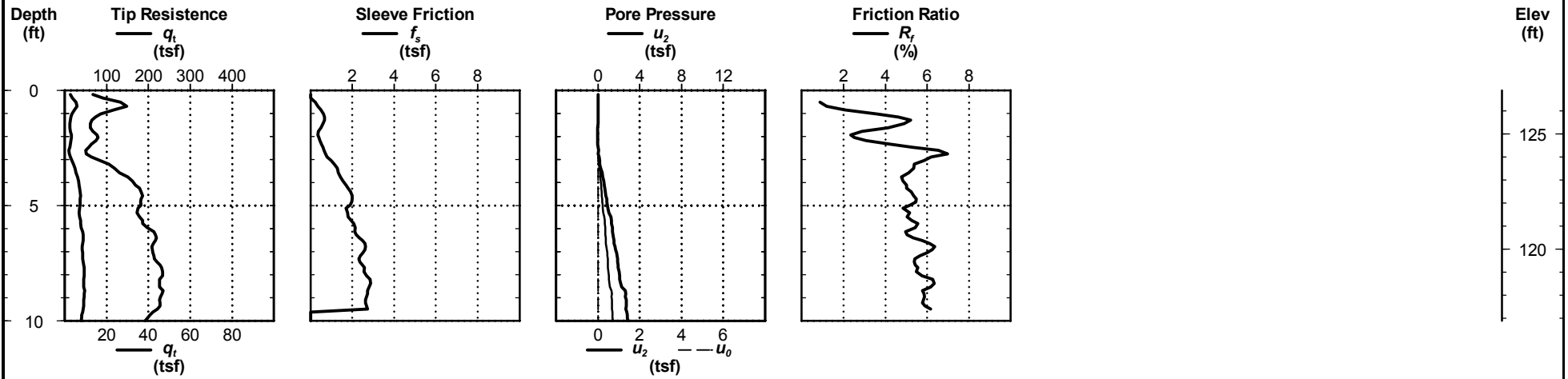

CPT REPORT - STANDARD R2582A\_GEO\_RDWY\_NORTHAMPTON\_CPT\_GINT.GPJ\_CPT\_V3.0.GDT 2/16/15

**C-11**



# Cone Penetration Test

# C-12

Date: Apr. 9, 2013  
 Estimated Water Depth:  
 Rig/Operator: ATV/J. Brandsen

Total Depth: 10.0 ft  
 Termination Criteria: Target Depth  
 Cone Size:

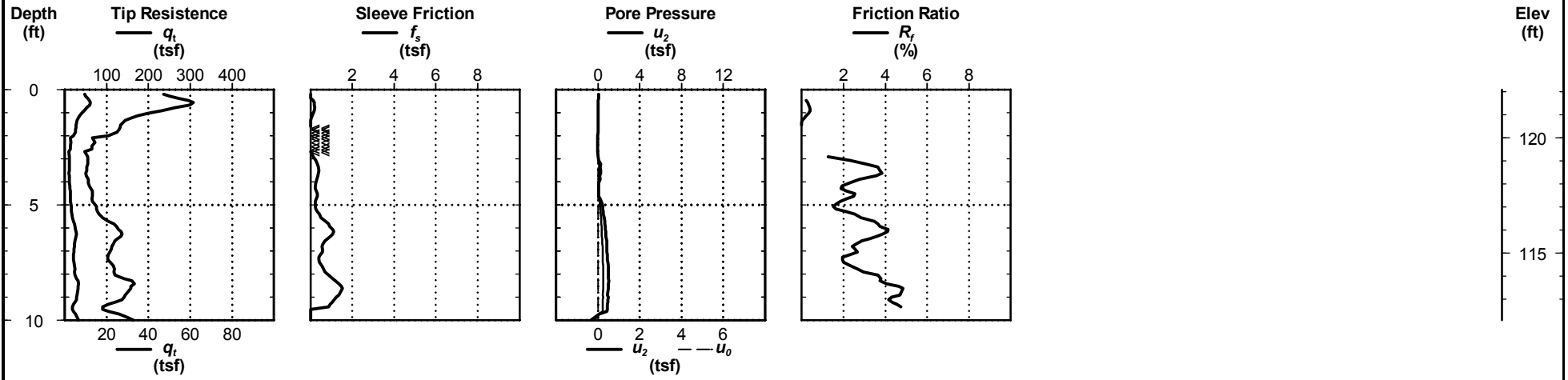

CPT REPORT - STANDARD R2582A\_GEO\_RDWY\_NORTHAMPTON\_CPT\_GINT.GPJ\_CPT\_V3.0.GDT 2/16/15

# C-12



# Cone Penetration Test

**C-13**

Date: Apr. 9, 2013  
 Estimated Water Depth:  
 Rig/Operator: ATV/J. Brandsen

Total Depth: 10.0 ft  
 Termination Criteria: Target Depth  
 Cone Size:

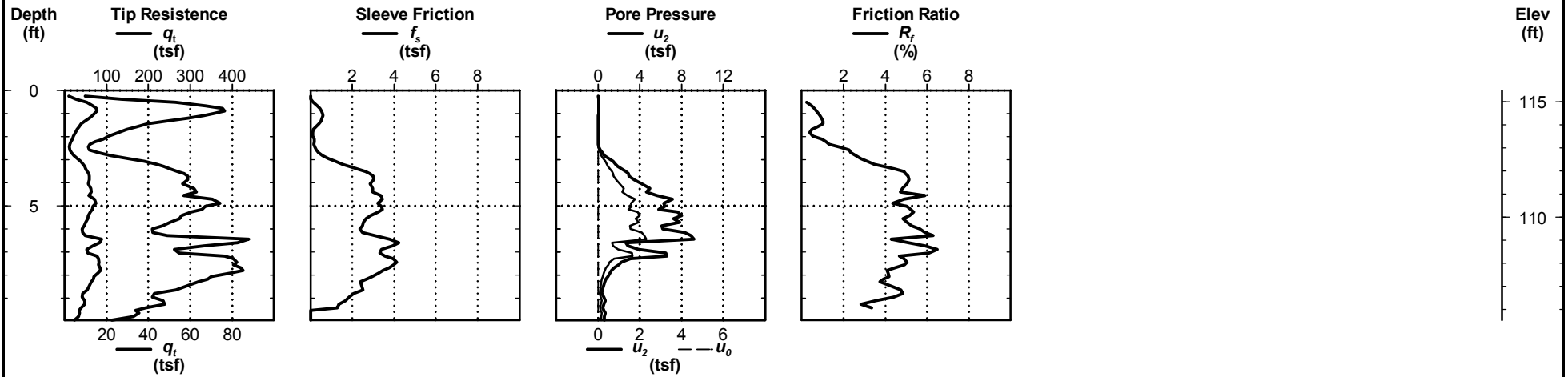

CPT REPORT - STANDARD R2582A\_GEO\_RDWY\_NORTHAMPTON\_CPT\_GINT.GPJ\_CPT\_V3.0.GDT 2/16/15

**C-13**



# Cone Penetration Test

# C-14

Date: Apr. 9, 2013  
 Estimated Water Depth:  
 Rig/Operator: ATV/J. Brandsen

Total Depth: 15.0 ft  
 Termination Criteria: Target Depth  
 Cone Size:

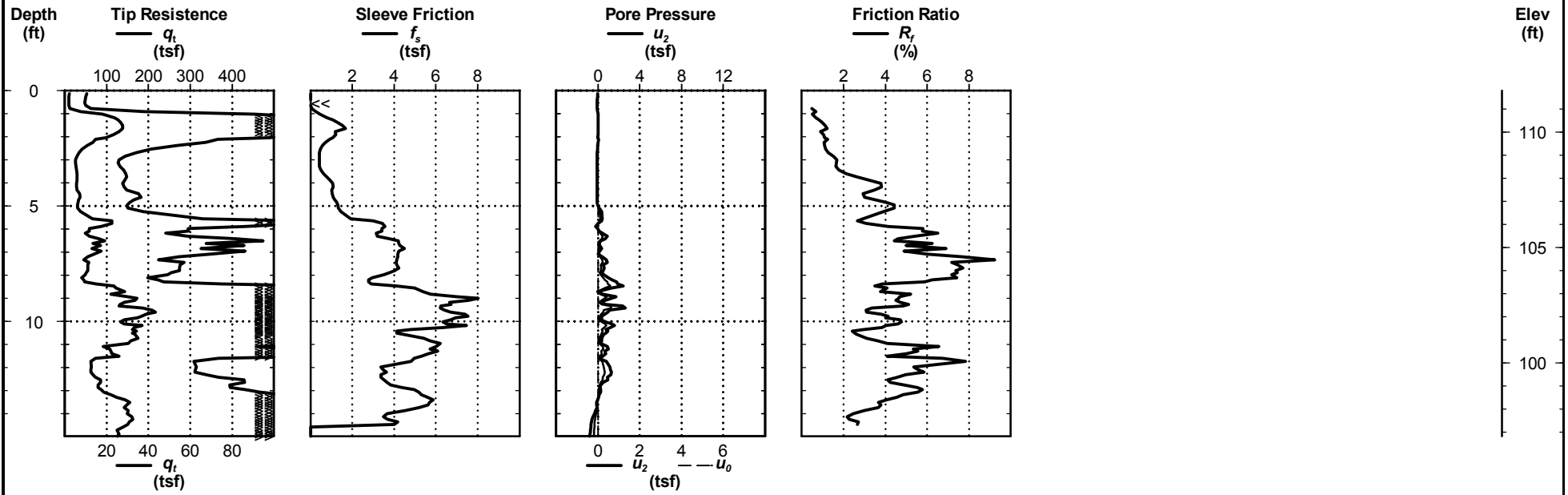

CPT REPORT - STANDARD R2582A\_GEO\_RDWY\_NORTHAMPTON\_CPT\_GINT.GPJ\_CPT\_V3.0.GDT 2/16/15

# C-14



# Cone Penetration Test

**C-15**

Date: Apr. 8, 2013  
 Estimated Water Depth:  
 Rig/Operator: ATV/J. Brandsen

Total Depth: 8.7 ft  
 Termination Criteria: Target Depth  
 Cone Size:

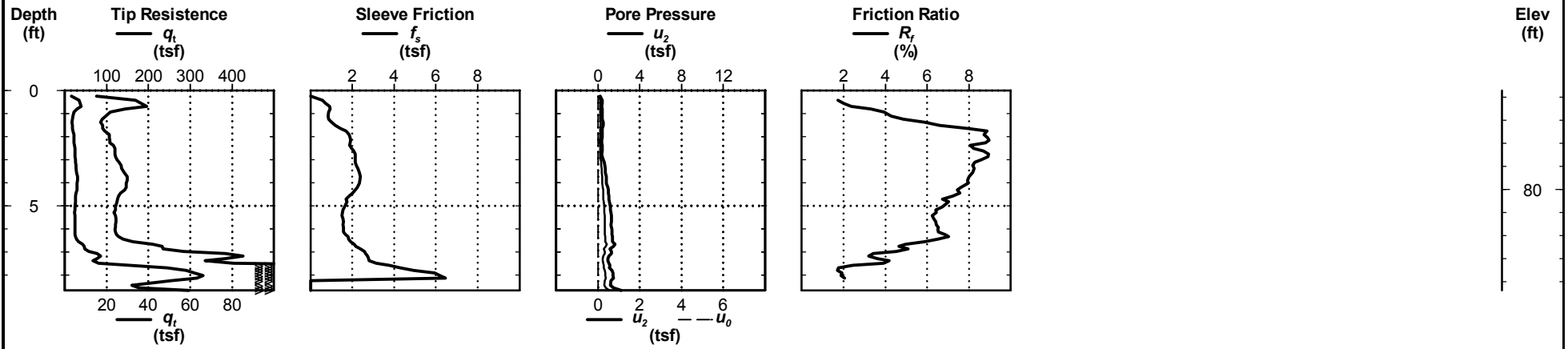

CPT REPORT - STANDARD R2582A\_GEO\_RDWY\_NORTHAMPTON\_CPT\_GINT.GPJ\_CPT\_V3.0.GDT 2/16/15

**C-15**





# Cone Penetration Test

**C-16**

Date: Apr. 9, 2013  
 Estimated Water Depth:  
 Rig/Operator: ATV/J. Brandsen

Total Depth: 7.5 ft  
 Termination Criteria: Target Depth  
 Cone Size:

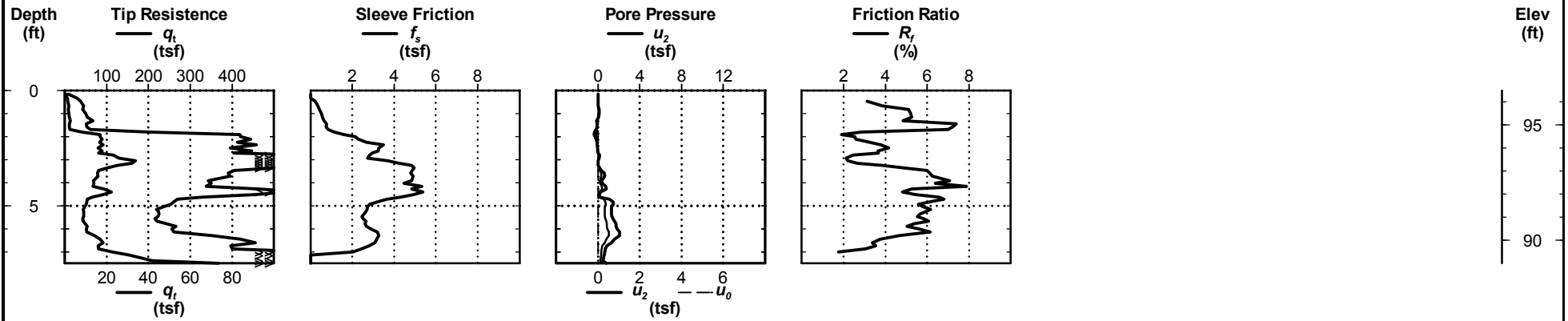

CPT REPORT - STANDARD R2582A\_GEO\_RDWY\_NORTHAMPTON\_CPT\_GINT.GPJ\_CPT\_V3.0.GDT 2/16/15

**C-16**



# Cone Penetration Test

**C-17**

Date: Apr. 8, 2013  
 Estimated Water Depth:  
 Rig/Operator: ATV/J. Brandsen

Total Depth: 16.8 ft  
 Termination Criteria: Target Depth  
 Cone Size:

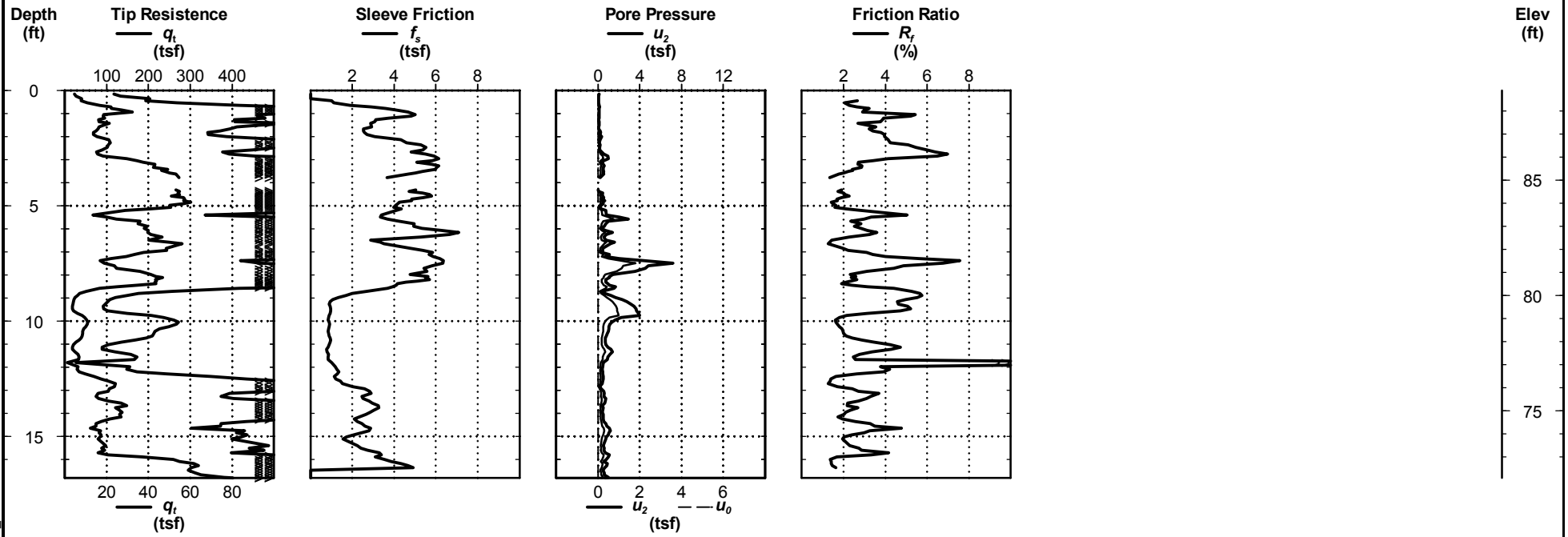

CPT REPORT - STANDARD R2582A\_GEO\_RDWY\_NORTHAMPTON\_CPT\_GINT.GPJ\_CPT V3.0.GDT 2/16/15

**C-17**



# Cone Penetration Test

**C-18**

Date: Apr. 9, 2013  
 Estimated Water Depth:  
 Rig/Operator: ATV/J. Brandsen

Total Depth: 12.0 ft  
 Termination Criteria: Target Depth  
 Cone Size:

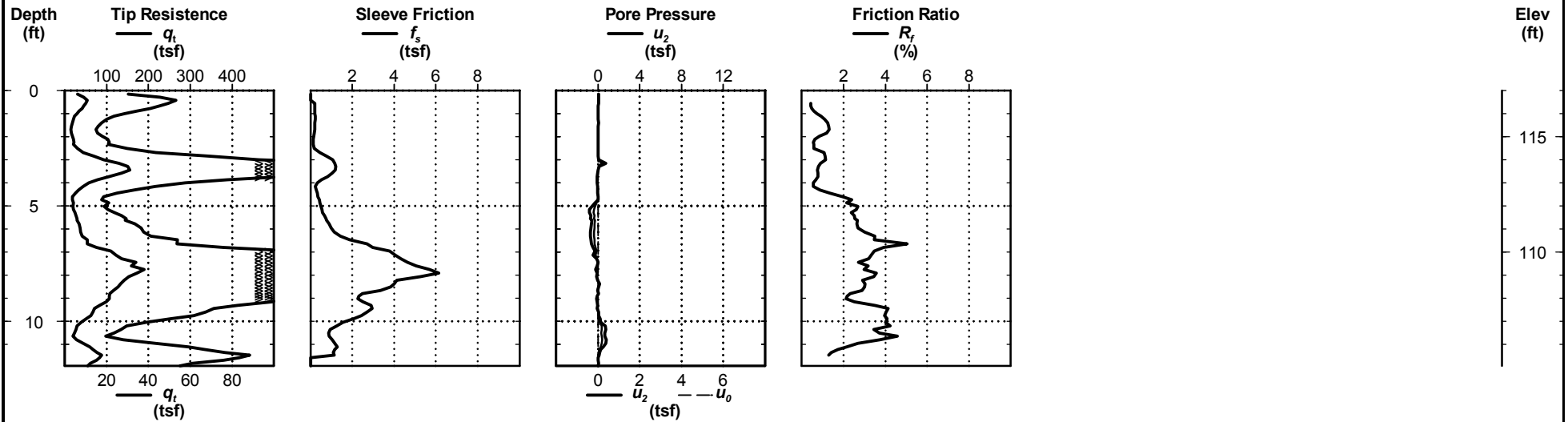

CPT REPORT - STANDARD R2582A\_GEO\_RDWY\_NORTHAMPTON\_CPT\_GINT.GPJ\_CPT\_V3.0.GDT 2/16/15

**C-18**



# Cone Penetration Test

**C-19**

Date: Apr. 8, 2013  
 Estimated Water Depth:  
 Rig/Operator: ATV/J. Brandsen

Total Depth: 10.0 ft  
 Termination Criteria: Target Depth  
 Cone Size:

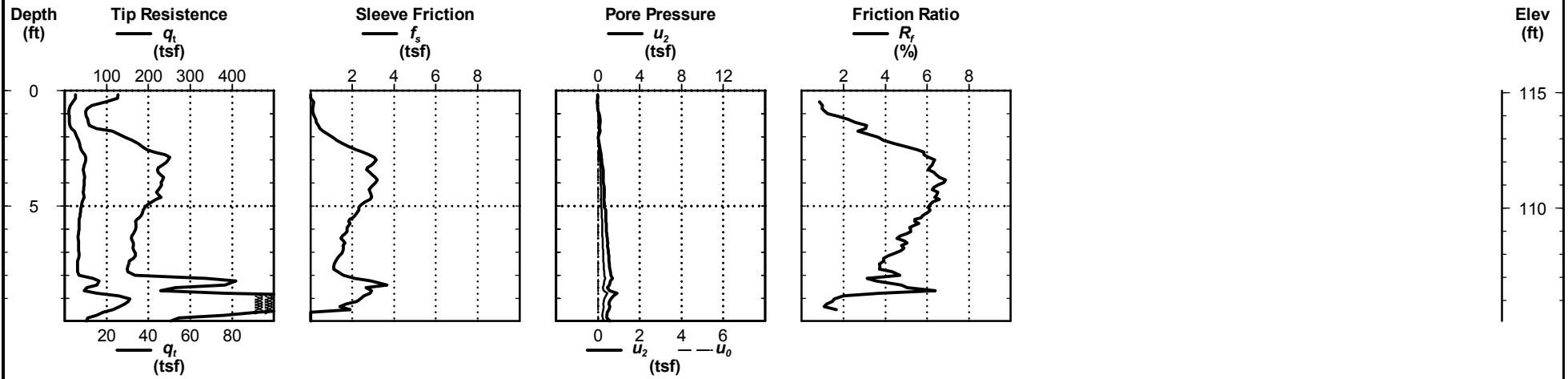

CPT REPORT - STANDARD R2582A\_GEO\_RDWY\_NORTHAMPTON\_CPT\_GINT.GPJ\_CPT\_V3.0.GDT 2/16/15

**C-19**



# Cone Penetration Test

**C-20**

Date: Apr. 8, 2013  
 Estimated Water Depth:  
 Rig/Operator: ATV/J. Brandsen

Total Depth: 10.1 ft  
 Termination Criteria: Target Depth  
 Cone Size:

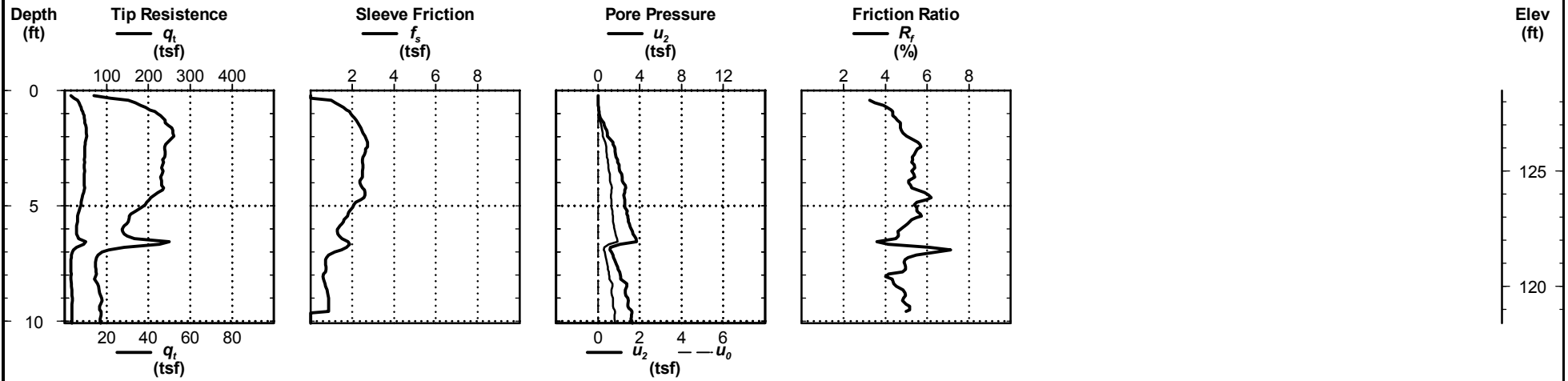

CPT REPORT - STANDARD R2582A\_GEO\_RDWY\_NORTHAMPTON\_CPT\_GINT.GPJ\_CPT\_V3.0.GDT 2/16/15

**C-20**



# Cone Penetration Test

**C-21**

Date: Apr. 8, 2013  
 Estimated Water Depth:  
 Rig/Operator: ATV/J. Brandsen

Total Depth: 15.9 ft  
 Termination Criteria: Target Depth  
 Cone Size:

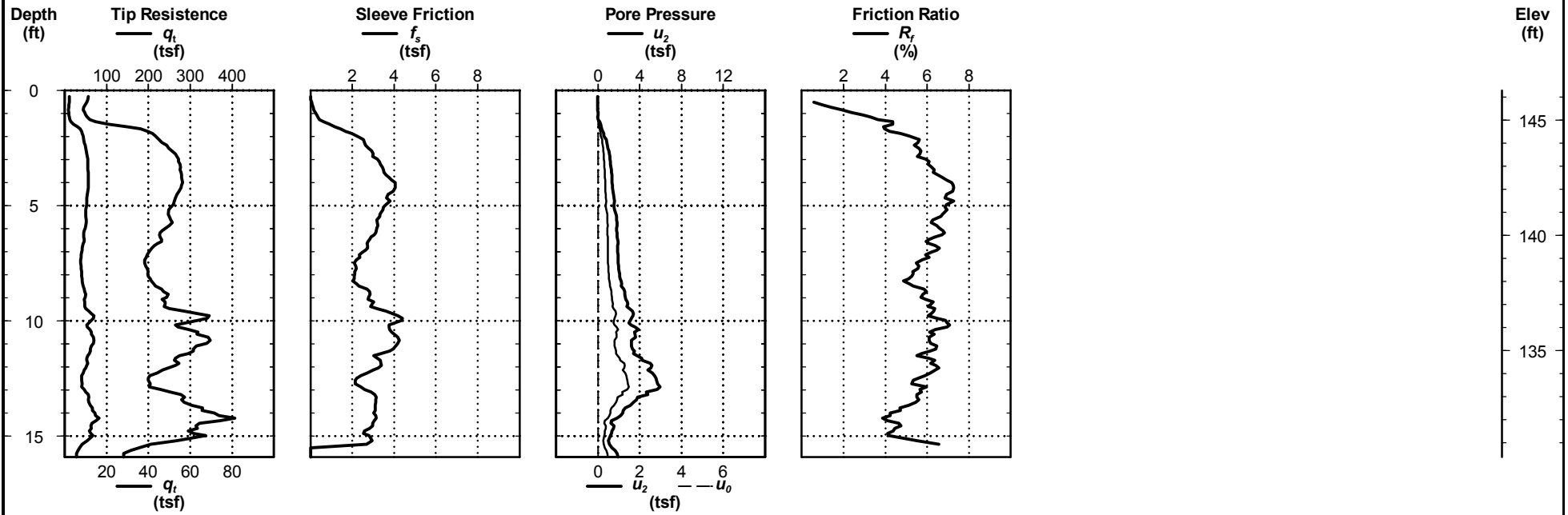

CPT REPORT - STANDARD R2582A\_GEO\_RDWY\_NORTHAMPTON\_CPT\_GINT.GPJ\_CPT\_V3.0.GDT 2/16/15

**C-21**



# Cone Penetration Test

**C-22**

Date: Apr. 8, 2013  
 Estimated Water Depth:  
 Rig/Operator: ATV/J. Brandsen

Total Depth: 10.1 ft  
 Termination Criteria: Target Depth  
 Cone Size:

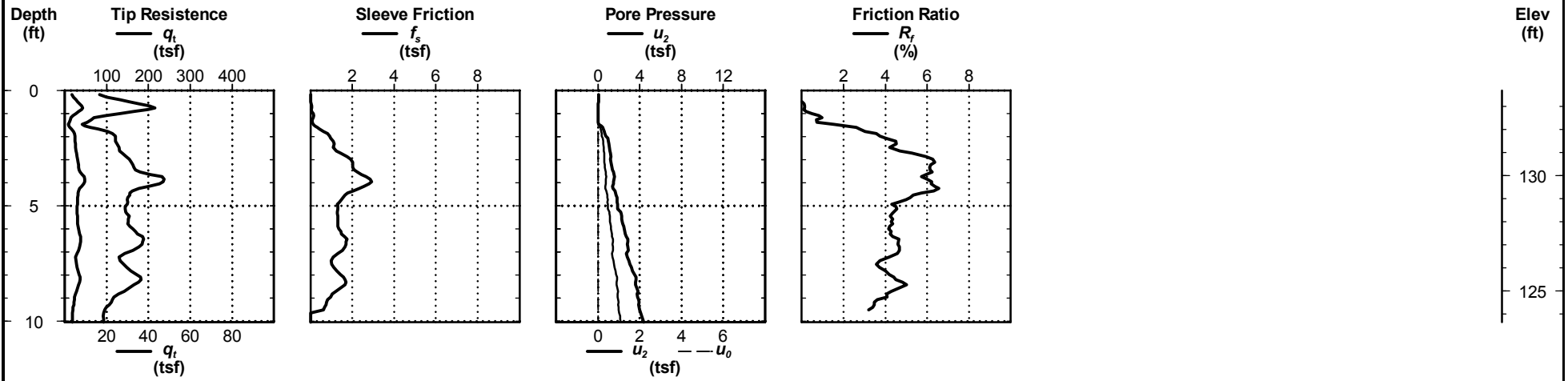

CPT REPORT - STANDARD R2582A\_GEO\_RDWY\_NORTHAMPTON\_CPT\_GINT.GPJ\_CPT V3.0.GDT 2/16/15

**C-22**



# Cone Penetration Test

**C-23**

Date: Apr. 8, 2013  
 Estimated Water Depth:  
 Rig/Operator: ATV/J. Brandsen

Total Depth: 10.0 ft  
 Termination Criteria: Target Depth  
 Cone Size:

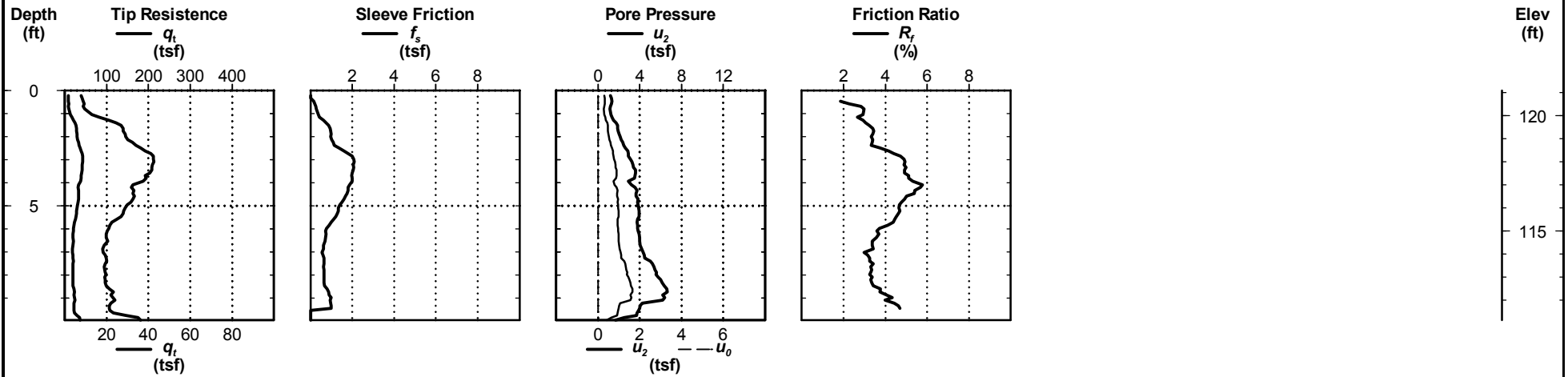

CPT REPORT - STANDARD R2582A\_GEO\_RDWY\_NORTHAMPTON\_CPT\_GINT.GPJ\_CPT\_V3.0.GDT 2/16/15

**C-23**





# Cone Penetration Test

**C-24**

Date: Apr. 8, 2013  
 Estimated Water Depth:  
 Rig/Operator: ATV/J. Brandsen

Total Depth: 10.0 ft  
 Termination Criteria: Target Depth  
 Cone Size:

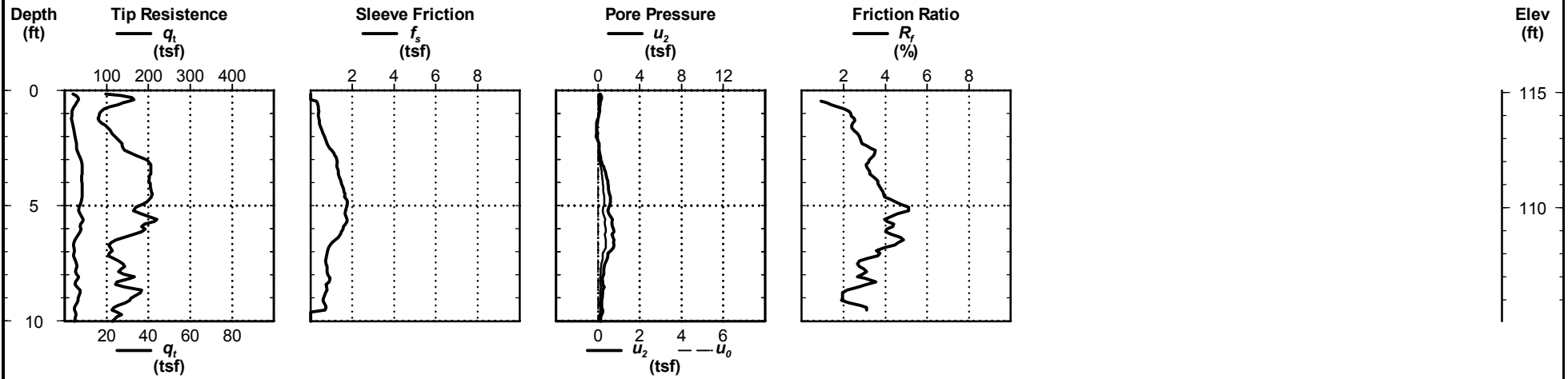

CPT REPORT - STANDARD R2582A\_GEO\_RDWY\_NORTHAMPTON\_CPT\_GINT.GPJ\_CPT\_V3.0.GDT 2/16/15

**C-24**



# Cone Penetration Test

**C-25**

Date: Apr. 8, 2013  
 Estimated Water Depth:  
 Rig/Operator: ATV/J. Brandsen

Total Depth: 11.7 ft  
 Termination Criteria: Target Depth  
 Cone Size:

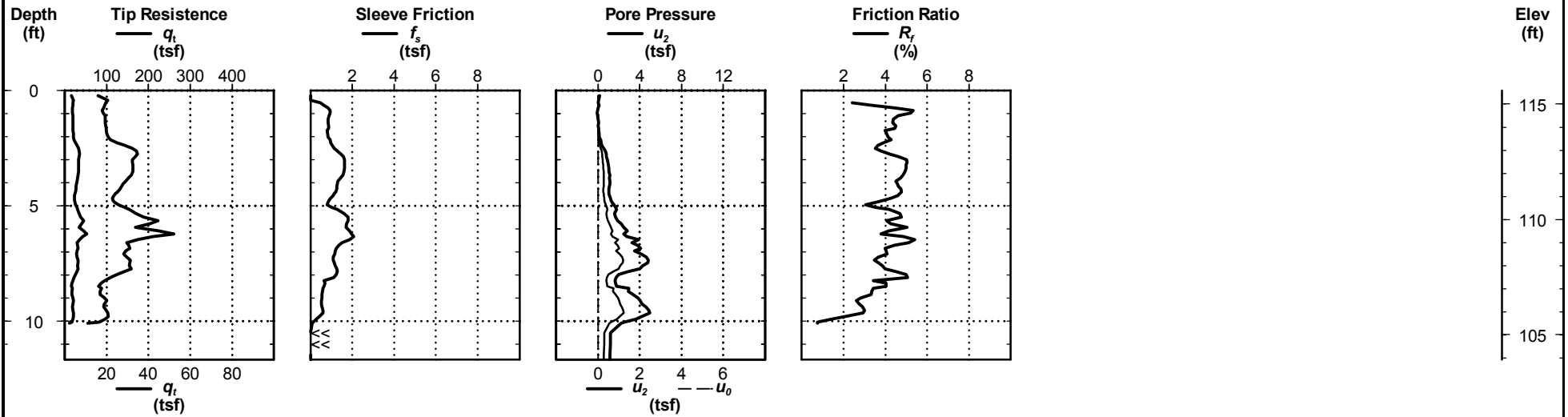

CPT REPORT - STANDARD R2582A\_GEO\_RDWY\_NORTHAMPTON\_CPT\_GINT.GPJ\_CPT\_V3.0.GDT 2/16/15

**C-25**



# Cone Penetration Test

**C-26**

Date: Apr. 5, 2013  
 Estimated Water Depth:  
 Rig/Operator: ATV/J. Brandsen

Total Depth: 10.0 ft  
 Termination Criteria: Target Depth  
 Cone Size:

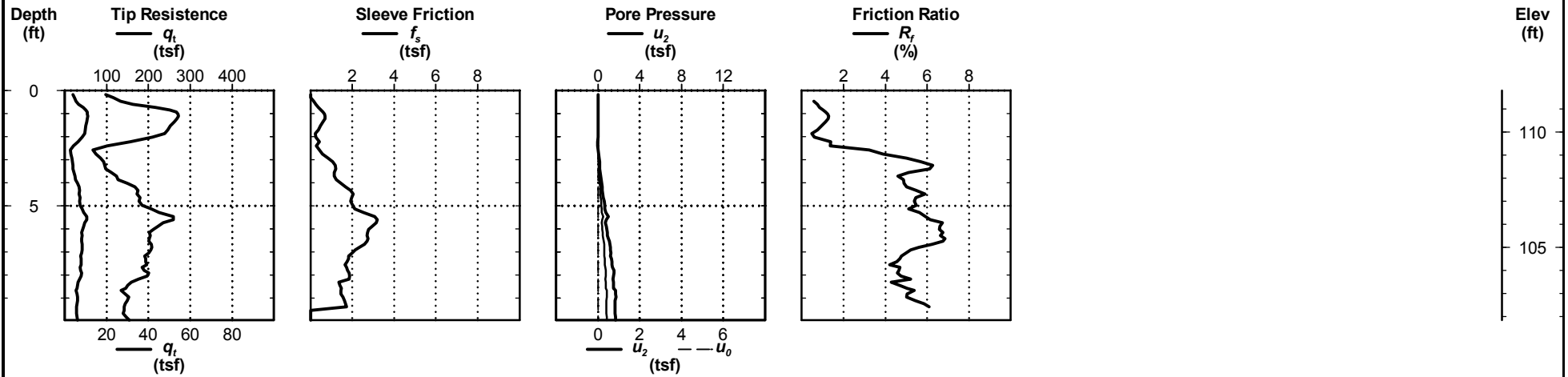

CPT REPORT - STANDARD R2582A\_GEO\_RDWY\_NORTHAMPTON\_CPT\_GINT.GPJ\_CPT V3.0.GDT 2/16/15

**C-26**



# Cone Penetration Test

**C-27**

Date: Apr. 5, 2013  
 Estimated Water Depth:  
 Rig/Operator: ATV/J. Brandsen

Total Depth: 11.2 ft  
 Termination Criteria: Target Depth  
 Cone Size:

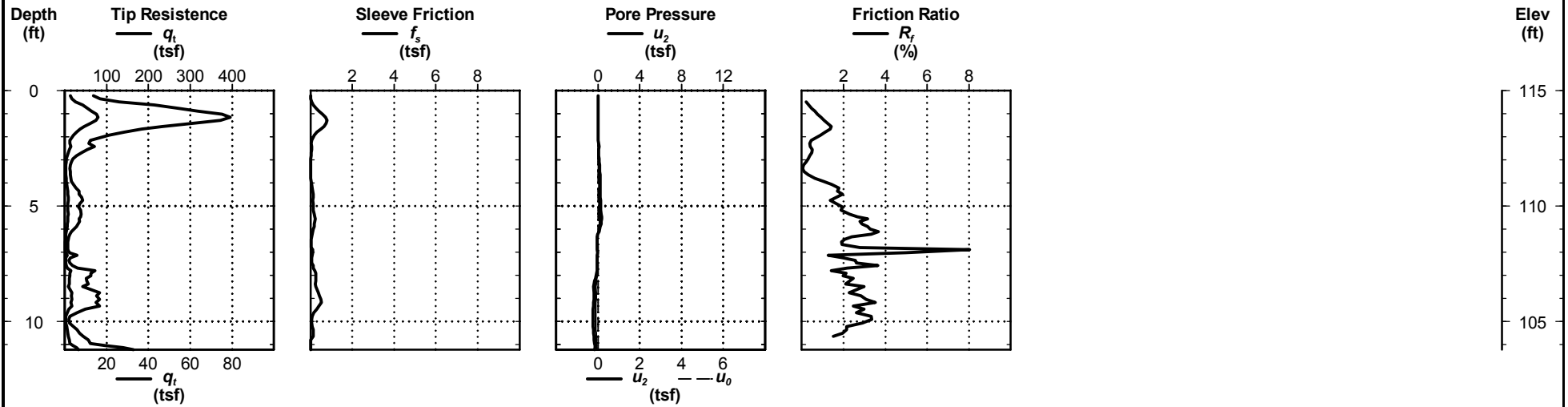

CPT REPORT - STANDARD R2582A\_GEO\_RDWY\_NORTHAMPTON\_CPT\_GINT.GPJ\_CPT\_V3.0.GDT 2/16/15

**C-27**



# Cone Penetration Test

**C-28**

Date: Apr. 5, 2013  
 Estimated Water Depth:  
 Rig/Operator: ATV/J. Brandsen

Total Depth: 10.0 ft  
 Termination Criteria: Target Depth  
 Cone Size:

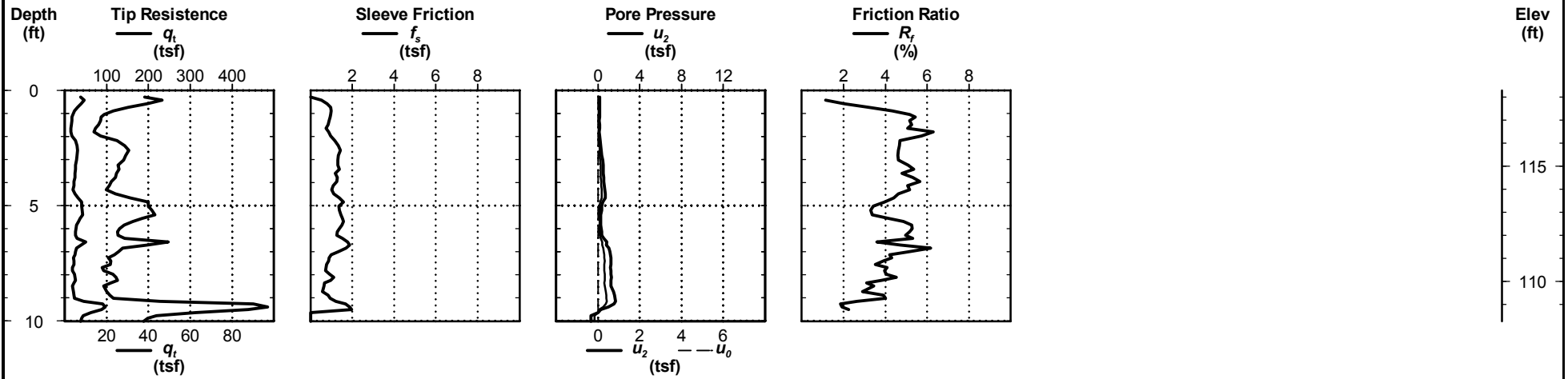

CPT REPORT - STANDARD R2582A\_GEO\_RDWY\_NORTHAMPTON\_CPT\_GINT.GPJ\_CPT\_V3.0.GDT 2/16/15

**C-28**



# Cone Penetration Test

**C-29**

Date: Apr. 5, 2013  
 Estimated Water Depth:  
 Rig/Operator: ATV/J. Brandsen

Total Depth: 10.0 ft  
 Termination Criteria: Target Depth  
 Cone Size:

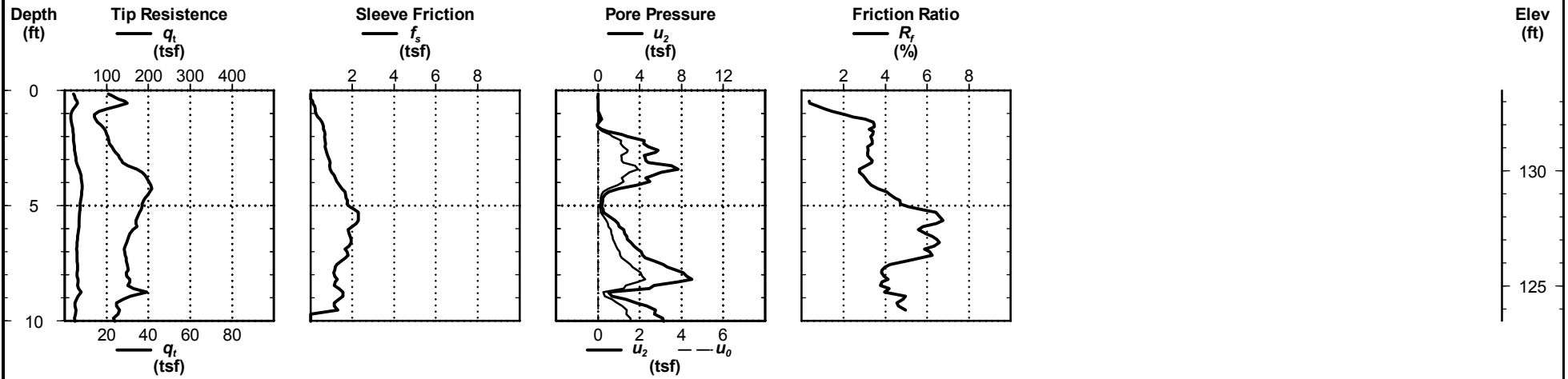

CPT REPORT - STANDARD R2582A\_GEO\_RDWY\_NORTHAMPTON\_CPT\_GINT.GPJ\_CPT\_V3.0.GDT 2/16/15

**C-29**



# Cone Penetration Test

**C-30**

Date: Apr. 4, 2013  
 Estimated Water Depth:  
 Rig/Operator: ATV/J. Brandsen

Total Depth: 50.0 ft  
 Termination Criteria: Target Depth  
 Cone Size:

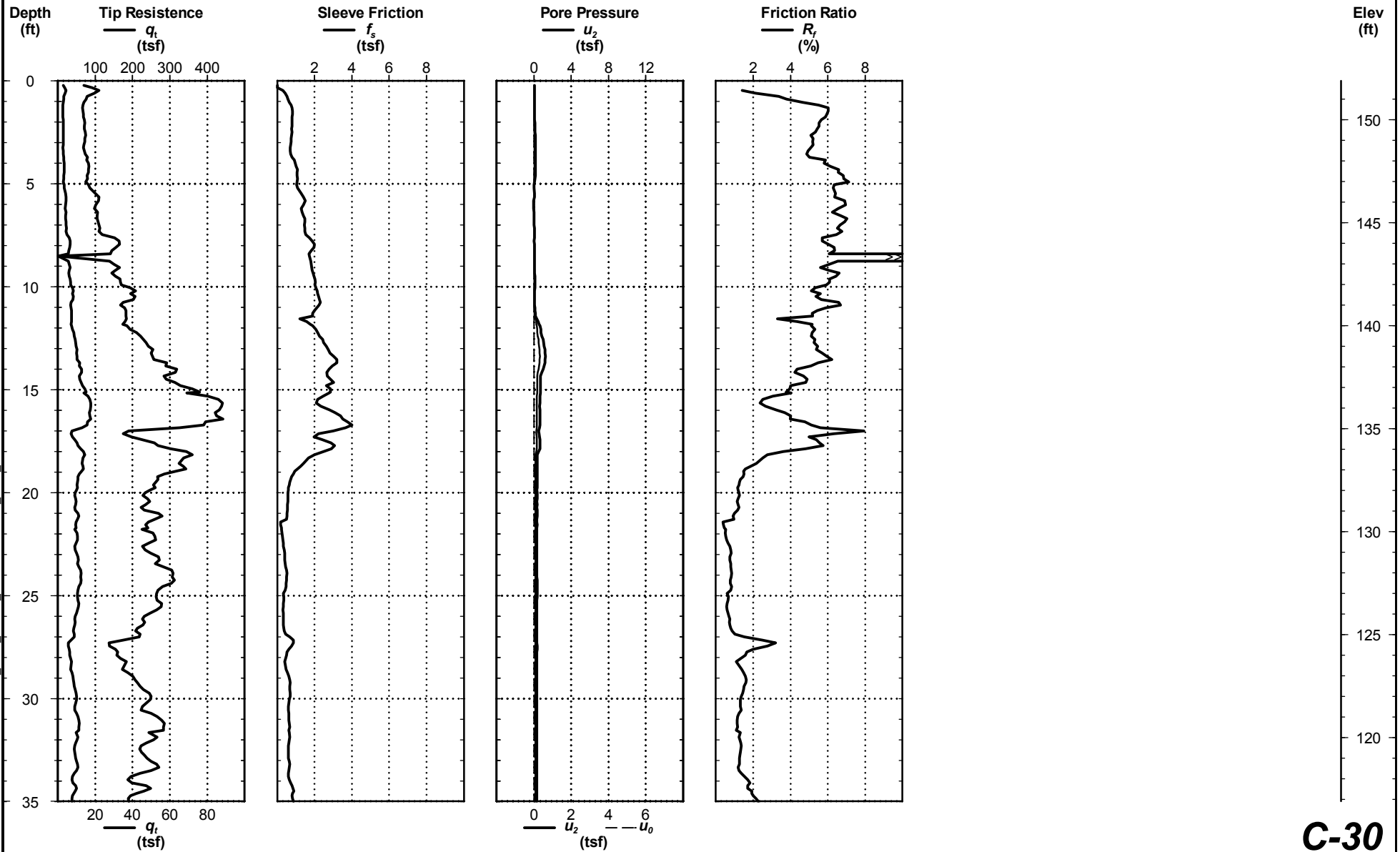

CPT REPORT - STANDARD R2582A GEO RDWY NORTHAMPTON\_CPT\_GINT.GPJ\_CPT\_V3.0.GDT 2/16/15

**C-30**



# Cone Penetration Test

**C-30**

Date: Apr. 4, 2013  
 Estimated Water Depth:  
 Rig/Operator: ATV/J. Brandsen

Total Depth: 50.0 ft  
 Termination Criteria: Target Depth  
 Cone Size:

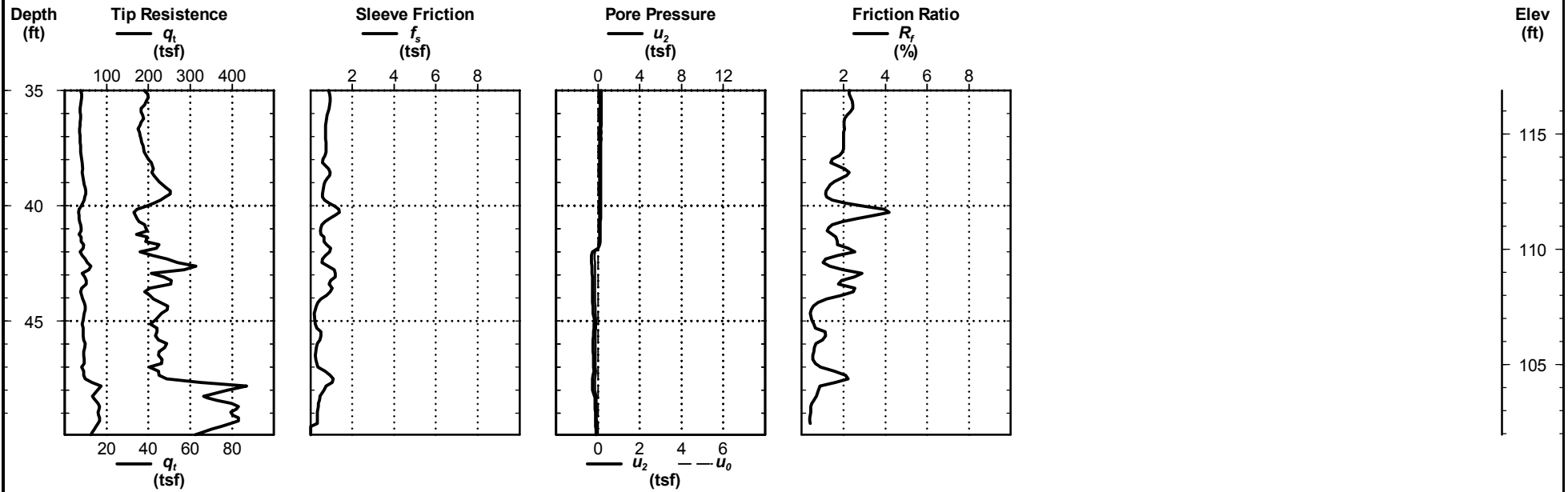

CPT REPORT - STANDARD R2582A\_GEO\_RDWY\_NORTHAMPTON\_CPT\_GINT.GPJ\_CPT\_V3.0.GDT 2/16/15

**C-30**





# Cone Penetration Test

# C-31

Date: Apr. 4, 2013  
 Estimated Water Depth:  
 Rig/Operator: ATV/J. Brandsen

Total Depth: 51.6 ft  
 Termination Criteria: Target Depth  
 Cone Size:

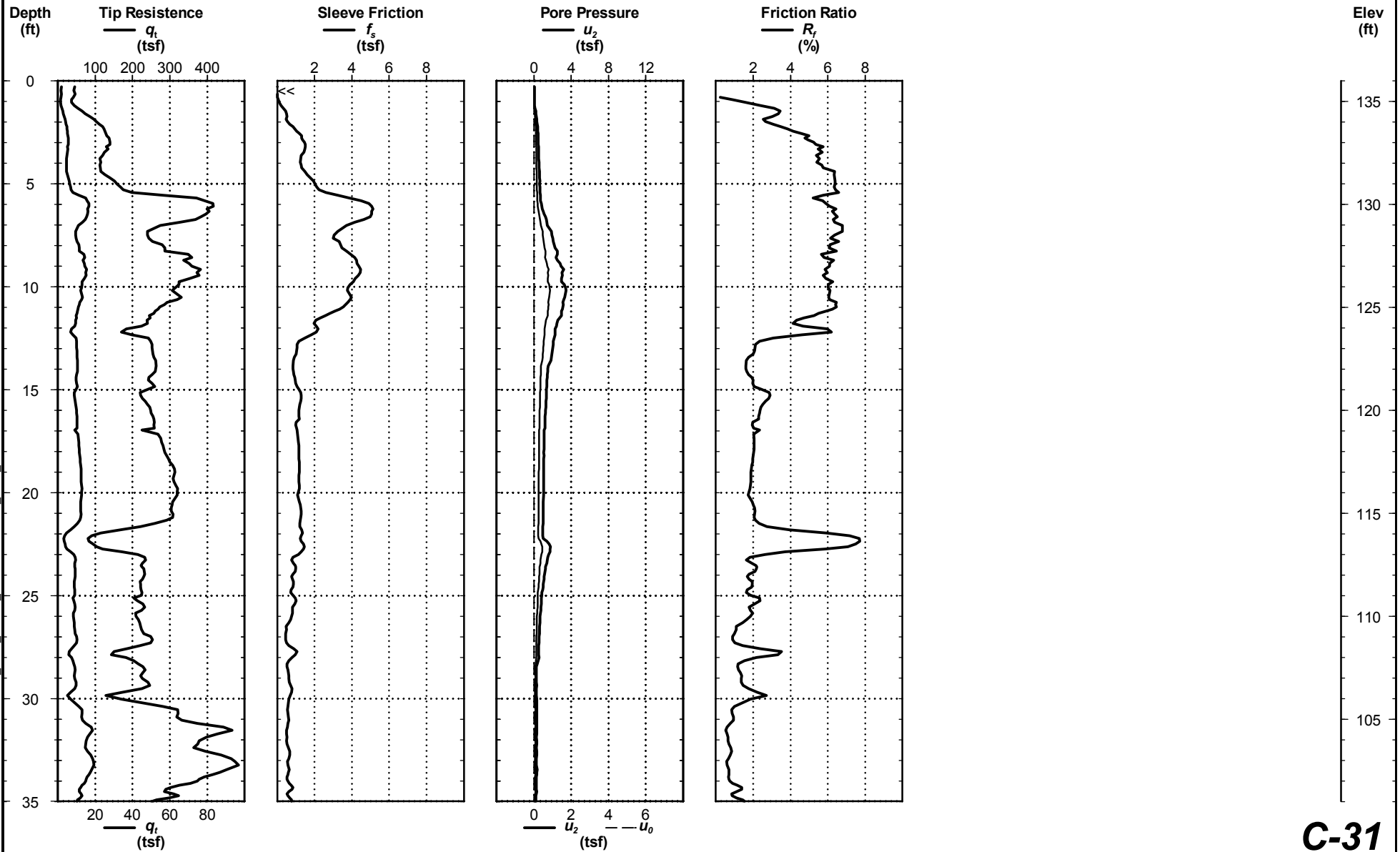

CPT REPORT - STANDARD R2582A GEO RDWY NORTHAMPTON\_CPT\_GINT.GPJ\_CPT\_V3.0.GDT 2/16/15

# C-31



# Cone Penetration Test

**C-31**

Date: Apr. 4, 2013  
 Estimated Water Depth:  
 Rig/Operator: ATV/J. Brandsen

Total Depth: 51.6 ft  
 Termination Criteria: Target Depth  
 Cone Size:

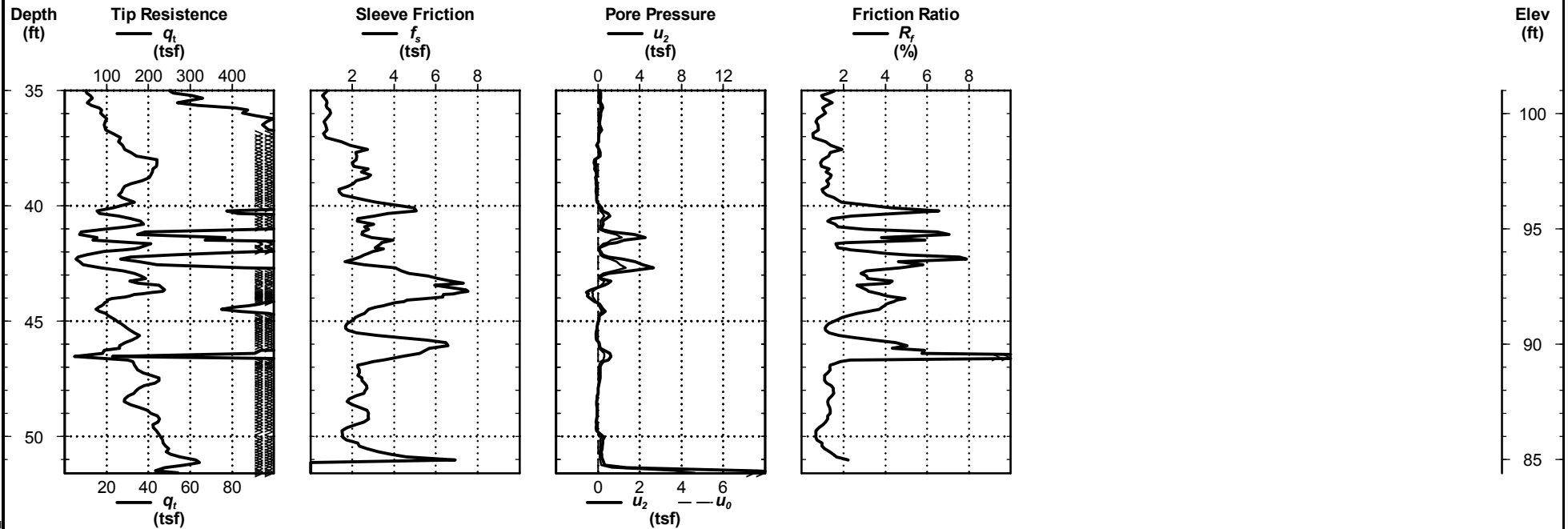

CPT REPORT - STANDARD R2582A\_GEO\_RDWY\_NORTHAMPTON\_CPT\_GINT.GPJ\_CPT V3.0.GDT 2/16/15

**C-31**



# Cone Penetration Test

**C-32**

Date: Apr. 3, 2013  
 Estimated Water Depth:  
 Rig/Operator: ATV/J. Brandsen

Total Depth: 15.0 ft  
 Termination Criteria: Target Depth  
 Cone Size:

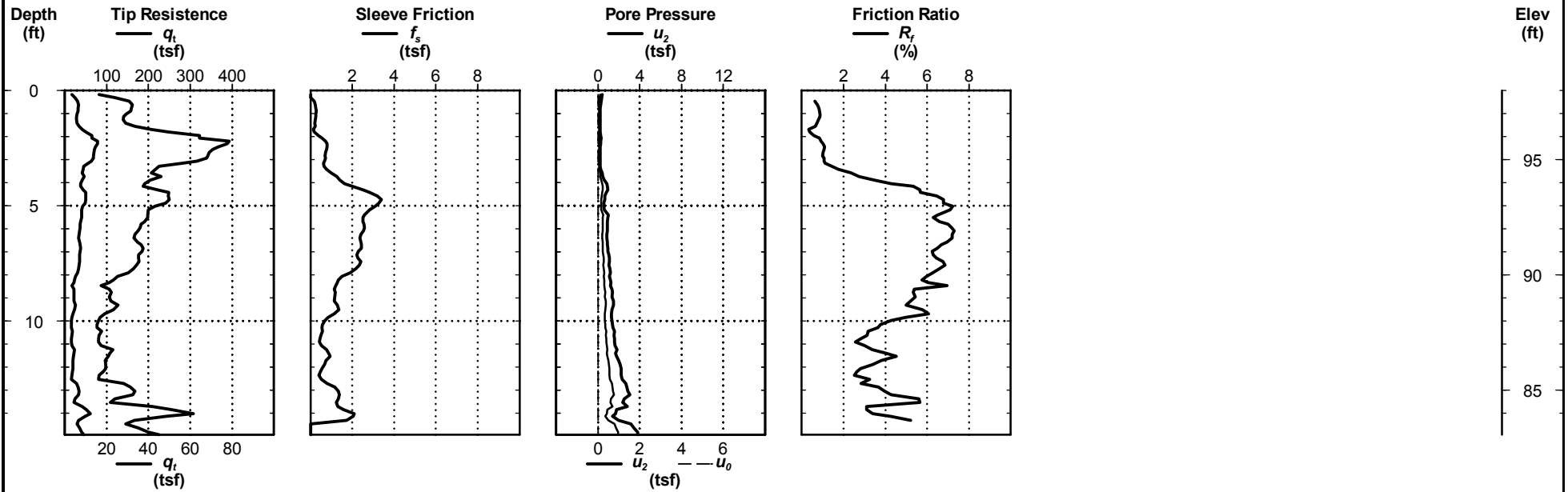

CPT REPORT - STANDARD R2582A\_GEO\_RDWY\_NORTHAMPTON\_CPT\_GINT.GPJ\_CPT\_V3.0.GDT 2/16/15

**C-32**



# Cone Penetration Test

**C-33**

Date: Apr. 3, 2013  
 Estimated Water Depth:  
 Rig/Operator: ATV/J. Brandsen

Total Depth: 9.5 ft  
 Termination Criteria: Target Depth  
 Cone Size:

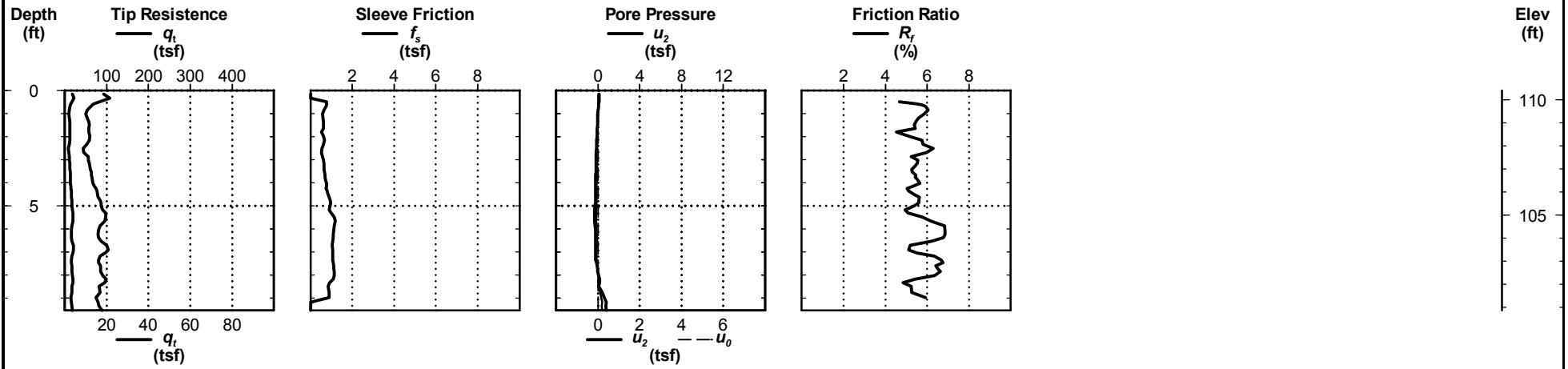

CPT REPORT - STANDARD R2582A\_GEO\_RDWY\_NORTHAMPTON\_CPT\_GINT.GPJ\_CPT\_V3.0.GDT 2/16/15

**C-33**



# Cone Penetration Test

**C-34**

Date: Apr. 3, 2013  
 Estimated Water Depth:  
 Rig/Operator: ATV/J. Brandsen

Total Depth: 20.0 ft  
 Termination Criteria: Target Depth  
 Cone Size:

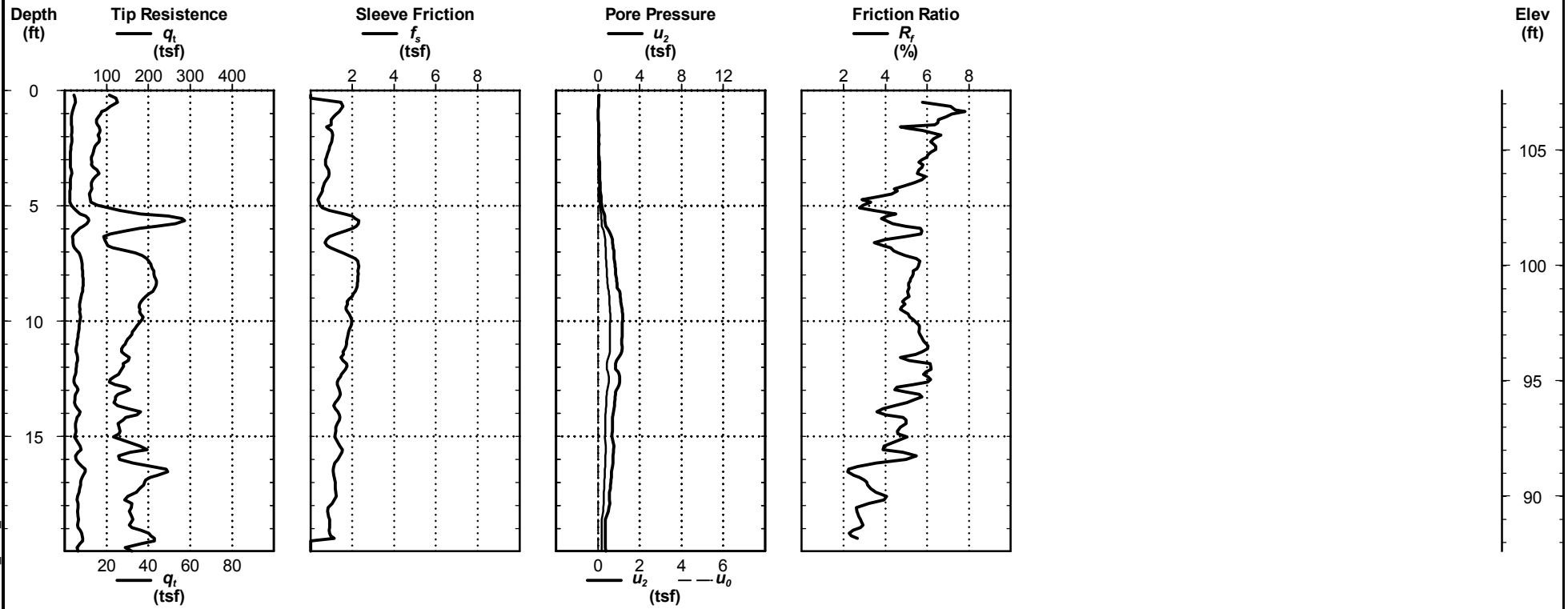

CPT REPORT - STANDARD R2582A\_GEO\_RDWY\_NORTHAMPTON\_CPT\_GINT.GPJ\_CPT V3.0.GDT 2/16/15

**C-34**



# Cone Penetration Test

**C-35**

Date: Apr. 3, 2013  
 Estimated Water Depth:  
 Rig/Operator: ATV/J. Brandsen

Total Depth: 16.0 ft  
 Termination Criteria: Target Depth  
 Cone Size:

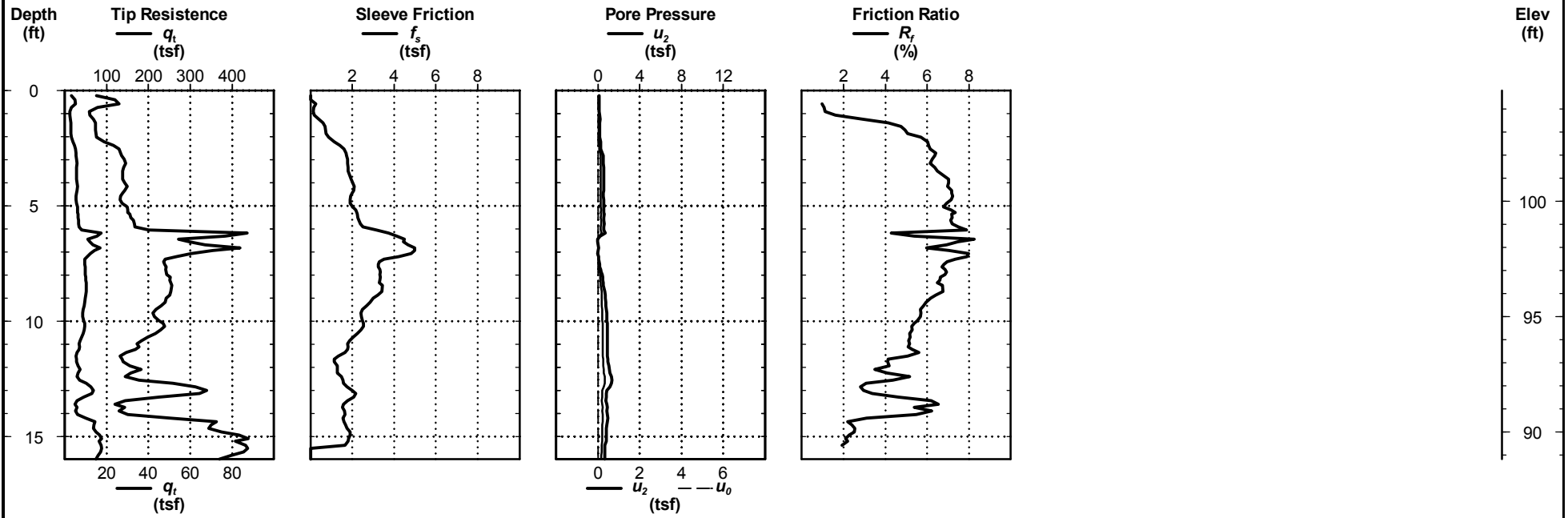

CPT REPORT - STANDARD R2582A\_GEO\_RDWY\_NORTHAMPTON\_CPT\_GINT.GPJ\_CPT V3.0.GDT 2/16/15

**C-35**



# Cone Penetration Test

**C-36**

Date: Apr. 3, 2013  
 Estimated Water Depth:  
 Rig/Operator: ATV/J. Brandsen

Total Depth: 16.0 ft  
 Termination Criteria: Target Depth  
 Cone Size:

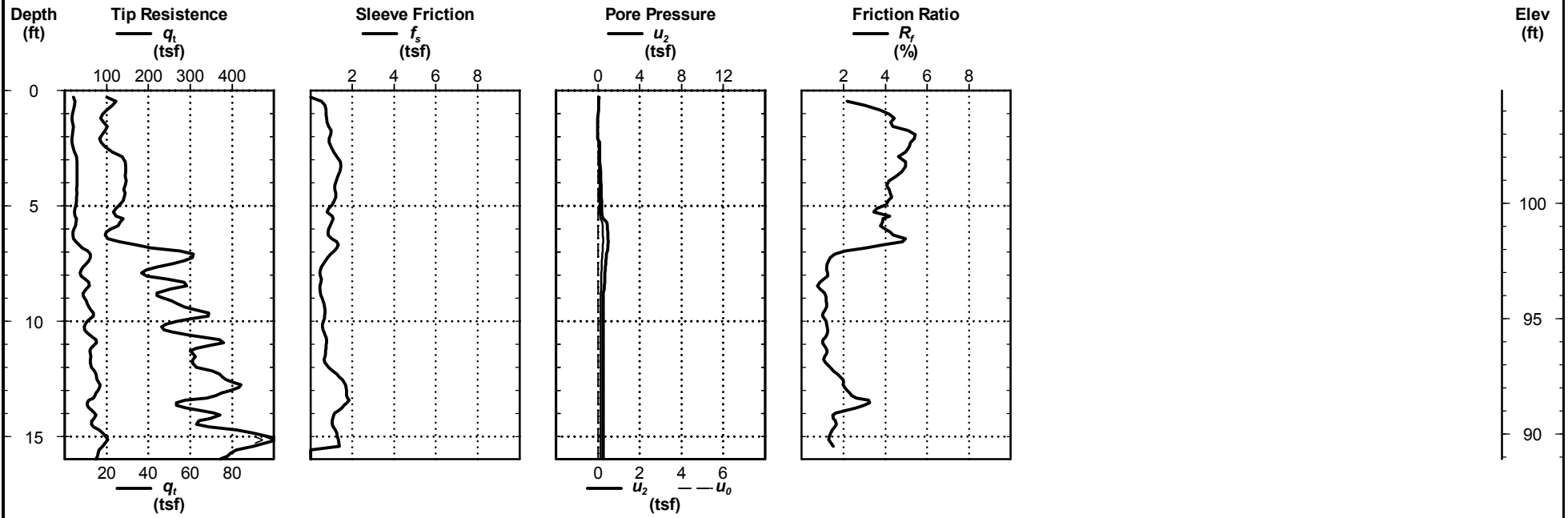

CPT REPORT - STANDARD R2582A\_GEO\_RDWY\_NORTHAMPTON\_CPT\_GINT.GPJ\_CPT V3.0.GDT 2/16/15

**C-36**



# Cone Penetration Test

**C-37**

Date: Apr. 3, 2013  
 Estimated Water Depth:  
 Rig/Operator: ATV/J. Brandsen

Total Depth: 13.0 ft  
 Termination Criteria: Target Depth  
 Cone Size:

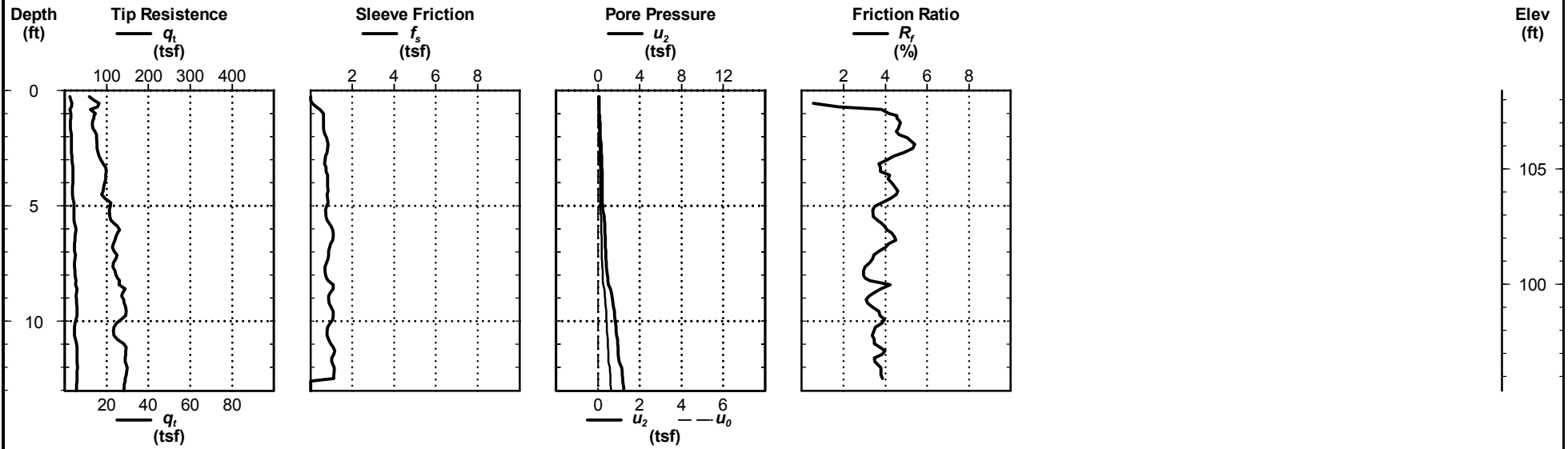

CPT REPORT - STANDARD R2582A\_GEO\_RDWY\_NORTHAMPTON\_CPT\_GINT.GPJ\_CPT\_V3.0.GDT 2/16/15

**C-37**





# Cone Penetration Test

**C-38**

Date: Apr. 3, 2013  
 Estimated Water Depth:  
 Rig/Operator: ATV/J. Brandsen

Total Depth: 10.1 ft  
 Termination Criteria: Target Depth  
 Cone Size:

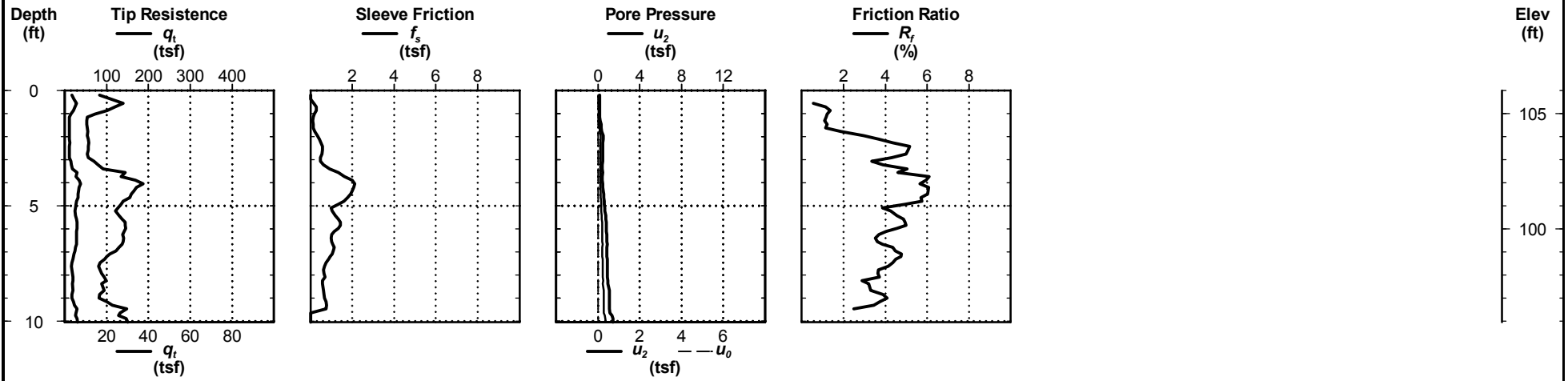

CPT REPORT - STANDARD R2582A\_GEO\_RDWY\_NORTHAMPTON\_CPT\_GINT.GPJ\_CPT\_V3.0.GDT 2/16/15

**C-38**



# Cone Penetration Test

**C-39**

Date: Apr. 3, 2013  
 Estimated Water Depth:  
 Rig/Operator: ATV/J. Brandsen

Total Depth: 11.8 ft  
 Termination Criteria: Target Depth  
 Cone Size:

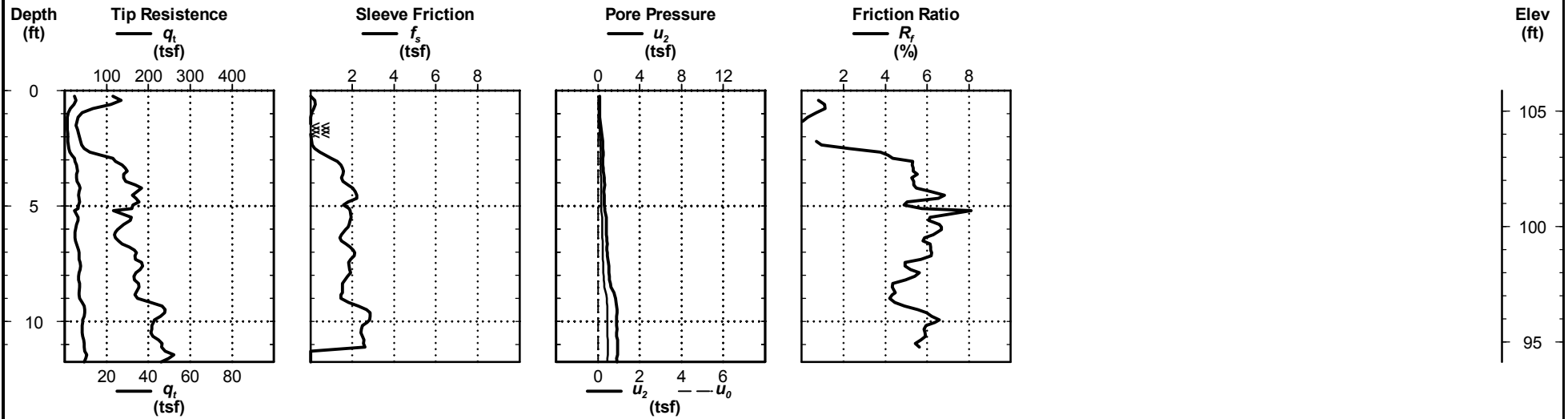

CPT REPORT - STANDARD R2582A\_GEO\_RDWY\_NORTHAMPTON\_CPT\_GINT.GPJ\_CPT\_V3.0.GDT 2/16/15

**C-39**



# Cone Penetration Test

**C-40**

Date: Apr. 3, 2013  
 Estimated Water Depth:  
 Rig/Operator: ATV/J. Brandsen

Total Depth: 9.0 ft  
 Termination Criteria: Target Depth  
 Cone Size:

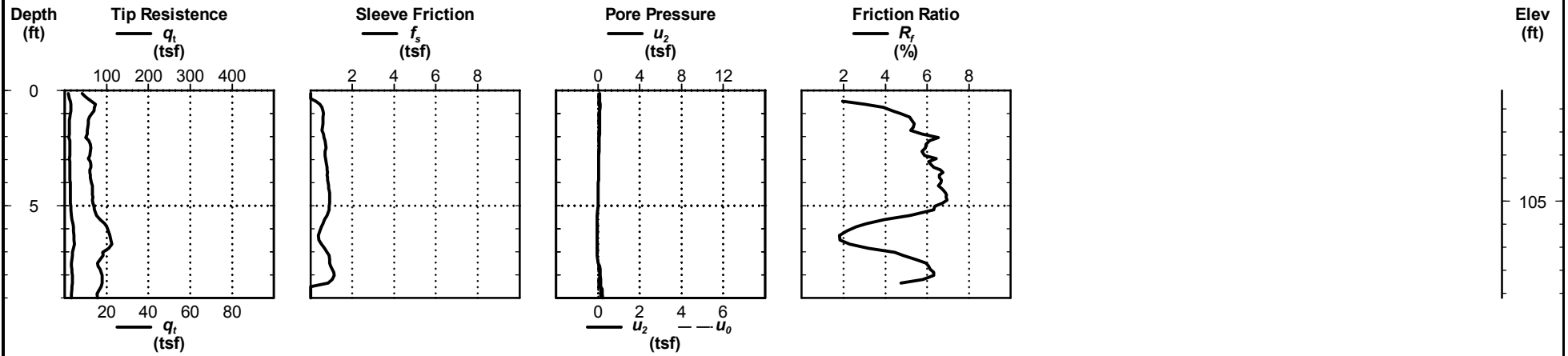

CPT REPORT - STANDARD R2582A\_GEO\_RDWY\_NORTHAMPTON\_CPT\_GINT.GPJ\_CPT\_V3.0.GDT 2/16/15

**C-40**



# Cone Penetration Test

**C-41**

Date: Apr. 3, 2013  
 Estimated Water Depth:  
 Rig/Operator: ATV/J. Brandsen

Total Depth: 8.0 ft  
 Termination Criteria: Target Depth  
 Cone Size:

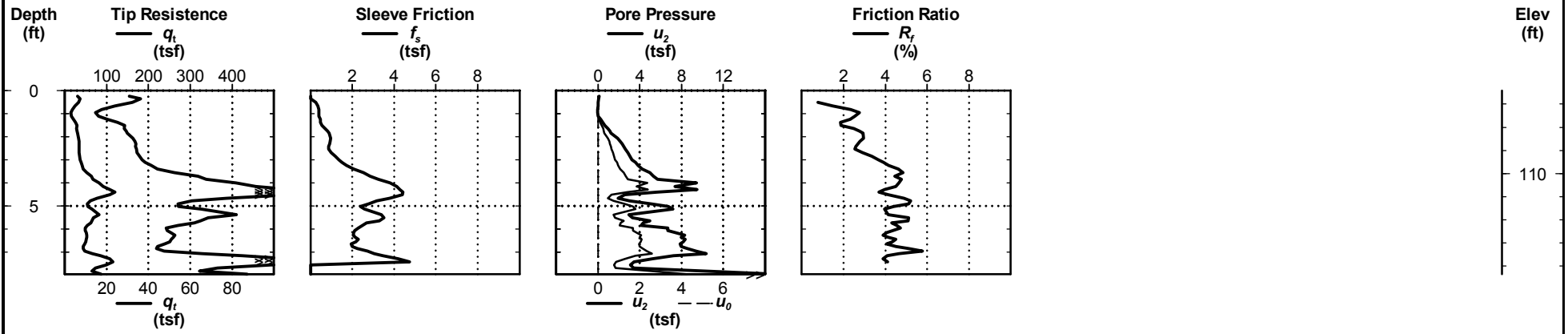

CPT REPORT - STANDARD R2582A\_GEO\_RDWY\_NORTHAMPTON\_CPT\_GINT.GPJ\_CPT\_V3.0.GDT 2/16/15

**C-41**



# Cone Penetration Test

**C-42**

Date: Apr. 3, 2013  
 Estimated Water Depth:  
 Rig/Operator: ATV/J. Brandsen

Total Depth: 11.9 ft  
 Termination Criteria: Target Depth  
 Cone Size:

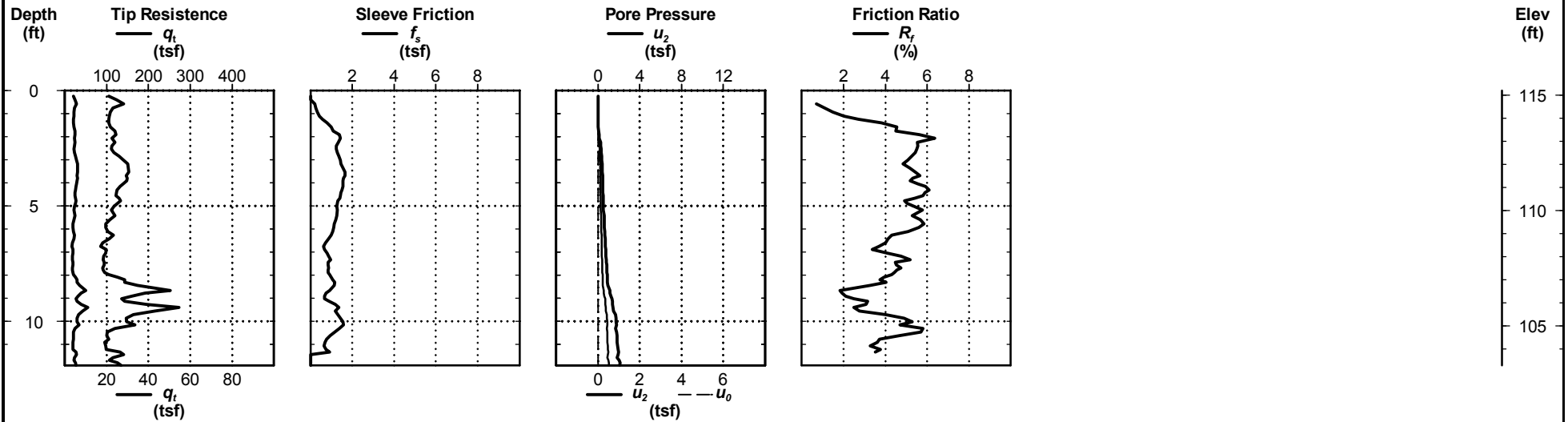

CPT REPORT - STANDARD R2582A\_GEO\_RDWY\_NORTHAMPTON\_CPT\_GINT.GPJ\_CPT\_V3.0.GDT 2/16/15

**C-42**



# Cone Penetration Test

**C-43**

Date: Apr. 3, 2013  
 Estimated Water Depth:  
 Rig/Operator: ATV/J. Brandsen

Total Depth: 14.0 ft  
 Termination Criteria: Target Depth  
 Cone Size:

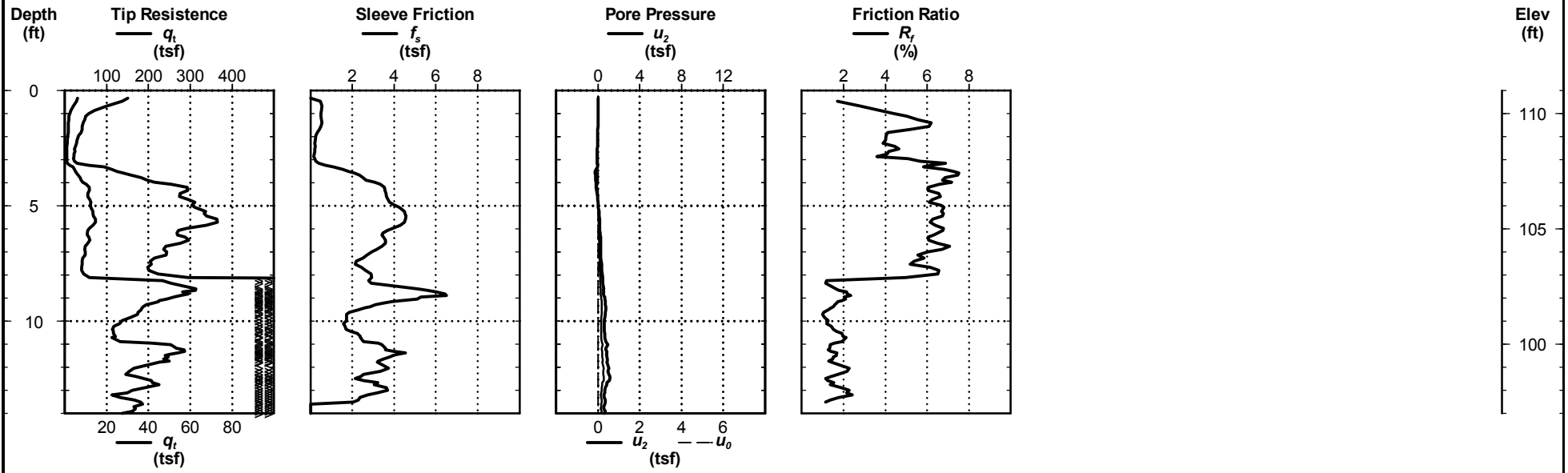

CPT REPORT - STANDARD R2582A\_GEO\_RDWY\_NORTHAMPTON\_CPT\_GINT.GPJ\_CPT\_V3.0.GDT 2/16/15

**C-43**



# Cone Penetration Test

**C-44**

Date: Apr. 3, 2013  
 Estimated Water Depth:  
 Rig/Operator: ATV/J. Brandsen

Total Depth: 18.1 ft  
 Termination Criteria: Target Depth  
 Cone Size:

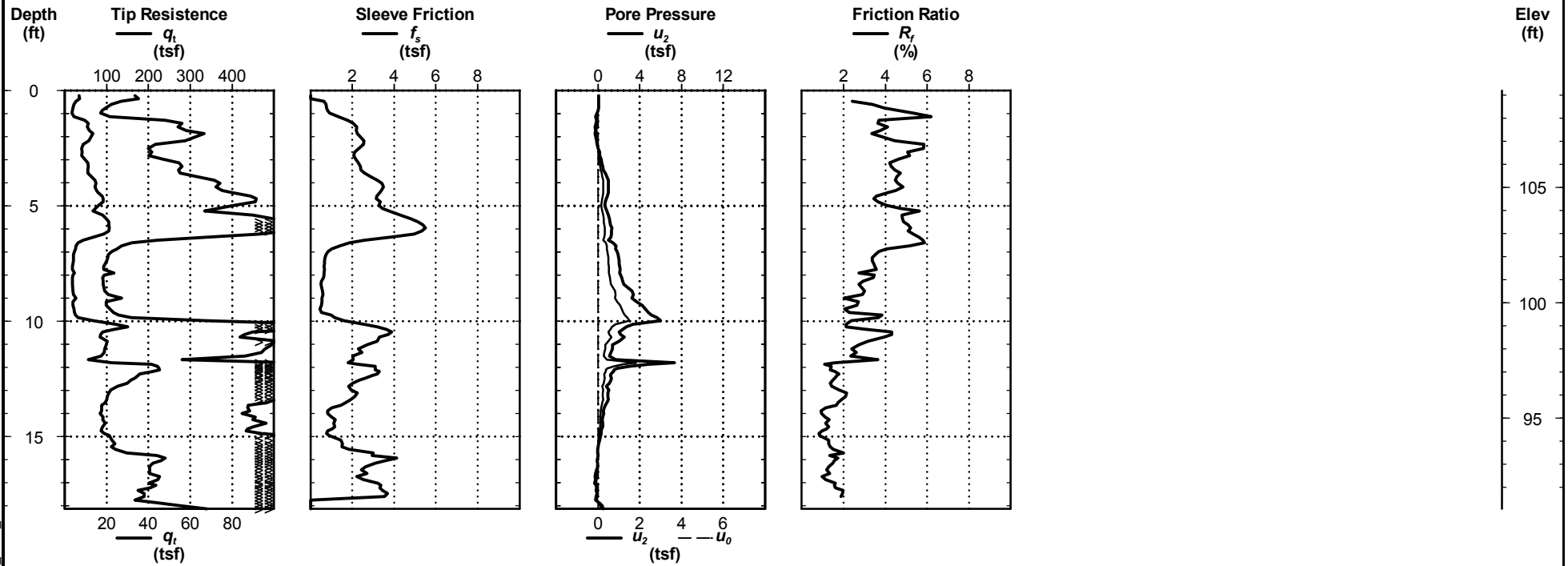

CPT REPORT - STANDARD R2582A\_GEO\_RDWY\_NORTHAMPTON\_CPT\_GINT.GPJ\_CPT V3.0.GDT 2/16/15

**C-44**



# Cone Penetration Test

**C-45**

Date: Apr. 3, 2013  
 Estimated Water Depth:  
 Rig/Operator: ATV/J. Brandsen

Total Depth: 13.0 ft  
 Termination Criteria: Target Depth  
 Cone Size:

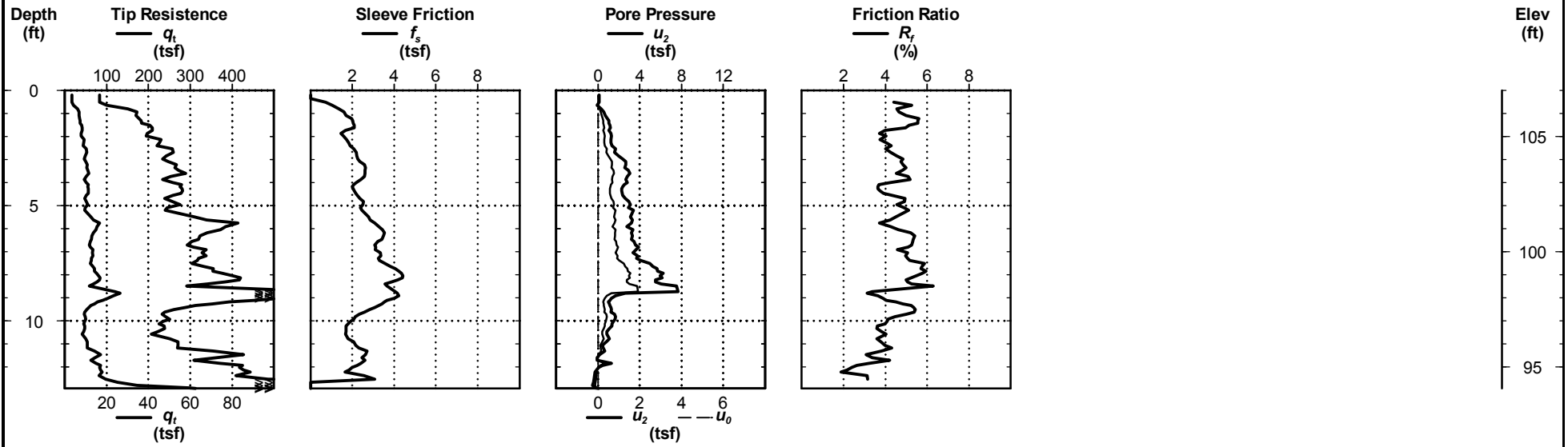

CPT REPORT - STANDARD R2582A\_GEO\_RDWY\_NORTHAMPTON\_CPT\_GINT.GPJ\_CPT\_V3.0.GDT 2/16/15

**C-45**





# Cone Penetration Test

**C-46**

Date: Apr. 3, 2013  
 Estimated Water Depth:  
 Rig/Operator: ATV/J. Brandsen

Total Depth: 12.1 ft  
 Termination Criteria: Target Depth  
 Cone Size:

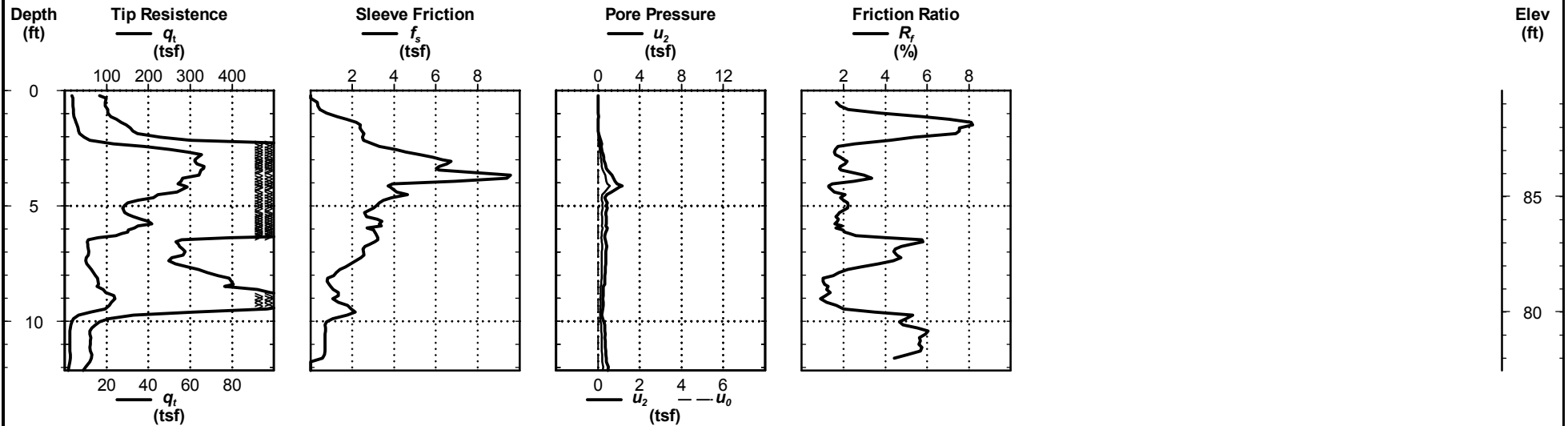

CPT REPORT - STANDARD R2582A\_GEO\_RDWY\_NORTHAMPTON\_CPT\_GINT.GPJ\_CPT\_V3.0.GDT 2/16/15

**C-46**



# Cone Penetration Test

**C-47**

Date: Apr. 3, 2013  
 Estimated Water Depth:  
 Rig/Operator: ATV/J. Brandsen

Total Depth: 14.9 ft  
 Termination Criteria: Target Depth  
 Cone Size:

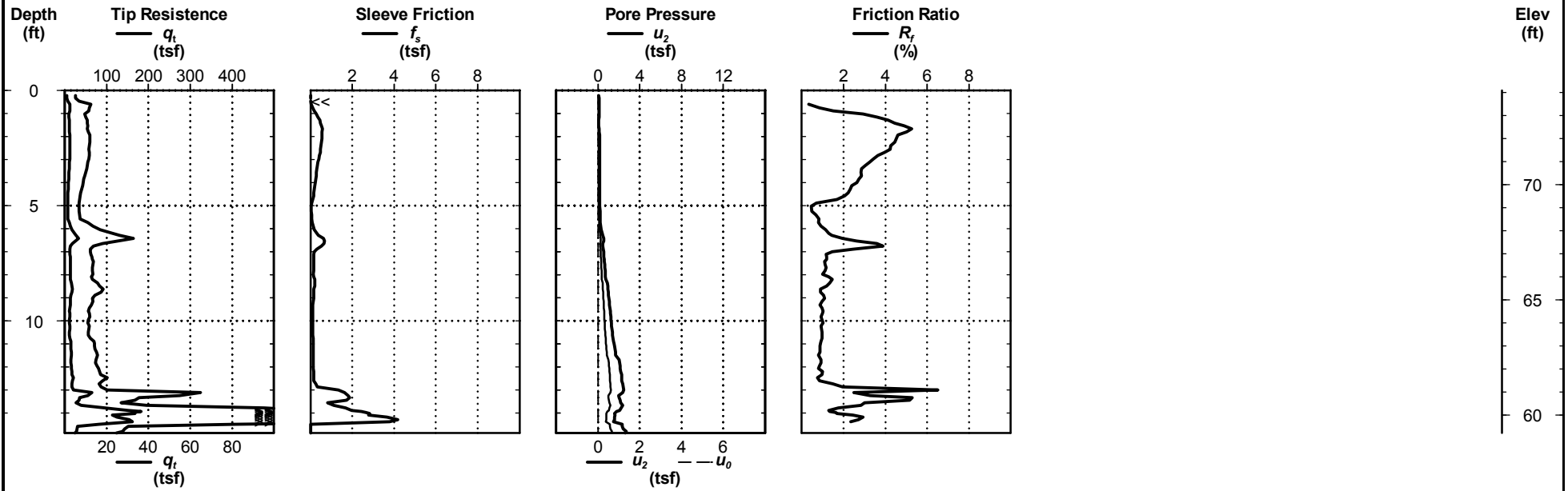

CPT REPORT - STANDARD R2582A\_GEO\_RDWY\_NORTHAMPTON\_CPT\_GINT.GPJ\_CPT\_V3.0.GDT 2/16/15

**C-47**



# Cone Penetration Test

**C-48**

Date: Apr. 3, 2013  
 Estimated Water Depth:  
 Rig/Operator: ATV/J. Brandsen

Total Depth: 9.4 ft  
 Termination Criteria: Target Depth  
 Cone Size:

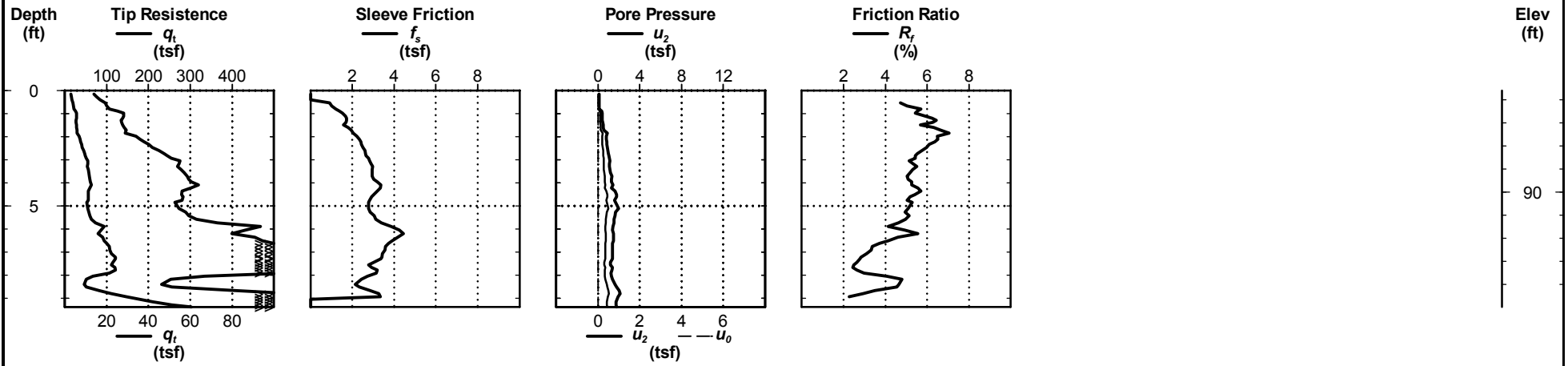

CPT REPORT - STANDARD R2582A\_GEO\_RDWY\_NORTHAMPTON\_CPT\_GINT.GPJ\_CPT V3.0.GDT 2/16/15

**C-48**



# Cone Penetration Test

**C-49**

Date: Apr. 3, 2013  
 Estimated Water Depth:  
 Rig/Operator: ATV/J. Brandsen

Total Depth: 8.1 ft  
 Termination Criteria: Target Depth  
 Cone Size:

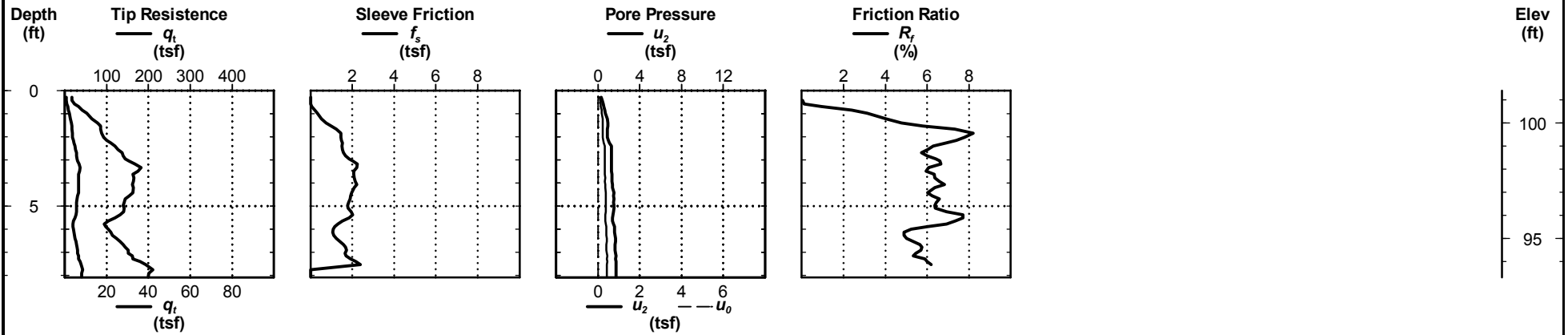

CPT REPORT - STANDARD R2582A\_GEO\_RDWY\_NORTHAMPTON\_CPT\_GINT.GPJ\_CPT\_V3.0.GDT 2/16/15

**C-49**



# Cone Penetration Test

**C-50**

Date: Apr. 4, 2013  
 Estimated Water Depth:  
 Rig/Operator: ATV/J. Brandsen

Total Depth: 8.0 ft  
 Termination Criteria: Target Depth  
 Cone Size:

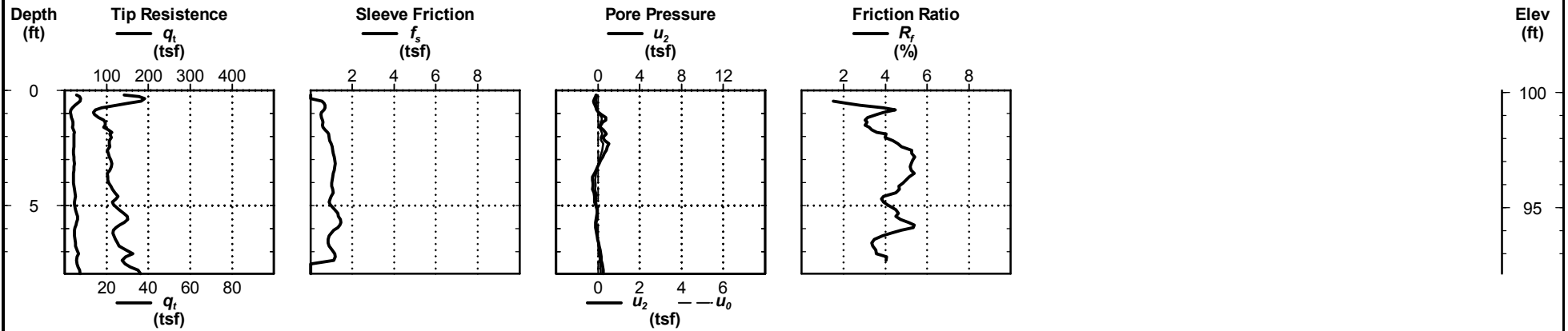

CPT REPORT - STANDARD R2582A\_GEO\_RDWY\_NORTHAMPTON\_CPT\_GINT.GPJ\_CPT\_V3.0.GDT 2/16/15

**C-50**



# Cone Penetration Test

**C-51**

Date: Apr. 4, 2013  
 Estimated Water Depth:  
 Rig/Operator: ATV/J. Brandsen

Total Depth: 8.1 ft  
 Termination Criteria: Target Depth  
 Cone Size:

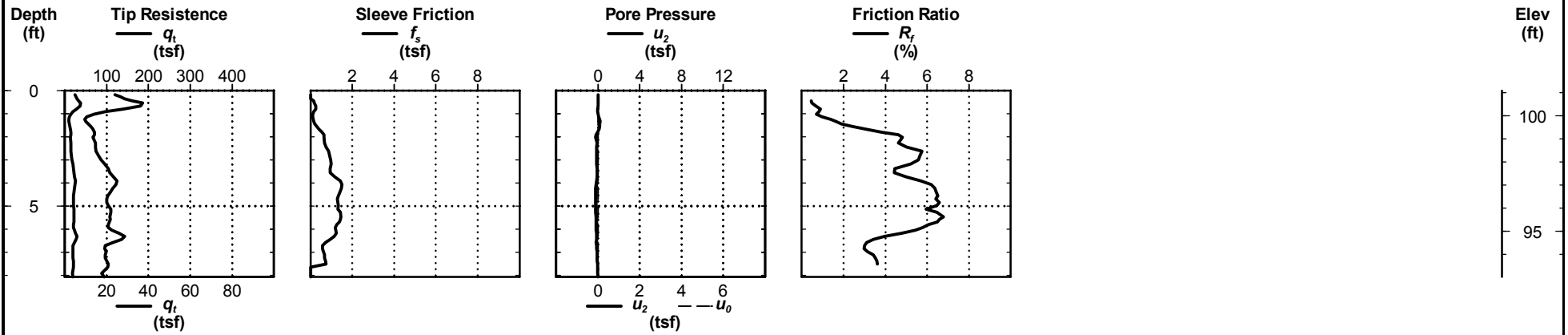

CPT REPORT - STANDARD R2582A\_GEO\_RDWY\_NORTHAMPTON\_CPT\_GINT.GPJ\_CPT\_V3.0.GDT 2/16/15

**C-51**



# Cone Penetration Test

**C-52**

Date: Apr. 4, 2013  
 Estimated Water Depth:  
 Rig/Operator: ATV/J. Brandsen

Total Depth: 8.0 ft  
 Termination Criteria: Target Depth  
 Cone Size:

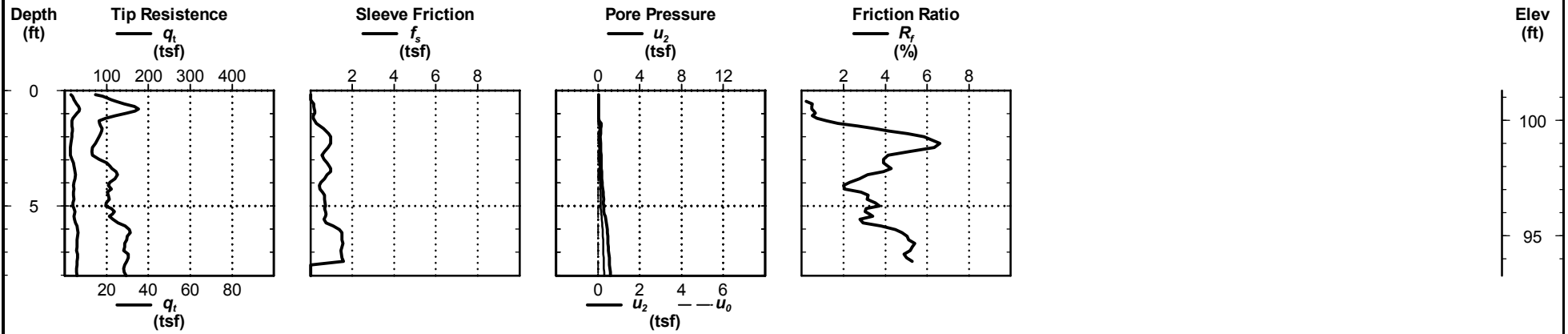

CPT REPORT - STANDARD R2582A\_GEO\_RDWY\_NORTHAMPTON\_CPT\_GINT.GPJ\_CPT V3.0.GDT 2/16/15

**C-52**



# Cone Penetration Test

**C-53**

Date: Apr. 4, 2013  
 Estimated Water Depth:  
 Rig/Operator: ATV/J. Brandsen

Total Depth: 8.0 ft  
 Termination Criteria: Target Depth  
 Cone Size:

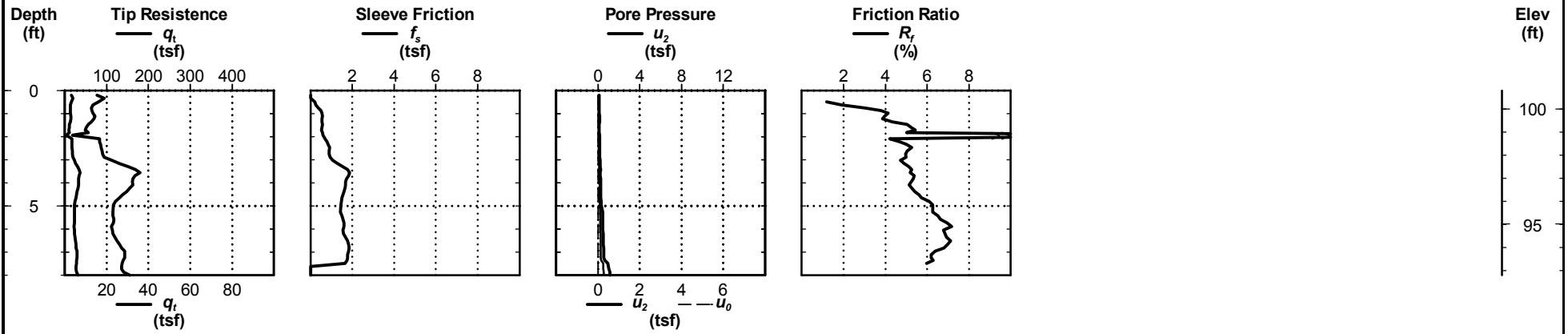

CPT REPORT - STANDARD R2582A\_GEO\_RDWY\_NORTHAMPTON\_CPT\_GINT.GPJ\_CPT V3.0.GDT 2/16/15

**C-53**





# Cone Penetration Test

**C-54**

Date: Apr. 4, 2013  
 Estimated Water Depth:  
 Rig/Operator: ATV/J. Brandsen

Total Depth: 8.0 ft  
 Termination Criteria: Target Depth  
 Cone Size:

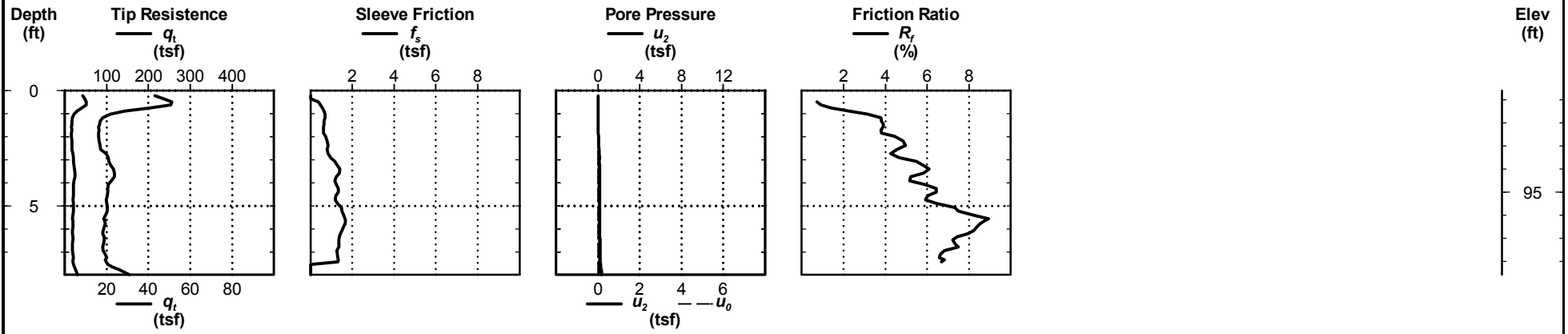

CPT REPORT - STANDARD R2582A\_GEO\_RDWY\_NORTHAMPTON\_CPT\_GINT.GPJ\_CPT V3.0.GDT 2/16/15

**C-54**



# Cone Penetration Test

**C-55**

Date: Apr. 4, 2013  
 Estimated Water Depth:  
 Rig/Operator: ATV/J. Brandsen

Total Depth: 8.0 ft  
 Termination Criteria: Target Depth  
 Cone Size:

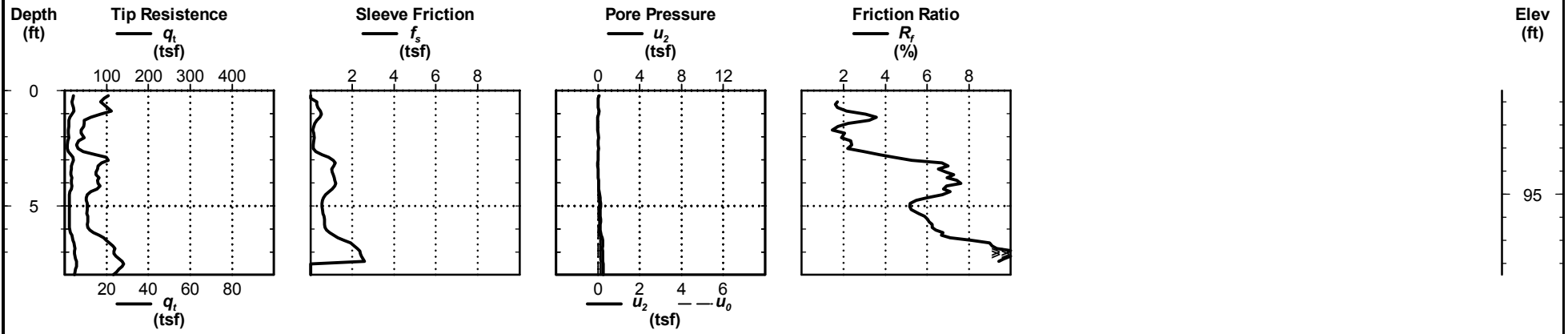

CPT REPORT - STANDARD R2582A\_GEO\_RDWY\_NORTHAMPTON\_CPT\_GINT.GPJ\_CPT\_V3.0.GDT 2/16/15

**C-55**



# Cone Penetration Test

**C-56**

Date: Apr. 4, 2013  
 Estimated Water Depth:  
 Rig/Operator: ATV/J. Brandsen

Total Depth: 7.9 ft  
 Termination Criteria: Target Depth  
 Cone Size:

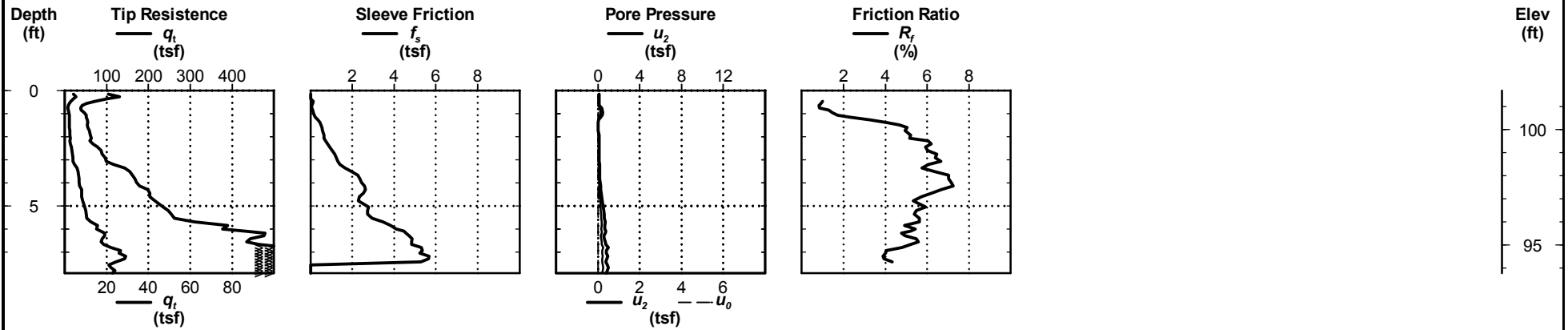

CPT REPORT - STANDARD R2582A\_GEO\_RDWY\_NORTHAMPTON\_CPT\_GINT.GPJ\_CPT\_V3.0.GDT 2/16/15

**C-56**



# Cone Penetration Test

**C-57**

Date: Apr. 4, 2013  
 Estimated Water Depth:  
 Rig/Operator: ATV/J. Brandsen

Total Depth: 8.1 ft  
 Termination Criteria: Target Depth  
 Cone Size:

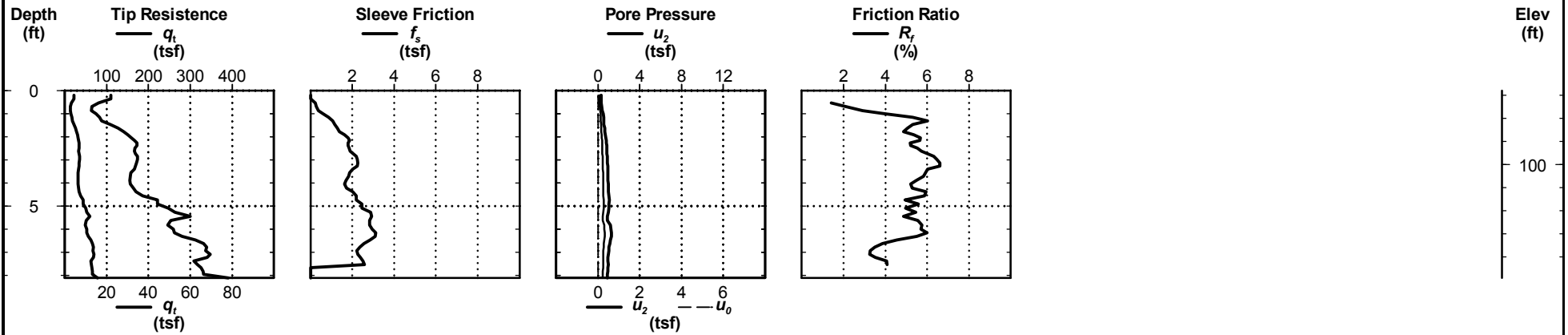

CPT REPORT - STANDARD R2582A\_GEO\_RDWY\_NORTHAMPTON\_CPT\_GINT.GPJ\_CPT\_V3.0.GDT 2/16/15

**C-57**



# Cone Penetration Test

**C-58**

Date: Apr. 4, 2013  
 Estimated Water Depth:  
 Rig/Operator: ATV/J. Brandsen

Total Depth: 8.0 ft  
 Termination Criteria: Target Depth  
 Cone Size:

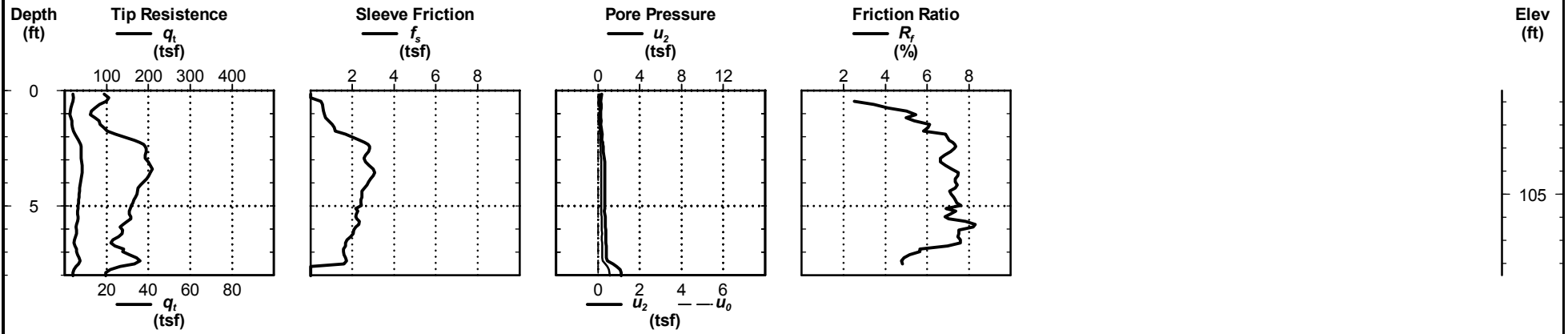

CPT REPORT - STANDARD R2582A\_GEO\_RDWY\_NORTHAMPTON\_CPT\_GINT.GPJ\_CPT V3.0.GDT 2/16/15

**C-58**



# Cone Penetration Test

**C-59**

Date: Apr. 4, 2013  
 Estimated Water Depth:  
 Rig/Operator: ATV/J. Brandsen

Total Depth: 8.0 ft  
 Termination Criteria: Target Depth  
 Cone Size:

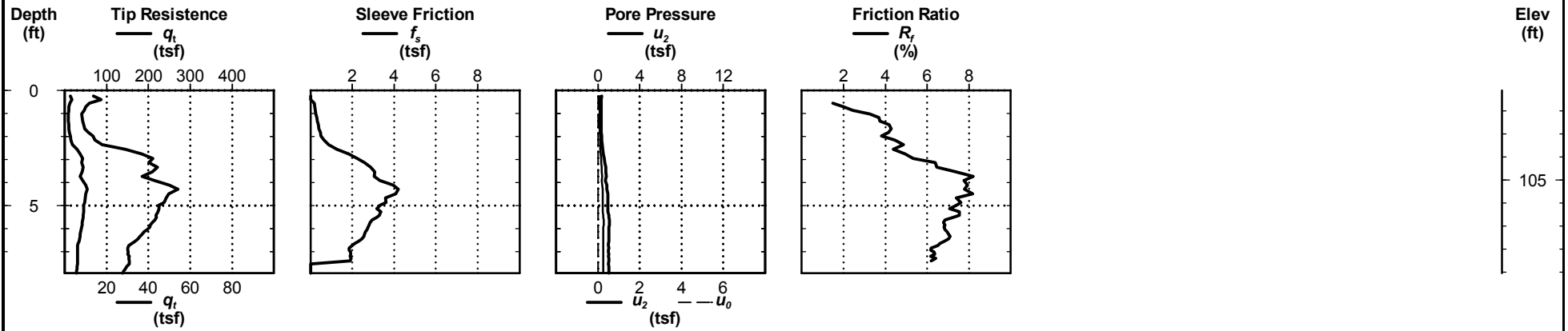

CPT REPORT - STANDARD R2582A\_GEO\_RDWY\_NORTHAMPTON\_CPT\_GINT.GPJ\_CPT V3.0.GDT 2/16/15

**C-59**



# Cone Penetration Test

**C-60**

Date: Apr. 4, 2013  
 Estimated Water Depth:  
 Rig/Operator: ATV/J. Brandsen

Total Depth: 8.5 ft  
 Termination Criteria: Target Depth  
 Cone Size:

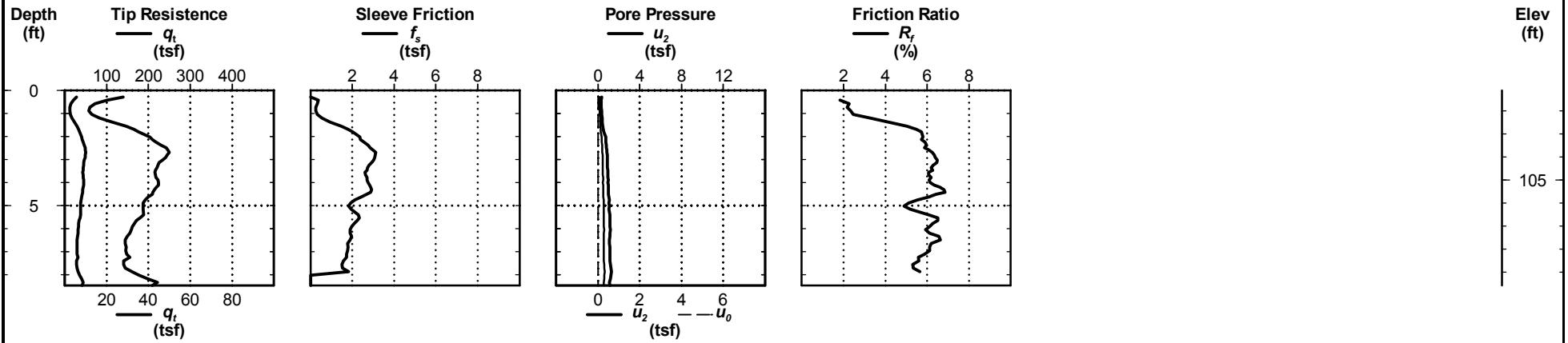

CPT REPORT - STANDARD R2582A\_GEO\_RDWY\_NORTHAMPTON\_CPT\_GINT.GPJ\_CPT\_V3.0.GDT 2/16/15

**C-60**



# Cone Penetration Test

**C-61**

Date: Apr. 4, 2013  
 Estimated Water Depth:  
 Rig/Operator: ATV/J. Brandsen

Total Depth: 8.0 ft  
 Termination Criteria: Target Depth  
 Cone Size:

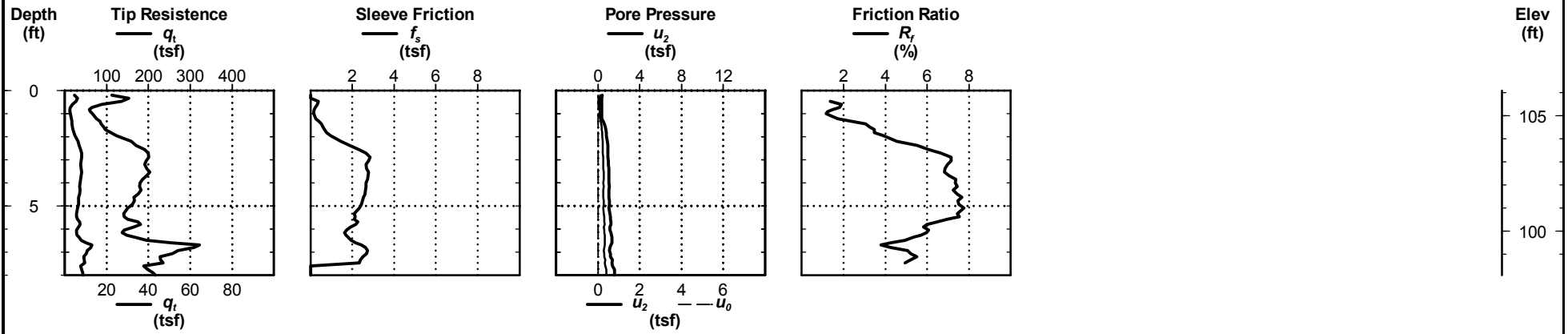

CPT REPORT - STANDARD R2582A\_GEO\_RDWY\_NORTHAMPTON\_CPT\_GINT.GPJ\_CPT V3.0.GDT 2/16/15

**C-61**





# Cone Penetration Test

**C-62**

Date: Apr. 4, 2013  
 Estimated Water Depth:  
 Rig/Operator: ATV/J. Brandsen

Total Depth: 8.0 ft  
 Termination Criteria: Target Depth  
 Cone Size:

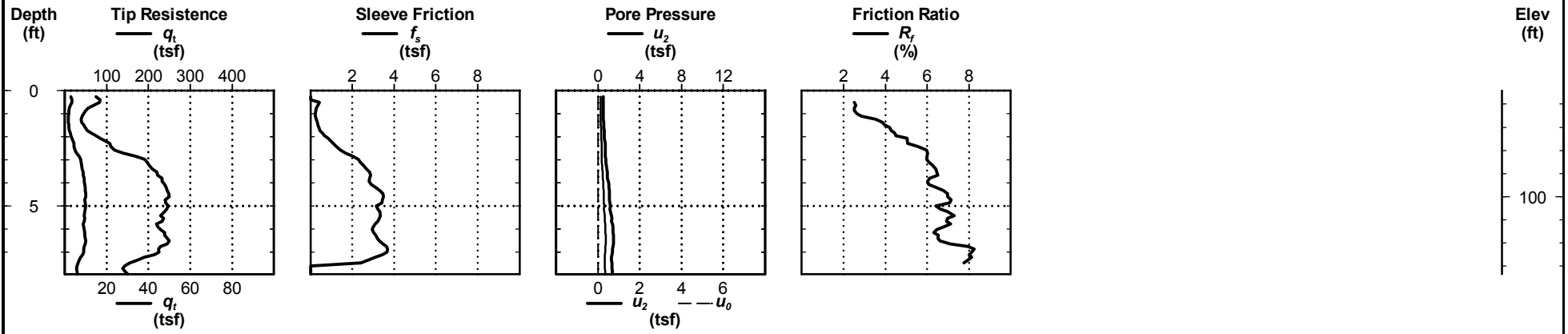

CPT REPORT - STANDARD R2582A\_GEO\_RDWY\_NORTHAMPTON\_CPT\_GINT.GPJ\_CPT\_V3.0.GDT 2/16/15

**C-62**



# Cone Penetration Test

**C-63**

Date: Apr. 4, 2013  
 Estimated Water Depth:  
 Rig/Operator: ATV/J. Brandsen

Total Depth: 8.0 ft  
 Termination Criteria: Target Depth  
 Cone Size:

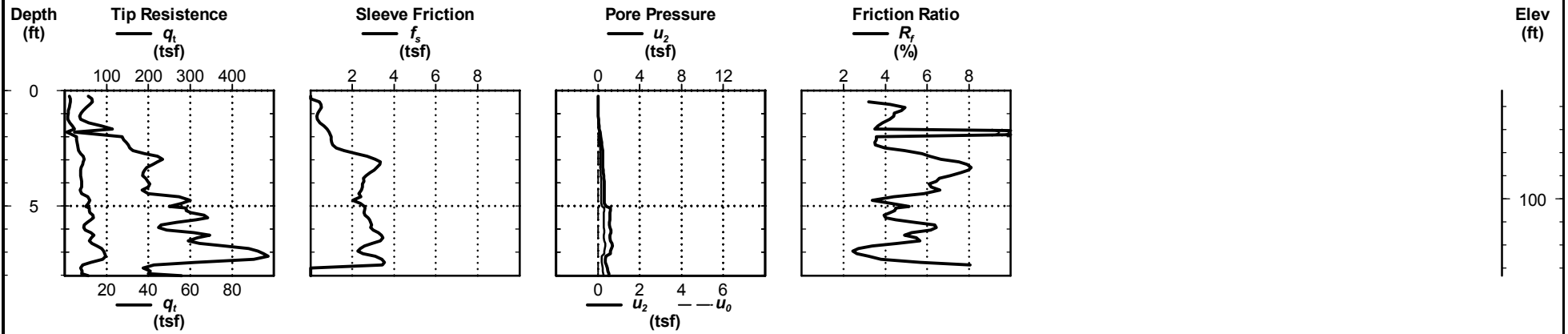

CPT REPORT - STANDARD R2582A\_GEO\_RDWY\_NORTHAMPTON\_CPT\_GINT.GPJ\_CPT\_V3.0.GDT 2/16/15

**C-63**



# Cone Penetration Test

**C-64**

Date: Apr. 4, 2013  
 Estimated Water Depth:  
 Rig/Operator: ATV/J. Brandsen

Total Depth: 7.9 ft  
 Termination Criteria: Target Depth  
 Cone Size:

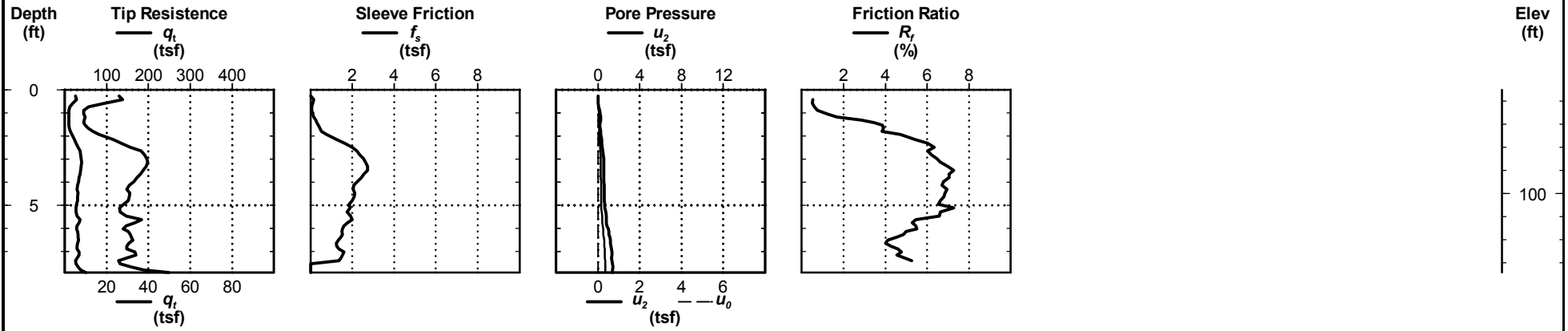

CPT REPORT - STANDARD R2582A\_GEO\_RDWY\_NORTHAMPTON\_CPT\_GINT.GPJ\_CPT\_V3.0.GDT 2/16/15

**C-64**



# Cone Penetration Test

**C-65**

Date: Apr. 4, 2013  
 Estimated Water Depth:  
 Rig/Operator: ATV/J. Brandsen

Total Depth: 8.1 ft  
 Termination Criteria: Target Depth  
 Cone Size:

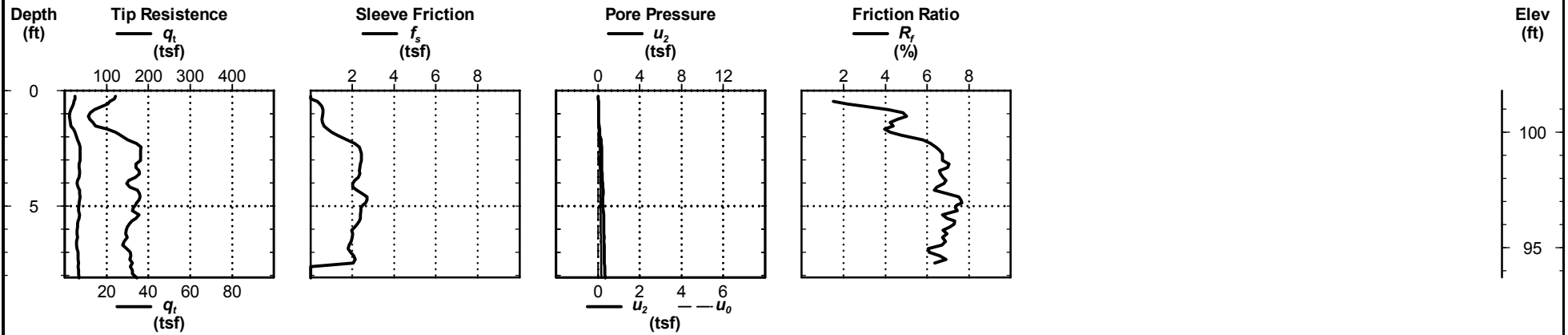

CPT REPORT - STANDARD R2582A\_GEO\_RDWY\_NORTHAMPTON\_CPT\_GINT.GPJ\_CPT\_V3.0.GDT 2/16/15

**C-65**



# Cone Penetration Test

**C-66**

Date: Apr. 4, 2013  
 Estimated Water Depth:  
 Rig/Operator: ATV/J. Brandsen

Total Depth: 8.0 ft  
 Termination Criteria: Target Depth  
 Cone Size:

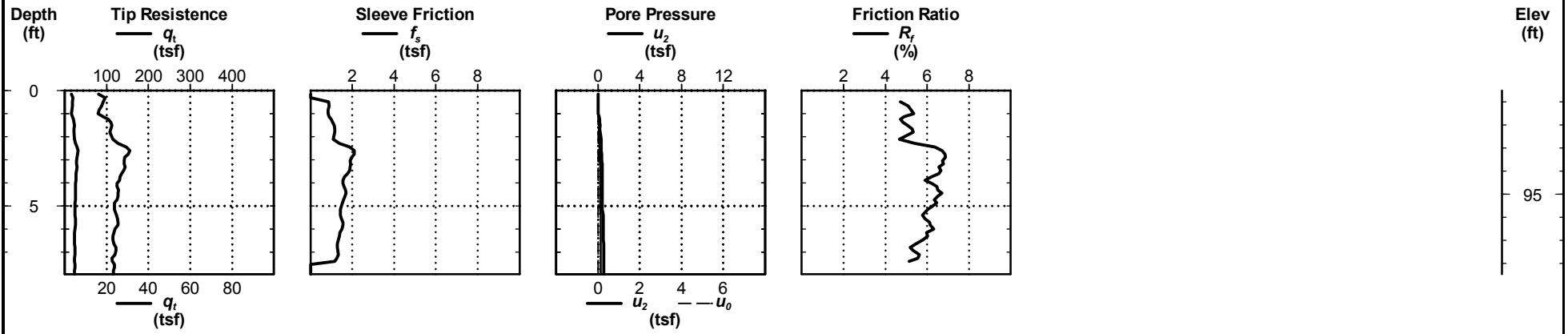

CPT REPORT - STANDARD R2582A\_GEO\_RDWY\_NORTHAMPTON\_CPT\_GINT.GPJ\_CPT V3.0.GDT 2/16/15

**C-66**



# Cone Penetration Test

**C-67**

Date: Apr. 4, 2013  
 Estimated Water Depth:  
 Rig/Operator: ATV/J. Brandsen

Total Depth: 8.0 ft  
 Termination Criteria: Target Depth  
 Cone Size:

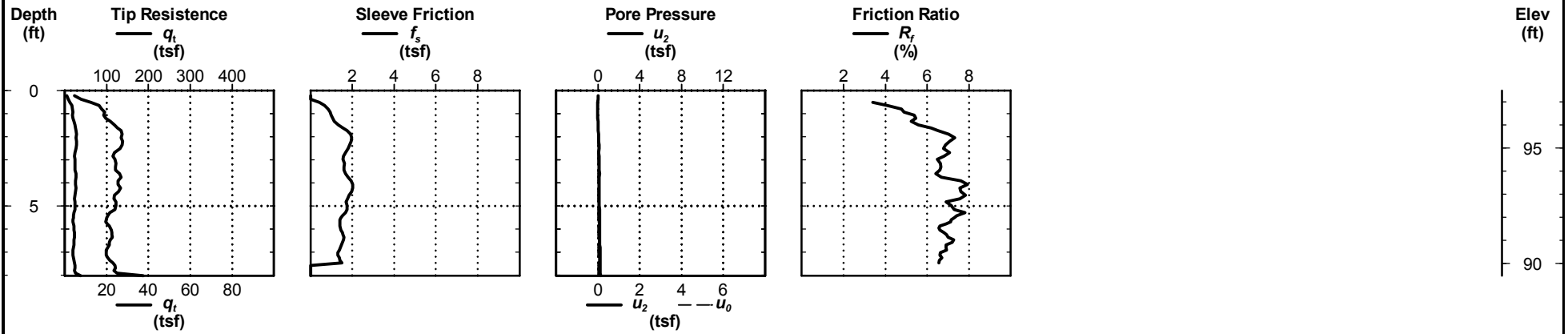

CPT REPORT - STANDARD R2582A\_GEO\_RDWY\_NORTHAMPTON\_CPT\_GINT.GPJ\_CPT\_V3.0.GDT 2/16/15

**C-67**



# Cone Penetration Test

**C-68**

Date: Apr. 4, 2013  
 Estimated Water Depth:  
 Rig/Operator: ATV/J. Brandsen

Total Depth: 8.0 ft  
 Termination Criteria: Target Depth  
 Cone Size:

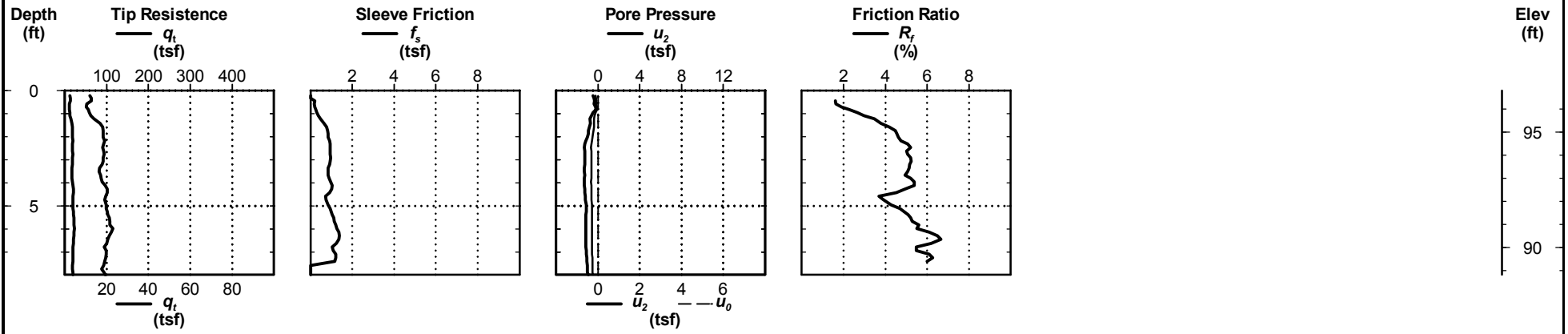

CPT REPORT - STANDARD R2582A\_GEO\_RDWY\_NORTHAMPTON\_CPT\_GINT.GPJ\_CPT V3.0.GDT 2/16/15

**C-68**



# Cone Penetration Test

**C-69**

Date: Apr. 4, 2013  
 Estimated Water Depth:  
 Rig/Operator: ATV/J. Brandsen

Total Depth: 8.0 ft  
 Termination Criteria: Target Depth  
 Cone Size:

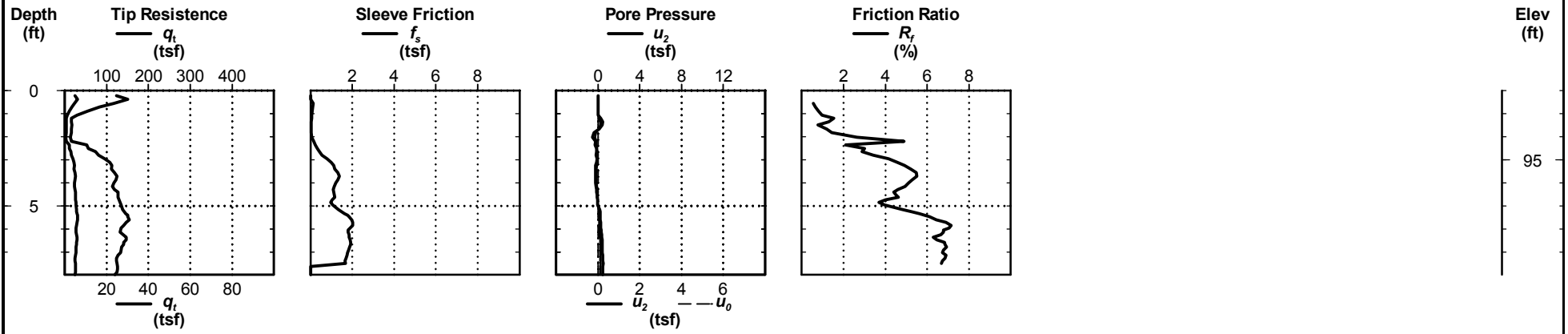

CPT REPORT - STANDARD R2582A\_GEO\_RDWY\_NORTHAMPTON\_CPT\_GINT.GPJ\_CPT V3.0.GDT 2/16/15

**C-69**





# Cone Penetration Test

**C-70**

Date: Apr. 4, 2013  
 Estimated Water Depth:  
 Rig/Operator: ATV/J. Brandsen

Total Depth: 8.1 ft  
 Termination Criteria: Target Depth  
 Cone Size:

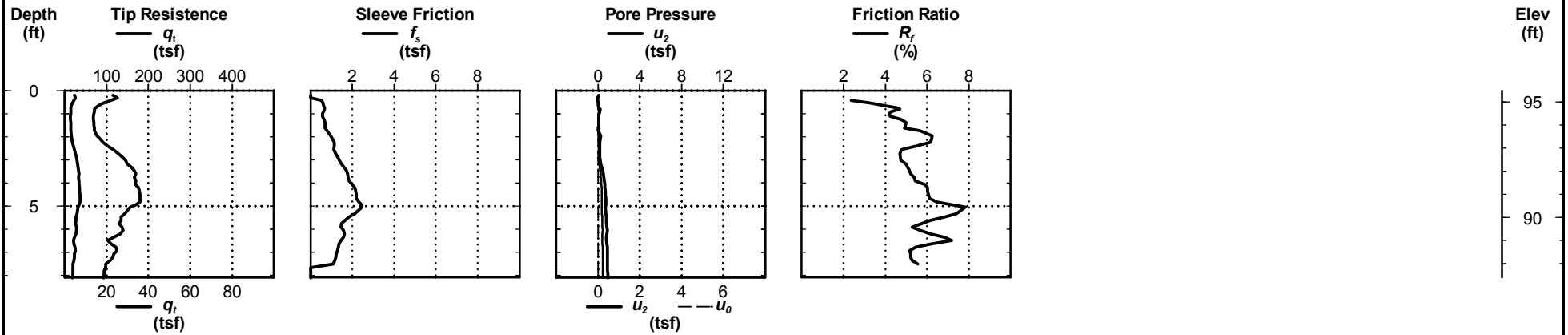

CPT REPORT - STANDARD R2582A\_GEO\_RDWY\_NORTHAMPTON\_CPT\_GINT.GPJ\_CPT\_V3.0.GDT 2/16/15

**C-70**



# Cone Penetration Test

**C-71**

Date: Apr. 4, 2013  
 Estimated Water Depth:  
 Rig/Operator: ATV/J. Brandsen

Total Depth: 7.9 ft  
 Termination Criteria: Target Depth  
 Cone Size:

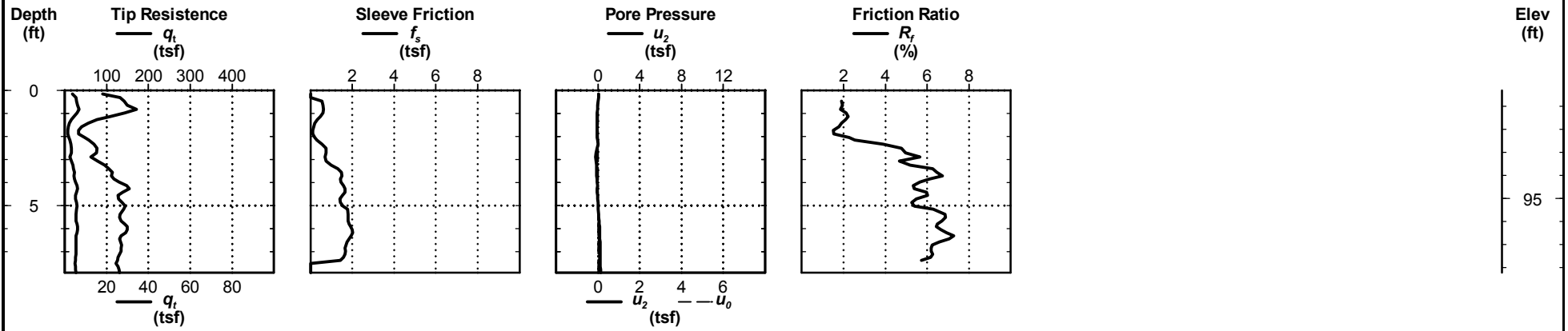

CPT REPORT - STANDARD R2582A\_GEO\_RDWY\_NORTHAMPTON\_CPT\_GINT.GPJ\_CPT\_V3.0.GDT 2/16/15

**C-71**



# Cone Penetration Test

**C-72**

Date: Apr. 4, 2013  
 Estimated Water Depth:  
 Rig/Operator: ATV/J. Brandsen

Total Depth: 8.0 ft  
 Termination Criteria: Target Depth  
 Cone Size:

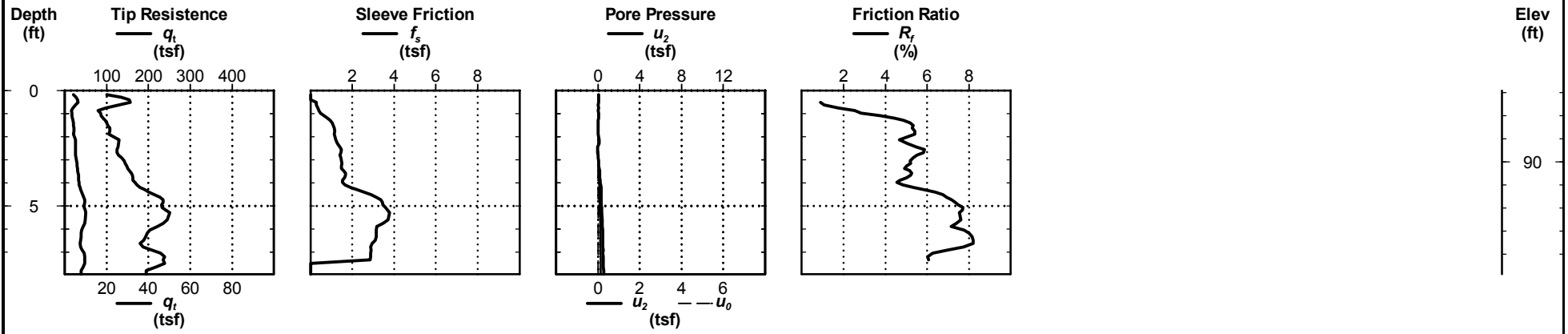

CPT REPORT - STANDARD R2582A\_GEO\_RDWY\_NORTHAMPTON\_CPT\_GINT.GPJ\_CPT V3.0.GDT 2/16/15

**C-72**



# Cone Penetration Test

**C-73**

Date: Apr. 4, 2013  
 Estimated Water Depth:  
 Rig/Operator: ATV/J. Brandsen

Total Depth: 8.0 ft  
 Termination Criteria: Target Depth  
 Cone Size:

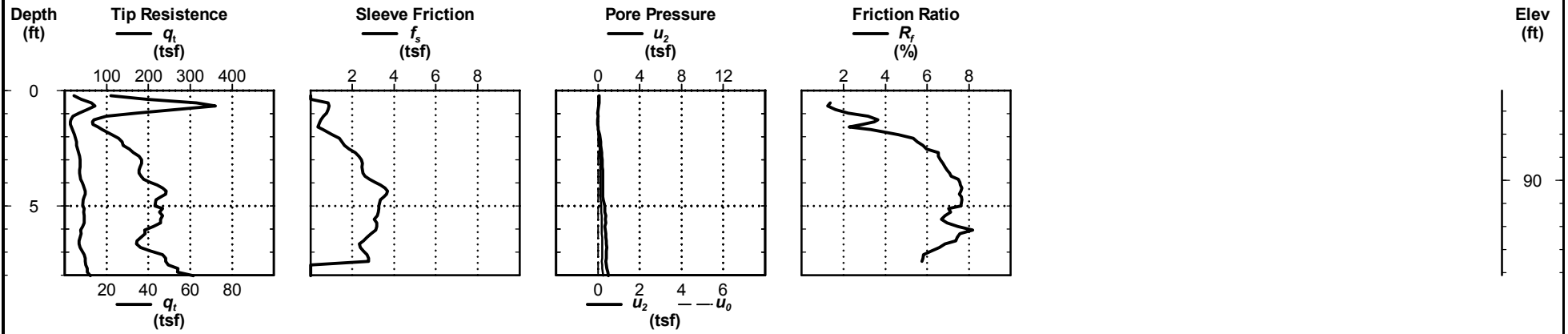

CPT REPORT - STANDARD R2582A\_GEO\_RDWY\_NORTHAMPTON\_CPT\_GINT.GPJ\_CPT\_V3.0.GDT 2/16/15

**C-73**



# Cone Penetration Test

**C-74**

Date: Apr. 4, 2013  
 Estimated Water Depth:  
 Rig/Operator: ATV/J. Brandsen

Total Depth: 8.0 ft  
 Termination Criteria: Target Depth  
 Cone Size:

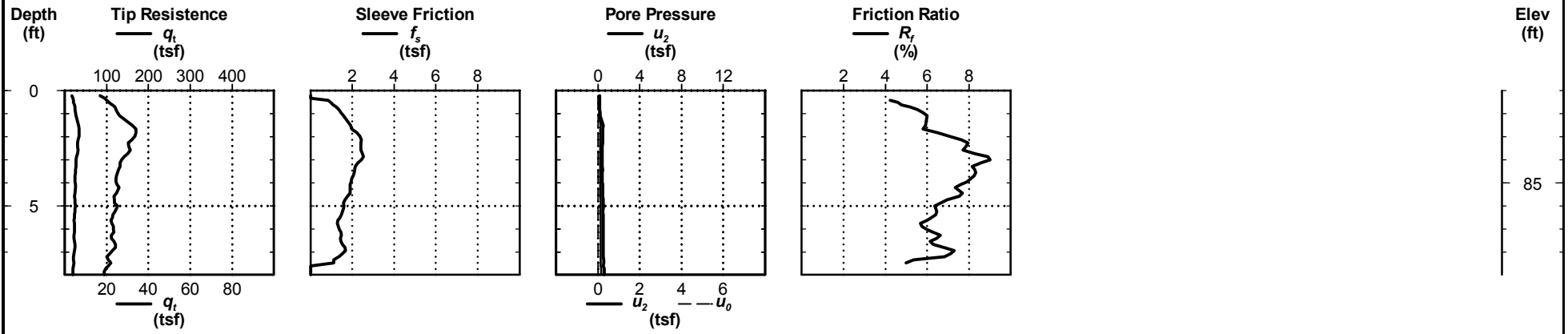

CPT REPORT - STANDARD R2582A\_GEO\_RDWY\_NORTHAMPTON\_CPT\_GINT.GPJ\_CPT V3.0.GDT 2/16/15

**C-74**



# Cone Penetration Test

**C-75**

Date: Apr. 4, 2013  
 Estimated Water Depth:  
 Rig/Operator: ATV/J. Brandsen

Total Depth: 8.0 ft  
 Termination Criteria: Target Depth  
 Cone Size:

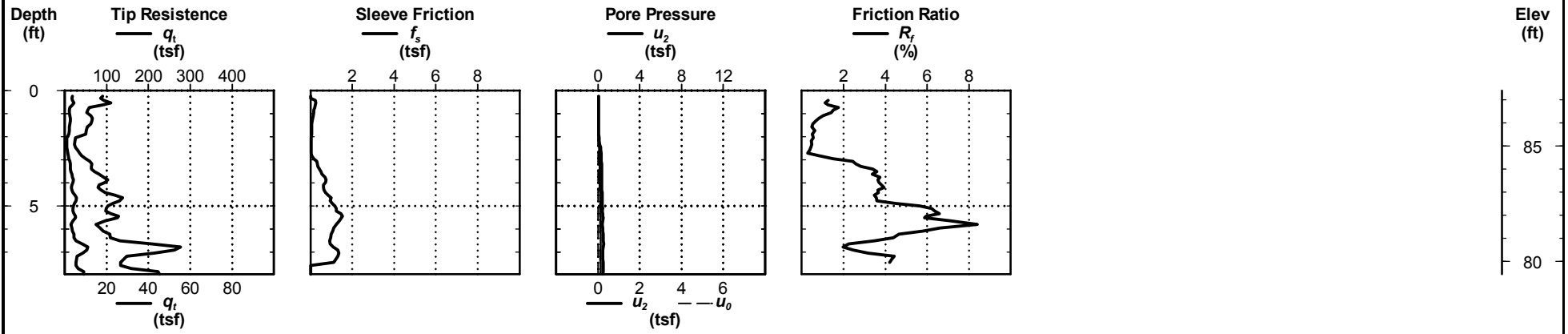

CPT REPORT - STANDARD R2582A\_GEO\_RDWY\_NORTHAMPTON\_CPT\_GINT.GPJ\_CPT V3.0.GDT 2/16/15

**C-75**



# Cone Penetration Test

**C-76**

Date: Apr. 4, 2013  
 Estimated Water Depth:  
 Rig/Operator: ATV/J. Brandsen

Total Depth: 8.0 ft  
 Termination Criteria: Target Depth  
 Cone Size:

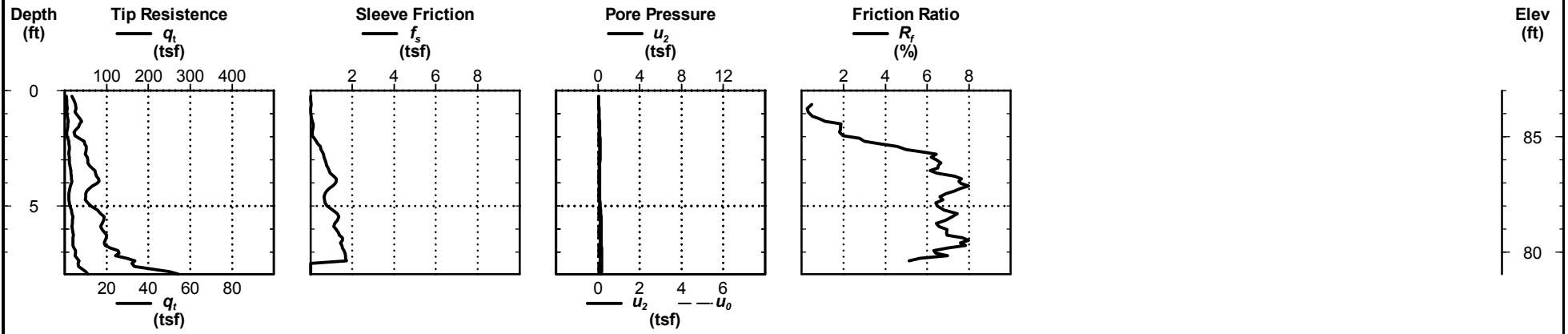

**C-76**



# Cone Penetration Test

**C-77**

Date: Apr. 4, 2013  
 Estimated Water Depth:  
 Rig/Operator: ATV/J. Brandsen

Total Depth: 7.9 ft  
 Termination Criteria: Target Depth  
 Cone Size:

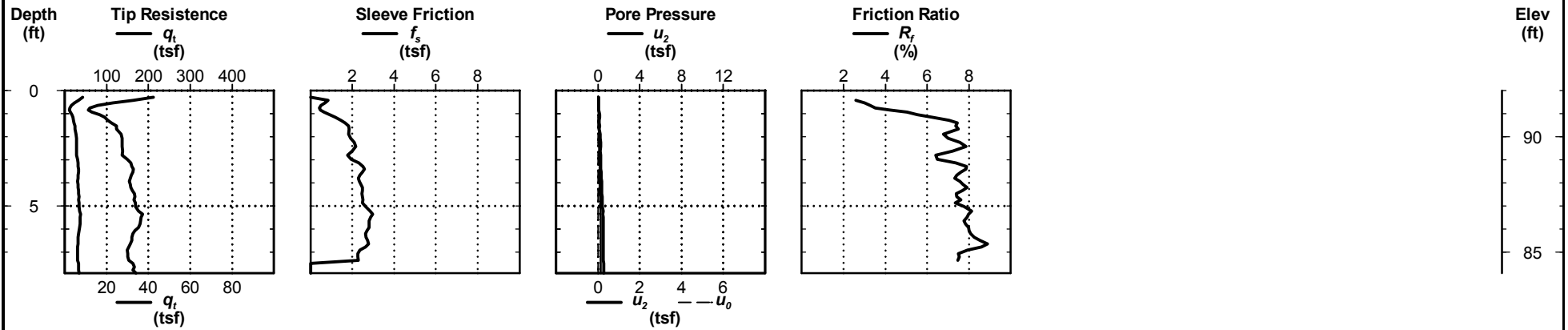

CPT REPORT - STANDARD R2582A\_GEO\_RDWY\_NORTHAMPTON\_CPT\_GINT.GPJ\_CPT\_V3.0.GDT 2/16/15

**C-77**





# Cone Penetration Test

**C-78**

Date: Apr. 4, 2013  
 Estimated Water Depth:  
 Rig/Operator: ATV/J. Brandsen

Total Depth: 7.9 ft  
 Termination Criteria: Target Depth  
 Cone Size:

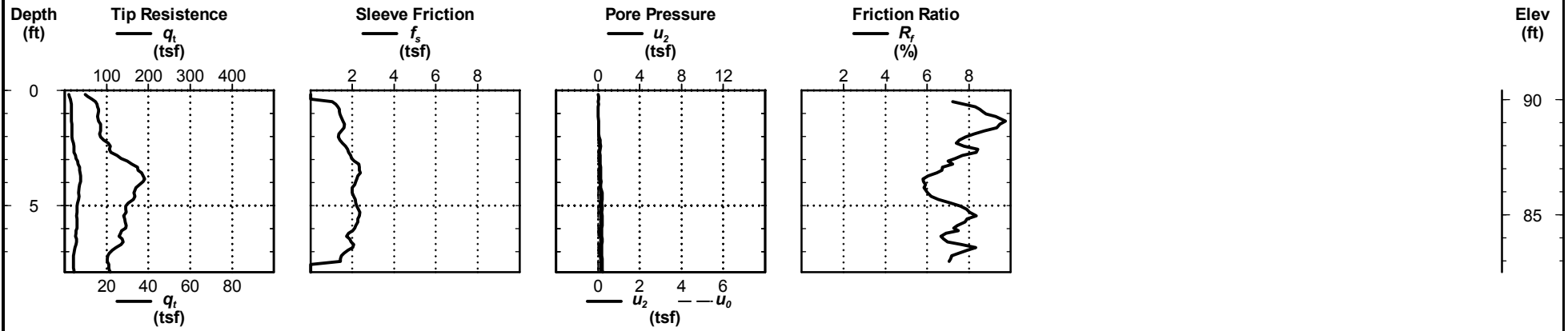

CPT REPORT - STANDARD R2582A\_GEO\_RDWY\_NORTHAMPTON\_CPT\_GINT.GPJ\_CPT V3.0.GDT 2/16/15

**C-78**



# Cone Penetration Test

**C-79**

Date: Apr. 4, 2013  
 Estimated Water Depth:  
 Rig/Operator: ATV/J. Brandsen

Total Depth: 7.9 ft  
 Termination Criteria: Target Depth  
 Cone Size:

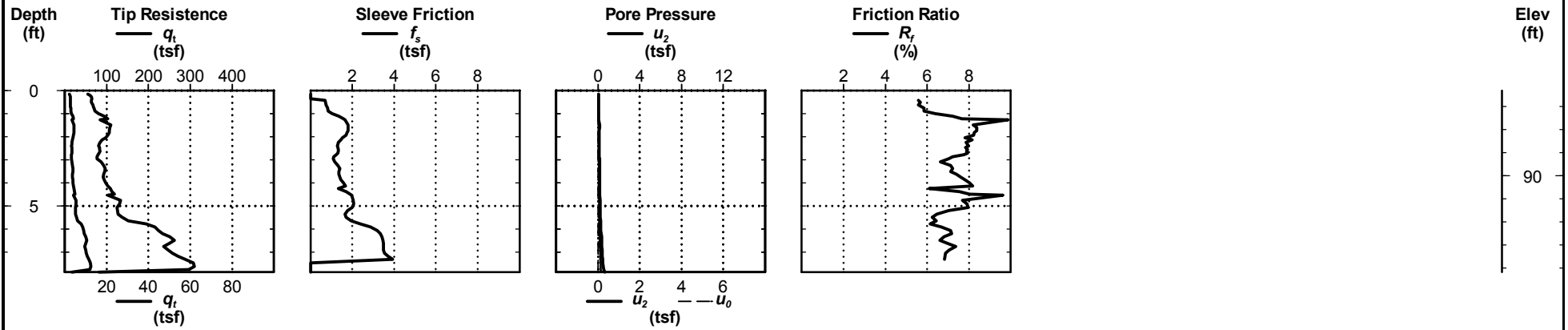

**C-79**



# Cone Penetration Test

**C-80**

Date: Apr. 4, 2013  
 Estimated Water Depth:  
 Rig/Operator: ATV/J. Brandsen

Total Depth: 8.1 ft  
 Termination Criteria: Target Depth  
 Cone Size:

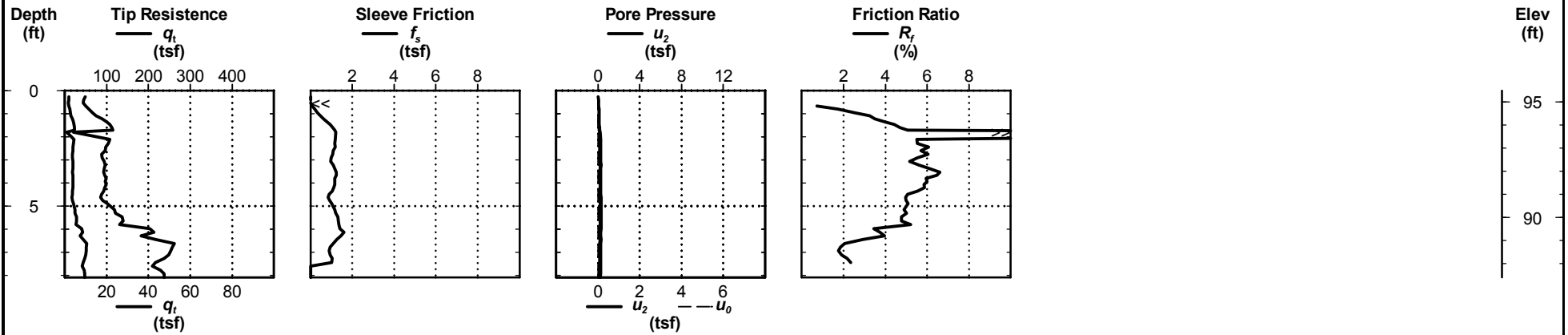

CPT REPORT - STANDARD R2582A\_GEO\_RDWY\_NORTHAMPTON\_CPT\_GINT.GPJ\_CPT V3.0.GDT 2/16/15

**C-80**

R-2582A

81-134

NORTH CAROLINA DEPARTMENT OF TRANSPORTATION  
DIVISION OF HIGHWAYS  
GEOTECHNICAL ENGINEERING UNIT  
SUBSURFACE INVESTIGATION  
APPENDIX I  
CPT LOGS  
INVENTORY SECTION 6

PROJECT: 34472  
REFERENCE: R-2582A

DS

/CB

INITIALS

3/11/2015

DATE



# Cone Penetration Test

**C-81**

Date: Apr. 4, 2013  
 Estimated Water Depth:  
 Rig/Operator: ATV/J. Brandsen

Total Depth: 8.0 ft  
 Termination Criteria: Target Depth  
 Cone Size:

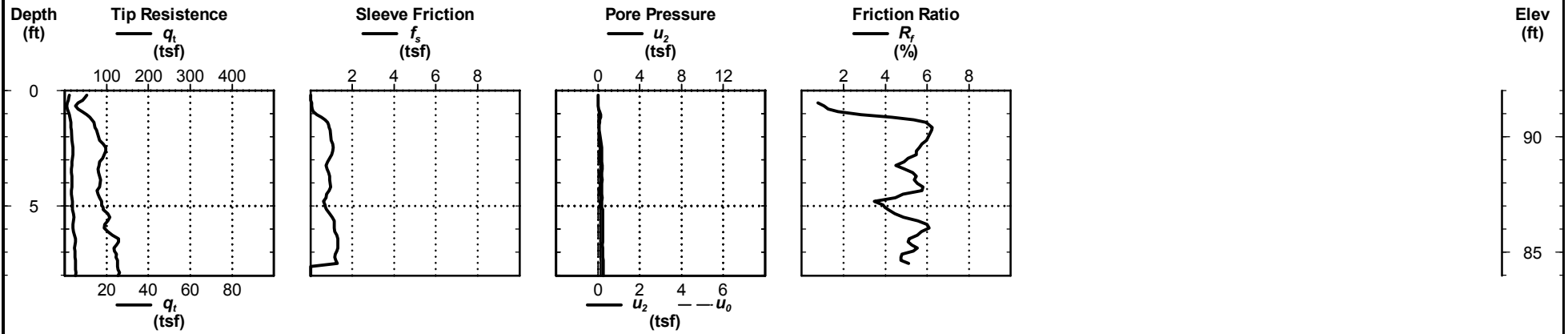

CPT REPORT - STANDARD R2582A\_GEO\_RDWY\_NORTHAMPTON\_CPT\_GINT.GPJ\_CPT V3.0.GDT 2/16/15

**C-81**



# Cone Penetration Test

**C-82**

Date: Apr. 4, 2013  
 Estimated Water Depth:  
 Rig/Operator: ATV/J. Brandsen

Total Depth: 8.1 ft  
 Termination Criteria: Target Depth  
 Cone Size:

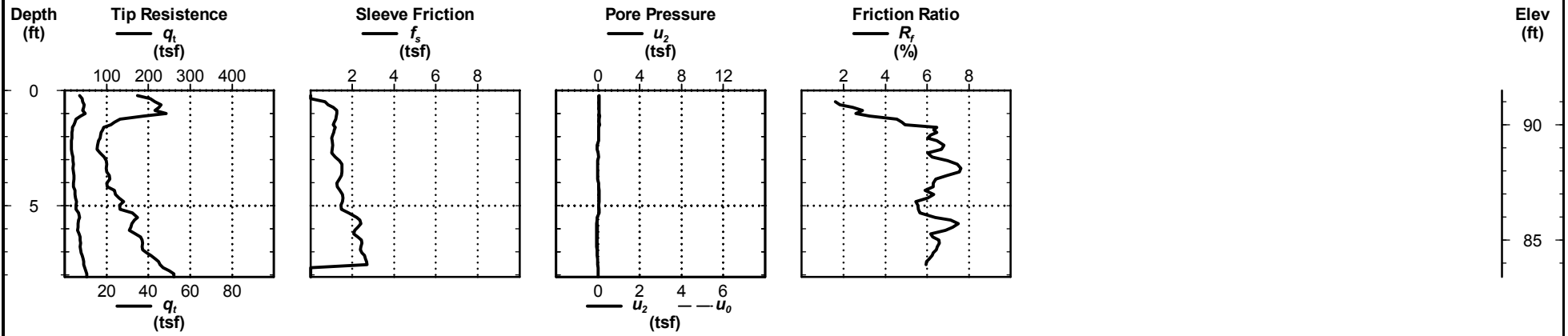

CPT REPORT - STANDARD R2582A\_GEO\_RDWY\_NORTHAMPTON\_CPT\_GINT.GPJ\_CPT V3.0.GDT 2/16/15

**C-82**



# Cone Penetration Test

**C-83**

Date: Apr. 9, 2013  
 Estimated Water Depth:  
 Rig/Operator: ATV/J. Brandsen

Total Depth: 7.9 ft  
 Termination Criteria: Target Depth  
 Cone Size:

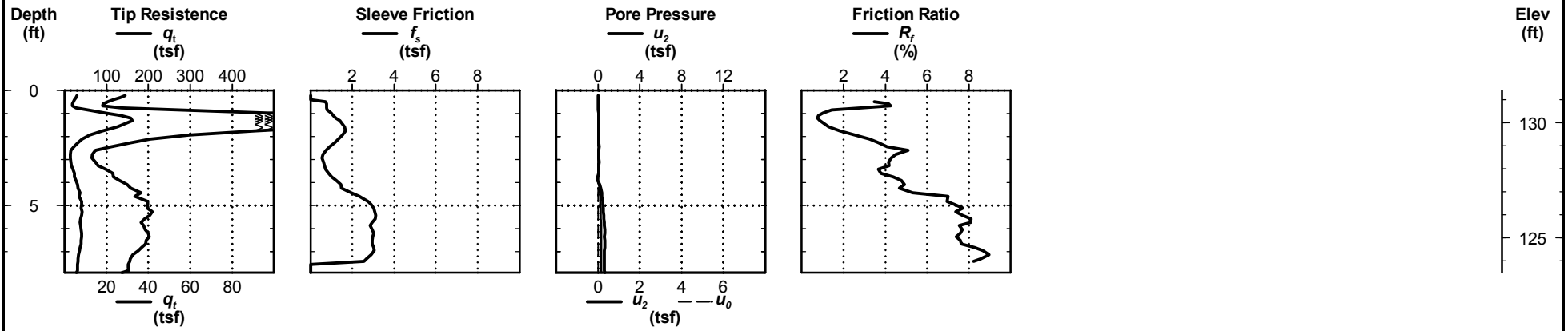

CPT REPORT - STANDARD R2582A\_GEO\_RDWY\_NORTHAMPTON\_CPT\_GINT.GPJ\_CPT\_V3.0.GDT 2/16/15

**C-83**



# Cone Penetration Test

**C-84**

Date: Apr. 9, 2013  
 Estimated Water Depth:  
 Rig/Operator: ATV/J. Brandsen

Total Depth: 9.2 ft  
 Termination Criteria: Target Depth  
 Cone Size:

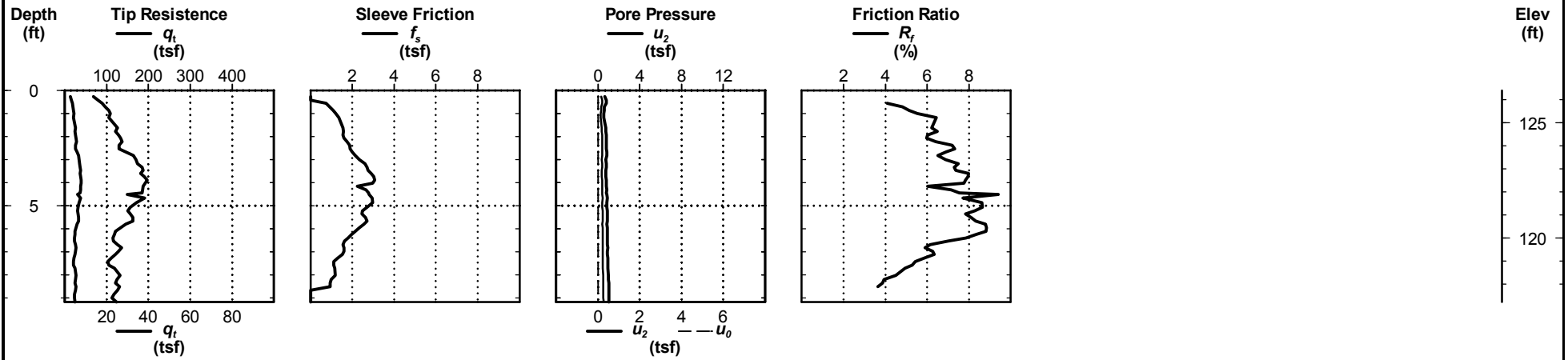

CPT REPORT - STANDARD R2582A\_GEO\_RDWY\_NORTHAMPTON\_CPT\_GINT.GPJ\_CPT\_V3.0.GDT 2/16/15

**C-84**





# Cone Penetration Test

**C-85**

Date: Apr. 9, 2013  
 Estimated Water Depth:  
 Rig/Operator: ATV/J. Brandsen

Total Depth: 8.1 ft  
 Termination Criteria: Target Depth  
 Cone Size:

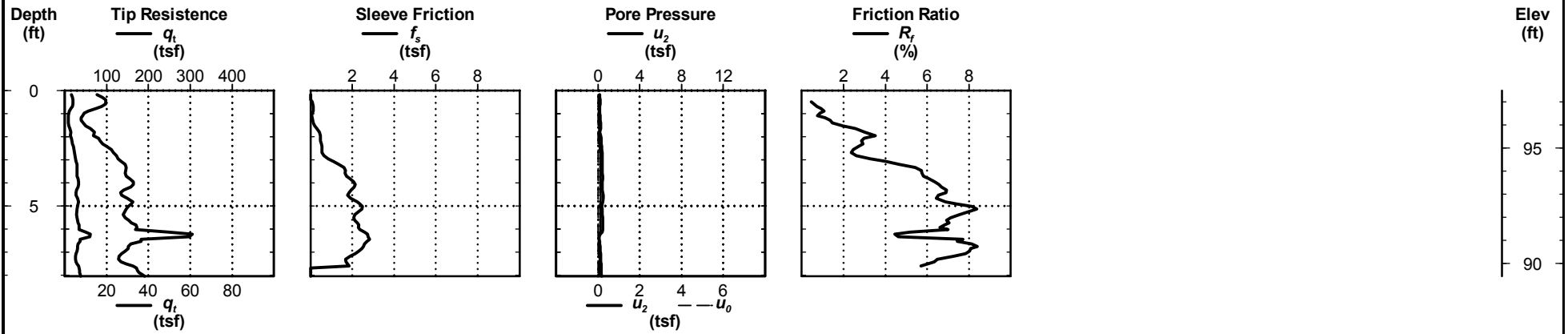

CPT REPORT - STANDARD R2582A\_GEO\_RDWY\_NORTHAMPTON\_CPT\_GINT.GPJ\_CPT V3.0.GDT 2/16/15

**C-85**



# Cone Penetration Test

**C-86**

Date: Apr. 9, 2013  
 Estimated Water Depth:  
 Rig/Operator: ATV/J. Brandsen

Total Depth: 8.1 ft  
 Termination Criteria: Target Depth  
 Cone Size:

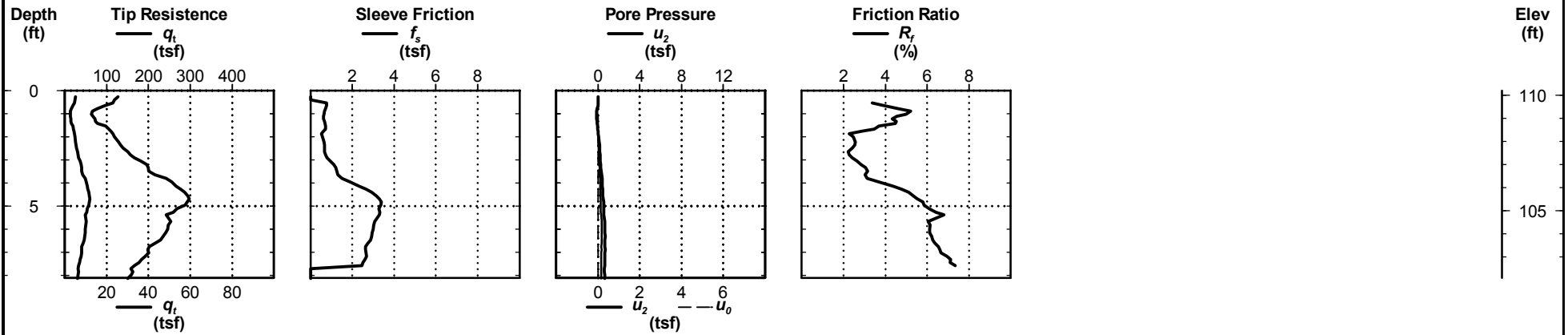

CPT REPORT - STANDARD R2582A\_GEO\_RDWY\_NORTHAMPTON\_CPT\_GINT.GPJ\_CPT\_V3.0.GDT 2/16/15

**C-86**



# Cone Penetration Test

**C-87**

Date: Apr. 9, 2013  
 Estimated Water Depth:  
 Rig/Operator: ATV/J. Brandsen

Total Depth: 8.0 ft  
 Termination Criteria: Target Depth  
 Cone Size:

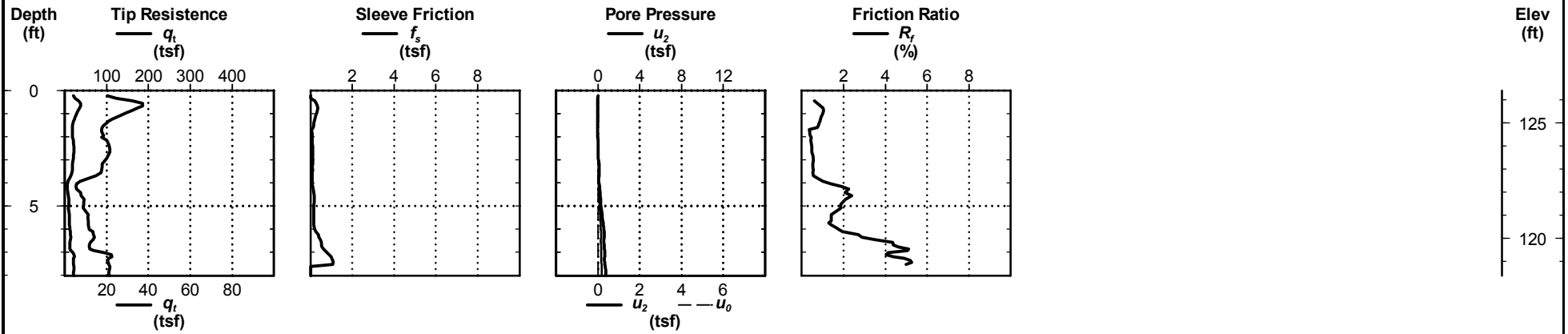

CPT REPORT - STANDARD R2582A\_GEO\_RDWY\_NORTHAMPTON\_CPT\_GINT.GPJ\_CPT V3.0.GDT 2/16/15

**C-87**



# Cone Penetration Test

**C-88**

Date: Apr. 9, 2013  
 Estimated Water Depth:  
 Rig/Operator: ATV/J. Brandsen

Total Depth: 8.0 ft  
 Termination Criteria: Target Depth  
 Cone Size:

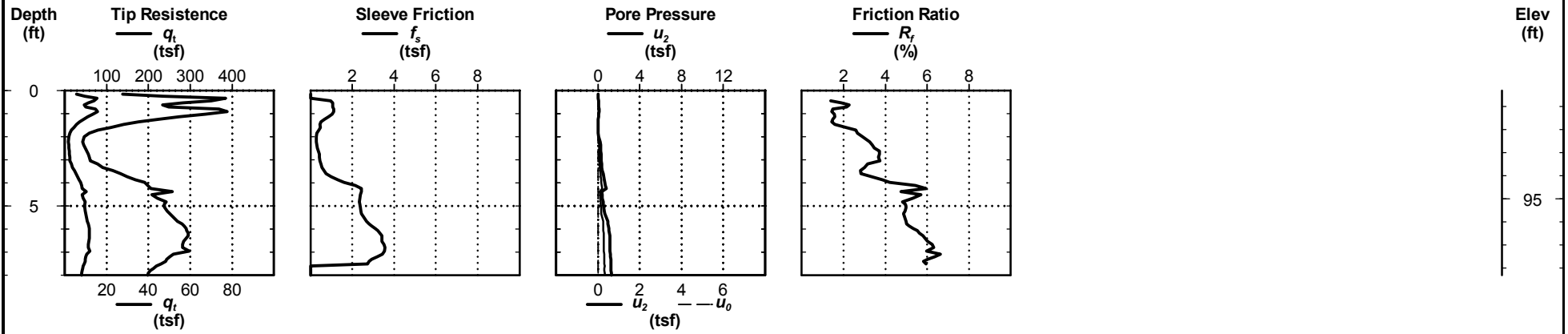

CPT REPORT - STANDARD R2582A\_GEO\_RDWY\_NORTHAMPTON\_CPT\_GINT.GPJ\_CPT V3.0.GDT 2/16/15

**C-88**



# Cone Penetration Test

**C-89**

Date: Apr. 9, 2013  
 Estimated Water Depth:  
 Rig/Operator: ATV/J. Brandsen

Total Depth: 8.1 ft  
 Termination Criteria: Target Depth  
 Cone Size:

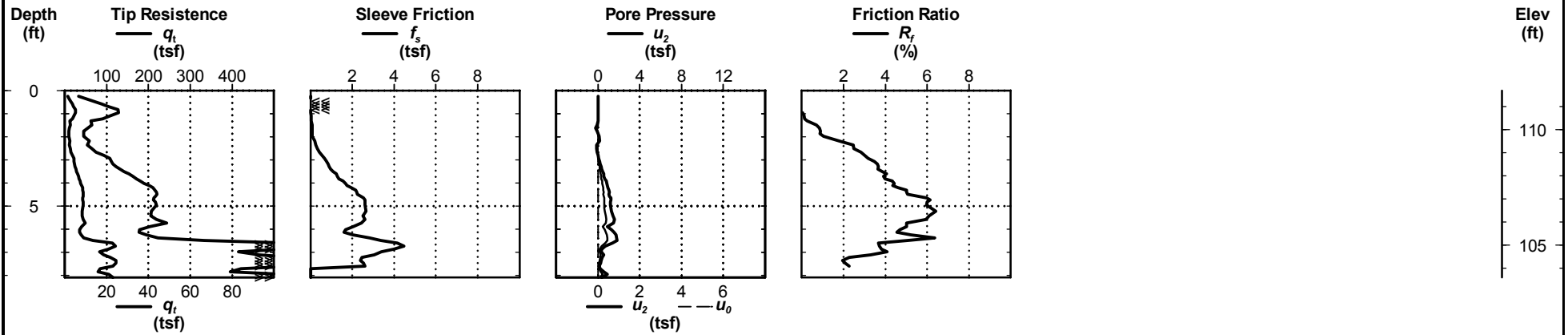

CPT REPORT - STANDARD R2582A\_GEO\_RDWY\_NORTHAMPTON\_CPT\_GINT.GPJ\_CPT V3.0.GDT 2/16/15

**C-89**



# Cone Penetration Test

**C-90**

Date: Apr. 8, 2013  
 Estimated Water Depth:  
 Rig/Operator: ATV/J. Brandsen

Total Depth: 8.2 ft  
 Termination Criteria: Target Depth  
 Cone Size:

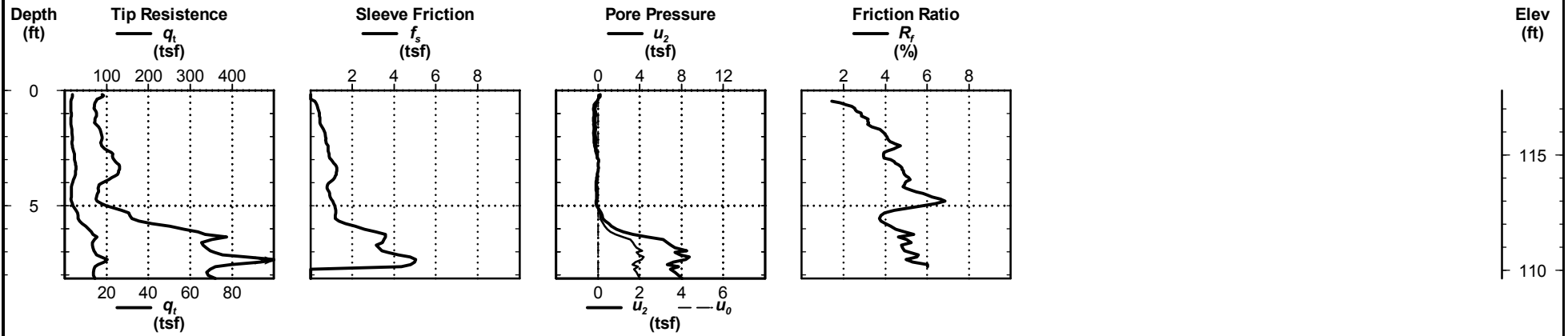

CPT REPORT - STANDARD R2582A\_GEO\_RDWY\_NORTHAMPTON\_CPT\_GINT.GPJ\_CPT\_V3.0.GDT 2/16/15

**C-90**



# Cone Penetration Test

**C-91**

Date: Apr. 8, 2013  
 Estimated Water Depth:  
 Rig/Operator: ATV/J. Brandsen

Total Depth: 8.1 ft  
 Termination Criteria: Target Depth  
 Cone Size:

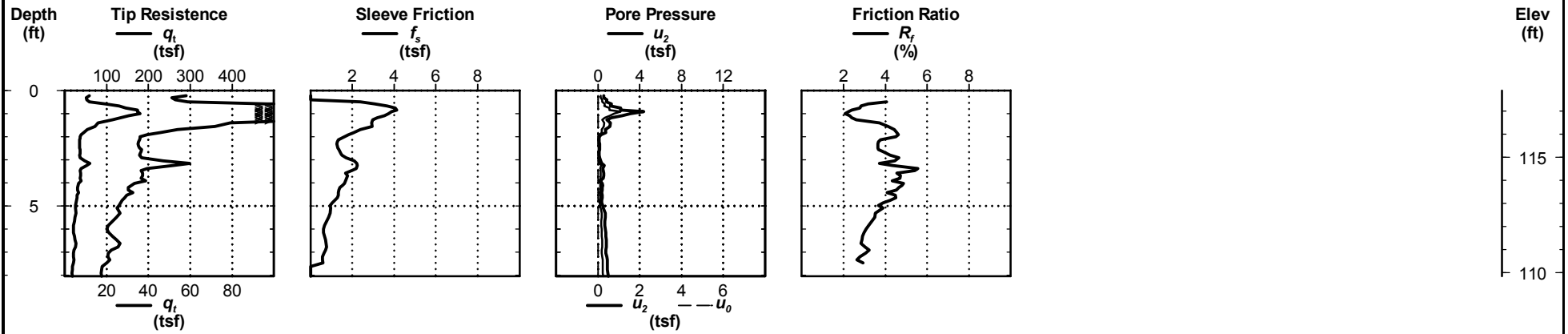

CPT REPORT - STANDARD R2582A\_GEO\_RDWY\_NORTHAMPTON\_CPT\_GINT.GPJ\_CPT V3.0.GDT 2/16/15

**C-91**



# Cone Penetration Test

**C-92**

Date: Apr. 8, 2013  
 Estimated Water Depth:  
 Rig/Operator: ATV/J. Brandsen

Total Depth: 8.0 ft  
 Termination Criteria: Target Depth  
 Cone Size:

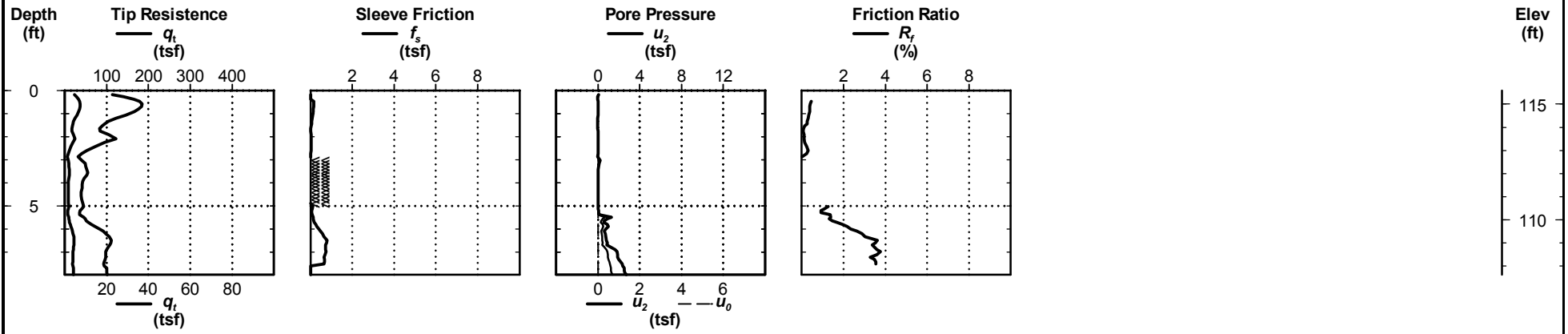

**C-92**





# Cone Penetration Test

**C-93**

Date: Apr. 5, 2013  
 Estimated Water Depth:  
 Rig/Operator: ATV/J. Brandsen

Total Depth: 8.4 ft  
 Termination Criteria: Target Depth  
 Cone Size:

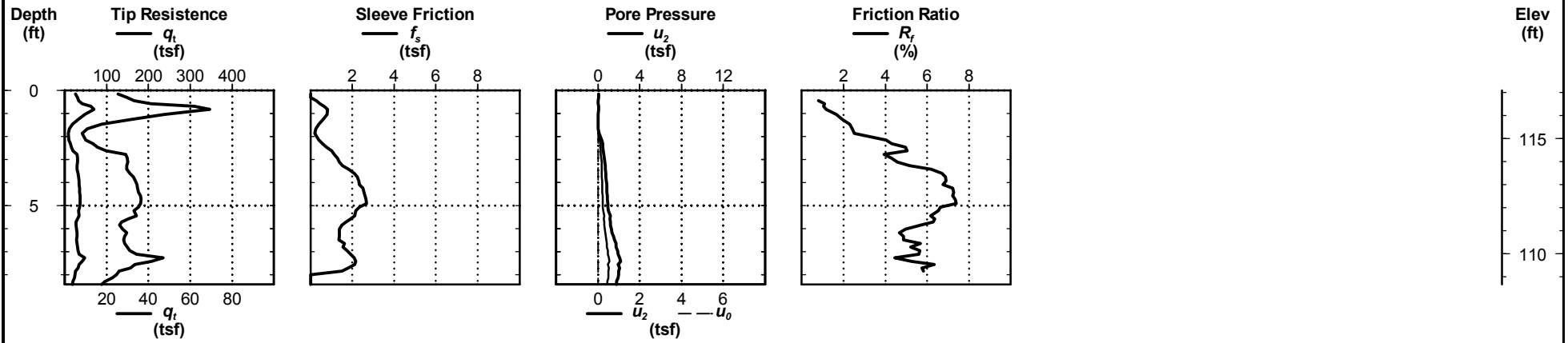

CPT REPORT - STANDARD R2582A\_GEO\_RDWY\_NORTHAMPTON\_CPT\_GINT.GPJ\_CPT\_V3.0.GDT 2/16/15

**C-93**



# Cone Penetration Test

**C-94**

Date: Apr. 5, 2013  
 Estimated Water Depth:  
 Rig/Operator: ATV/J. Brandsen

Total Depth: 16.1 ft  
 Termination Criteria: Target Depth  
 Cone Size:

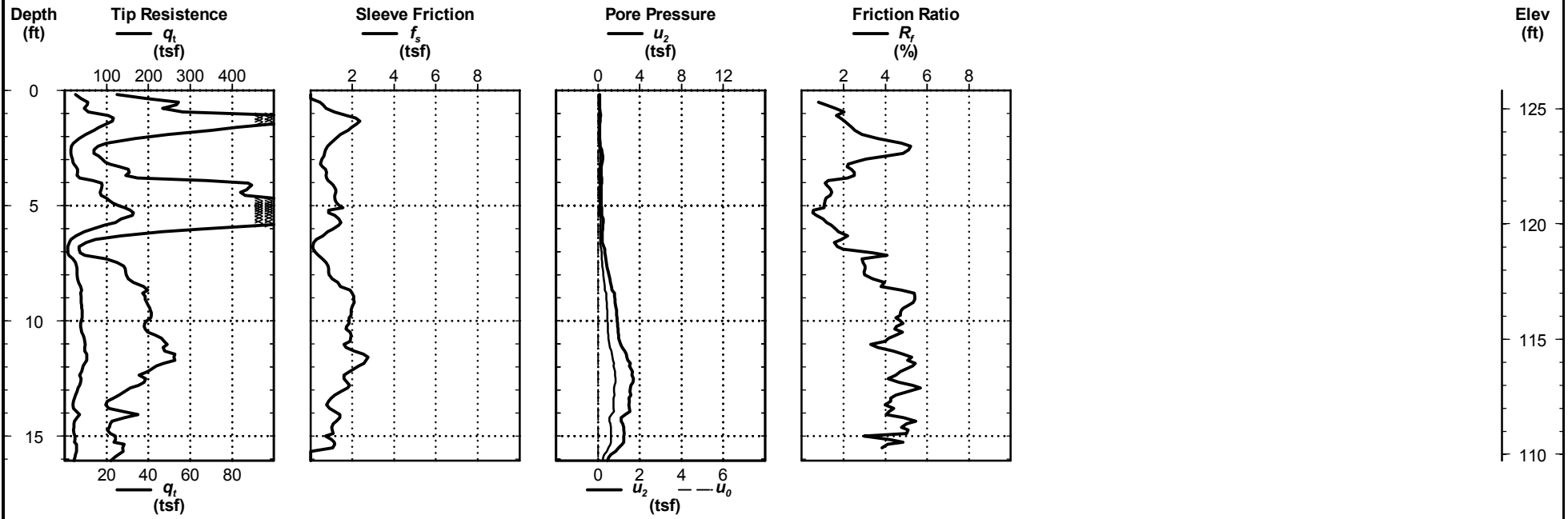

CPT REPORT - STANDARD R2582A\_GEO\_RDWY\_NORTHAMPTON\_CPT\_GINT.GPJ\_CPT V3.0.GDT 2/16/15

**C-94**



# Cone Penetration Test

**C-95**

Date: Apr. 5, 2013  
 Estimated Water Depth:  
 Rig/Operator: ATV/J. Brandsen

Total Depth: 8.9 ft  
 Termination Criteria: Target Depth  
 Cone Size:

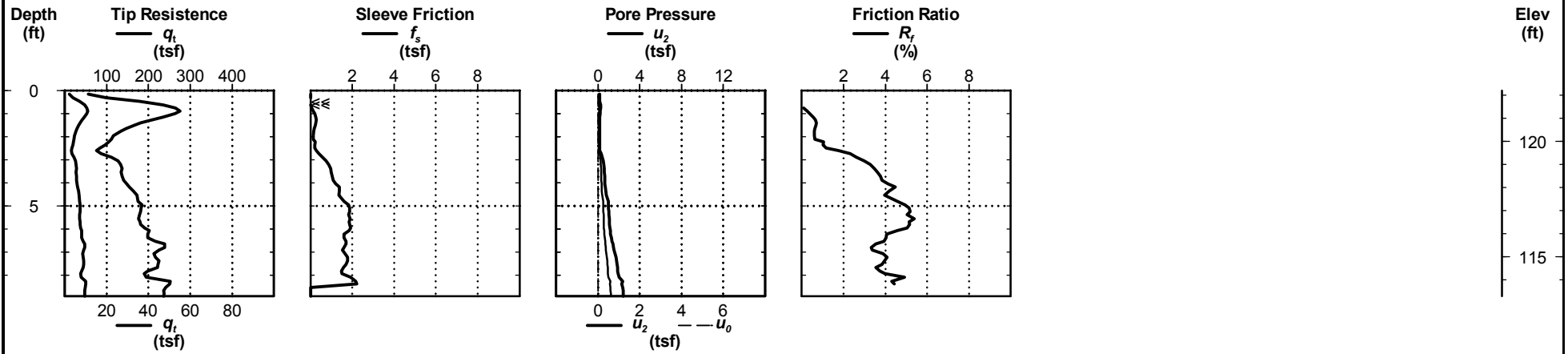

**C-95**



# Cone Penetration Test

**C-96**

Date: Apr. 5, 2013  
 Estimated Water Depth:  
 Rig/Operator: ATV/J. Brandsen

Total Depth: 9.0 ft  
 Termination Criteria: Target Depth  
 Cone Size:

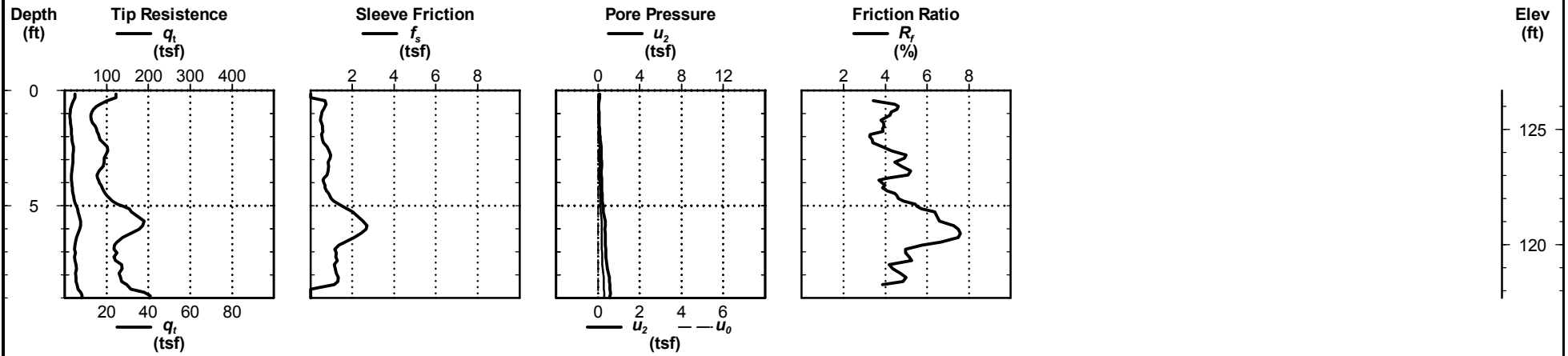

CPT REPORT - STANDARD R2582A\_GEO\_RDWY\_NORTHAMPTON\_CPT\_GINT.GPJ\_CPT\_V3.0.GDT 2/16/15

**C-96**



# Cone Penetration Test

**C-97**

Date: Apr. 5, 2013  
 Estimated Water Depth:  
 Rig/Operator: ATV/J. Brandsen

Total Depth: 9.1 ft  
 Termination Criteria: Target Depth  
 Cone Size:

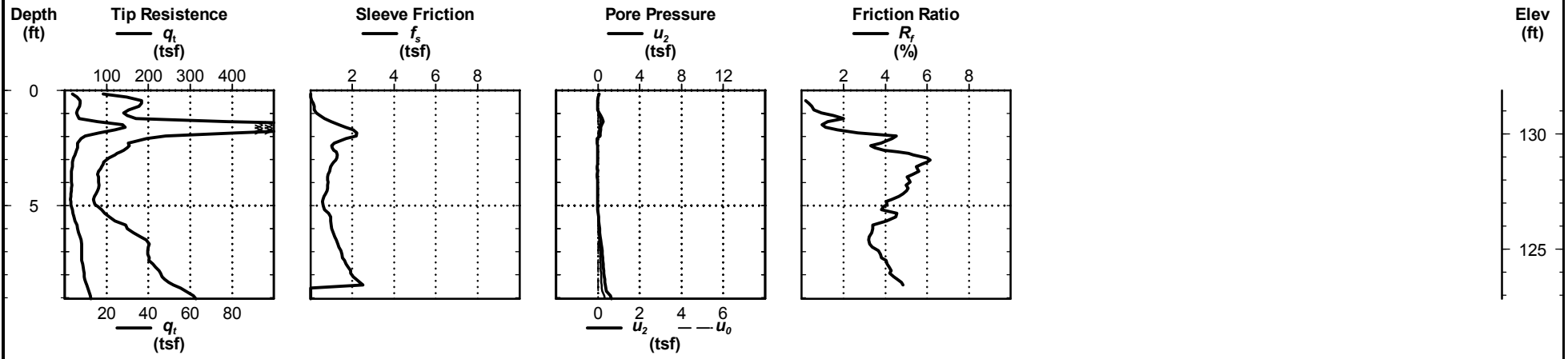

CPT REPORT - STANDARD R2582A\_GEO\_RDWY\_NORTHAMPTON\_CPT\_GINT.GPJ\_CPT\_V3.0.GDT 2/16/15

**C-97**



# Cone Penetration Test

**C-98**

Date: Apr. 5, 2013  
 Estimated Water Depth:  
 Rig/Operator: ATV/J. Brandsen

Total Depth: 11.9 ft  
 Termination Criteria: Target Depth  
 Cone Size:

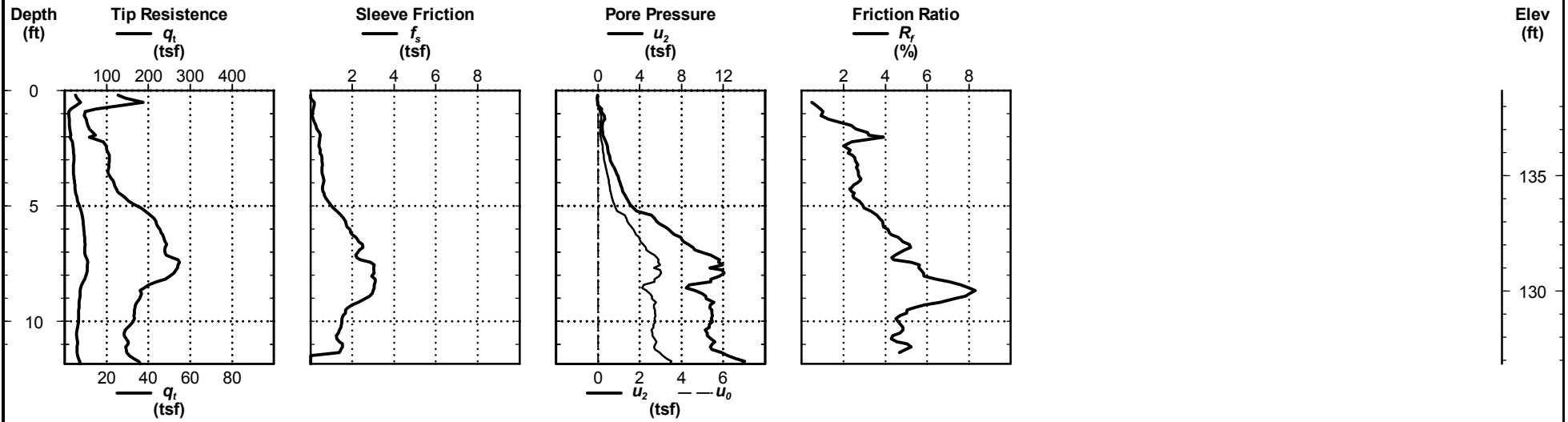

CPT REPORT - STANDARD R2582A\_GEO\_RDWY\_NORTHAMPTON\_CPT\_GINT.GPJ\_CPT\_V3.0.GDT 2/16/15

**C-98**



# Cone Penetration Test

**C-99**

Date: Apr. 5, 2013  
 Estimated Water Depth:  
 Rig/Operator: ATV/J. Brandsen

Total Depth: 8.1 ft  
 Termination Criteria: Target Depth  
 Cone Size:

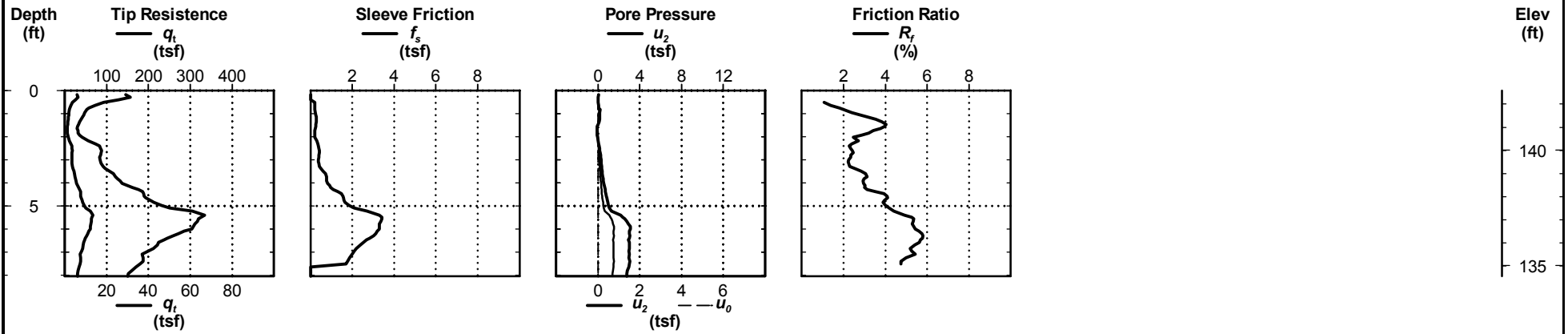

CPT REPORT - STANDARD R2582A\_GEO\_RDWY\_NORTHAMPTON\_CPT\_GINT.GPJ\_CPT V3.0.GDT 2/16/15

**C-99**



# Cone Penetration Test

## C-100

Date: Apr. 5, 2013  
 Estimated Water Depth:  
 Rig/Operator: ATV/J. Brandsen

Total Depth: 8.2 ft  
 Termination Criteria: Target Depth  
 Cone Size:

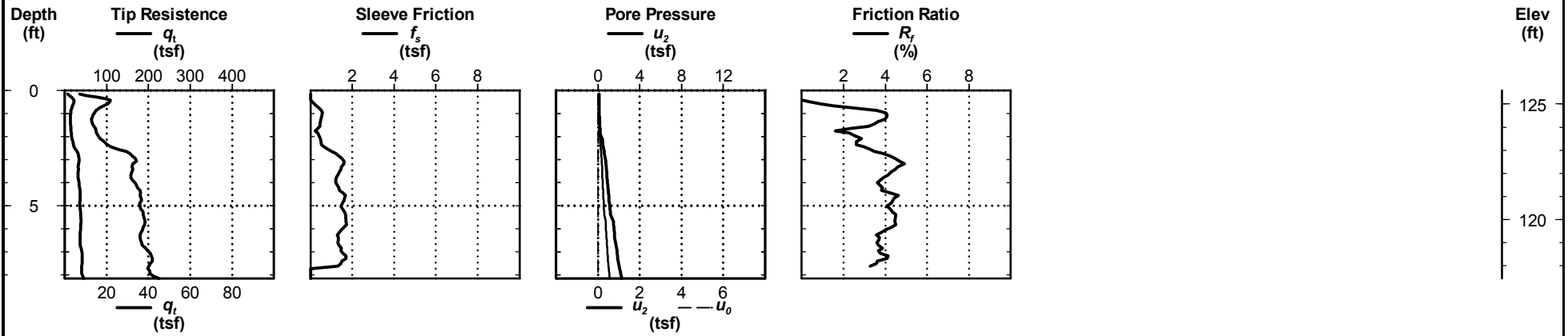

## C-100





# Cone Penetration Test

# C-101

Date: Apr. 10, 2013  
 Estimated Water Depth:  
 Rig/Operator: ATV/J. Brandsen

Total Depth: 8.0 ft  
 Termination Criteria: Target Depth  
 Cone Size:

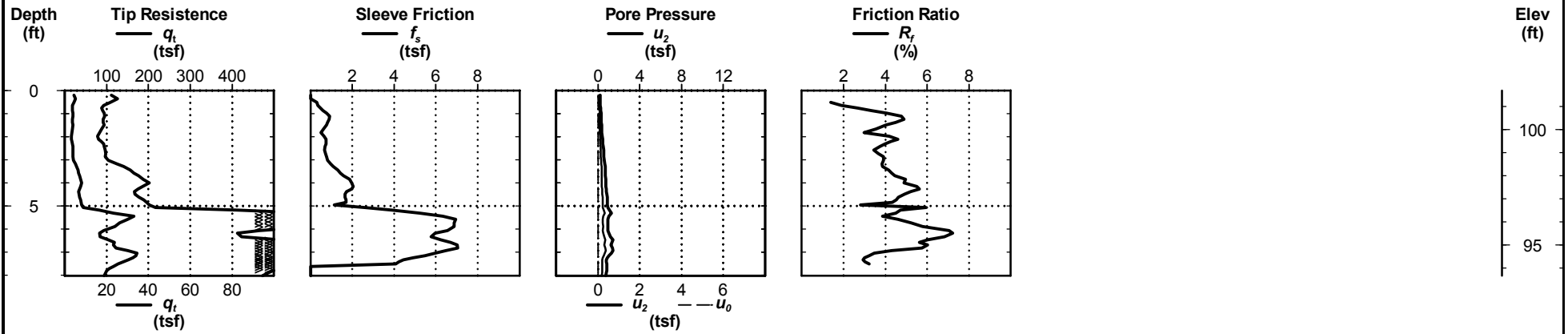

CPT REPORT - STANDARD R2582A\_GEO\_RDWY\_NORTHAMPTON\_CPT\_GINT.GPJ\_CPT V3.0.GDT 2/16/15

# C-101



# Cone Penetration Test

## C-102

Date: Apr. 10, 2013  
 Estimated Water Depth:  
 Rig/Operator: ATV/J. Brandsen

Total Depth: 8.1 ft  
 Termination Criteria: Target Depth  
 Cone Size:

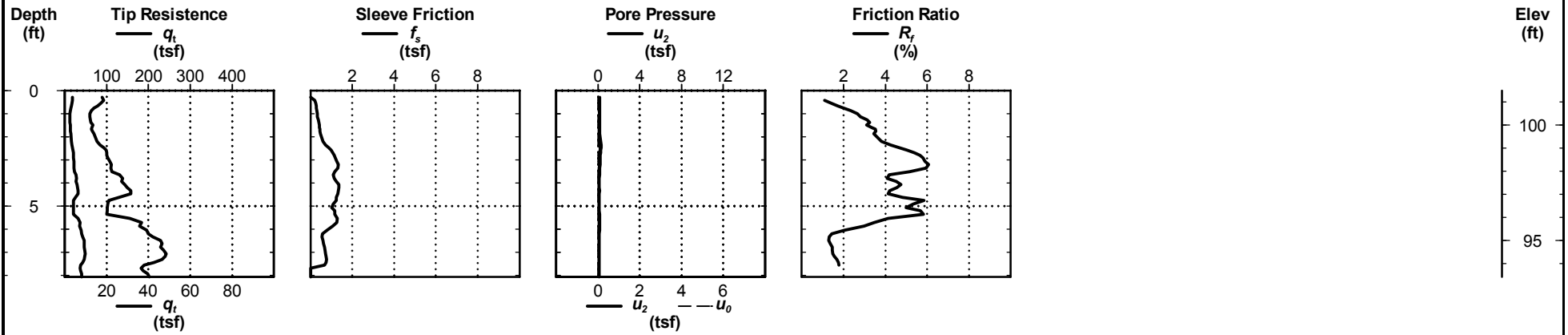

CPT REPORT - STANDARD R2582A\_GEO\_RDWY\_NORTHAMPTON\_CPT\_GINT.GPJ\_CPT V3.0.GDT 2/16/15

## C-102



# Cone Penetration Test

**C-103**

Date: Apr. 10, 2013  
 Estimated Water Depth:  
 Rig/Operator: ATV/J. Brandsen

Total Depth: 8.0 ft  
 Termination Criteria: Target Depth  
 Cone Size:

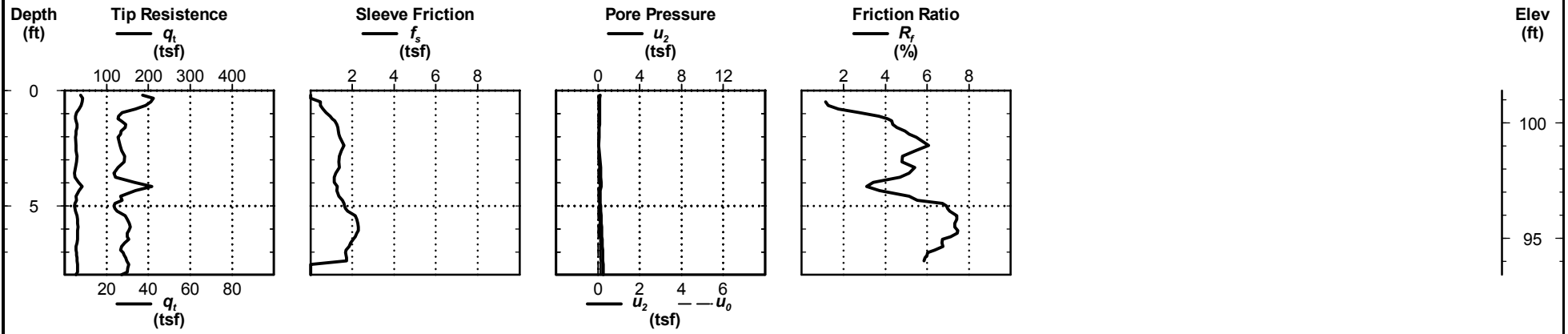

CPT REPORT - STANDARD R2582A\_GEO\_RDWY\_NORTHAMPTON\_CPT\_GINT.GPJ\_CPT\_V3.0.GDT 2/16/15

**C-103**



# Cone Penetration Test

## C-104

Date: Apr. 10, 2013  
 Estimated Water Depth:  
 Rig/Operator: ATV/J. Brandsen

Total Depth: 8.1 ft  
 Termination Criteria: Target Depth  
 Cone Size:

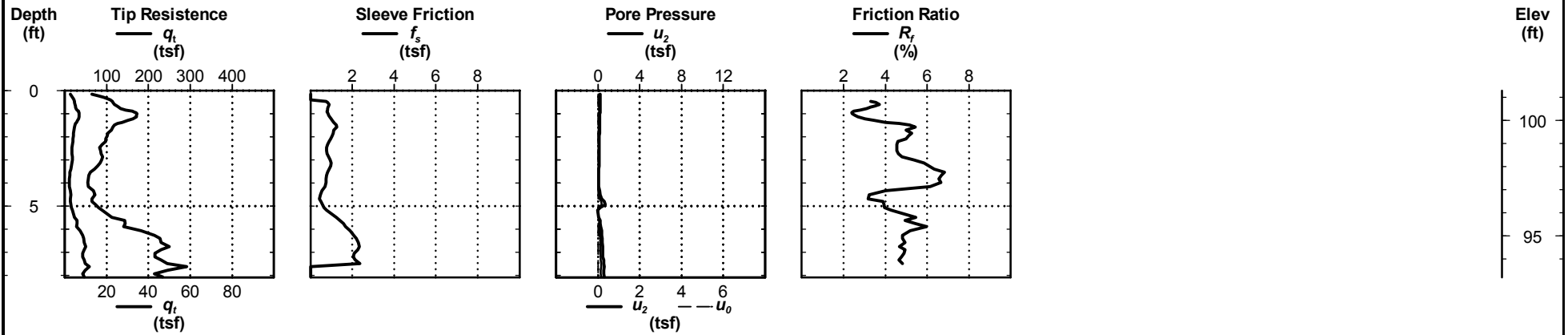

CPT REPORT - STANDARD R2582A\_GEO\_RDWY\_NORTHAMPTON\_CPT\_GINT.GPJ\_CPT\_V3.0.GDT 2/16/15

## C-104



# Cone Penetration Test

## C-105

Date: Apr. 10, 2013  
 Estimated Water Depth:  
 Rig/Operator: ATV/J. Brandsen

Total Depth: 8.0 ft  
 Termination Criteria: Target Depth  
 Cone Size:

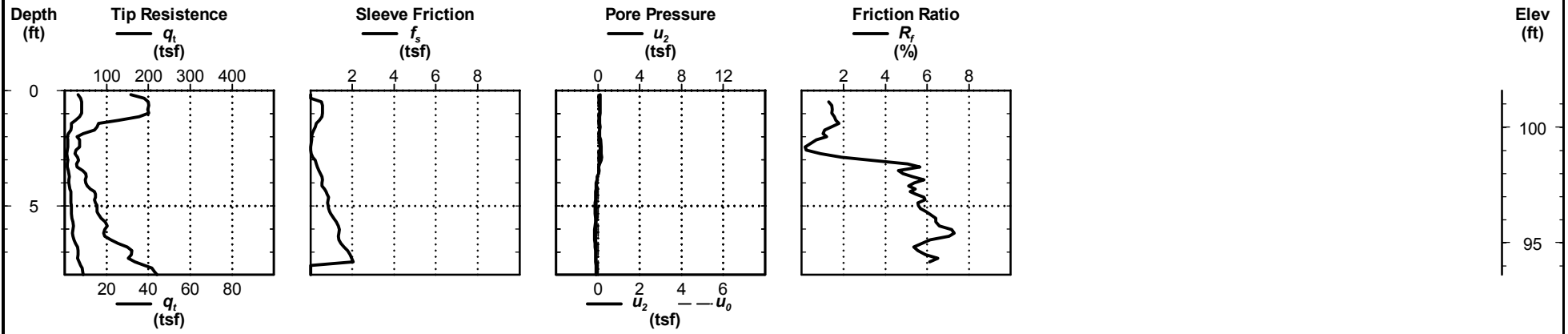

## C-105



# Cone Penetration Test

**C-106**

Date: Apr. 10, 2013  
 Estimated Water Depth:  
 Rig/Operator: ATV/J. Brandsen

Total Depth: 8.3 ft  
 Termination Criteria: Target Depth  
 Cone Size:

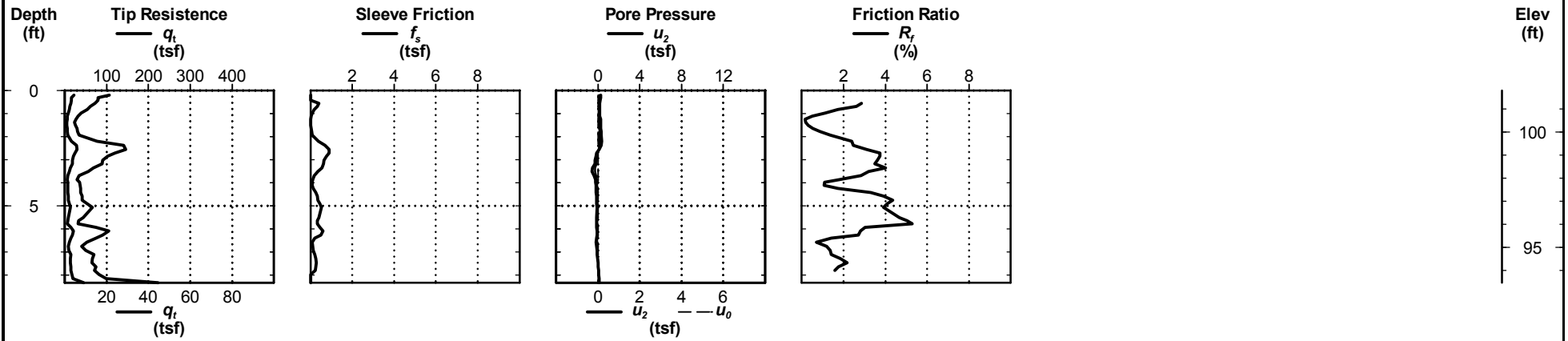

CPT REPORT - STANDARD R2582A\_GEO\_RDWY\_NORTHAMPTON\_CPT\_GINT.GPJ\_CPT\_V3.0.GDT 2/16/15

**C-106**



# Cone Penetration Test

## C-107

Date: Apr. 3, 2013  
 Estimated Water Depth:  
 Rig/Operator: ATV/J. Brandsen

Total Depth: 8.0 ft  
 Termination Criteria: Target Depth  
 Cone Size:

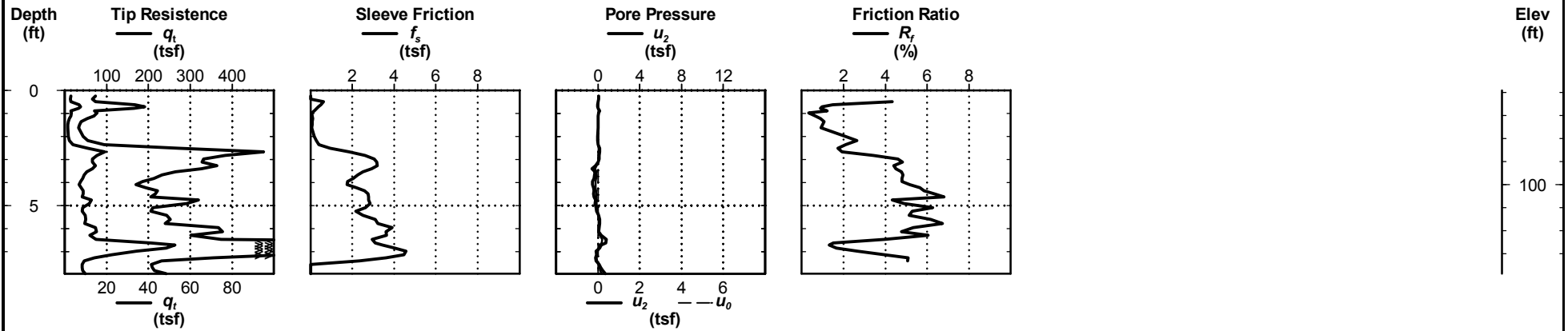

CPT REPORT - STANDARD R2582A\_GEO\_RDWY\_NORTHAMPTON\_CPT\_GINT.GPJ\_CPT V3.0.GDT 2/16/15

## C-107



# Cone Penetration Test

## C-108

Date: Apr. 3, 2013  
 Estimated Water Depth:  
 Rig/Operator: ATV/J. Brandsen

Total Depth: 15.0 ft  
 Termination Criteria: Target Depth  
 Cone Size:

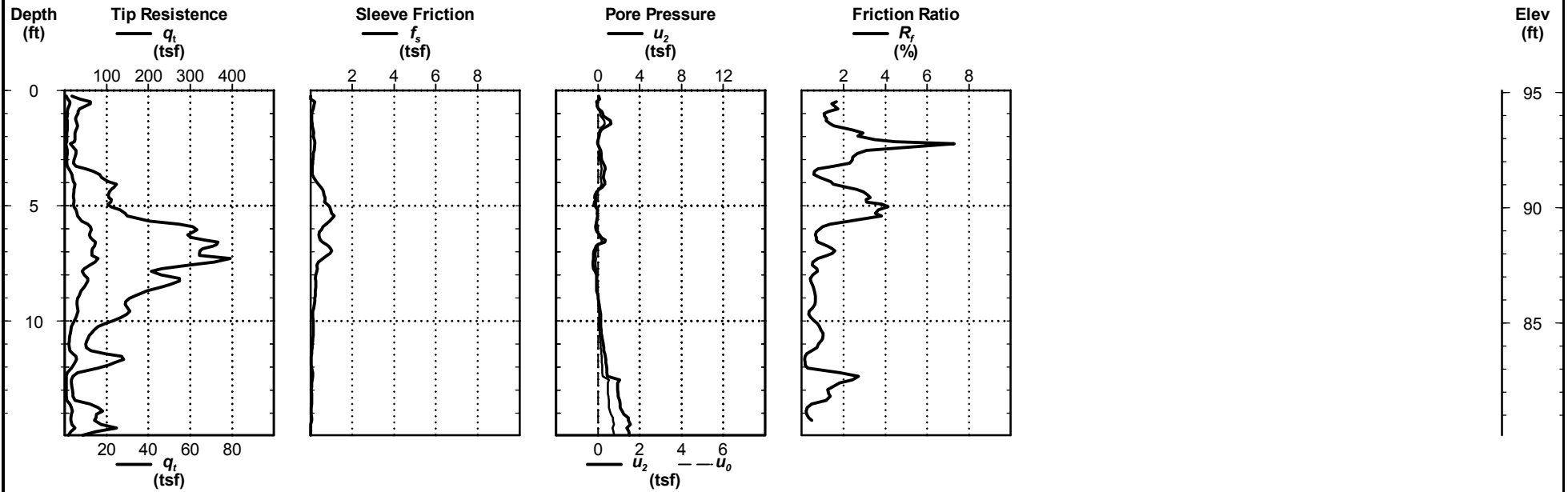

CPT REPORT - STANDARD R2582A\_GEO\_RDWY\_NORTHAMPTON\_CPT\_GINT.GPJ\_CPT\_V3.0.GDT 2/16/15

## C-108





# Cone Penetration Test

## C-109

Date: Apr. 3, 2013  
 Estimated Water Depth:  
 Rig/Operator: ATV/J. Brandsen

Total Depth: 28.0 ft  
 Termination Criteria: Target Depth  
 Cone Size:

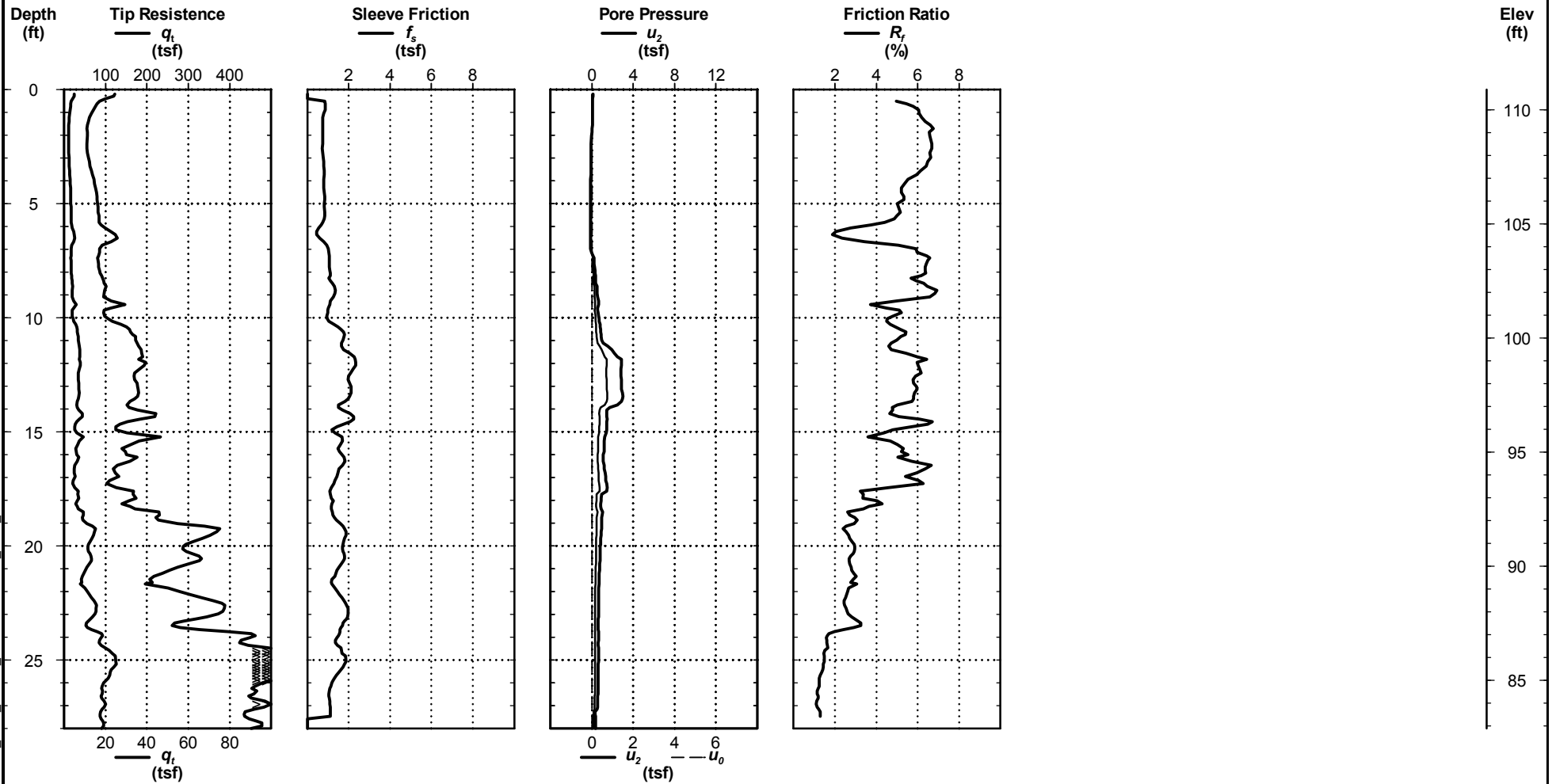

CPT REPORT - STANDARD R2582A\_GEO\_RDWY\_NORTHAMPTON\_CPT\_GINT.GPJ\_CPT\_V3.0.GDT 2/16/15

## C-109



# Cone Penetration Test

# C-110

Date: Apr. 3, 2013  
 Estimated Water Depth:  
 Rig/Operator: ATV/J. Brandsen

Total Depth: 29.0 ft  
 Termination Criteria: Target Depth  
 Cone Size:

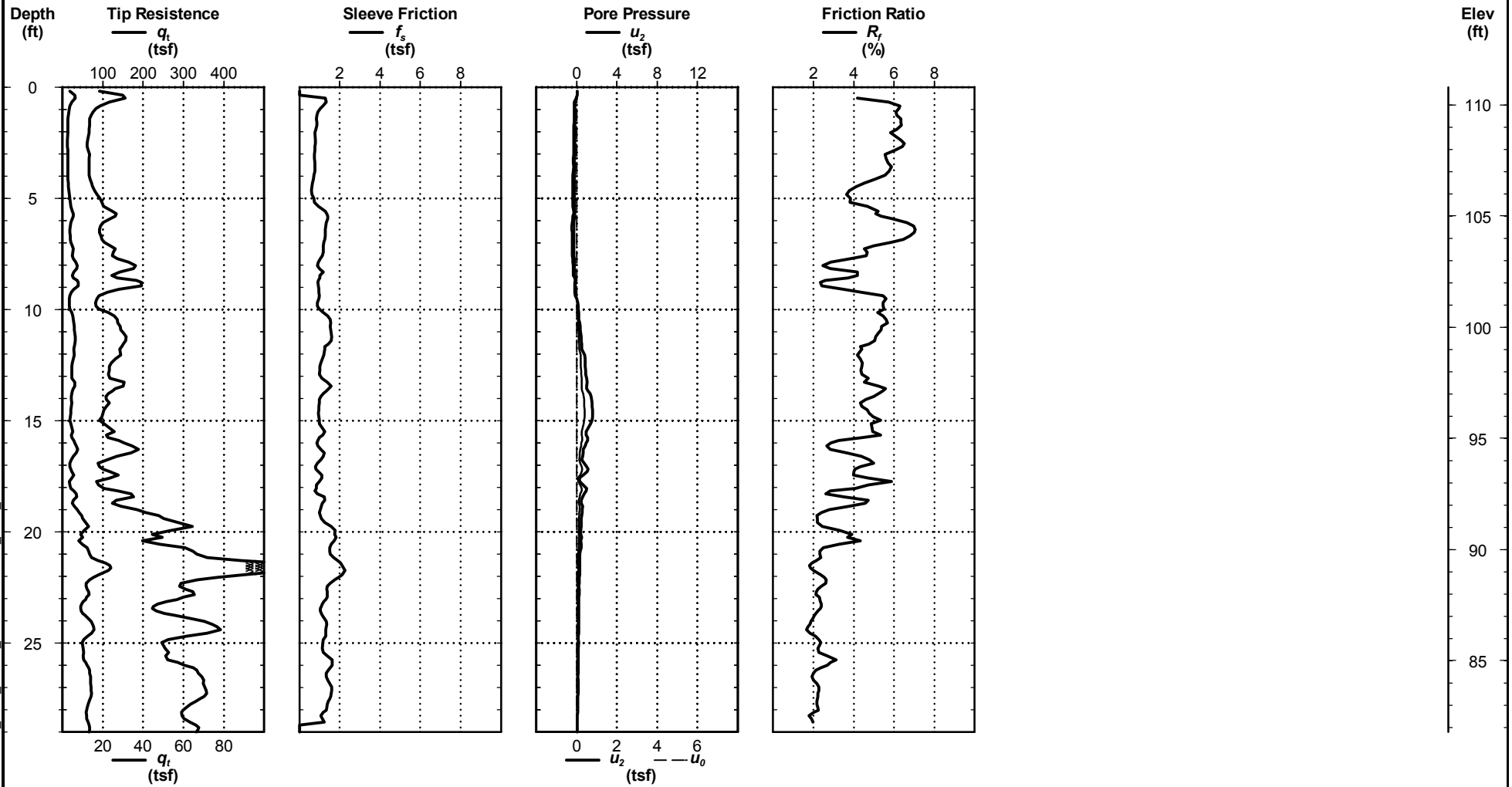

CPT REPORT - STANDARD R2582A GEO\_RDWY\_NORTHAMPTON\_CPT\_GINT.GPJ\_CPT\_V3.0.GDT 2/16/15

# C-110



# Cone Penetration Test

# C-111

Date: Apr. 3, 2013  
 Estimated Water Depth:  
 Rig/Operator: ATV/J. Brandsen

Total Depth: 20.0 ft  
 Termination Criteria: Target Depth  
 Cone Size:

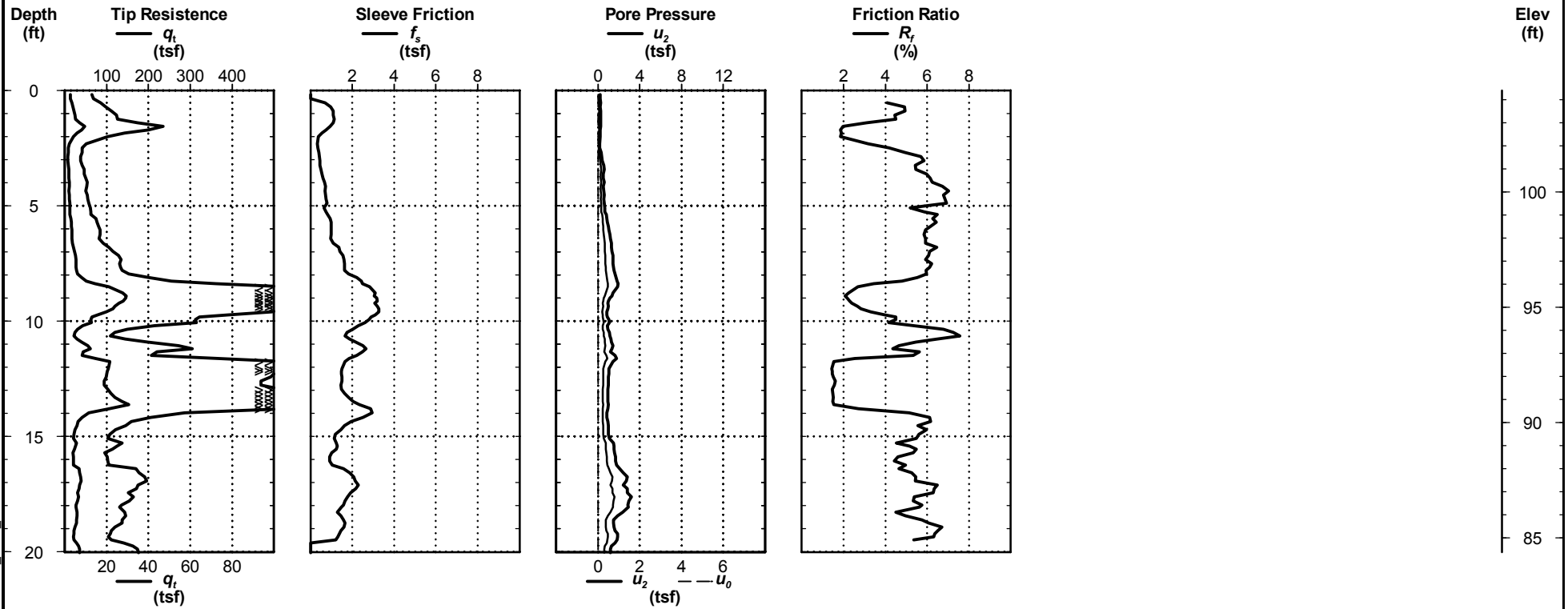

CPT REPORT - STANDARD R2582A\_GEO\_RDWY\_NORTHAMPTON\_CPT\_GINT.GPJ\_CPT\_V3.0.GDT 2/16/15

# C-111



# Cone Penetration Test

# C-112

Date: Apr. 3, 2013  
 Estimated Water Depth:  
 Rig/Operator: ATV/J. Brandsen

Total Depth: 10.4 ft  
 Termination Criteria: Target Depth  
 Cone Size:

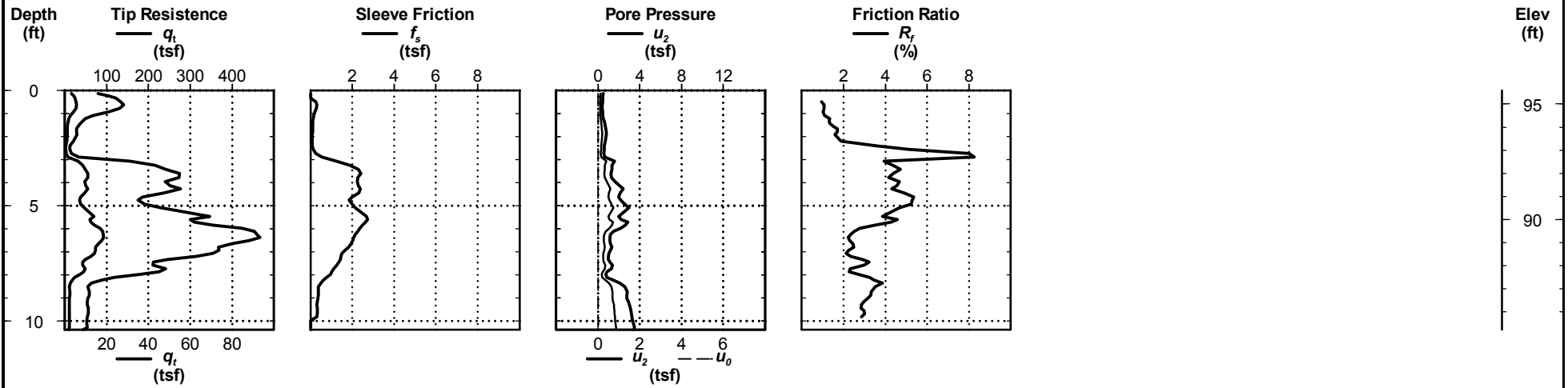

CPT REPORT - STANDARD R2582A\_GEO\_RDWY\_NORTHAMPTON\_CPT\_GINT.GPJ\_CPT\_V3.0.GDT 2/16/15

# C-112



# Cone Penetration Test

# C-113

Date: Apr. 10, 2013  
 Estimated Water Depth:  
 Rig/Operator: ATV/J. Brandsen

Total Depth: 8.7 ft  
 Termination Criteria: Target Depth  
 Cone Size:

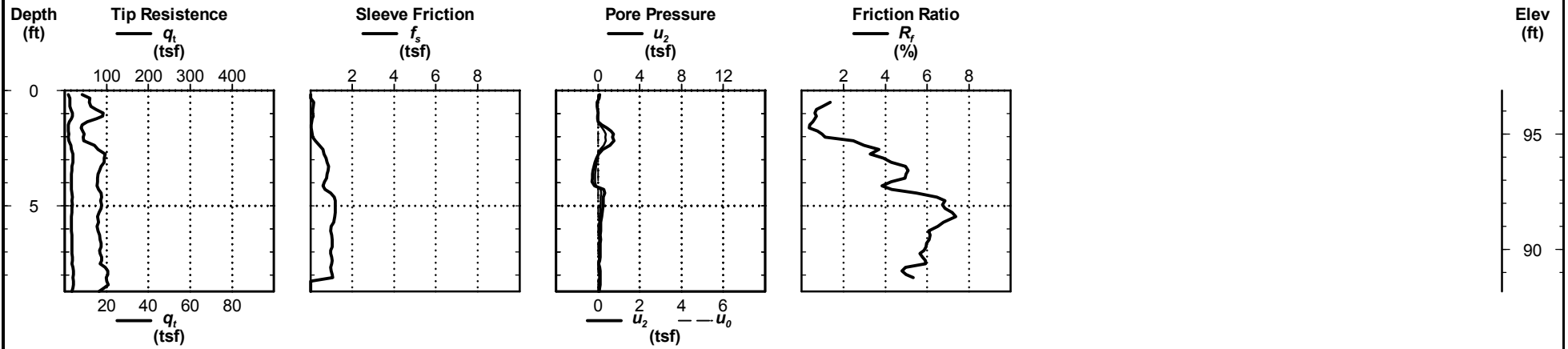

CPT REPORT - STANDARD R2582A\_GEO\_RDWY\_NORTHAMPTON\_CPT\_GINT.GPJ\_CPT\_V3.0.GDT 2/16/15

# C-113



# Cone Penetration Test

# C-114

Date: Apr. 10, 2013  
 Estimated Water Depth:  
 Rig/Operator: ATV/J. Brandsen

Total Depth: 7.9 ft  
 Termination Criteria: Target Depth  
 Cone Size:

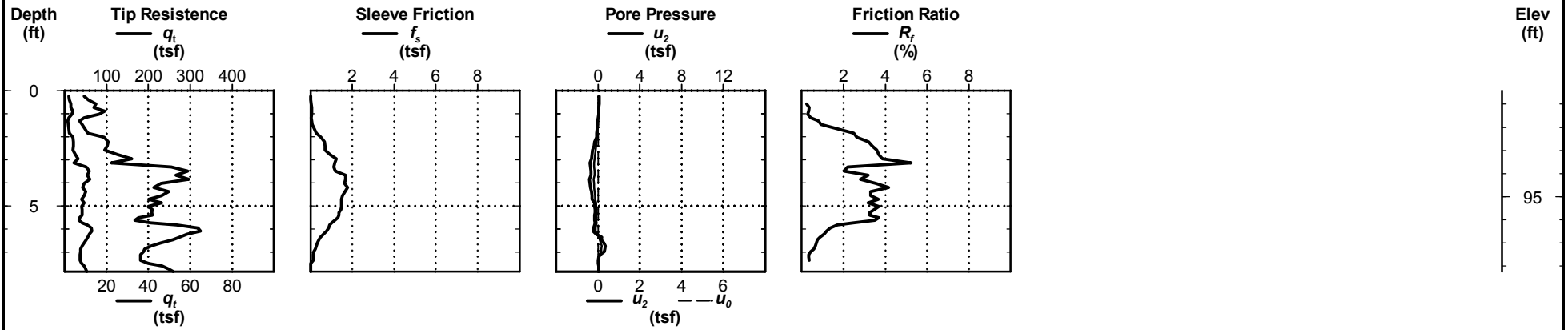

# C-114



# Cone Penetration Test

# C-115

Date: Apr. 10, 2013  
 Estimated Water Depth:  
 Rig/Operator: ATV/J. Brandsen

Total Depth: 22.0 ft  
 Termination Criteria: Target Depth  
 Cone Size:

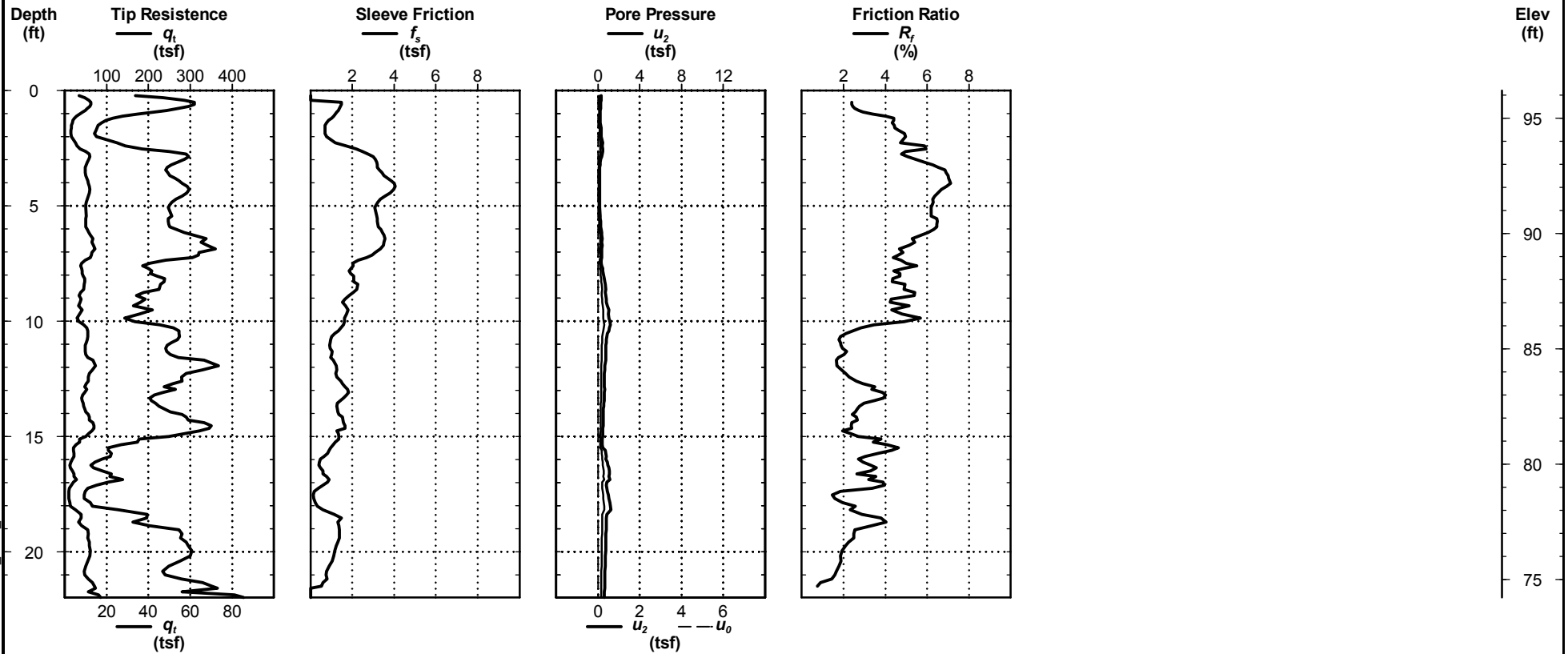

CPT REPORT - STANDARD R2582A\_GEO\_RDWY\_NORTHAMPTON\_CPT\_GINT.GPJ\_CPT V3.0.GDT 2/16/15

# C-115



# Cone Penetration Test

# C-116

Date: Apr. 3, 2013  
 Estimated Water Depth:  
 Rig/Operator: ATV/J. Brandsen

Total Depth: 17.9 ft  
 Termination Criteria: Target Depth  
 Cone Size:

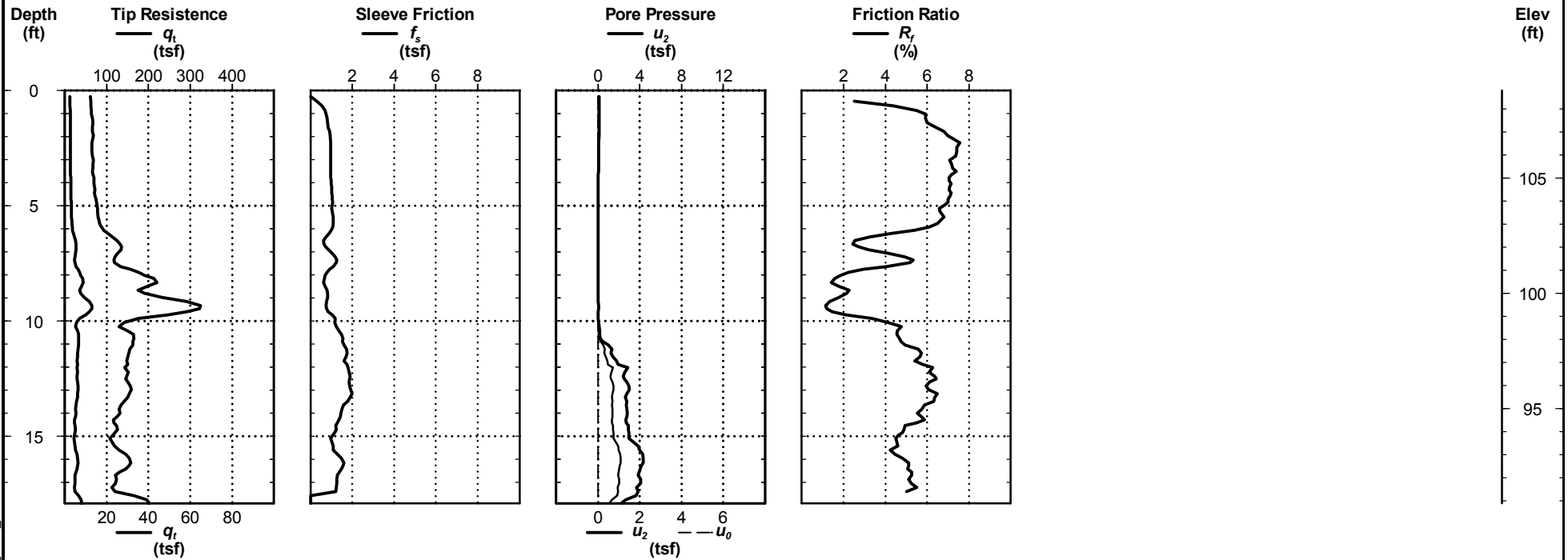

CPT REPORT - STANDARD R2582A\_GEO\_RDWY\_NORTHAMPTON\_CPT\_GINT.GPJ\_CPT V3.0.GDT 2/16/15

# C-116





# Cone Penetration Test

# C-117

Date: Apr. 3, 2013  
 Estimated Water Depth:  
 Rig/Operator: ATV/J. Brandsen

Total Depth: 12.0 ft  
 Termination Criteria: Target Depth  
 Cone Size:

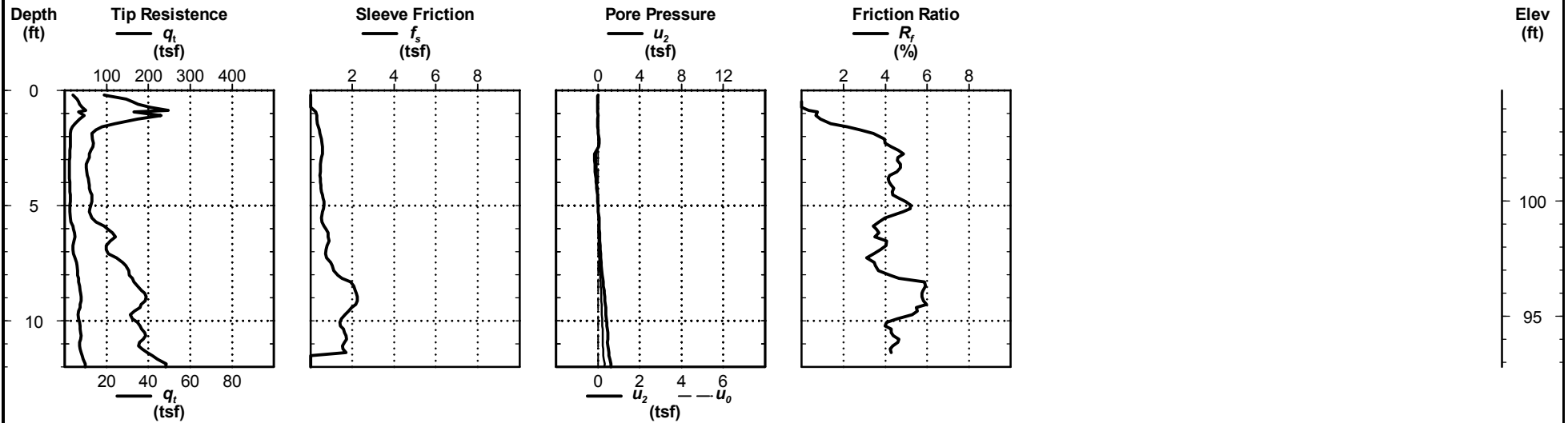

CPT REPORT - STANDARD R2582A\_GEO\_RDWY\_NORTHAMPTON\_CPT\_GINT.GPJ\_CPT\_V3.0.GDT 2/16/15

# C-117



# Cone Penetration Test

# C-118

Date: Apr. 10, 2013  
 Estimated Water Depth:  
 Rig/Operator: ATV/J. Brandsen

Total Depth: 9.0 ft  
 Termination Criteria: Target Depth  
 Cone Size:

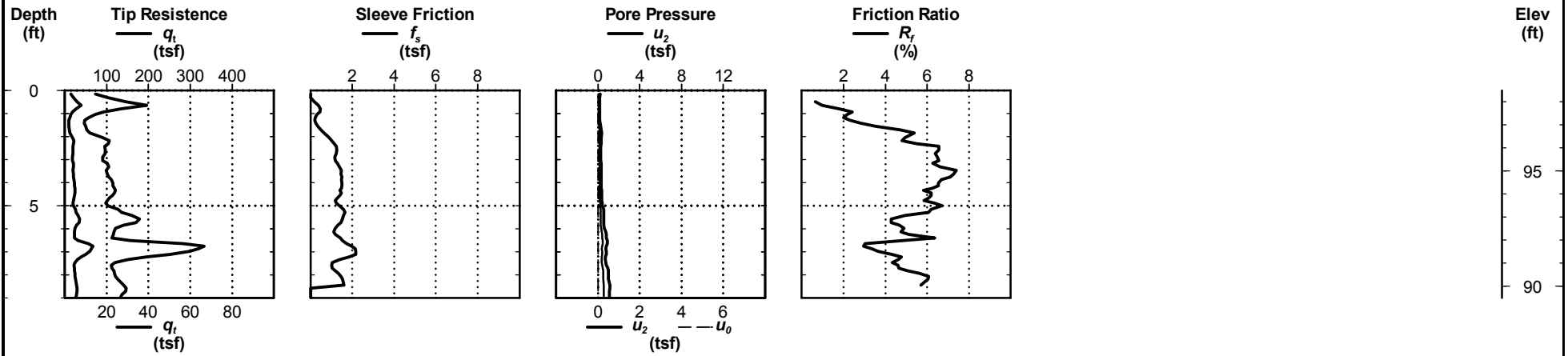

CPT REPORT - STANDARD R2582A\_GEO\_RDWY\_NORTHAMPTON\_CPT\_GINT.GPJ\_CPT\_V3.0.GDT 2/16/15

# C-118



# Cone Penetration Test

# C-119

Date: Apr. 10, 2013  
 Estimated Water Depth:  
 Rig/Operator: ATV/J. Brandsen

Total Depth: 9.1 ft  
 Termination Criteria: Target Depth  
 Cone Size:

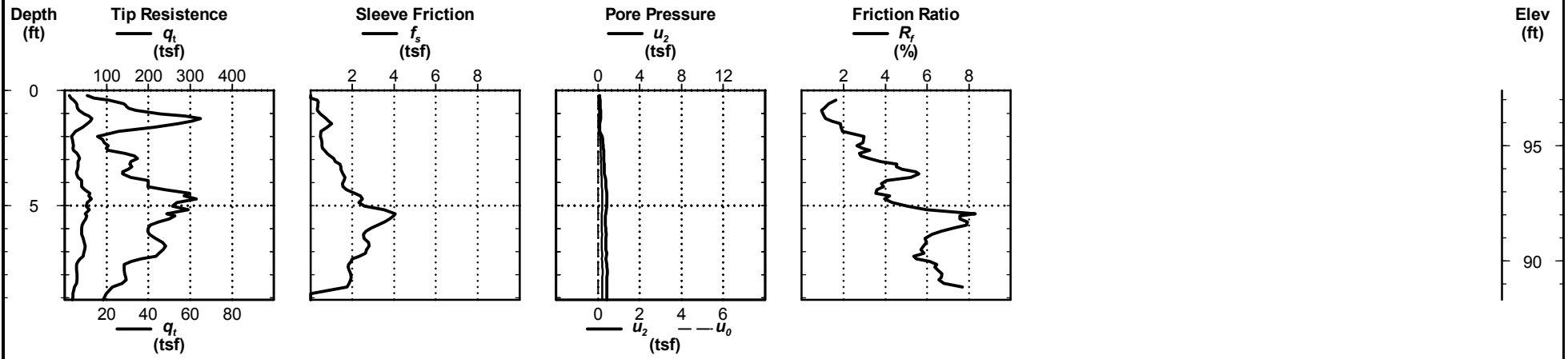

CPT REPORT - STANDARD R2582A\_GEO\_RDWY\_NORTHAMPTON\_CPT\_GINT.GPJ\_CPT\_V3.0.GDT 2/16/15

# C-119



# Cone Penetration Test

## C-120

Date: Apr. 3, 2013  
 Estimated Water Depth:  
 Rig/Operator: ATV/J. Brandsen

Total Depth: 9.0 ft  
 Termination Criteria: Target Depth  
 Cone Size:

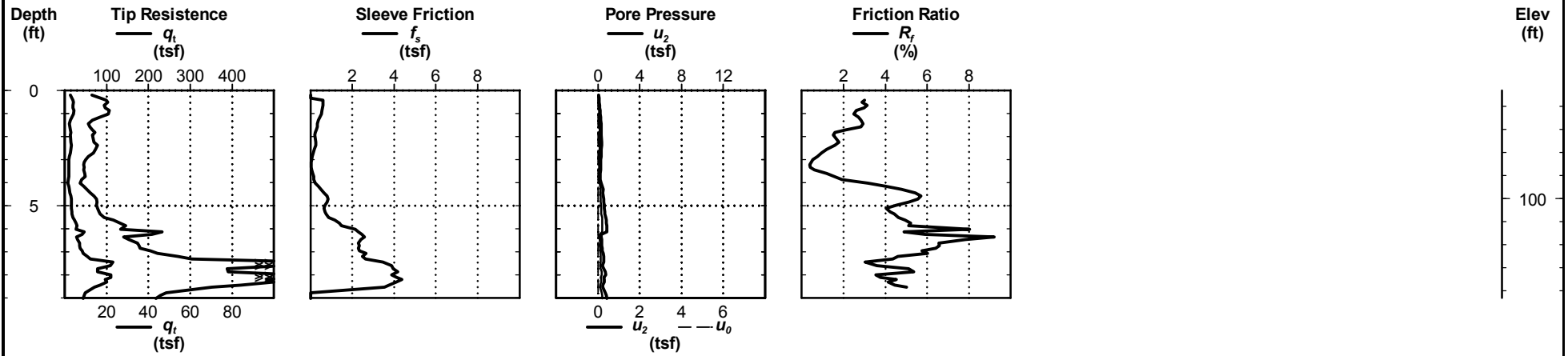

CPT REPORT - STANDARD R2582A\_GEO\_RDWY\_NORTHAMPTON\_CPT\_GINT.GPJ\_CPT\_V3.0.GDT 2/16/15

## C-120



# Cone Penetration Test

# C-121

Date: Apr. 10, 2013  
 Estimated Water Depth:  
 Rig/Operator: ATV/J. Brandsen

Total Depth: 37.9 ft  
 Termination Criteria: Target Depth  
 Cone Size:

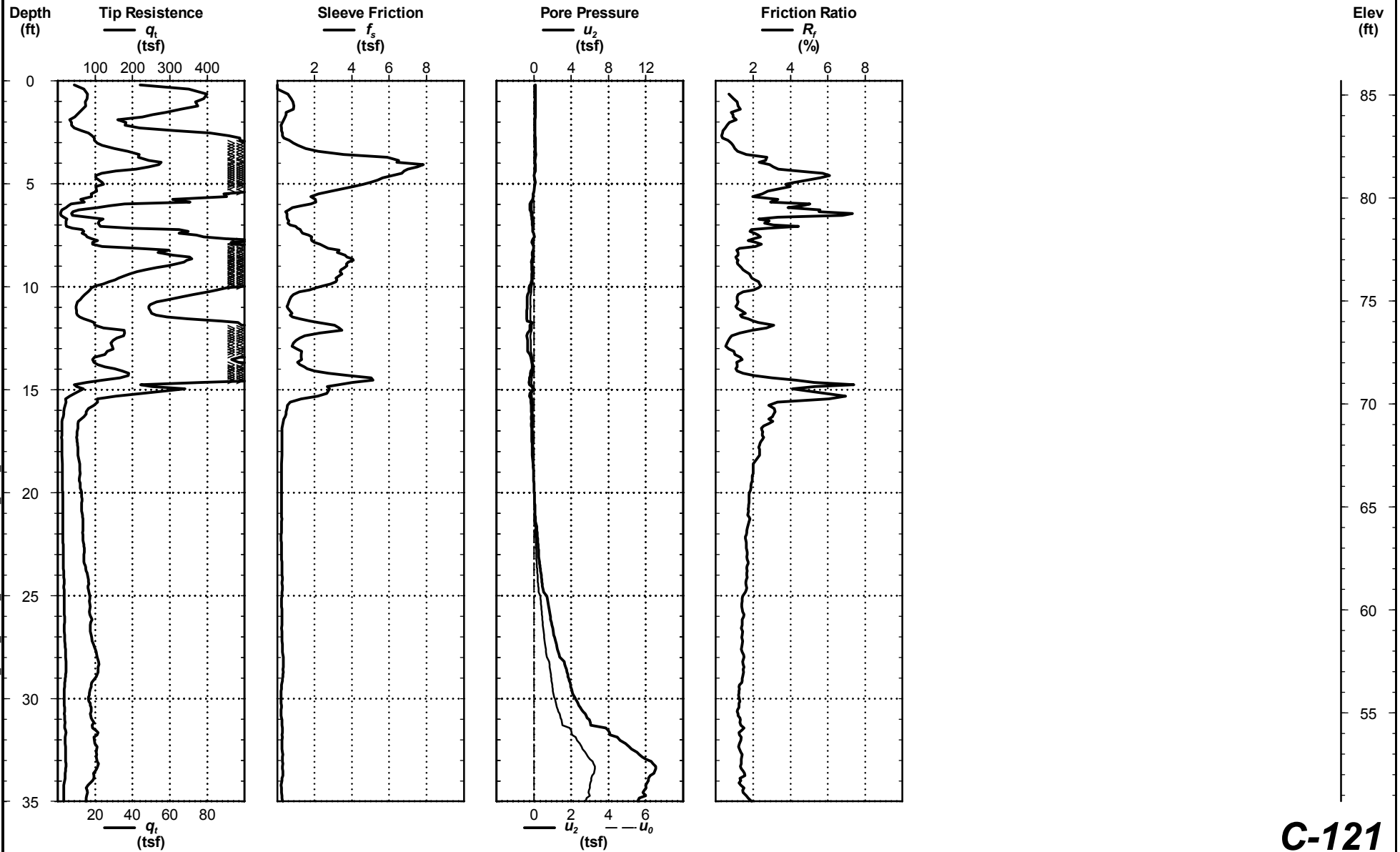

CPT REPORT - STANDARD R2582A GEO\_RDWY\_NORTHAMPTON\_CPT\_GINT.GPJ\_CPT\_V3.0.GDT 2/16/15

# C-121



# Cone Penetration Test

# C-121

Date: Apr. 10, 2013  
 Estimated Water Depth:  
 Rig/Operator: ATV/J. Brandsen

Total Depth: 37.9 ft  
 Termination Criteria: Target Depth  
 Cone Size:

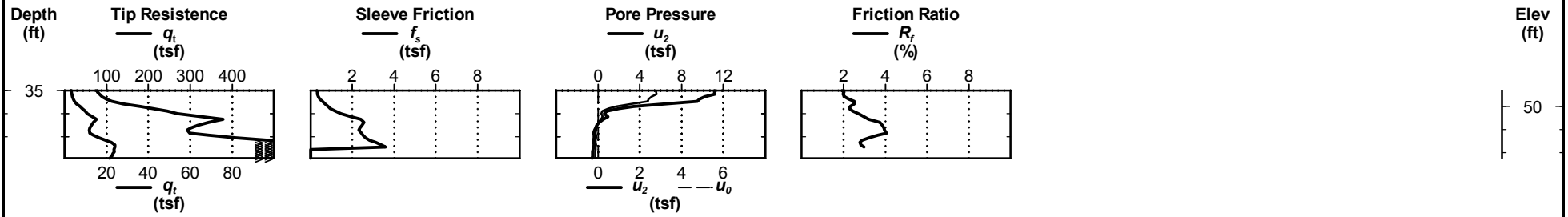

# C-121



# Cone Penetration Test

# C-122

Date: Apr. 3, 2013  
 Estimated Water Depth:  
 Rig/Operator: ATV/J. Brandsen

Total Depth: 8.1 ft  
 Termination Criteria: Target Depth  
 Cone Size:

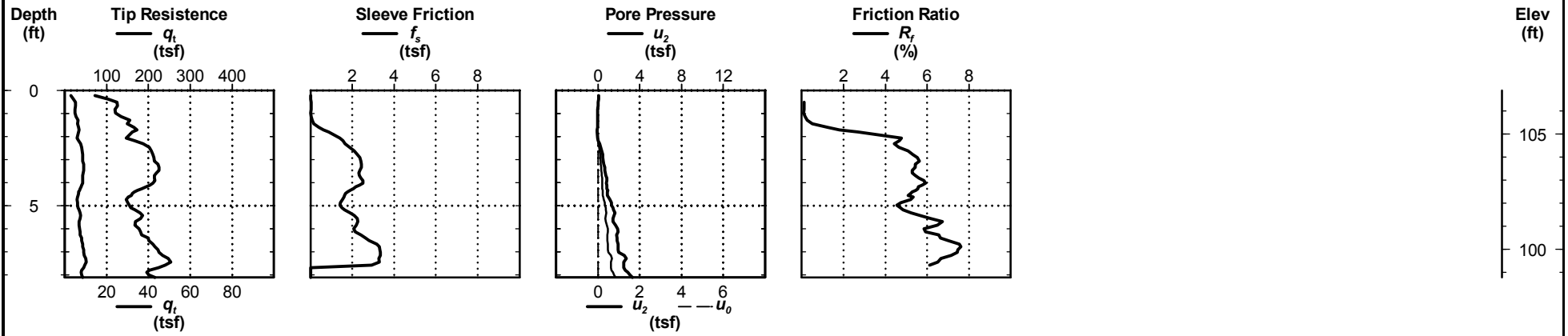

CPT REPORT - STANDARD R2582A\_GEO\_RDWY\_NORTHAMPTON\_CPT\_GINT.GPJ\_CPT\_V3.0.GDT 2/16/15

# C-122



# Cone Penetration Test

# C-123

Date: Apr. 3, 2013  
 Estimated Water Depth:  
 Rig/Operator: ATV/J. Brandsen

Total Depth: 14.2 ft  
 Termination Criteria: Target Depth  
 Cone Size:

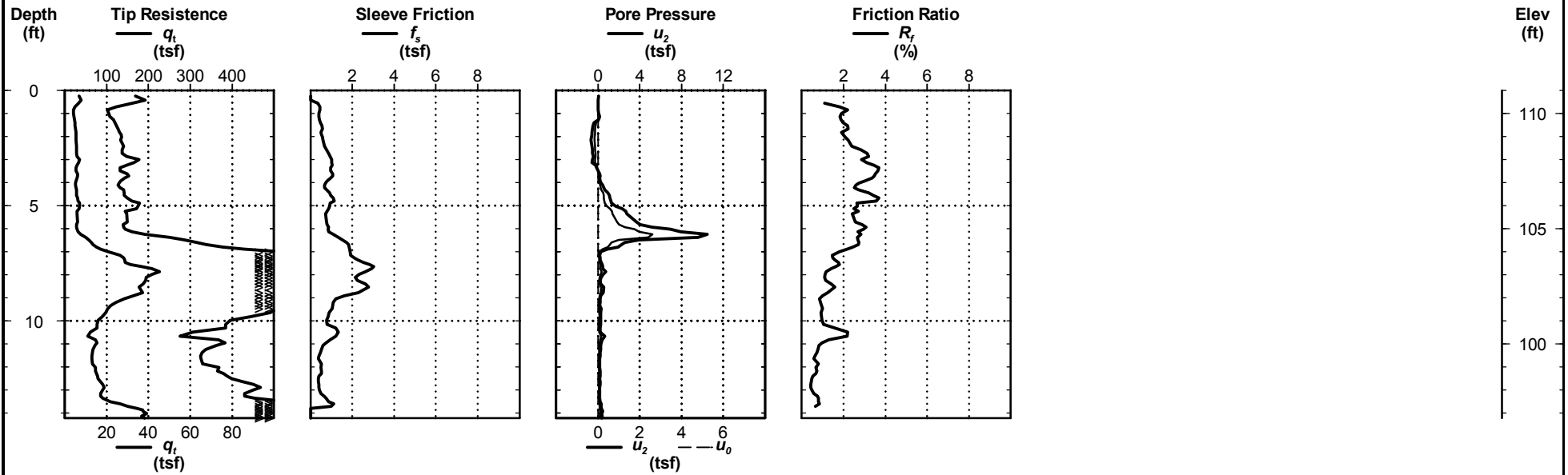

CPT REPORT - STANDARD R2582A\_GEO\_RDWY\_NORTHAMPTON\_CPT\_GINT.GPJ\_CPT\_V3.0.GDT 2/16/15

# C-123





# Cone Penetration Test

# C-124

Date: Apr. 3, 2013  
 Estimated Water Depth:  
 Rig/Operator: ATV/J. Brandsen

Total Depth: 14.1 ft  
 Termination Criteria: Target Depth  
 Cone Size:

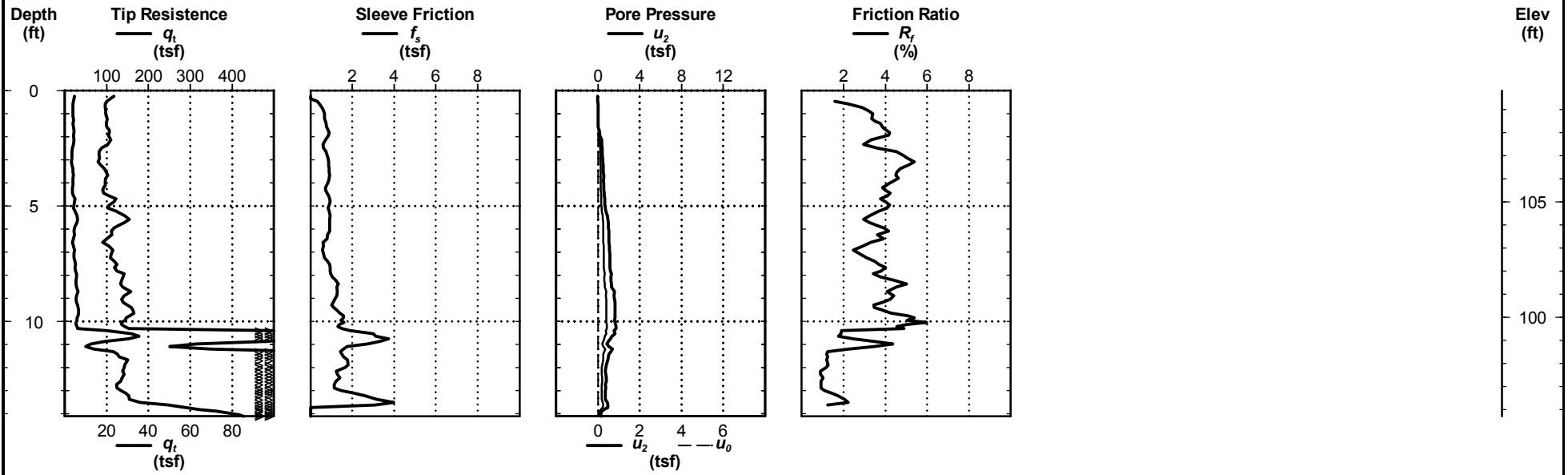

CPT REPORT - STANDARD R2582A\_GEO\_RDWY\_NORTHAMPTON\_CPT\_GINT.GPJ\_CPT\_V3.0.GDT 2/16/15

# C-124



# Cone Penetration Test

## C-125

Date: Apr. 3, 2013  
 Estimated Water Depth:  
 Rig/Operator: ATV/J. Brandsen

Total Depth: 7.9 ft  
 Termination Criteria: Target Depth  
 Cone Size:

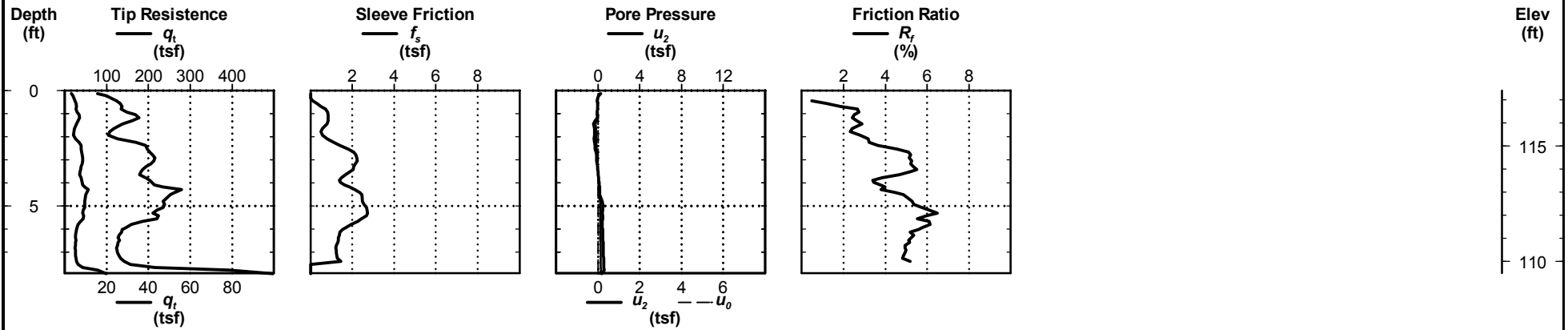

## C-125



# Cone Penetration Test

## C-126

Date: Apr. 3, 2013  
 Estimated Water Depth:  
 Rig/Operator: ATV/J. Brandsen

Total Depth: 9.1 ft  
 Termination Criteria: Target Depth  
 Cone Size:

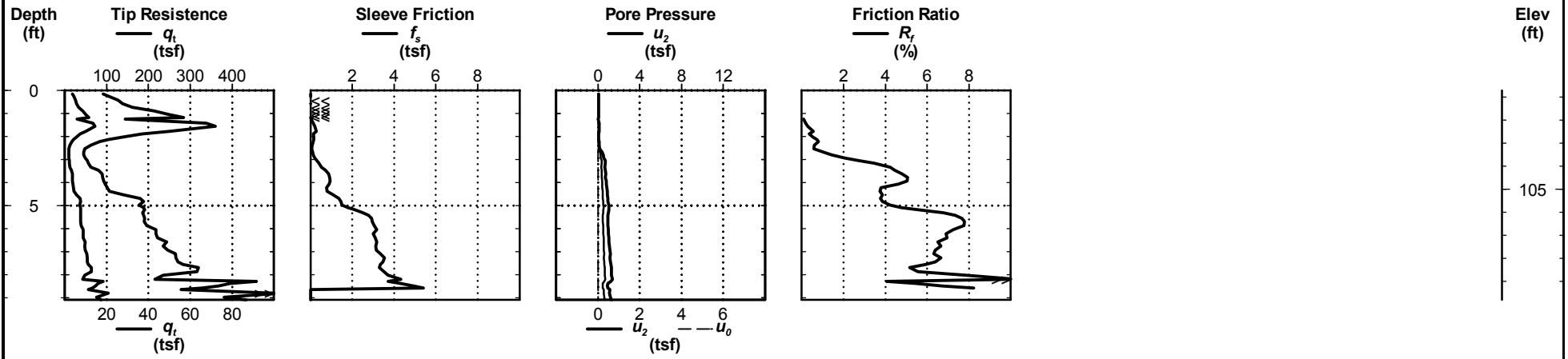

## C-126



# Cone Penetration Test

# C-127

Date: Apr. 3, 2013  
 Estimated Water Depth:  
 Rig/Operator: ATV/J. Brandsen

Total Depth: 8.0 ft  
 Termination Criteria: Target Depth  
 Cone Size:

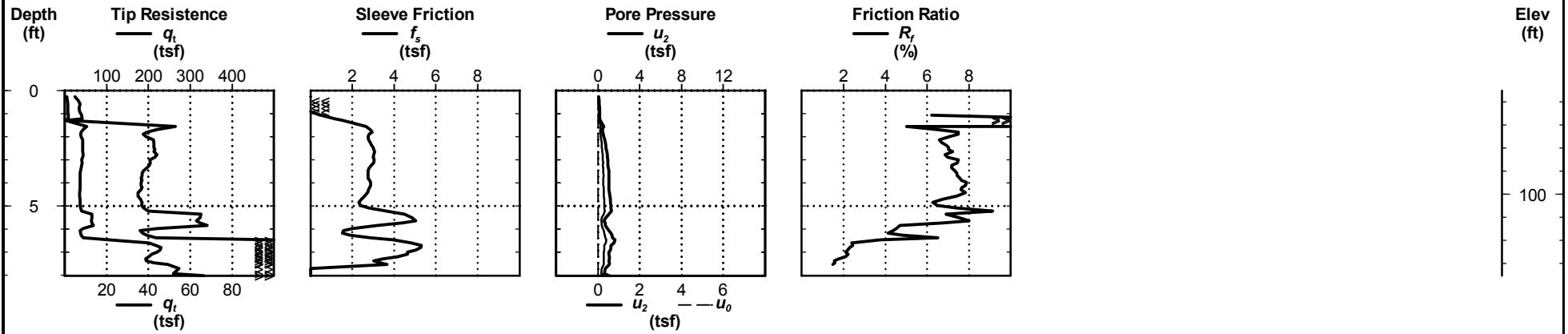

CPT REPORT - STANDARD R2582A\_GEO\_RDWY\_NORTHAMPTON\_CPT\_GINT.GPJ\_CPT\_V3.0.GDT 2/16/15

# C-127



# Cone Penetration Test

# C-128

Date: Apr. 4, 2013  
 Estimated Water Depth:  
 Rig/Operator: ATV/J. Brandsen

Total Depth: 8.1 ft  
 Termination Criteria: Target Depth  
 Cone Size:

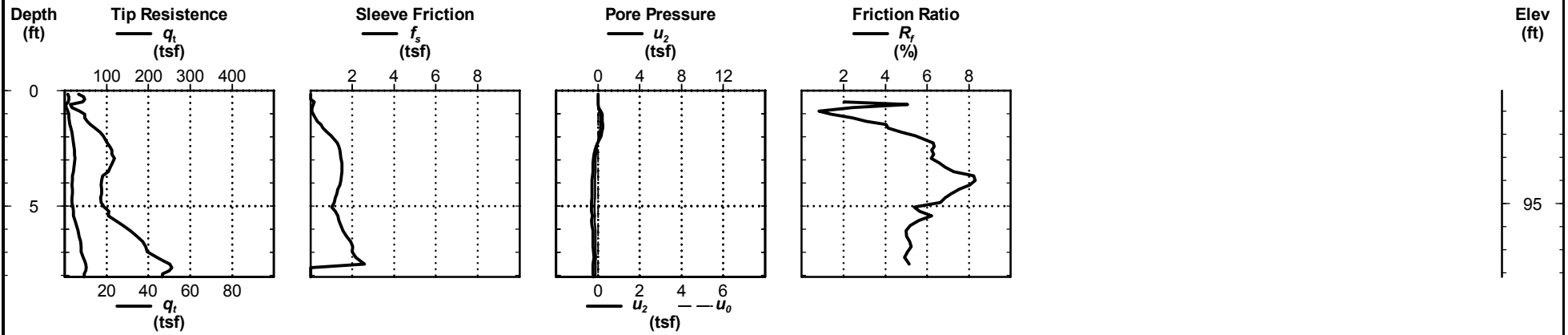

CPT REPORT - STANDARD R2582A\_GEO\_RDWY\_NORTHAMPTON\_CPT\_GINT.GPJ\_CPT\_V3.0.GDT 2/16/15

# C-128



# Cone Penetration Test

## C-129

Date: Apr. 4, 2013  
 Estimated Water Depth:  
 Rig/Operator: ATV/J. Brandsen

Total Depth: 8.3 ft  
 Termination Criteria: Target Depth  
 Cone Size:

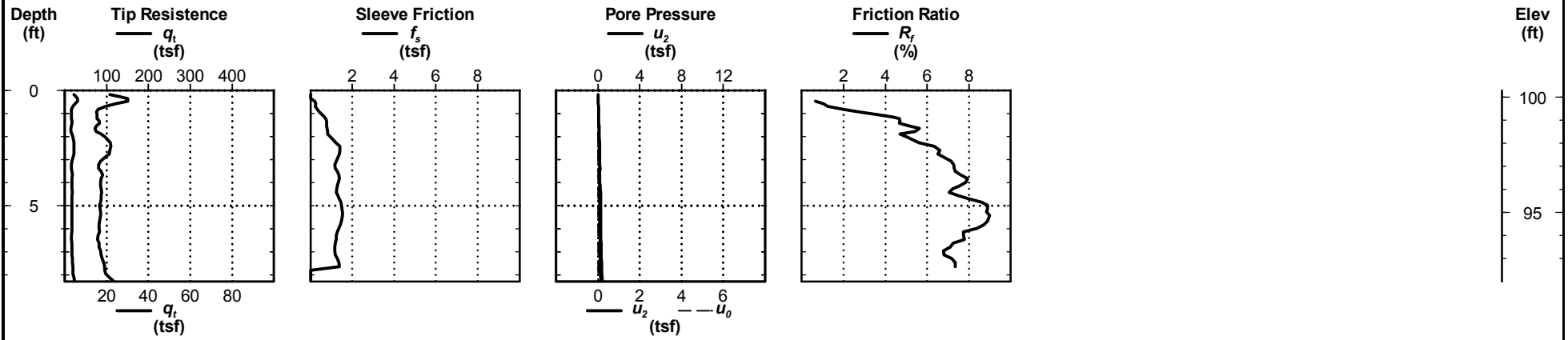

CPT REPORT - STANDARD R2582A\_GEO\_RDWY\_NORTHAMPTON\_CPT\_GINT.GPJ\_CPT V3.0.GDT 2/16/15

## C-129



# Cone Penetration Test

## C-130

Date: Apr. 4, 2013  
 Estimated Water Depth:  
 Rig/Operator: ATV/J. Brandsen

Total Depth: 8.0 ft  
 Termination Criteria: Target Depth  
 Cone Size:

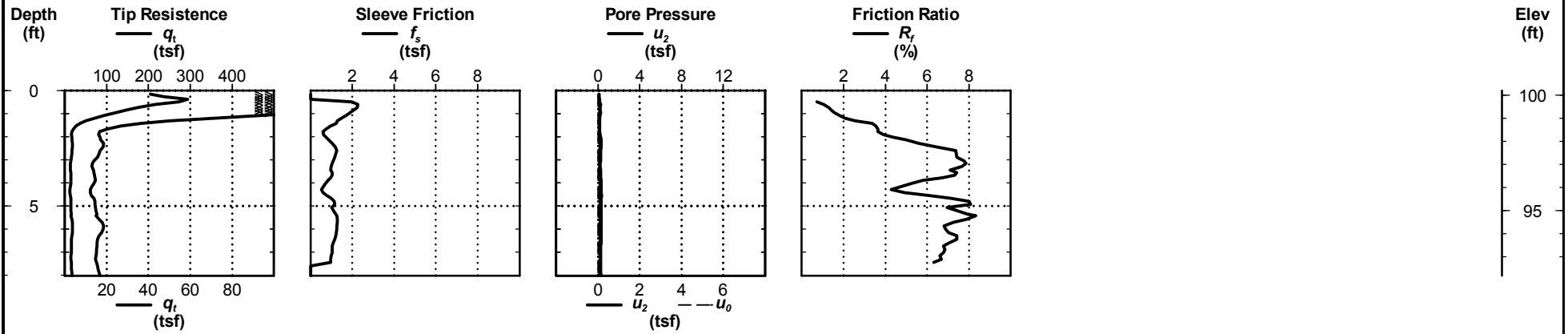

CPT REPORT - STANDARD R2582A\_GEO\_RDWY\_NORTHAMPTON\_CPT\_GINT.GPJ\_CPT\_V3.0.GDT 2/16/15

## C-130



# Cone Penetration Test

# C-131

Date: Apr. 4, 2013  
 Estimated Water Depth:  
 Rig/Operator: ATV/J. Brandsen

Total Depth: 8.0 ft  
 Termination Criteria: Target Depth  
 Cone Size:

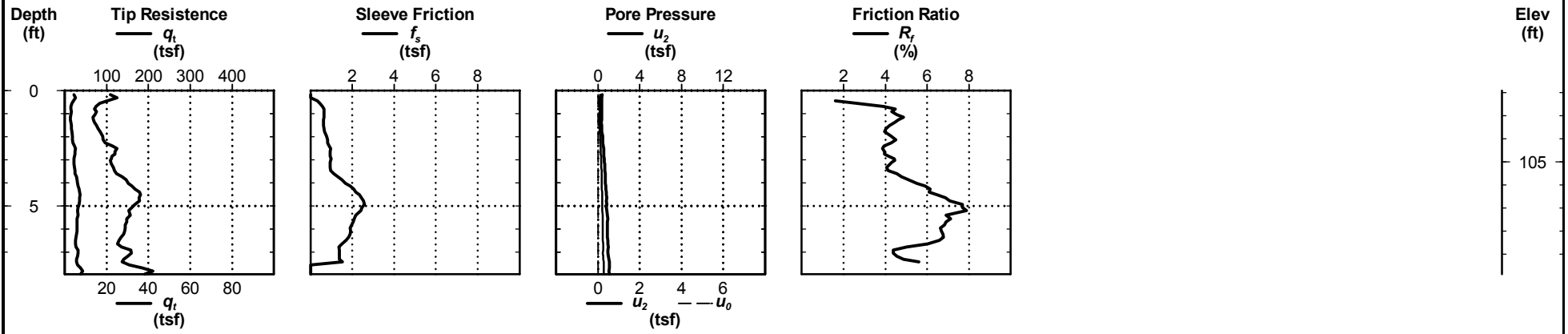

CPT REPORT - STANDARD R2582A\_GEO\_RDWY\_NORTHAMPTON\_CPT\_GINT.GPJ\_CPT\_V3.0.GDT 2/16/15

# C-131





# Cone Penetration Test

# C-132

Date: Apr. 9, 2013  
 Estimated Water Depth:  
 Rig/Operator: ATV/J. Brandsen

Total Depth: 14.9 ft  
 Termination Criteria: Target Depth  
 Cone Size:

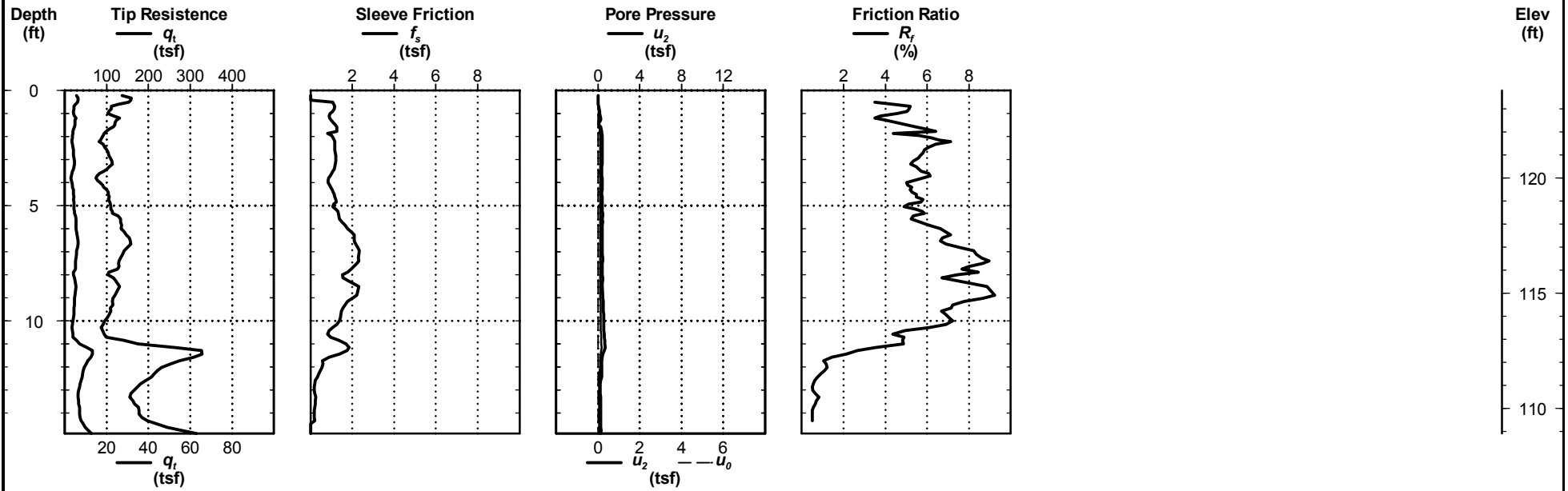

CPT REPORT - STANDARD R2582A\_GEO\_RDWY\_NORTHAMPTON\_CPT\_GINT.GPJ\_CPT\_V3.0.GDT 2/16/15

# C-132



# Cone Penetration Test

## C-133

Date: Apr. 9, 2013  
 Estimated Water Depth:  
 Rig/Operator: ATV/J. Brandsen

Total Depth: 9.2 ft  
 Termination Criteria: Target Depth  
 Cone Size:

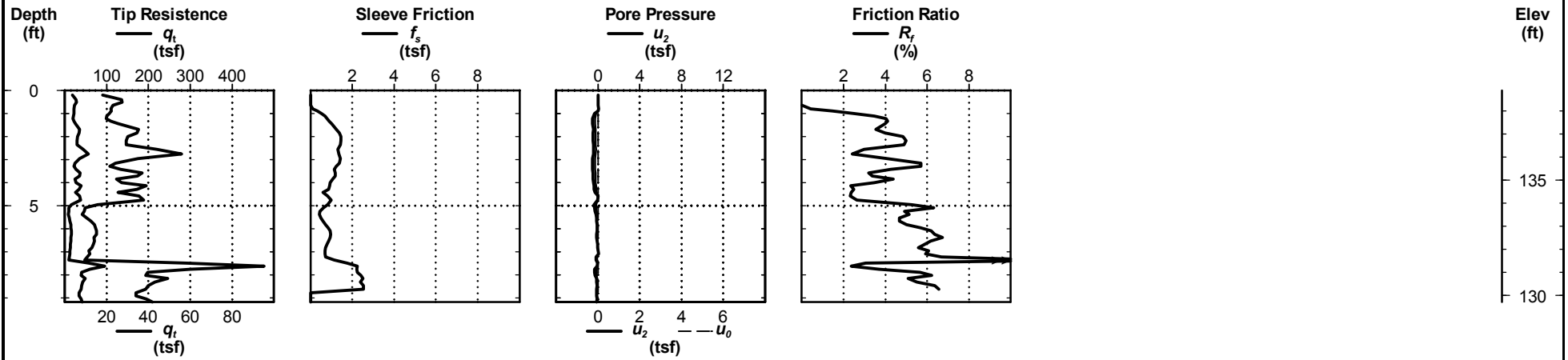

CPT REPORT - STANDARD R2582A\_GEO\_RDWY\_NORTHAMPTON\_CPT\_GINT.GPJ\_CPT\_V3.0.GDT 2/16/15

## C-133



# Cone Penetration Test

# C-134

Date: Apr. 9, 2013  
 Estimated Water Depth:  
 Rig/Operator: ATV/J. Brandsen

Total Depth: 10.1 ft  
 Termination Criteria: Target Depth  
 Cone Size:

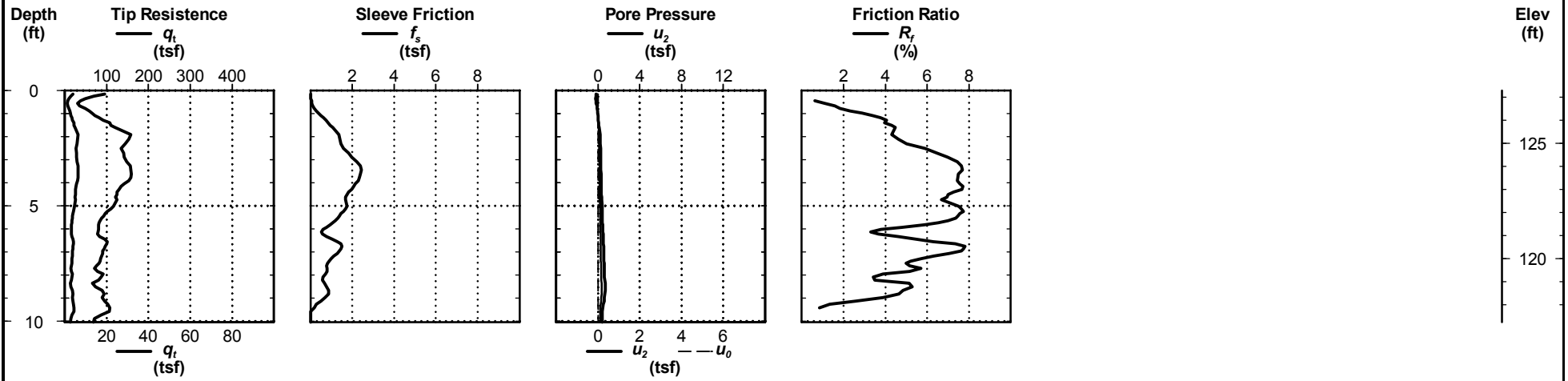

CPT REPORT - STANDARD R2582A\_GEO\_RDWY\_NORTHAMPTON\_CPT\_GINT.GPJ\_CPT\_V3.0.GDT 2/16/15

# C-134