

**This electronic collection of documents is provided
for the convenience of the user
and is Not a Certified Document –**

**The documents contained herein were originally issued
and sealed by the individuals whose names and license
numbers appear on each page, on the dates appearing
with their signature on that page.**

**This file or an individual page
shall not be considered a certified document.**

6/23/16



PROJ. REFERENCE NO.
R-1015

SHEET NO.
X-320

150 140 130 120 110 100 90 80 70 60 50 40 30 20 10 0 10 20 30 40 50 60 70 80 90 100 110 120 130 140 150

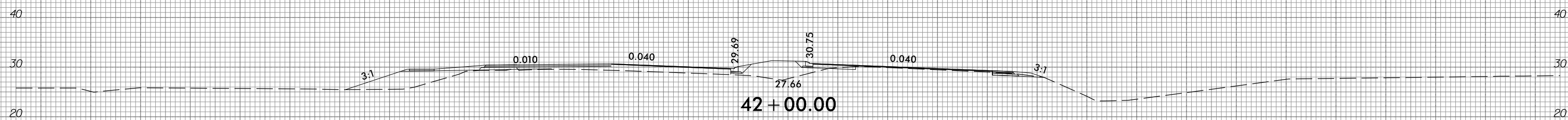
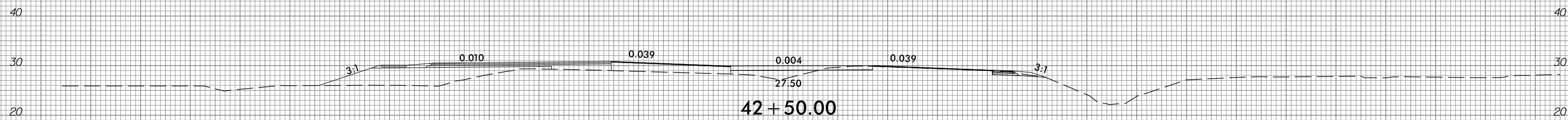
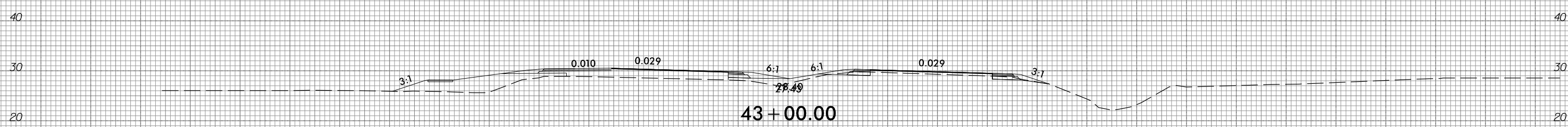
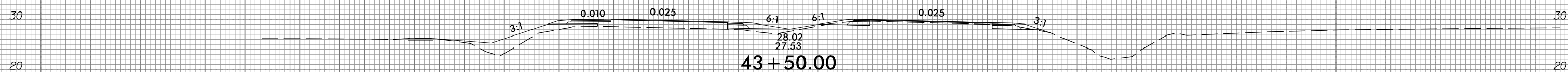
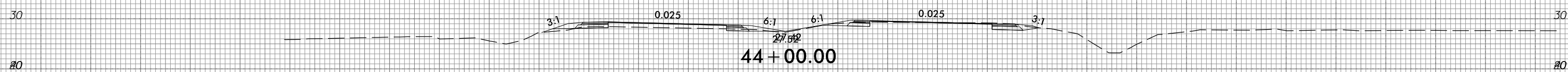
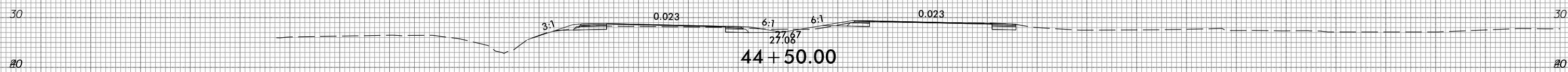
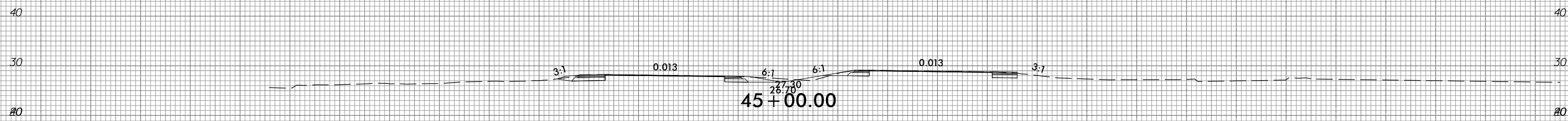

-RPIAB-

150 140 130 120 110 100 90 80 70 60 50 40 30 20 10 0 10 20 30 40 50 60 70 80 90 100 110 120 130 140 150

10/31/2016
G:\RA\9729-02\CADD\1015\Roadway\XSC\1015_xp1_RPIAB.dgn
gncdlin

6/23/16



| | |
|---------------------|-----------|
| PROJ. REFERENCE NO. | SHEET NO. |
| R-1015 | X-321 |

150 140 130 120 110 100 90 80 70 60 50 40 30 20 10 0 10 20 30 40 50 60 70 80 90 100 110 120 130 140 150

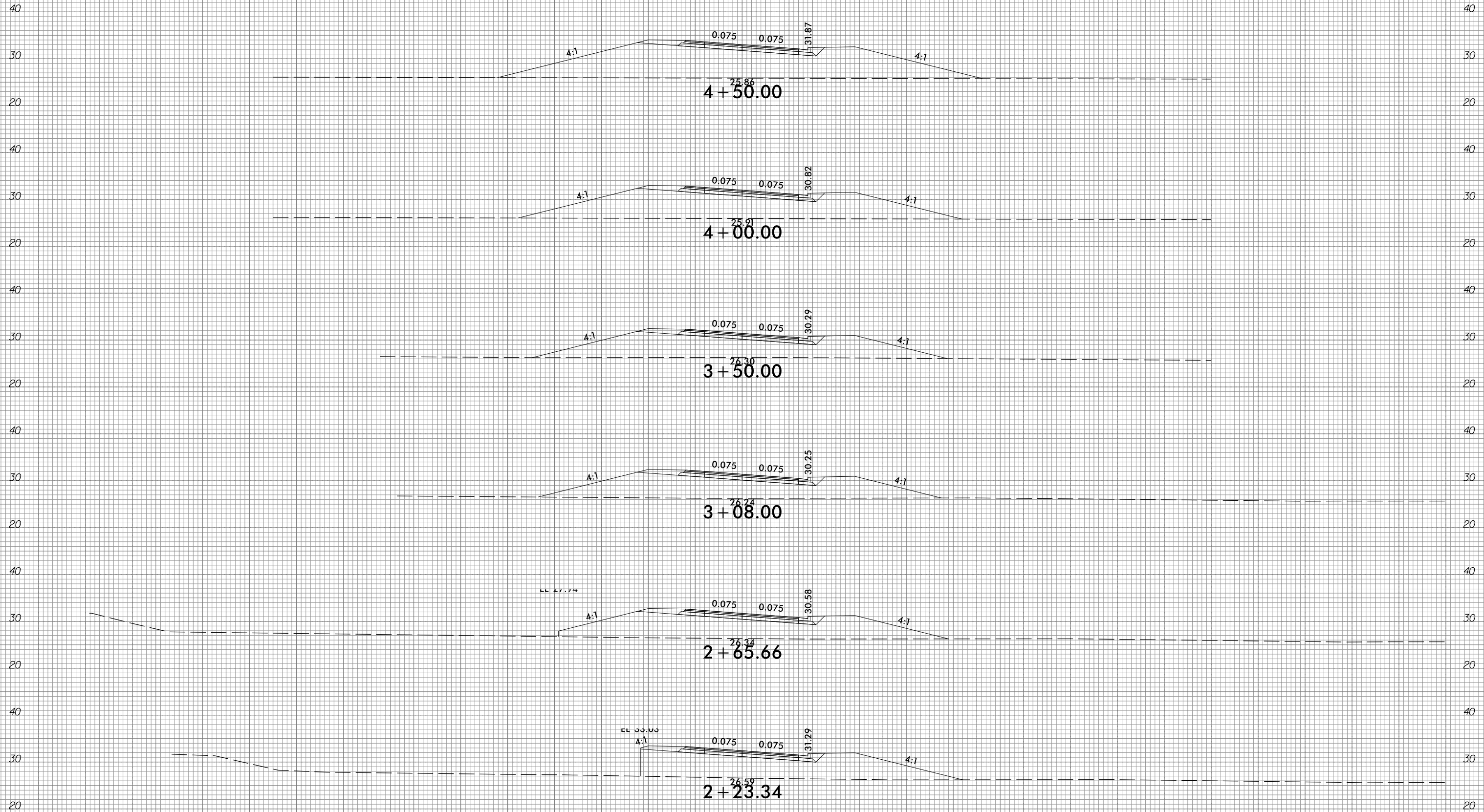

-LP1B-

150 140 130 120 110 100 90 80 70 60 50 40 30 20 10 0 10 20 30 40 50 60 70 80 90 100 110 120 130 140 150

10/31/2018
 G:\RA\1729-02\CADD\1015\Roadway\XSC\1015_xp1.LP1B.dgn
 gmc311n

6/23/16



PROJ. REFERENCE NO.
R-1015

SHEET NO.
X-322

150 140 130 120 110 100 90 80 70 60 50 40 30 20 10 0 10 20 30 40 50 60 70 80 90 100 110 120 130 140 150

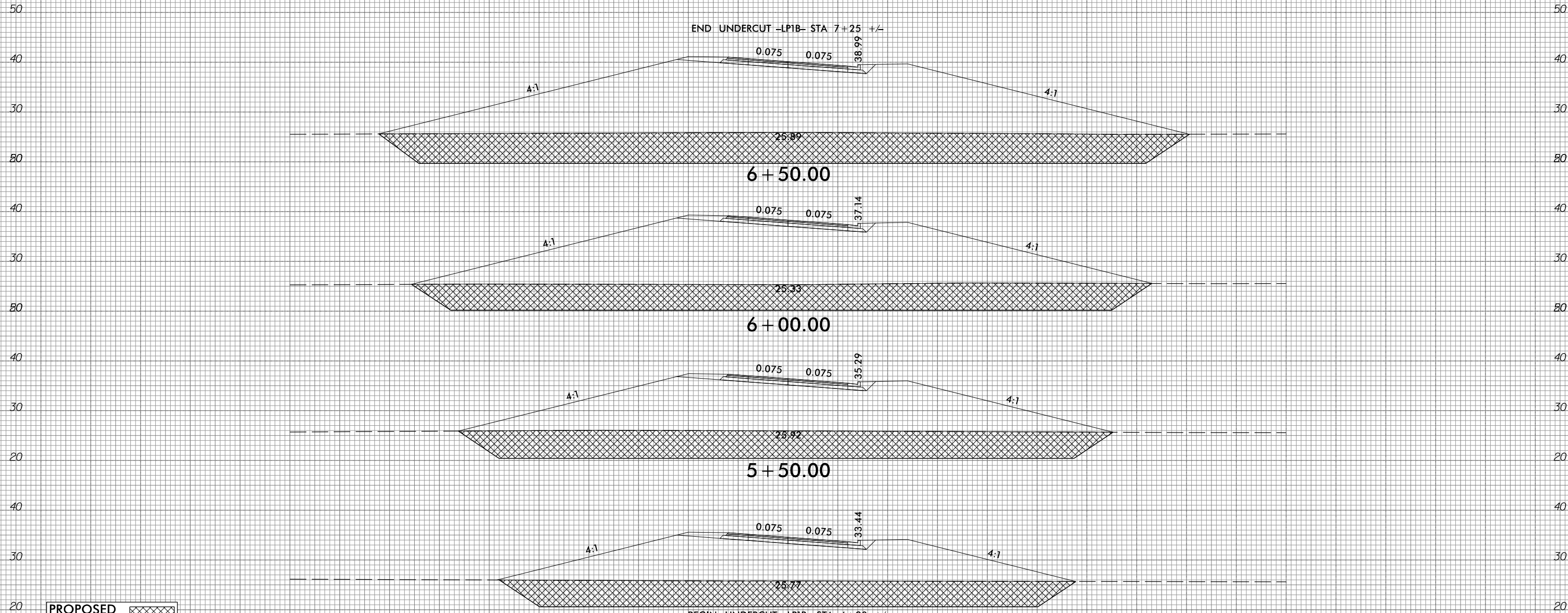

PROPOSED UNDERCUT

BEGIN UNDERCUT -LP1B- STA 4+90 +/-
-LP1B- 5+00.00

150 140 130 120 110 100 90 80 70 60 50 40 30 20 10 0 10 20 30 40 50 60 70 80 90 100 110 120 130 140 150

10/31/2016
G:\RA\9729-02\CADD\1015\Roadway\XSC\1015_xp1.LP1B.dgn
gmodlin

6/23/16



PROJ. REFERENCE NO.
R-1015

SHEET NO.
X-323

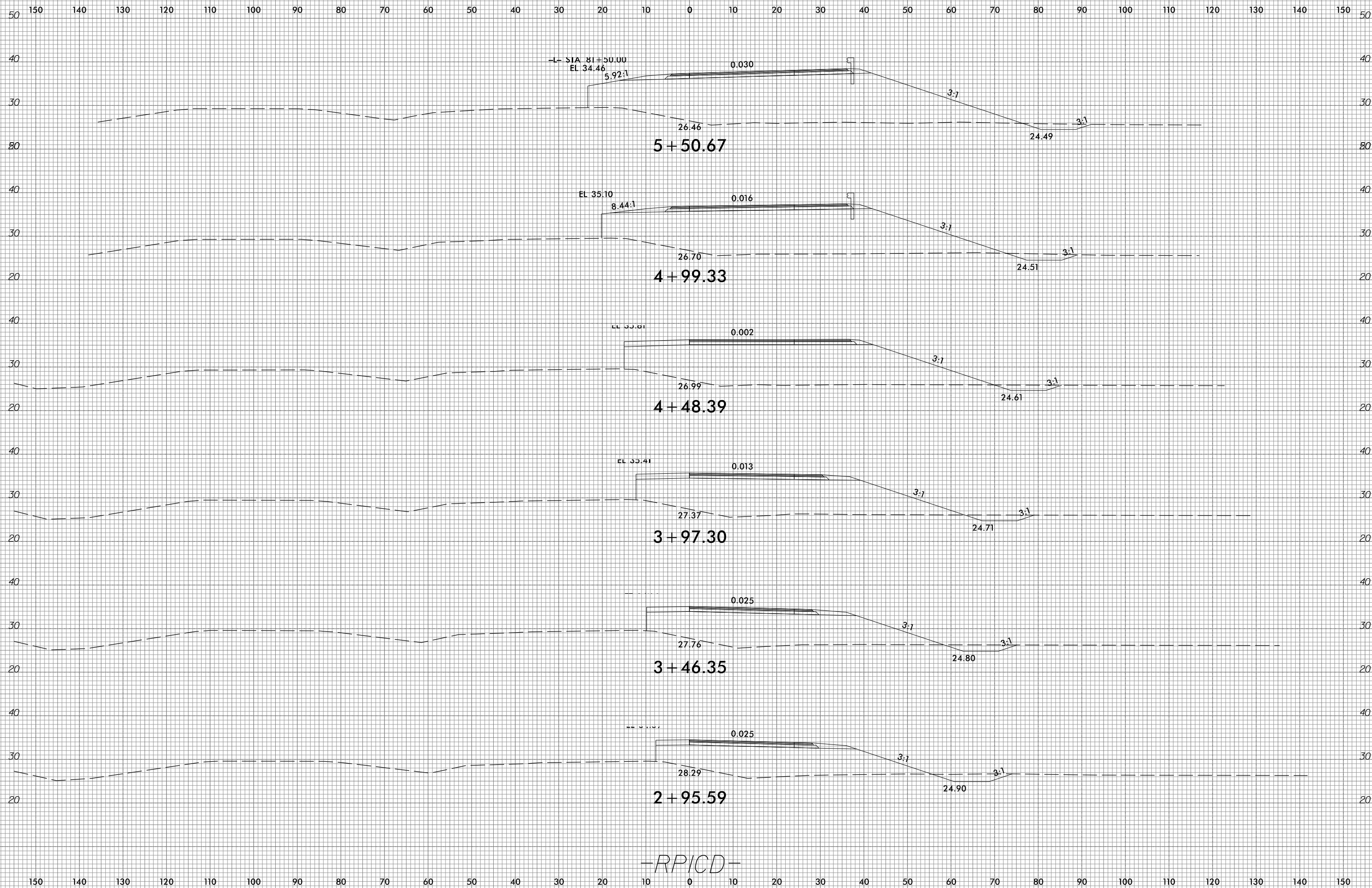

-RPICD-

10/31/2018
G:\RA\19729-02\CADD\1015\Roadway\XSC\1015_xp1_RPICD.dgn
gncdlin

6/23/16



PROJ. REFERENCE NO.
R-1015

SHEET NO.
X-324

150 140 130 120 110 100 90 80 70 60 50 40 30 20 10 0 10 20 30 40 50 60 70 80 90 100 110 120 130 140 150

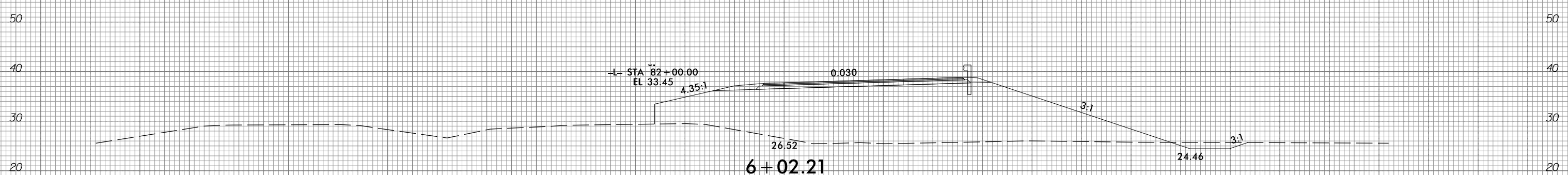
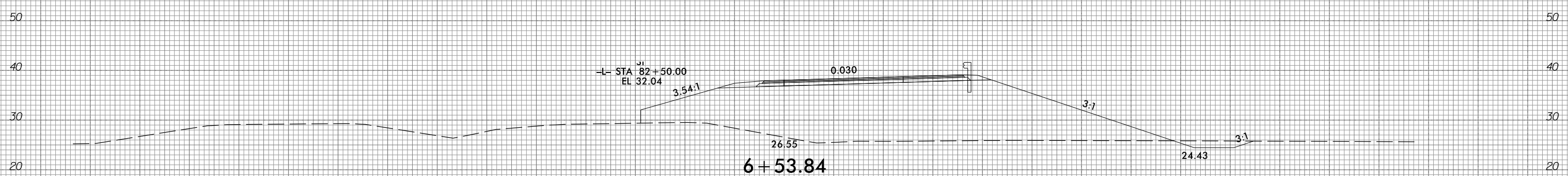
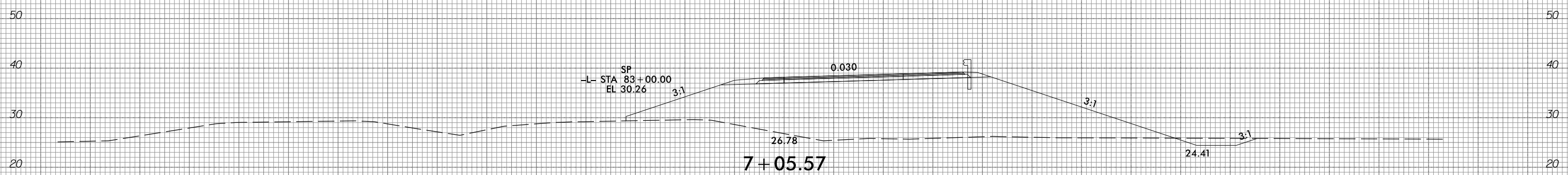
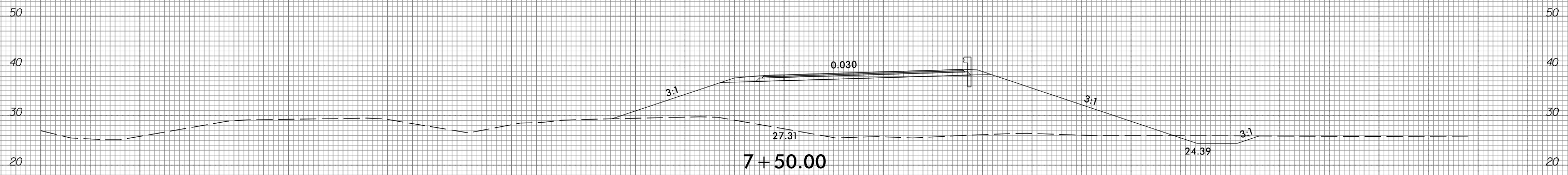

-RPICD-

150 140 130 120 110 100 90 80 70 60 50 40 30 20 10 0 10 20 30 40 50 60 70 80 90 100 110 120 130 140 150

10/31/2018
G:\RA\9729-02\CADD\1015\Roadway\XSC\1015_xp1_RPICD.dgn
gncdlin

6/23/16



PROJ. REFERENCE NO.
R-1015

SHEET NO.
X-325

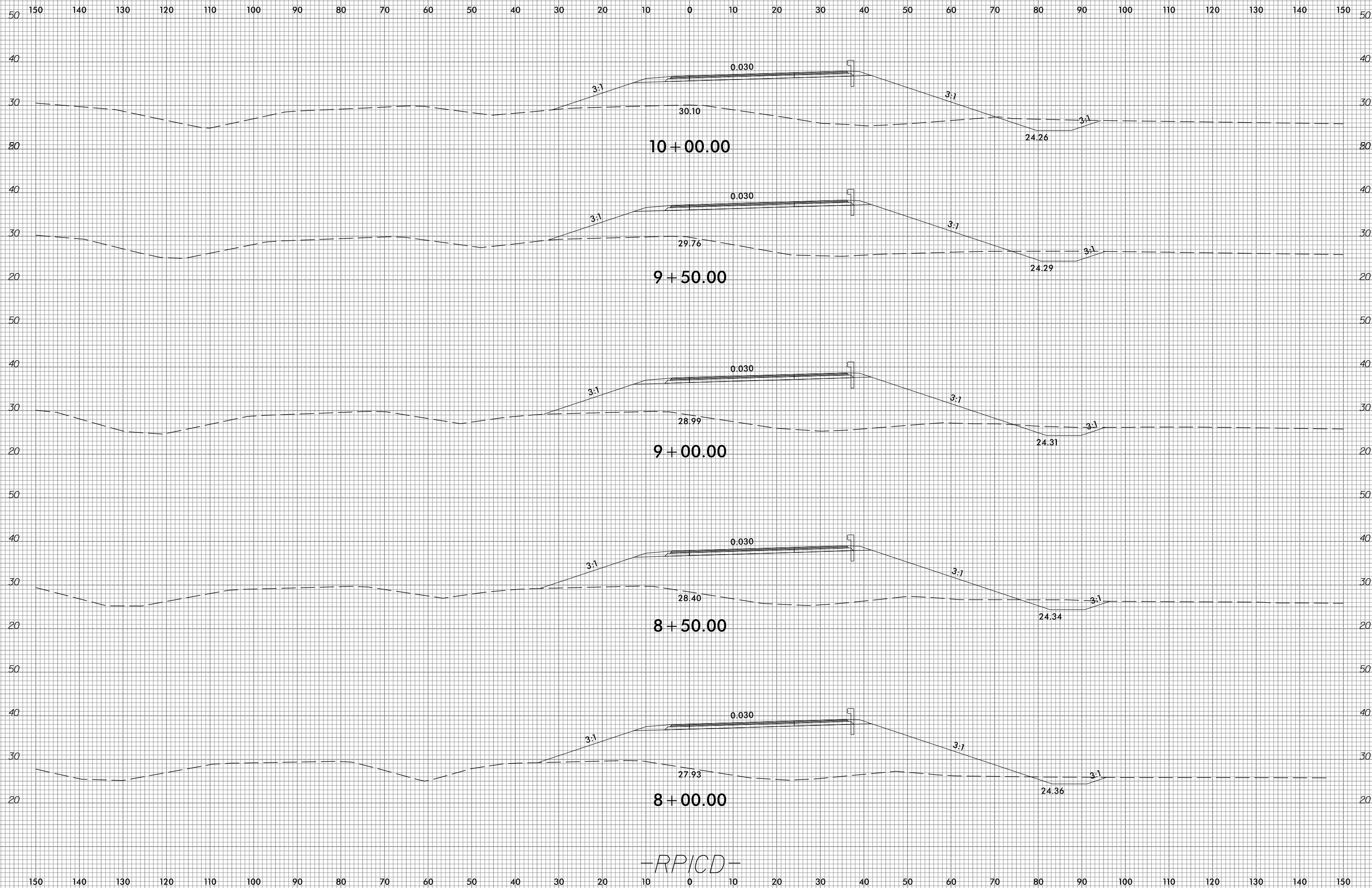

-RPICD-

10/31/2018
G:\RA\9729-02\CADD\1015\Roadway\XSC\1015_xp1_RPICD.dgn
gncdlin



150 140 130 120 110 100 90 80 70 60 50 40 30 20 10 0 10 20 30 40 50 60 70 80 90 100 110 120 130 140 150

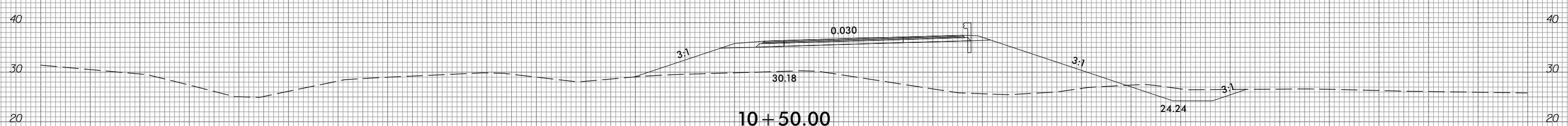
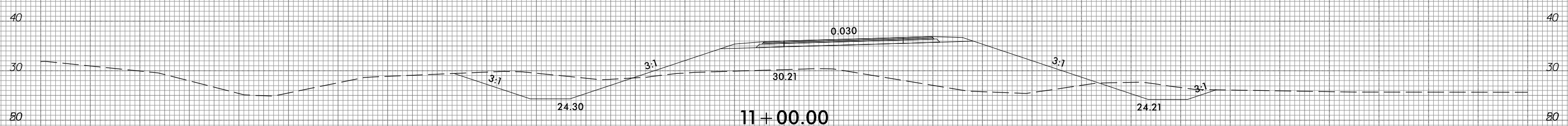
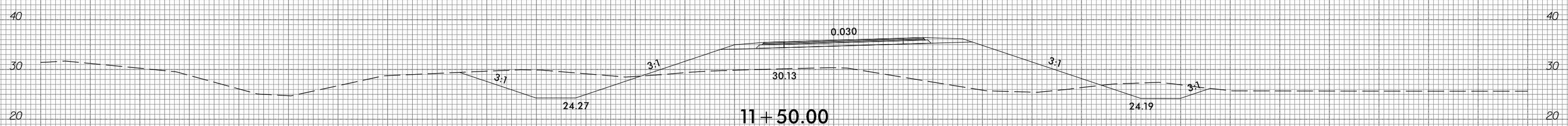
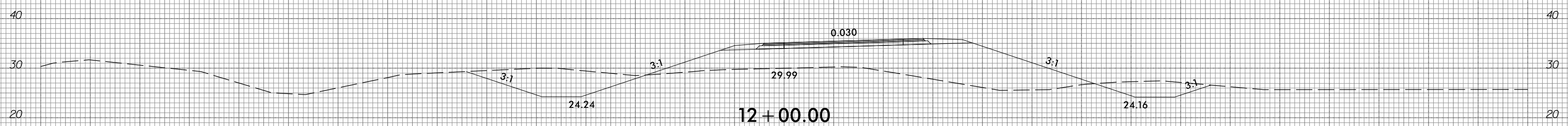
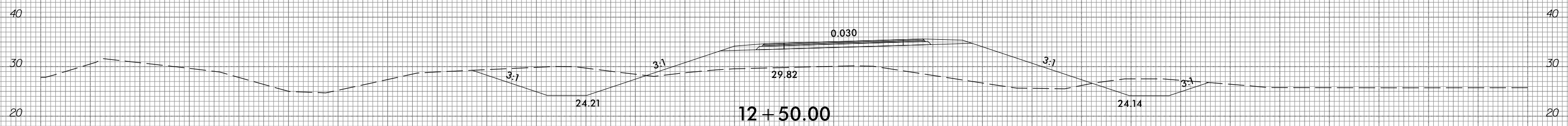
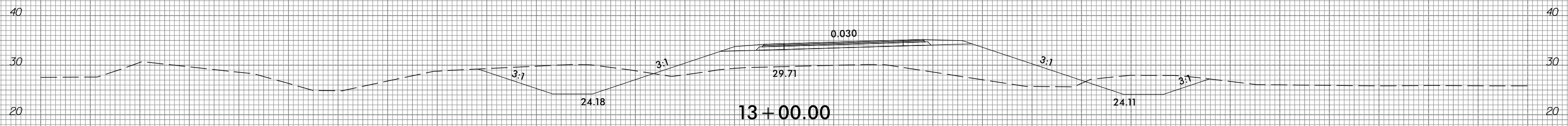

-RPICD-

150 140 130 120 110 100 90 80 70 60 50 40 30 20 10 0 10 20 30 40 50 60 70 80 90 100 110 120 130 140 150

150 140 130 120 110 100 90 80 70 60 50 40 30 20 10 0 10 20 30 40 50 60 70 80 90 100 110 120 130 140 150

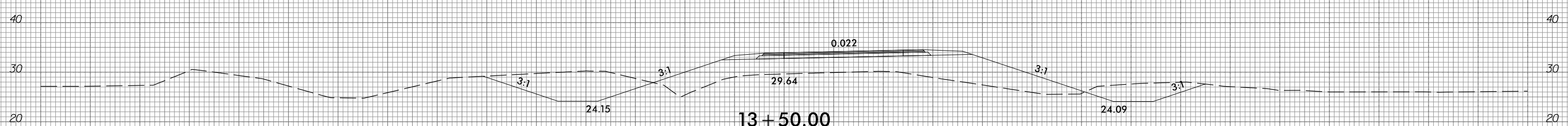
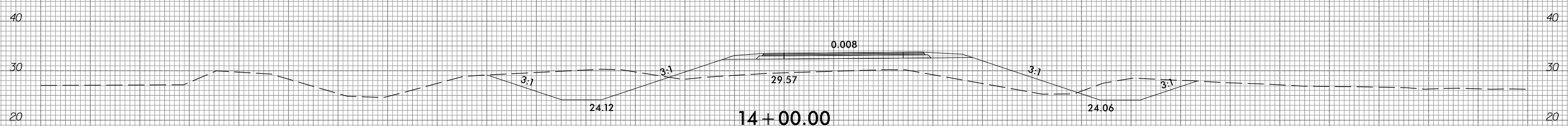
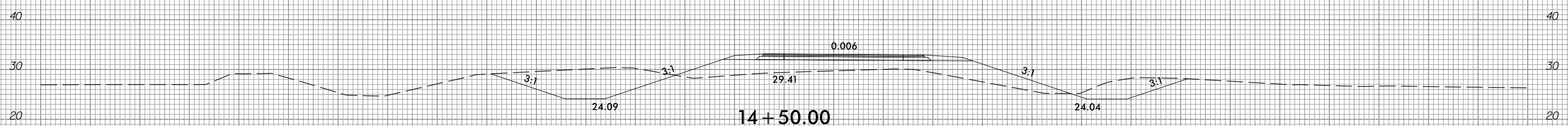
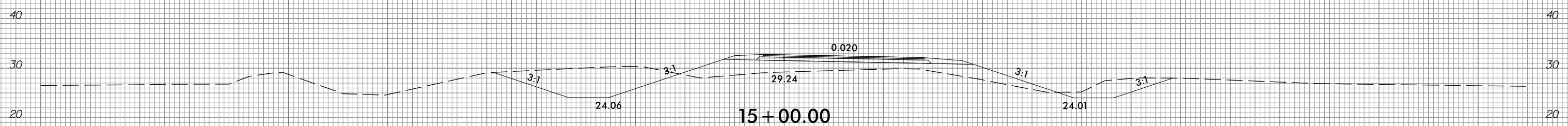
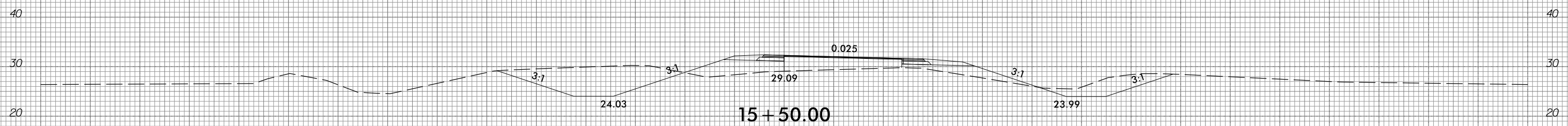
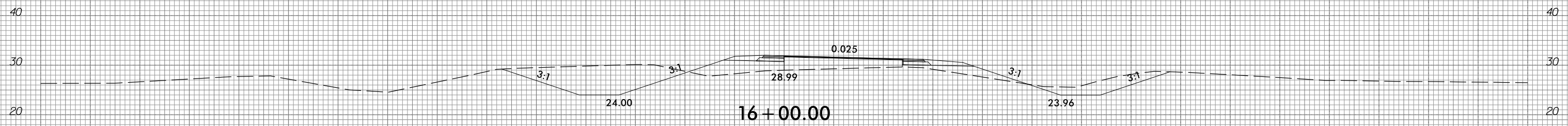

-RPICD-

150 140 130 120 110 100 90 80 70 60 50 40 30 20 10 0 10 20 30 40 50 60 70 80 90 100 110 120 130 140 150



150 140 130 120 110 100 90 80 70 60 50 40 30 20 10 0 10 20 30 40 50 60 70 80 90 100 110 120 130 140 150

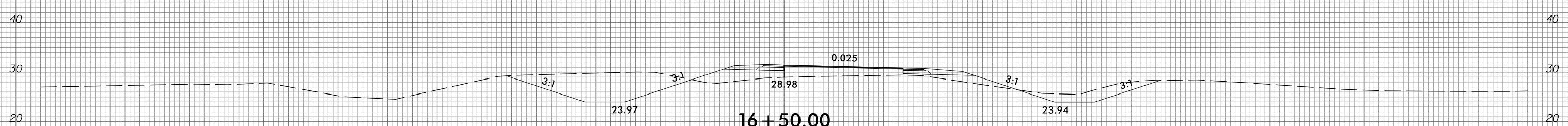
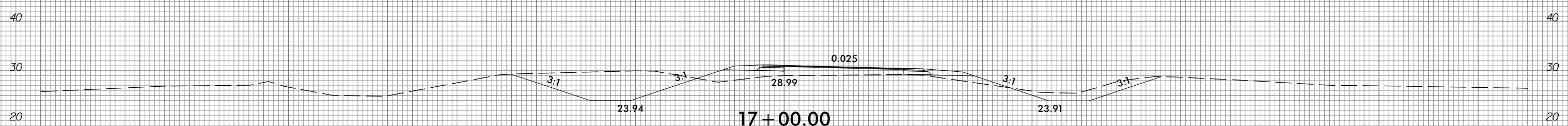
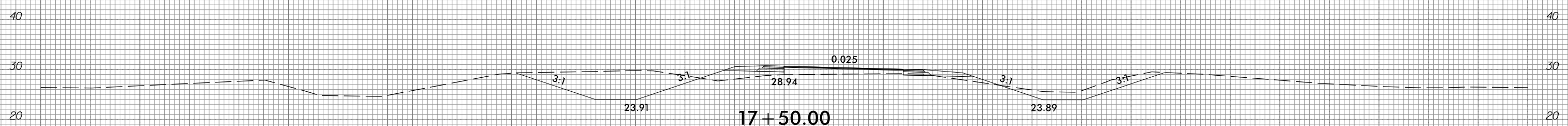
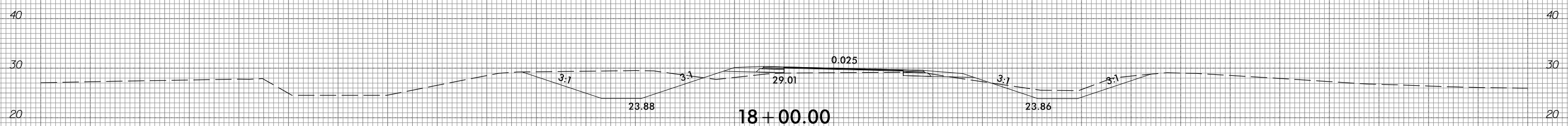
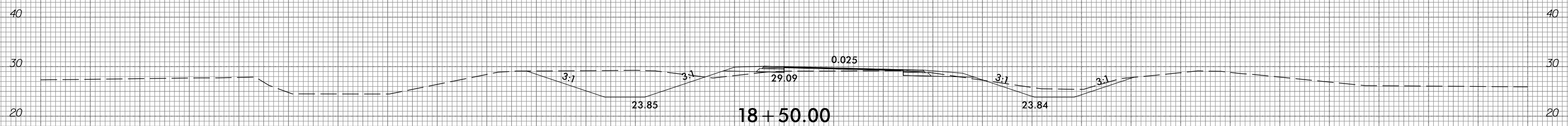
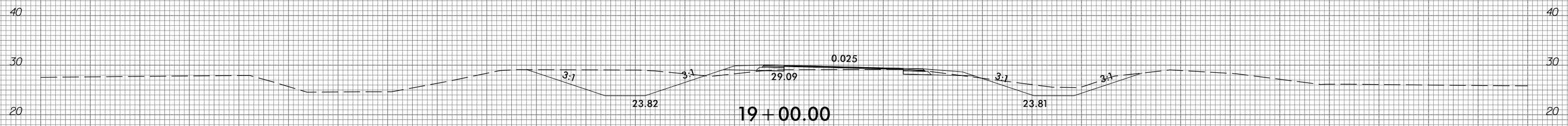

-RPICD-

150 140 130 120 110 100 90 80 70 60 50 40 30 20 10 0 10 20 30 40 50 60 70 80 90 100 110 120 130 140 150



150 140 130 120 110 100 90 80 70 60 50 40 30 20 10 0 10 20 30 40 50 60 70 80 90 100 110 120 130 140 150

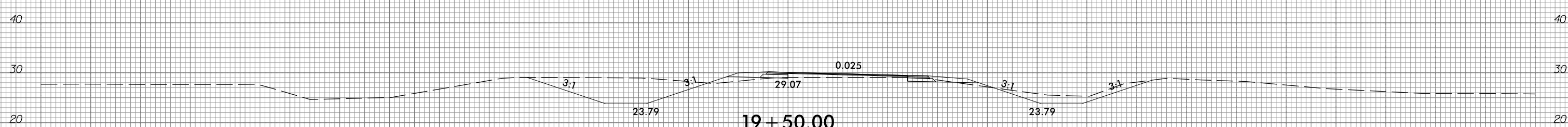
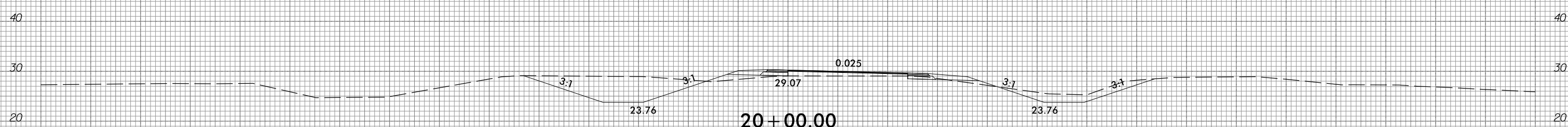
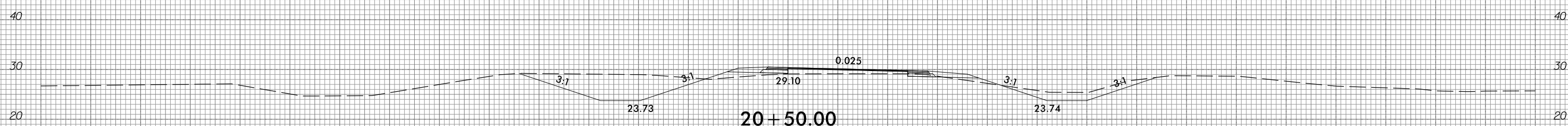
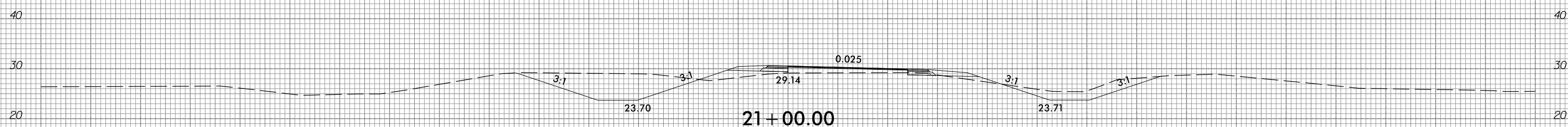
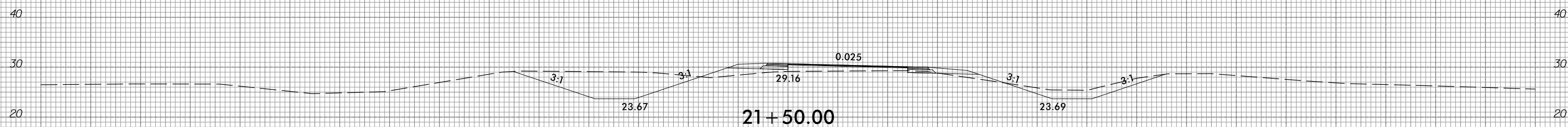
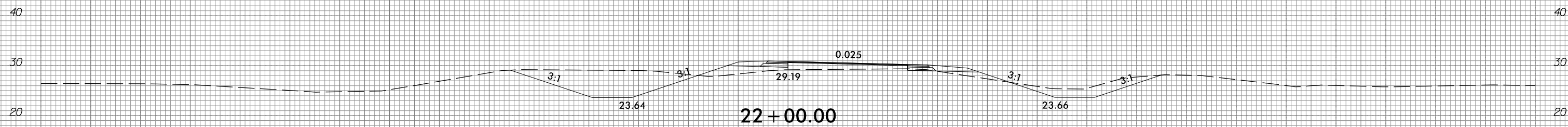

-RPICD-

150 140 130 120 110 100 90 80 70 60 50 40 30 20 10 0 10 20 30 40 50 60 70 80 90 100 110 120 130 140 150

6/23/16



| | |
|---------------------|-----------|
| PROJ. REFERENCE NO. | SHEET NO. |
| R-1015 | X-330 |

150 140 130 120 110 100 90 80 70 60 50 40 30 20 10 0 10 20 30 40 50 60 70 80 90 100 110 120 130 140 150

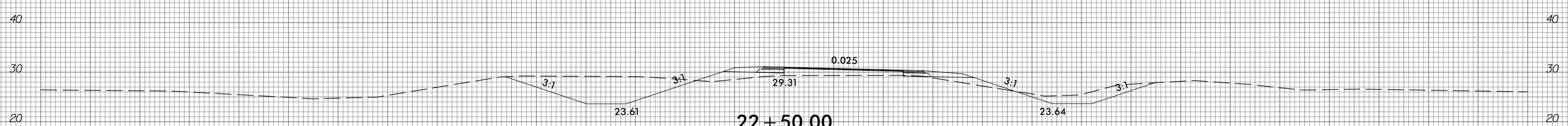
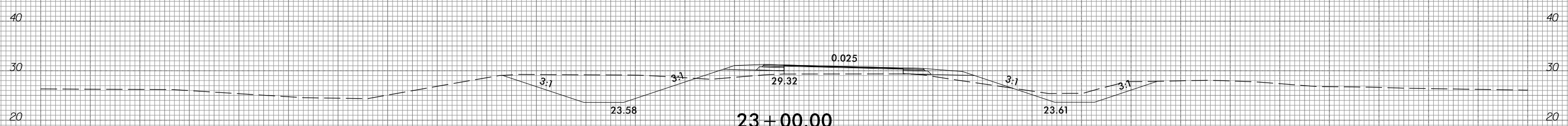
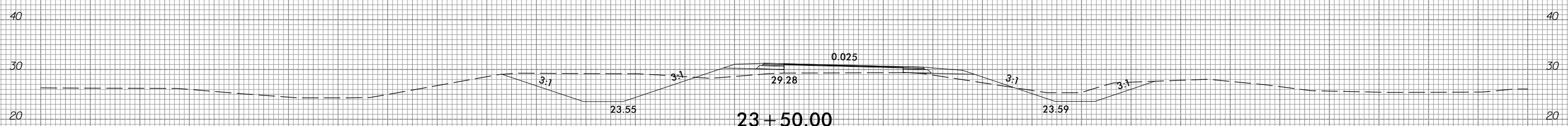
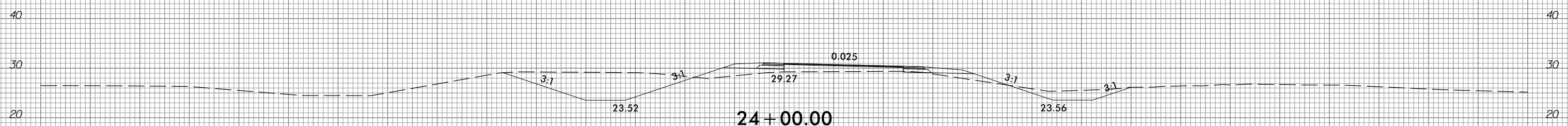
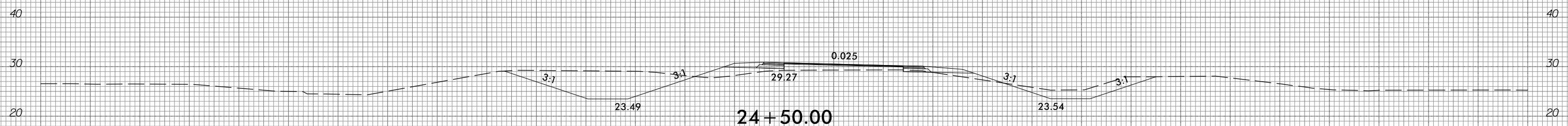
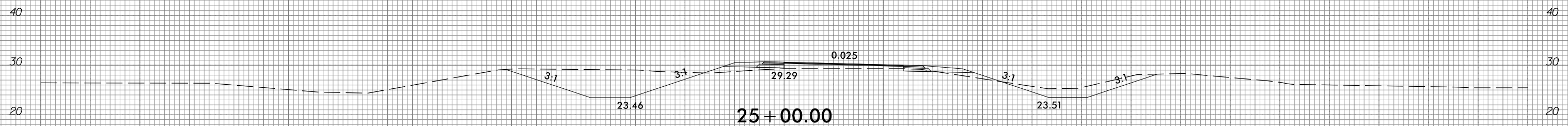

-RPICD-

150 140 130 120 110 100 90 80 70 60 50 40 30 20 10 0 10 20 30 40 50 60 70 80 90 100 110 120 130 140 150

10/31/2018
 G:\RA\9729-02\CADD\1015\Roadway\XSC\1015_xp1_RPICD.dgn
 gncdlin



150 140 130 120 110 100 90 80 70 60 50 40 30 20 10 0 10 20 30 40 50 60 70 80 90 100 110 120 130 140 150

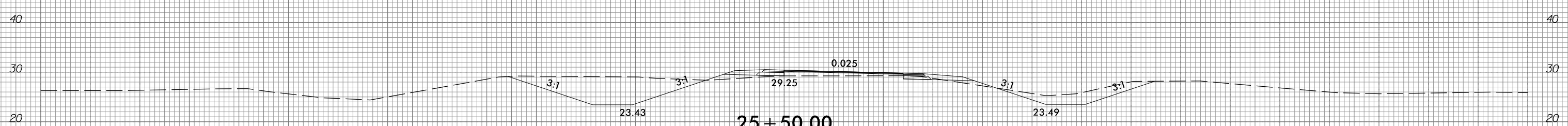
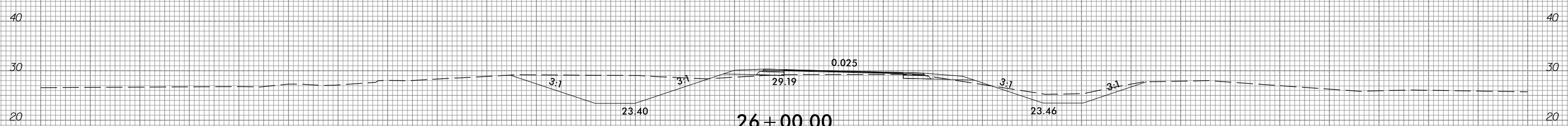
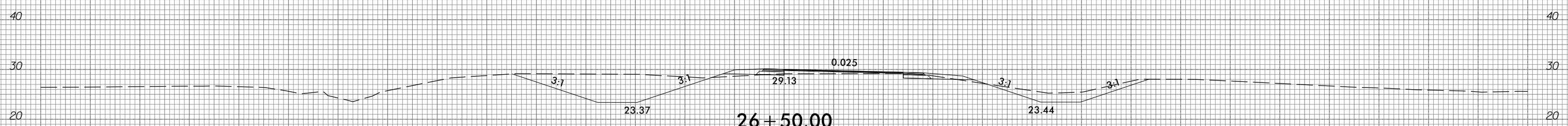
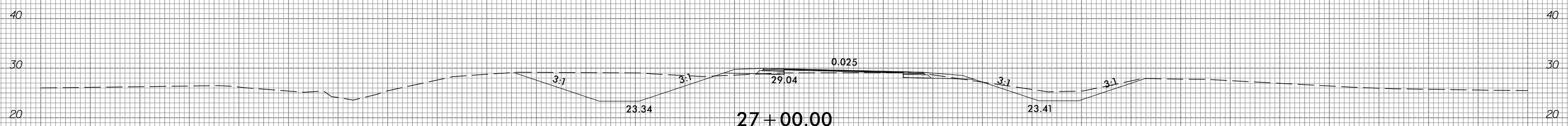
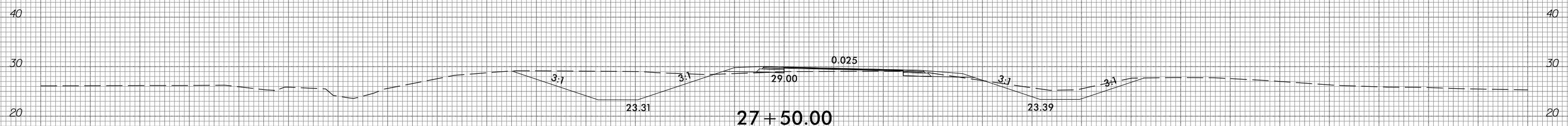
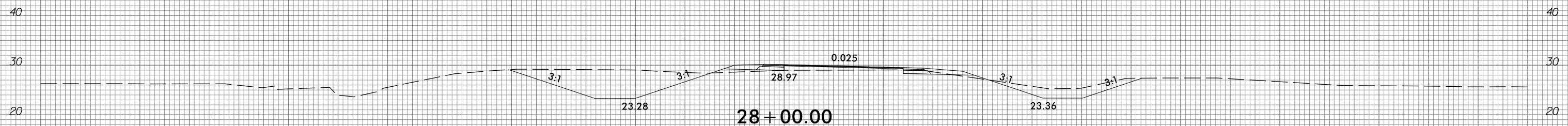

-RPICD-

150 140 130 120 110 100 90 80 70 60 50 40 30 20 10 0 10 20 30 40 50 60 70 80 90 100 110 120 130 140 150

6/23/16



PROJ. REFERENCE NO.
R-1015

SHEET NO.
X-332

150 140 130 120 110 100 90 80 70 60 50 40 30 20 10 0 10 20 30 40 50 60 70 80 90 100 110 120 130 140 150

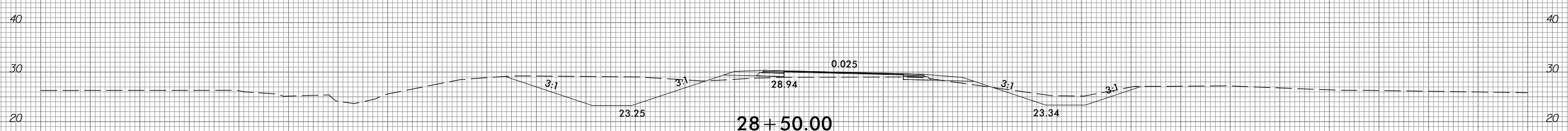
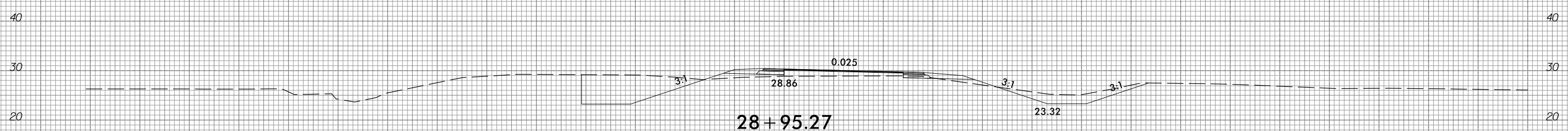
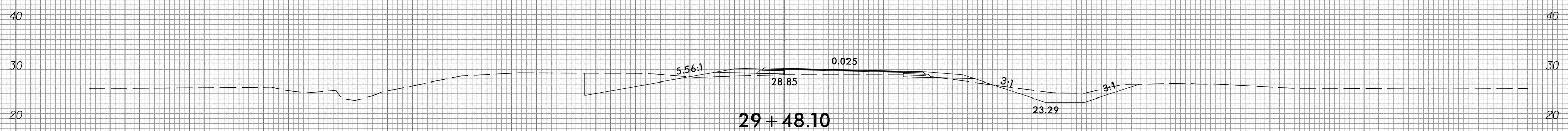
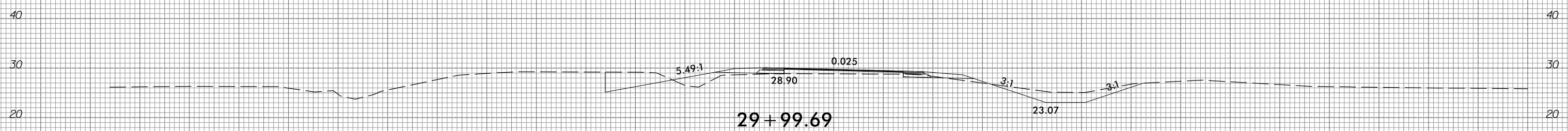
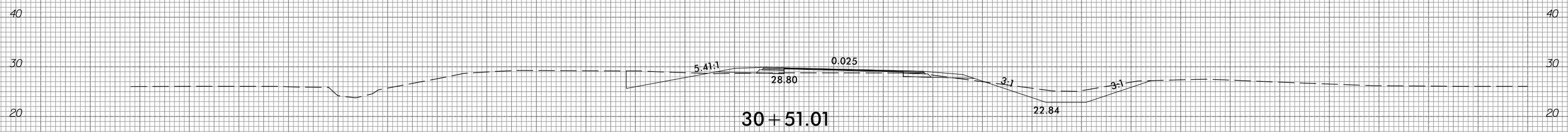
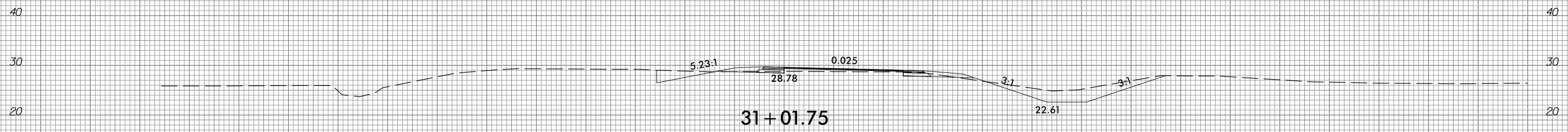

-RPICD-

150 140 130 120 110 100 90 80 70 60 50 40 30 20 10 0 10 20 30 40 50 60 70 80 90 100 110 120 130 140 150

10/31/2018
G:\RA\9729-02\CADD\1015\Roadway\XSC\1015_xp1_RPICD.dgn
gncdlin



150 140 130 120 110 100 90 80 70 60 50 40 30 20 10 0 10 20 30 40 50 60 70 80 90 100 110 120 130 140 150

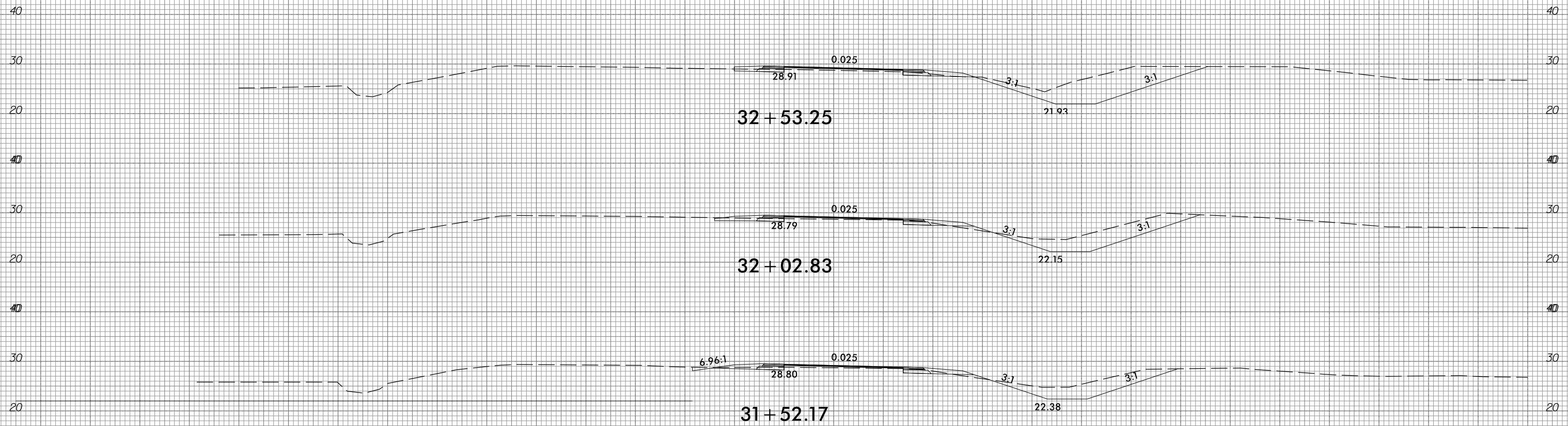

-RPICD-

6/23/16



PROJ. REFERENCE NO.
R-1015

SHEET NO.
X-334

150 140 130 120 110 100 90 80 70 60 50 40 30 20 10 0 10 20 30 40 50 60 70 80 90 100 110 120 130 140 150

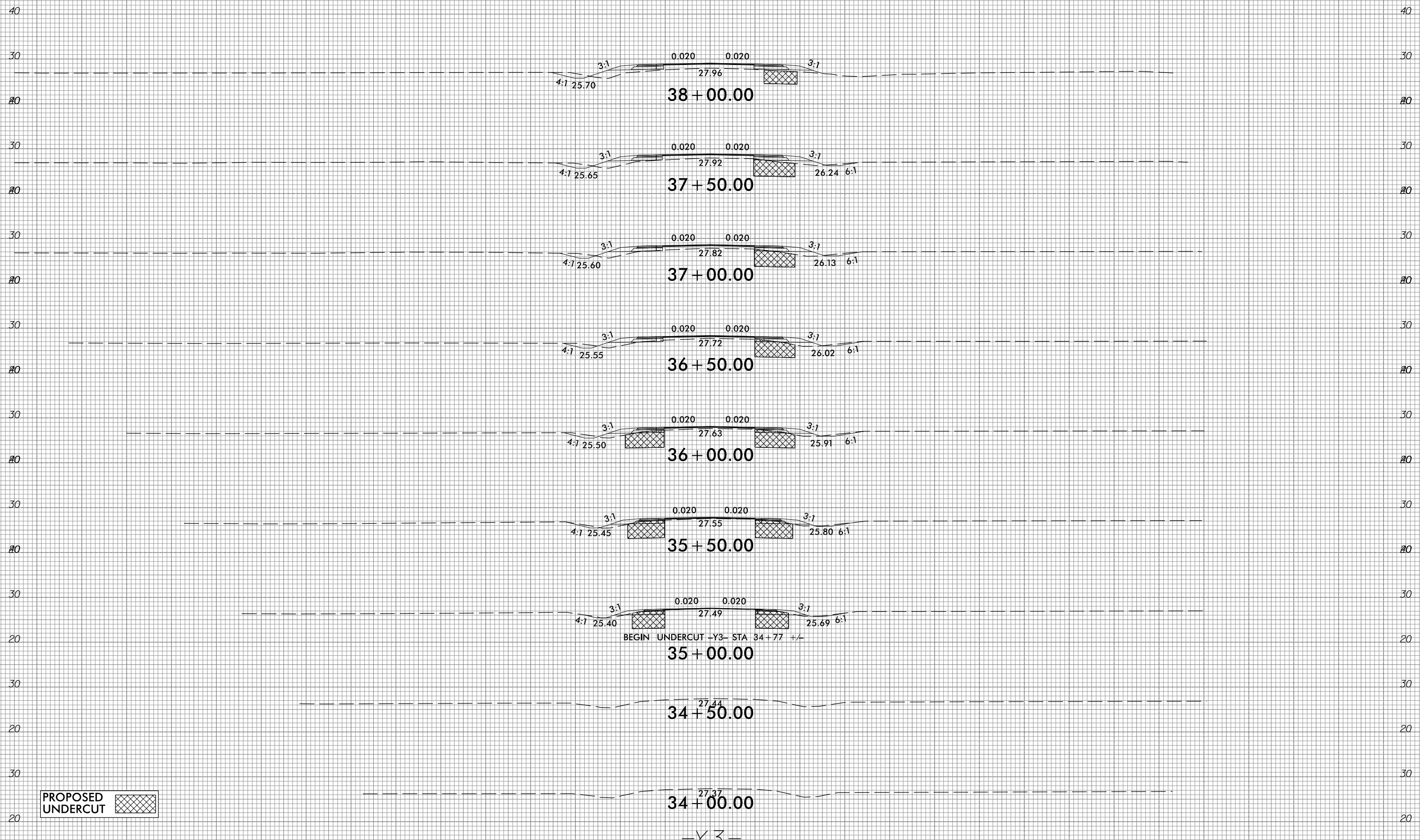

PROPOSED UNDERCUT

150 140 130 120 110 100 90 80 70 60 50 40 30 20 10 0 10 20 30 40 50 60 70 80 90 100 110 120 130 140 150

10/31/2018
G:\RA\9729-02\CADD\1015\Roadway\XSC\1015_xp1_Y3.dgn
gncdlin

-Y3-

6/23/16



PROJ. REFERENCE NO.
R-1015

SHEET NO.
X-335

150 140 130 120 110 100 90 80 70 60 50 40 30 20 10 0 10 20 30 40 50 60 70 80 90 100 110 120 130 140 150

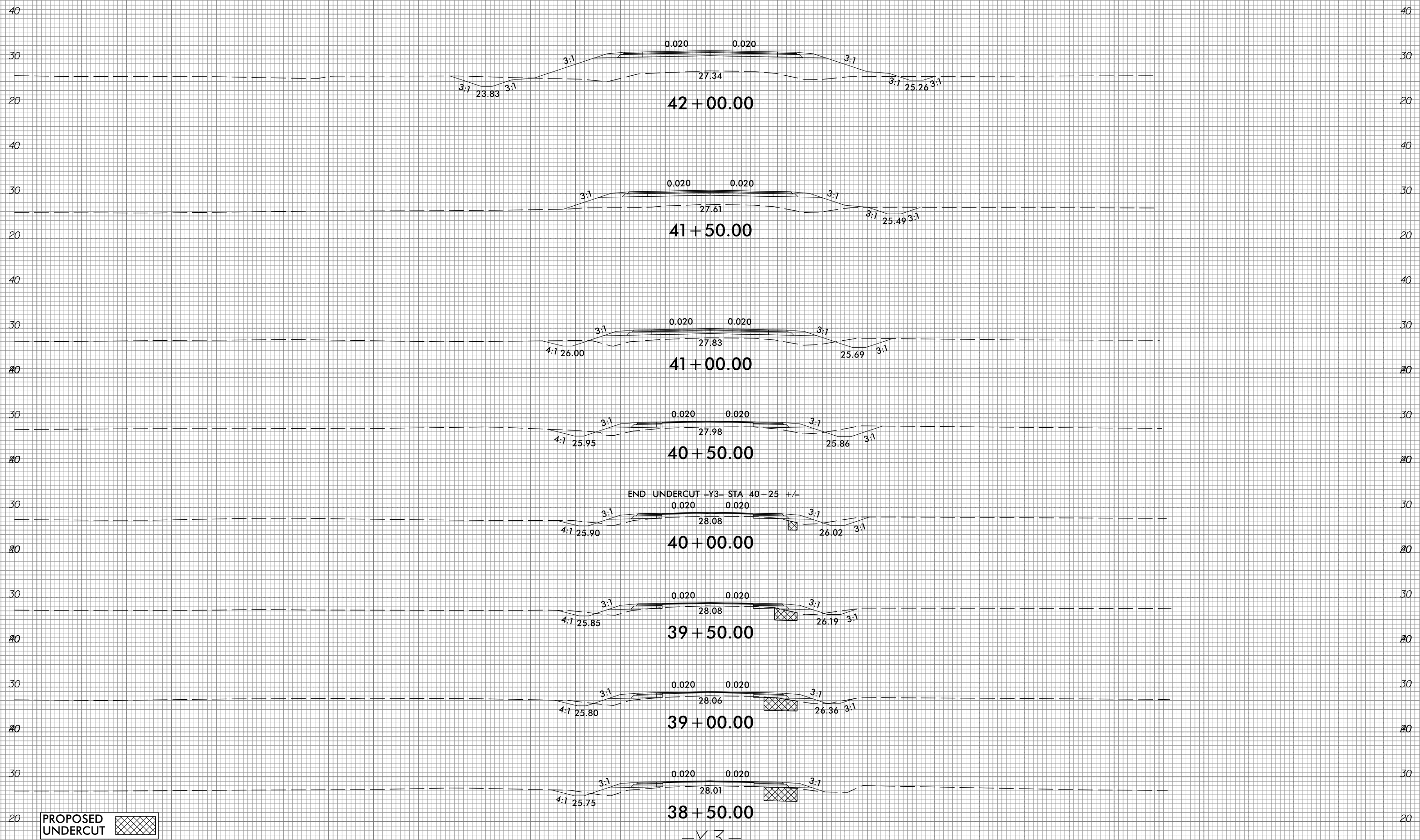

PROPOSED UNDERCUT



10/31/2018
G:\RA\9729-02\CADD\1015\Roadway\XSC\1015_xp1_Y3.dgn
gncdlin

150 140 130 120 110 100 90 80 70 60 50 40 30 20 10 0 10 20 30 40 50 60 70 80 90 100 110 120 130 140 150

6/23/16



| |
|---------------------|
| PROJ. REFERENCE NO. |
| R-1015 |

| |
|-----------|
| SHEET NO. |
| X-336 |

150 140 130 120 110 100 90 80 70 60 50 40 30 20 10 0 10 20 30 40 50 60 70 80 90 100 110 120 130 140 150

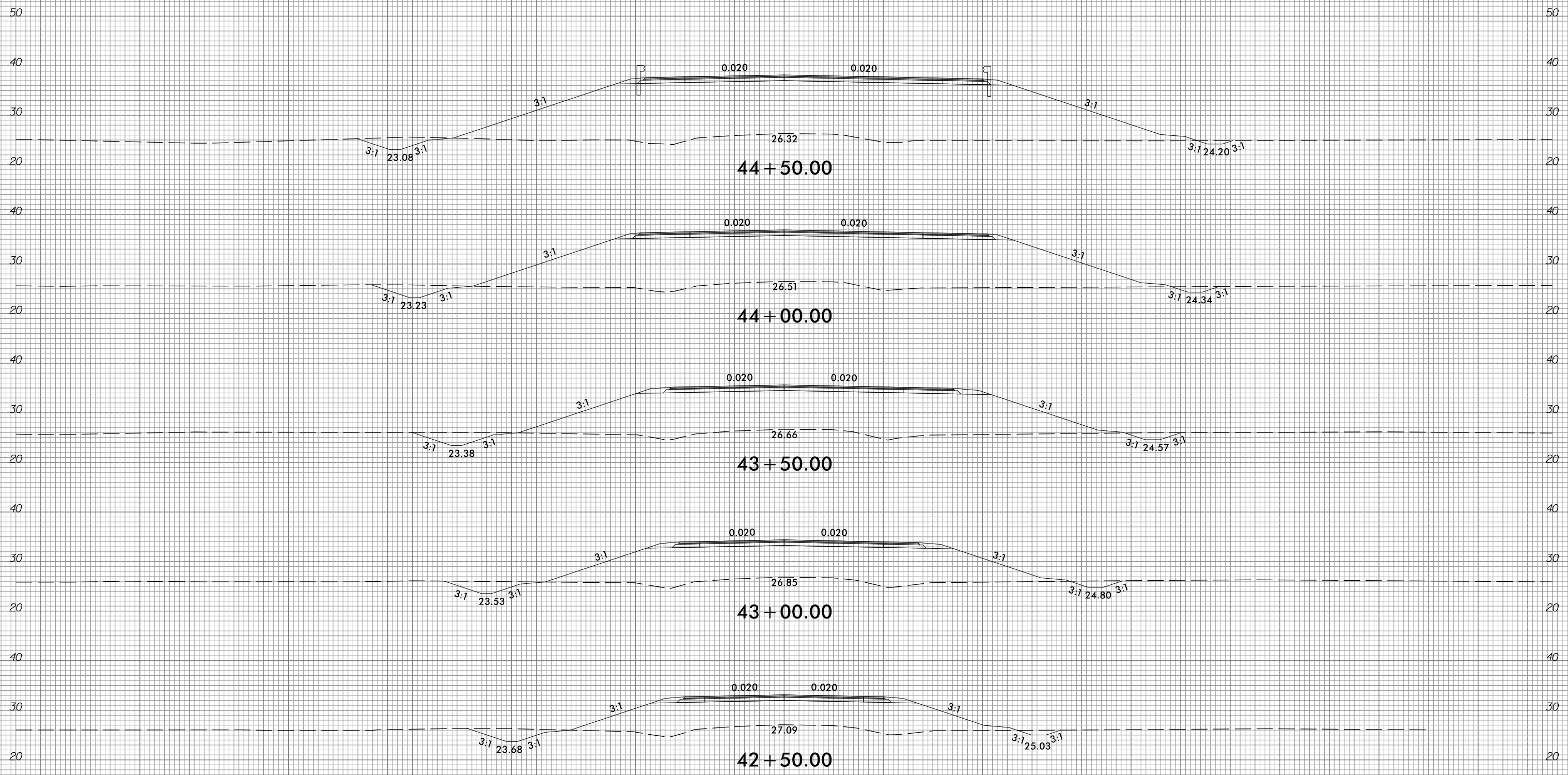

-Y3-

150 140 130 120 110 100 90 80 70 60 50 40 30 20 10 0 10 20 30 40 50 60 70 80 90 100 110 120 130 140 150

10/31/2018
 G:\RA\9729-02\CADD\1015\Roadway\XSC\1015_xp1_Y3.dgn
 gmc011n

6/23/16



PROJ. REFERENCE NO.
R-1015

SHEET NO.
X-337

150 140 130 120 110 100 90 80 70 60 50 40 30 20 10 0 10 20 30 40 50 60 70 80 90 100 110 120 130 140 150

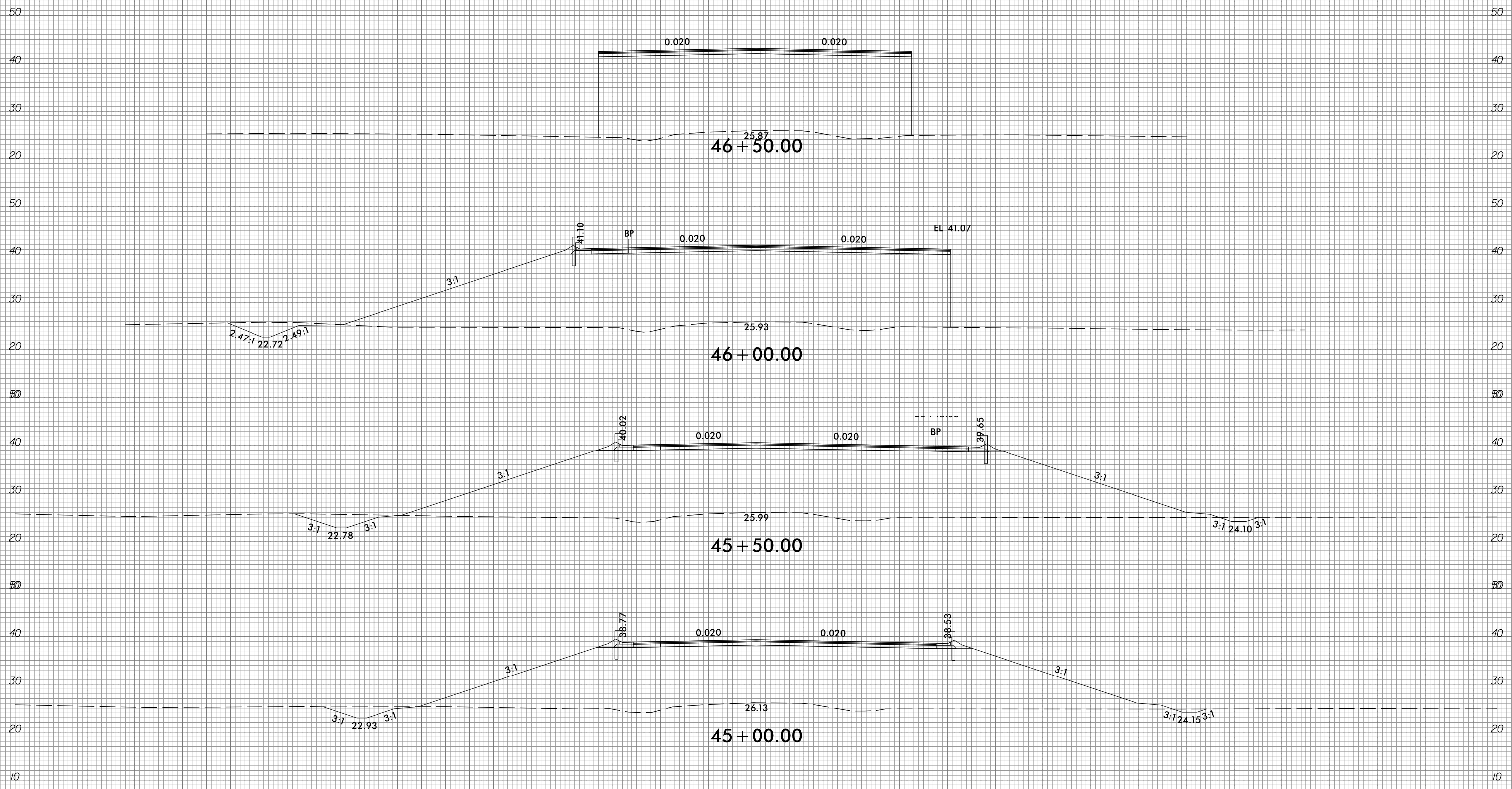

-Y3-

150 140 130 120 110 100 90 80 70 60 50 40 30 20 10 0 10 20 30 40 50 60 70 80 90 100 110 120 130 140 150

10/31/2018
G:\RA\9729-02\CADD\1015\Roadway\XSC\1015_xp1_Y3.dgn
gncdlin

6/23/16



PROJ. REFERENCE NO.
R-1015

SHEET NO.
X-338

150 140 130 120 110 100 90 80 70 60 50 40 30 20 10 0 10 20 30 40 50 60 70 80 90 100 110 120 130 140 150

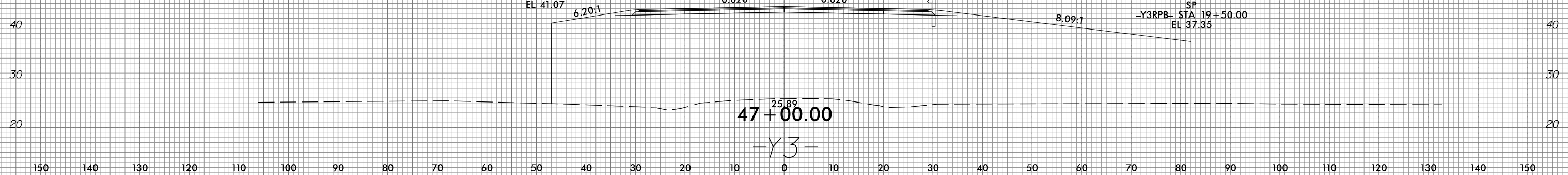
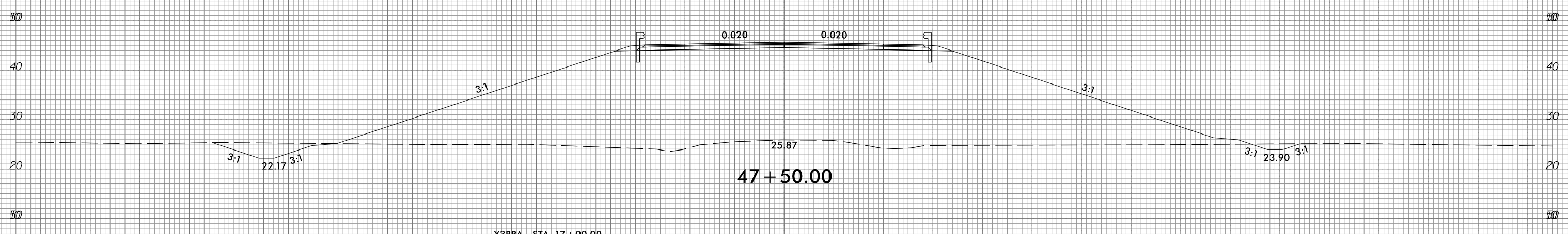
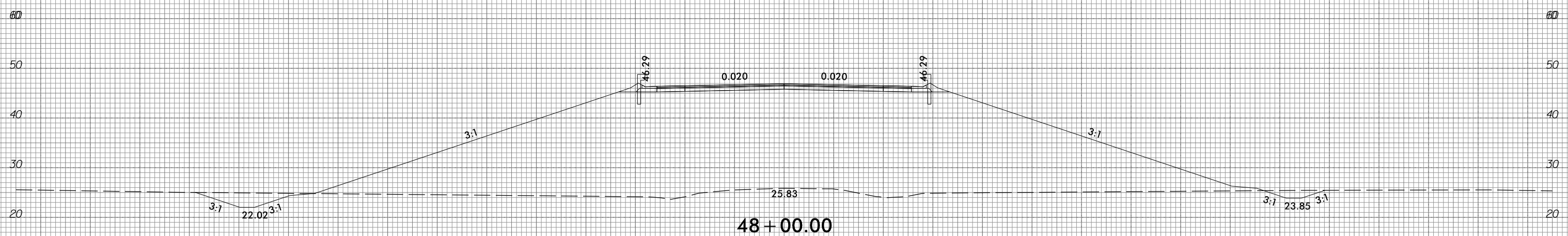
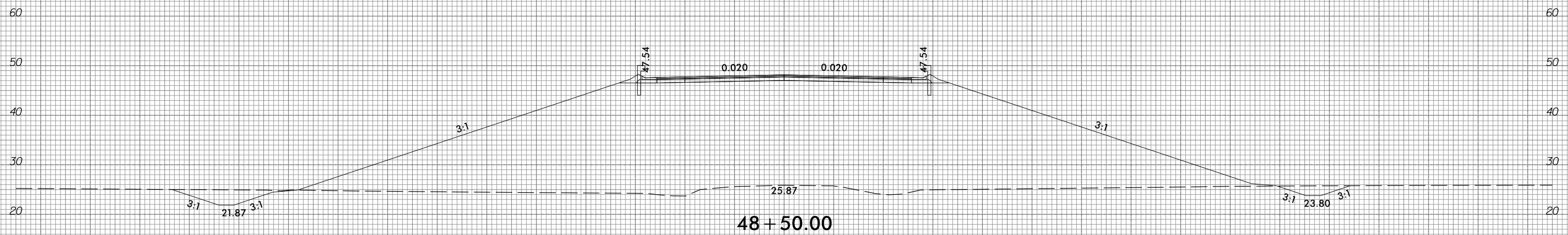

150 140 130 120 110 100 90 80 70 60 50 40 30 20 10 0 10 20 30 40 50 60 70 80 90 100 110 120 130 140 150

10/31/2018
G:\RA\9729-02\CADD\1015\Roadway\XSC\1015_xp1_Y3.dgn
gncdlin

6/23/16



| |
|---------------------|
| PROJ. REFERENCE NO. |
| R-1015 |

| |
|-----------|
| SHEET NO. |
| X-339 |

150 140 130 120 110 100 90 80 70 60 50 40 30 20 10 0 10 20 30 40 50 60 70 80 90 100 110 120 130 140 150

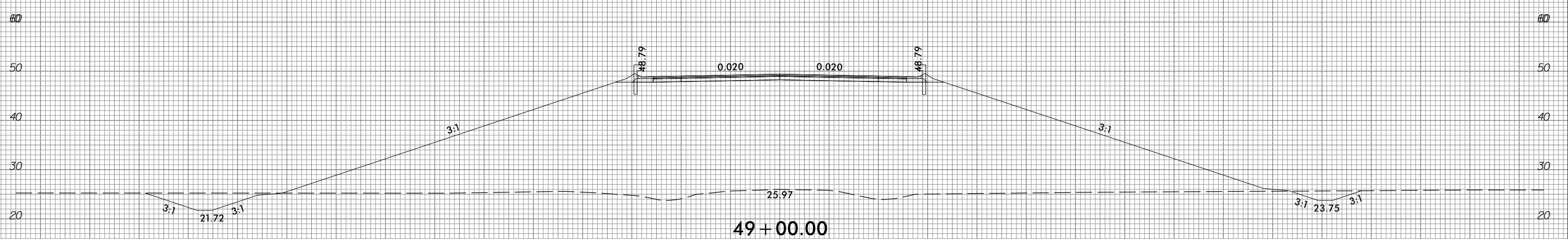
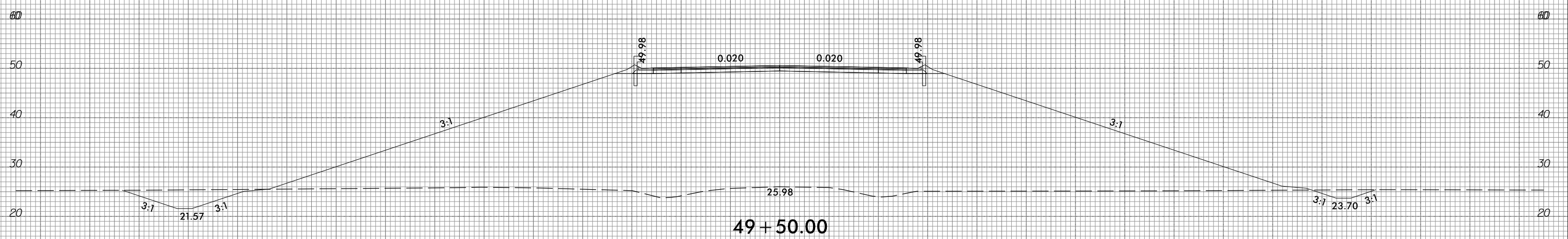
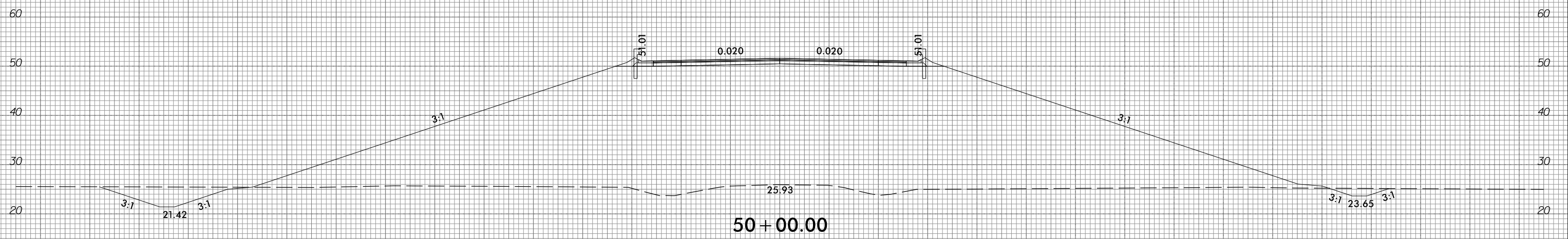

-Y3-

150 140 130 120 110 100 90 80 70 60 50 40 30 20 10 0 10 20 30 40 50 60 70 80 90 100 110 120 130 140 150

10/31/2018
 G:\RA\9729-02\CAD\00\1015\Roadway\XSC\1015_xp1_Y3.dgn
 gmc31in

6/23/16



PROJ. REFERENCE NO.
R-1015

SHEET NO.
X-340

150 140 130 120 110 100 90 80 70 60 50 40 30 20 10 0 10 20 30 40 50 60 70 80 90 100 110 120 130 140 150

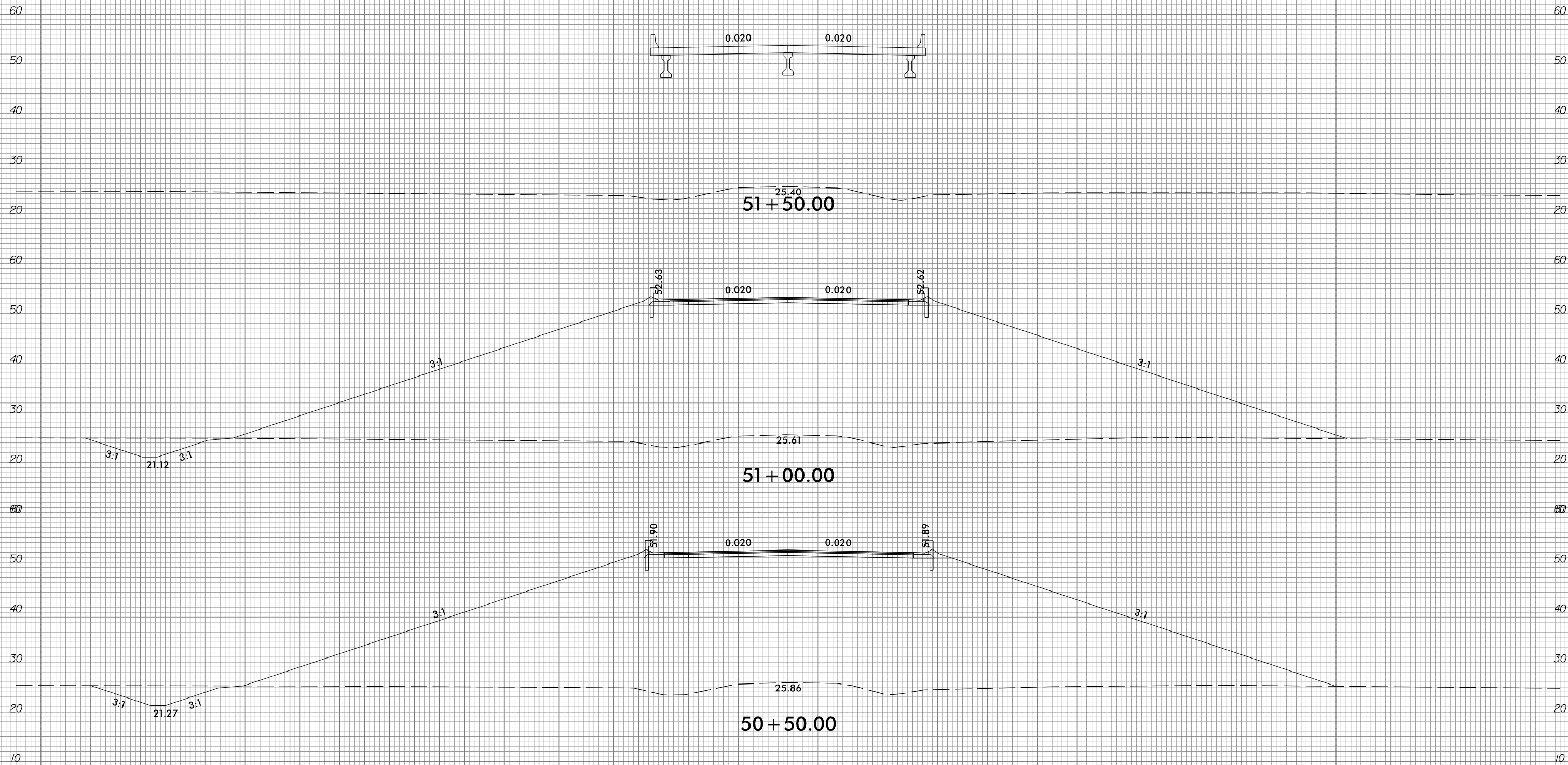

-Y3-

150 140 130 120 110 100 90 80 70 60 50 40 30 20 10 0 10 20 30 40 50 60 70 80 90 100 110 120 130 140 150

10/31/2018
G:\RA\9729-02\CADD\1015\Roadway\XSC\1015_xp1_Y3.dgn
gncdlin

6/23/16



PROJ. REFERENCE NO.
R-1015

SHEET NO.
X-341

150 140 130 120 110 100 90 80 70 60 50 40 30 20 10 0 10 20 30 40 50 60 70 80 90 100 110 120 130 140 150

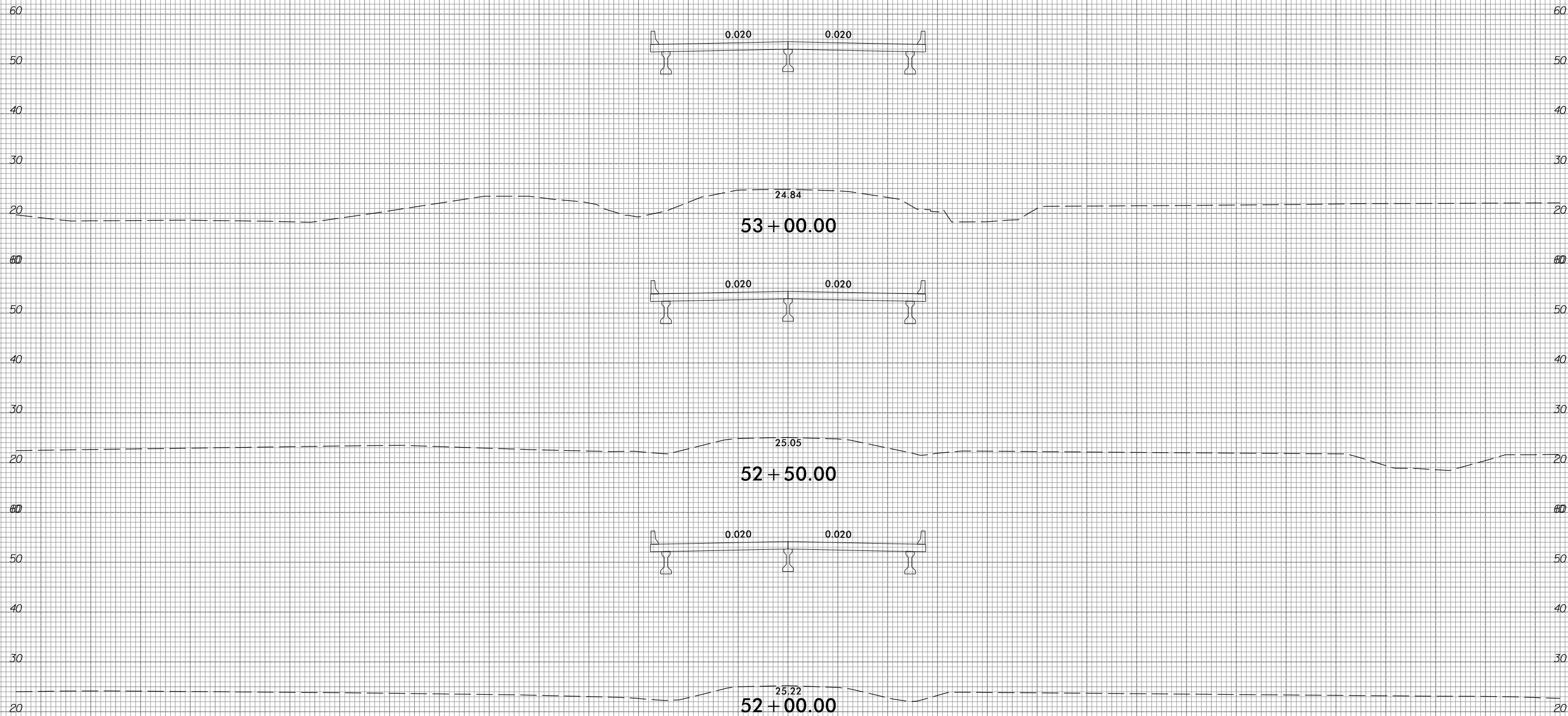

-Y3-

150 140 130 120 110 100 90 80 70 60 50 40 30 20 10 0 10 20 30 40 50 60 70 80 90 100 110 120 130 140 150

10/31/2018
G:\RA\9729-02\CADD\1015\Roadway\XSC\1015_xp1_Y3.dgn
gncdjin

150 140 130 120 110 100 90 80 70 60 50 40 30 20 10 0 10 20 30 40 50 60 70 80 90 100 110 120 130 140 150

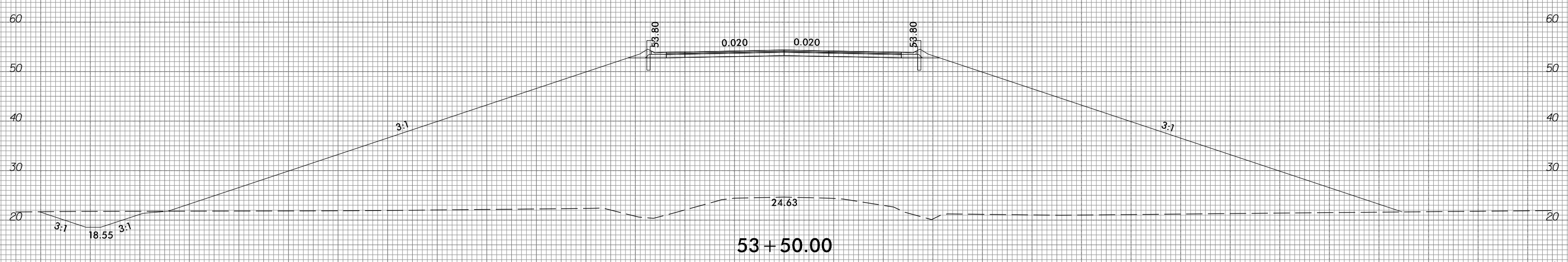
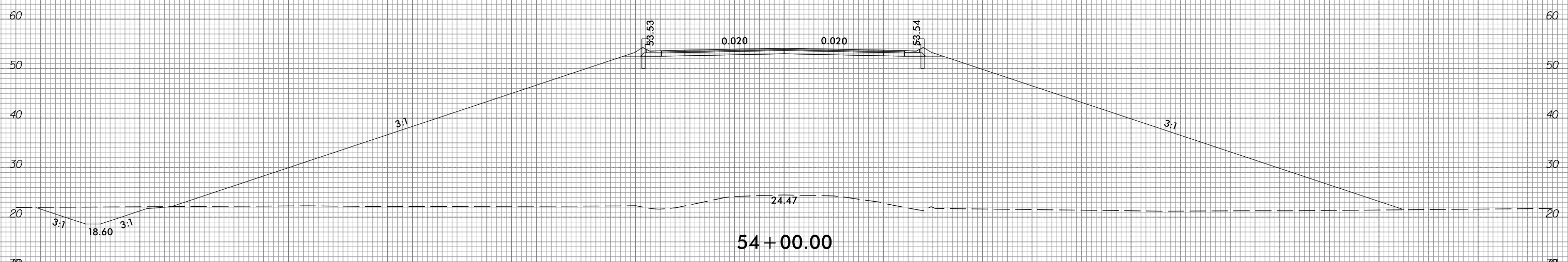
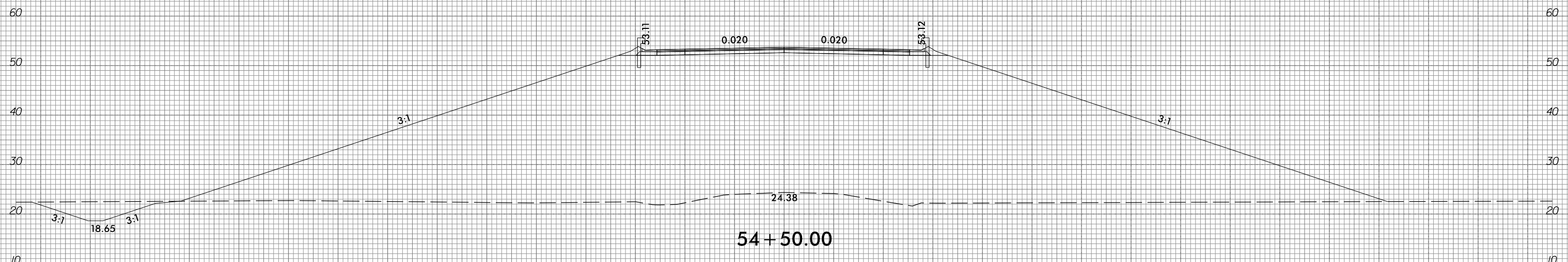

-Y3-

6/23/16



PROJ. REFERENCE NO.
R-1015

SHEET NO.
X-343

150 140 130 120 110 100 90 80 70 60 50 40 30 20 10 0 10 20 30 40 50 60 70 80 90 100 110 120 130 140 150

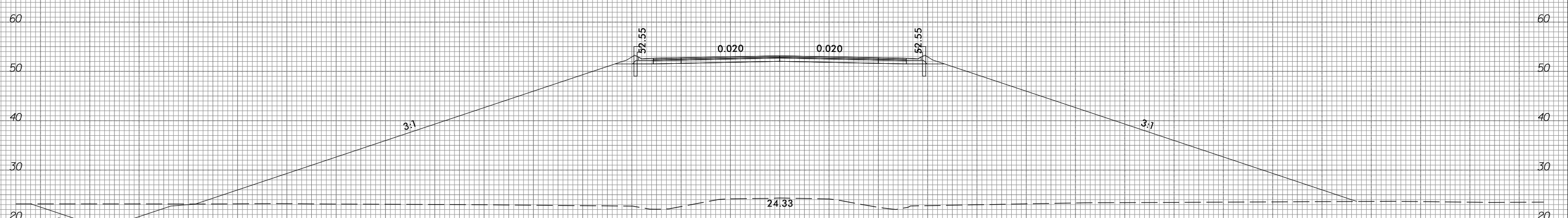
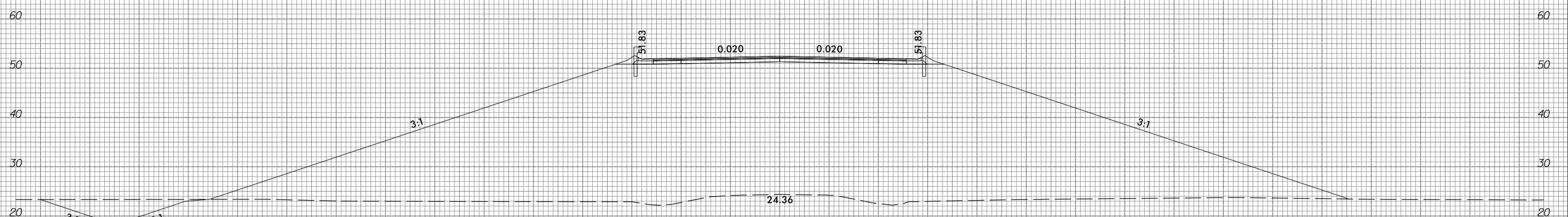
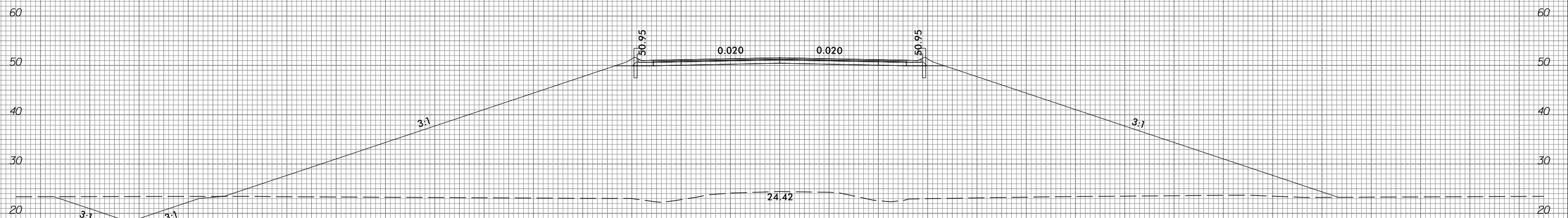

-Y3-

150 140 130 120 110 100 90 80 70 60 50 40 30 20 10 0 10 20 30 40 50 60 70 80 90 100 110 120 130 140 150

10/31/2018
G:\RA\9729-02\CADD\1015\Roadway\XSC\1015_xp1_Y3.dgn
gncdlin

6/23/16



| | |
|---------------------|-----------|
| PROJ. REFERENCE NO. | SHEET NO. |
| R-1015 | X-344 |

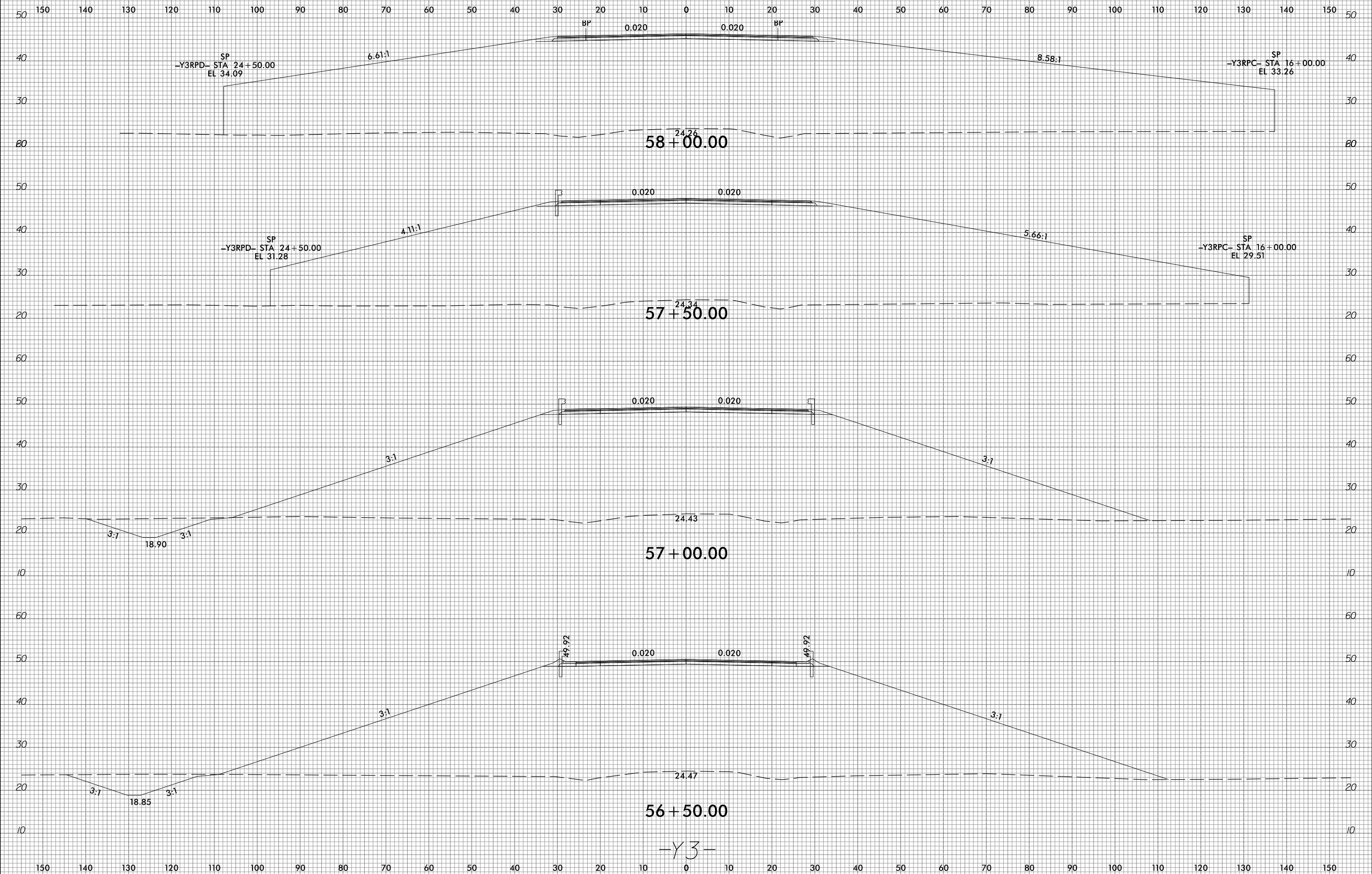

10/31/2018
G:\RA\9729-02\CADD\1015\Roadway\XSC\1015_xp1_Y3.dgn
gncdlin

6/23/16



PROJ. REFERENCE NO.
R-1015

SHEET NO.
X-345

150 140 130 120 110 100 90 80 70 60 50 40 30 20 10 0 10 20 30 40 50 60 70 80 90 100 110 120 130 140 150

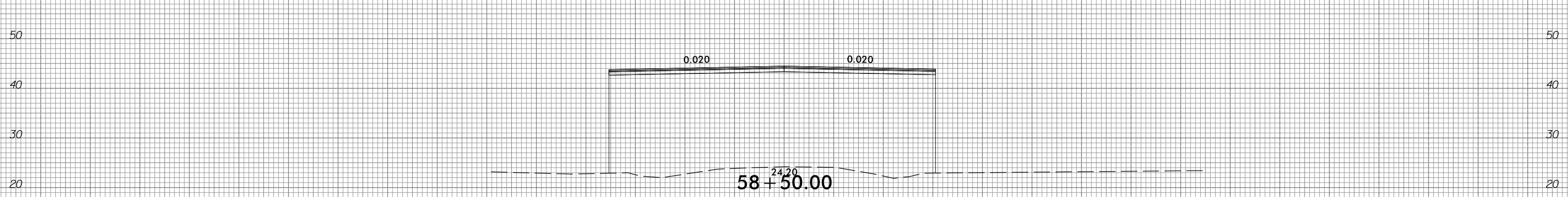
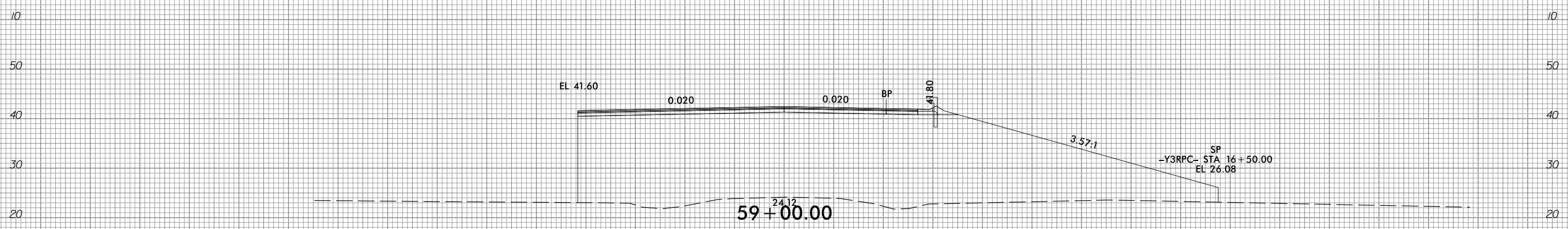
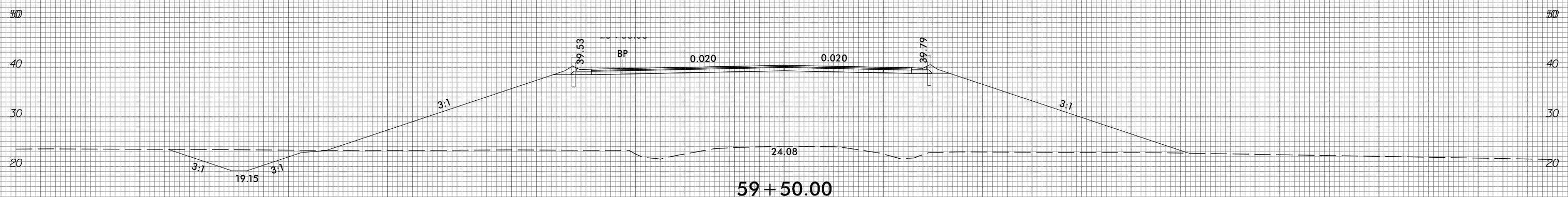
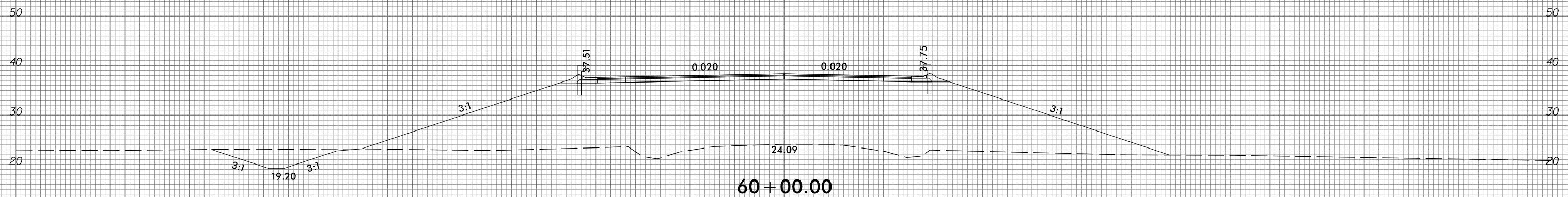

-Y3-

150 140 130 120 110 100 90 80 70 60 50 40 30 20 10 0 10 20 30 40 50 60 70 80 90 100 110 120 130 140 150

10/31/2018
G:\RA\9729-02\CADD\1015\Roadway\XSC\1015_xp1_Y3.dgn
gncdlin

6/23/16



PROJ. REFERENCE NO.
R-1015

SHEET NO.
X-346

150 140 130 120 110 100 90 80 70 60 50 40 30 20 10 0 10 20 30 40 50 60 70 80 90 100 110 120 130 140 150

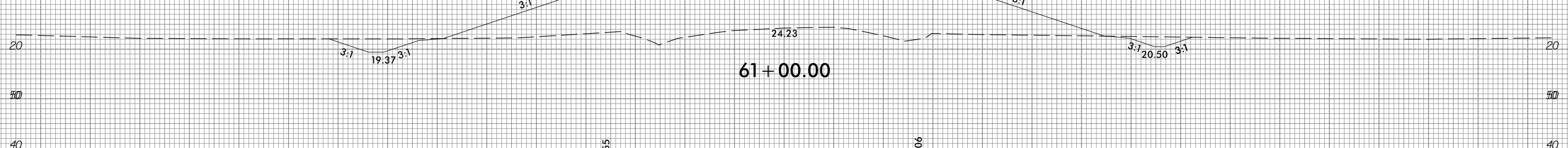
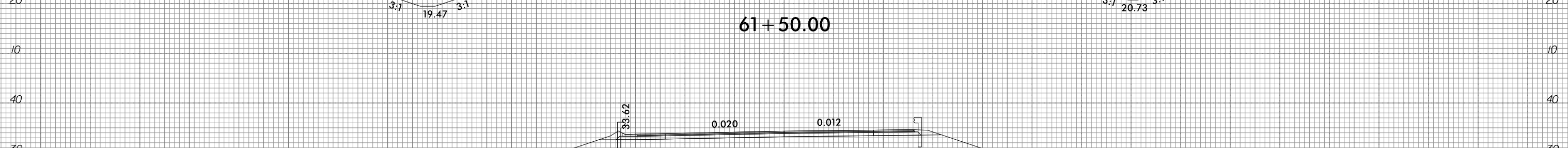
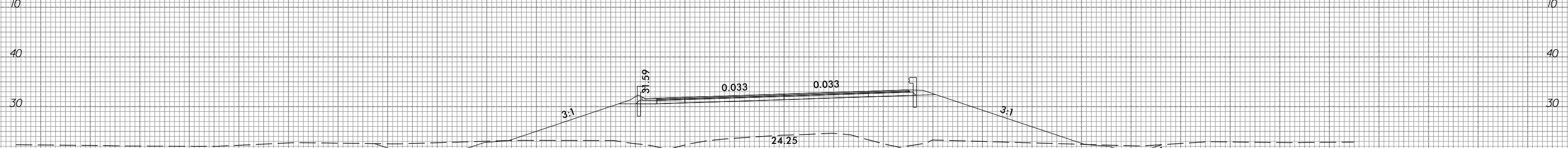
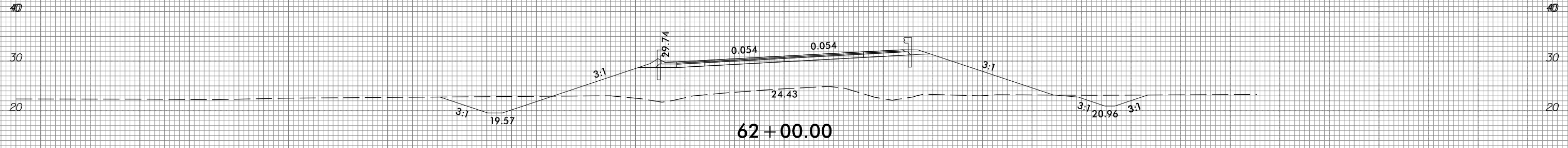
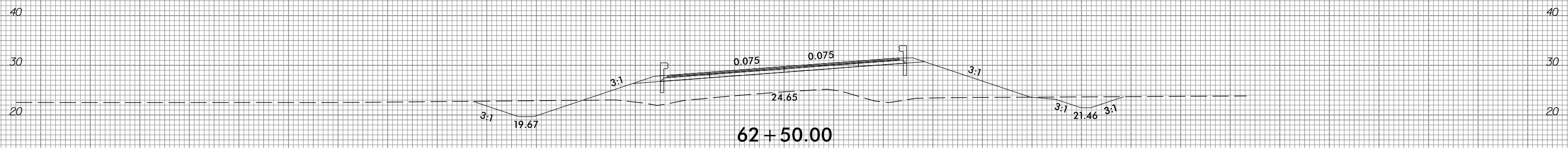

150 140 130 120 110 100 90 80 70 60 50 40 30 20 10 0 10 20 30 40 50 60 70 80 90 100 110 120 130 140 150

-Y3-

10/31/2018
G:\RA\9729-02\CADD\1015\Roadway\XSC\1015_xp1_Y3.dgn
gncdlin

150 140 130 120 110 100 90 80 70 60 50 40 30 20 10 0 10 20 30 40 50 60 70 80 90 100 110 120 130 140 150

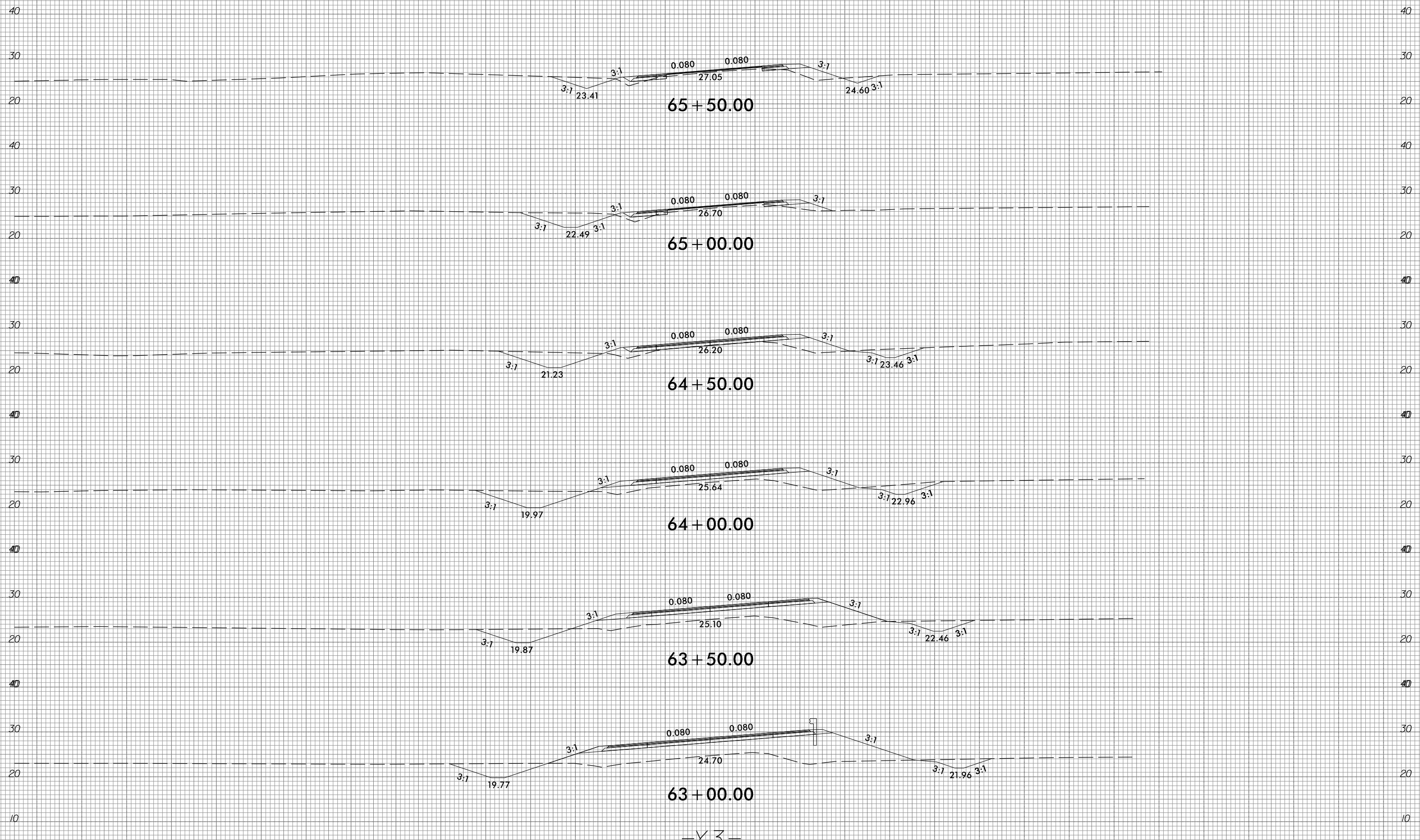

-Y3-

6/23/16



PROJ. REFERENCE NO.
R-1015

SHEET NO.
X-348

150 140 130 120 110 100 90 80 70 60 50 40 30 20 10 0 10 20 30 40 50 60 70 80 90 100 110 120 130 140 150

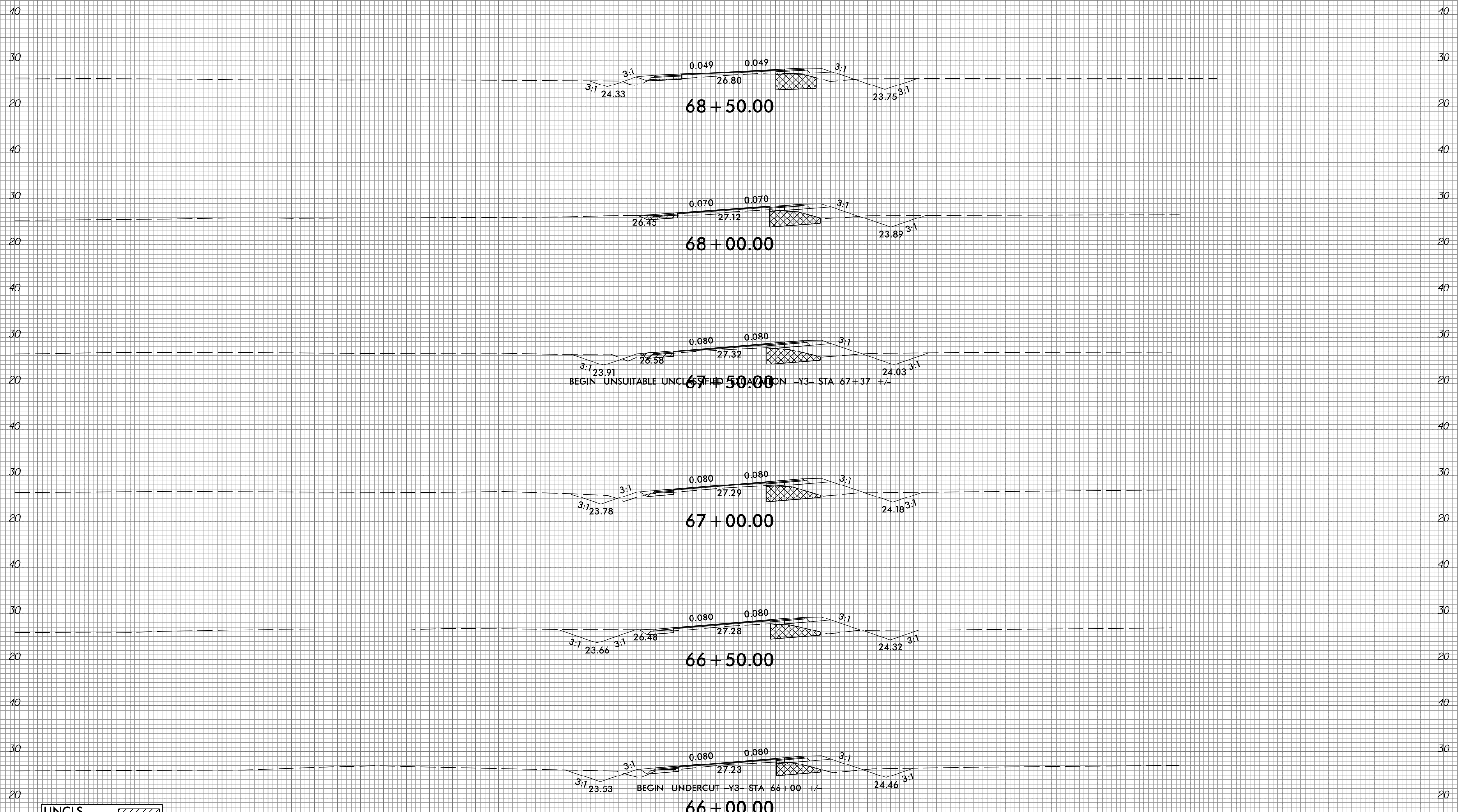

68+50.00

68+00.00

67+50.00

67+00.00

66+50.00

66+00.00

BEGIN UNSUITABLE UNCL. FIELD DRAINAGE ON -Y3- STA. 67+37 +/-

BEGIN UNDERCUT -Y3- STA. 66+00 +/-

-Y3-

| | |
|----------------------|--|
| UNCLS UNSUIT | |
| PROPOSED UNDERCUT | |

150 140 130 120 110 100 90 80 70 60 50 40 30 20 10 0 10 20 30 40 50 60 70 80 90 100 110 120 130 140 150

10/31/2018
G:\RA\9729-02\CADD\1015\Roadway\XSC\1015_xp1_Y3.dgn
gncdjin

6/23/16



PROJ. REFERENCE NO.
R-1015

SHEET NO.
X-349

150 140 130 120 110 100 90 80 70 60 50 40 30 20 10 0 10 20 30 40 50 60 70 80 90 100 110 120 130 140 150

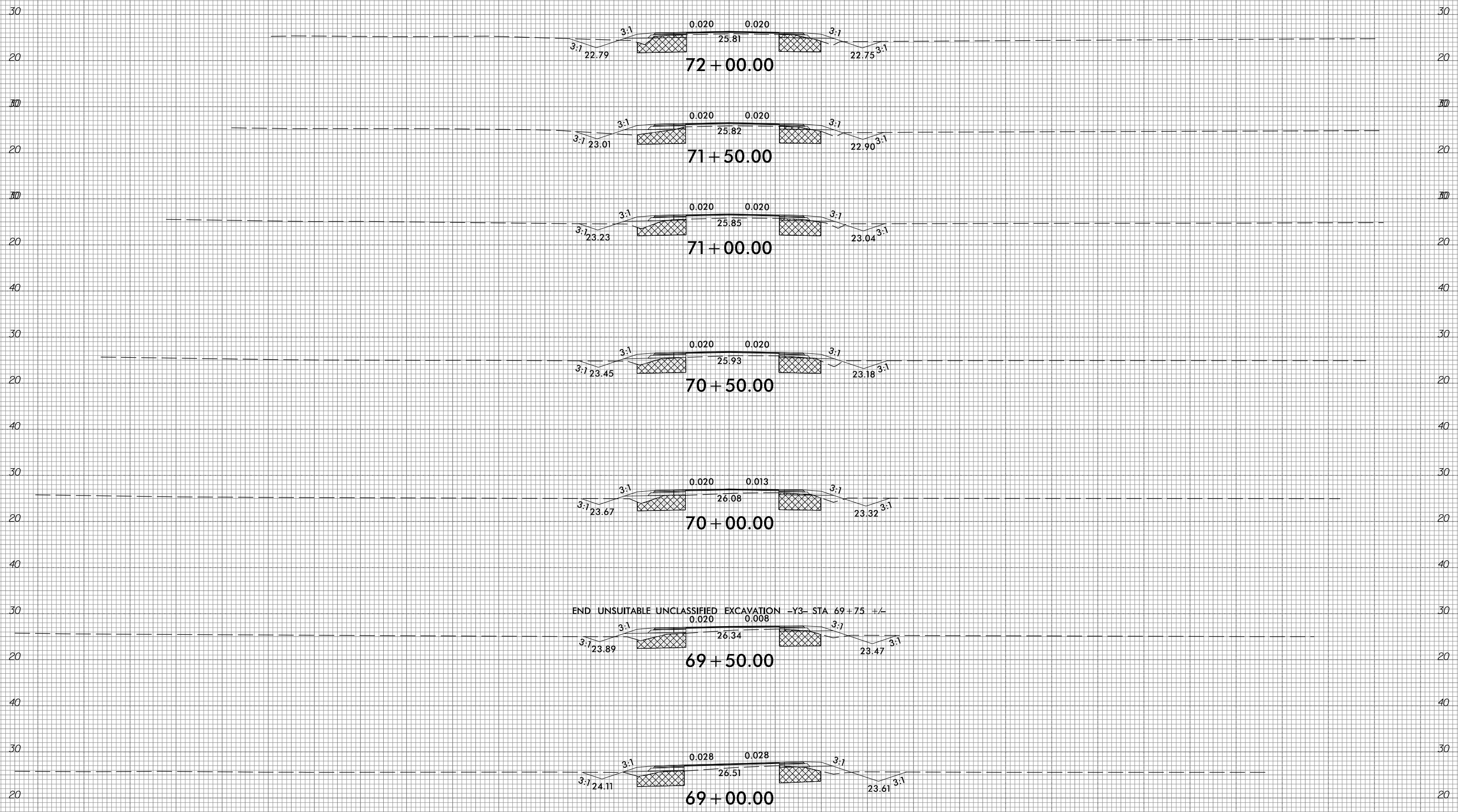

END UNSUITABLE UNCLASSIFIED EXCAVATION -Y3- STA 69+75 +/-

PROPOSED UNDERCUT

-Y3-

150 140 130 120 110 100 90 80 70 60 50 40 30 20 10 0 10 20 30 40 50 60 70 80 90 100 110 120 130 140 150

10/31/2018
G:\RA\9729-02\CADD\1015\Roadway\XSC\1015_xp1_Y3.dgn
gncdlin

6/23/16



PROJ. REFERENCE NO.
R-1015

SHEET NO.
X-350

150 140 130 120 110 100 90 80 70 60 50 40 30 20 10 0 10 20 30 40 50 60 70 80 90 100 110 120 130 140 150

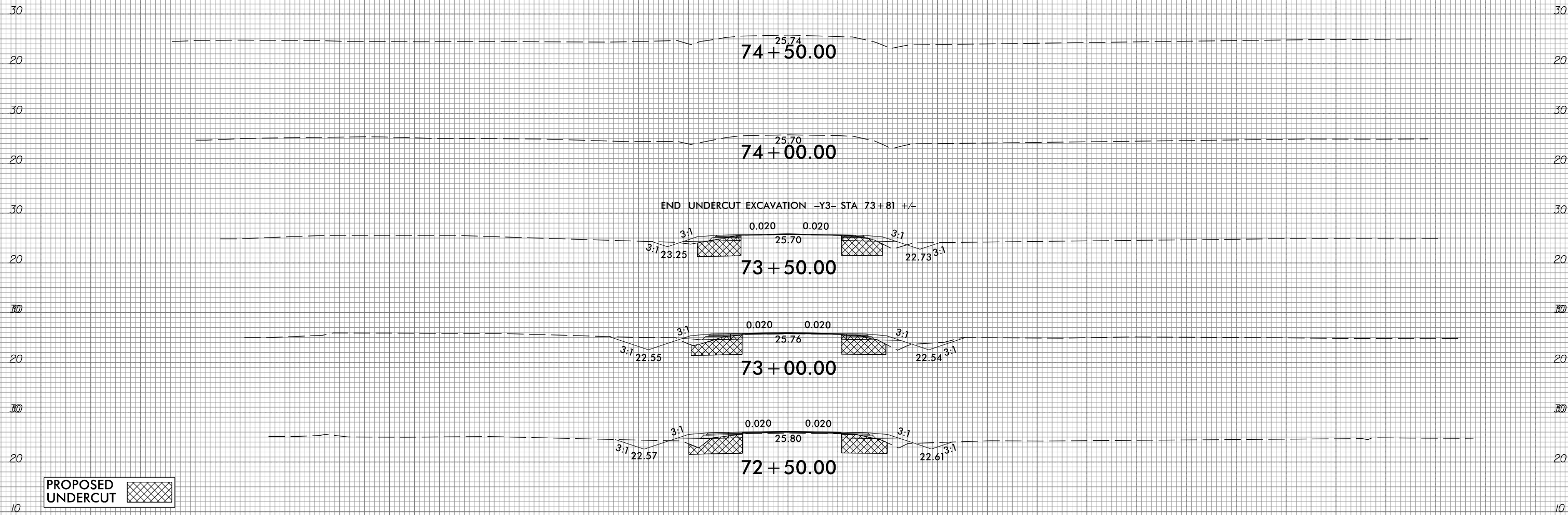

PROPOSED UNDERCUT



-Y3-

150 140 130 120 110 100 90 80 70 60 50 40 30 20 10 0 10 20 30 40 50 60 70 80 90 100 110 120 130 140 150

10/31/2018
G:\RA\9729-02\CADD\1015\Roadway\XSC\1015_xp1_Y3.dgn
gmc311

6/23/16



PROJ. REFERENCE NO.
R-1015

SHEET NO.
X-351

150 140 130 120 110 100 90 80 70 60 50 40 30 20 10 0 10 20 30 40 50 60 70 80 90 100 110 120 130 140 150

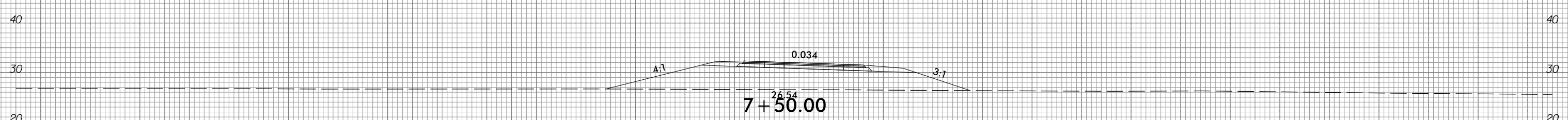
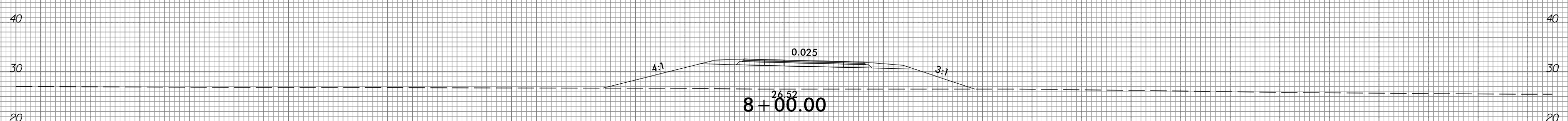
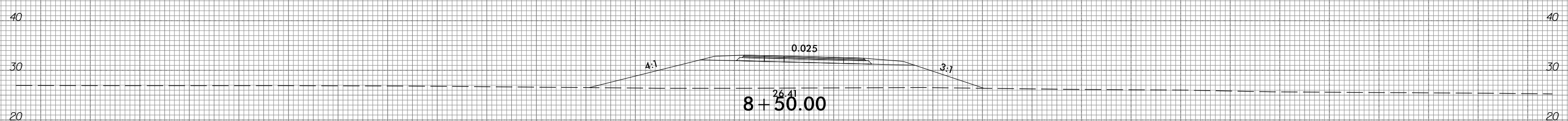
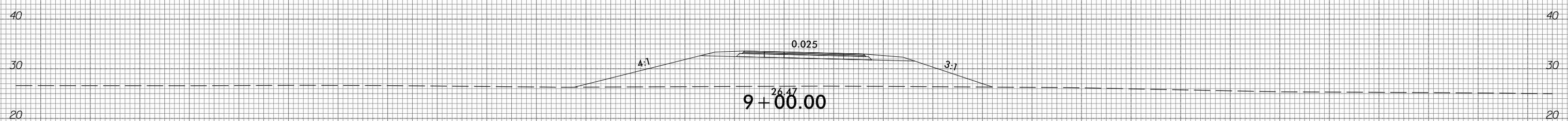
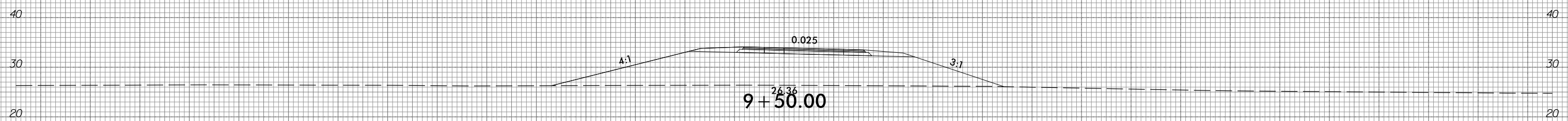
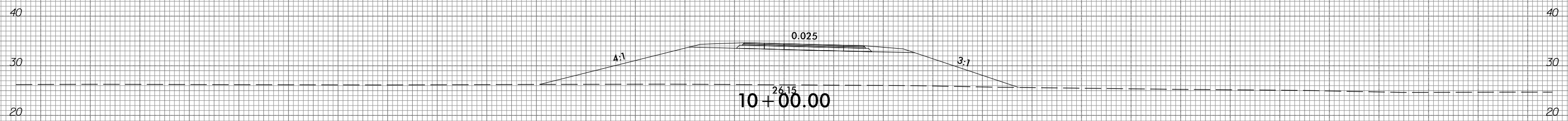

-Y3RPA-

150 140 130 120 110 100 90 80 70 60 50 40 30 20 10 0 10 20 30 40 50 60 70 80 90 100 110 120 130 140 150

10/31/2018
G:\RA\9729-02\CADD\1015\Roadway\XSC\1015.sp1.Y3RPA.dgn
gncdlin

6/23/16



PROJ. REFERENCE NO.
R-1015

SHEET NO.
X-352

150 140 130 120 110 100 90 80 70 60 50 40 30 20 10 0 10 20 30 40 50 60 70 80 90 100 110 120 130 140 150

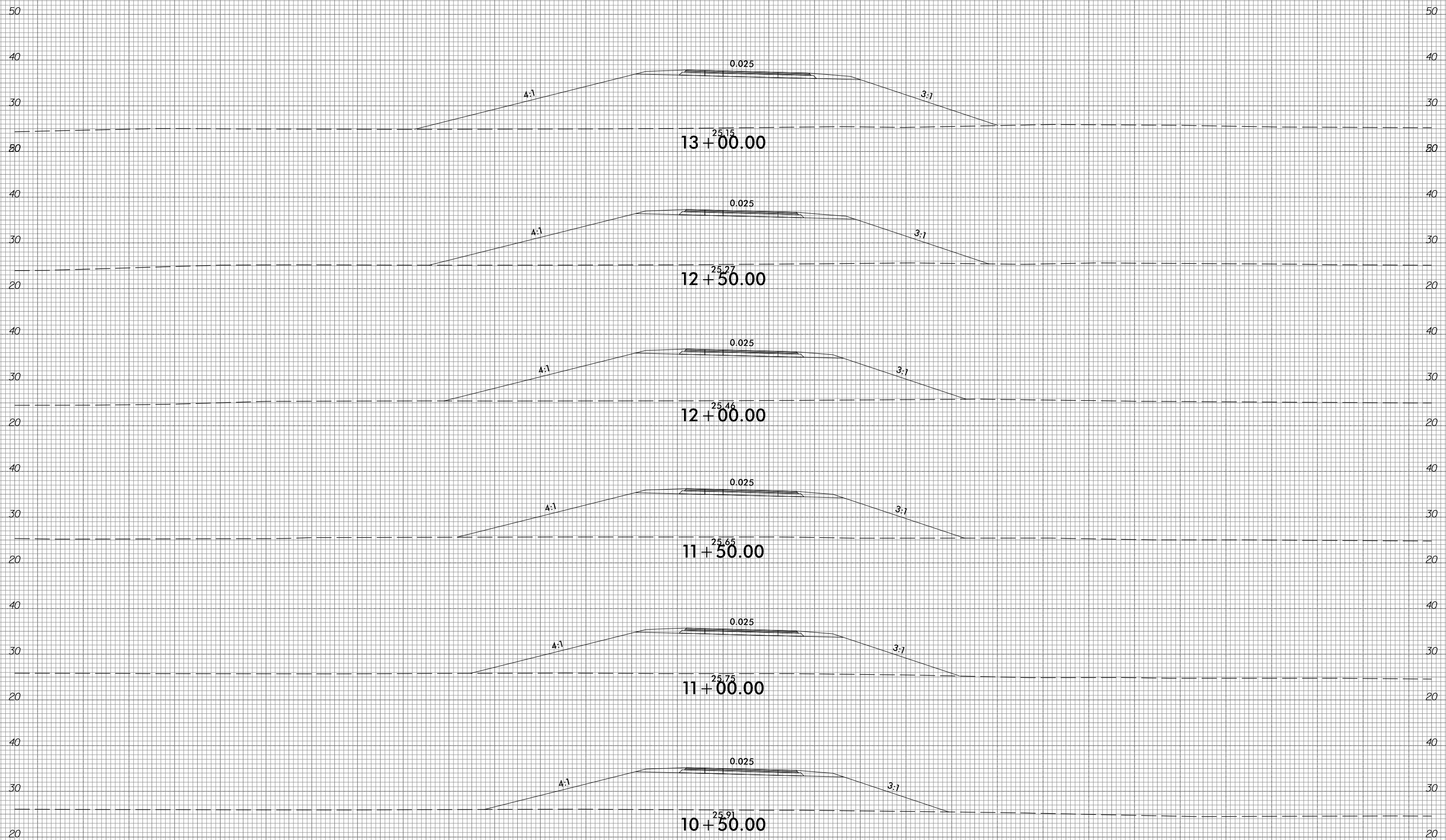

10+50.00
-Y3RPA-

150 140 130 120 110 100 90 80 70 60 50 40 30 20 10 0 10 20 30 40 50 60 70 80 90 100 110 120 130 140 150

10/31/2018
G:\RA\9729-02\CADD\1015\Roadway\XSC\1015.sp1.Y3RPA.dgn
gncdlin

150 140 130 120 110 100 90 80 70 60 50 40 30 20 10 0 10 20 30 40 50 60 70 80 90 100 110 120 130 140 150

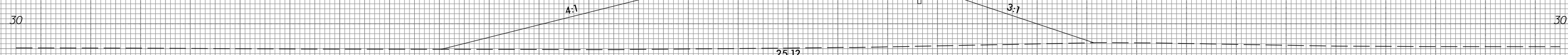
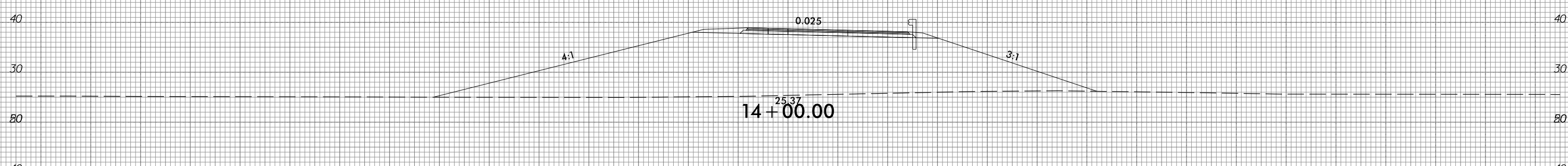
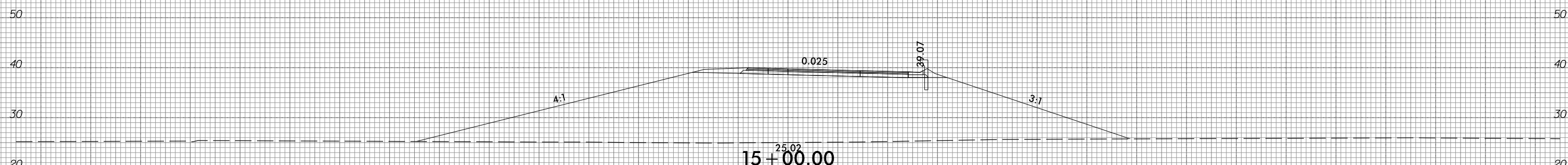
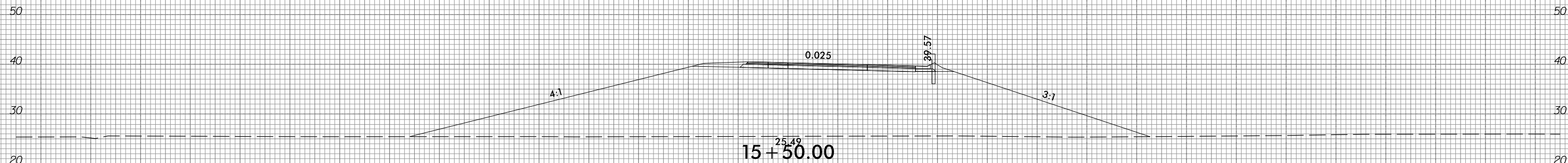

-Y3RPA-

150 140 130 120 110 100 90 80 70 60 50 40 30 20 10 0 10 20 30 40 50 60 70 80 90 100 110 120 130 140 150

6/23/16



PROJ. REFERENCE NO.
R-1015

SHEET NO.
X-354

150 140 130 120 110 100 90 80 70 60 50 40 30 20 10 0 10 20 30 40 50 60 70 80 90 100 110 120 130 140 150

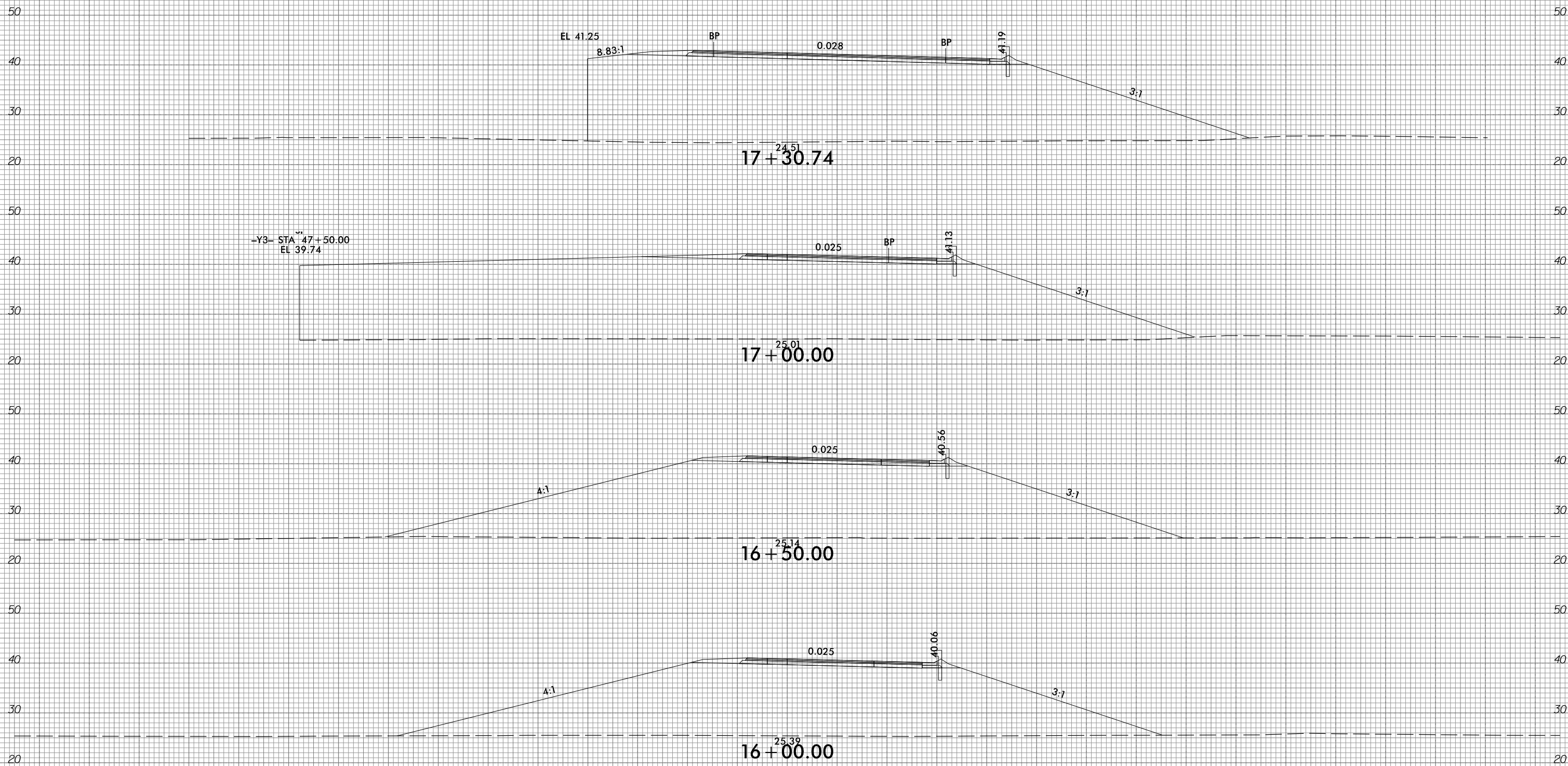

150 140 130 120 110 100 90 80 70 60 50 40 30 20 10 0 10 20 30 40 50 60 70 80 90 100 110 120 130 140 150

10/31/2018
G:\RA\9729-02\CADD\1015\Roadway\XSC\1015_xp1_Y3RPA.dgn
gncdlin

150 140 130 120 110 100 90 80 70 60 50 40 30 20 10 0 10 20 30 40 50 60 70 80 90 100 110 120 130 140 150

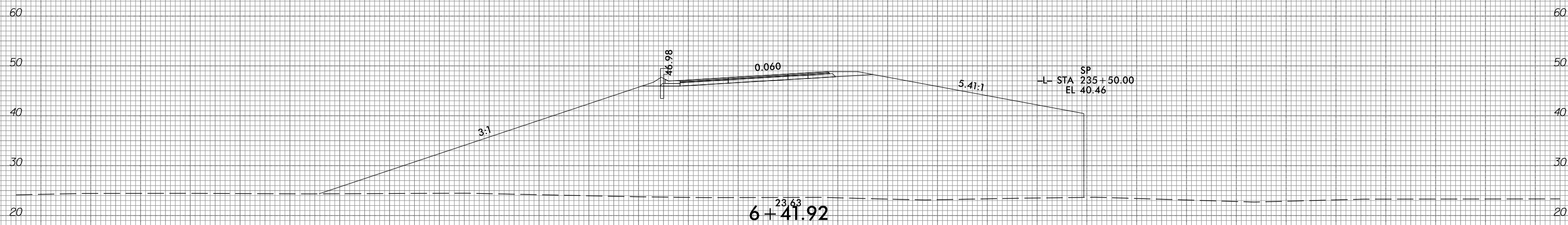
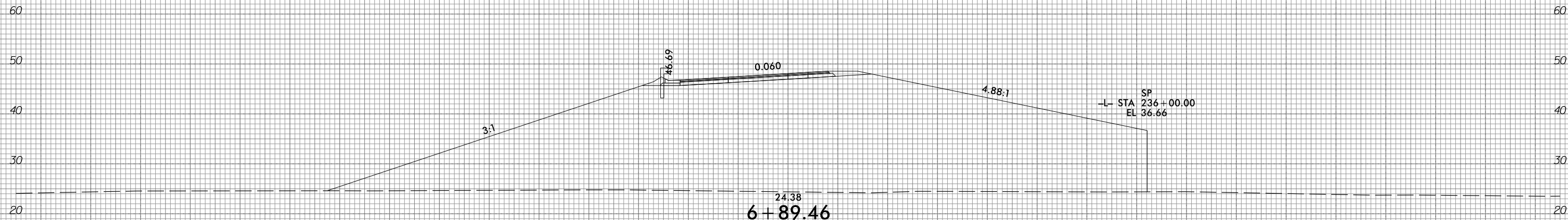
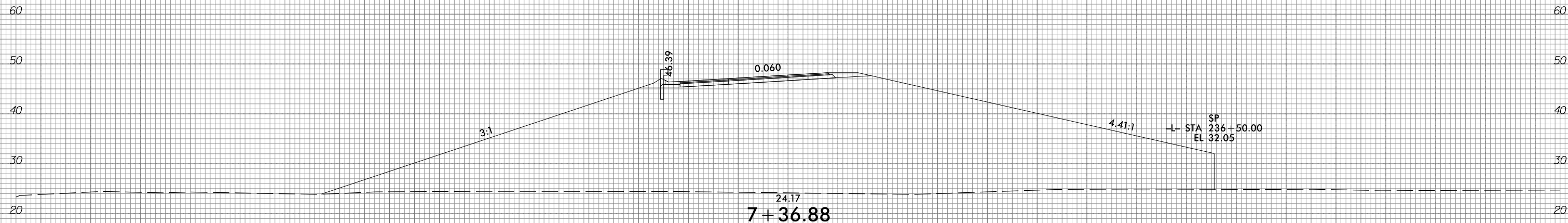

-Y3RPB-

150 140 130 120 110 100 90 80 70 60 50 40 30 20 10 0 10 20 30 40 50 60 70 80 90 100 110 120 130 140 150

6/23/16



| |
|---------------------|
| PROJ. REFERENCE NO. |
| R-1015 |

| |
|-----------|
| SHEET NO. |
| X-356 |

150 140 130 120 110 100 90 80 70 60 50 40 30 20 10 0 10 20 30 40 50 60 70 80 90 100 110 120 130 140 150

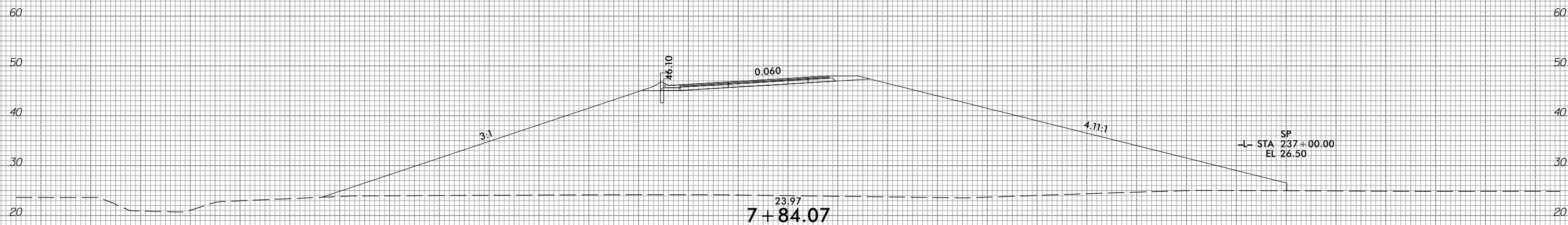
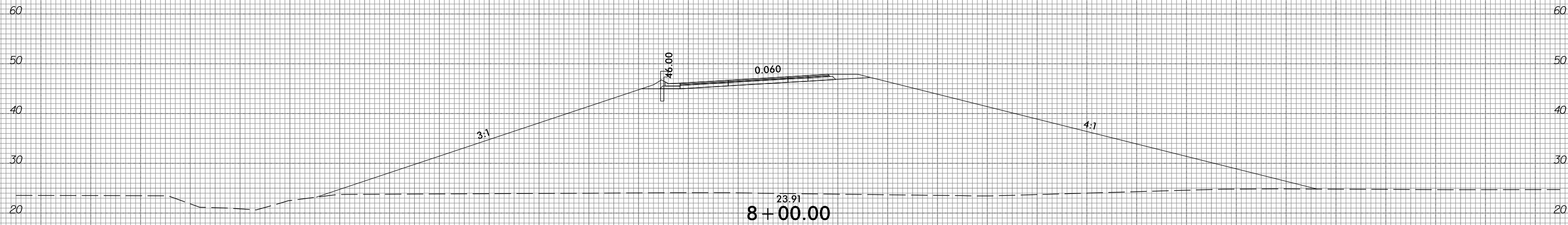
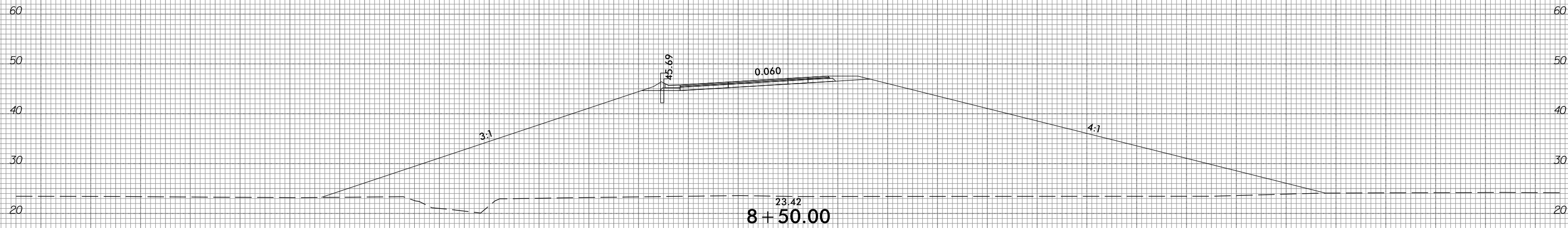

-Y3RPB-

10/31/2018
 G:\RA\9729-02\CADD\1015\Roadway\XSC\1015_xp1_Y3RPB.dgn
 gmc31in



150 140 130 120 110 100 90 80 70 60 50 40 30 20 10 0 10 20 30 40 50 60 70 80 90 100 110 120 130 140 150

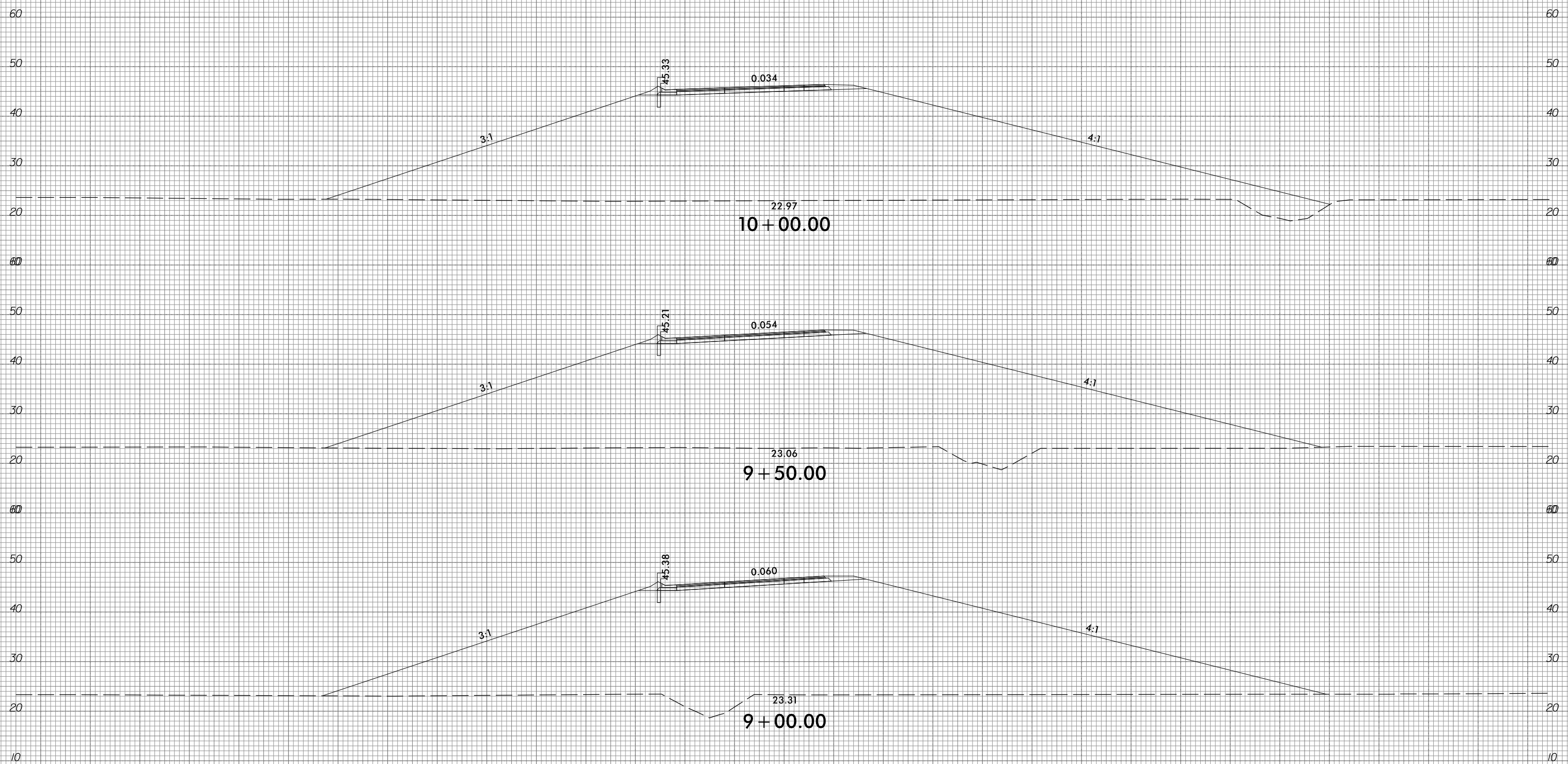

-Y3RPB-

150 140 130 120 110 100 90 80 70 60 50 40 30 20 10 0 10 20 30 40 50 60 70 80 90 100 110 120 130 140 150



150 140 130 120 110 100 90 80 70 60 50 40 30 20 10 0 10 20 30 40 50 60 70 80 90 100 110 120 130 140 150

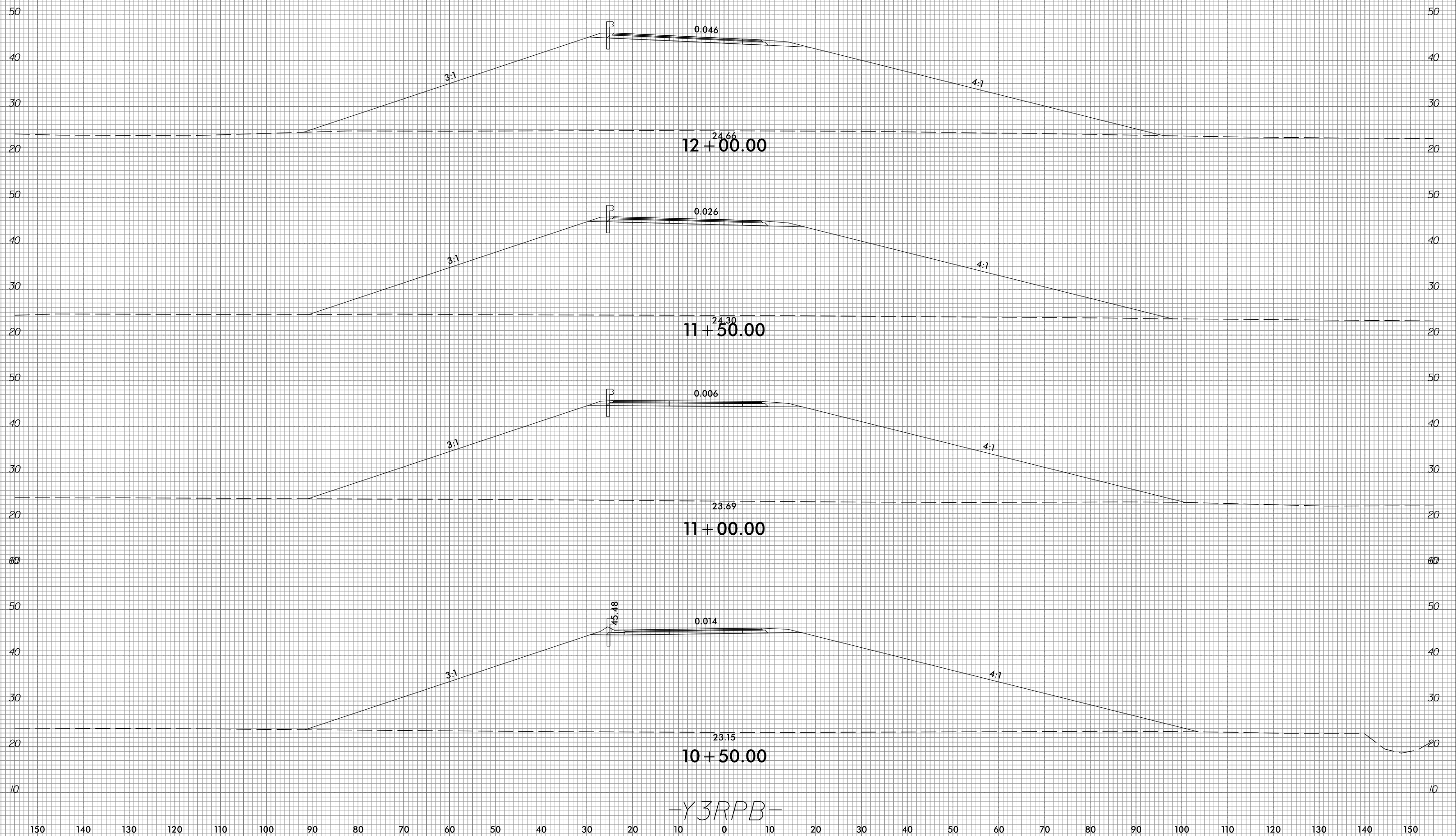

-Y3RPB-



150 140 130 120 110 100 90 80 70 60 50 40 30 20 10 0 10 20 30 40 50 60 70 80 90 100 110 120 130 140 150

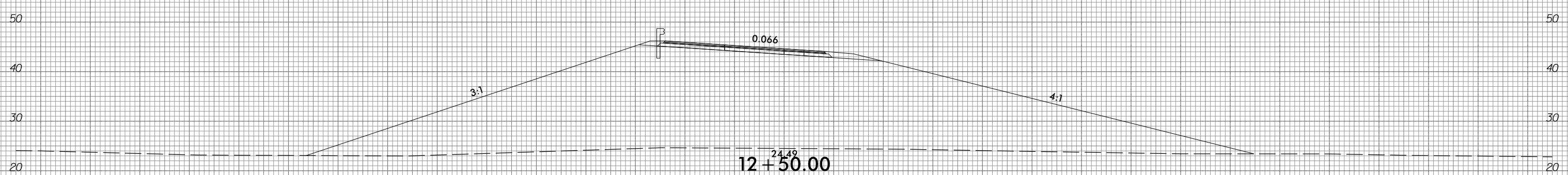
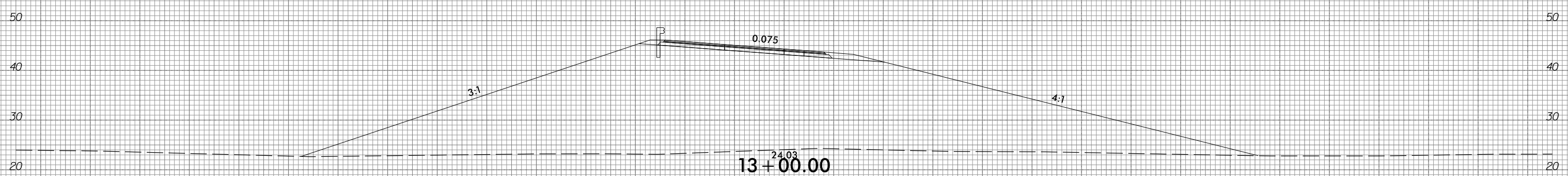
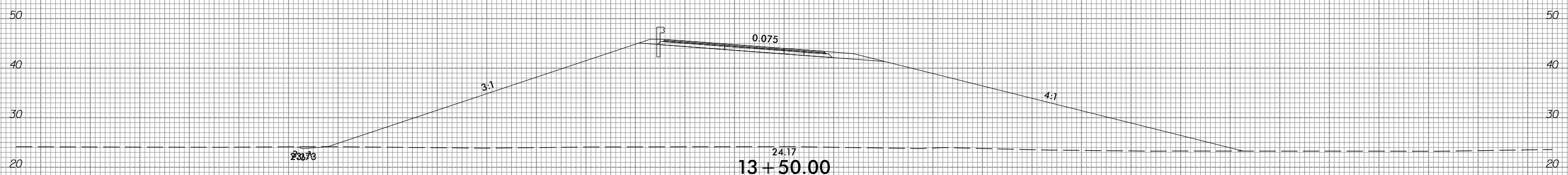
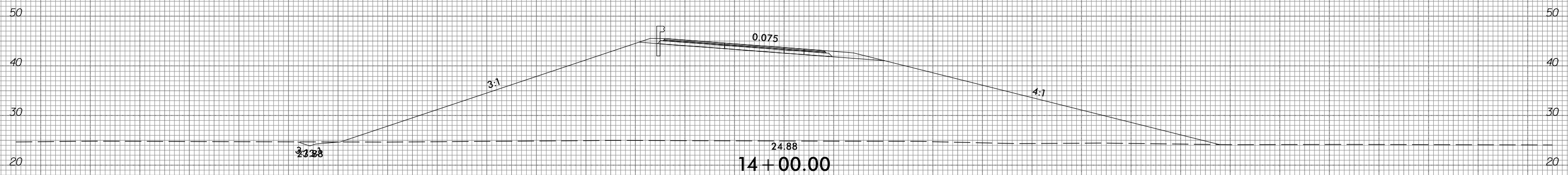

-Y3RPB-

150 140 130 120 110 100 90 80 70 60 50 40 30 20 10 0 10 20 30 40 50 60 70 80 90 100 110 120 130 140 150

6/23/16



PROJ. REFERENCE NO.
R-1015

SHEET NO.
X-360

150 140 130 120 110 100 90 80 70 60 50 40 30 20 10 0 10 20 30 40 50 60 70 80 90 100 110 120 130 140 150

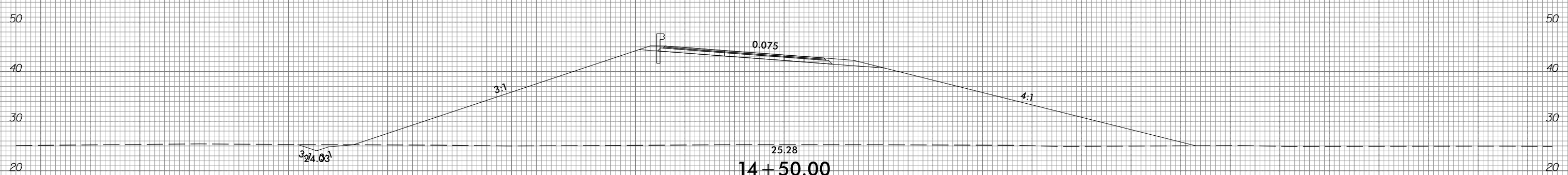
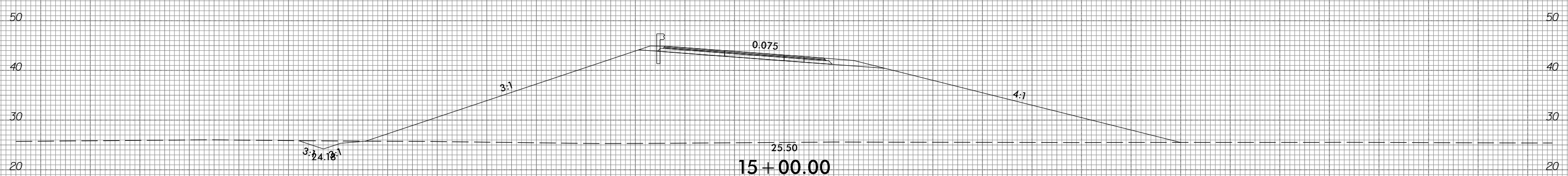
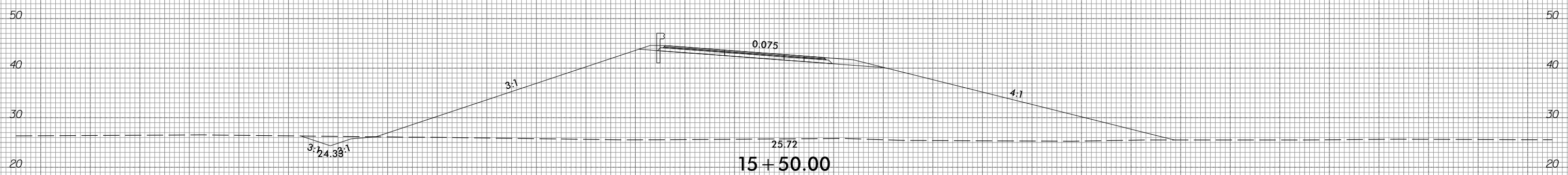
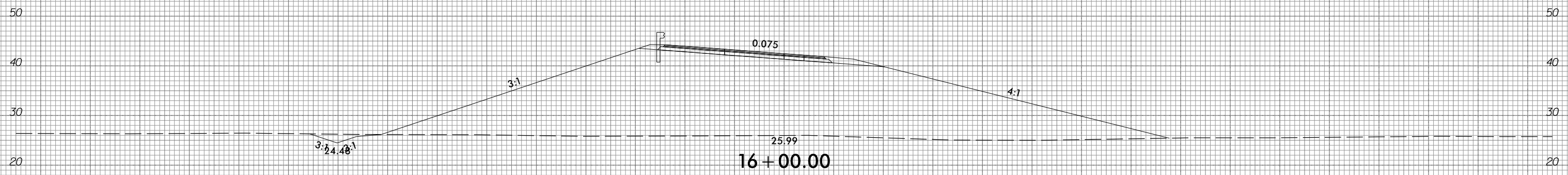

-Y3RPB-

150 140 130 120 110 100 90 80 70 60 50 40 30 20 10 0 10 20 30 40 50 60 70 80 90 100 110 120 130 140 150

10/31/2018
G:\RA\9729-02\CADD\1015\Roadway\XSC\1015_xp1_Y3RPB.dgn
gncdlin

6/23/16



PROJ. REFERENCE NO.
R-1015

SHEET NO.
X-361

150 140 130 120 110 100 90 80 70 60 50 40 30 20 10 0 10 20 30 40 50 60 70 80 90 100 110 120 130 140 150

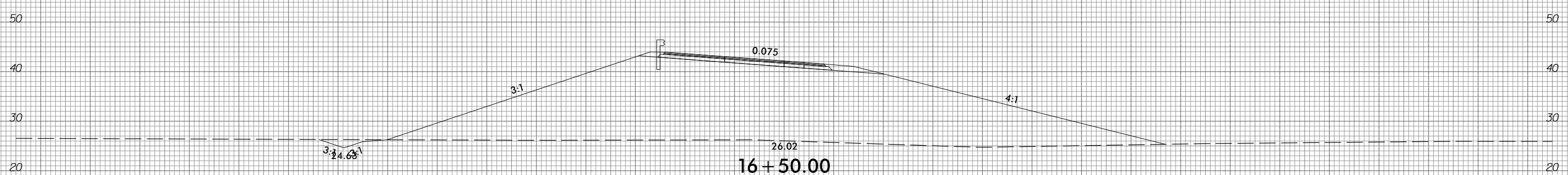
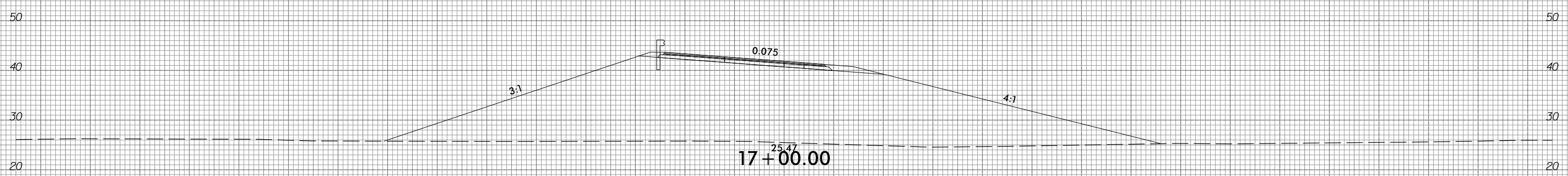
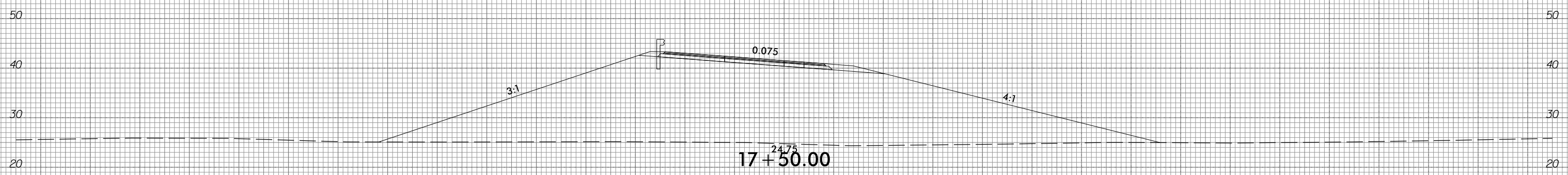
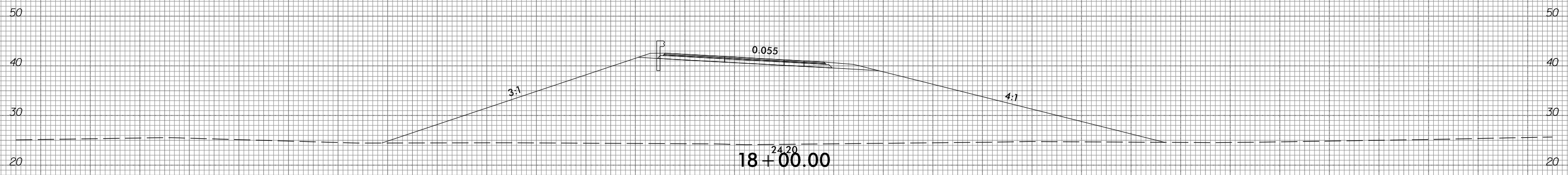

-Y3RPB-

150 140 130 120 110 100 90 80 70 60 50 40 30 20 10 0 10 20 30 40 50 60 70 80 90 100 110 120 130 140 150

10/31/2018
G:\RA\9729-02\CADD\1015\Roadway\XSC\1015_xp1_Y3RPB.dgn
gncdlin

6/23/16



PROJ. REFERENCE NO.
R-1015

SHEET NO.
X-362

150 140 130 120 110 100 90 80 70 60 50 40 30 20 10 0 10 20 30 40 50 60 70 80 90 100 110 120 130 140 150

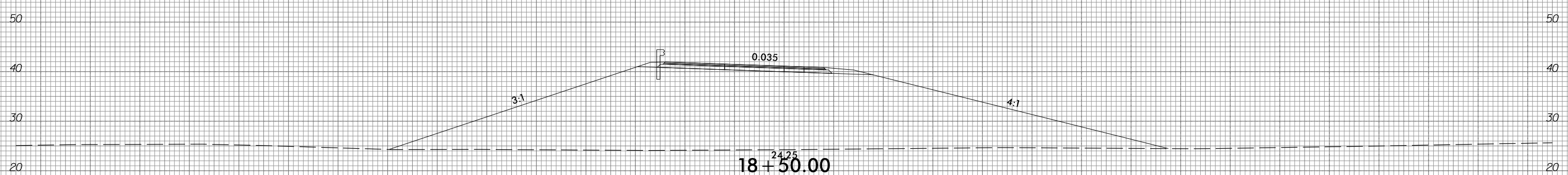
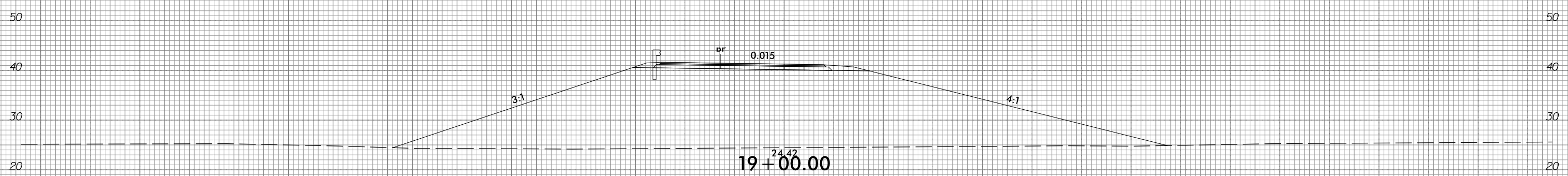
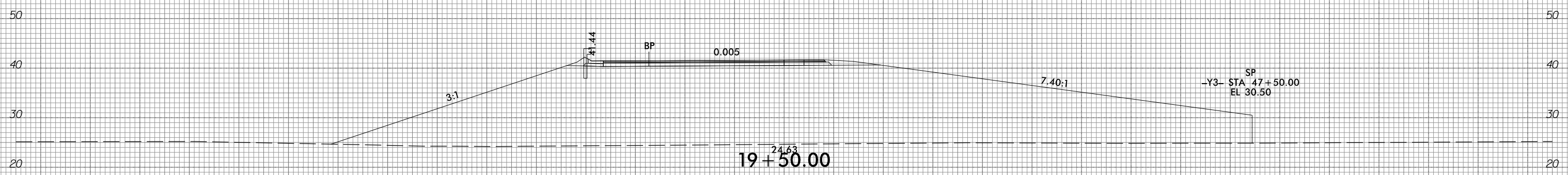
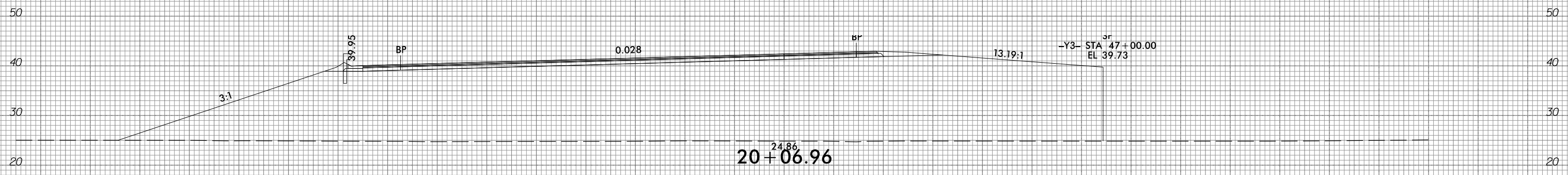

-Y3RPB-

150 140 130 120 110 100 90 80 70 60 50 40 30 20 10 0 10 20 30 40 50 60 70 80 90 100 110 120 130 140 150

10/31/2016
G:\RA\9729-02\CADD\1015\Roadway\XSC\1015_xp1_Y3RPB.dgn
gncdlin

6/23/16



| |
|---------------------|
| PROJ. REFERENCE NO. |
| R-1015 |

| |
|-----------|
| SHEET NO. |
| X-363 |

150 140 130 120 110 100 90 80 70 60 50 40 30 20 10 0 10 20 30 40 50 60 70 80 90 100 110 120 130 140 150

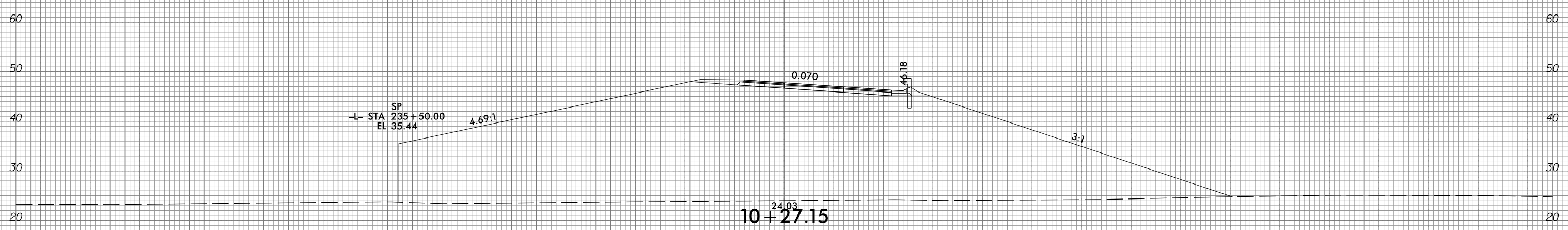
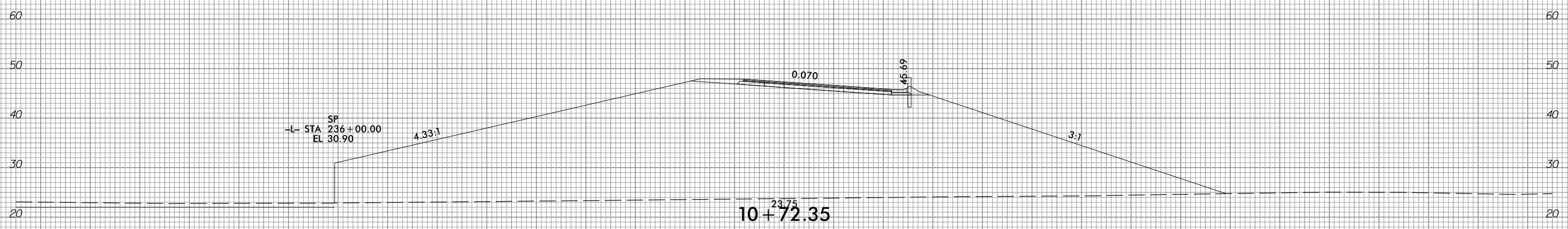
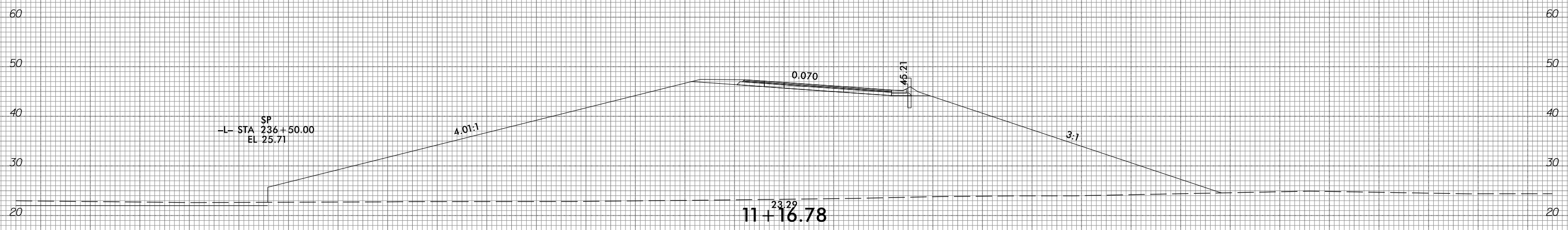

-Y3RPC-

150 140 130 120 110 100 90 80 70 60 50 40 30 20 10 0 10 20 30 40 50 60 70 80 90 100 110 120 130 140 150

10/31/2018
 G:\RA\9729-02\CADD\1015\Roadway\XSC\1015_xp1_Y3RPC.dgn
 gmc31in

6/23/16



| | |
|---------------------|--------|
| PROJ. REFERENCE NO. | R-1015 |
|---------------------|--------|

| | |
|-----------|-------|
| SHEET NO. | X-364 |
|-----------|-------|

150 140 130 120 110 100 90 80 70 60 50 40 30 20 10 0 10 20 30 40 50 60 70 80 90 100 110 120 130 140 150

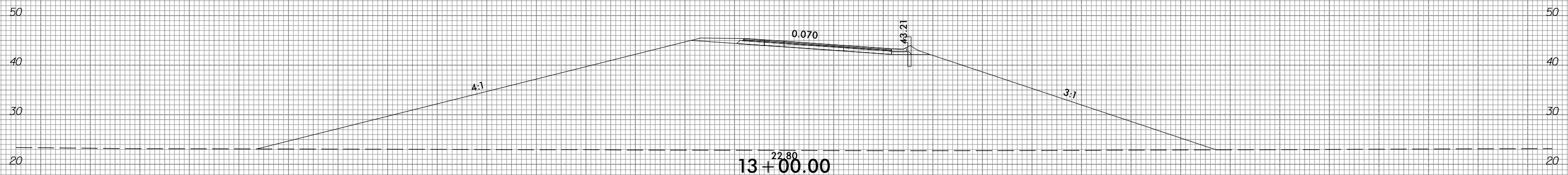

13+00.00
22.80

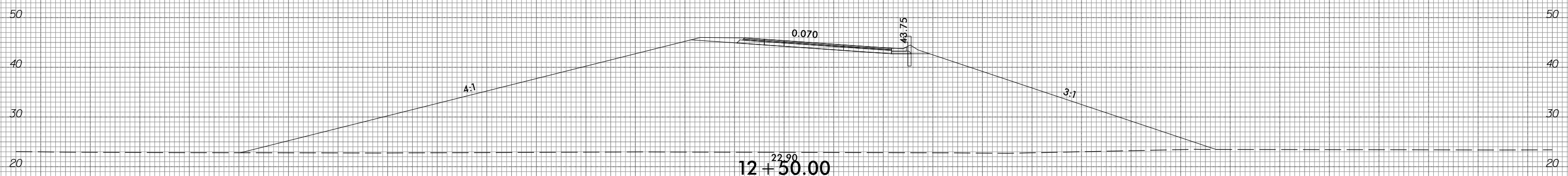

12+50.00
22.90

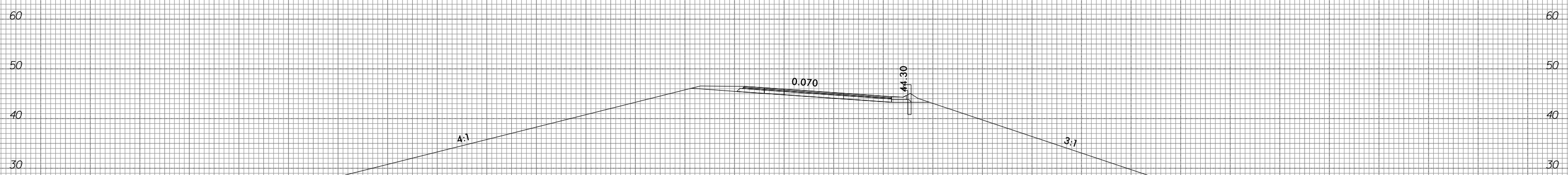

12+00.00
23.07

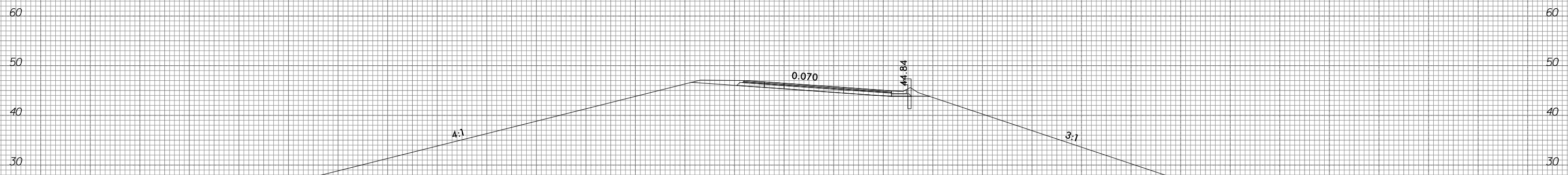

11+50.00
23.29

-Y3RPC-

150 140 130 120 110 100 90 80 70 60 50 40 30 20 10 0 10 20 30 40 50 60 70 80 90 100 110 120 130 140 150

10/31/2018
 G:\RA\9729-02\CADD\1015\Roadway\XSC\1015_xp1_Y3RPC.dgn
 gmc31in

6/23/16



PROJ. REFERENCE NO.
R-1015

SHEET NO.
X-365

150 140 130 120 110 100 90 80 70 60 50 40 30 20 10 0 10 20 30 40 50 60 70 80 90 100 110 120 130 140 150

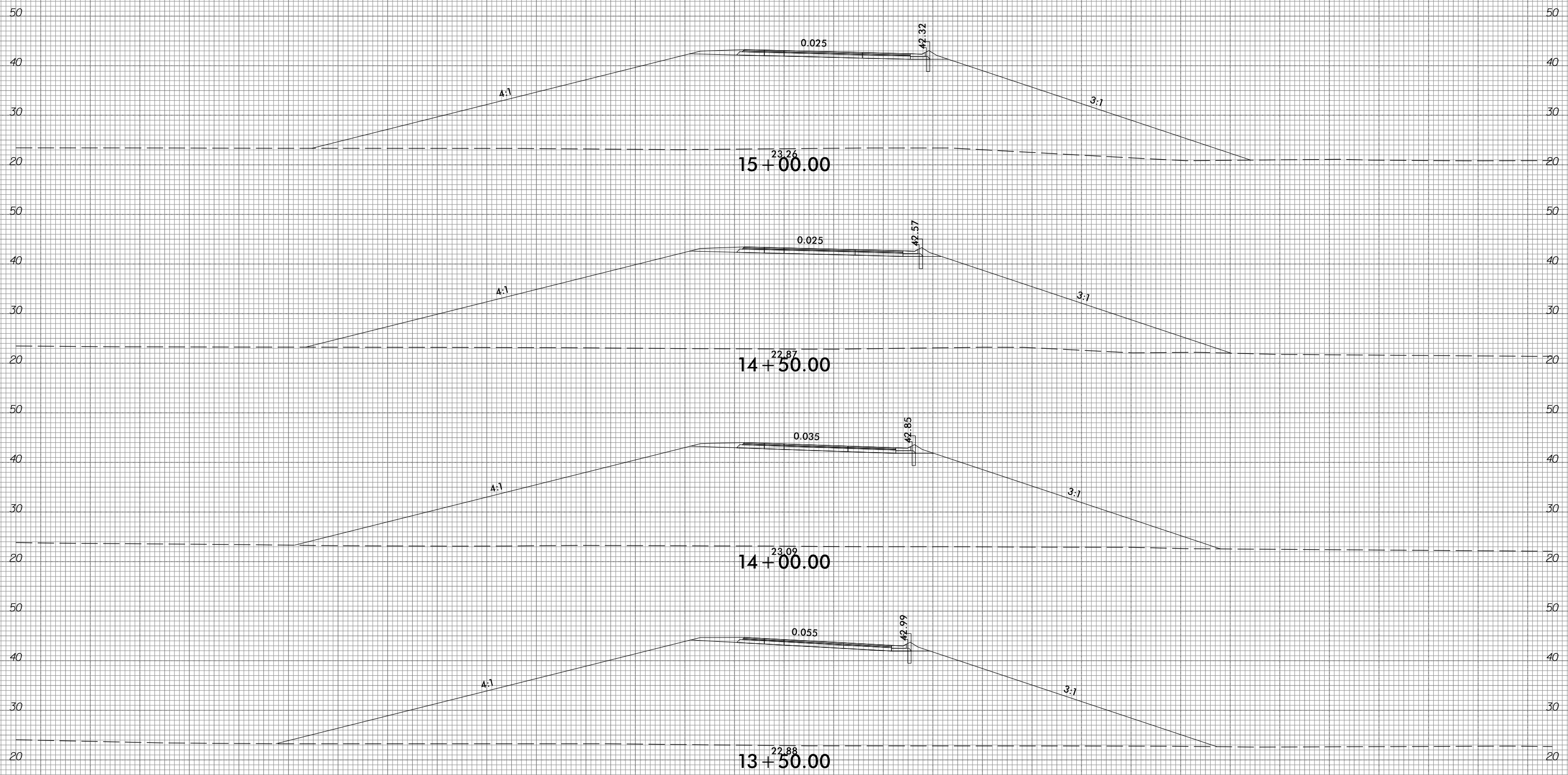

-Y3RPC-

10/31/2018
G:\RA\9729-02\CADD\1015\Roadway\XSC\1015_xp1_Y3RPC.dgn
gncdlin

150 140 130 120 110 100 90 80 70 60 50 40 30 20 10 0 10 20 30 40 50 60 70 80 90 100 110 120 130 140 150

6/23/16



PROJ. REFERENCE NO.
R-1015

SHEET NO.
X-366

150 140 130 120 110 100 90 80 70 60 50 40 30 20 10 0 10 20 30 40 50 60 70 80 90 100 110 120 130 140 150

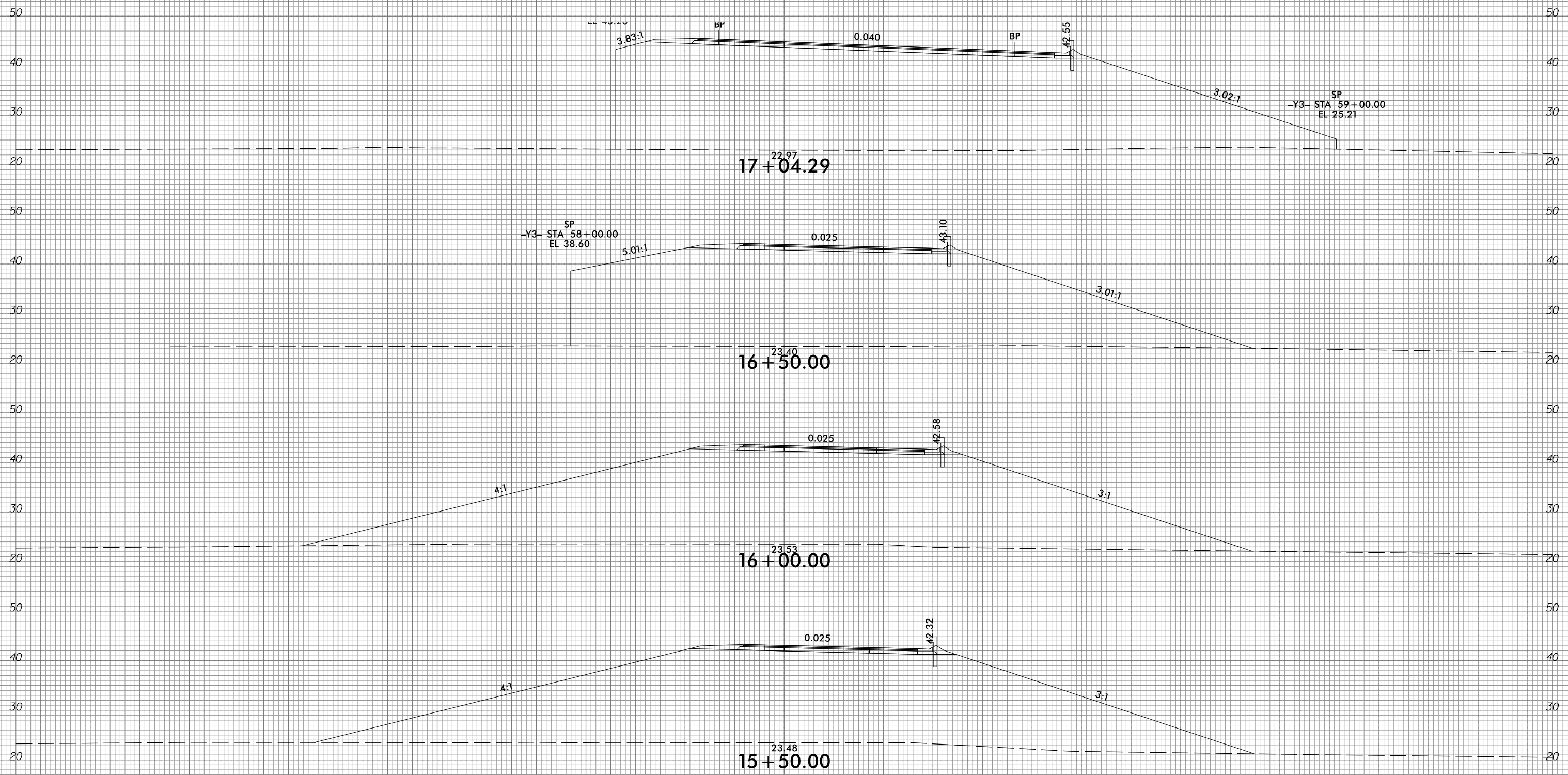

-Y3RPC-

10/31/2018
G:\RA\9729-02\CADD\1015\Roadway\XSC\1015_xp1_Y3RPC.dgn
gncdlin

6/23/16



PROJ. REFERENCE NO.
R-1015

SHEET NO.
X-367

150 140 130 120 110 100 90 80 70 60 50 40 30 20 10 0 10 20 30 40 50 60 70 80 90 100 110 120 130 140 150

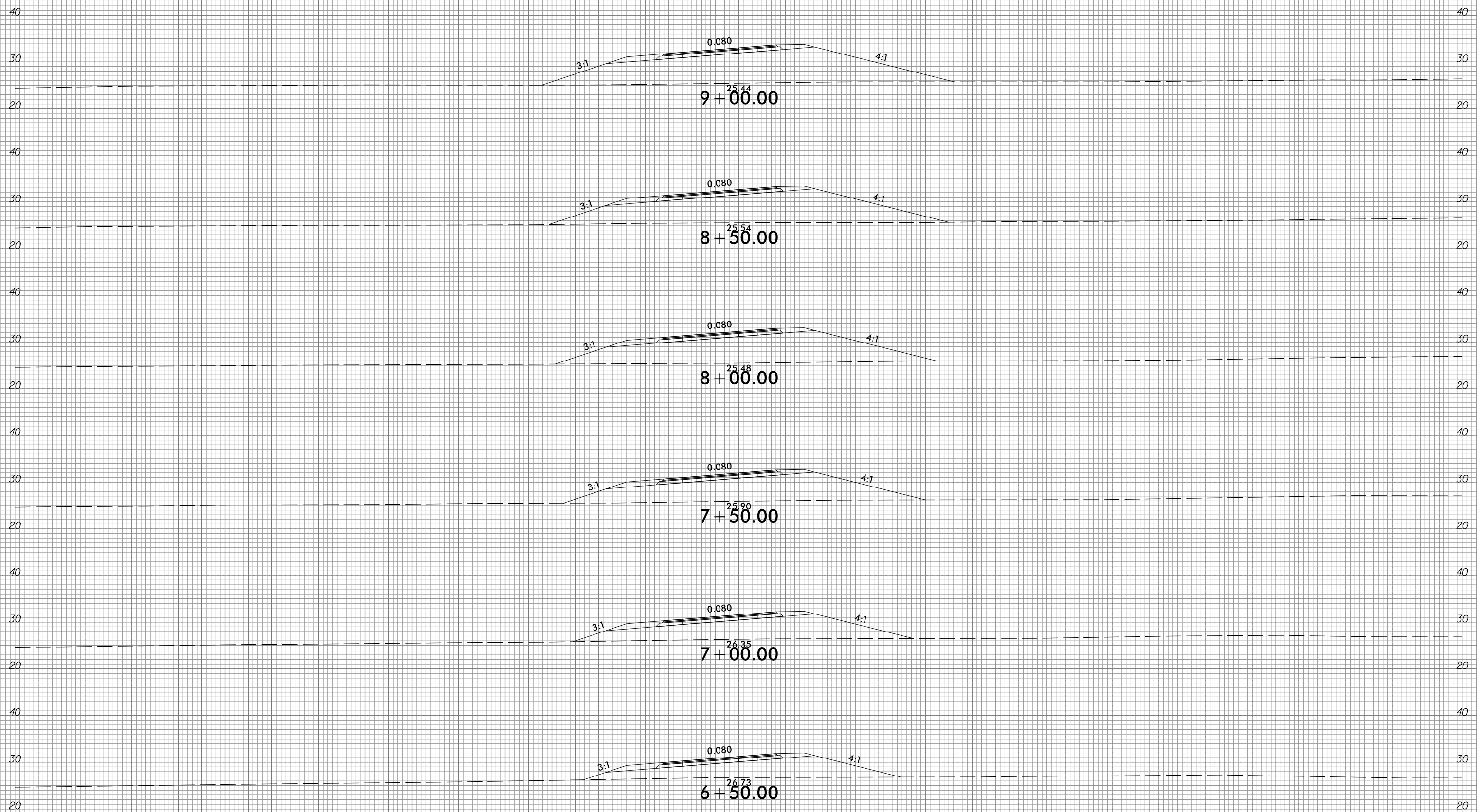

-Y3RPD-

150 140 130 120 110 100 90 80 70 60 50 40 30 20 10 0 10 20 30 40 50 60 70 80 90 100 110 120 130 140 150

10/31/2018
G:\RA\9729-02\CADD\1015\Roadway\XSC\1015_xp1_Y3RPD.dgn
gncdlin

6/23/16



PROJ. REFERENCE NO.
R-1015

SHEET NO.
X-368

150 140 130 120 110 100 90 80 70 60 50 40 30 20 10 0 10 20 30 40 50 60 70 80 90 100 110 120 130 140 150

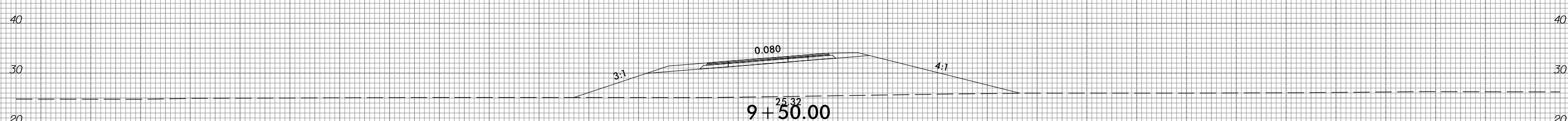
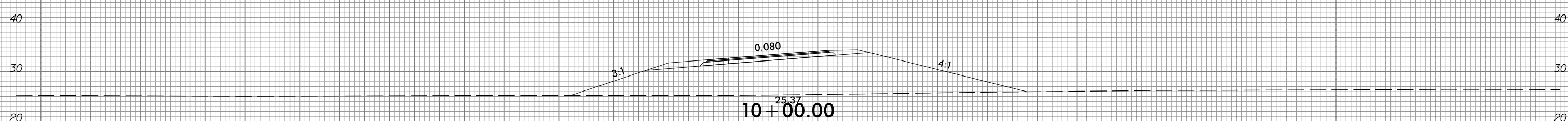
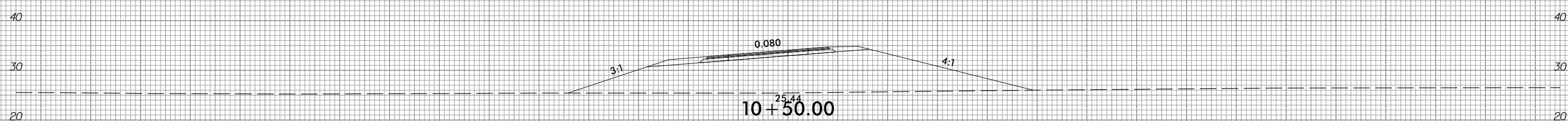
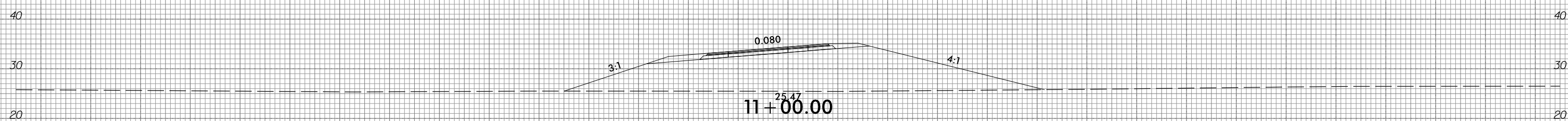
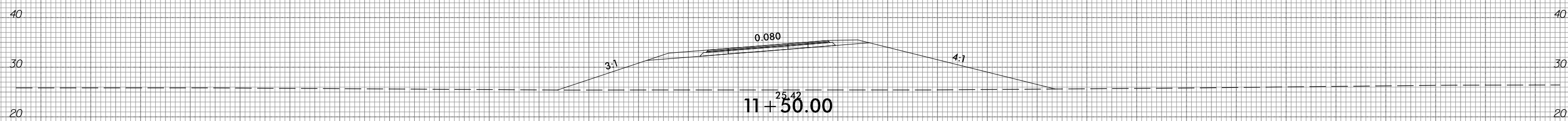
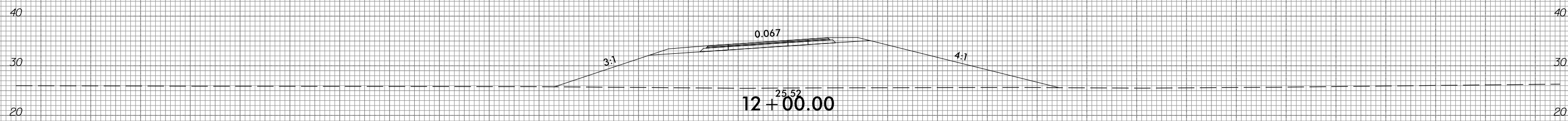

-Y3RPD-

150 140 130 120 110 100 90 80 70 60 50 40 30 20 10 0 10 20 30 40 50 60 70 80 90 100 110 120 130 140 150

10/31/2018
G:\RA\9729-02\CADD\1015\Roadway\XSC\1015.sp1.Y3RPD.dgn
gncdlin

6/23/16



PROJ. REFERENCE NO.
R-1015

SHEET NO.
X-369

150 140 130 120 110 100 90 80 70 60 50 40 30 20 10 0 10 20 30 40 50 60 70 80 90 100 110 120 130 140 150

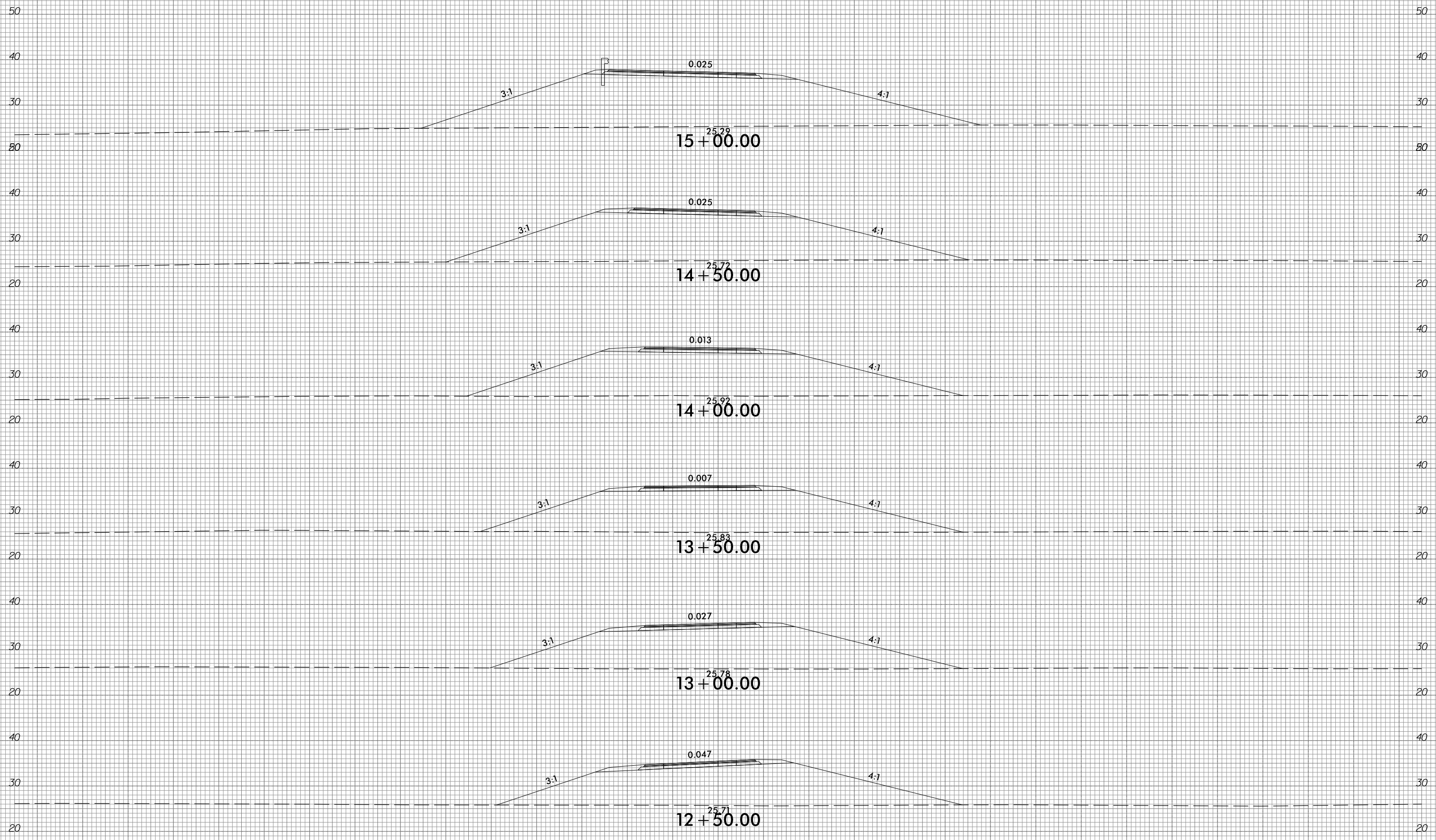

-Y3RPD-

150 140 130 120 110 100 90 80 70 60 50 40 30 20 10 0 10 20 30 40 50 60 70 80 90 100 110 120 130 140 150

10/31/2018
G:\RA\1729-02\CADD\1015\Roadway\XSC\1015_xp1_Y3RPD.dgn
gncdlin

6/23/16



| | |
|---------------------|-----------|
| PROJ. REFERENCE NO. | SHEET NO. |
| R-1015 | X-370 |

150 140 130 120 110 100 90 80 70 60 50 40 30 20 10 0 10 20 30 40 50 60 70 80 90 100 110 120 130 140 150

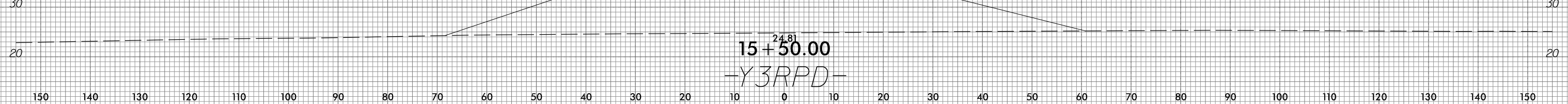
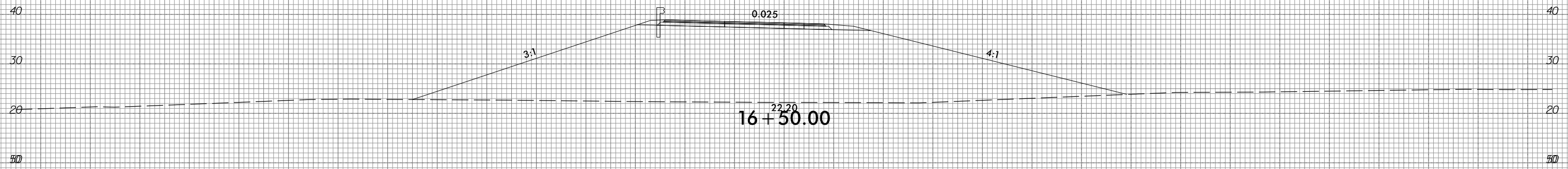
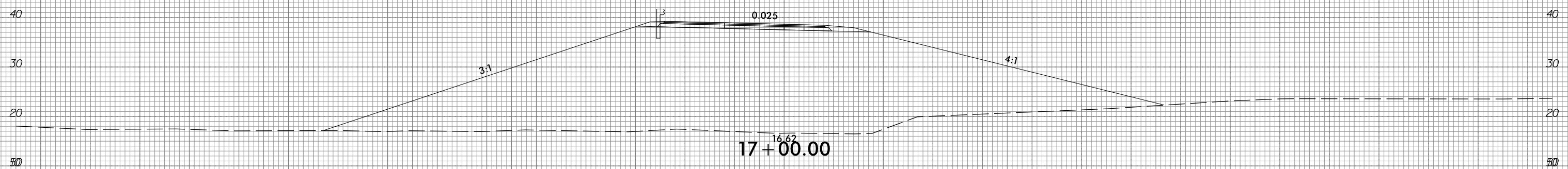
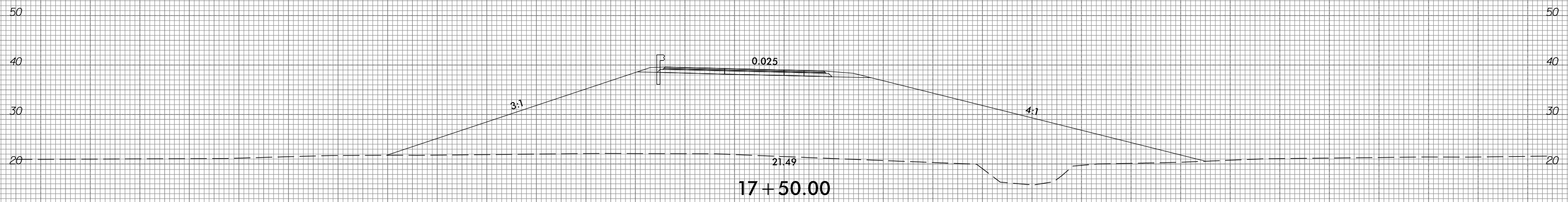

-Y3RPD-

150 140 130 120 110 100 90 80 70 60 50 40 30 20 10 0 10 20 30 40 50 60 70 80 90 100 110 120 130 140 150

10/31/2018
G:\RA\1729-02\CADD\1015\Roadway\XSC\1015_xpl_Y3RPD.dgn
gncdlin

6/23/16



PROJ. REFERENCE NO.
R-1015

SHEET NO.
X-371

150 140 130 120 110 100 90 80 70 60 50 40 30 20 10 0 10 20 30 40 50 60 70 80 90 100 110 120 130 140 150

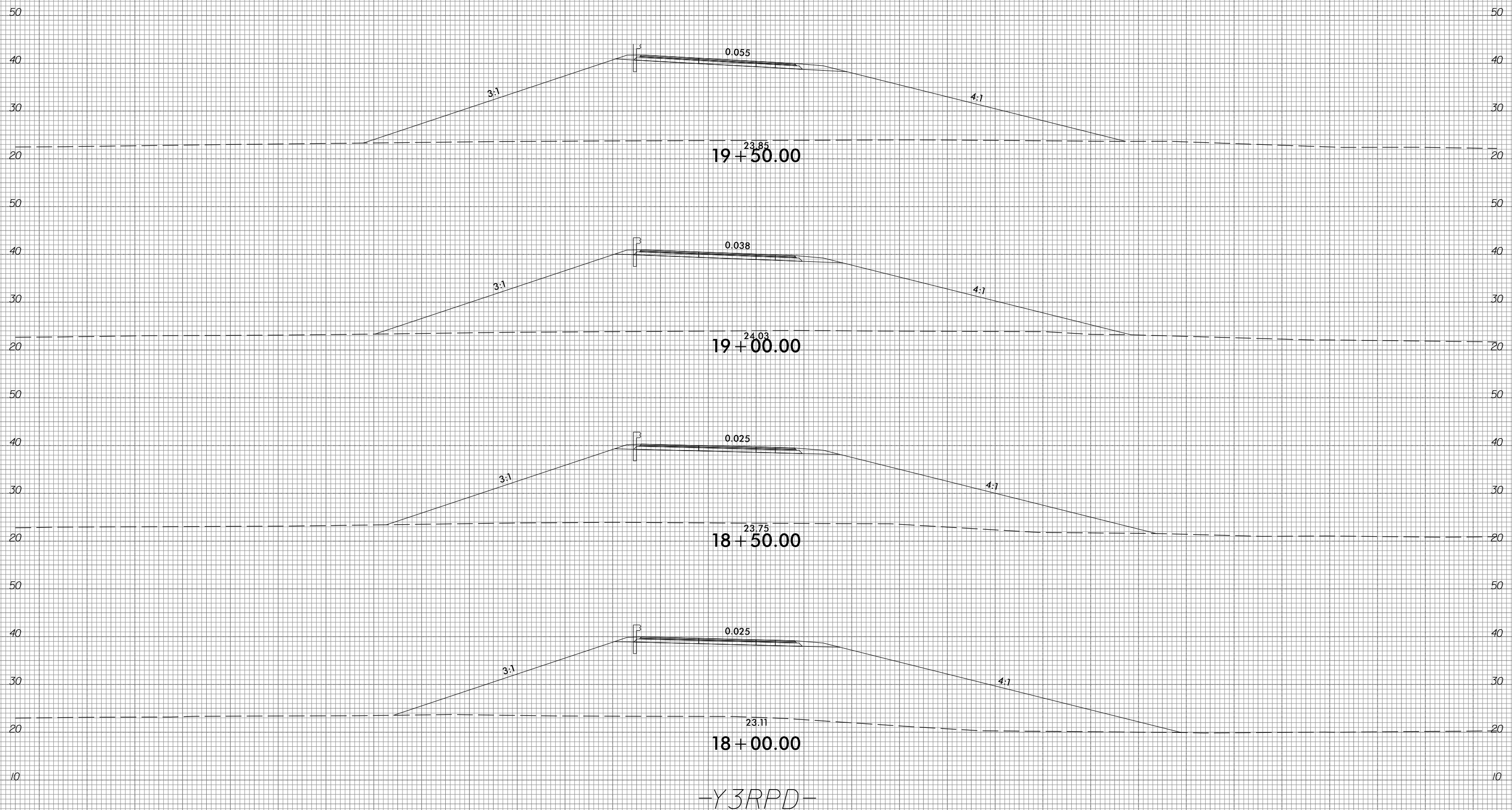

-Y3RPD-

10/31/2018
G:\RA\9729-02\CADD\1015\Roadway\XSC\1015_xp1_Y3RPD.dgn
gncdlin

6/23/16



| |
|---------------------|
| PROJ. REFERENCE NO. |
| R-1015 |

| |
|-----------|
| SHEET NO. |
| X-372 |

150 140 130 120 110 100 90 80 70 60 50 40 30 20 10 0 10 20 30 40 50 60 70 80 90 100 110 120 130 140 150

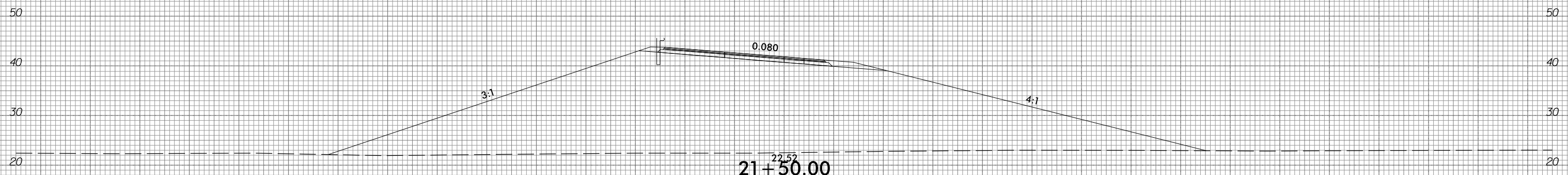

21+50.00
22.52

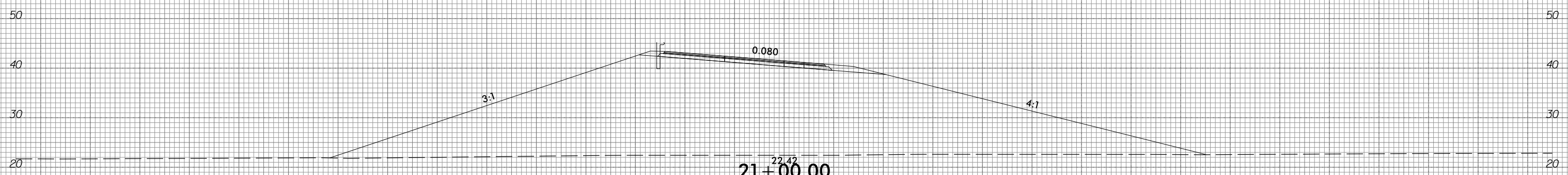

21+00.00
22.42

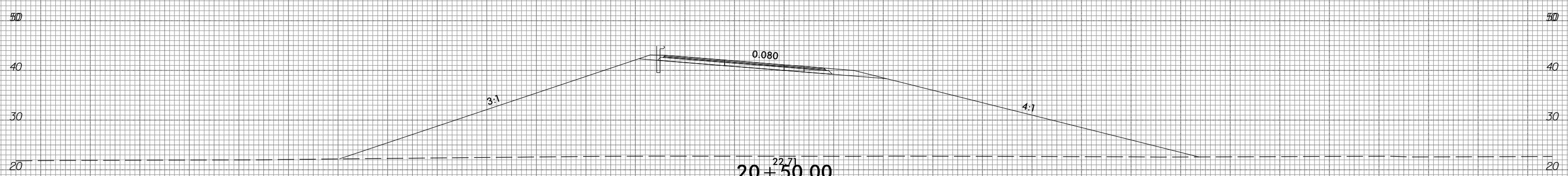

20+50.00
22.71

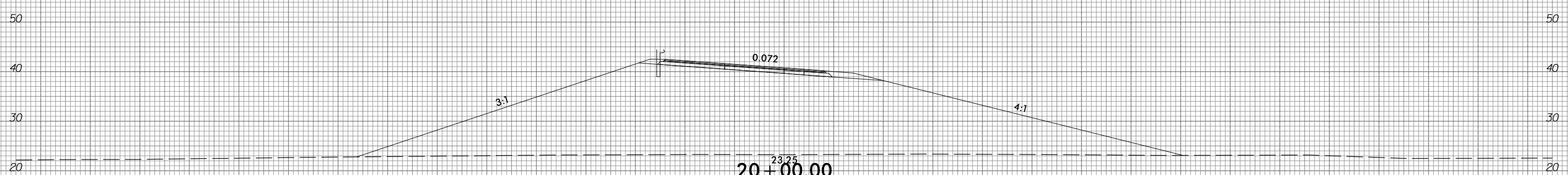

20+00.00
23.25

-Y3RPD-

150 140 130 120 110 100 90 80 70 60 50 40 30 20 10 0 10 20 30 40 50 60 70 80 90 100 110 120 130 140 150

10/31/2018
 G:\RA\9729-02\CADD\1015\Roadway\XSC\1015_xp1_Y3RPD.dgn
 gmc31in

6/23/16



PROJ. REFERENCE NO.
R-1015

SHEET NO.
X-373

150 140 130 120 110 100 90 80 70 60 50 40 30 20 10 0 10 20 30 40 50 60 70 80 90 100 110 120 130 140 150

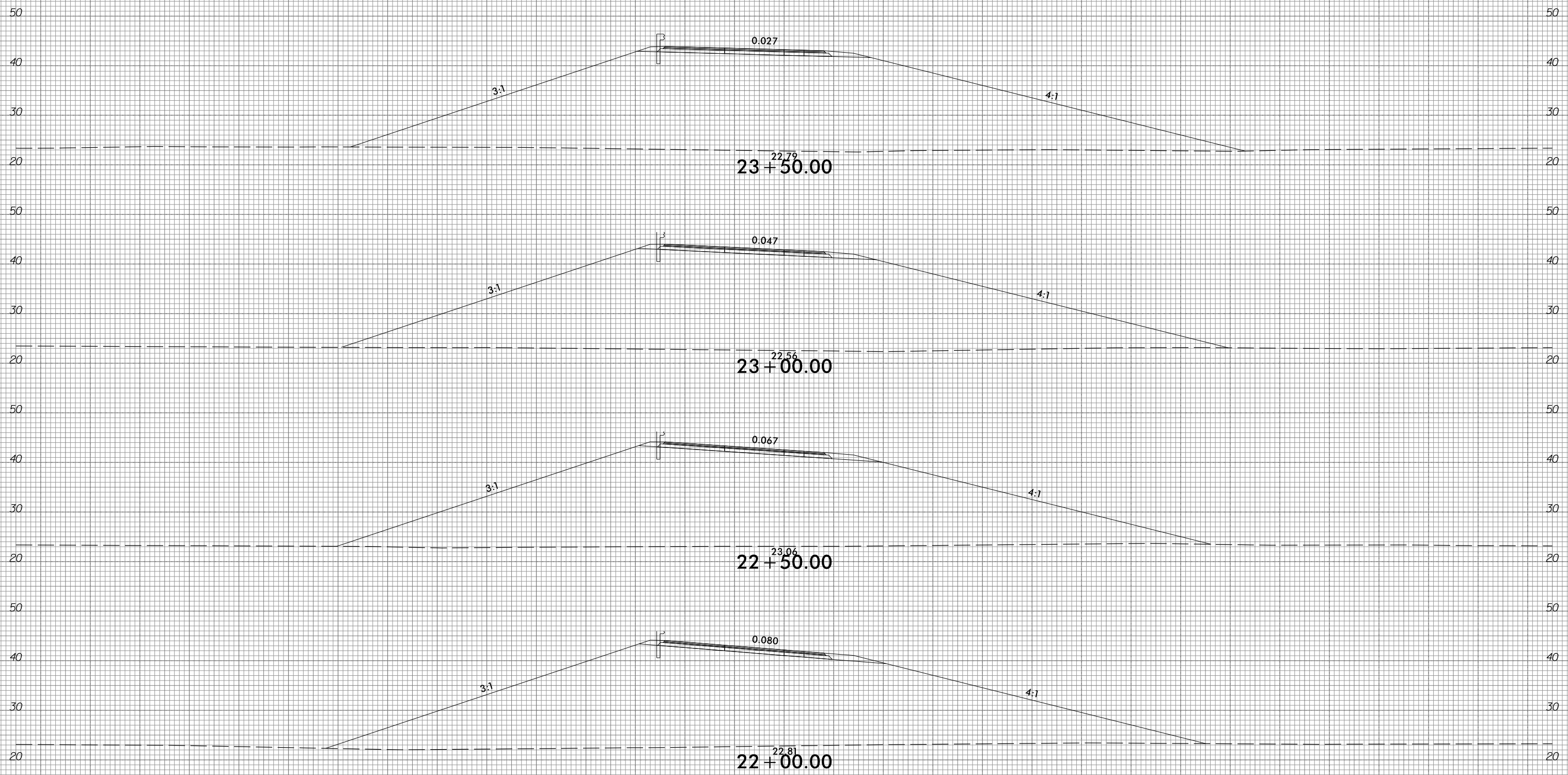

-Y3RPD-

150 140 130 120 110 100 90 80 70 60 50 40 30 20 10 0 10 20 30 40 50 60 70 80 90 100 110 120 130 140 150

10/31/2018
G:\RA\9729-02\CADD\1015\Roadway\XSC\1015_xp1_Y3RPD.dgn
gncdlin

6/23/16



PROJ. REFERENCE NO.
R-1015

SHEET NO.
X-374

150 140 130 120 110 100 90 80 70 60 50 40 30 20 10 0 10 20 30 40 50 60 70 80 90 100 110 120 130 140 150

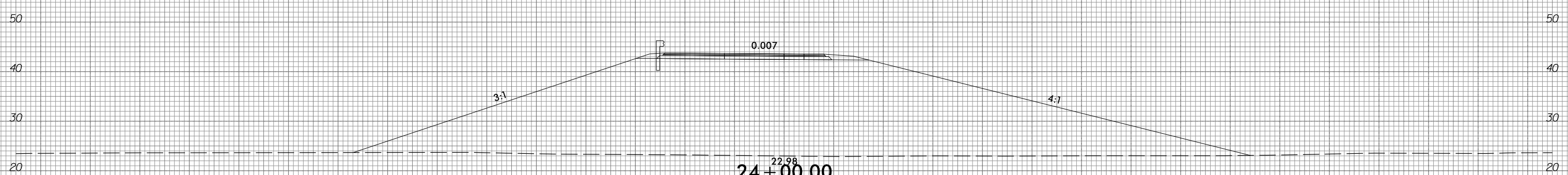
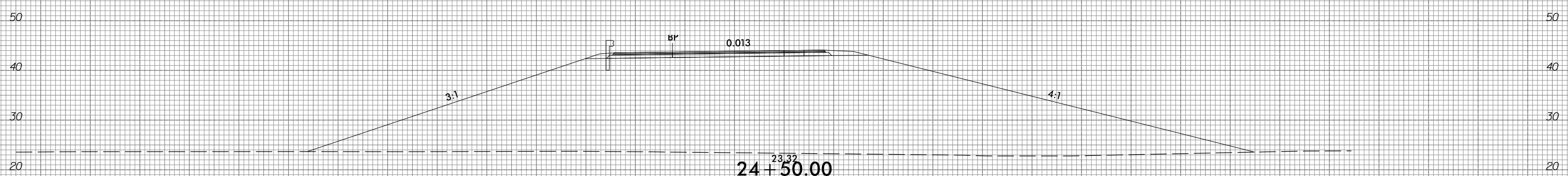
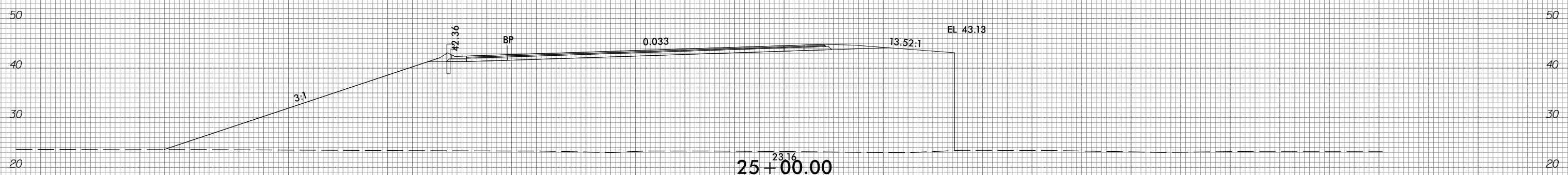

-Y3RPD-

150 140 130 120 110 100 90 80 70 60 50 40 30 20 10 0 10 20 30 40 50 60 70 80 90 100 110 120 130 140 150

10/31/2018
G:\RA\9729-02\CADD\1015\Roadway\XSC\1015_xp1.Y3RPD.dgn
gncdlin

6/23/16



PROJ. REFERENCE NO.
R-1015

SHEET NO.
X-375

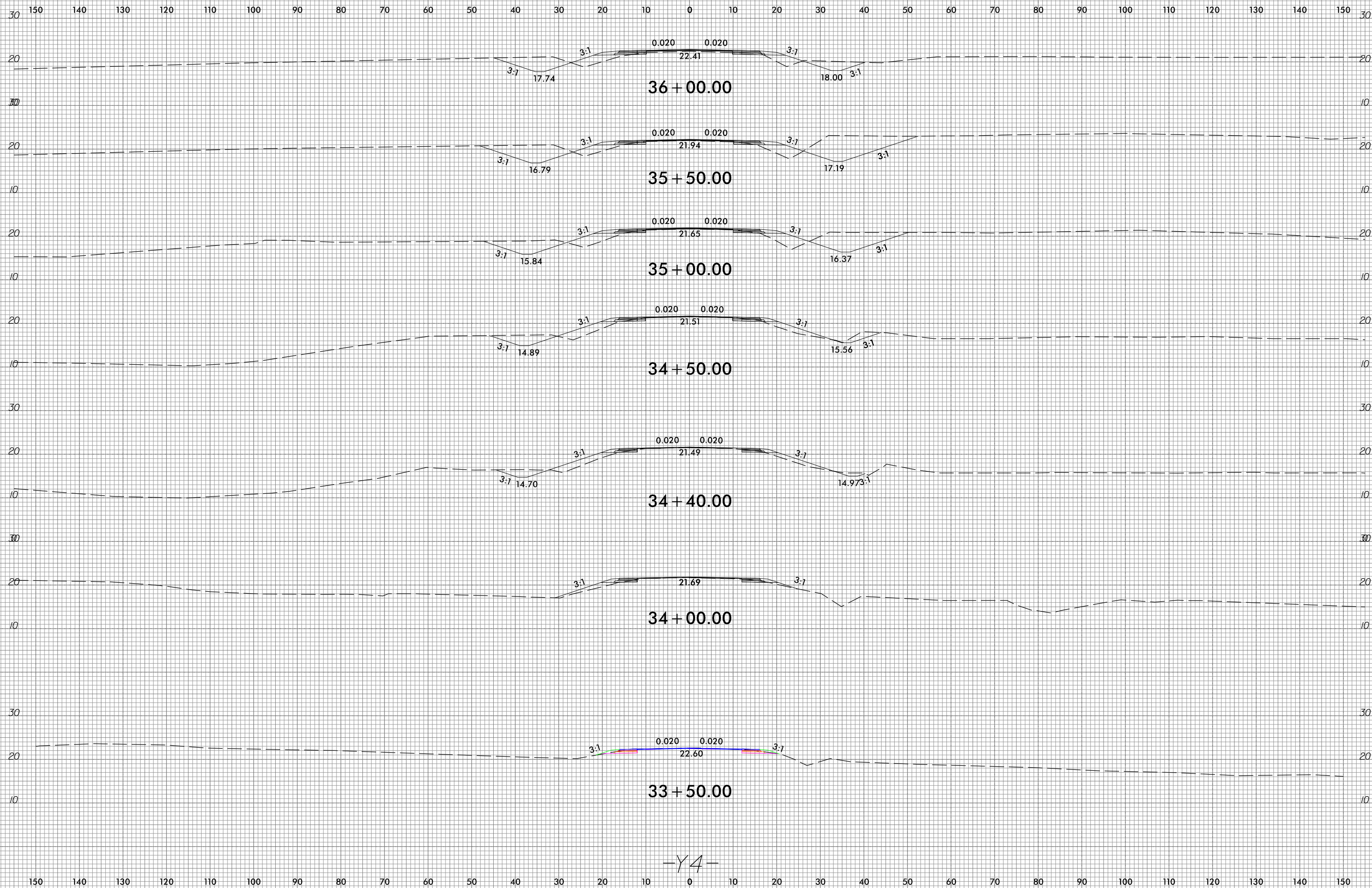

-Y4-

4/23/2016 9:17:29 AM G:\A00\1015\Roadway\XSC\1015_xp1_Y4.dgn

6/23/16



PROJ. REFERENCE NO.
R-1015

SHEET NO.
X-376

150 140 130 120 110 100 90 80 70 60 50 40 30 20 10 0 10 20 30 40 50 60 70 80 90 100 110 120 130 140 150

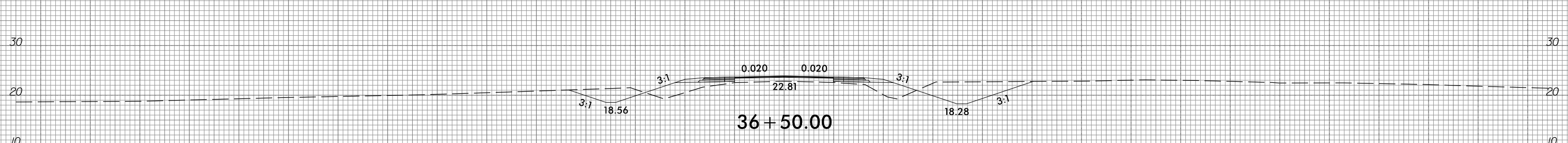
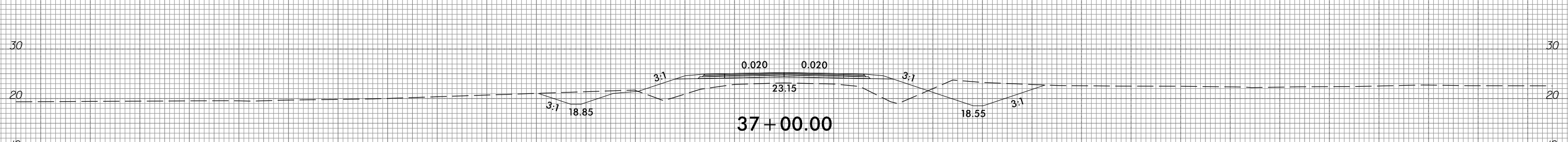
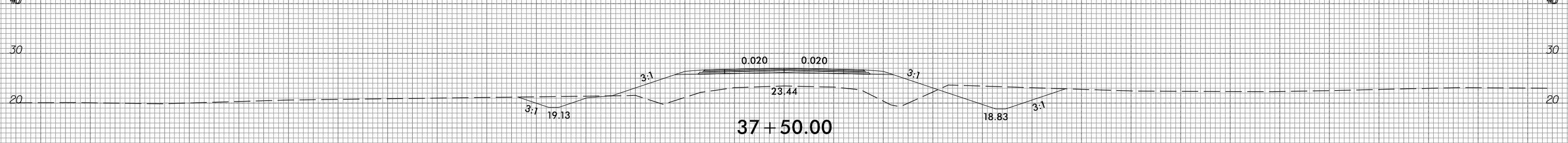
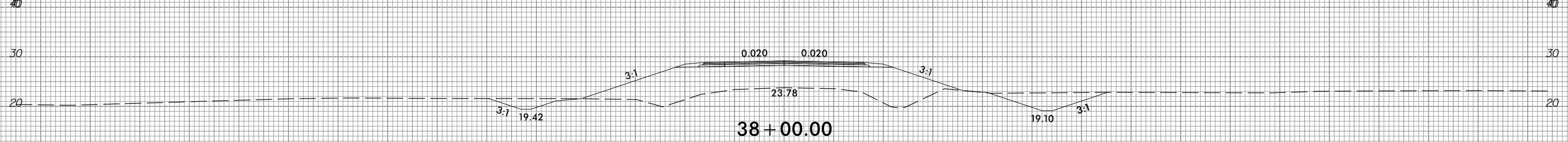
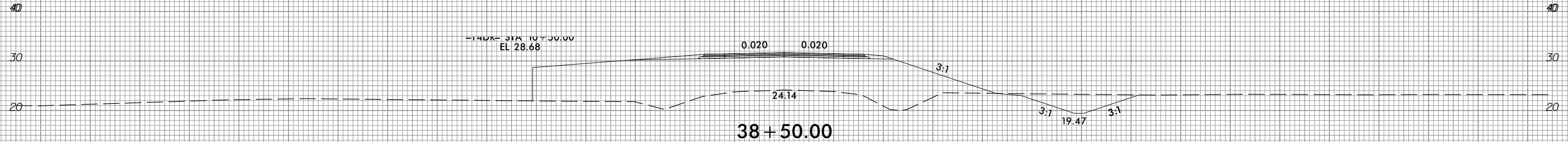
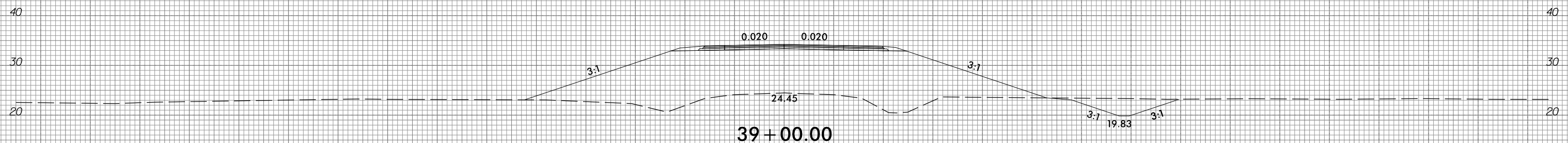

-Y4-

150 140 130 120 110 100 90 80 70 60 50 40 30 20 10 0 10 20 30 40 50 60 70 80 90 100 110 120 130 140 150

10/31/2018
G:\RA\9729-02\CADD\1015\Roadway\XSC\1015_xp1_Y4.dgn
gncdlin

6/23/16



PROJ. REFERENCE NO.
R-1015

SHEET NO.
X-377

150 140 130 120 110 100 90 80 70 60 50 40 30 20 10 0 10 20 30 40 50 60 70 80 90 100 110 120 130 140 150

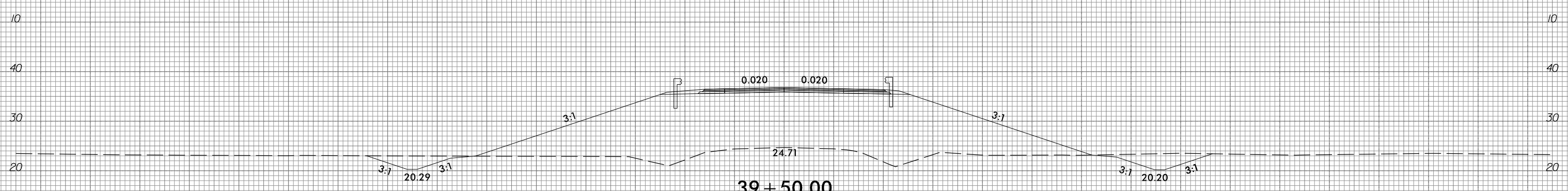
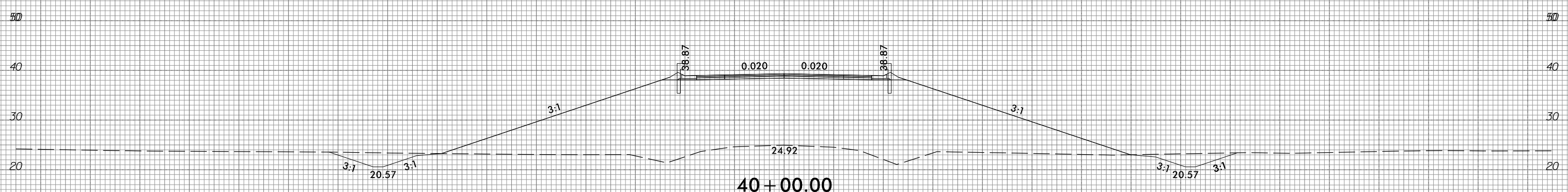
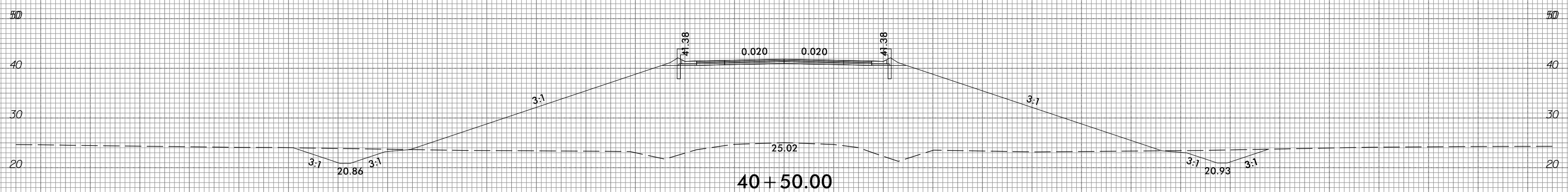
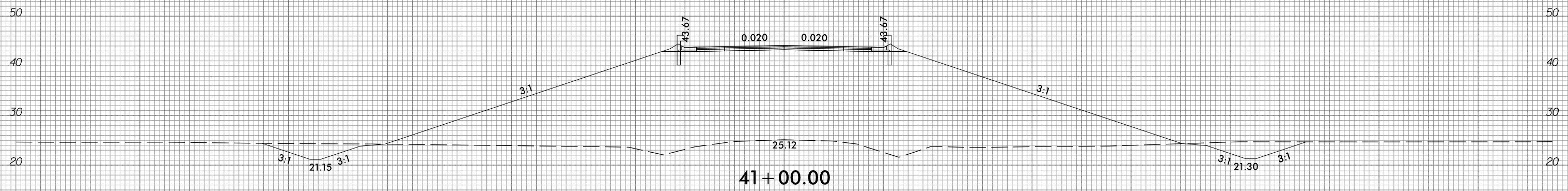

-Y4-

150 140 130 120 110 100 90 80 70 60 50 40 30 20 10 0 10 20 30 40 50 60 70 80 90 100 110 120 130 140 150

10/31/2018
G:\RA\9729-02\CADD\1015\Roadway\XSC\1015_xp1_Y4.dgn
gncdlin

6/23/16



| |
|---------------------|
| PROJ. REFERENCE NO. |
| R-1015 |

| |
|-----------|
| SHEET NO. |
| X-378 |

150 140 130 120 110 100 90 80 70 60 50 40 30 20 10 0 10 20 30 40 50 60 70 80 90 100 110 120 130 140 150

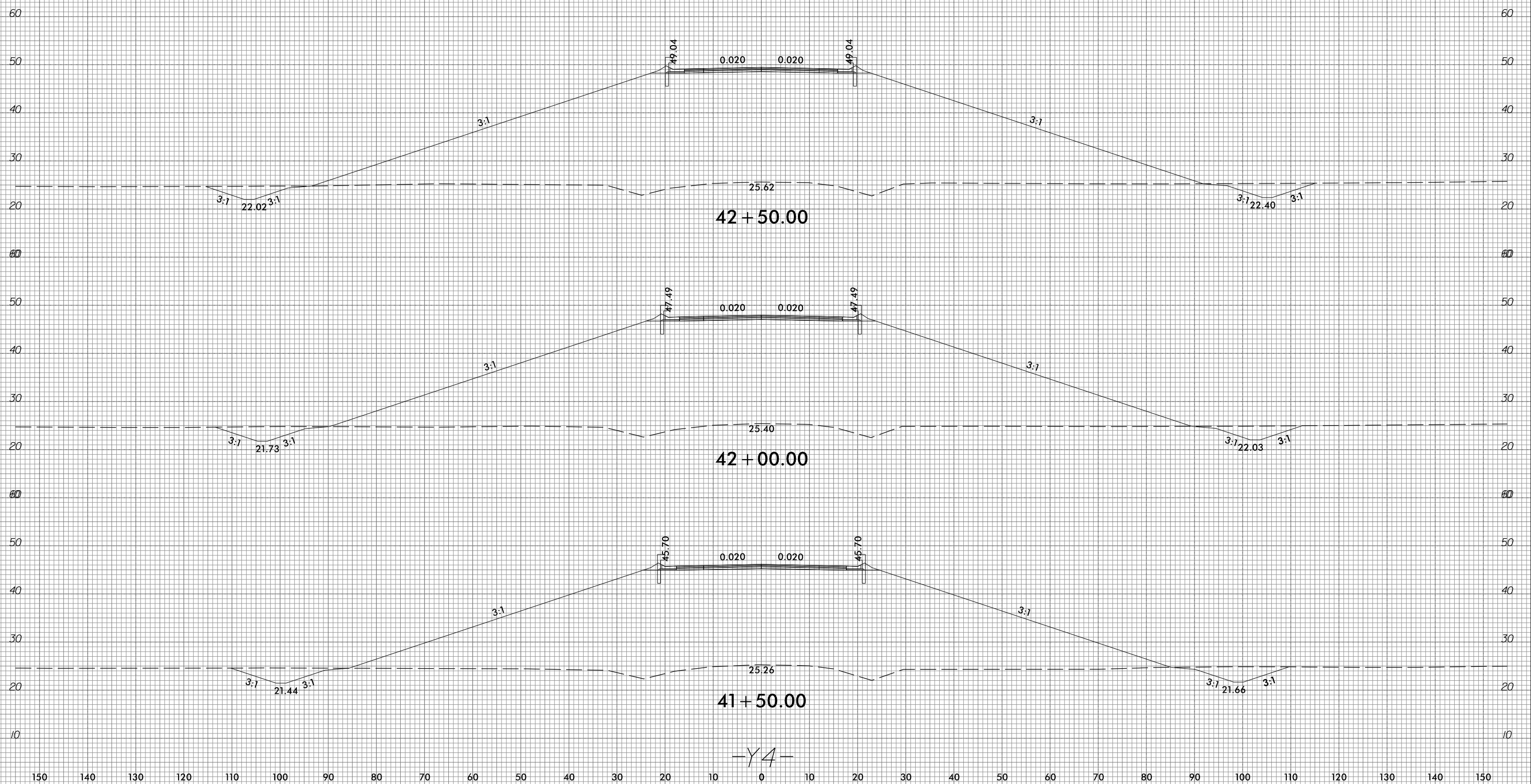

-Y4-

10/31/2018
 G:\RA\9729-02\CADD\1015\Roadway\XSC\1015_xp1_Y4.dgn
 gncdlin

6/23/16



| |
|---------------------|
| PROJ. REFERENCE NO. |
| R-1015 |

| |
|-----------|
| SHEET NO. |
| X-379 |

150 140 130 120 110 100 90 80 70 60 50 40 30 20 10 0 10 20 30 40 50 60 70 80 90 100 110 120 130 140 150

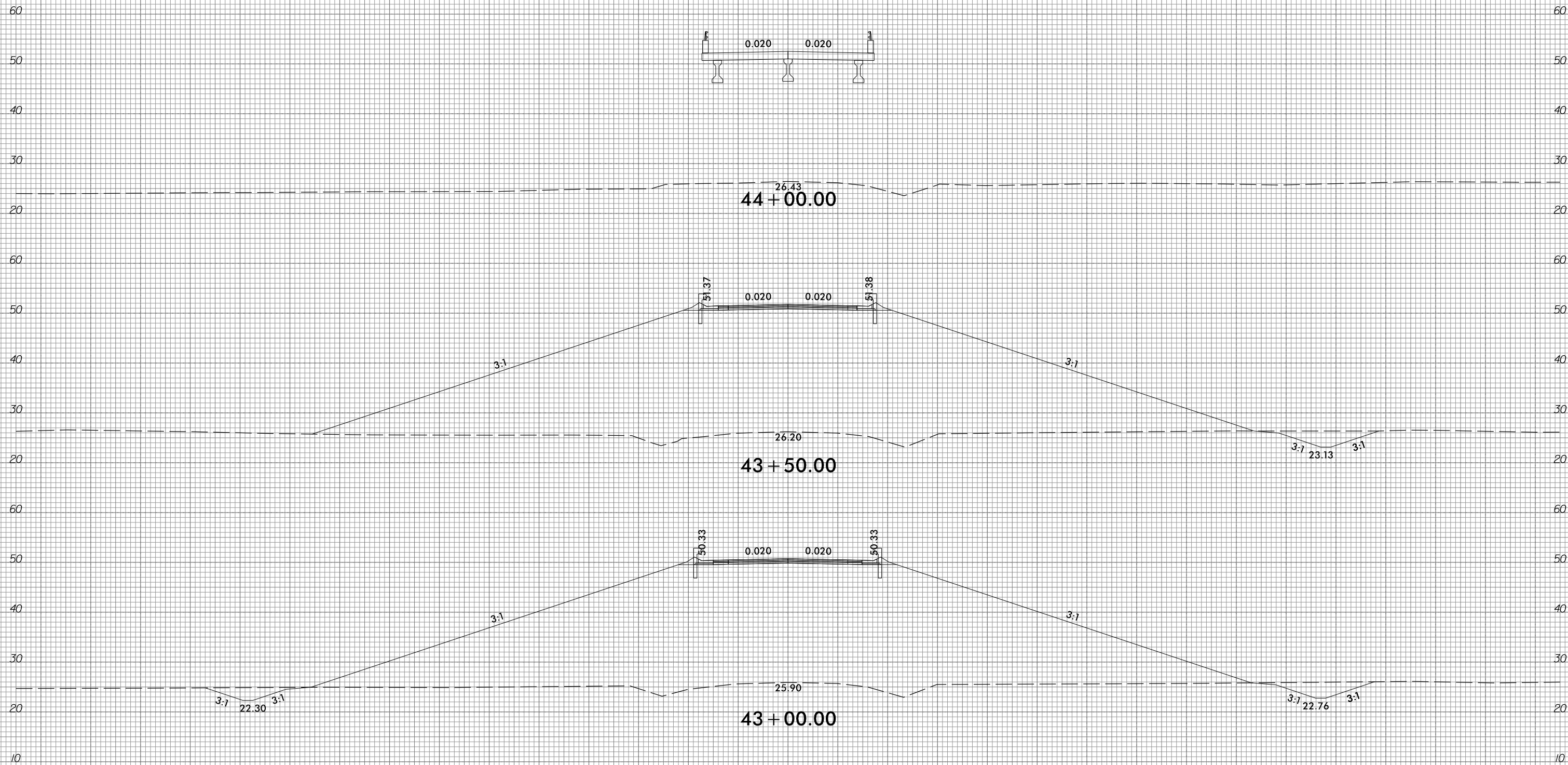

-Y4-

150 140 130 120 110 100 90 80 70 60 50 40 30 20 10 0 10 20 30 40 50 60 70 80 90 100 110 120 130 140 150

10/31/2018
 G:\RA\9729-02\CAD\1015\Roadway\XSC\1015_xp1_Y4.dgn
 gmc01in

6/23/16



PROJ. REFERENCE NO.
R-1015

SHEET NO.
X-380

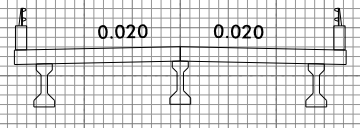
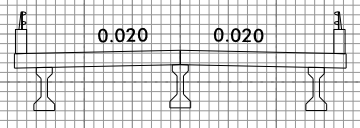
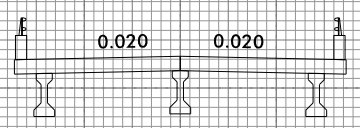
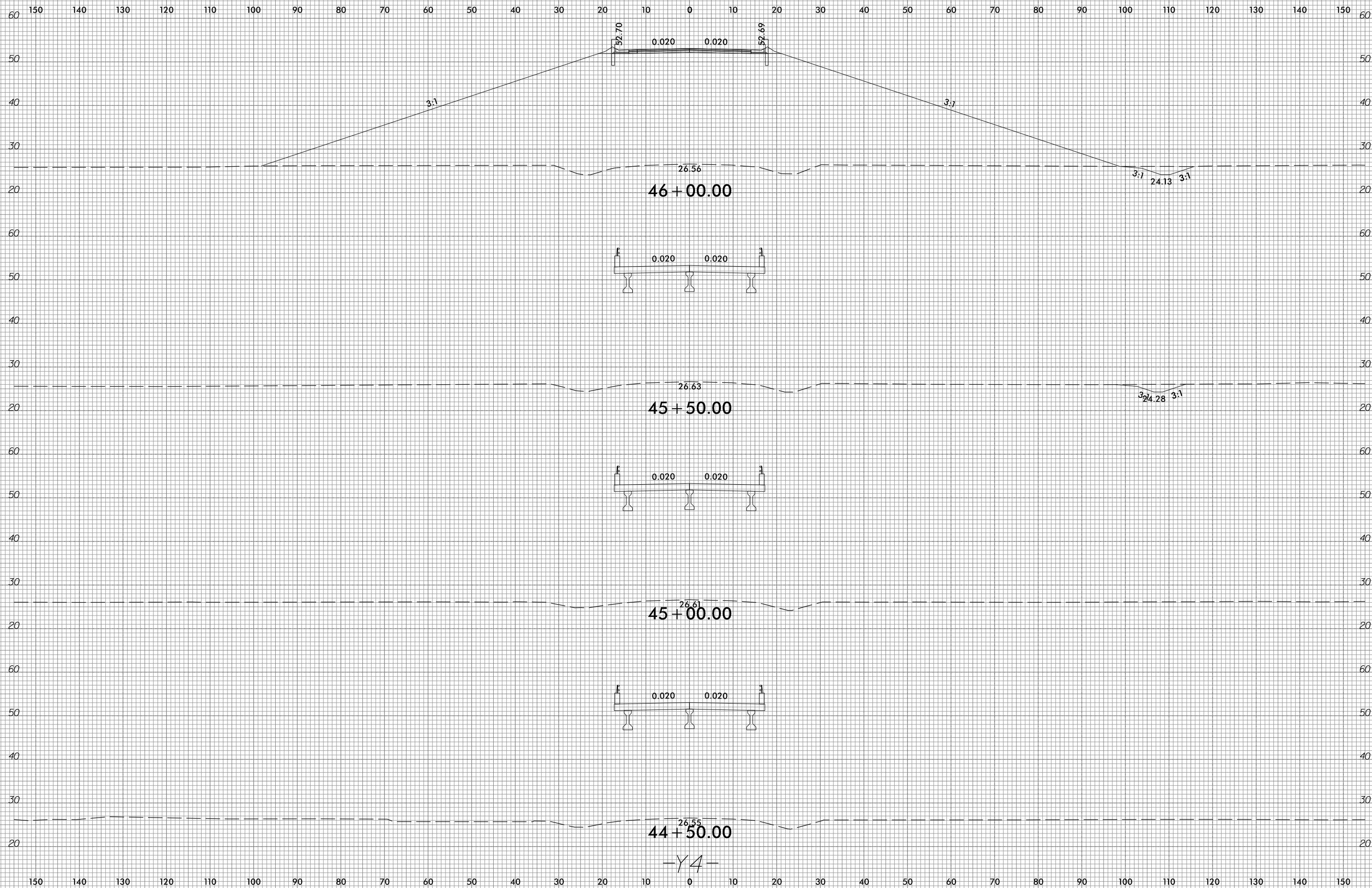

-Y4-

10/31/2018
G:\RA\9729-02\CADD\1015\Roadway\XSC\1015_xpl_Y4.dgn
gncdlin

6/23/16



| | |
|---------------------|-----------|
| PROJ. REFERENCE NO. | SHEET NO. |
| R-1015 | X-381 |

150 140 130 120 110 100 90 80 70 60 50 40 30 20 10 0 10 20 30 40 50 60 70 80 90 100 110 120 130 140 150

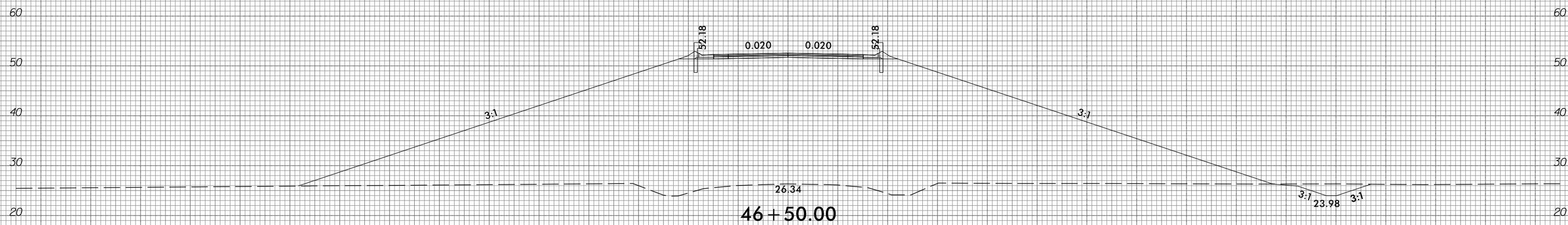
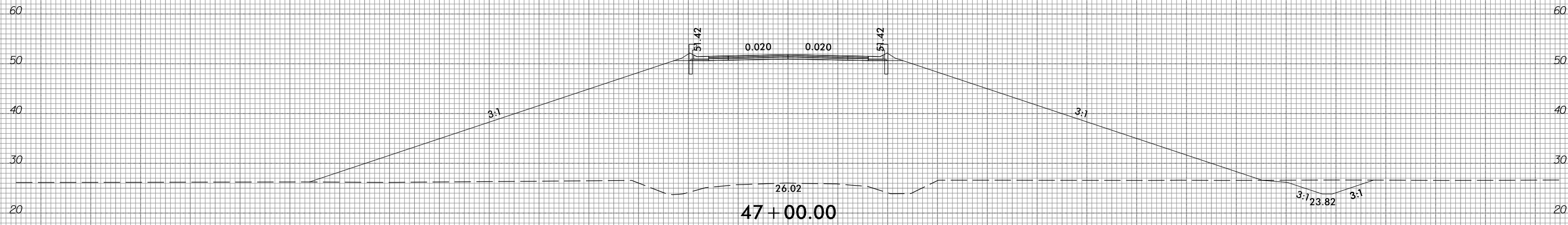
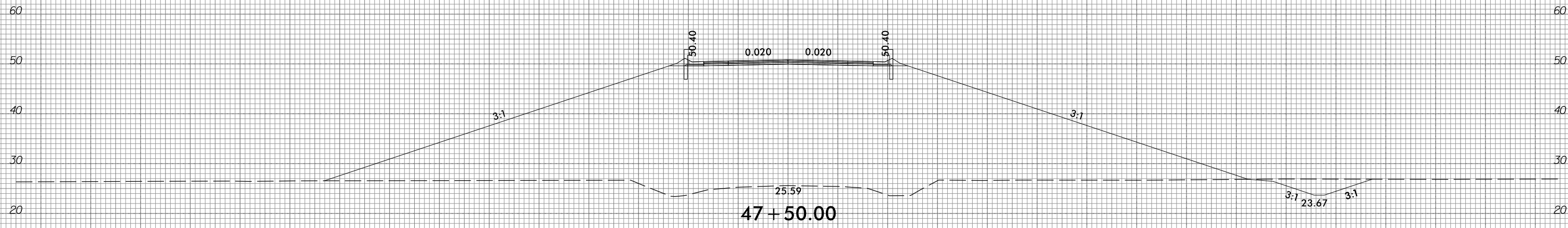

-Y4-

150 140 130 120 110 100 90 80 70 60 50 40 30 20 10 0 10 20 30 40 50 60 70 80 90 100 110 120 130 140 150

I:\A\1729-02\CAD\1015\Roadway\XSC\1015_xp1_Y4.dgn
gncdlin

6/23/16



| | |
|---------------------|-----------|
| PROJ. REFERENCE NO. | SHEET NO. |
| R-1015 | X-382 |

150 140 130 120 110 100 90 80 70 60 50 40 30 20 10 0 10 20 30 40 50 60 70 80 90 100 110 120 130 140 150

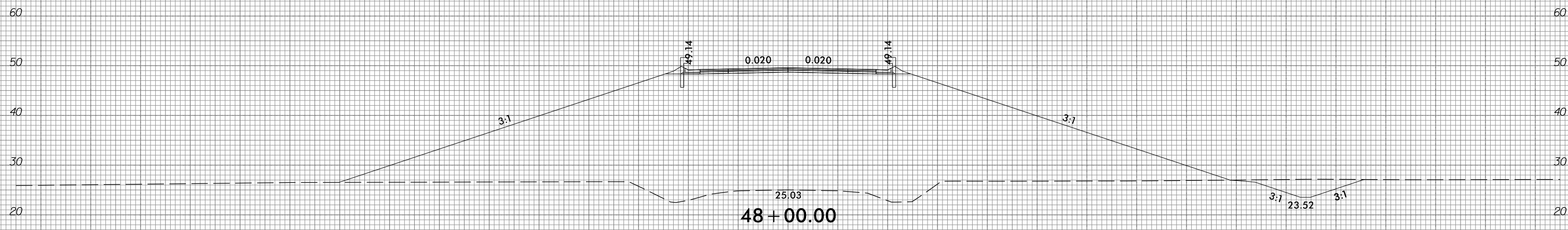
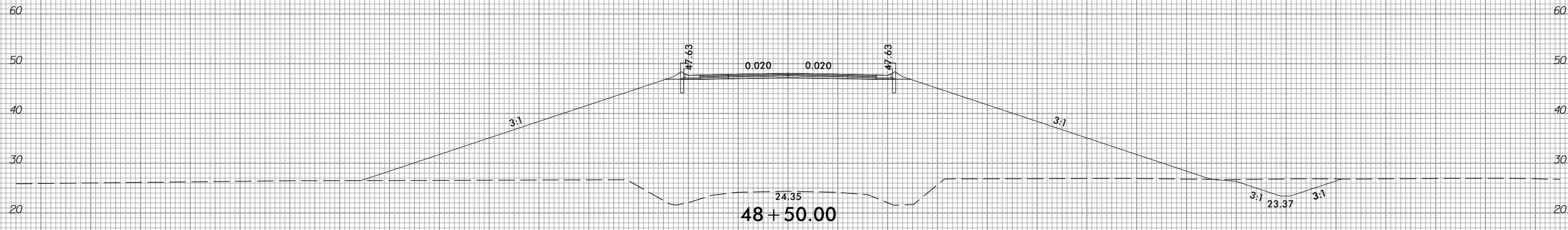
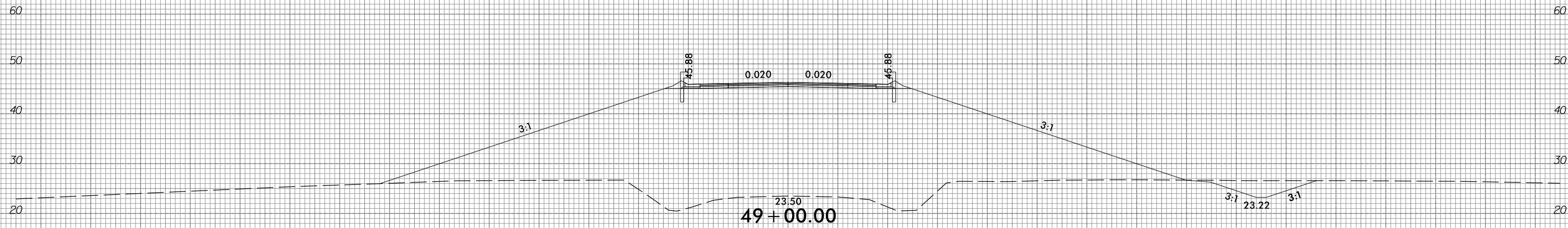

-Y4-

10/31/2018
 G:\RA\9729-02\CA00\1015\Roadway\XSC\1015_xp1_Y4.dgn
 gmc31in

6/23/16



PROJ. REFERENCE NO.
R-1015

SHEET NO.
X-383

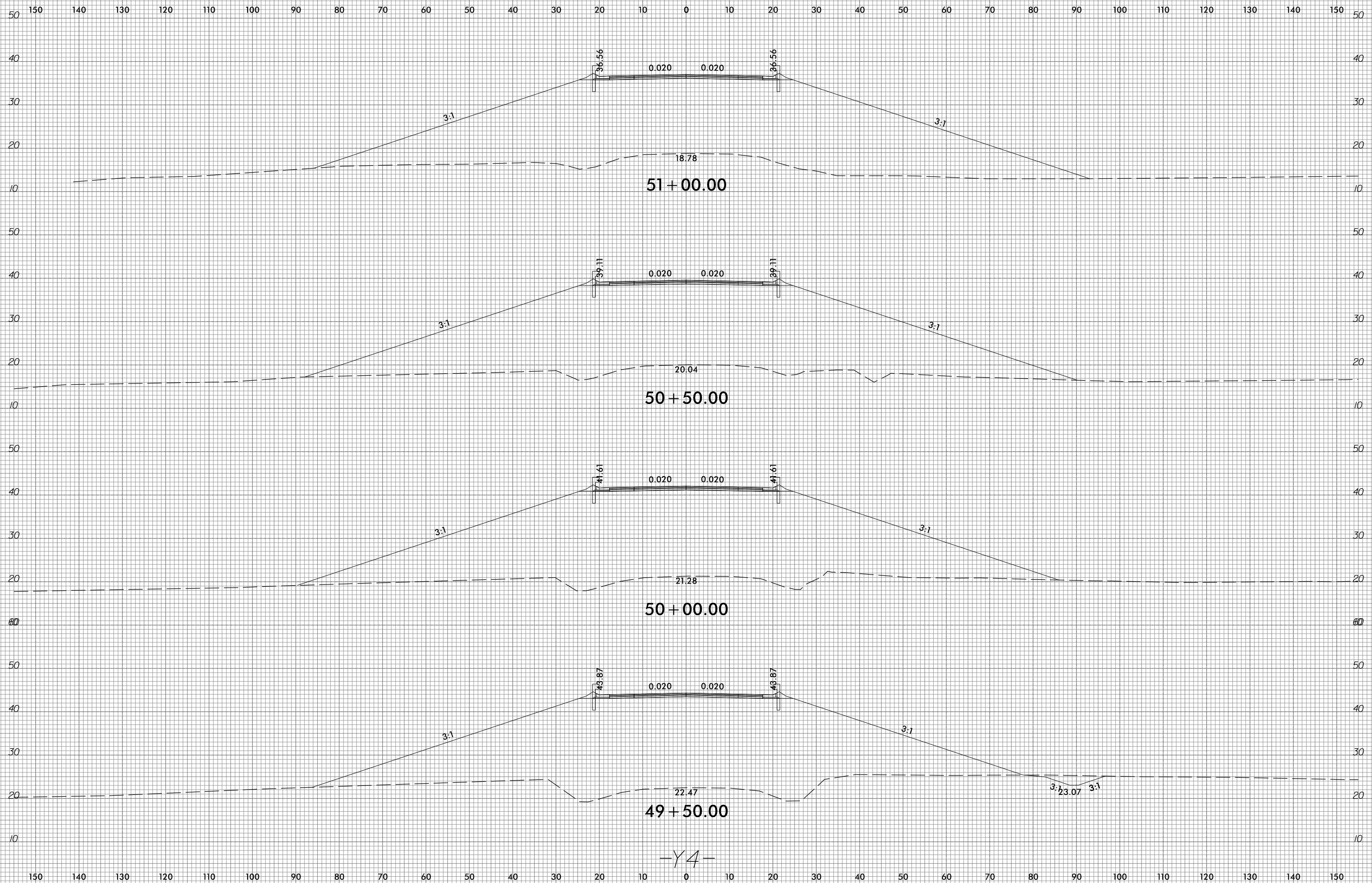

10/31/2018
G:\RA\9729-02\CADD\1015\Roadway\XSC\1015_xp1_Y4.dgn
gncdjin

6/23/16



PROJ. REFERENCE NO.
R-1015

SHEET NO.
X-384

150 140 130 120 110 100 90 80 70 60 50 40 30 20 10 0 10 20 30 40 50 60 70 80 90 100 110 120 130 140 150

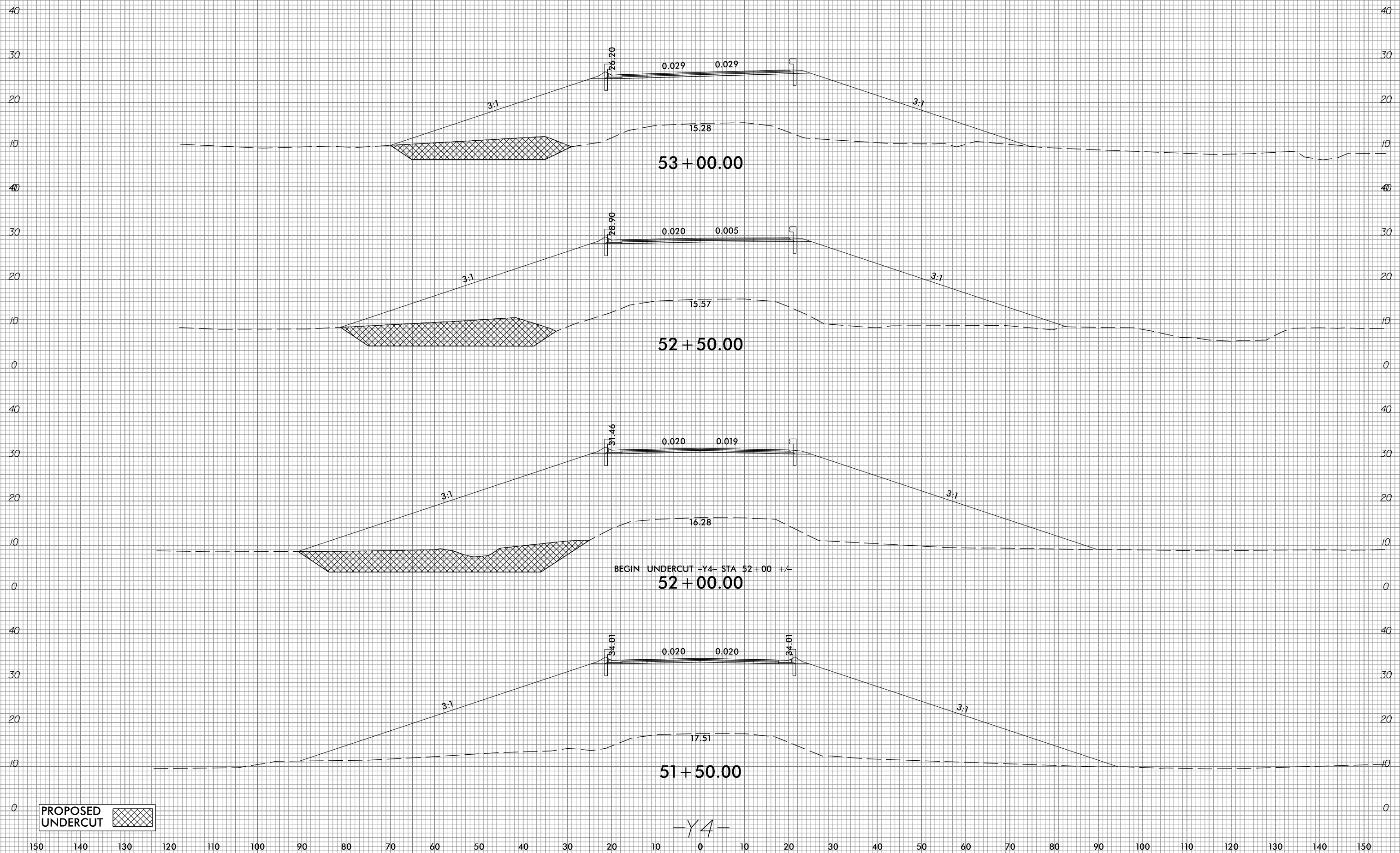

10/31/2018
G:\RA\9729-02\CADD\1015\Roadway\XSC\1015_xp1_y4.dgn
gmc311

150 140 130 120 110 100 90 80 70 60 50 40 30 20 10 0 10 20 30 40 50 60 70 80 90 100 110 120 130 140 150

6/23/16



PROJ. REFERENCE NO.
R-1015

SHEET NO.
X-385

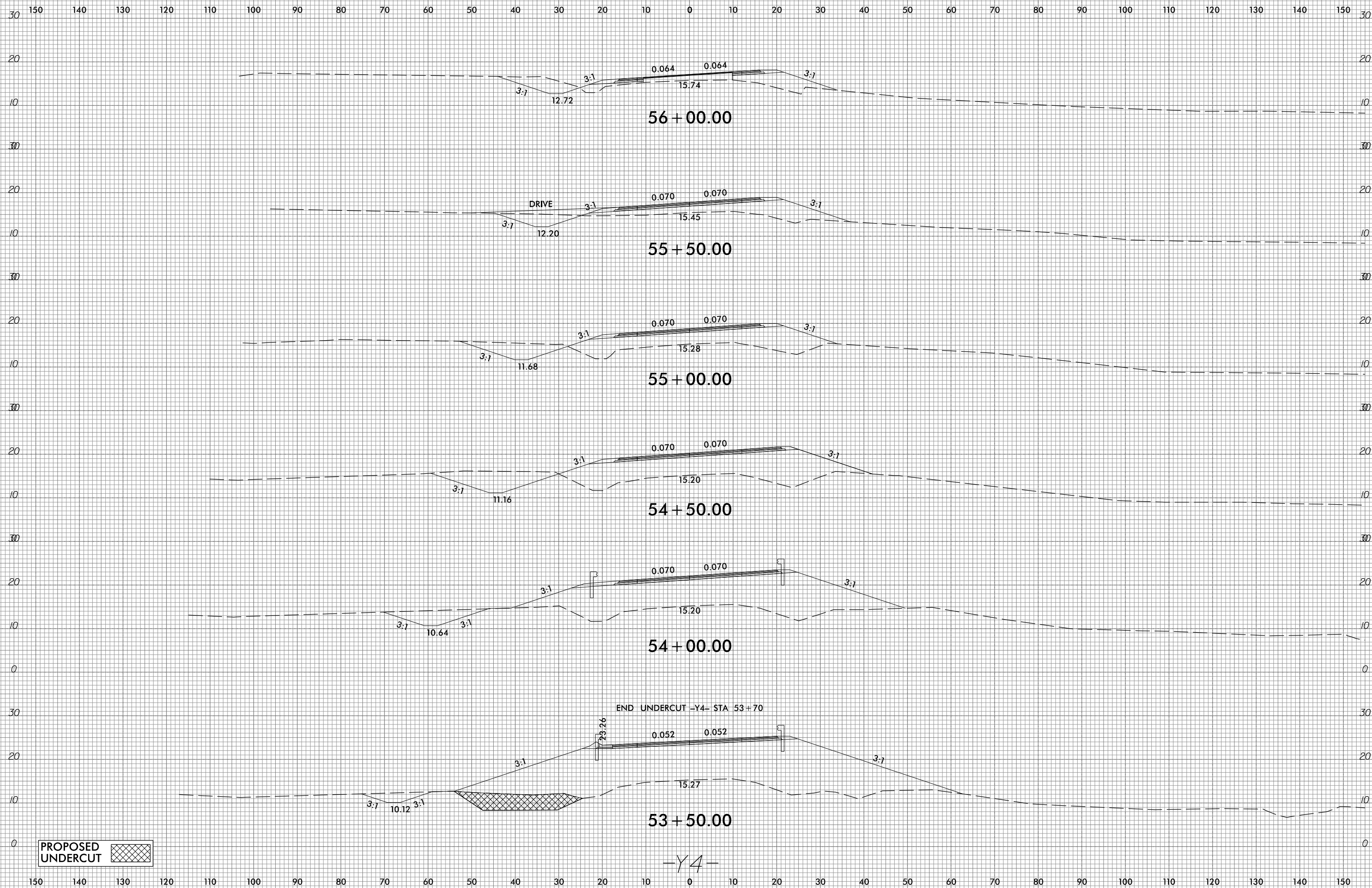

PROPOSED UNDERCUT



10/31/2018
G:\RA\9729-02\CADD\1015\Roadway\XSC\1015_xp1_Y4.dgn
gncdjin

6/23/16



PROJ. REFERENCE NO.
R-1015

SHEET NO.
X-386

150 140 130 120 110 100 90 80 70 60 50 40 30 20 10 0 10 20 30 40 50 60 70 80 90 100 110 120 130 140 150

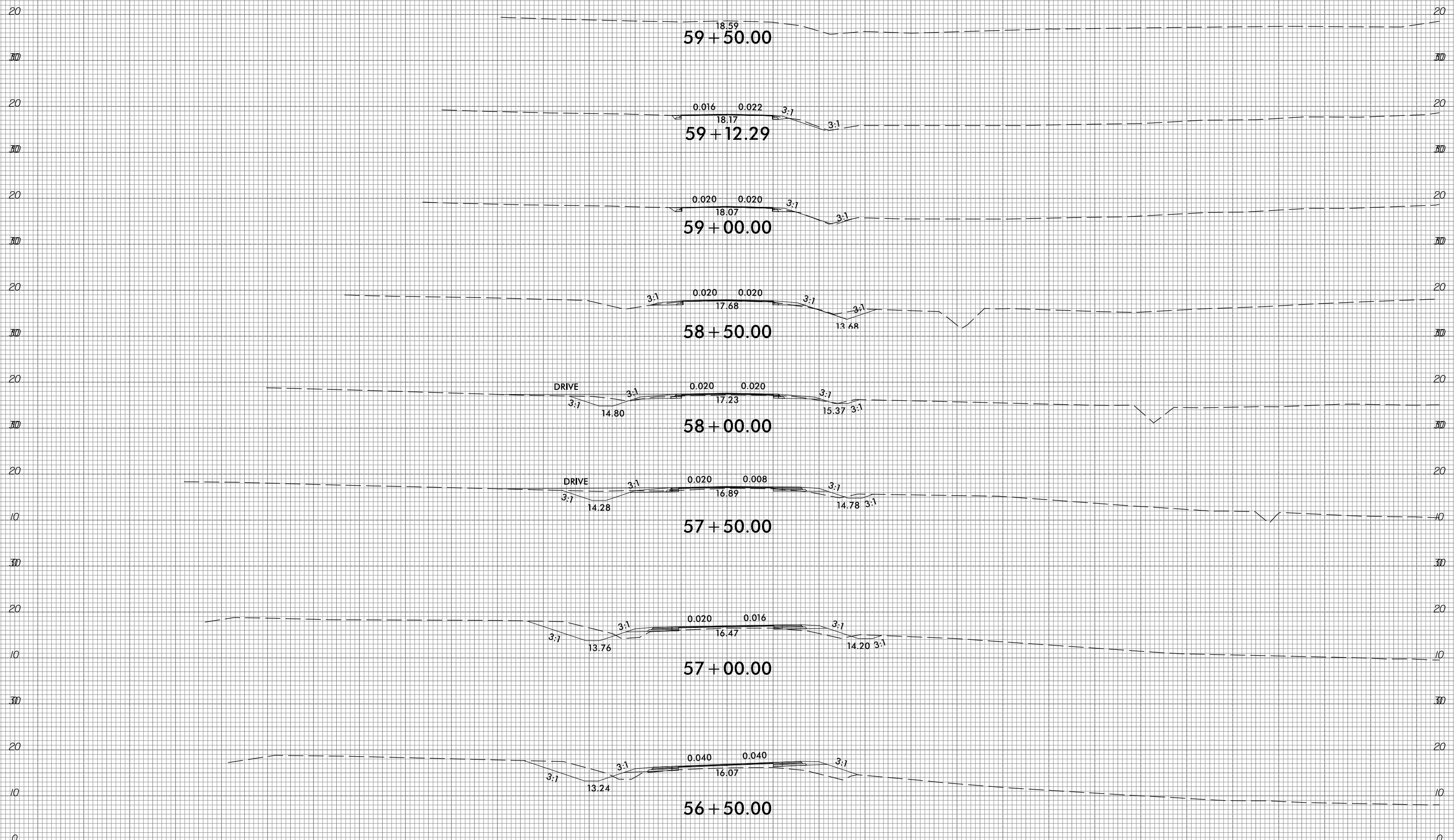

18.59
59 + 50.00

0.016 0.022
18.17
59 + 12.29

0.020 0.020
18.07
59 + 00.00

0.020 0.020
17.68
58 + 50.00

DRIVE
14.80
17.23
58 + 00.00

DRIVE
14.28
16.89
57 + 50.00

13.76
16.47
57 + 00.00

13.24
16.07
56 + 50.00

-Y4-

10/31/2018
G:\RA\9729-02\CADD\1015\Roadway\XSC\1015_xp1_Y4.dgn
gncdlin

150 140 130 120 110 100 90 80 70 60 50 40 30 20 10 0 10 20 30 40 50 60 70 80 90 100 110 120 130 140 150

6/23/16



PROJ. REFERENCE NO.
R-1015

SHEET NO.
X-387

150 140 130 120 110 100 90 80 70 60 50 40 30 20 10 0 10 20 30 40 50 60 70 80 90 100 110 120 130 140 150

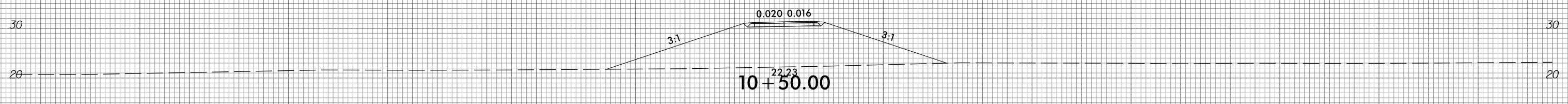
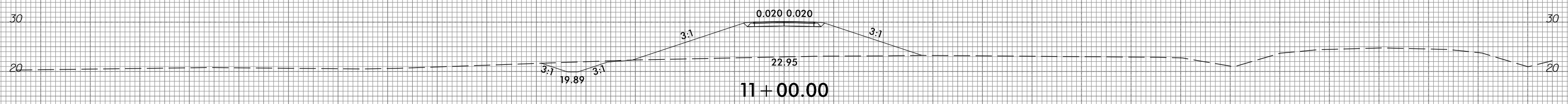
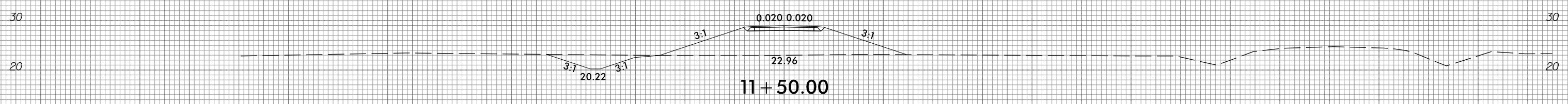
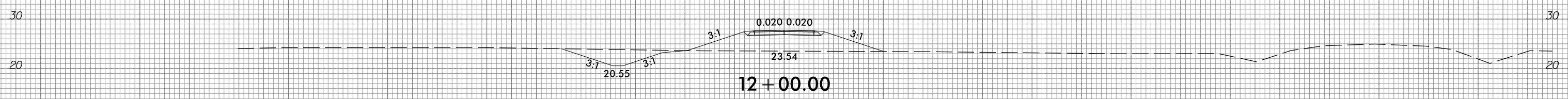
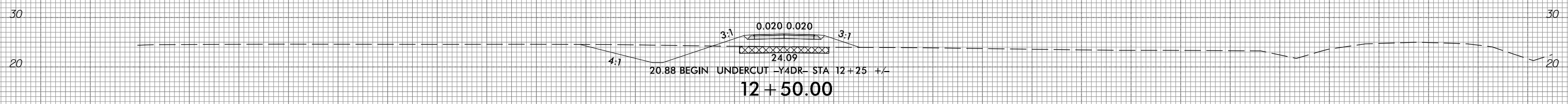
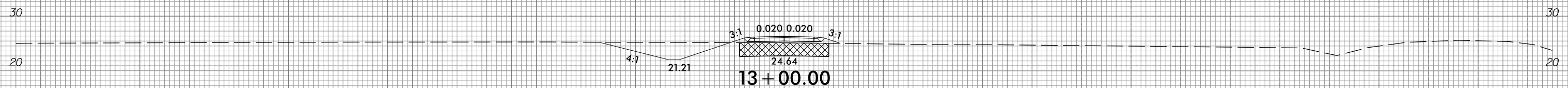

PROPOSED UNDERCUT



-Y4DR-

150 140 130 120 110 100 90 80 70 60 50 40 30 20 10 0 10 20 30 40 50 60 70 80 90 100 110 120 130 140 150

10/31/2018
G:\RA\9729-02\CADD\1015\Roadway\XSC\1015_xp1_Y4DR.dgn
gncdlin

6/23/16



PROJ. REFERENCE NO.
R-1015

SHEET NO.
X-388

150 140 130 120 110 100 90 80 70 60 50 40 30 20 10 0 10 20 30 40 50 60 70 80 90 100 110 120 130 140 150

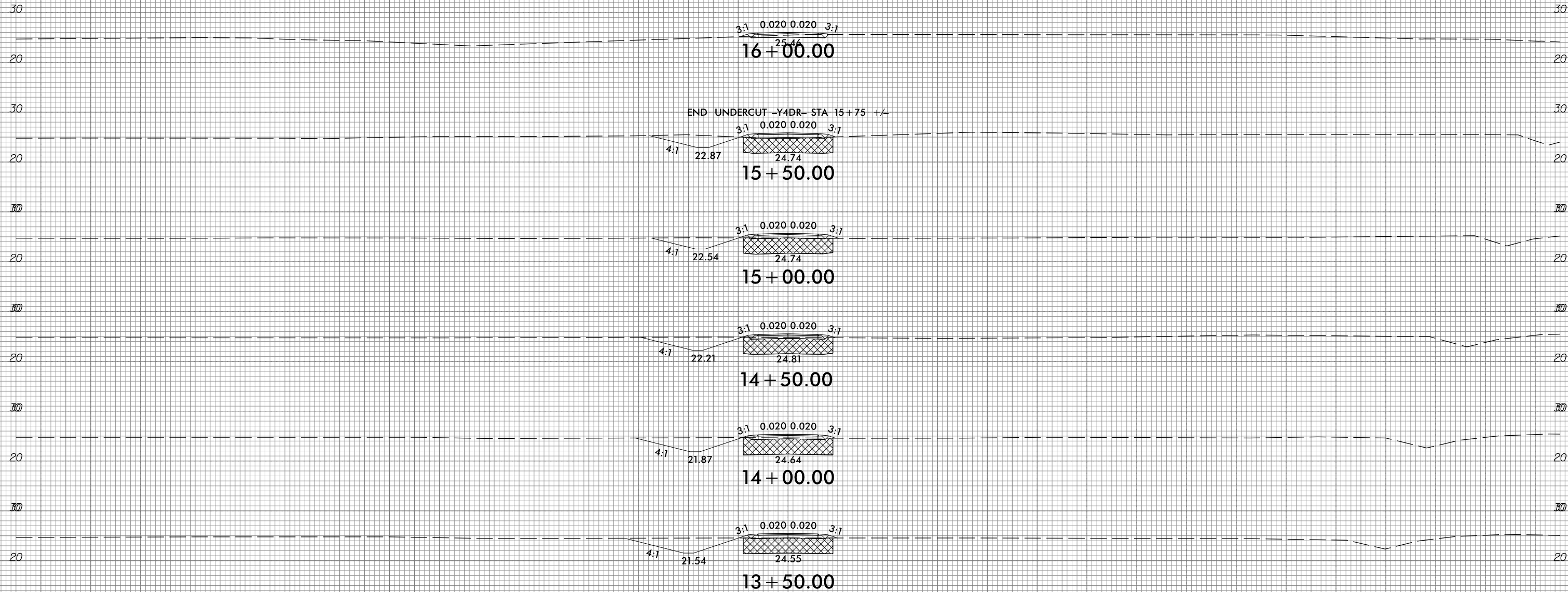

PROPOSED UNDERCUT

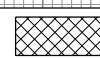

-Y4DR-

150 140 130 120 110 100 90 80 70 60 50 40 30 20 10 0 10 20 30 40 50 60 70 80 90 100 110 120 130 140 150

10/31/2018
G:\RA\9729-02\CADD\1015\Roadway\XSC\1015.sp1.Y4DR.dgn
gncdjin

6/23/16



PROJ. REFERENCE NO.
R-1015

SHEET NO.
X-389

150 140 130 120 110 100 90 80 70 60 50 40 30 20 10 0 10 20 30 40 50 60 70 80 90 100 110 120 130 140 150

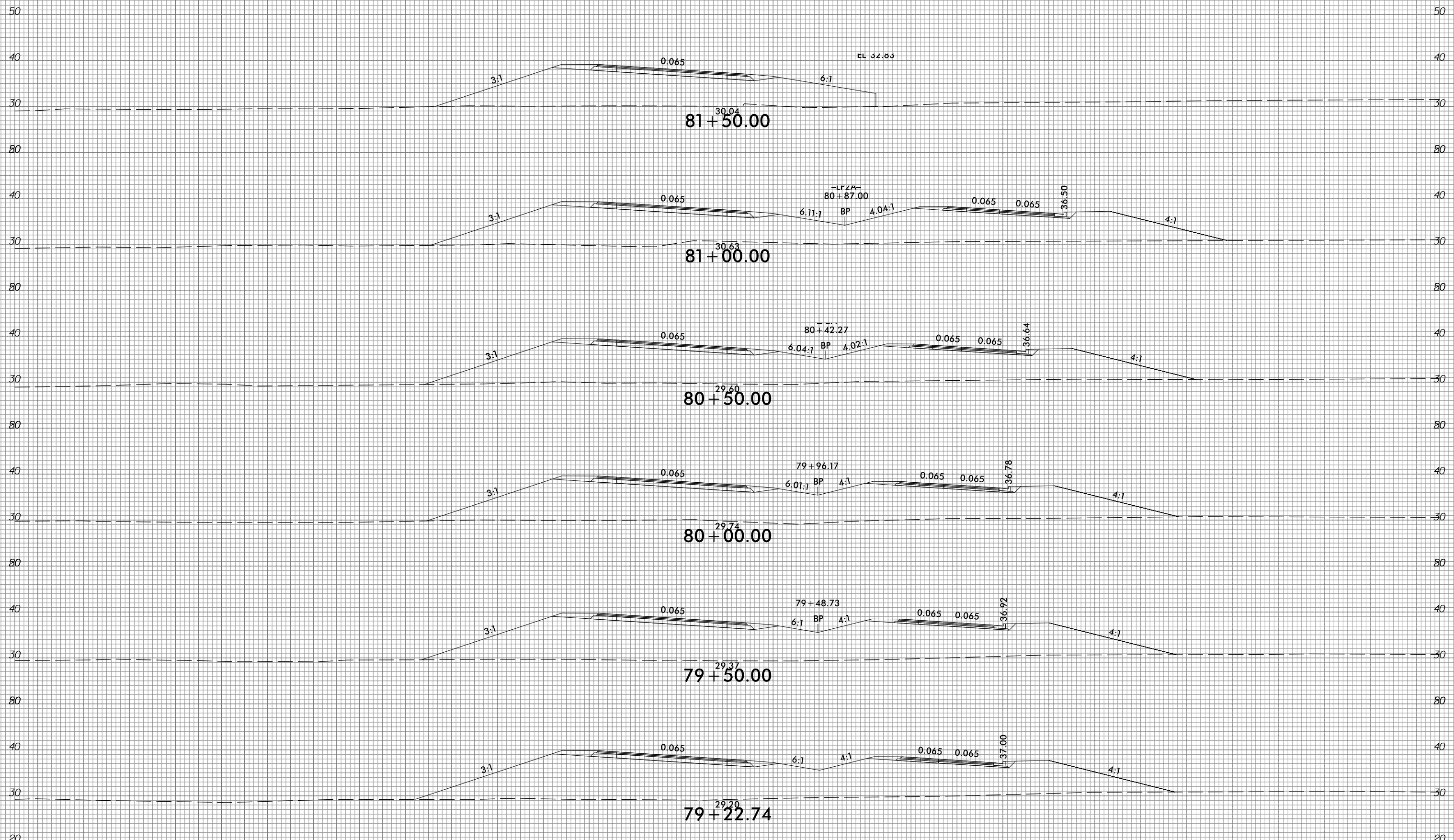

-RP2A-

10/31/2018
G:\RA\9729-02\CADD\1015\Roadway\XSC\1015_xp1_RP2A.dgn
gncdlin

6/23/16



| | |
|---------------------|-----------|
| PROJ. REFERENCE NO. | SHEET NO. |
| R-1015 | X-390 |

150 140 130 120 110 100 90 80 70 60 50 40 30 20 10 0 10 20 30 40 50 60 70 80 90 100 110 120 130 140 150

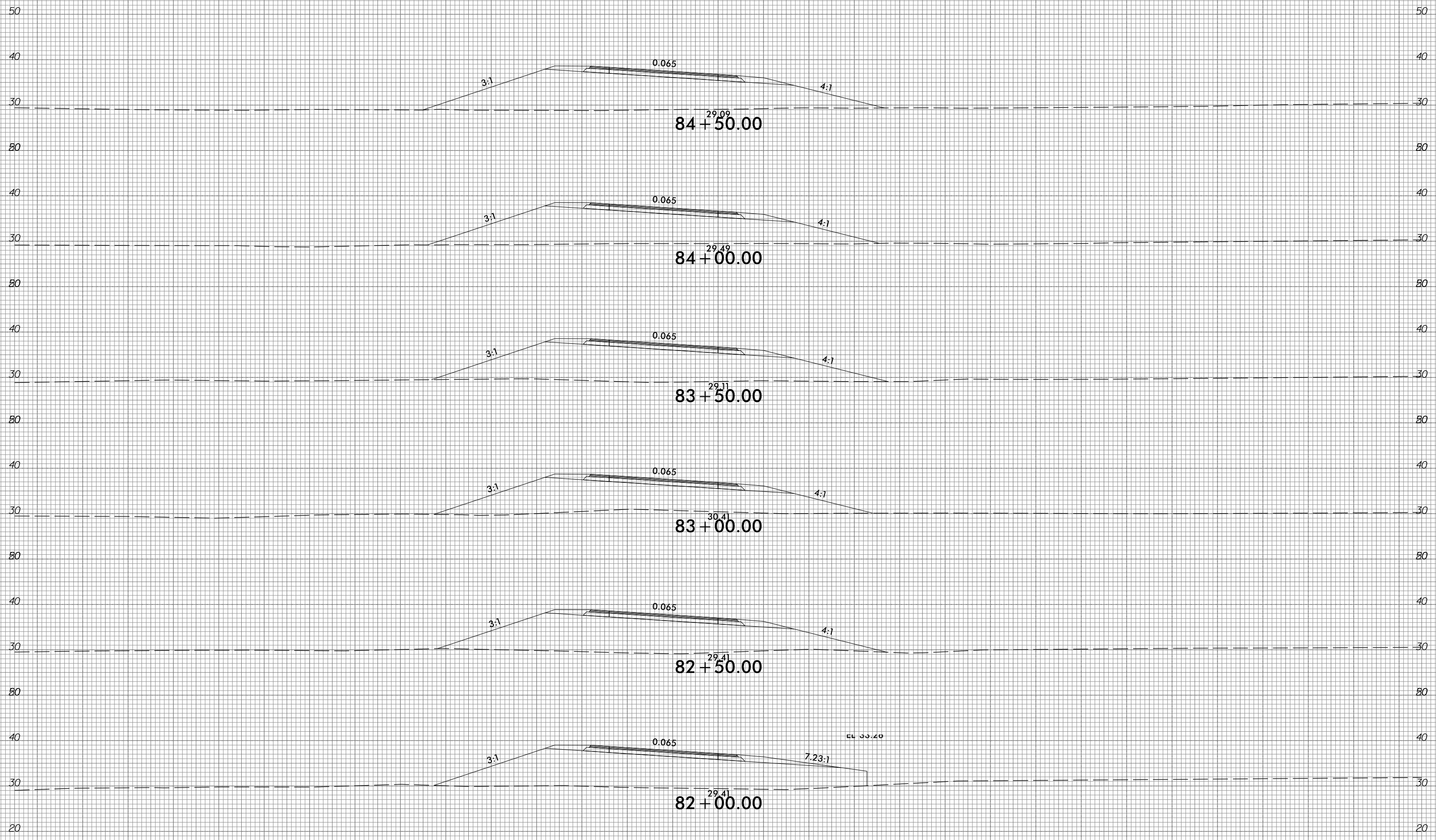

-RP2A-

10/31/2016
 G:\RA\9729-02\CADD\1015\Roadway\XSC\1015_xp1_RP2A.dgn
 gncdlin

6/23/16



PROJ. REFERENCE NO.
R-1015

SHEET NO.
X-391

150 140 130 120 110 100 90 80 70 60 50 40 30 20 10 0 10 20 30 40 50 60 70 80 90 100 110 120 130 140 150

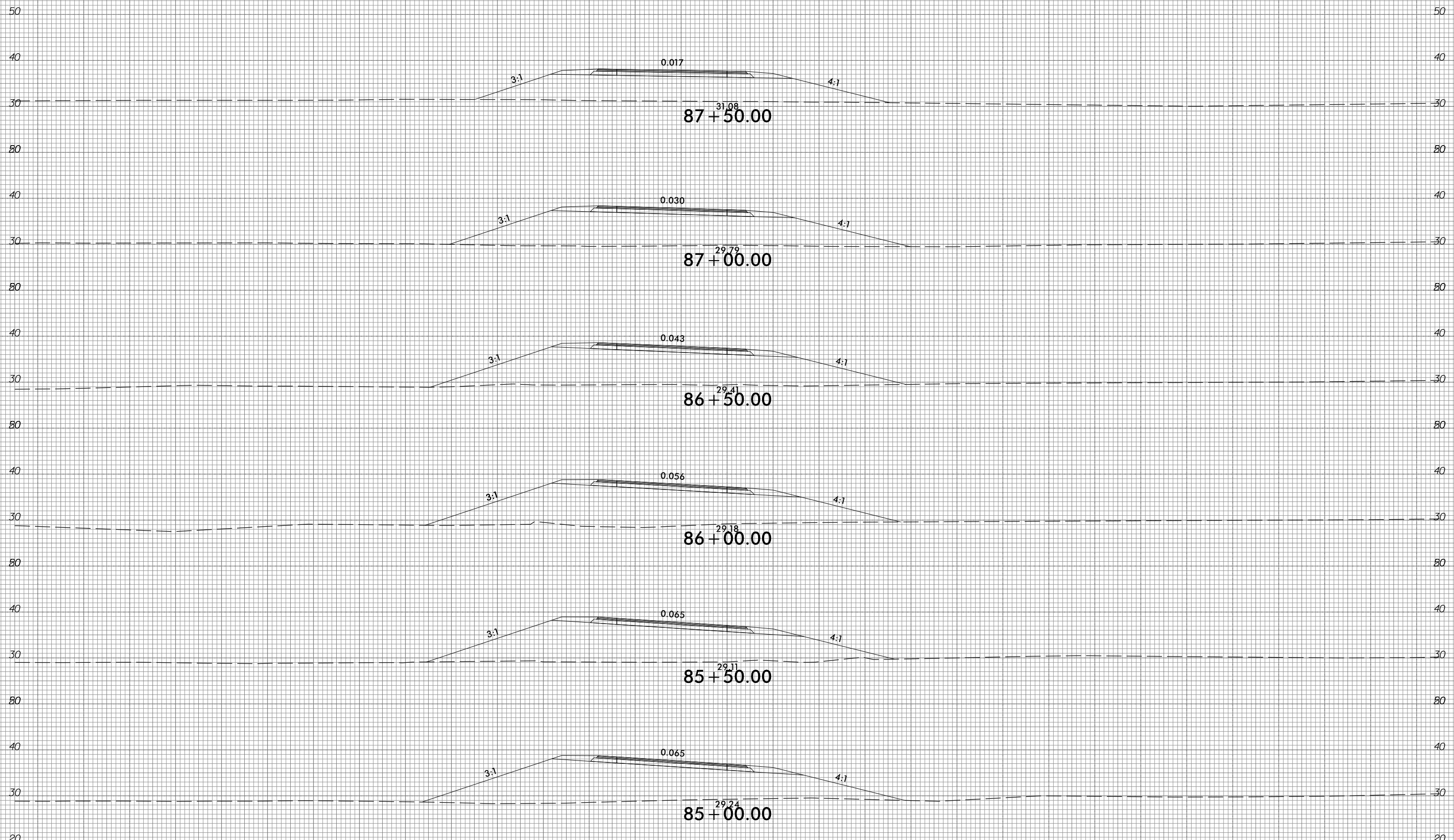

-RP2A-

150 140 130 120 110 100 90 80 70 60 50 40 30 20 10 0 10 20 30 40 50 60 70 80 90 100 110 120 130 140 150

10/31/2018
G:\RA\9729-02\CADD\1015\Roadway\XSC\1015_xp1_RP2A.dgn
gncdlin

6/23/16



PROJ. REFERENCE NO.
R-1015

SHEET NO.
X-392

150 140 130 120 110 100 90 80 70 60 50 40 30 20 10 0 10 20 30 40 50 60 70 80 90 100 110 120 130 140 150

50 50

40 40

30 30

90 + 50.00

0.062

3:1

4:1

31.63

20 20

40 40

30 30

90 + 00.00

0.049

3:1

4:1

31.86

20 20

40 40

30 30

89 + 50.00

0.036

3:1

4:1

31.52

20 20

40 40

30 30

89 + 00.00

0.023

3:1

4:1

31.65

20 20

40 40

30 30

88 + 50.00

0.010

3:1

4:1

31.65

20 20

40 40

30 30

88 + 00.00

0.004

3:1

4:1

31.73

-RP2A-

150 140 130 120 110 100 90 80 70 60 50 40 30 20 10 0 10 20 30 40 50 60 70 80 90 100 110 120 130 140 150

10/31/2016
G:\RA\9729-02\CADD\1015\Roadway\XSC\1015_xp1_RP2A.dgn
gncdlin

6/23/16



PROJ. REFERENCE NO.
R-1015

SHEET NO.
X-393

150 140 130 120 110 100 90 80 70 60 50 40 30 20 10 0 10 20 30 40 50 60 70 80 90 100 110 120 130 140 150

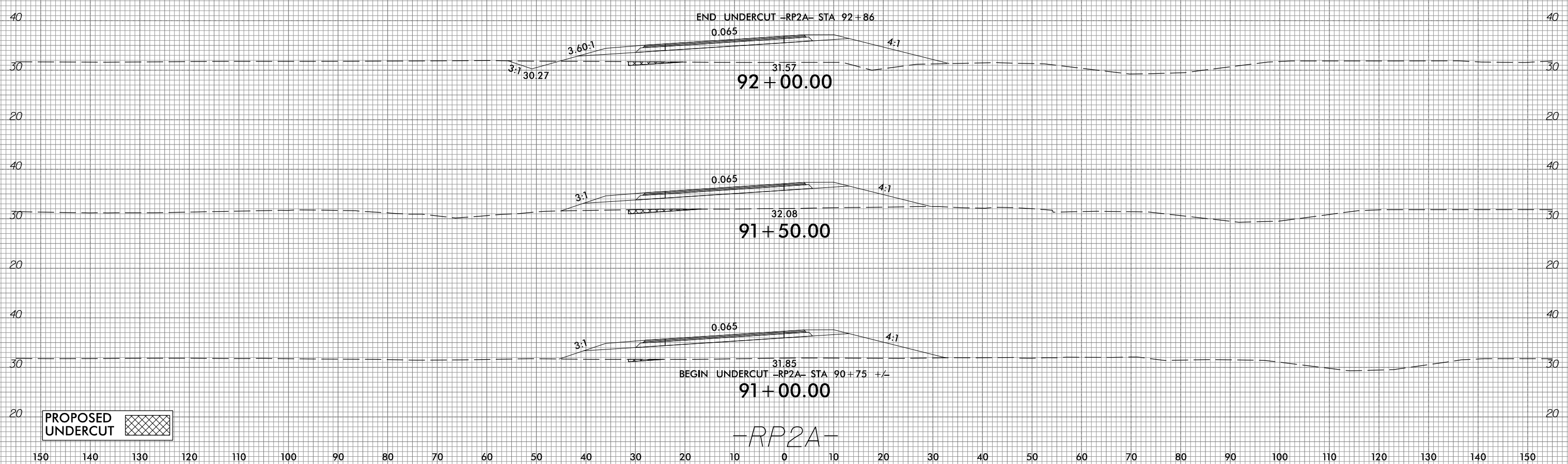

10/31/2018
G:\RA\9729-02\CADD\1015\Roadway\XSC\1015_xp1_RP2A.dgn
gncdjin

6/23/16



| |
|---------------------|
| PROJ. REFERENCE NO. |
| R-1015 |

| |
|-----------|
| SHEET NO. |
| X-394 |

150 140 130 120 110 100 90 80 70 60 50 40 30 20 10 0 10 20 30 40 50 60 70 80 90 100 110 120 130 140 150

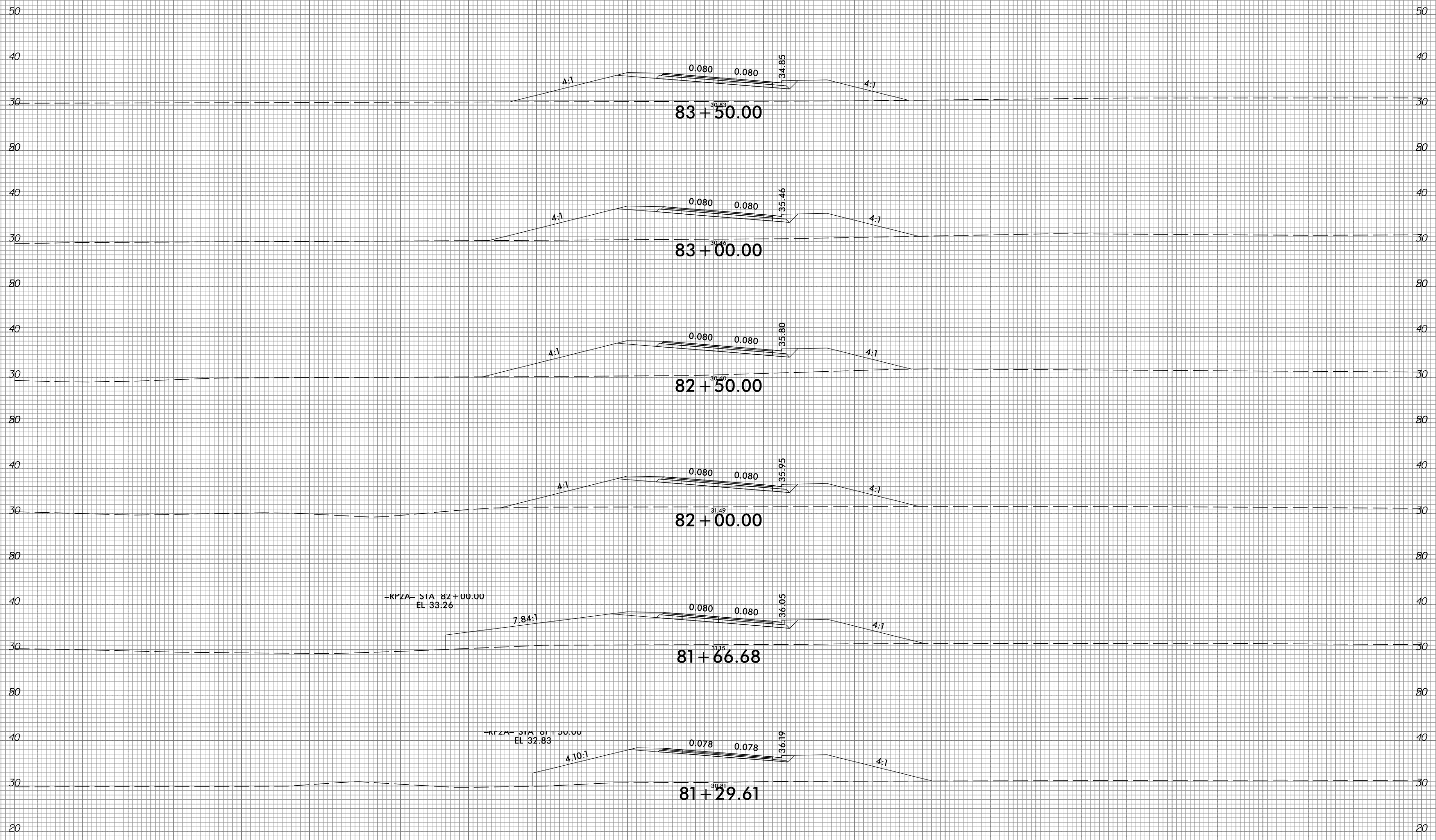

-KP2A- STA 82+00.00
 EL 33.26

-KP2A- STA 81+00.00
 EL 32.83

-LP2A-

10/31/2016
 G:\RA\9729-02\CADD\1015\Roadway\XSC\1015_xp1.LP2A.dgn
 gmc31in

150 140 130 120 110 100 90 80 70 60 50 40 30 20 10 0 10 20 30 40 50 60 70 80 90 100 110 120 130 140 150

6/23/16



PROJ. REFERENCE NO.
R-1015

SHEET NO.
X-395

150 140 130 120 110 100 90 80 70 60 50 40 30 20 10 0 10 20 30 40 50 60 70 80 90 100 110 120 130 140 150

SP
-L- STA 528+79.38
EL 31.88 END UNDERCUT EXCAVATION -LP2A- STA 87+25

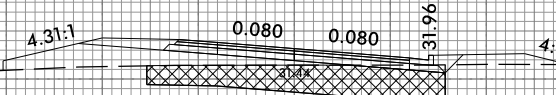

86+00.00

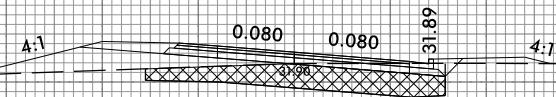

85+50.00

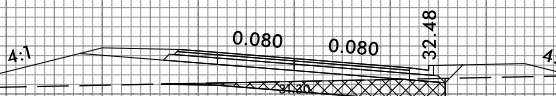

85+00.00

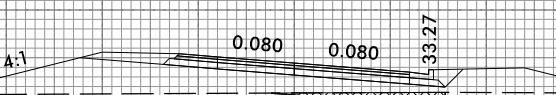

84+50.00

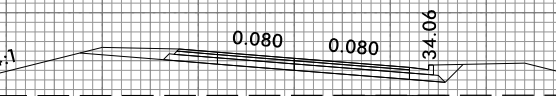

84+00.00

BEGIN UNDERCUT -LP2A- STA 83+75 +/-

-LP2A-

UNCLS
ACCEPTABLE

PROPOSED
UNDERCUT

150 140 130 120 110 100 90 80 70 60 50 40 30 20 10 0 10 20 30 40 50 60 70 80 90 100 110 120 130 140 150

10/31/2018
G:\RA\9729-02\CADD\1015\Roadway\XSC\1015_xp1.LP2A.dgn
gmc311

6/23/16



PROJ. REFERENCE NO.
R-1015

SHEET NO.
X-396

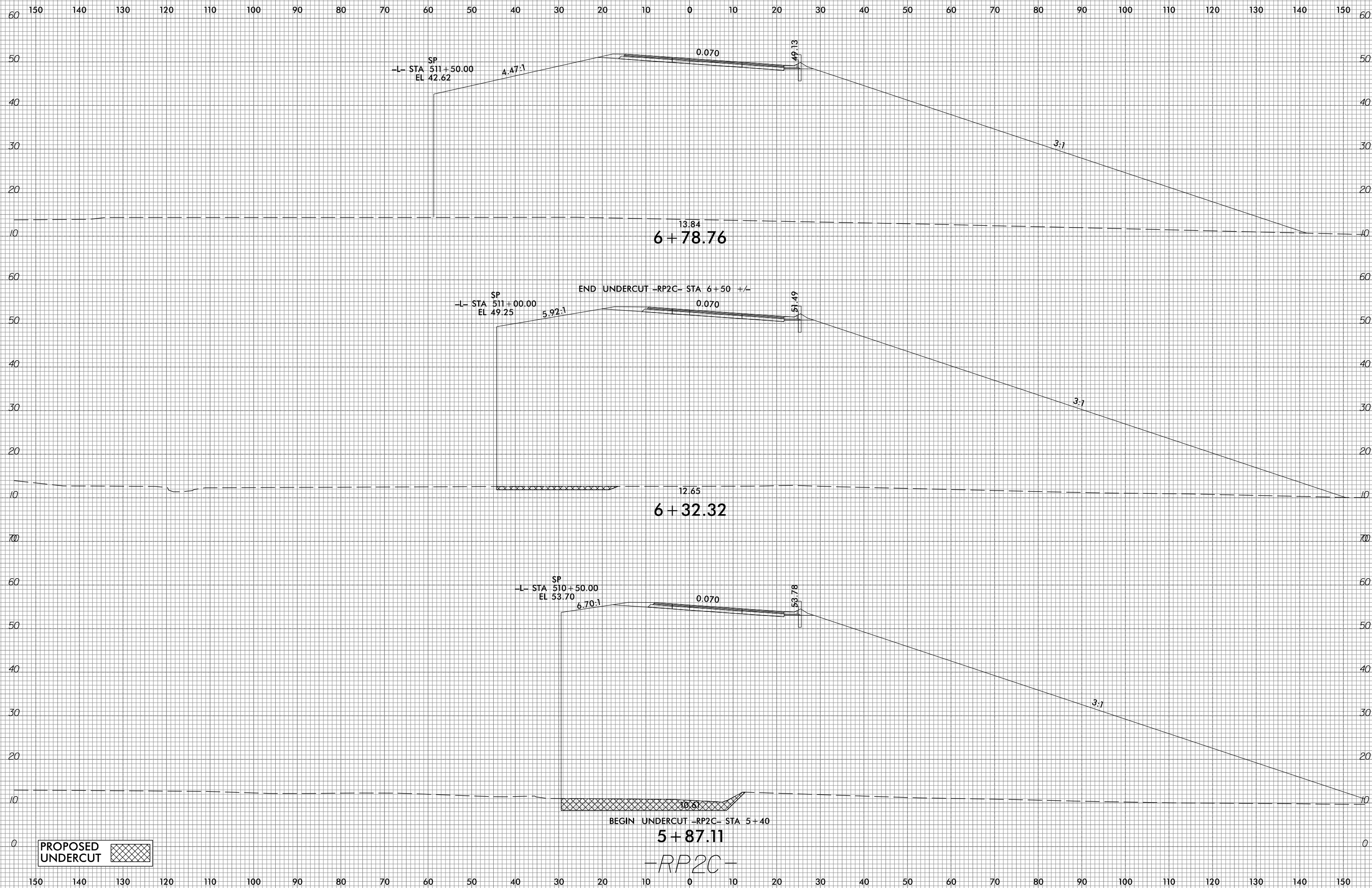

SP
-L- STA 511+50.00
EL 42.62

4.47:1

0.070

49.13

3:1

13.84
6+78.76

SP
-L- STA 511+00.00
EL 49.25

END UNDERCUT -RP2C- STA 6+50 +/-

5.92:1

0.070

51.49

3:1

12.65
6+32.32

SP
-L- STA 510+50.00
EL 53.70

6.70:1

0.070

53.78

3:1

BEGIN UNDERCUT -RP2C- STA 5+40

10.61
5+87.11

-RP2C-

PROPOSED UNDERCUT



10/31/2018
G:\RA\9729-02\CADD\1015\Roadway\XSC\1015_xp1_RP2C.dgn
gncdlin

6/23/16



PROJ. REFERENCE NO.
R-1015

SHEET NO.
X-397

150 140 130 120 110 100 90 80 70 60 50 40 30 20 10 0 10 20 30 40 50 60 70 80 90 100 110 120 130 140 150

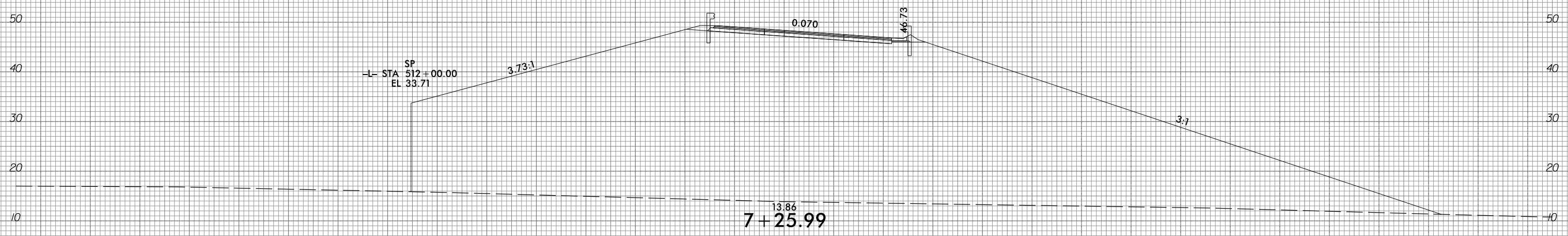
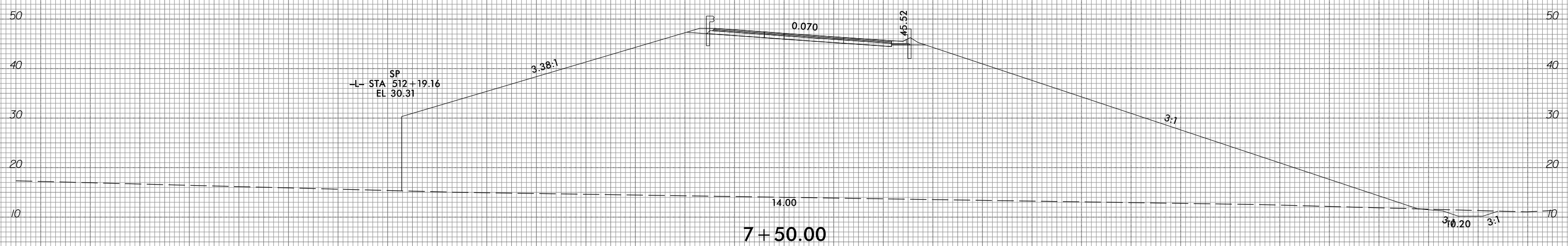
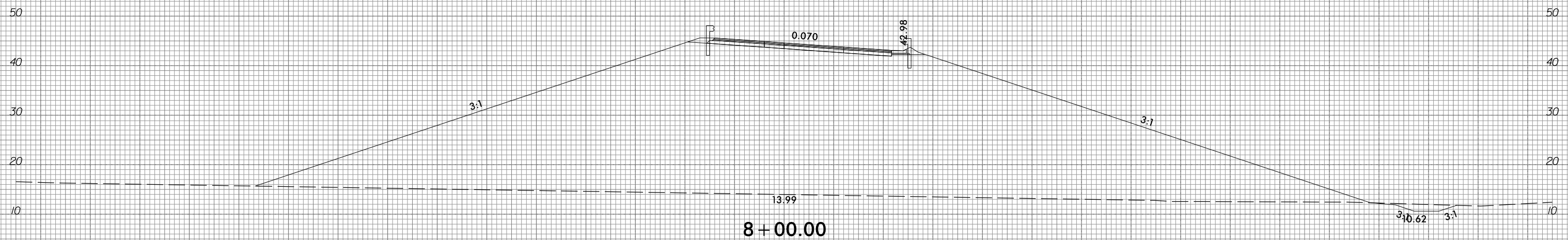

-RP2C-

150 140 130 120 110 100 90 80 70 60 50 40 30 20 10 0 10 20 30 40 50 60 70 80 90 100 110 120 130 140 150

10/31/2018
G:\RA\9729-02\CADD\1015\Roadway\XSC\1015_xp1_RP2C.dgn
gncdlin

6/23/16



| | |
|---------------------|-----------|
| PROJ. REFERENCE NO. | SHEET NO. |
| R-1015 | X-398 |

150 140 130 120 110 100 90 80 70 60 50 40 30 20 10 0 10 20 30 40 50 60 70 80 90 100 110 120 130 140 150

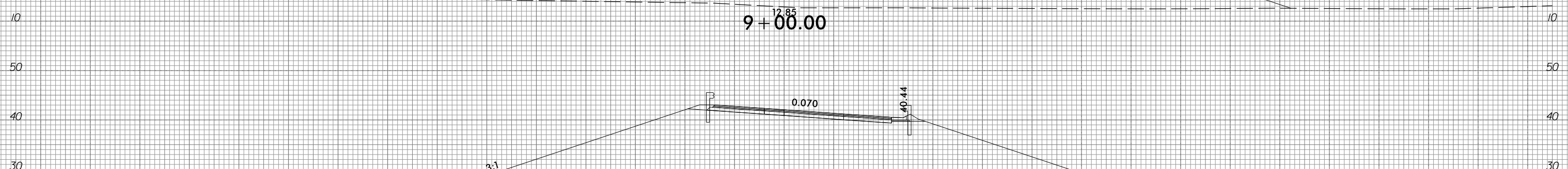
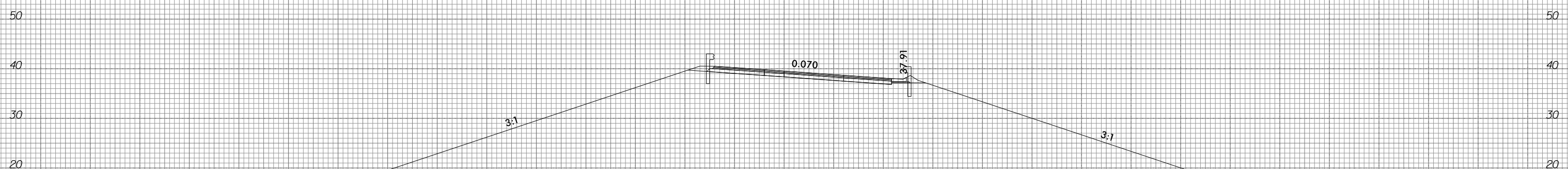
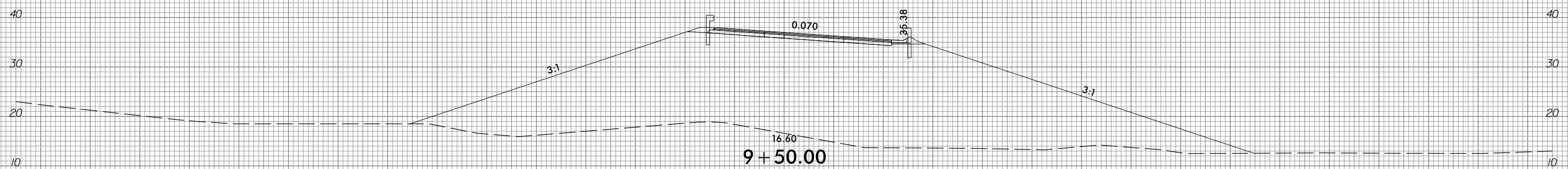
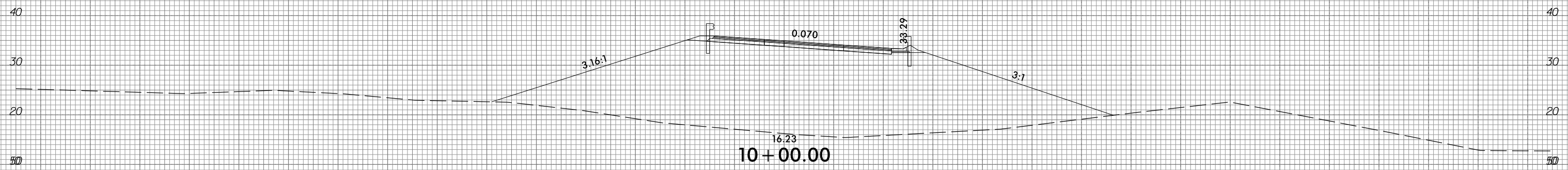

-RP2C-

150 140 130 120 110 100 90 80 70 60 50 40 30 20 10 0 10 20 30 40 50 60 70 80 90 100 110 120 130 140 150

10/31/2018
 G:\RA\9729-02\CADD\1015\Roadway\XSC\1015_xp1_RP2C.dgn
 gmc011n

6/23/16



PROJ. REFERENCE NO.
R-1015

SHEET NO.
X-399

150 140 130 120 110 100 90 80 70 60 50 40 30 20 10 0 10 20 30 40 50 60 70 80 90 100 110 120 130 140 150

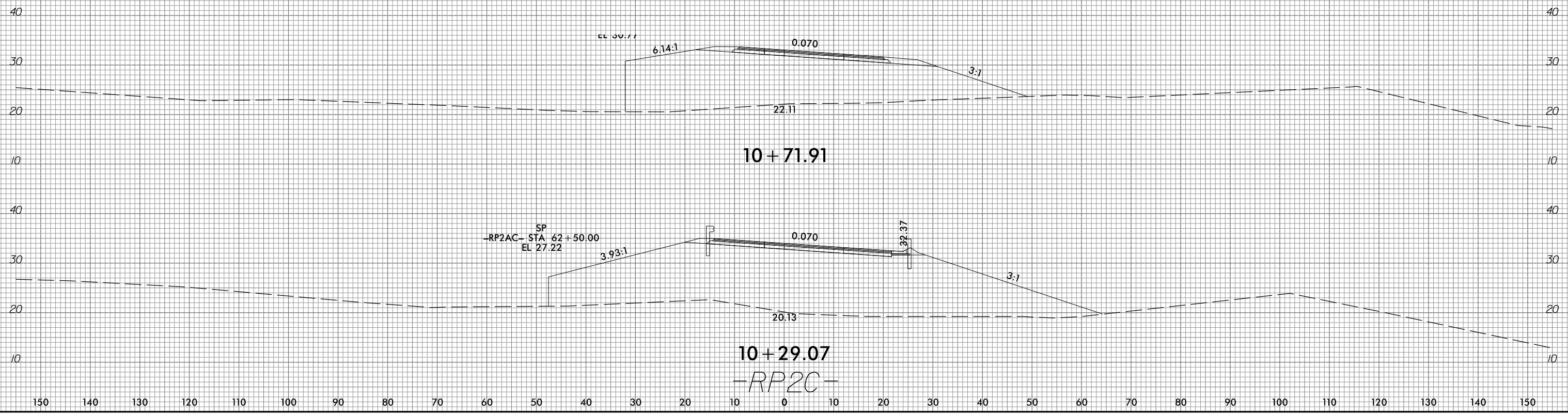

10/31/2018
G:\RA\9729-02\CADD\1015\Roadway\XSC\1015_xp1_RP2C.dgn
gncdlin

150 140 130 120 110 100 90 80 70 60 50 40 30 20 10 0 10 20 30 40 50 60 70 80 90 100 110 120 130 140 150



150 140 130 120 110 100 90 80 70 60 50 40 30 20 10 0 10 20 30 40 50 60 70 80 90 100 110 120 130 140 150

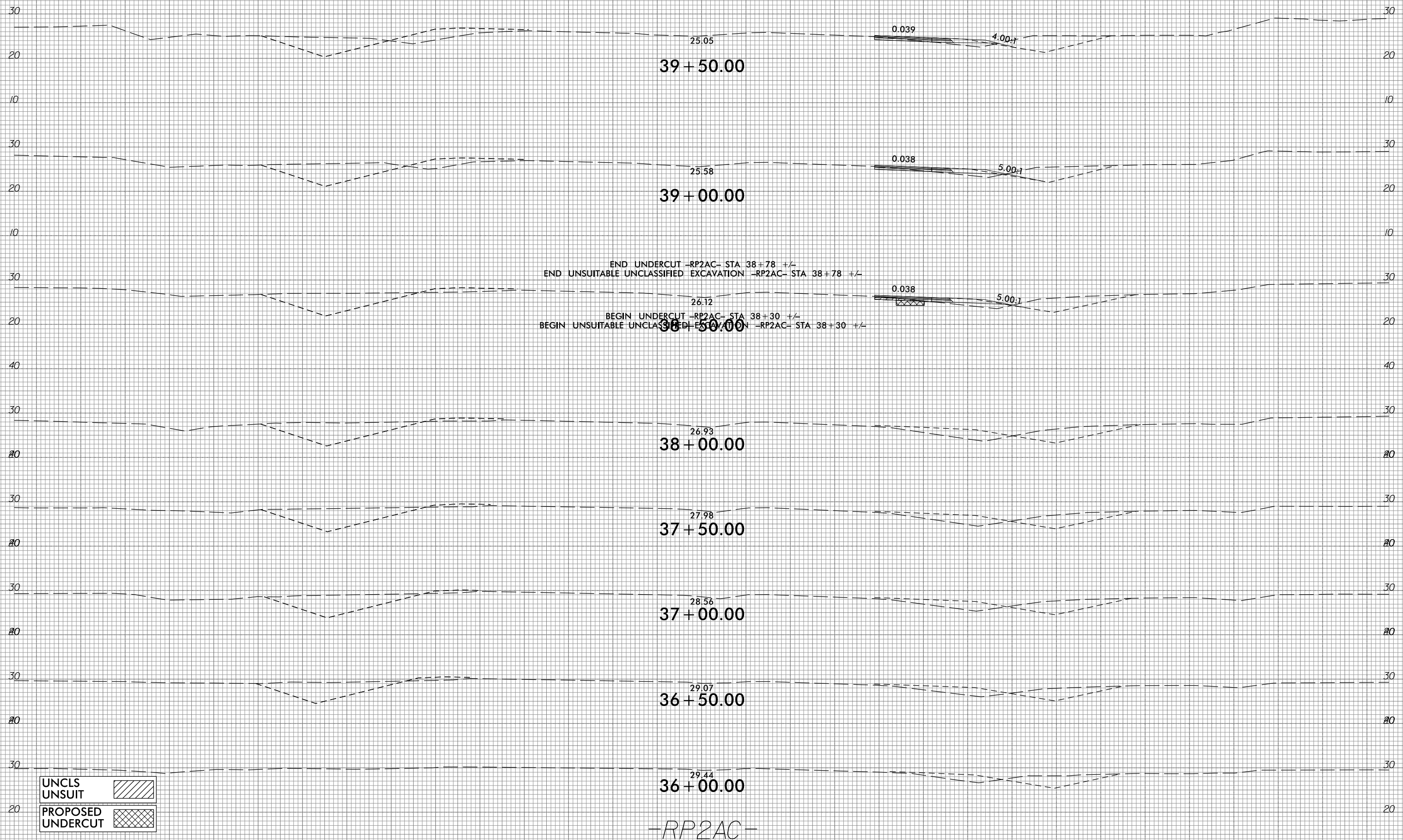

END UNDERCUT -RP2AC- STA 38+78 +/-
END UNSUITABLE UNCLASSIFIED EXCAVATION -RP2AC- STA 38+78 +/-
26.12
BEGIN UNDERCUT -RP2AC- STA 38+30 +/-
BEGIN UNSUITABLE UNCLASSIFIED EXCAVATION -RP2AC- STA 38+30 +/-

UNCLS
UNSUIT

PROPOSED
UNDERCUT

-RP2AC-

150 140 130 120 110 100 90 80 70 60 50 40 30 20 10 0 10 20 30 40 50 60 70 80 90 100 110 120 130 140 150



150 140 130 120 110 100 90 80 70 60 50 40 30 20 10 0 10 20 30 40 50 60 70 80 90 100 110 120 130 140 150

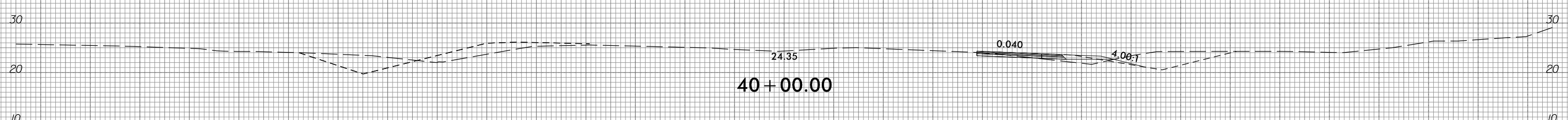
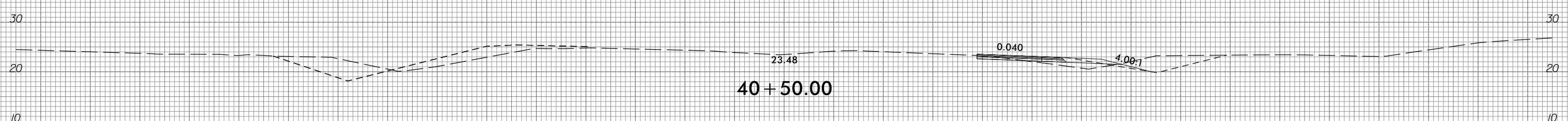
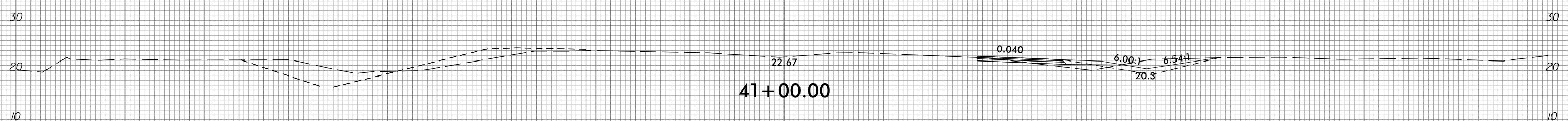
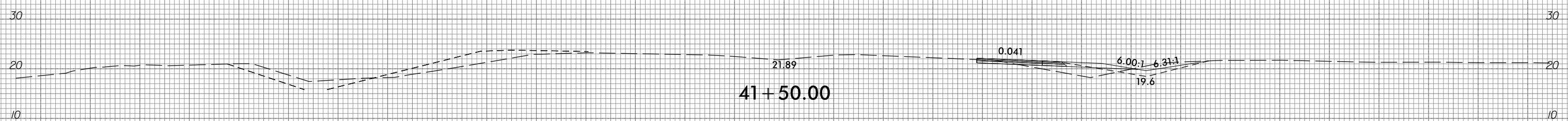
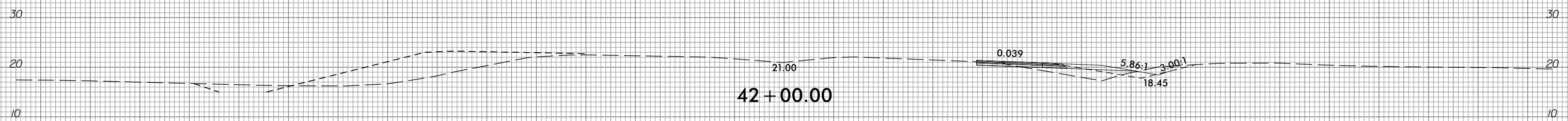
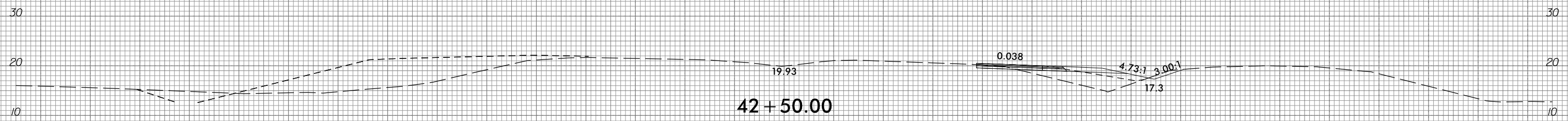

-RP2AC-

150 140 130 120 110 100 90 80 70 60 50 40 30 20 10 0 10 20 30 40 50 60 70 80 90 100 110 120 130 140 150

6/23/16



PROJ. REFERENCE NO.
R-1015

SHEET NO.
X-402

150 140 130 120 110 100 90 80 70 60 50 40 30 20 10 0 10 20 30 40 50 60 70 80 90 100 110 120 130 140 150

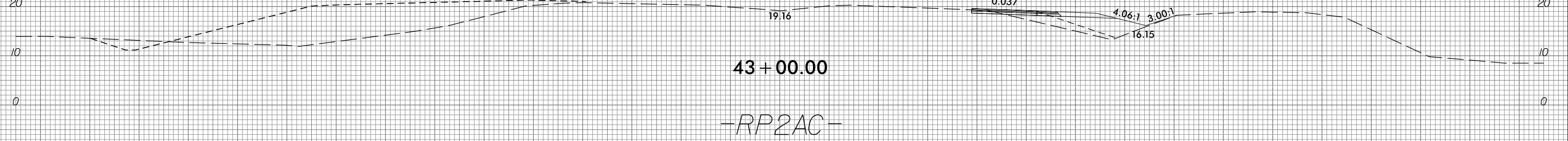
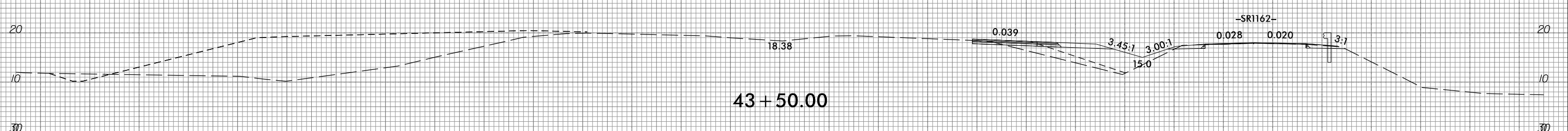
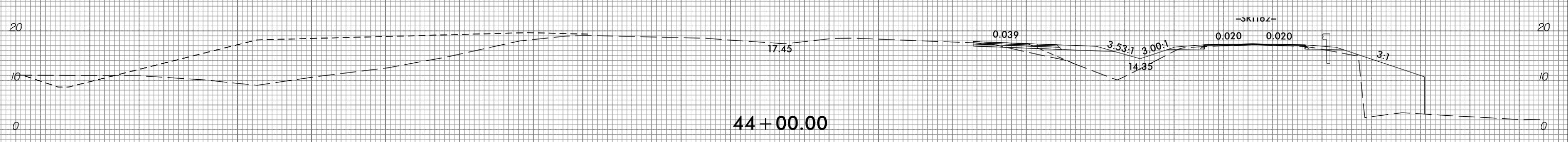
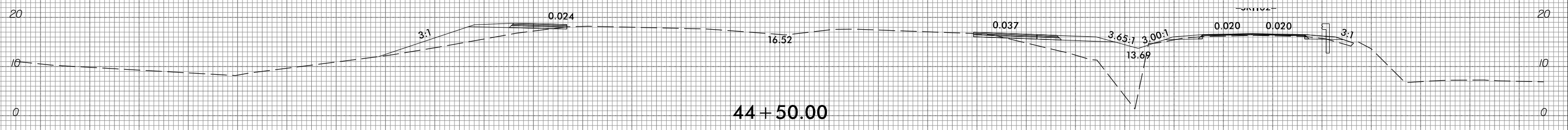
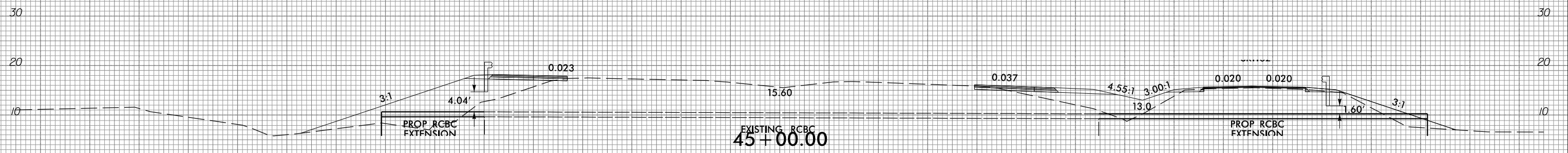

-RP2AC-

I:\2016\11\17\2016-02\CA00\1015\Roadway\XSC\1015_xp1_RP2AC.dgn

6/23/16



PROJ. REFERENCE NO.
R-1015

SHEET NO.
X-403

150 140 130 120 110 100 90 80 70 60 50 40 30 20 10 0 10 20 30 40 50 60 70 80 90 100 110 120 130 140 150

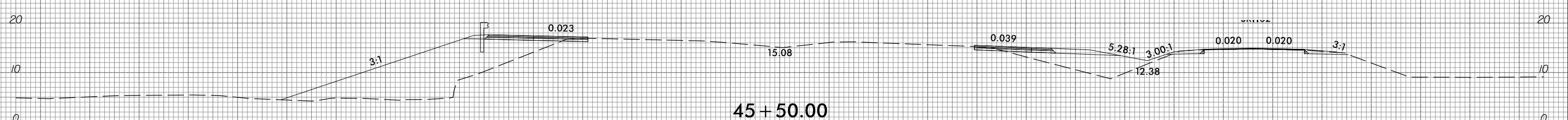
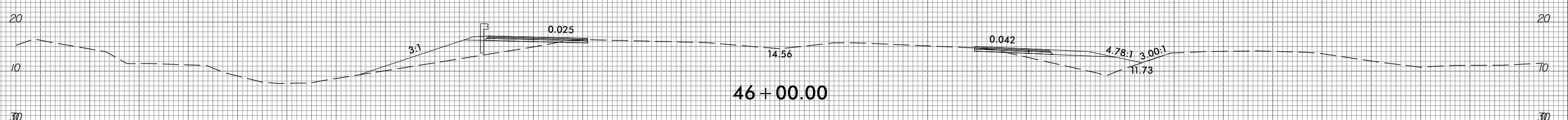
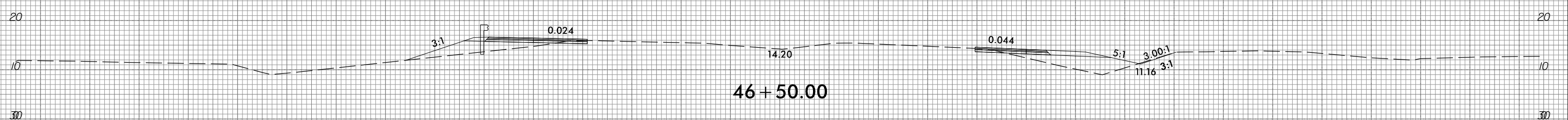
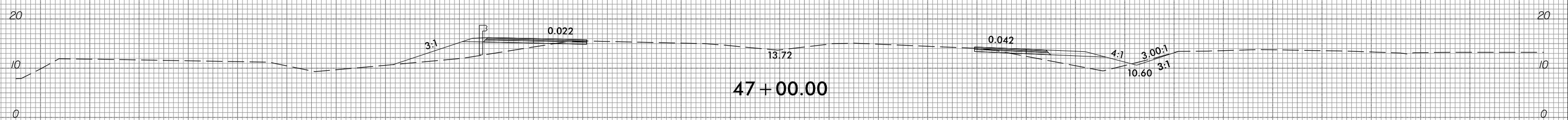
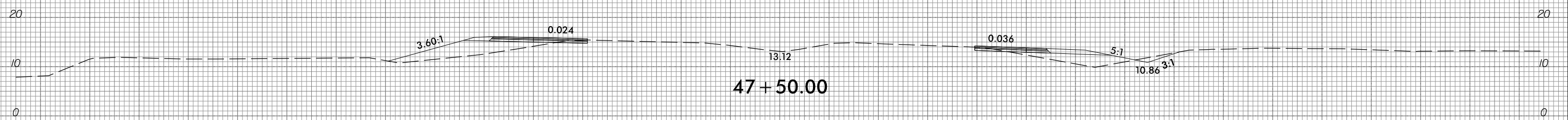
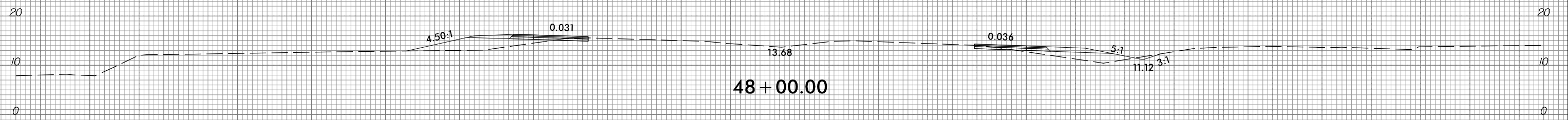

RP2AC

I:\2016\11\1\2016-02\CAD\1015\Roadway\XSC\1015_xp1_RP2AC.dgn



150 140 130 120 110 100 90 80 70 60 50 40 30 20 10 0 10 20 30 40 50 60 70 80 90 100 110 120 130 140 150

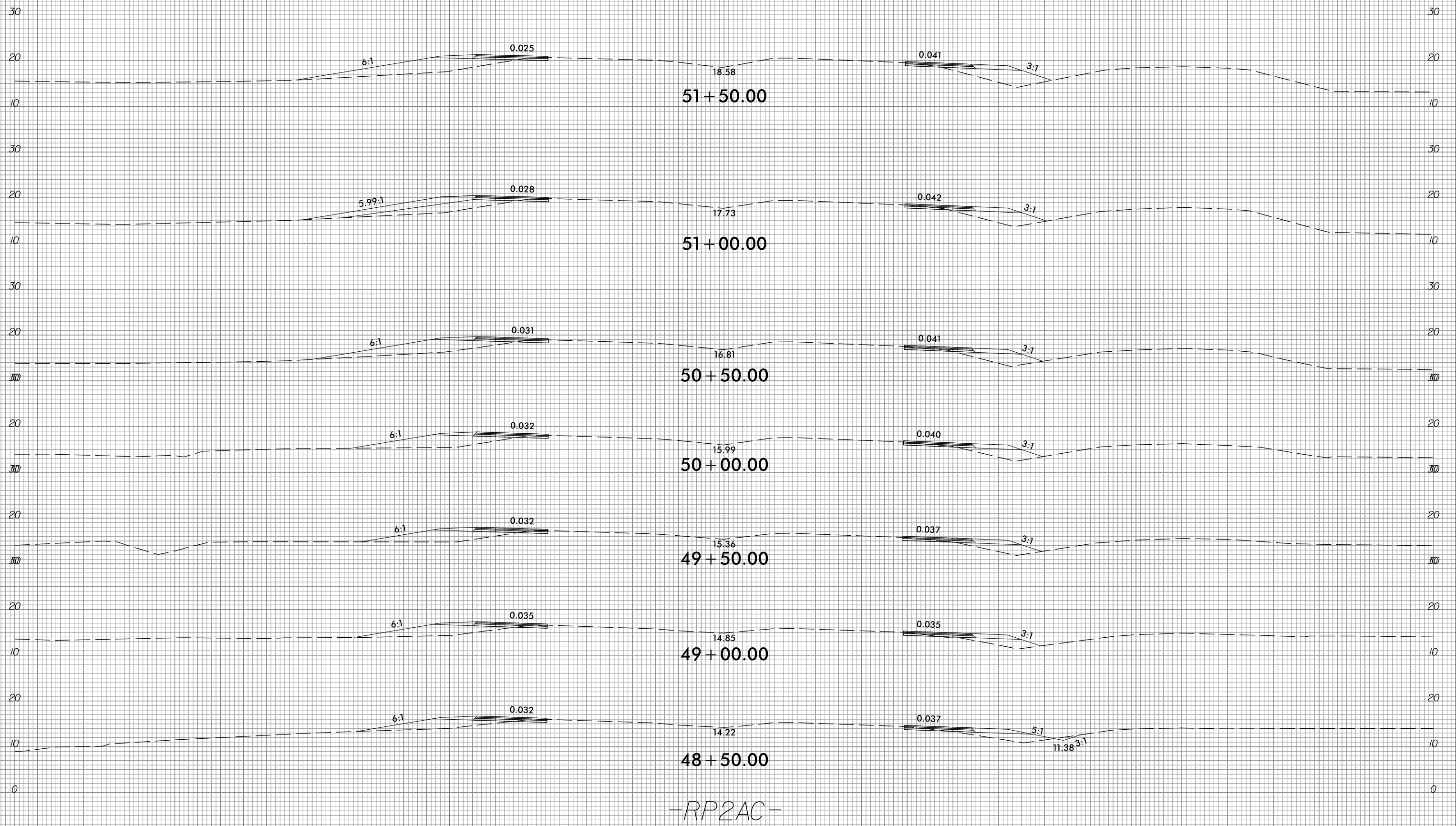

-RP2AC-



150 140 130 120 110 100 90 80 70 60 50 40 30 20 10 0 10 20 30 40 50 60 70 80 90 100 110 120 130 140 150

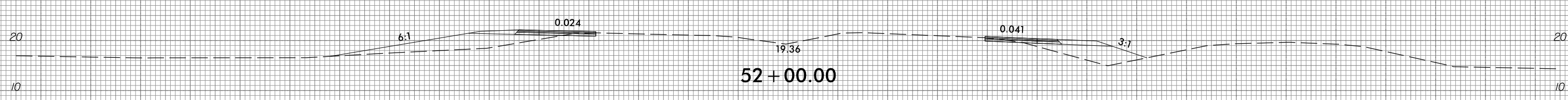
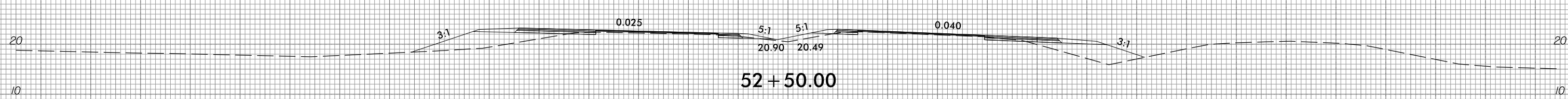
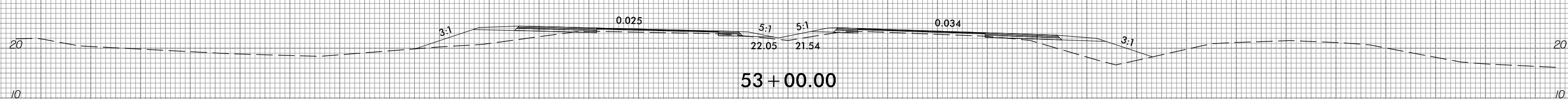
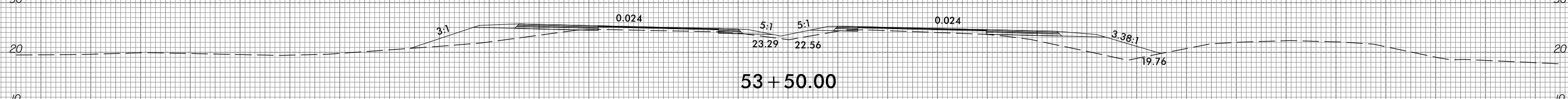
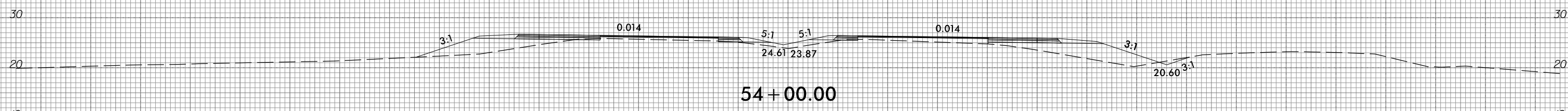
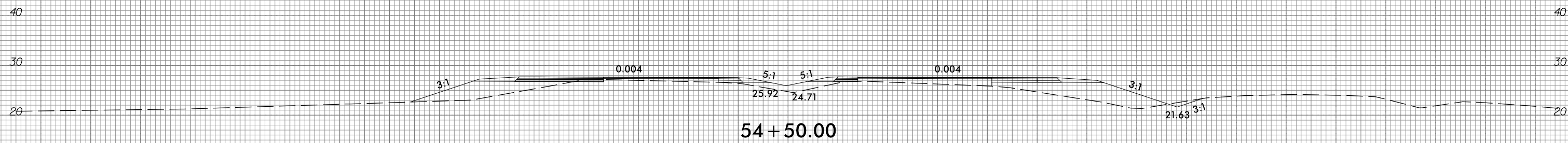

-RP2AC-

150 140 130 120 110 100 90 80 70 60 50 40 30 20 10 0 10 20 30 40 50 60 70 80 90 100 110 120 130 140 150

6/23/16

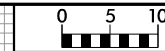

| PROJ. REFERENCE NO. | SHEET NO. |
|---------------------|-----------|
| R-1015 | X-406 |

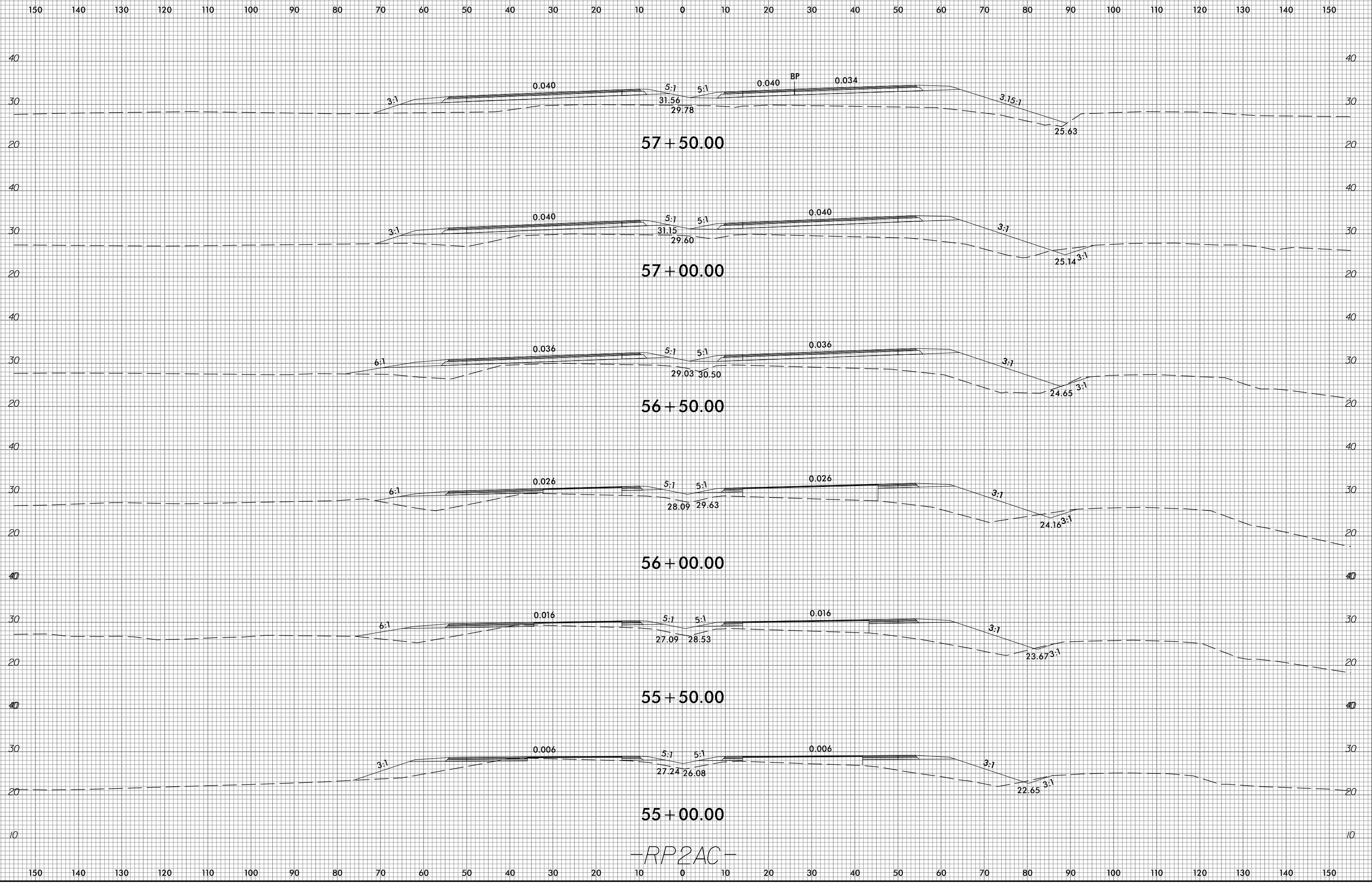

-RP2AC-

I:\2016\11\2016-11-17\29-02\CADD\1015\Roadway\XSC\1015_xp1_RP2AC.dgn

6/23/16



PROJ. REFERENCE NO.
R-1015

SHEET NO.
X-407

150 140 130 120 110 100 90 80 70 60 50 40 30 20 10 0 10 20 30 40 50 60 70 80 90 100 110 120 130 140 150

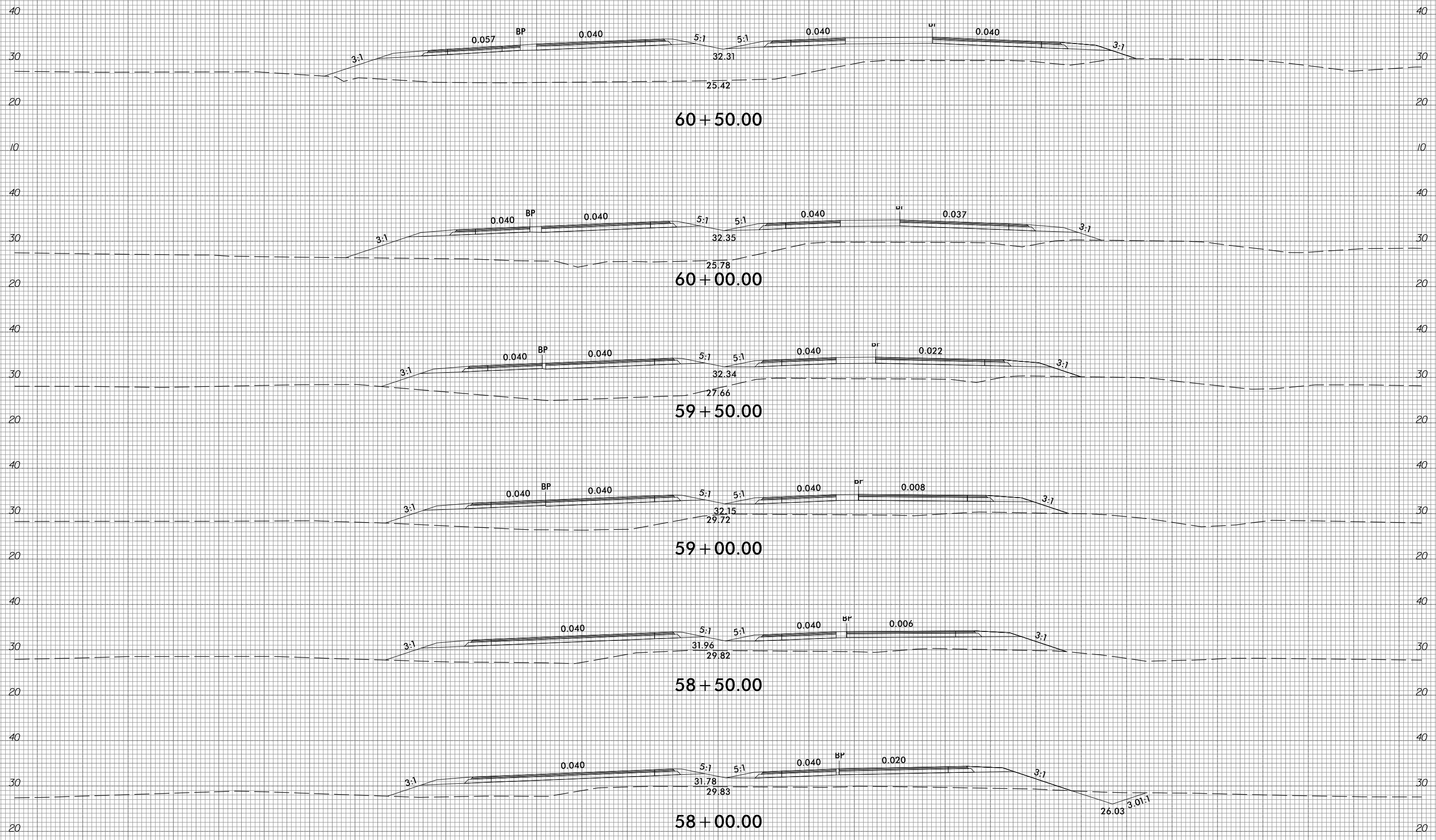

RP2AC

I:\2016\11\2016-06\11\2016-06-23\16\02\CADD\1015\Roadway\XSC\1015_xp1_RP2AC.dgn
gncdlin

6/23/16



PROJ. REFERENCE NO.
R-1015

SHEET NO.
X-408

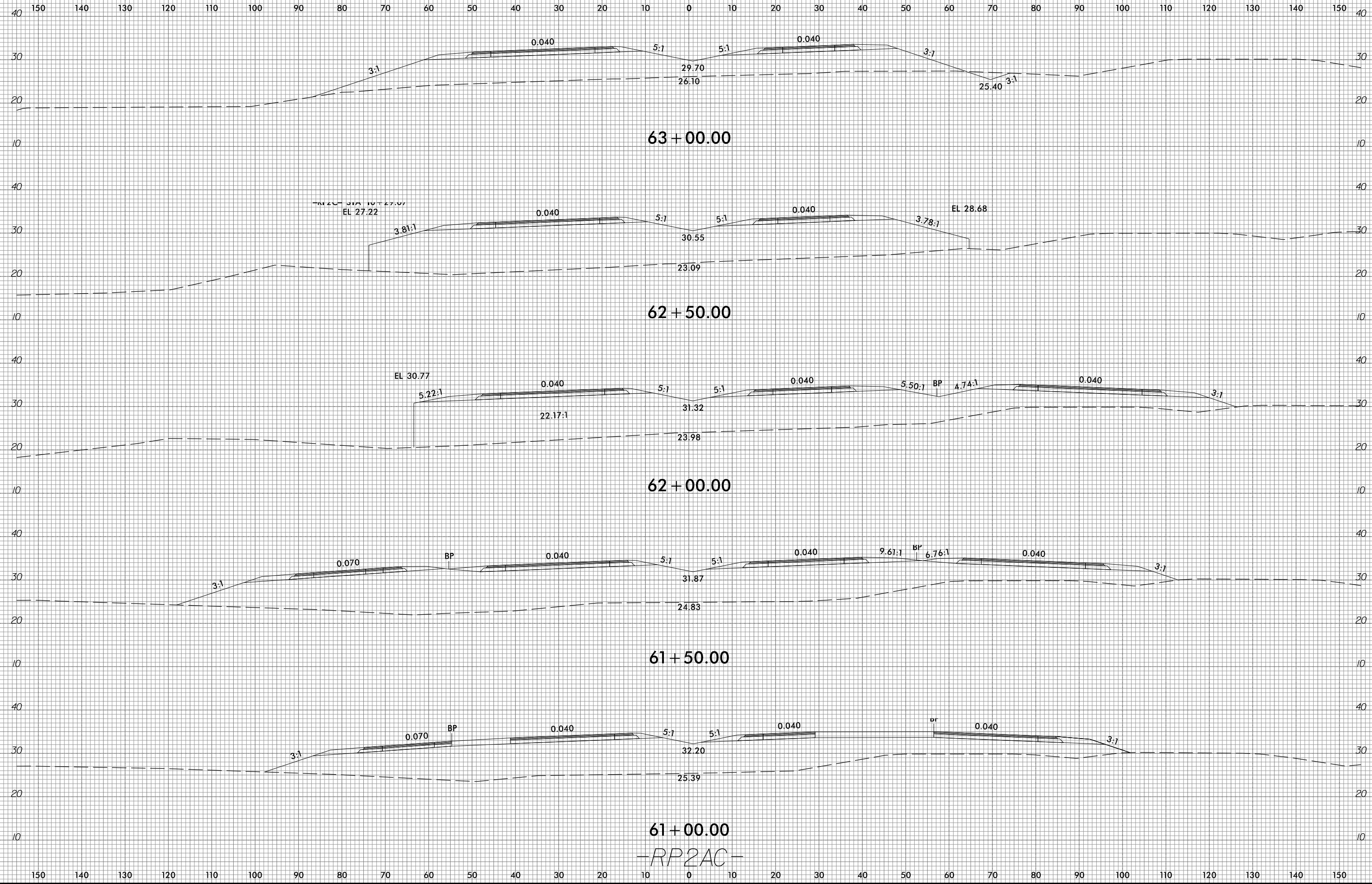

I:\2016\11\2016-09-29-02\CADD\1015\Roadway\XSC\1015_xp1_RP2AC.dgn
gncdlin

6/23/16



PROJ. REFERENCE NO.
R-1015

SHEET NO.
X-409

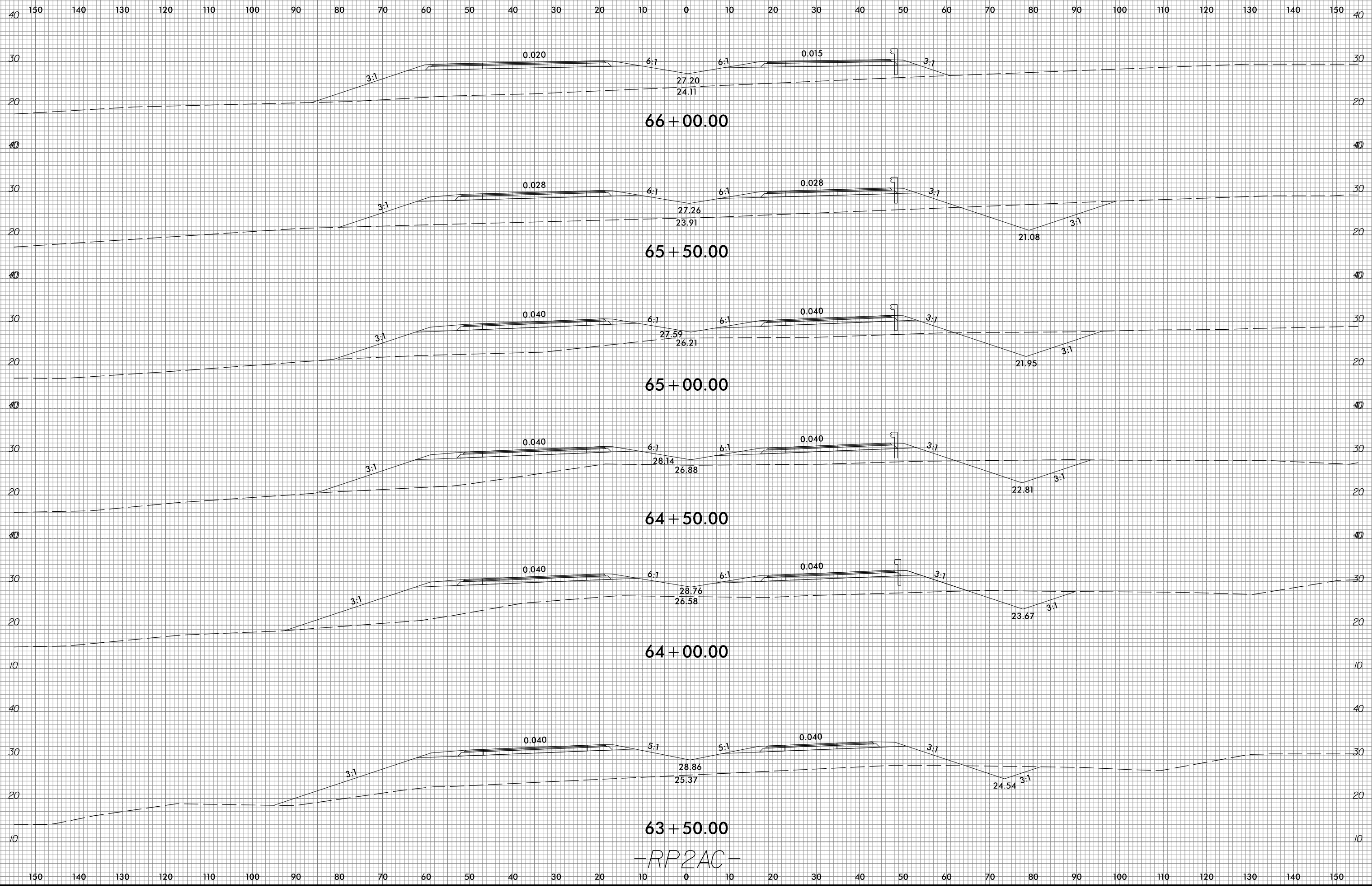

RP2AC

I:\2016\11\2016-02\11\2016-02\CADD\1015\Roadway\XSC\1015_xp1_RP2AC.dgn



150 140 130 120 110 100 90 80 70 60 50 40 30 20 10 0 10 20 30 40 50 60 70 80 90 100 110 120 130 140 150

40 40

30 30

20 20

40 40

30 30

20 20

40 40

30 30

20 20

40 40

30 30

20 20

40 40

30 30

20 20

40 40

30 30

20 20

40 40

30 30

20 20

10 10

150 140 130 120 110 100 90 80 70 60 50 40 30 20 10 0 10 20 30 40 50 60 70 80 90 100 110 120 130 140 150

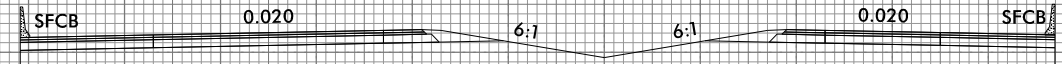

69+00.00

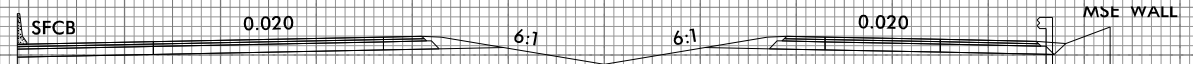

68+50.00

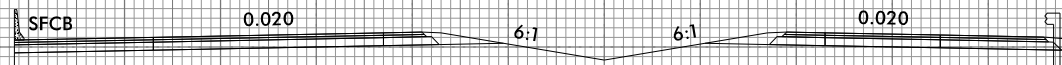

68+00.00

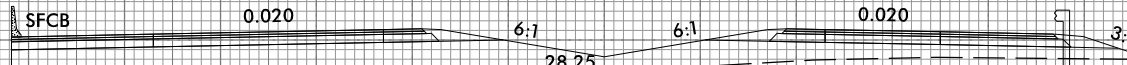

67+50.00

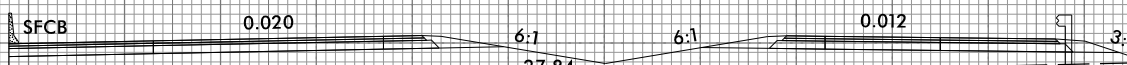

67+00.00

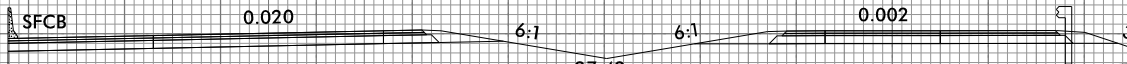

66+50.00

-RP2AC-

6/23/16



PROJ. REFERENCE NO.
R-1015

SHEET NO.
X-411

150 140 130 120 110 100 90 80 70 60 50 40 30 20 10 0 10 20 30 40 50 60 70 80 90 100 110 120 130 140 150

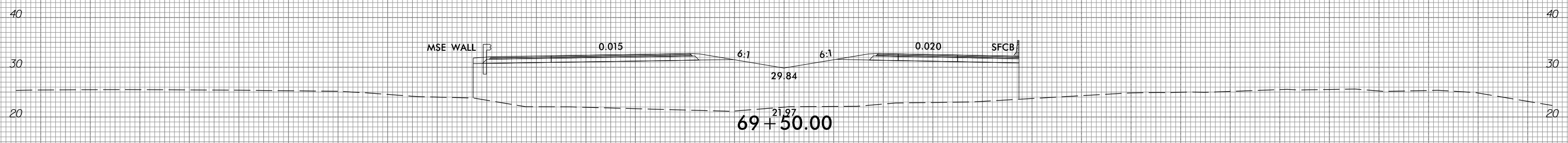
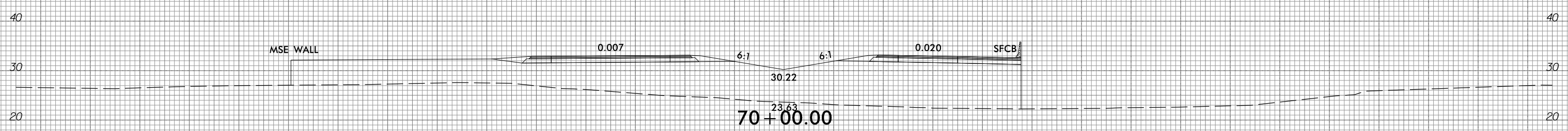
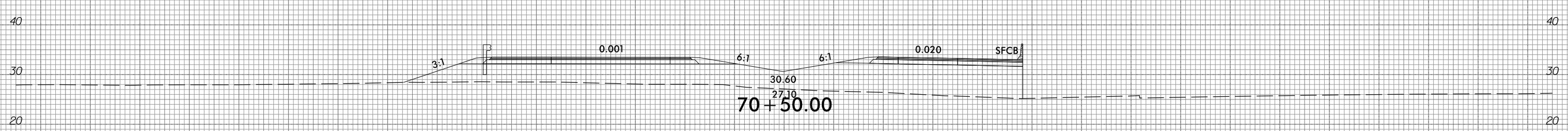
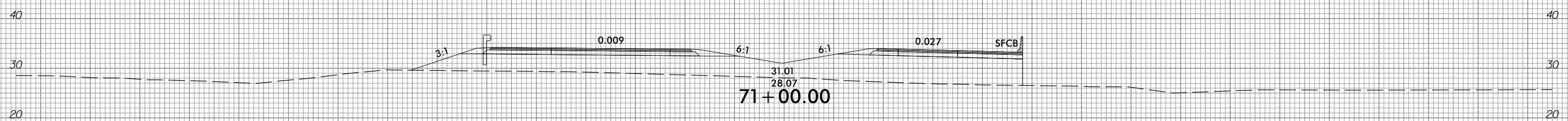
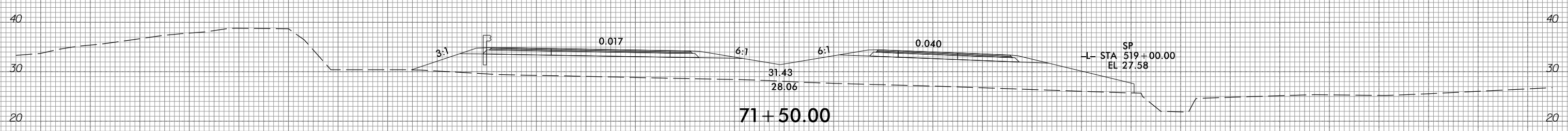
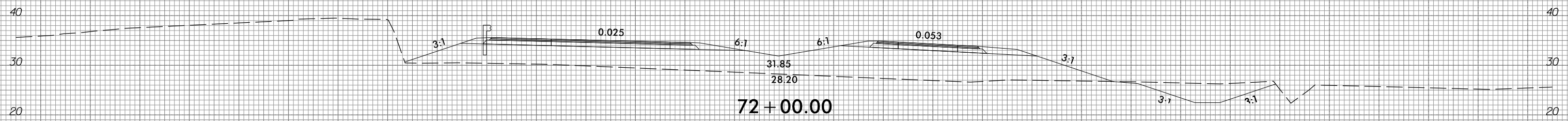

-RP2AC-

150 140 130 120 110 100 90 80 70 60 50 40 30 20 10 0 10 20 30 40 50 60 70 80 90 100 110 120 130 140 150

I:\2016\11\2016-11-17\11-17-29-02\CAD\1015\Roadway\XSC\1015_xp1_RP2AC.dgn

6/23/16



PROJ. REFERENCE NO.
R-1015

SHEET NO.
X-412

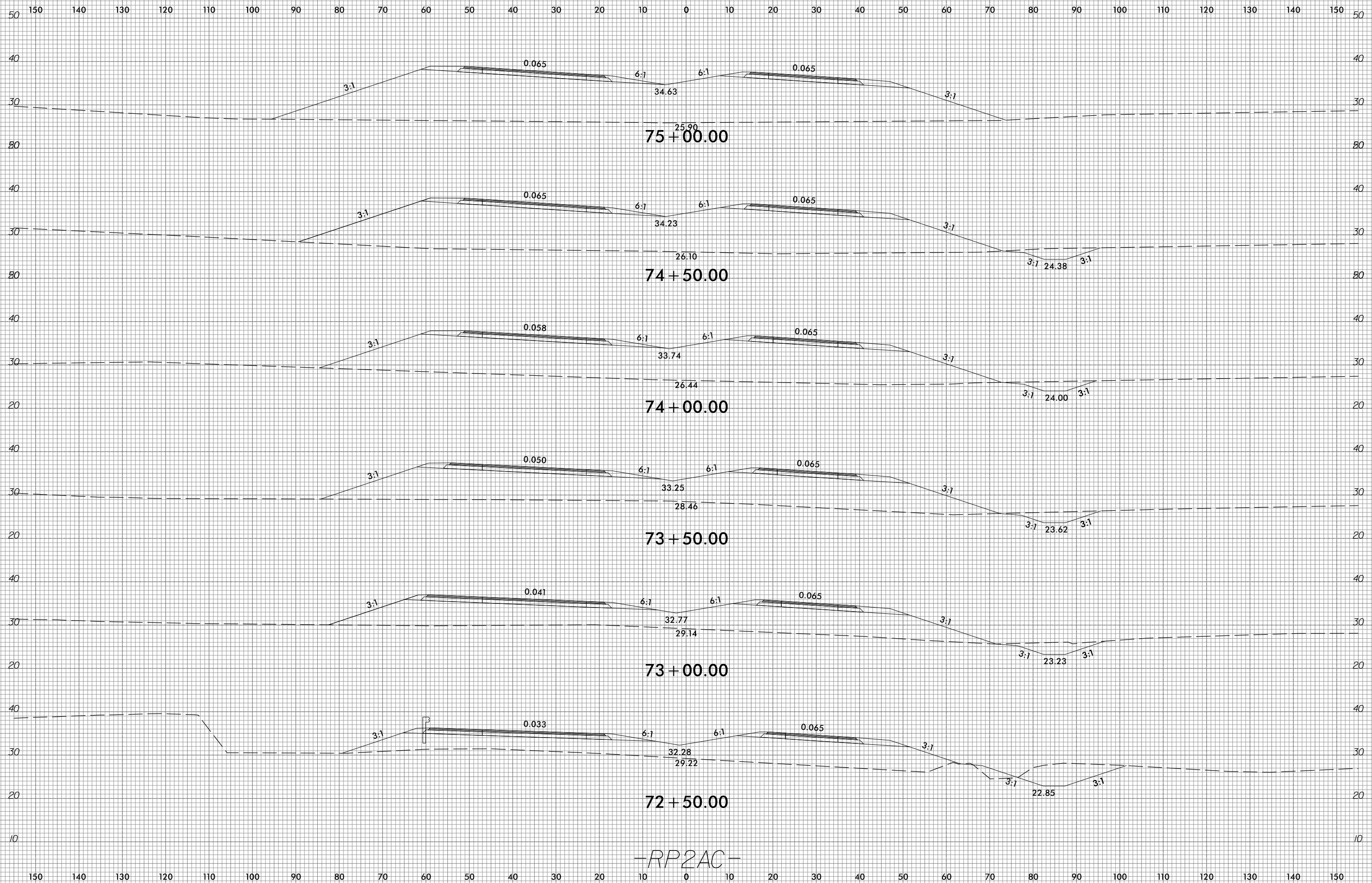

-RP2AC-

I:\2016\11\17\2016-02\CADD\1015\Roadway\XSC\1015_xp1_RP2AC.dgn
gncdlin



150 140 130 120 110 100 90 80 70 60 50 40 30 20 10 0 10 20 30 40 50 60 70 80 90 100 110 120 130 140 150

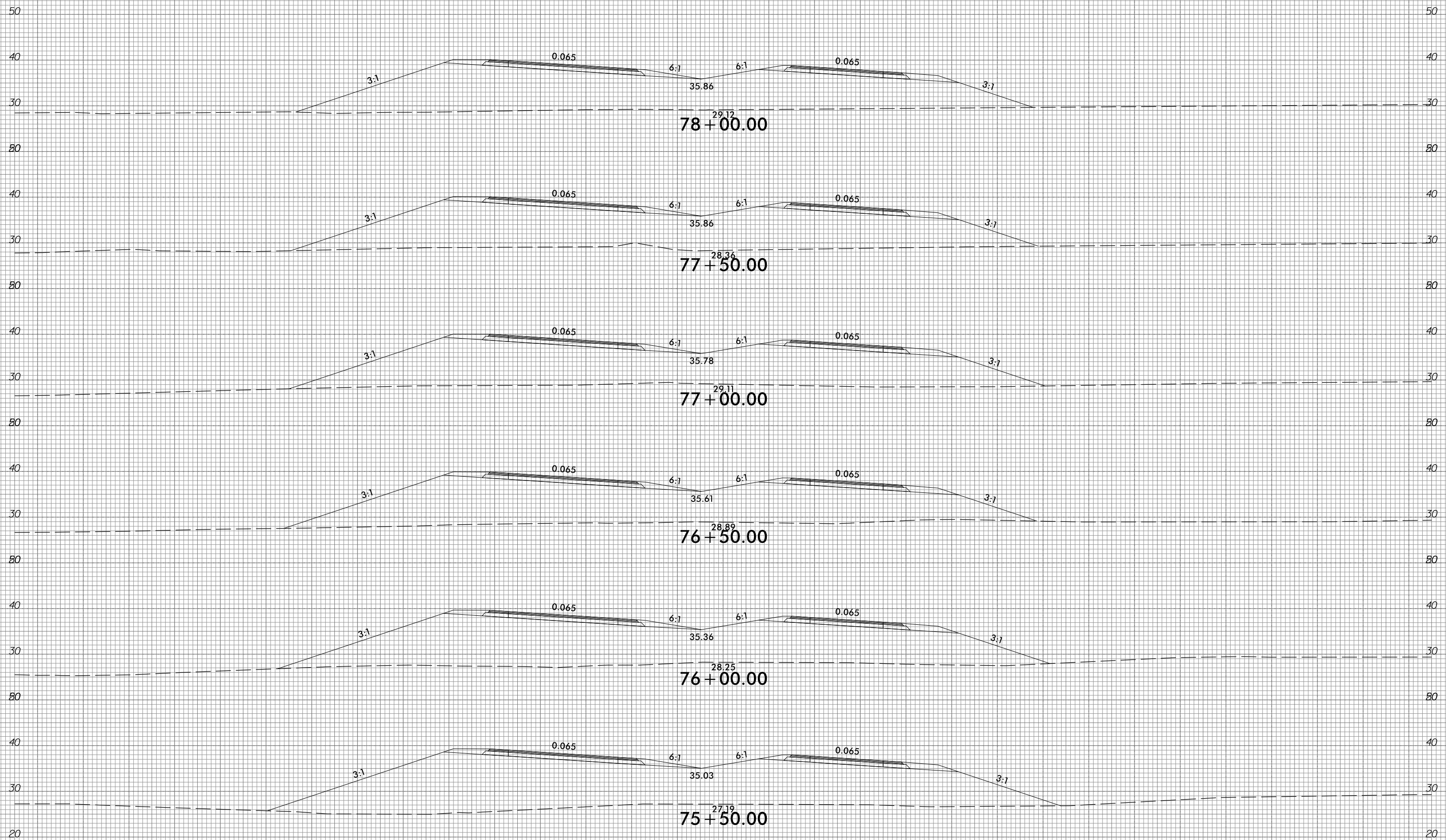

-RP2AC-

6/23/16



| |
|---------------------|
| PROJ. REFERENCE NO. |
| R-1015 |

| |
|-----------|
| SHEET NO. |
| X-414 |

150 140 130 120 110 100 90 80 70 60 50 40 30 20 10 0 10 20 30 40 50 60 70 80 90 100 110 120 130 140 150

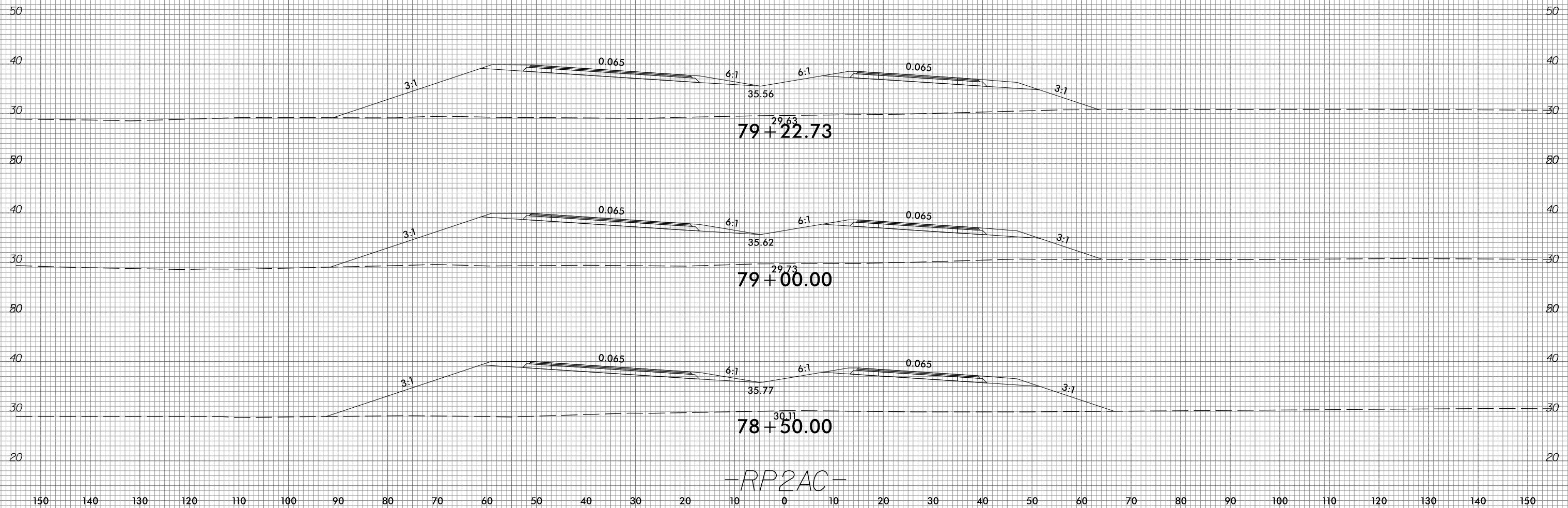

I:\2016\11\1\2016-02\CADD\1015\Roadway\XSC\1015_xp1_RP2AC.dgn
 gmc311

150 140 130 120 110 100 90 80 70 60 50 40 30 20 10 0 10 20 30 40 50 60 70 80 90 100 110 120 130 140 150

6/23/16



PROJ. REFERENCE NO.
R-1015

SHEET NO.
X-415

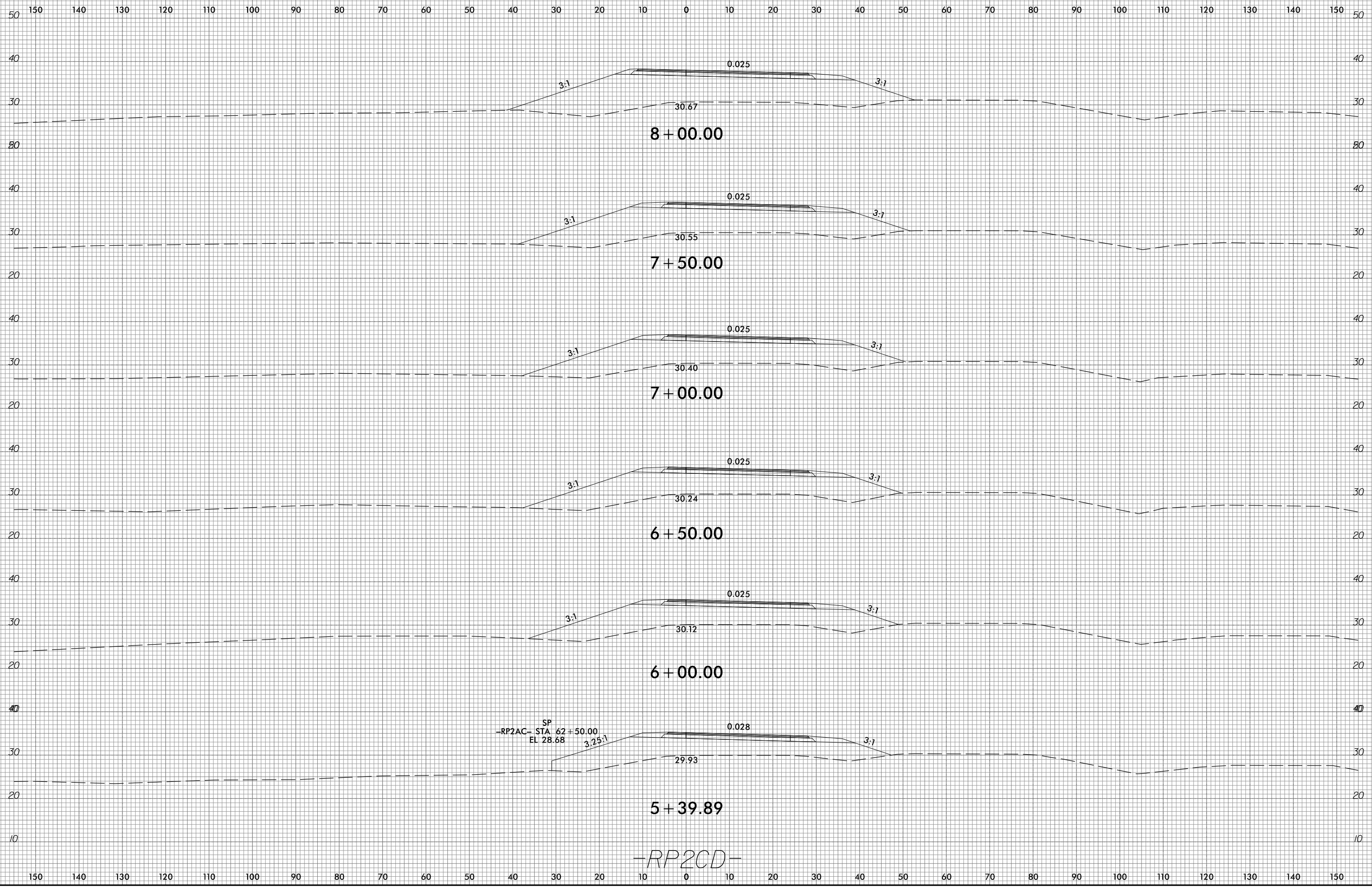

| |
|----------------------|
| SP |
| -RP2AC- STA 62+50.00 |
| EL 28.68 |
| 3.25:1 |

-RP2CD-

10/31/2018
G:\RA\9729-02\CADD\1015\Roadway\XSC\1015_xp1_RP2CD.dgn
gncdlin

6/23/16



| | |
|---------------------|-----------|
| PROJ. REFERENCE NO. | SHEET NO. |
| R-1015 | X-416 |

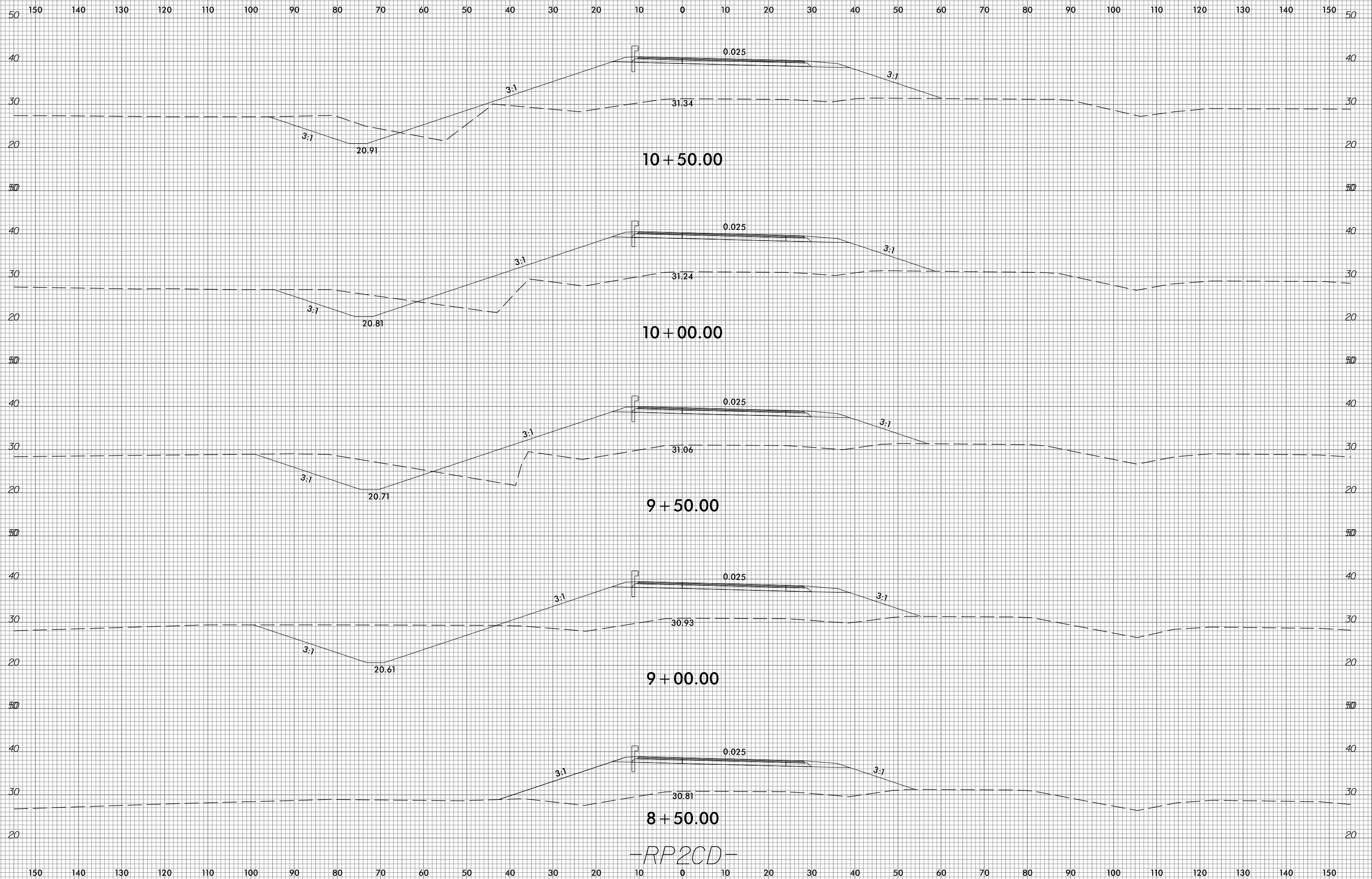

-RP2CD-

10/31/2018
G:\RA\9729-02\CADD\1015\Roadway\XSC\1015_xp1_RP2CD.dgn
gncdlin

6/23/16



PROJ. REFERENCE NO.
R-1015

SHEET NO.
X-417

150 140 130 120 110 100 90 80 70 60 50 40 30 20 10 0 10 20 30 40 50 60 70 80 90 100 110 120 130 140 150

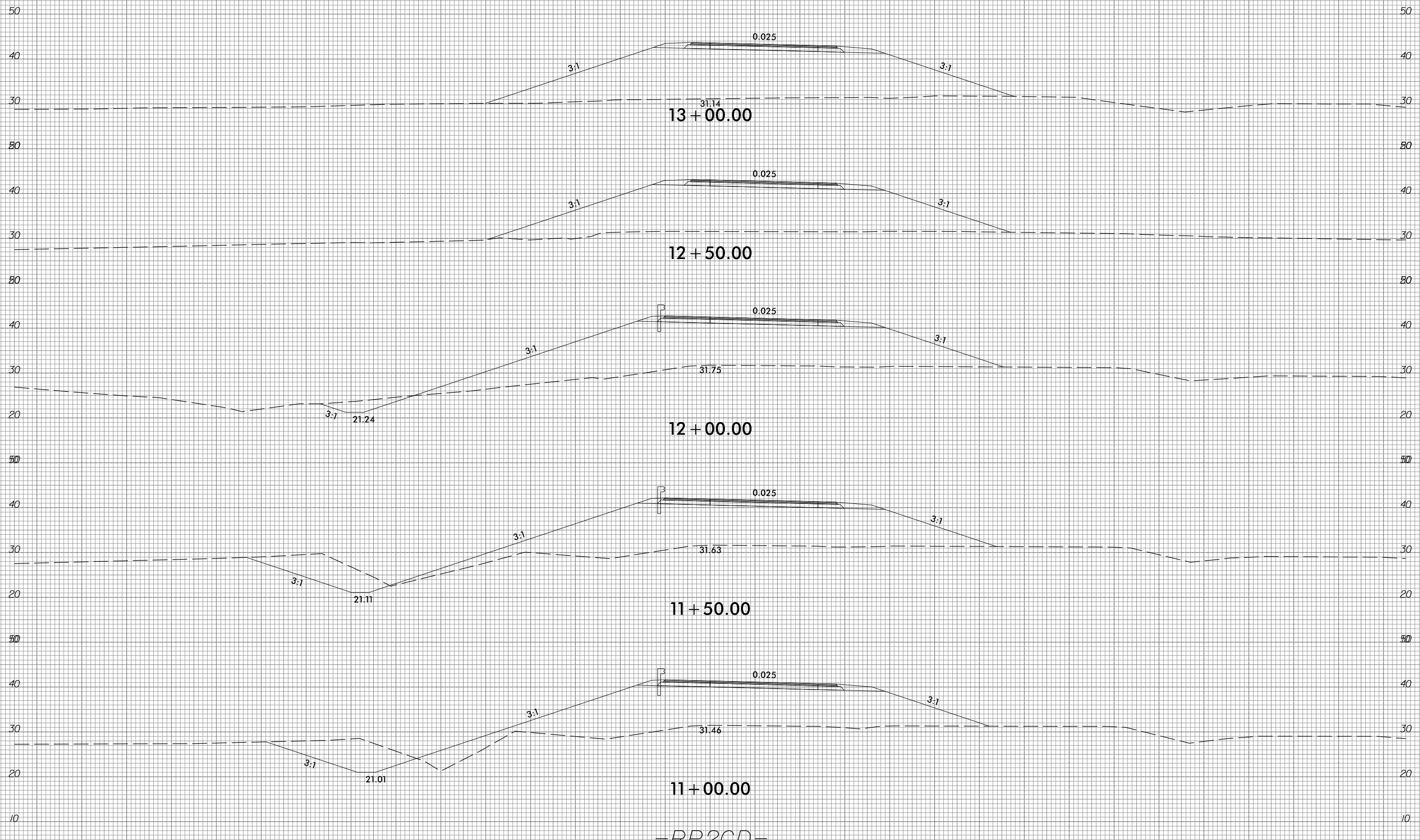

-RP2CD-

10/31/2018
G:\RA\9729-02\CADD\1015\Roadway\XSC\1015_xp1_RP2CD.dgn
gncdlin



150 140 130 120 110 100 90 80 70 60 50 40 30 20 10 0 10 20 30 40 50 60 70 80 90 100 110 120 130 140 150

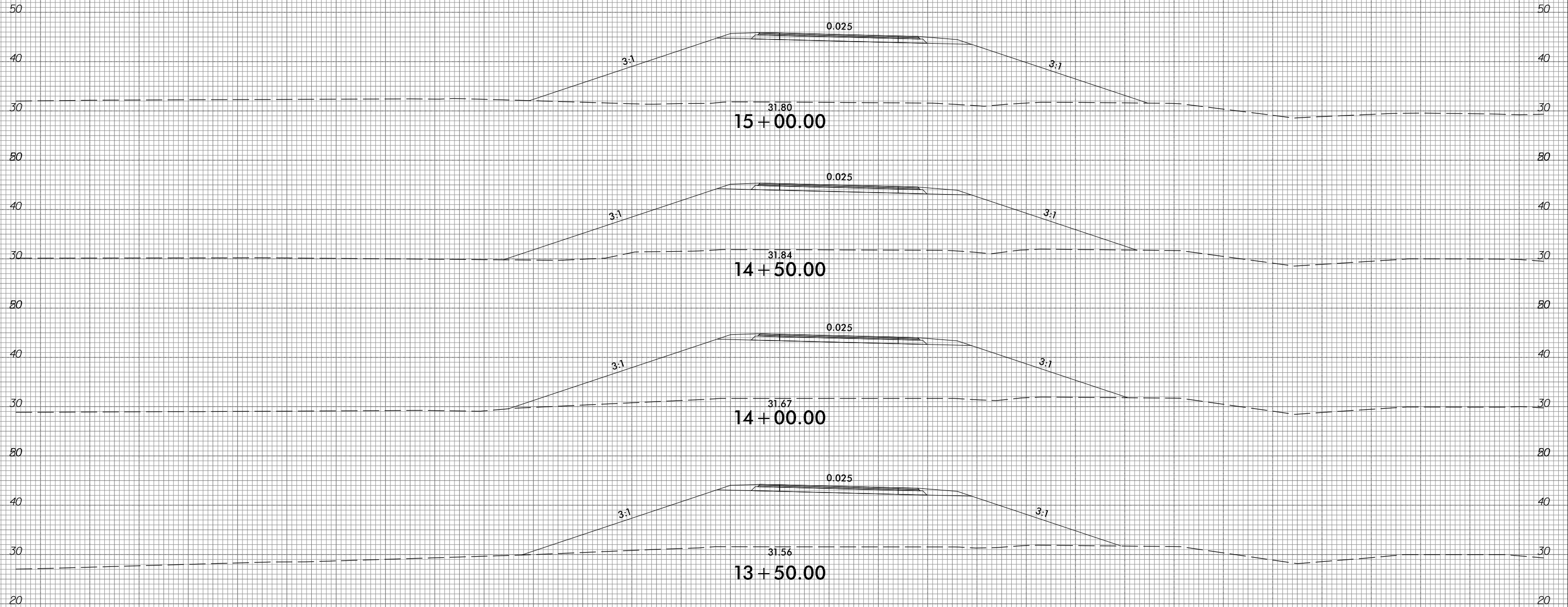

-RP2CD-

150 140 130 120 110 100 90 80 70 60 50 40 30 20 10 0 10 20 30 40 50 60 70 80 90 100 110 120 130 140 150



150 140 130 120 110 100 90 80 70 60 50 40 30 20 10 0 10 20 30 40 50 60 70 80 90 100 110 120 130 140 150

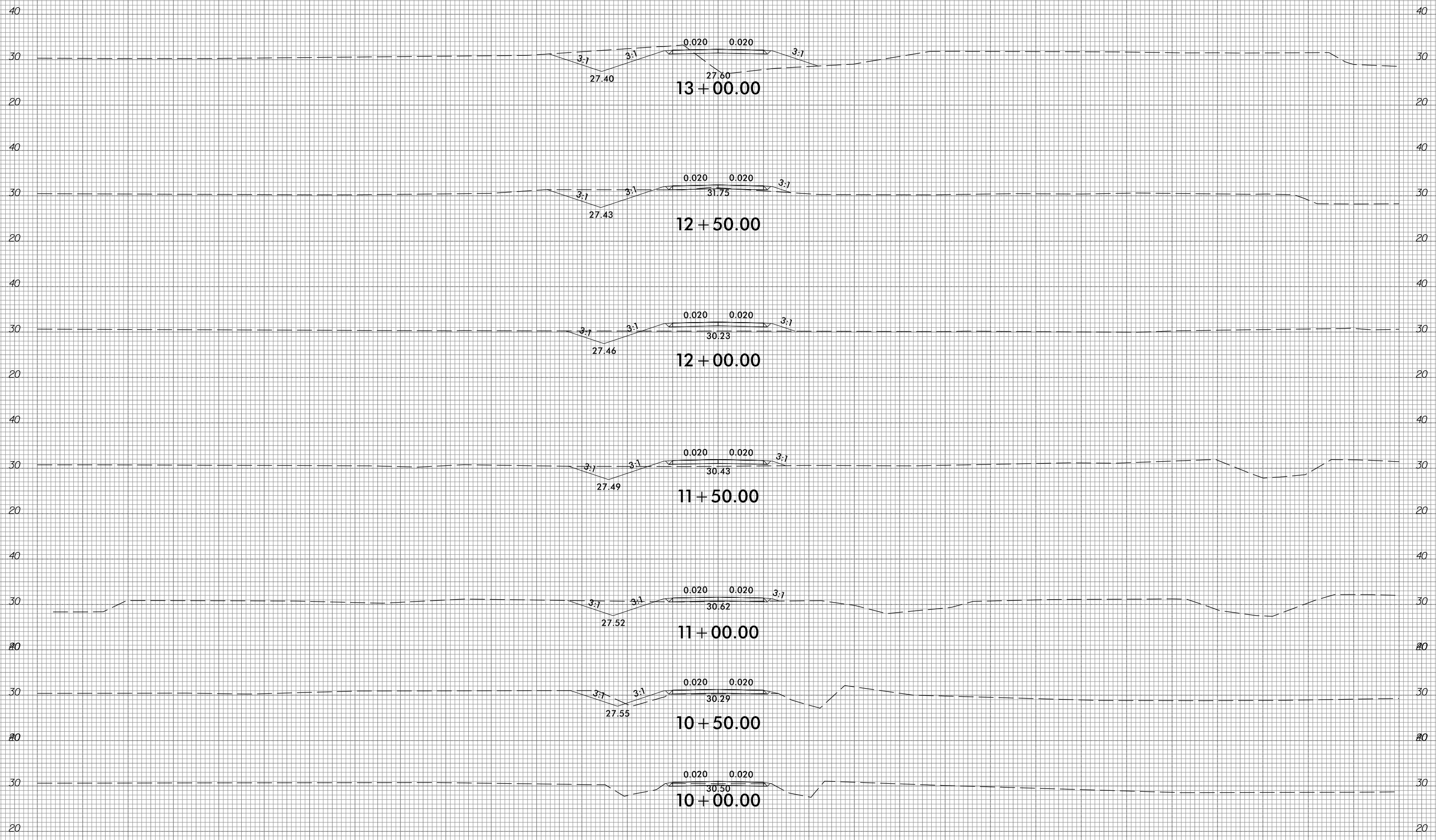

-DRI-

150 140 130 120 110 100 90 80 70 60 50 40 30 20 10 0 10 20 30 40 50 60 70 80 90 100 110 120 130 140 150

6/23/16



PROJ. REFERENCE NO.
R-1015

SHEET NO.
X-420

150 140 130 120 110 100 90 80 70 60 50 40 30 20 10 0 10 20 30 40 50 60 70 80 90 100 110 120 130 140 150

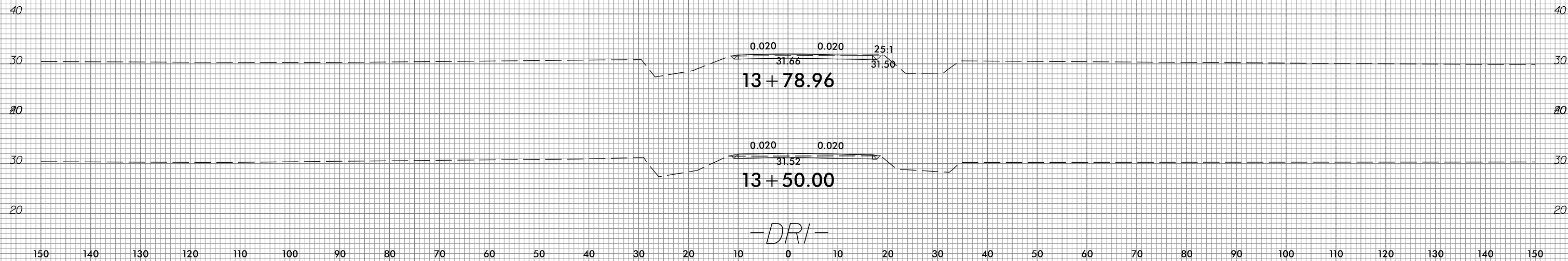

10/31/2018
G:\RA\9729-02\CADD\1015\Roadway\XSC\1015_xp1.DRI.dgn
gncdlin

150 140 130 120 110 100 90 80 70 60 50 40 30 20 10 0 10 20 30 40 50 60 70 80 90 100 110 120 130 140 150

6/23/16



PROJ. REFERENCE NO.
R-1015

SHEET NO.
X-421

150 140 130 120 110 100 90 80 70 60 50 40 30 20 10 0 10 20 30 40 50 60 70 80 90 100 110 120 130 140 150

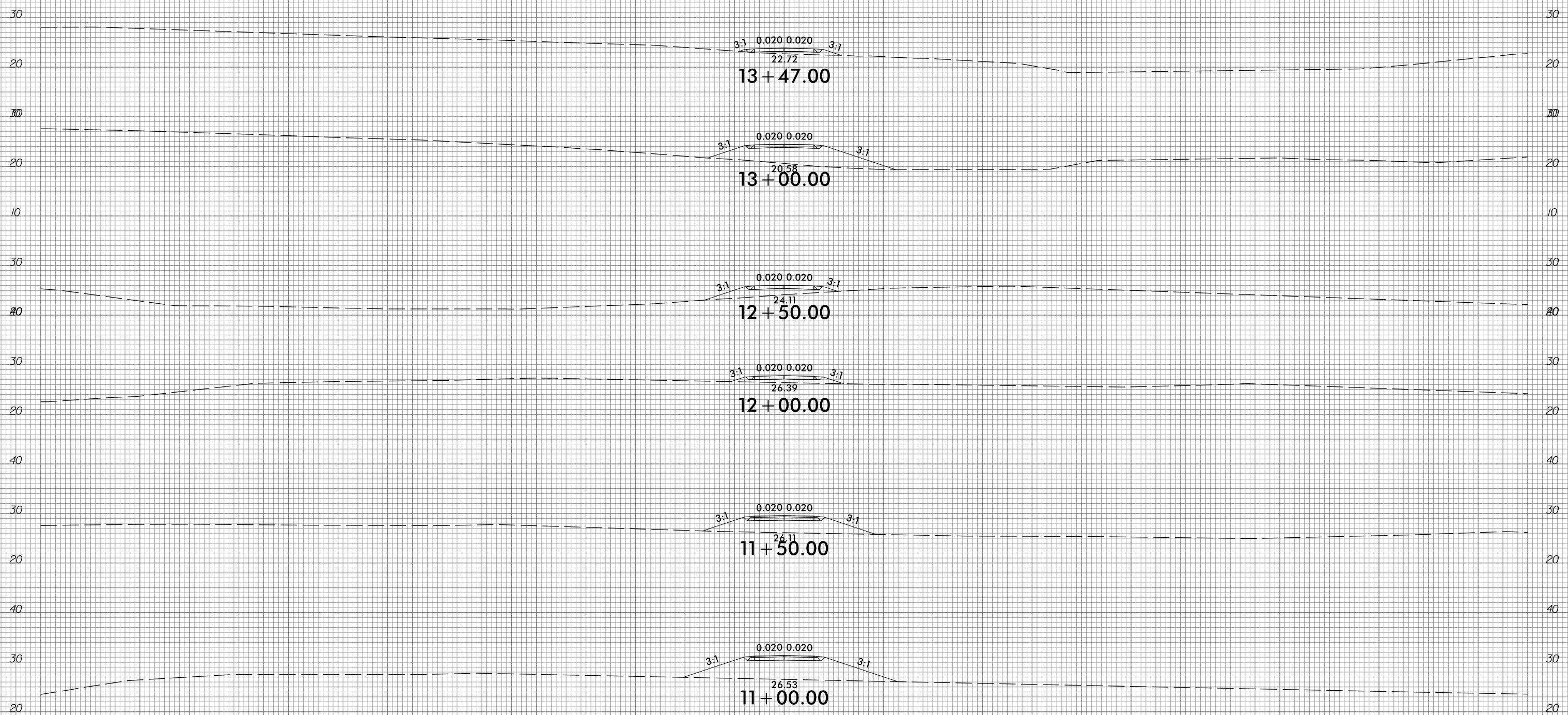

-G/2-

10/31/2018
G:\RA\9729-02\CADD\1015\Roadway\XSC\1015_xp1_G12.dgn
gncdlin

150 140 130 120 110 100 90 80 70 60 50 40 30 20 10 0 10 20 30 40 50 60 70 80 90 100 110 120 130 140 150

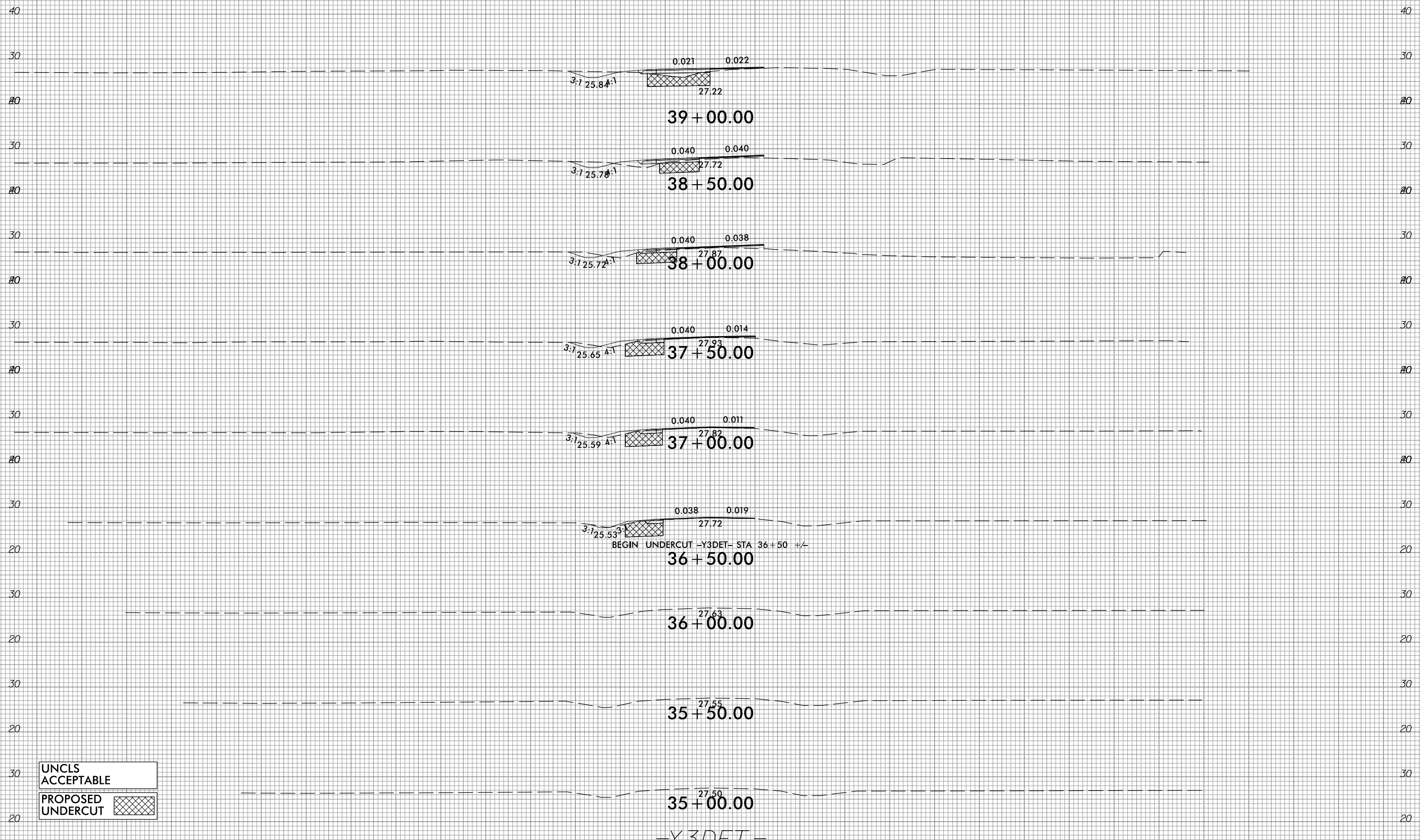

UNCLS
ACCEPTABLE

PROPOSED
UNDERCUT

-Y3DET-

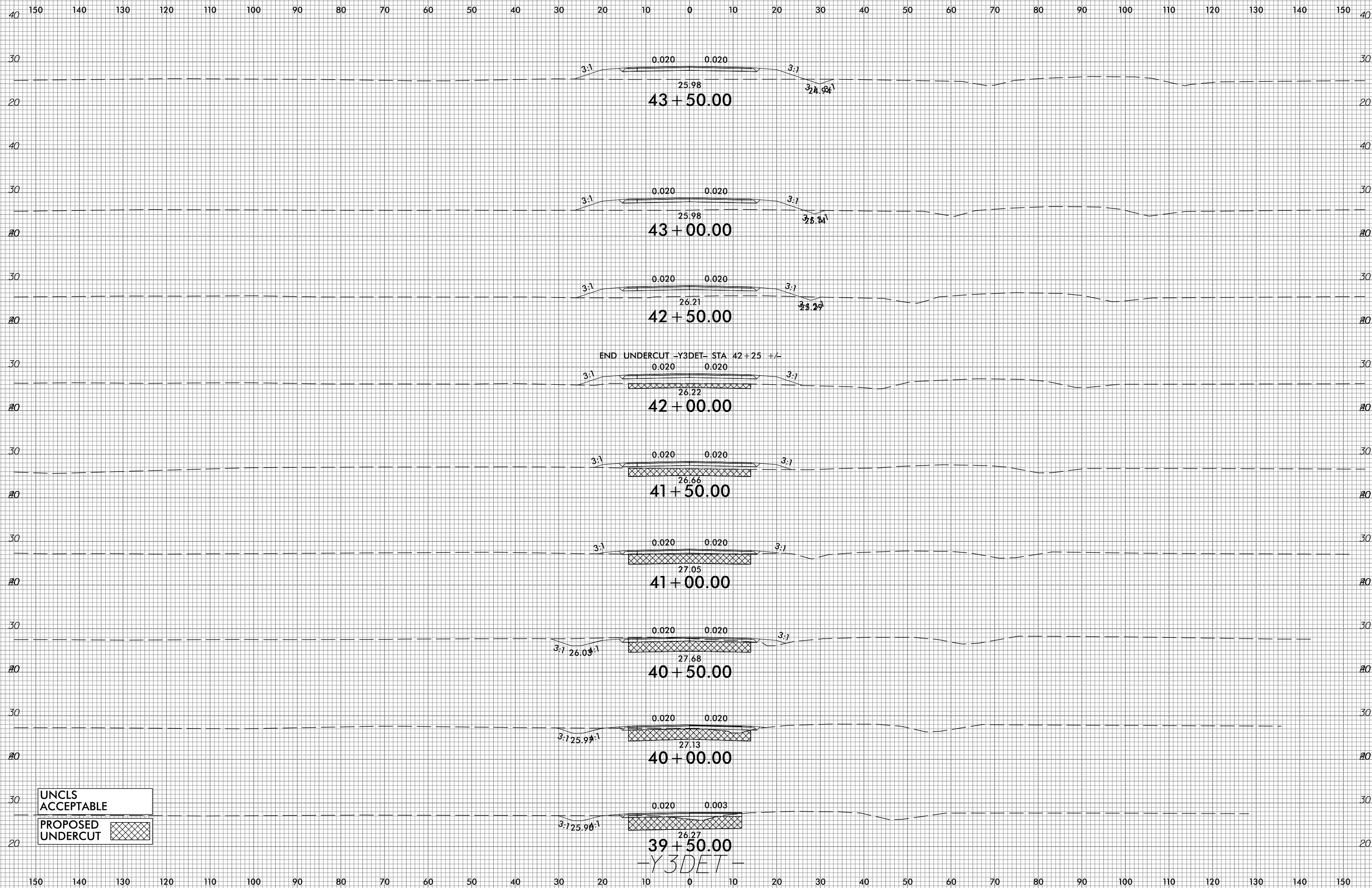

UNCLS
ACCEPTABLE

PROPOSED
UNDERCUT

6/23/16



| | |
|---------------------|--------|
| PROJ. REFERENCE NO. | R-1015 |
|---------------------|--------|

| | |
|-----------|-------|
| SHEET NO. | X-424 |
|-----------|-------|

150 140 130 120 110 100 90 80 70 60 50 40 30 20 10 0 10 20 30 40 50 60 70 80 90 100 110 120 130 140 150

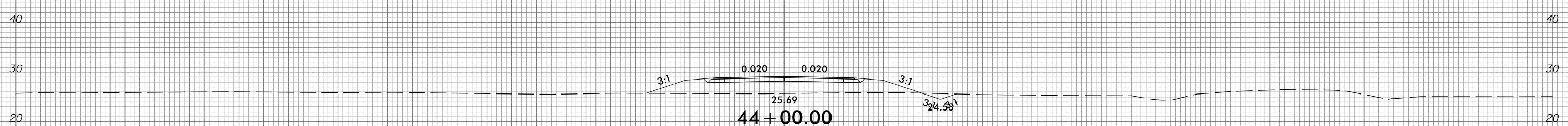
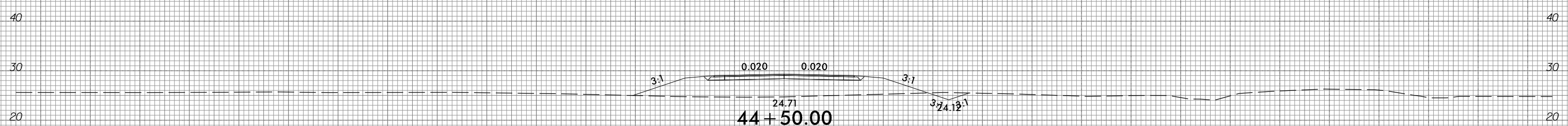
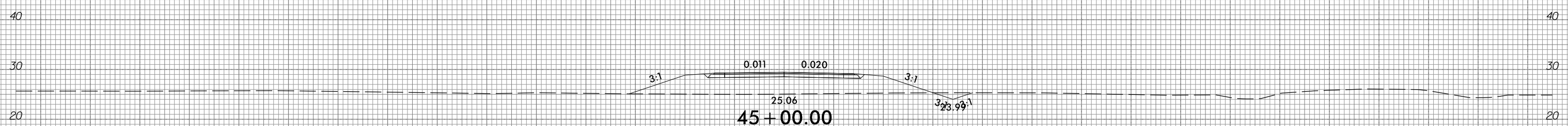
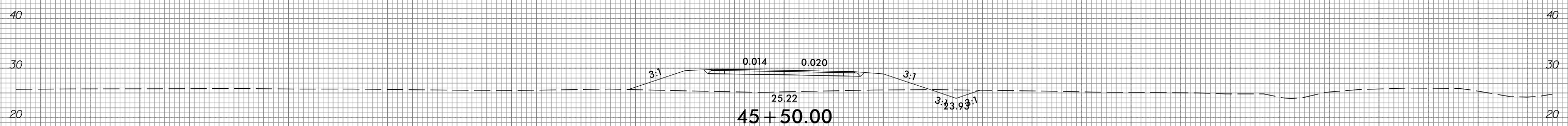
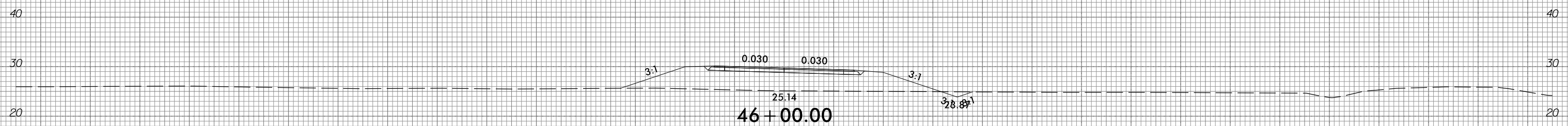
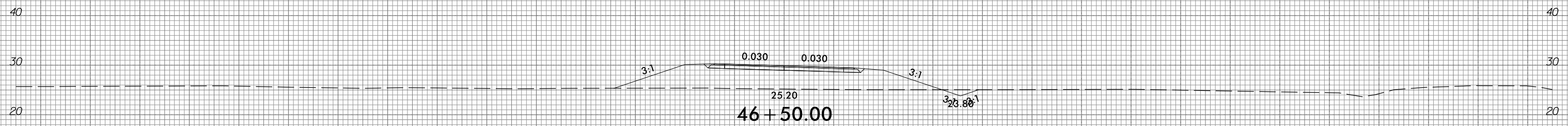

-Y3DET-

150 140 130 120 110 100 90 80 70 60 50 40 30 20 10 0 10 20 30 40 50 60 70 80 90 100 110 120 130 140 150

10/31/2018
 G:\RA\9729-02\CADD\1015\Roadway\XSC\1015_xp1_Y3DET.dgn
 gmc31in

6/23/16



PROJ. REFERENCE NO.
R-1015

SHEET NO.
X-425

150 140 130 120 110 100 90 80 70 60 50 40 30 20 10 0 10 20 30 40 50 60 70 80 90 100 110 120 130 140 150

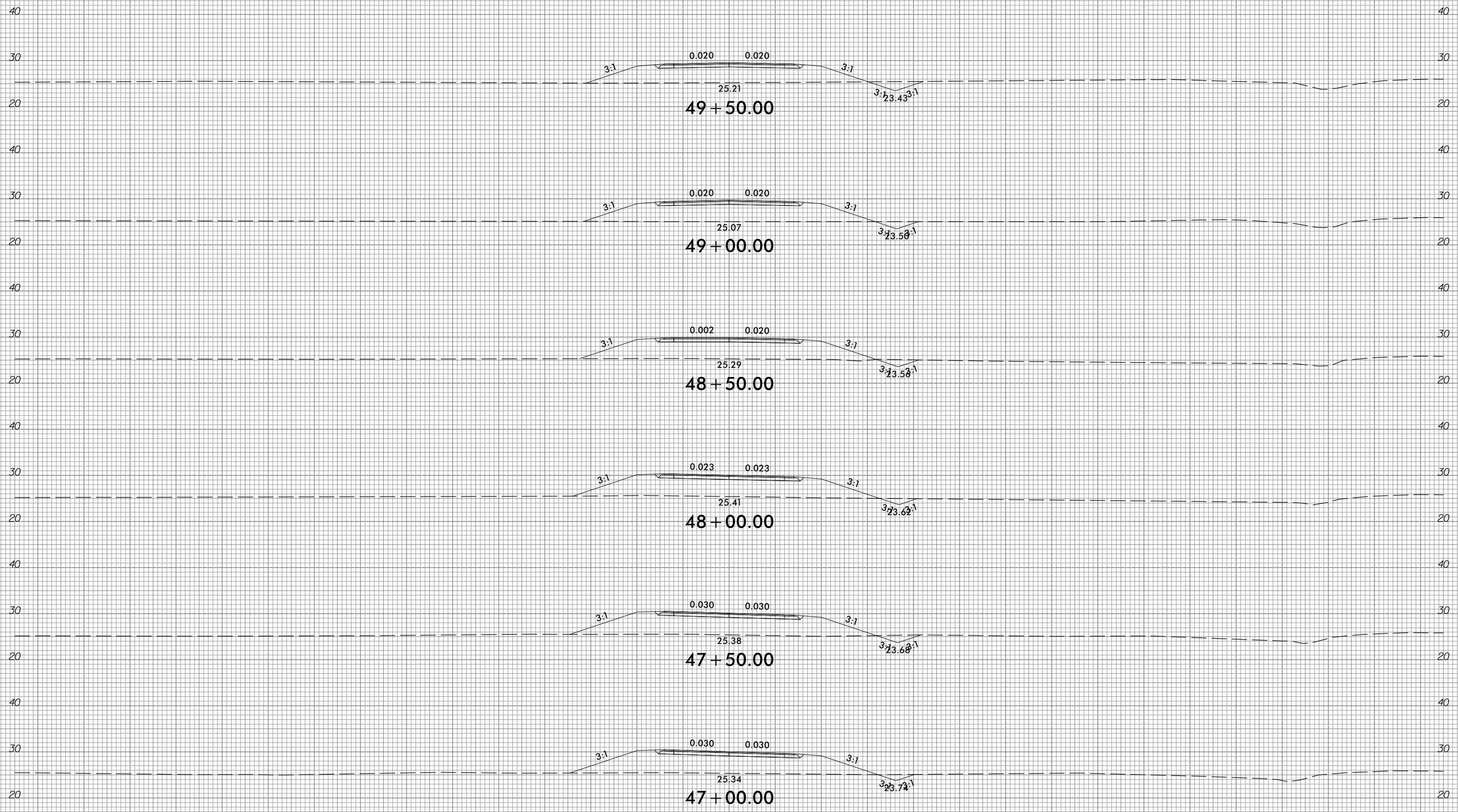

-Y3DET-

150 140 130 120 110 100 90 80 70 60 50 40 30 20 10 0 10 20 30 40 50 60 70 80 90 100 110 120 130 140 150

10/31/2018
G:\RA\9729-02\CADD\1015\Roadway\XSC\1015_xpl.Y3DET.dgn
gncdlin

6/23/16



PROJ. REFERENCE NO.
R-1015

SHEET NO.
X-426

150 140 130 120 110 100 90 80 70 60 50 40 30 20 10 0 10 20 30 40 50 60 70 80 90 100 110 120 130 140 150

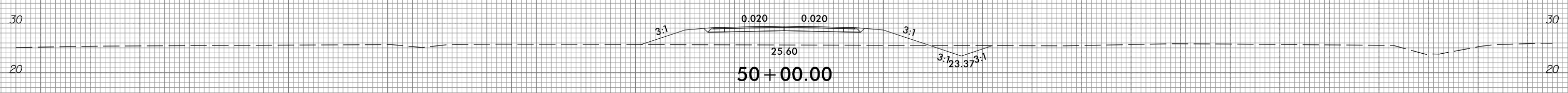
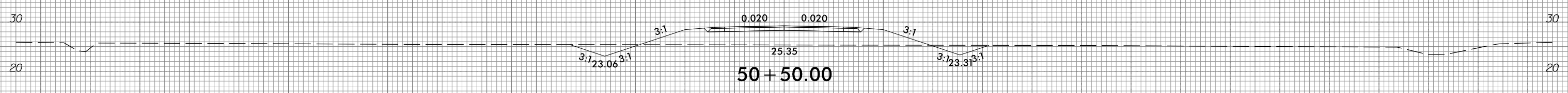
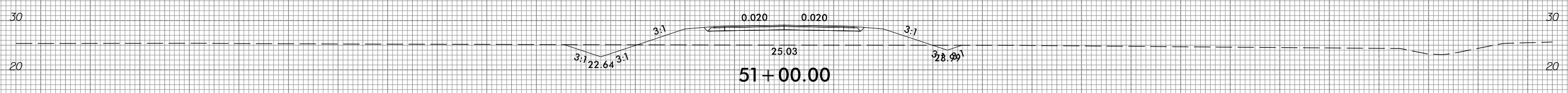
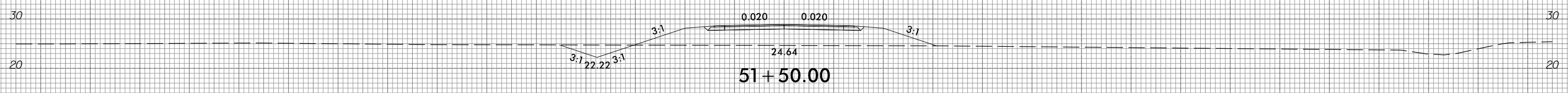
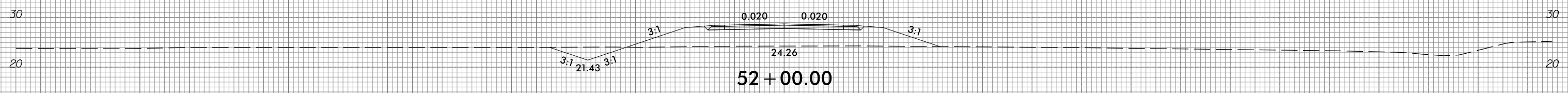
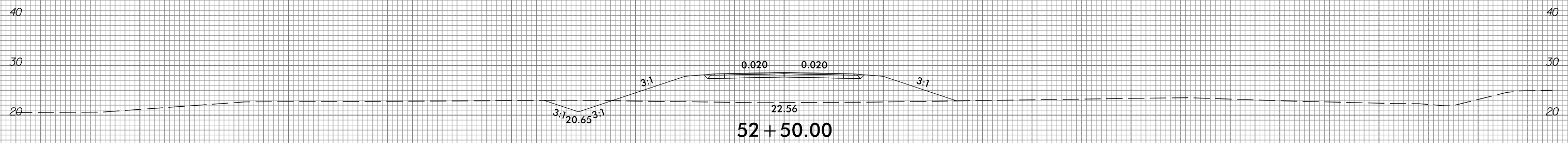

-Y3DET-

150 140 130 120 110 100 90 80 70 60 50 40 30 20 10 0 10 20 30 40 50 60 70 80 90 100 110 120 130 140 150

10/31/2018
G:\RA\9729-02\CADD\1015\Roadway\XSC\1015_xpl.Y3DET.dgn
gncdlin

6/23/16



PROJ. REFERENCE NO.
R-1015

SHEET NO.
X-427

150 140 130 120 110 100 90 80 70 60 50 40 30 20 10 0 10 20 30 40 50 60 70 80 90 100 110 120 130 140 150

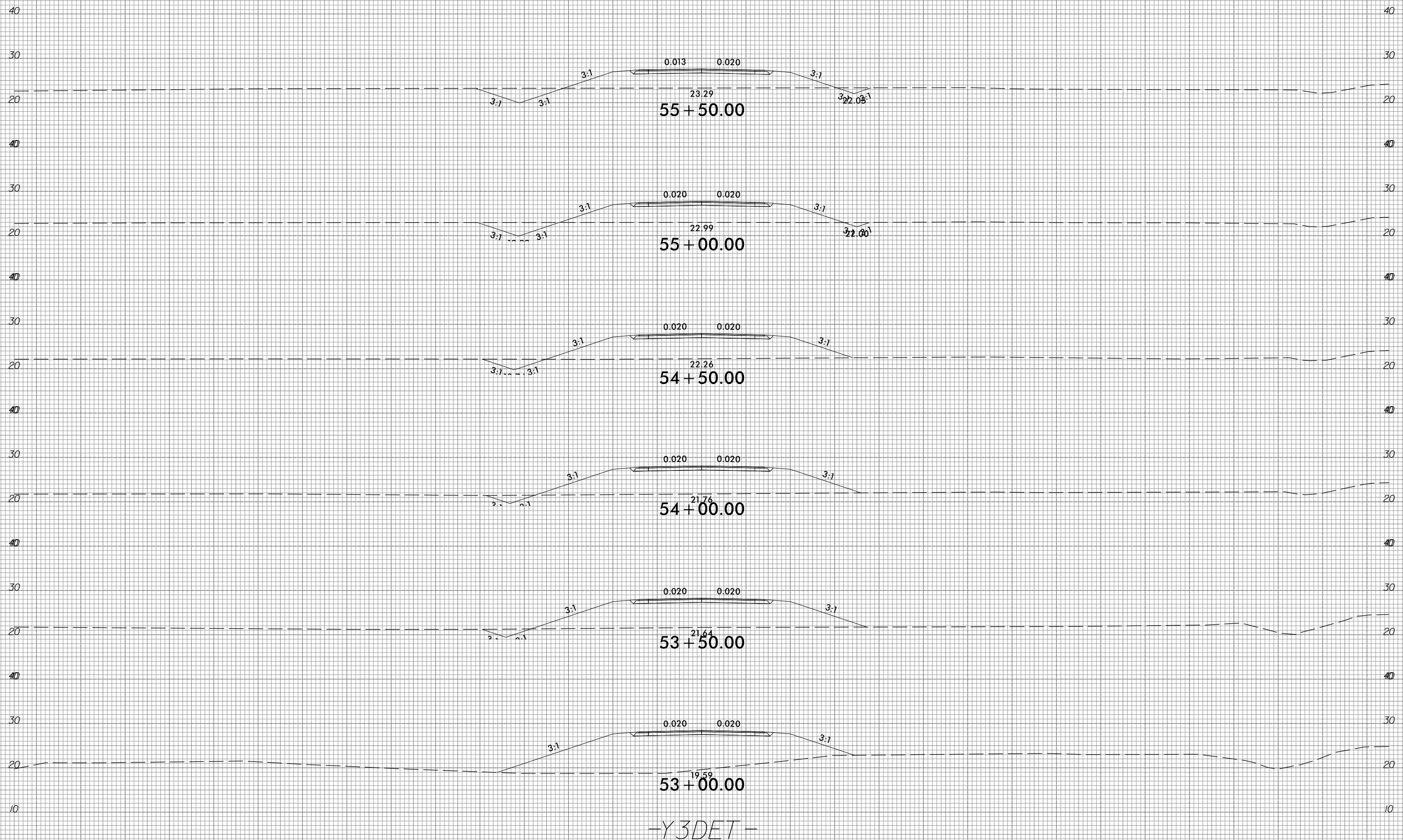

-Y3DET-

10/31/2018
G:\RA\9729-02\CADD\1015\Roadway\XSC\1015_xpl.Y3DET.dgn
gncdlin

6/23/16



PROJ. REFERENCE NO.
R-1015

SHEET NO.
X-428

150 140 130 120 110 100 90 80 70 60 50 40 30 20 10 0 10 20 30 40 50 60 70 80 90 100 110 120 130 140 150

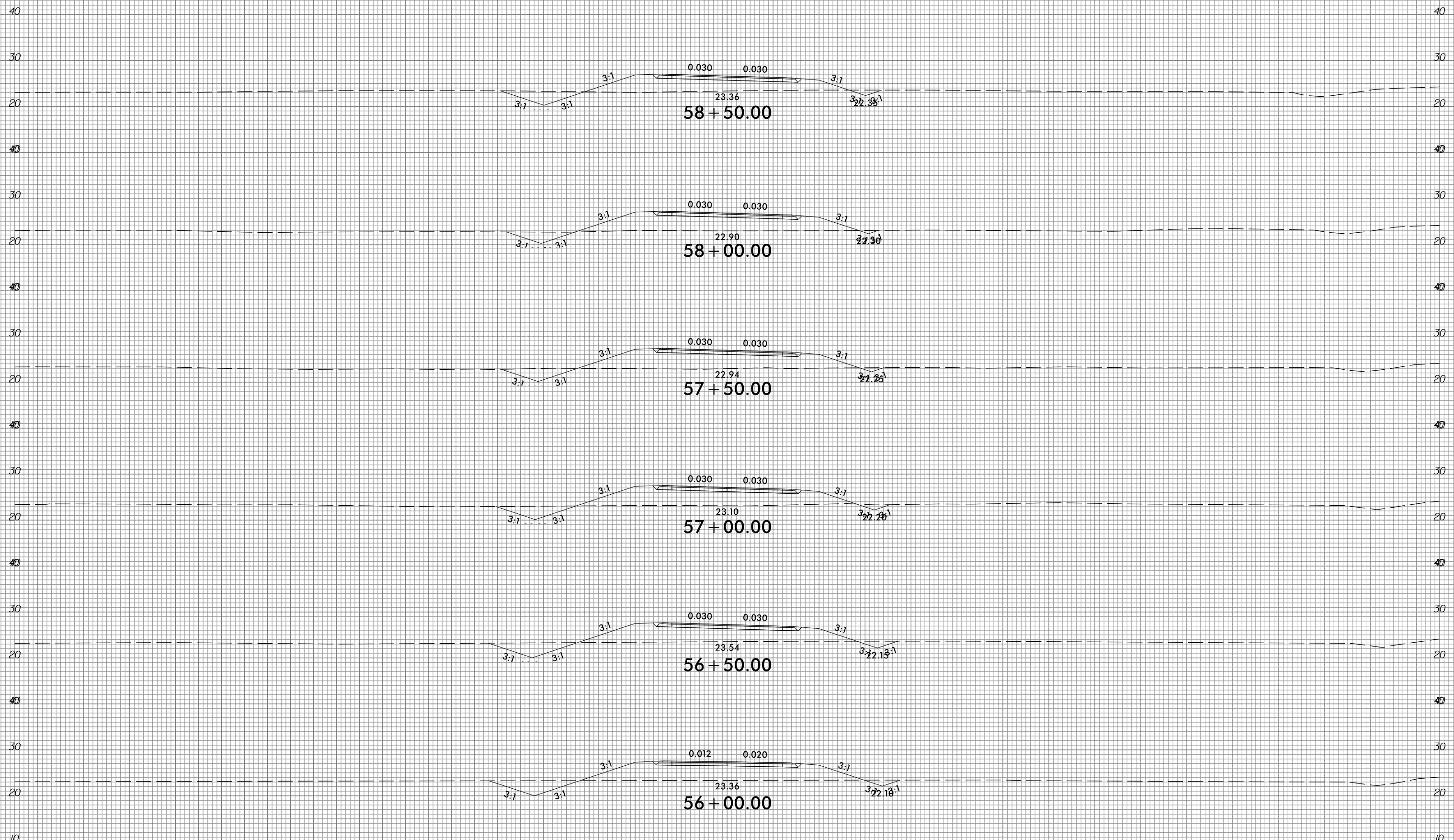

58 + 50.00

58 + 00.00

57 + 50.00

57 + 00.00

56 + 50.00

56 + 00.00

-Y3DET-

10/31/2018
G:\RA\9729-02\CADD\1015\Roadway\XSC\1015_xpl.Y3DET.dgn
gncdlin

6/23/16



PROJ. REFERENCE NO.
R-1015

SHEET NO.
X-429

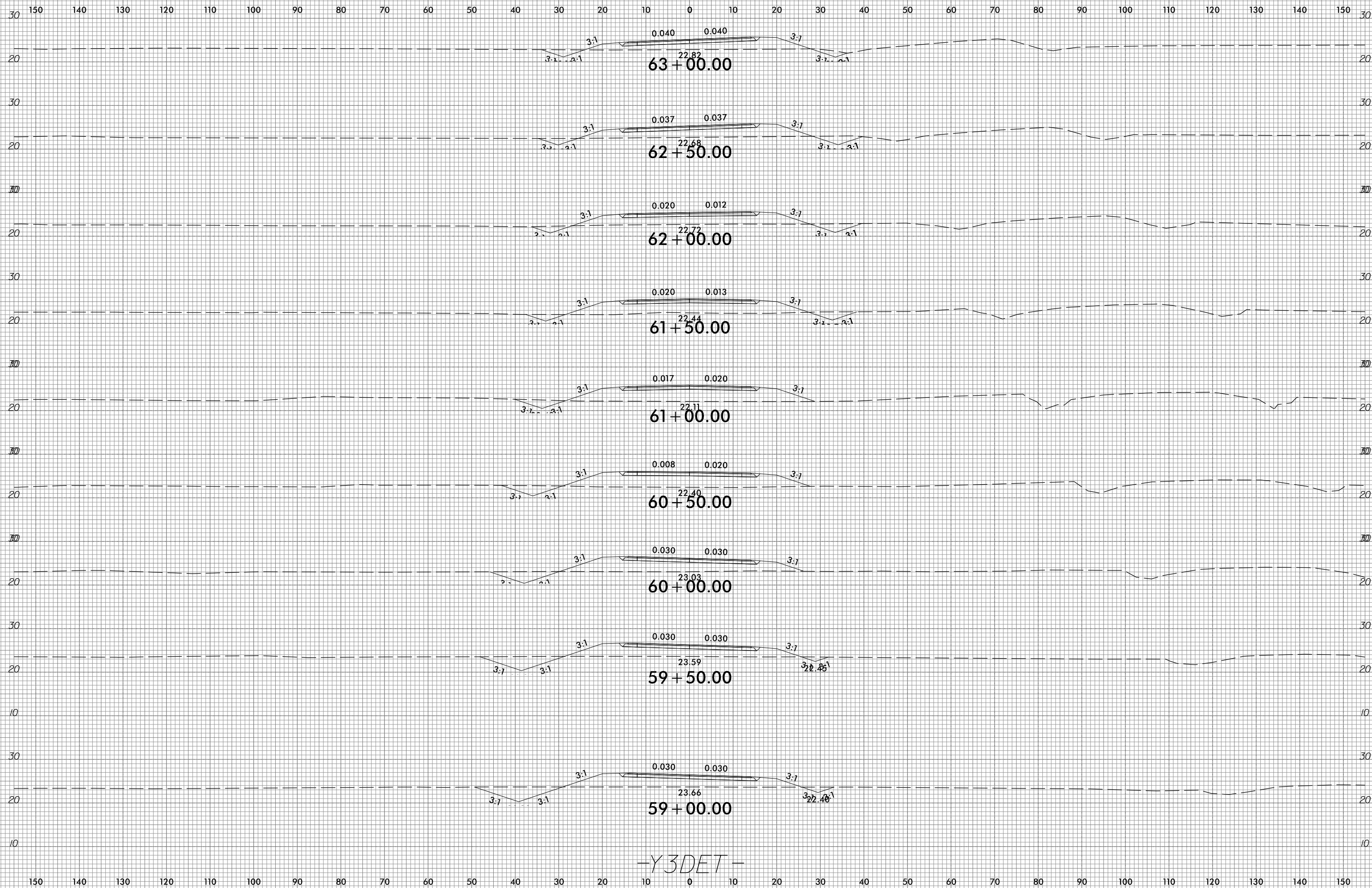

-Y3DET-

10/31/2018
G:\RA\9729-02\CADD\1015\Roadway\XSC\1015_xpl.Y3DET.dgn
gncdlin

6/23/16



PROJ. REFERENCE NO.
R-1015

SHEET NO.
X-430

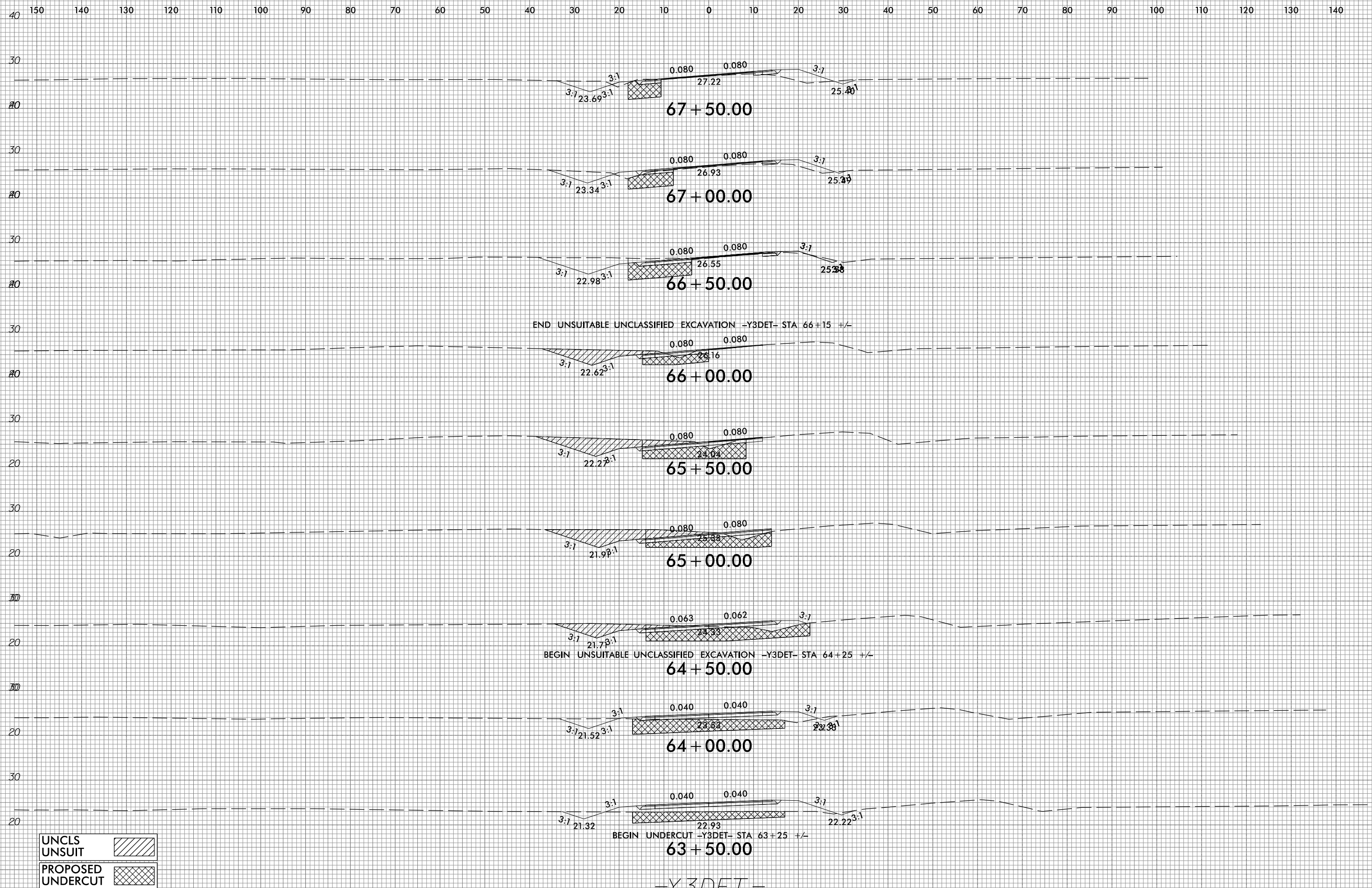

END UNSUITABLE UNCLASSIFIED EXCAVATION -Y3DET- STA 66+15 +/-

BEGIN UNSUITABLE UNCLASSIFIED EXCAVATION -Y3DET- STA 64+25 +/-

BEGIN UNDERCUT -Y3DET- STA 63+25 +/-

-Y3DET-

| | |
|----------------------|--|
| UNCLS UNSUIT | |
| PROPOSED UNDERCUT | |

10/31/2018
G:\RA\9729-02\CADD\1015\Roadway\XSC\1015_xp1_Y3DET.dgn
gmc311

150 140 130 120 110 100 90 80 70 60 50 40 30 20 10 0 10 20 30 40 50 60 70 80 90 100 110 120 130 140 150

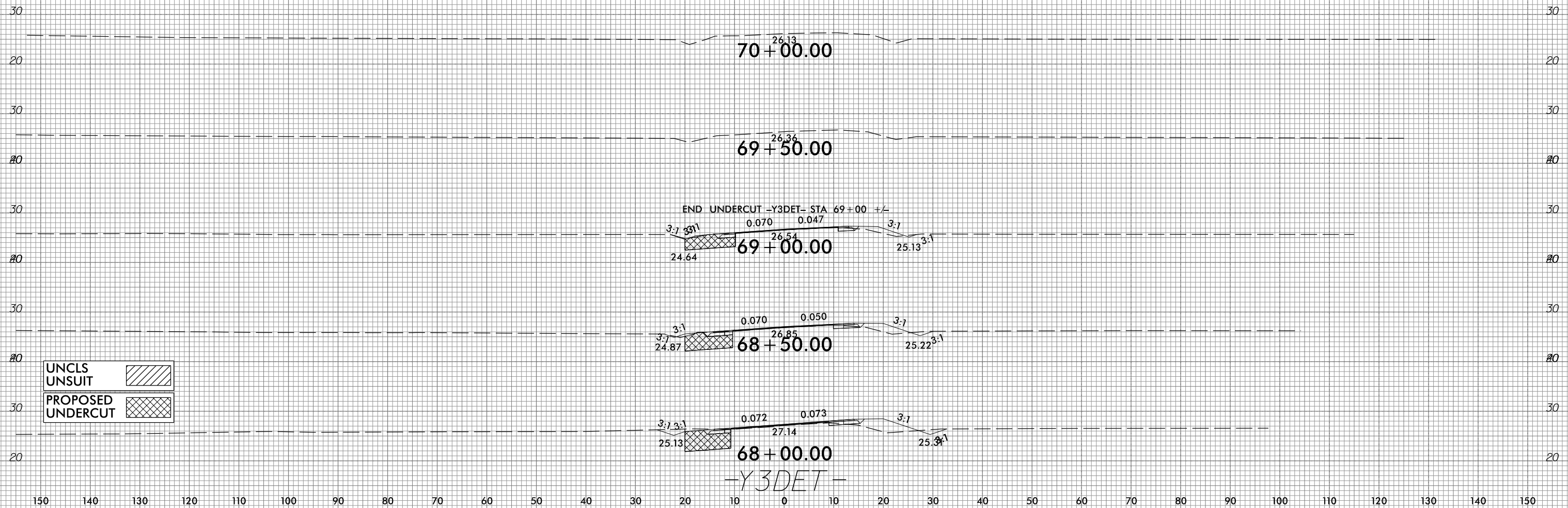

| | |
|-------------------|--|
| UNCLD UNSUIT | |
| PROPOSED UNDERCUT | |

150 140 130 120 110 100 90 80 70 60 50 40 30 20 10 0 10 20 30 40 50 60 70 80 90 100 110 120 130 140 150

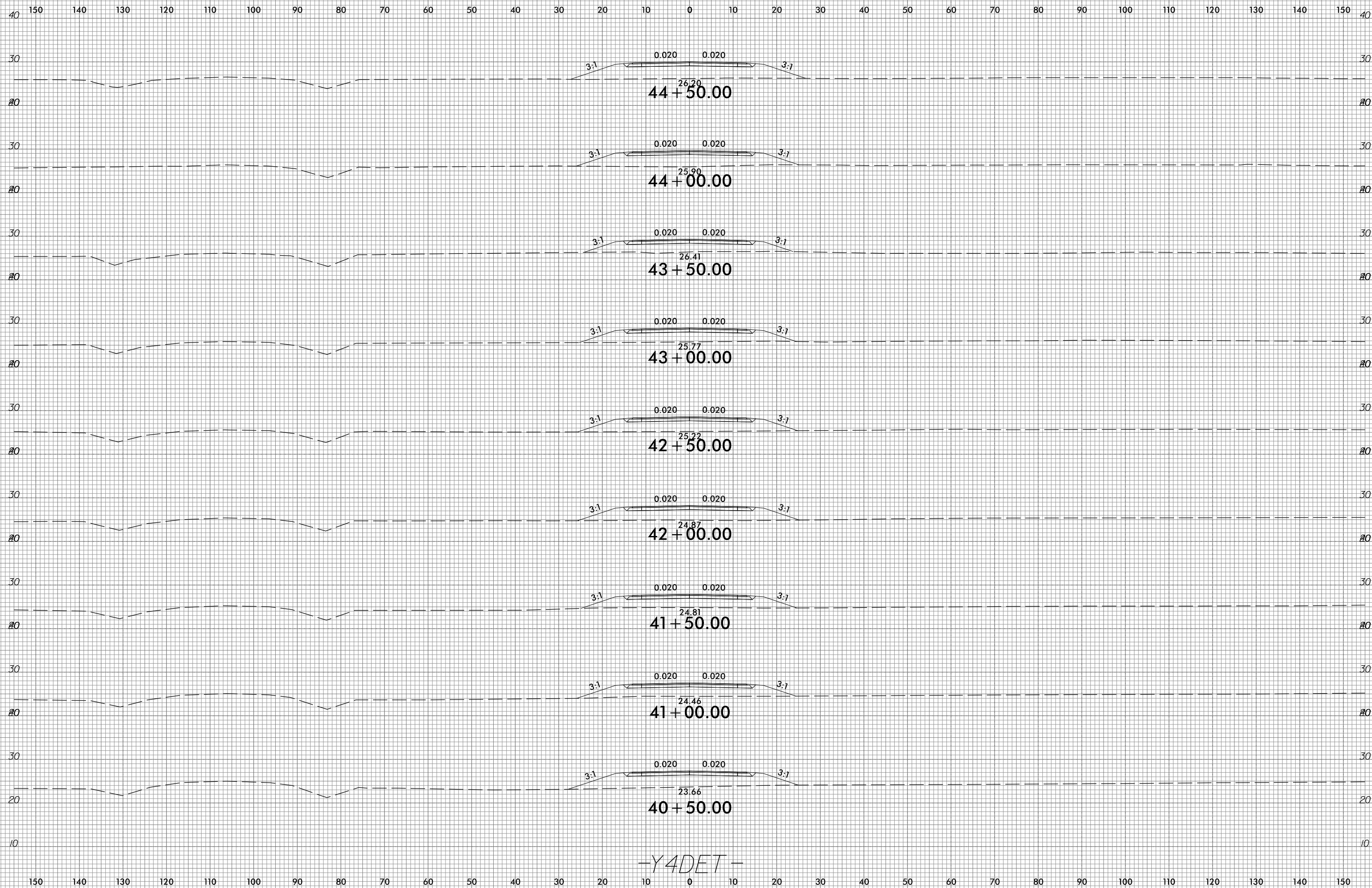

-Y4DET-

