

**This electronic collection of documents is provided  
for the convenience of the user  
and is Not a Certified Document –**

**The documents contained herein were originally issued  
and sealed by the individuals whose names and license  
numbers appear on each page, on the dates appearing  
with their signature on that page.**

**This file or an individual page  
shall not be considered a certified document.**

6/23/16



PROJ. REFERENCE NO.  
R-1015

SHEET NO.  
X-320

150 140 130 120 110 100 90 80 70 60 50 40 30 20 10 0 10 20 30 40 50 60 70 80 90 100 110 120 130 140 150

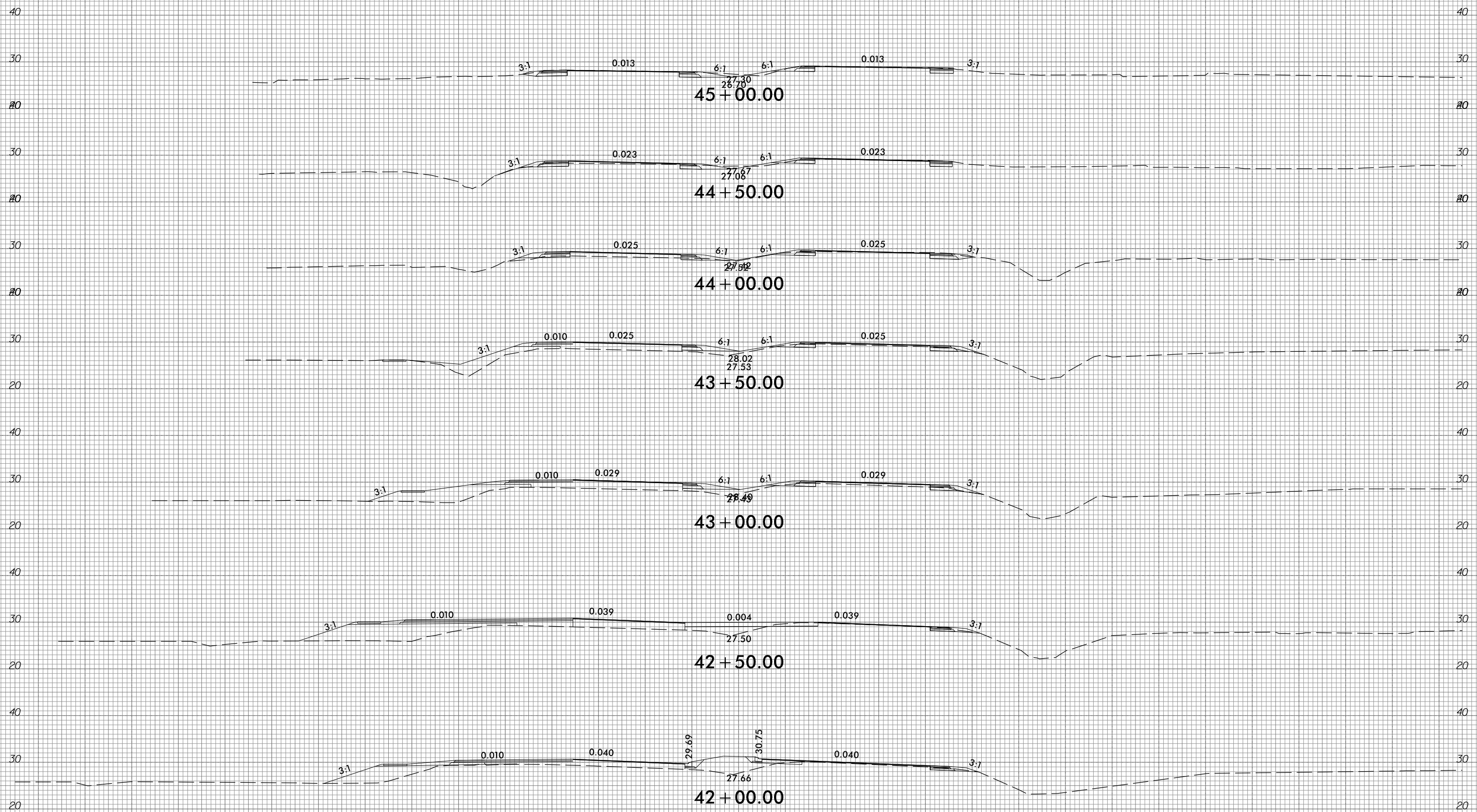

42 + 00.00  
-RPIAB-

150 140 130 120 110 100 90 80 70 60 50 40 30 20 10 0 10 20 30 40 50 60 70 80 90 100 110 120 130 140 150

10/31/2018  
G:\RA\9729-02\CADD\1015\Roadway\XSC\1015\_xp1\_RPIAB.dgn  
gnc311

6/23/16



PROJ. REFERENCE NO.  
R-1015

SHEET NO.  
X-321

150 140 130 120 110 100 90 80 70 60 50 40 30 20 10 0 10 20 30 40 50 60 70 80 90 100 110 120 130 140 150

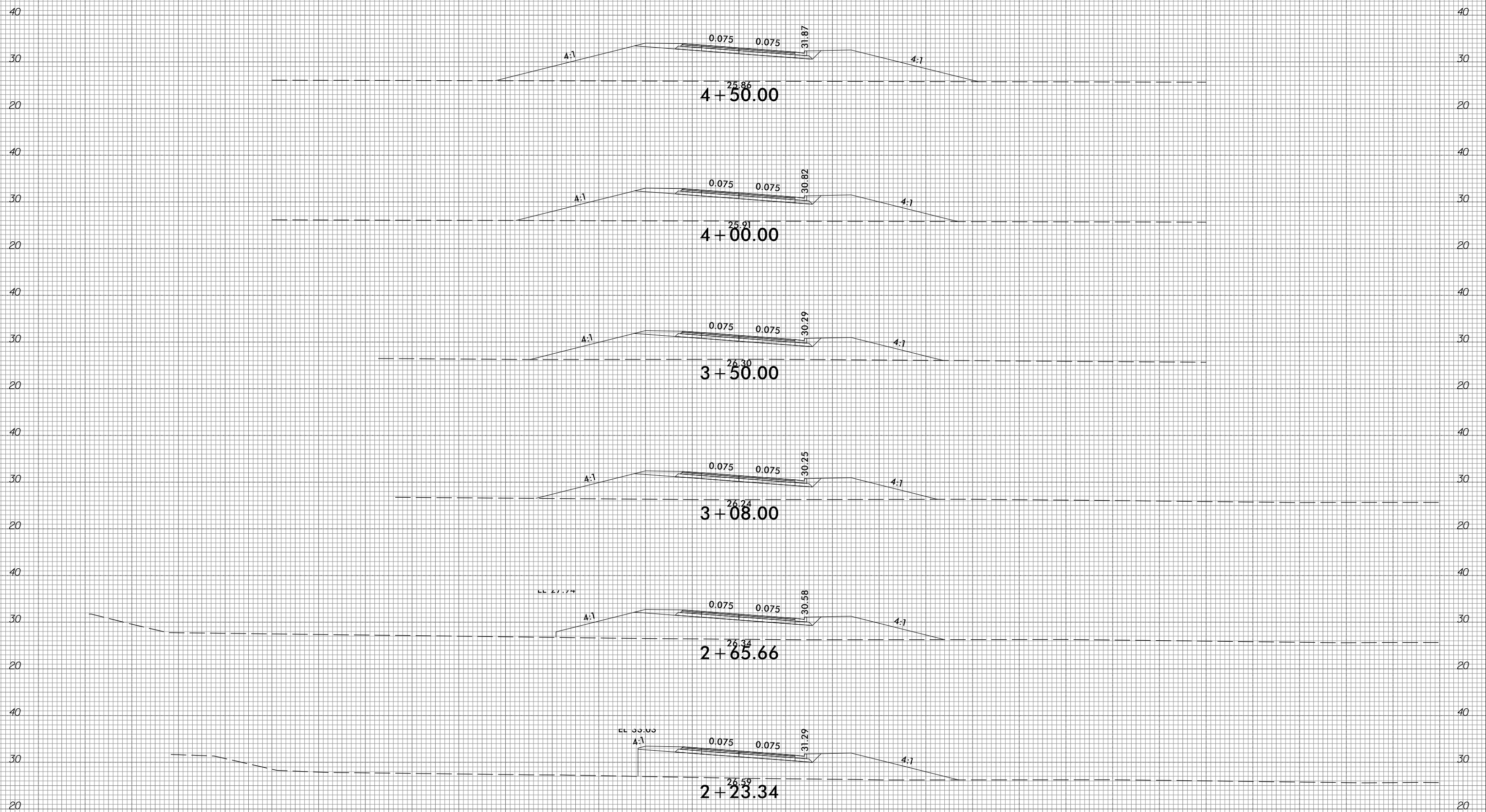

-LP1B-

150 140 130 120 110 100 90 80 70 60 50 40 30 20 10 0 10 20 30 40 50 60 70 80 90 100 110 120 130 140 150

10/31/2018  
G:\RA\1729-02\CADD\1015\Roadway\XSC\1015\_xp1.LP1B.dgn  
gncdlin

6/23/16



PROJ. REFERENCE NO.  
R-1015

SHEET NO.  
X-322

150 140 130 120 110 100 90 80 70 60 50 40 30 20 10 0 10 20 30 40 50 60 70 80 90 100 110 120 130 140 150

50

50

END UNDERCUT -LP1B- STA 7+25 +/-

0.075 0.075

38.99

4:1

4:1

30

30

20

20

6 + 50.00

25.80

0.075 0.075

37.14

4:1

4:1

40

40

30

30

20

20

6 + 00.00

25.33

0.075 0.075

35.29

4:1

4:1

40

40

30

30

20

20

5 + 50.00

25.82

0.075 0.075

33.44

4:1

4:1

40

40

30

30

20

20

BEGIN UNDERCUT -LP1B- STA 4+90 +/-

-LP1B- 5 + 00.00

25.77

PROPOSED UNDERCUT

150 140 130 120 110 100 90 80 70 60 50 40 30 20 10 0 10 20 30 40 50 60 70 80 90 100 110 120 130 140 150

10/31/2016  
G:\RA\9729-02\CADD\1015\Roadway\XSC\1015\_xp1.LP1B.dgn  
gmodlin

6/23/16



PROJ. REFERENCE NO.  
R-1015

SHEET NO.  
X-323

50 150 140 130 120 110 100 90 80 70 60 50 40 30 20 10 0 10 20 30 40 50 60 70 80 90 100 110 120 130 140 150 50

-L- STA 81+50.00  
EL 34.46

5.92:1

0.030

3:1

3:1

5 + 50.67

EL 35.10

8.44:1

0.016

3:1

3:1

4 + 99.33

EL 35.01

0.002

3:1

3:1

4 + 48.39

EL 35.41

0.013

3:1

3:1

3 + 97.30

0.025

3:1

3:1

3 + 46.35

0.025

3:1

3:1

2 + 95.59

-RPICD-

150 140 130 120 110 100 90 80 70 60 50 40 30 20 10 0 10 20 30 40 50 60 70 80 90 100 110 120 130 140 150

10/31/2016  
G:\RA\9729-02\CADD\1015\Roadway\XSC\1015\_xp1\_RPICD.dgn  
gncdlin

6/23/16



PROJ. REFERENCE NO.  
R-1015

SHEET NO.  
X-324

150 140 130 120 110 100 90 80 70 60 50 40 30 20 10 0 10 20 30 40 50 60 70 80 90 100 110 120 130 140 150

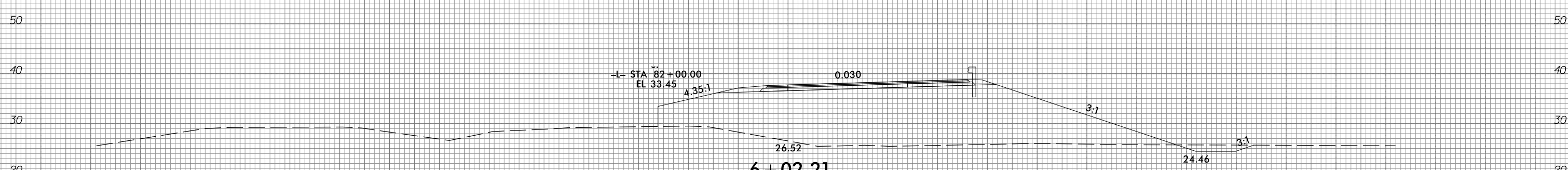
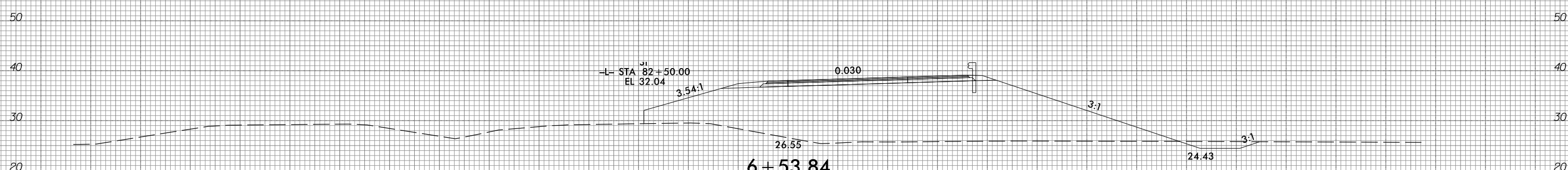
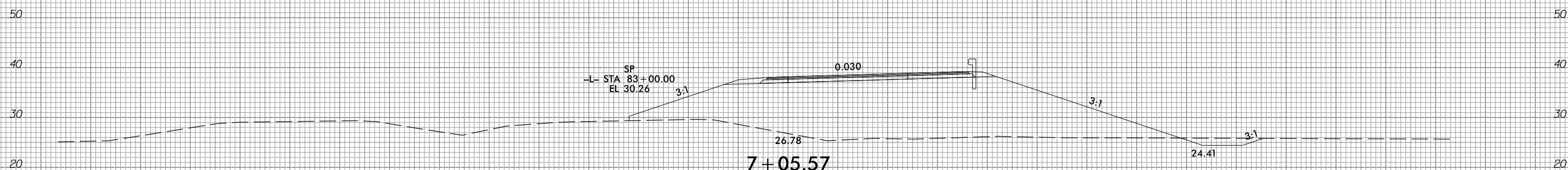
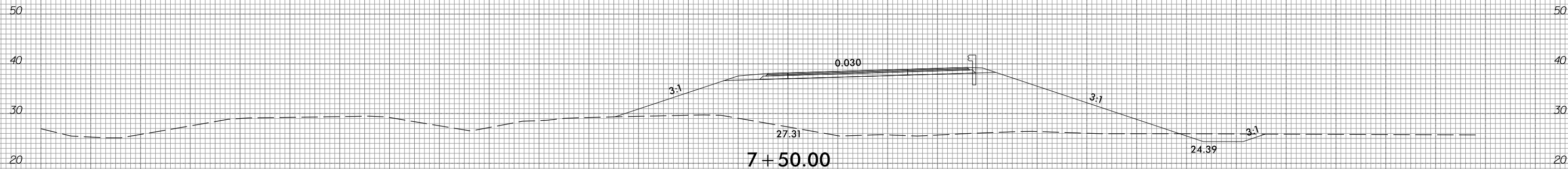

-RPICD-

150 140 130 120 110 100 90 80 70 60 50 40 30 20 10 0 10 20 30 40 50 60 70 80 90 100 110 120 130 140 150

10/31/2018  
G:\RA\9729-02\CADD\1015\Roadway\XSC\1015\_xp1\_RPICD.dgn  
gncdlin

6/23/16



PROJ. REFERENCE NO.  
R-1015

SHEET NO.  
X-325

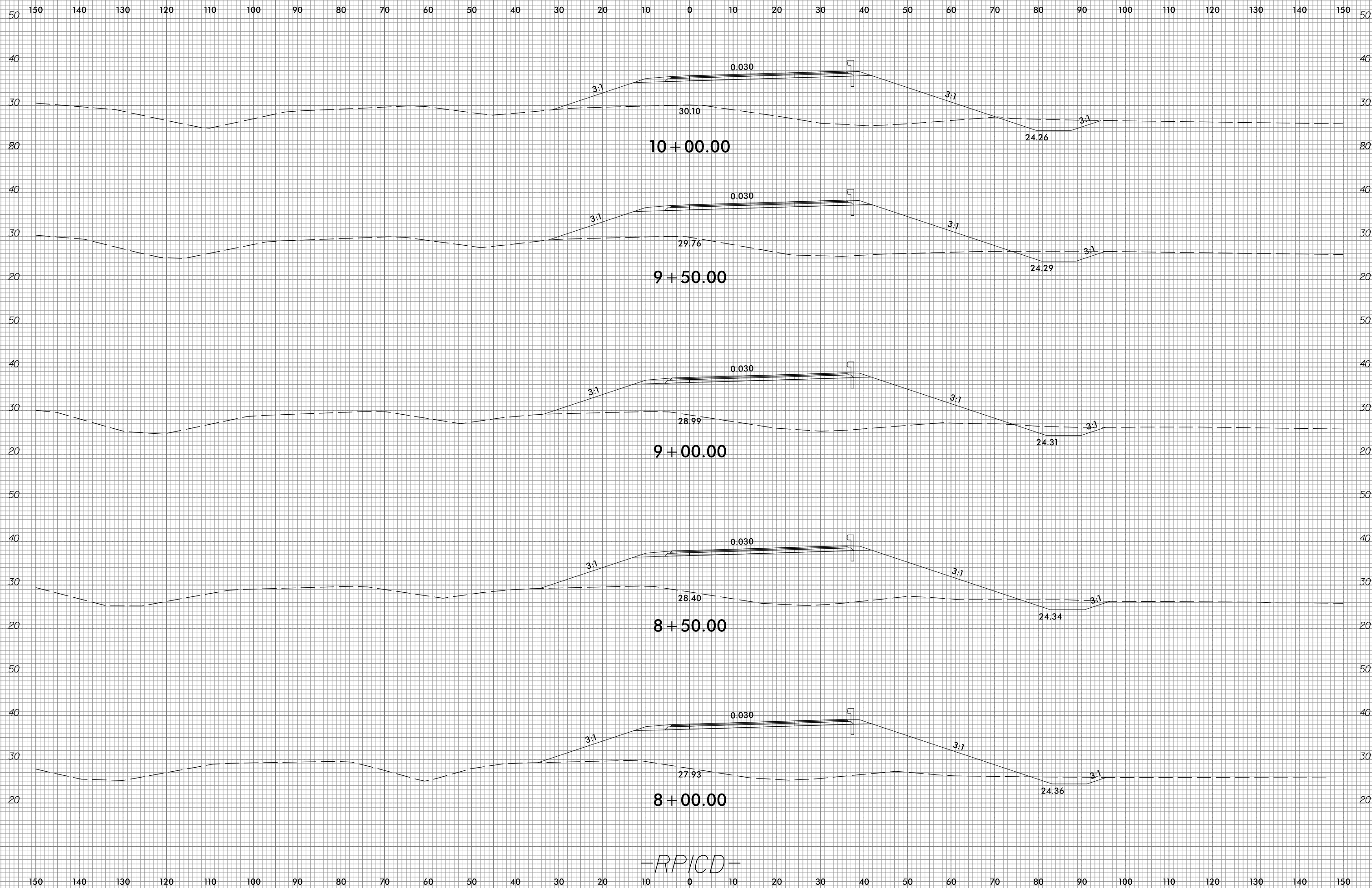

-RPICD-

10/31/2018  
G:\RA\9729-02\CADD\1015\Roadway\XSC\1015\_xp1\_RPICD.dgn  
gmc311

150 140 130 120 110 100 90 80 70 60 50 40 30 20 10 0 10 20 30 40 50 60 70 80 90 100 110 120 130 140 150

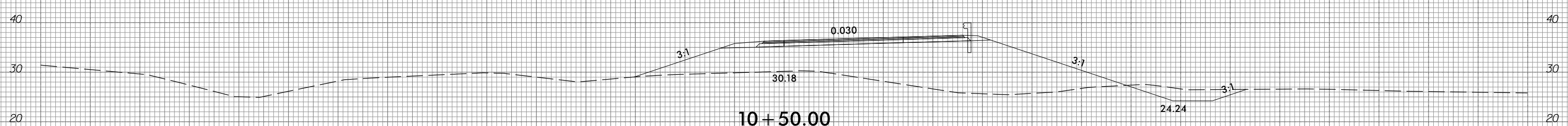
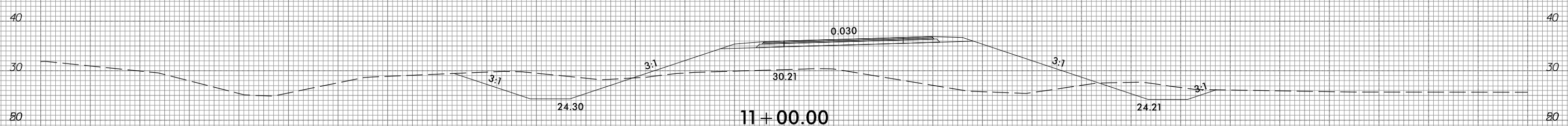
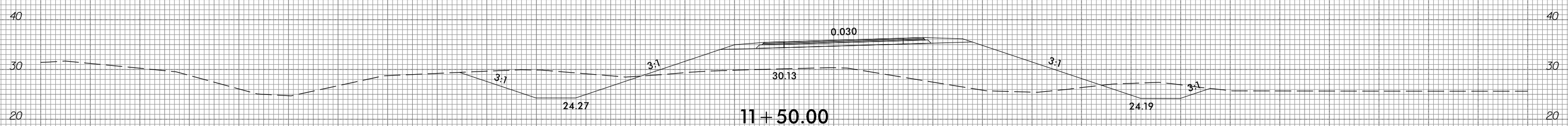
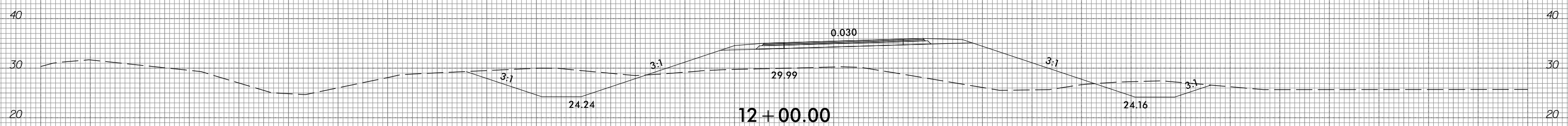
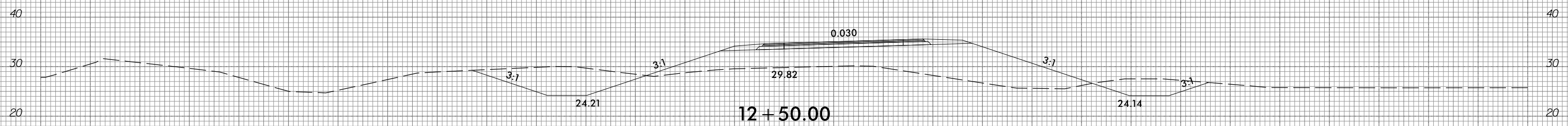
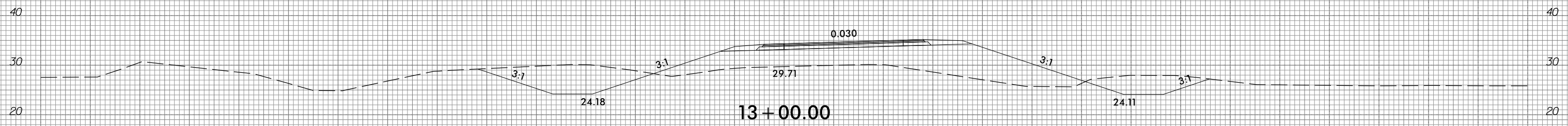

-RPICD-

150 140 130 120 110 100 90 80 70 60 50 40 30 20 10 0 10 20 30 40 50 60 70 80 90 100 110 120 130 140 150



150 140 130 120 110 100 90 80 70 60 50 40 30 20 10 0 10 20 30 40 50 60 70 80 90 100 110 120 130 140 150

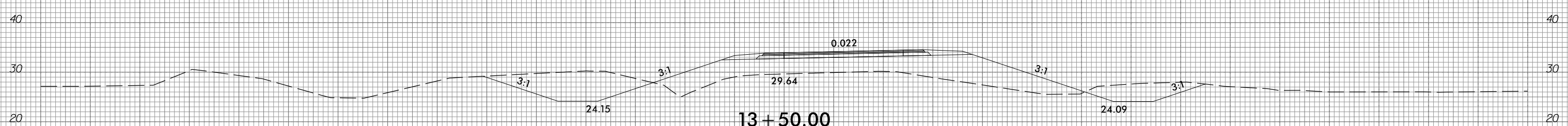
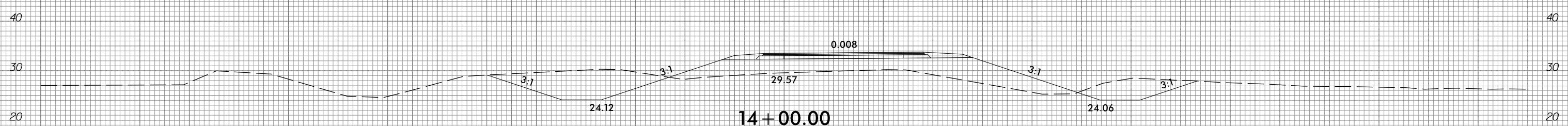
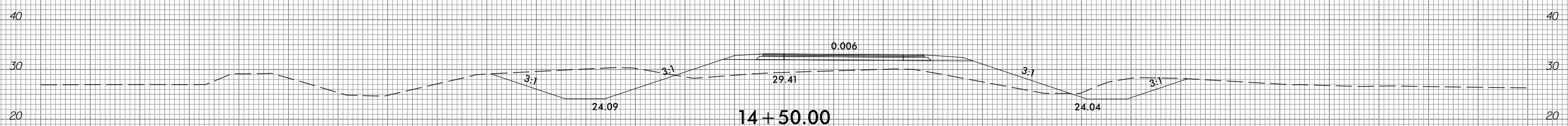
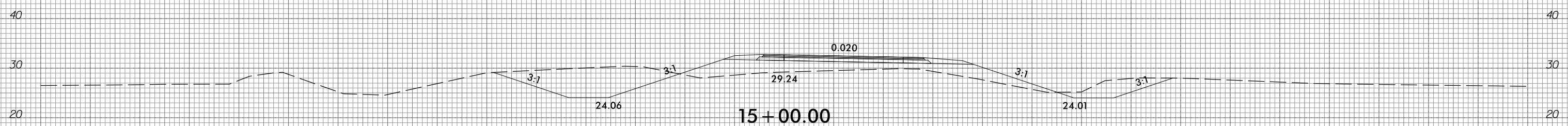
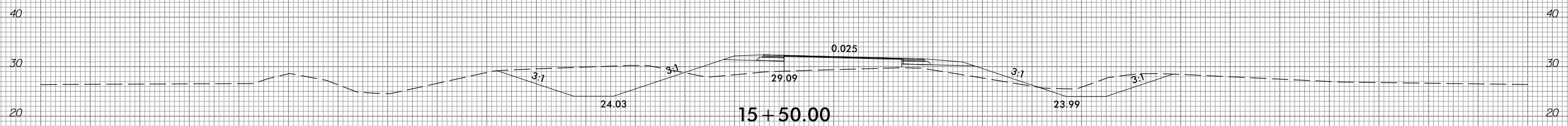
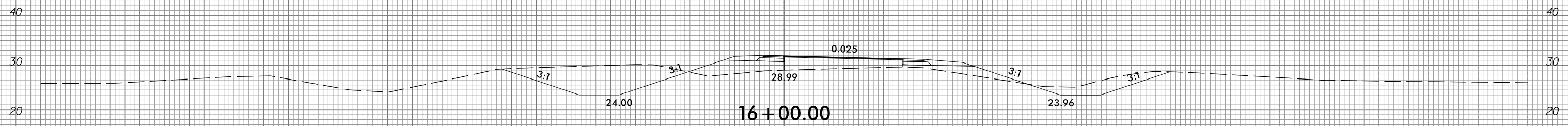

-RPICD-

150 140 130 120 110 100 90 80 70 60 50 40 30 20 10 0 10 20 30 40 50 60 70 80 90 100 110 120 130 140 150



150 140 130 120 110 100 90 80 70 60 50 40 30 20 10 0 10 20 30 40 50 60 70 80 90 100 110 120 130 140 150

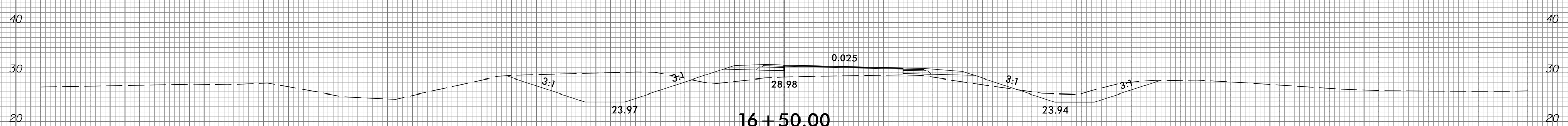
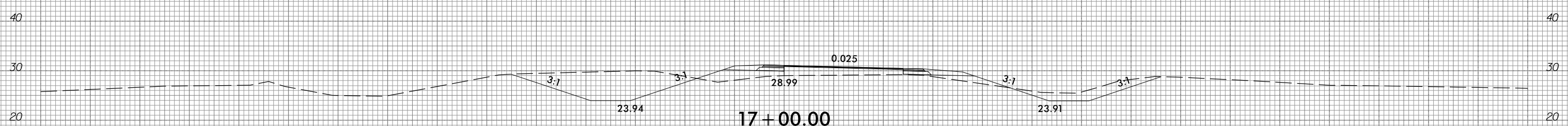
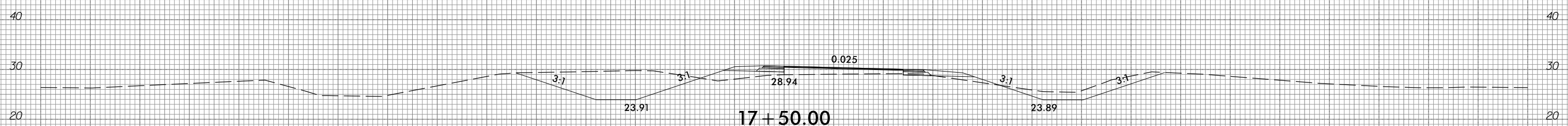
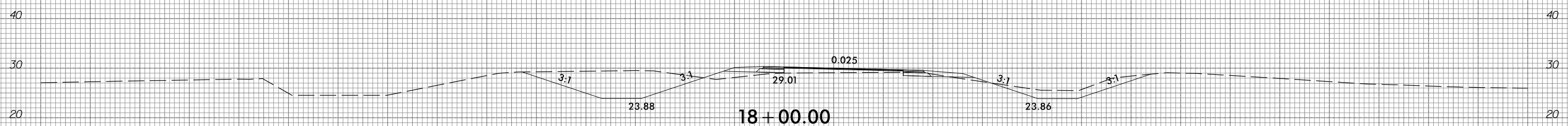
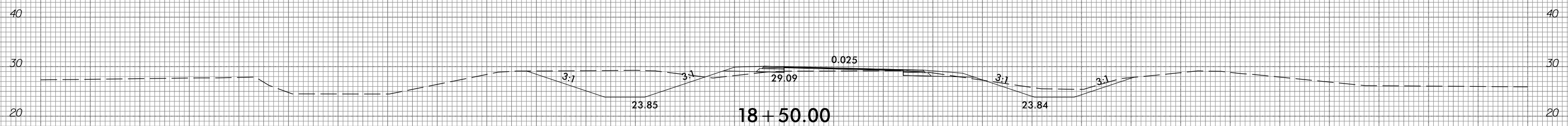
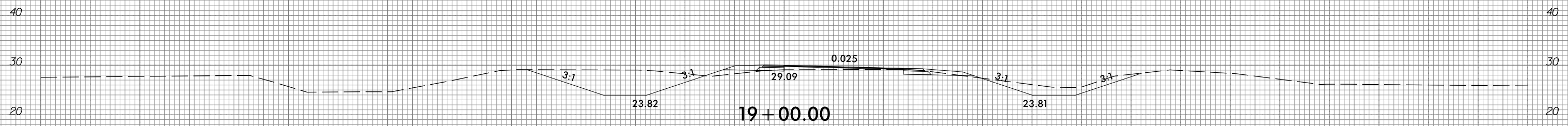

-RPICD-

150 140 130 120 110 100 90 80 70 60 50 40 30 20 10 0 10 20 30 40 50 60 70 80 90 100 110 120 130 140 150



150 140 130 120 110 100 90 80 70 60 50 40 30 20 10 0 10 20 30 40 50 60 70 80 90 100 110 120 130 140 150

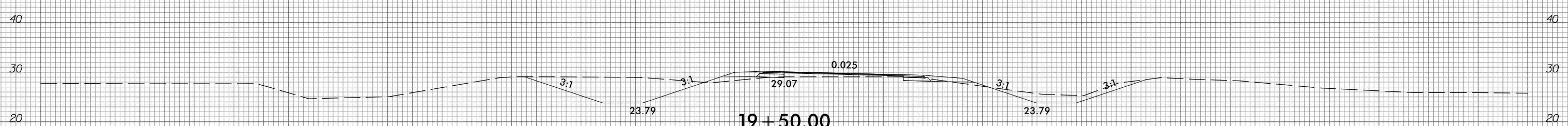
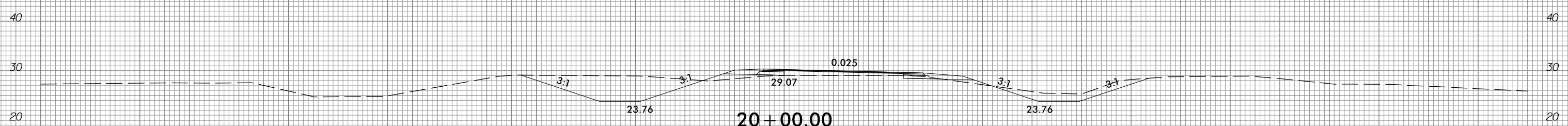
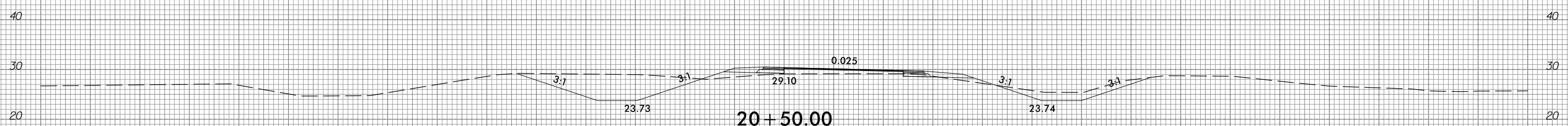
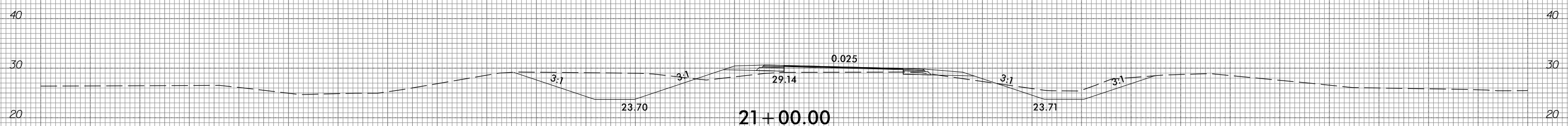
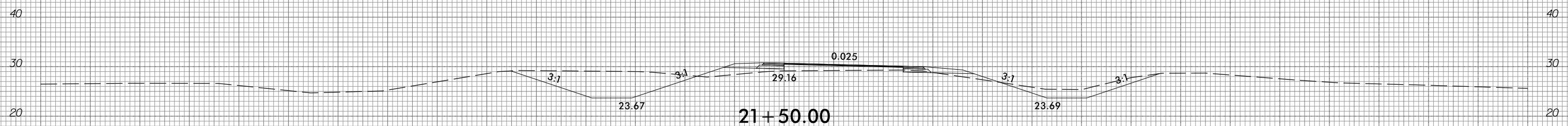
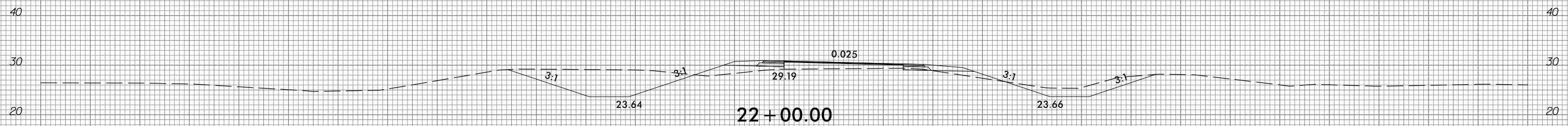

-RPICD-

150 140 130 120 110 100 90 80 70 60 50 40 30 20 10 0 10 20 30 40 50 60 70 80 90 100 110 120 130 140 150



150 140 130 120 110 100 90 80 70 60 50 40 30 20 10 0 10 20 30 40 50 60 70 80 90 100 110 120 130 140 150

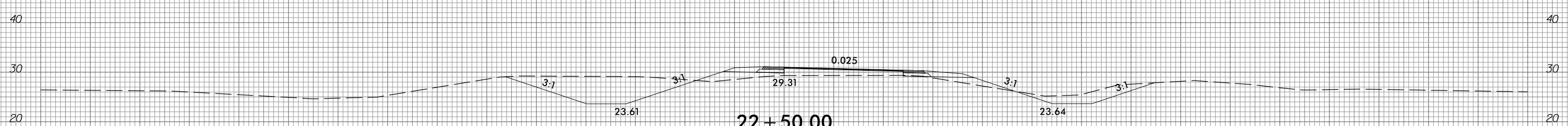
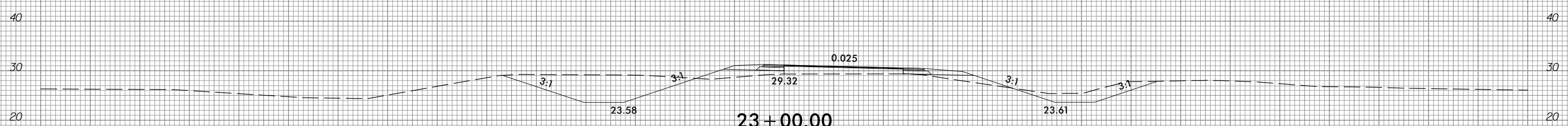
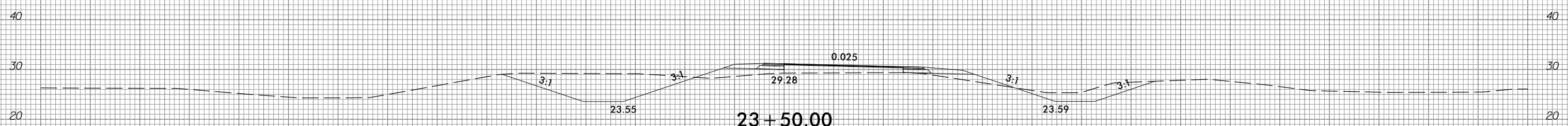
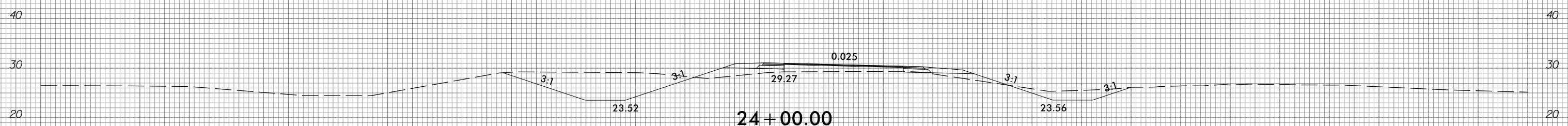
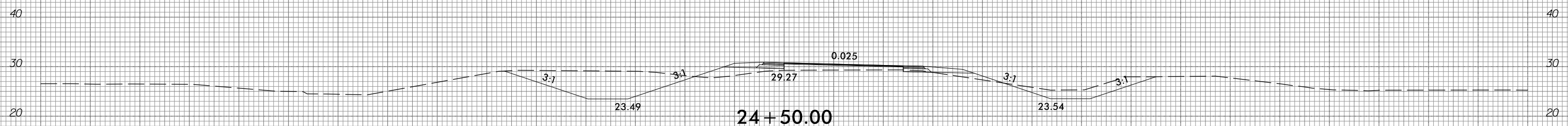
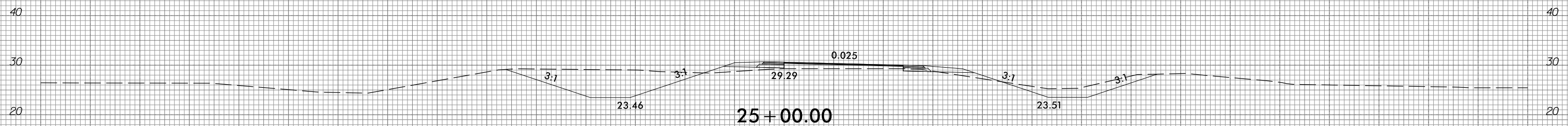

-RPICD-

150 140 130 120 110 100 90 80 70 60 50 40 30 20 10 0 10 20 30 40 50 60 70 80 90 100 110 120 130 140 150



150 140 130 120 110 100 90 80 70 60 50 40 30 20 10 0 10 20 30 40 50 60 70 80 90 100 110 120 130 140 150

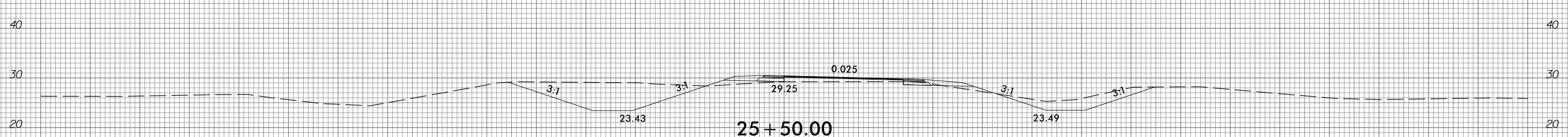
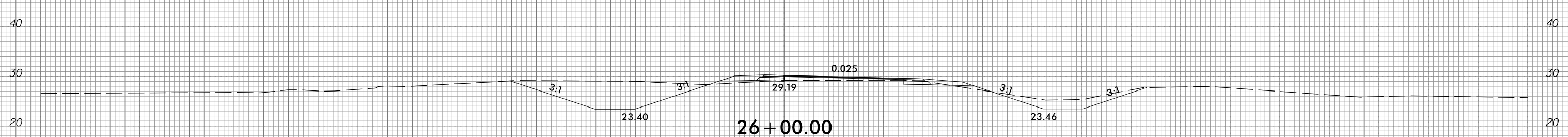
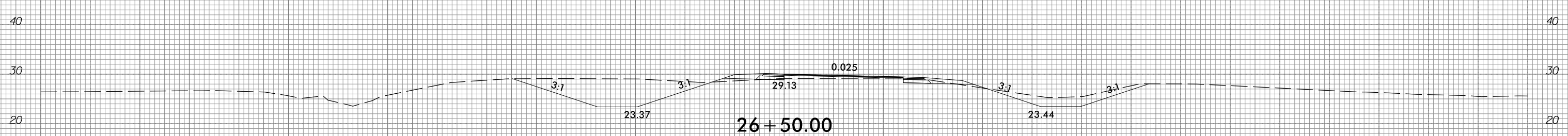
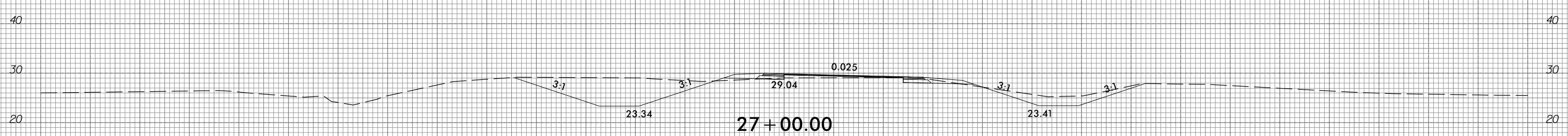
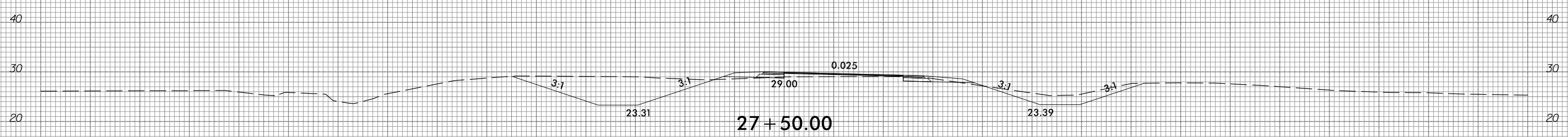
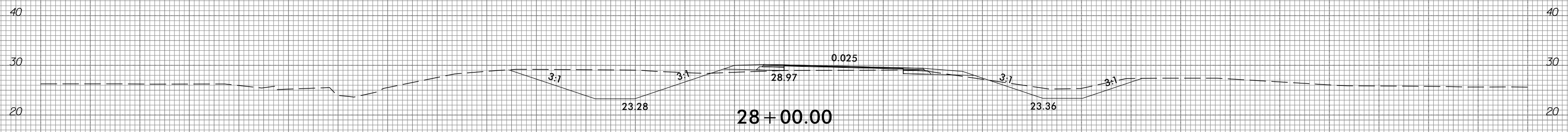

-RPICD-

150 140 130 120 110 100 90 80 70 60 50 40 30 20 10 0 10 20 30 40 50 60 70 80 90 100 110 120 130 140 150

6/23/16



PROJ. REFERENCE NO.  
R-1015

SHEET NO.  
X-332

150 140 130 120 110 100 90 80 70 60 50 40 30 20 10 0 10 20 30 40 50 60 70 80 90 100 110 120 130 140 150

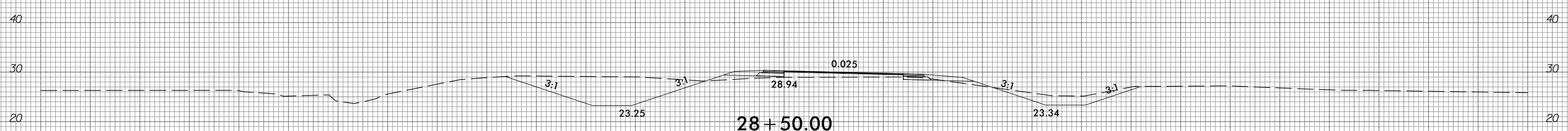
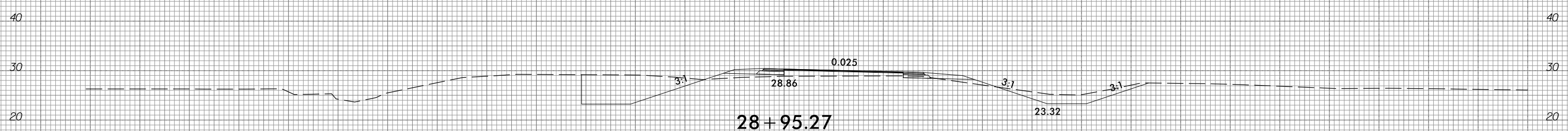
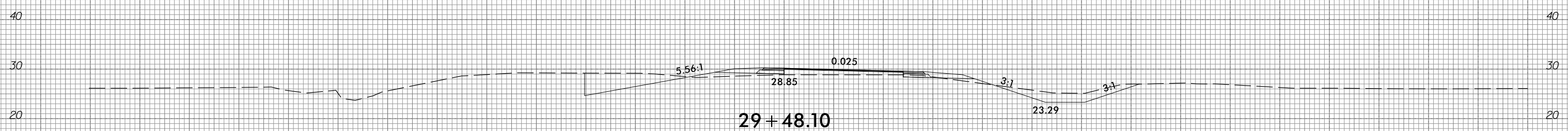
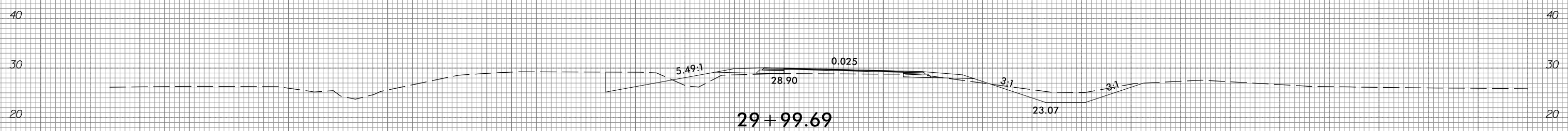
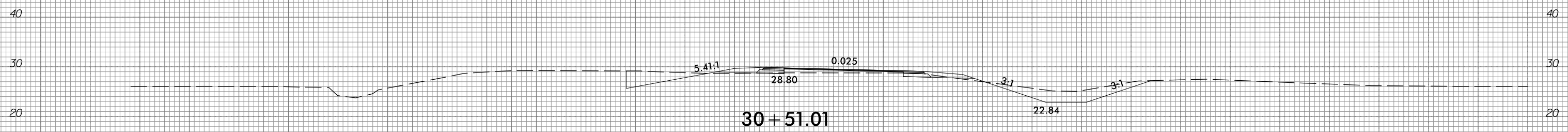
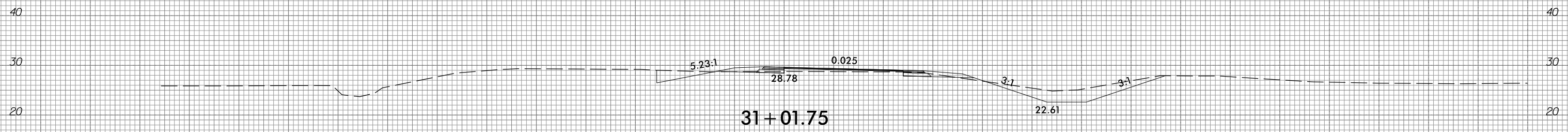

-RPICD-

150 140 130 120 110 100 90 80 70 60 50 40 30 20 10 0 10 20 30 40 50 60 70 80 90 100 110 120 130 140 150

10/31/2018  
G:\RA\9729-02\CADD\1015\Roadway\XSC\1015\_xp1\_RPICD.dgn  
gncdlin

6/23/16



PROJ. REFERENCE NO.  
R-1015

SHEET NO.  
X-333

150 140 130 120 110 100 90 80 70 60 50 40 30 20 10 0 10 20 30 40 50 60 70 80 90 100 110 120 130 140 150

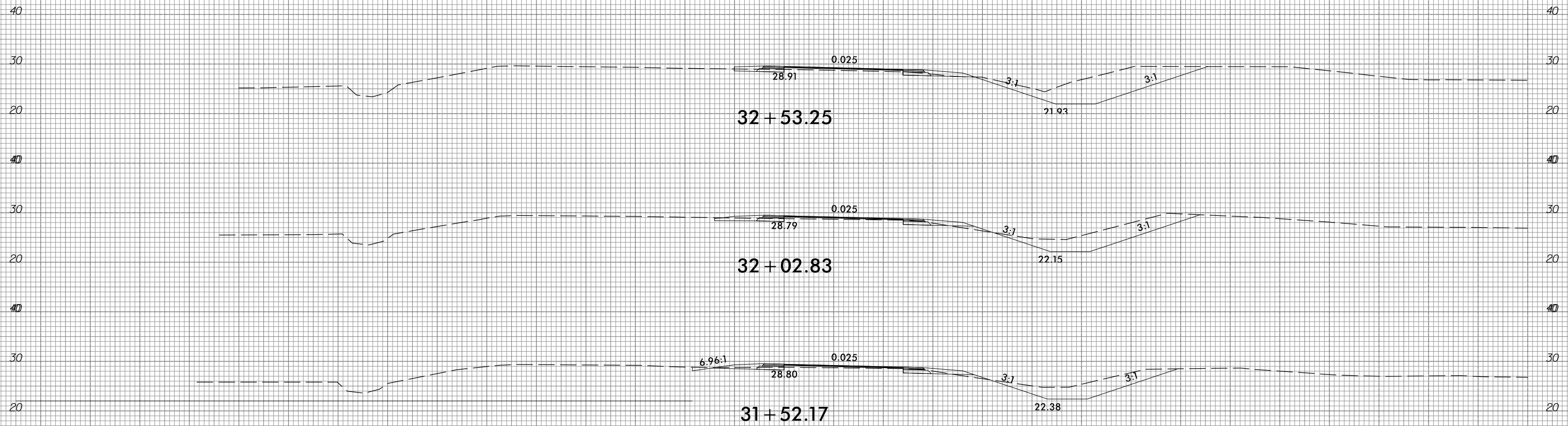

-RPICD-

I:\2016\6/23/16\10/31/2016\02\CADD\1015\Roadway\XSC\1015\_xp1\_RPICD.dgn

150 140 130 120 110 100 90 80 70 60 50 40 30 20 10 0 10 20 30 40 50 60 70 80 90 100 110 120 130 140 150

6/23/16



PROJ. REFERENCE NO.  
R-1015

SHEET NO.  
X-334

150 140 130 120 110 100 90 80 70 60 50 40 30 20 10 0 10 20 30 40 50 60 70 80 90 100 110 120 130 140 150

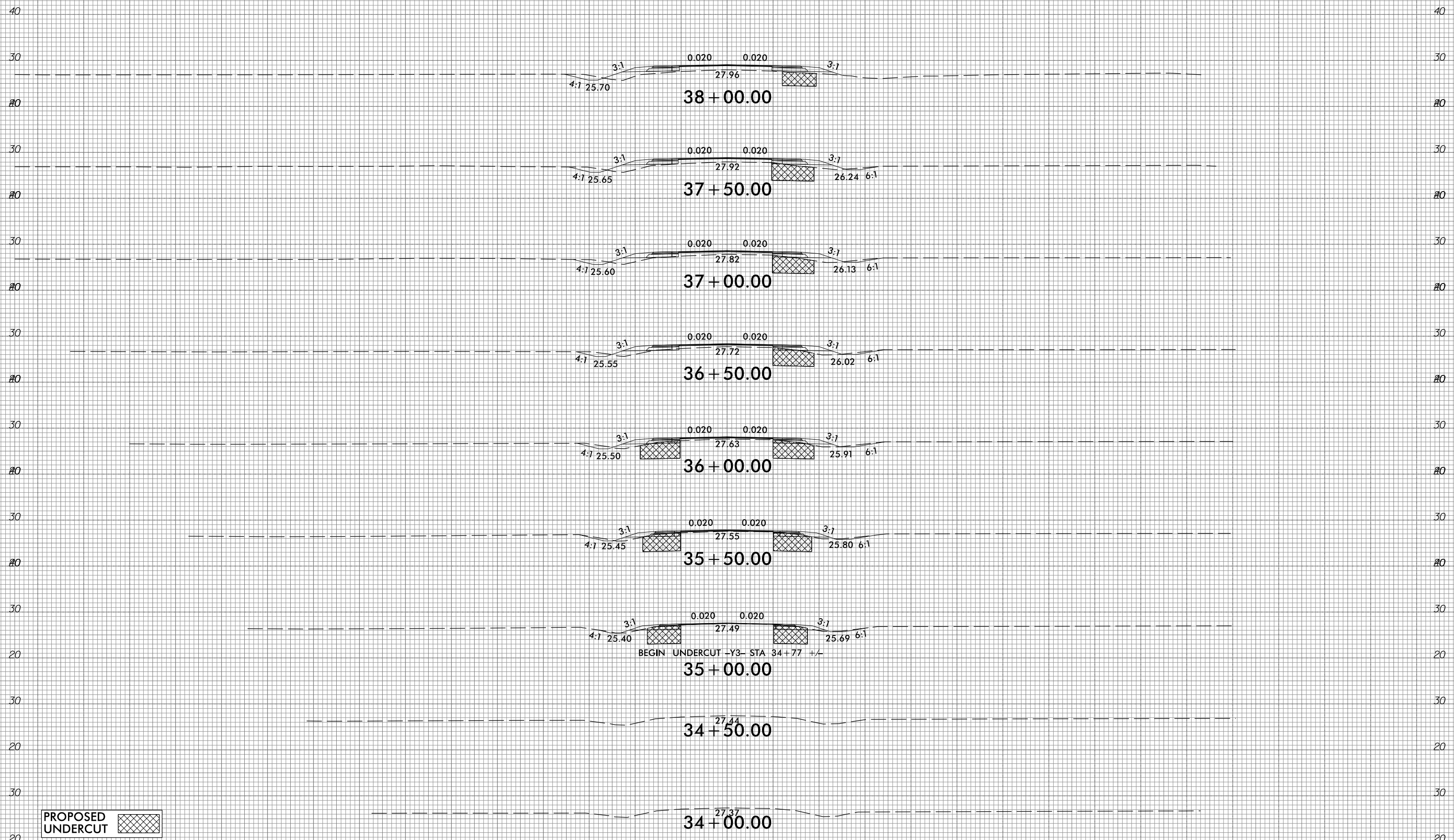

PROPOSED UNDERCUT

-Y3-

10/31/2018  
G:\RA\9729-02\CADD\1015\Roadway\XSC\1015\_xp1\_Y3.dgn  
gncdlin

150 140 130 120 110 100 90 80 70 60 50 40 30 20 10 0 10 20 30 40 50 60 70 80 90 100 110 120 130 140 150



150 140 130 120 110 100 90 80 70 60 50 40 30 20 10 0 10 20 30 40 50 60 70 80 90 100 110 120 130 140 150

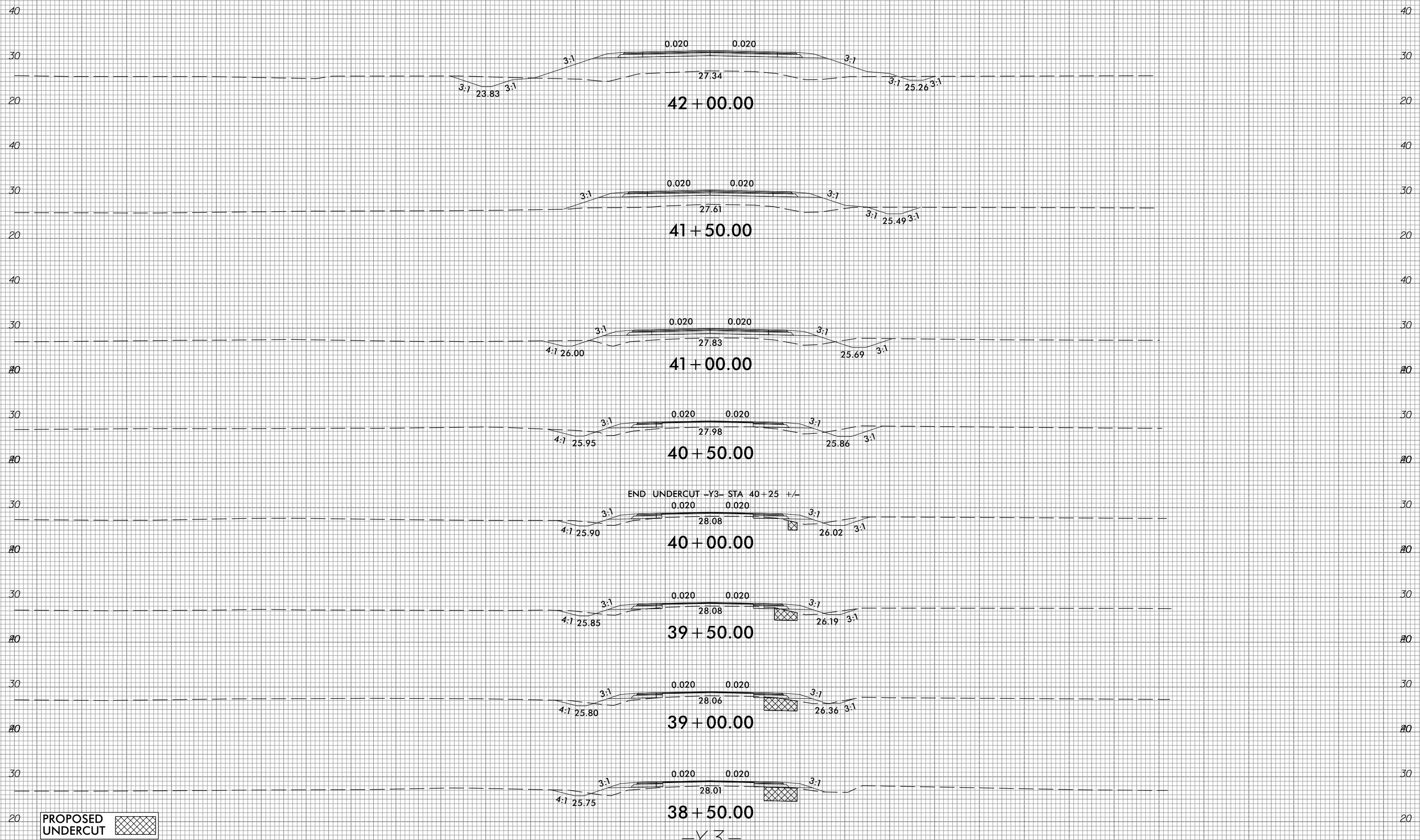

150 140 130 120 110 100 90 80 70 60 50 40 30 20 10 0 10 20 30 40 50 60 70 80 90 100 110 120 130 140 150

150 140 130 120 110 100 90 80 70 60 50 40 30 20 10 0 10 20 30 40 50 60 70 80 90 100 110 120 130 140 150

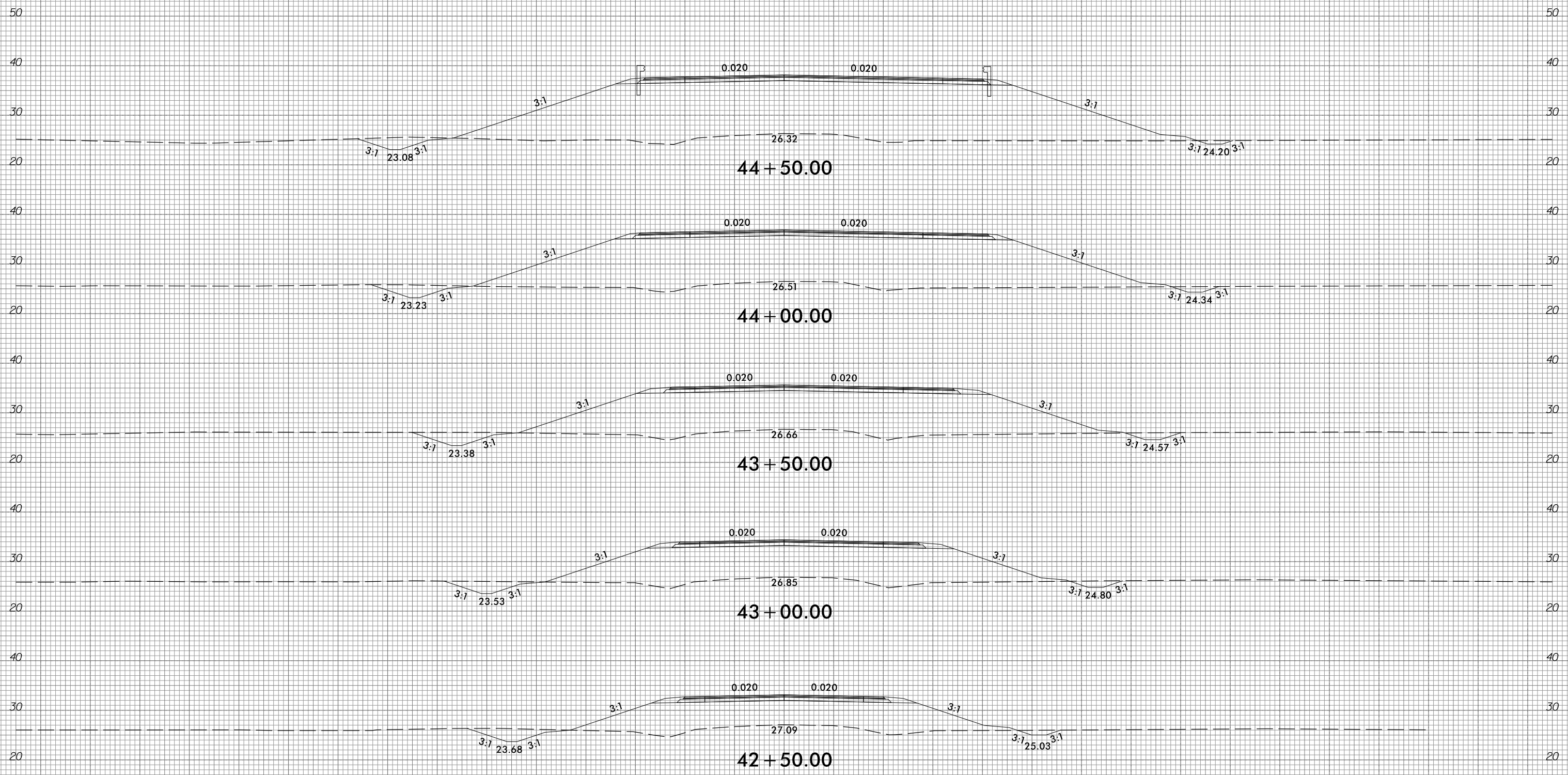

-Y3-

6/23/16



PROJ. REFERENCE NO.  
R-1015

SHEET NO.  
X-337

150 140 130 120 110 100 90 80 70 60 50 40 30 20 10 0 10 20 30 40 50 60 70 80 90 100 110 120 130 140 150

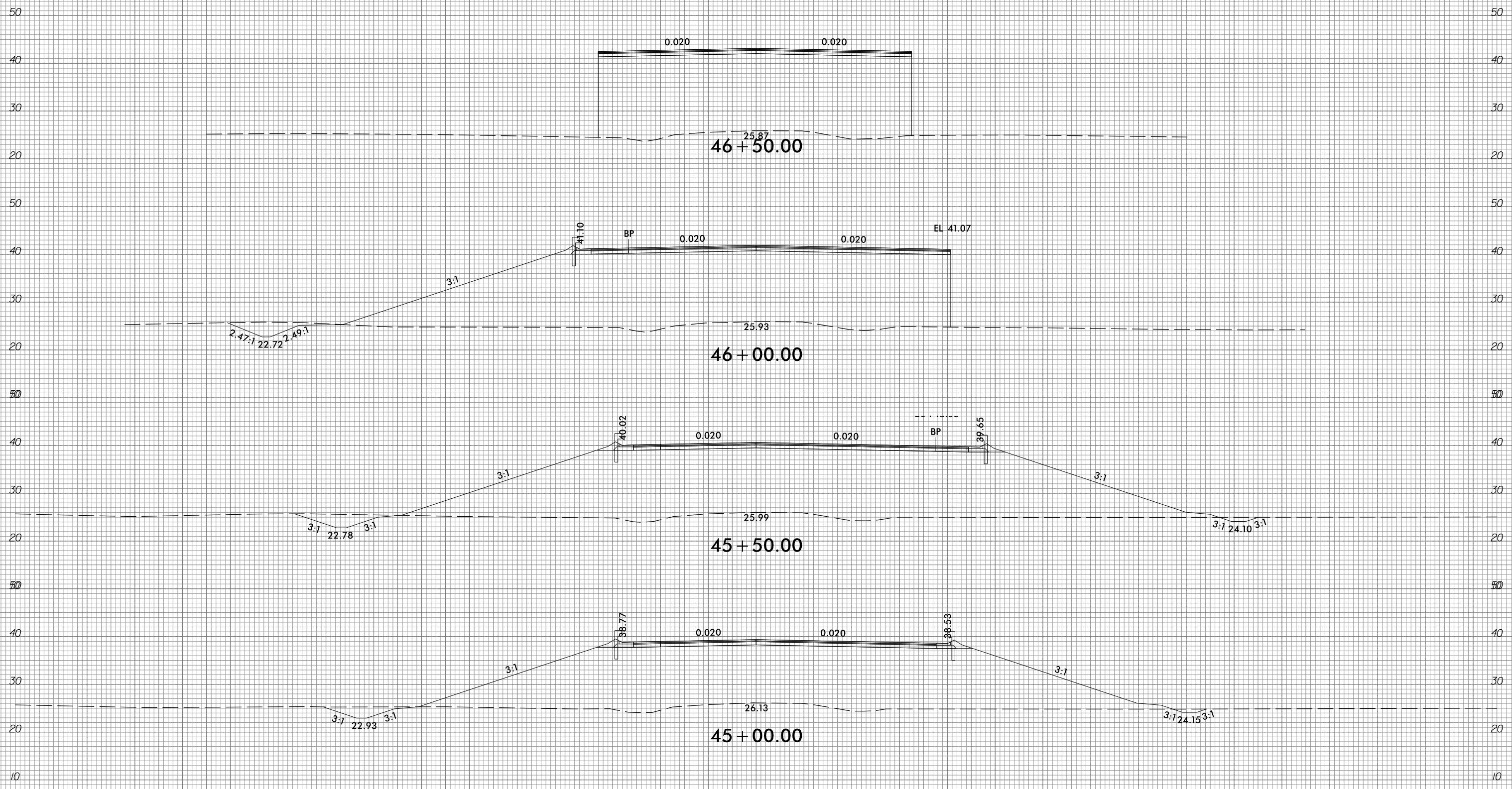

-Y3-

150 140 130 120 110 100 90 80 70 60 50 40 30 20 10 0 10 20 30 40 50 60 70 80 90 100 110 120 130 140 150

10/31/2018  
G:\RA\9729-02\CADD\1015\Roadway\XSC\1015\_xp1\_Y3.dgn  
gncdlin

6/23/16



PROJ. REFERENCE NO.  
R-1015

SHEET NO.  
X-338

150 140 130 120 110 100 90 80 70 60 50 40 30 20 10 0 10 20 30 40 50 60 70 80 90 100 110 120 130 140 150

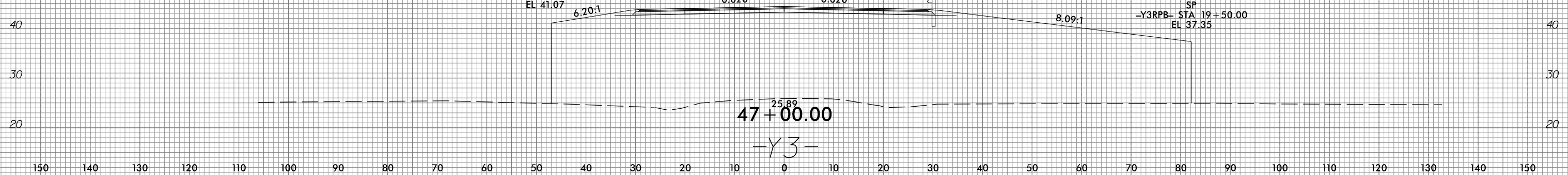
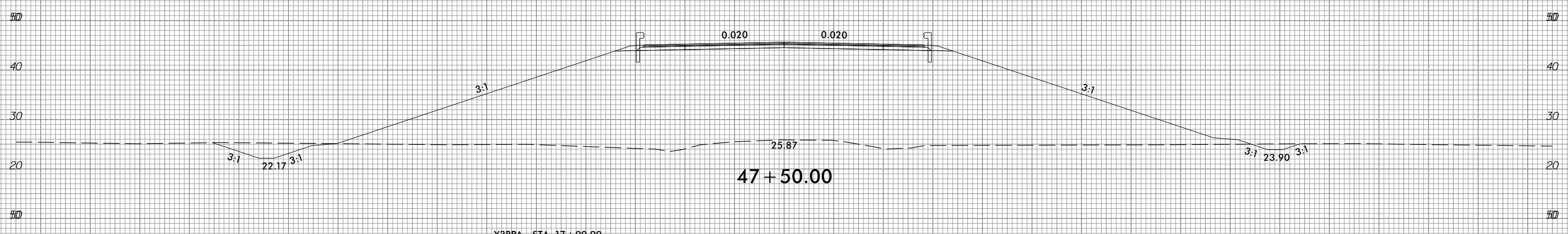
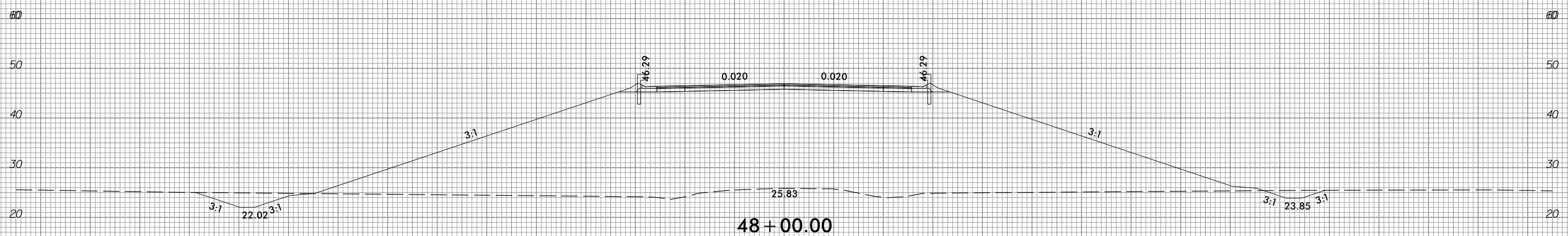
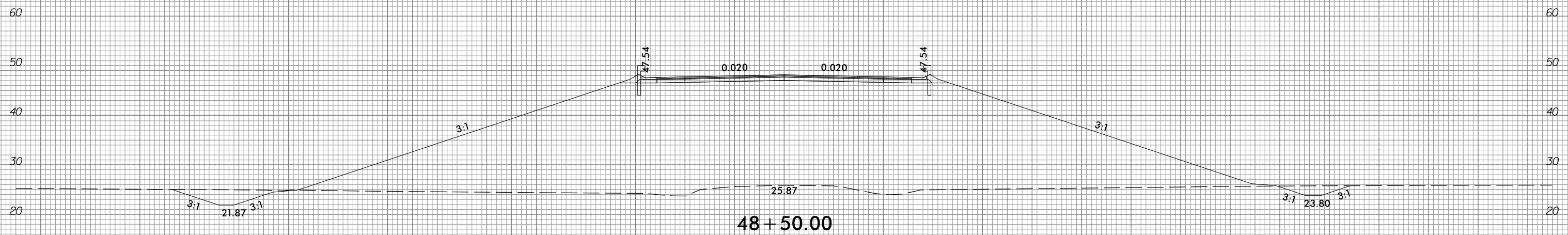

150 140 130 120 110 100 90 80 70 60 50 40 30 20 10 0 10 20 30 40 50 60 70 80 90 100 110 120 130 140 150

10/31/2018  
G:\RA\9729-02\CADD\1015\Roadway\XSC\1015\_xp1\_Y3.dgn  
gncdjin



150 140 130 120 110 100 90 80 70 60 50 40 30 20 10 0 10 20 30 40 50 60 70 80 90 100 110 120 130 140 150

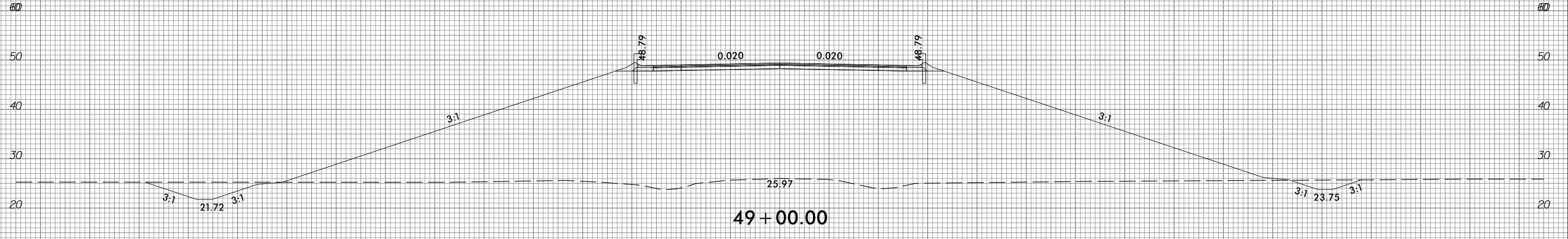
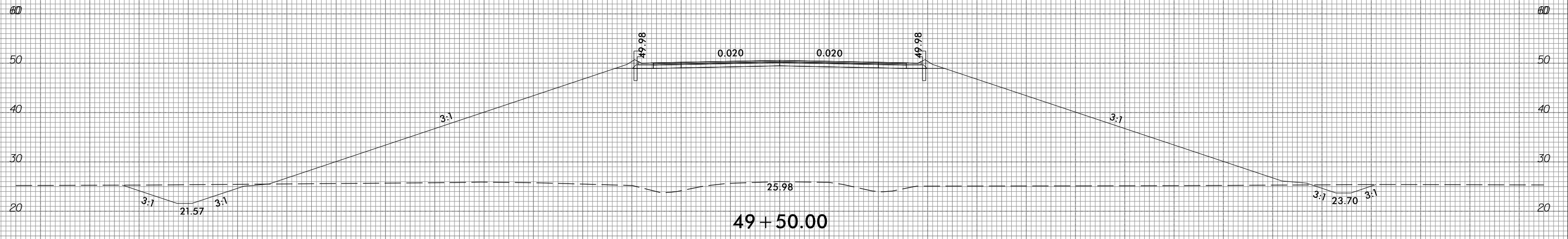
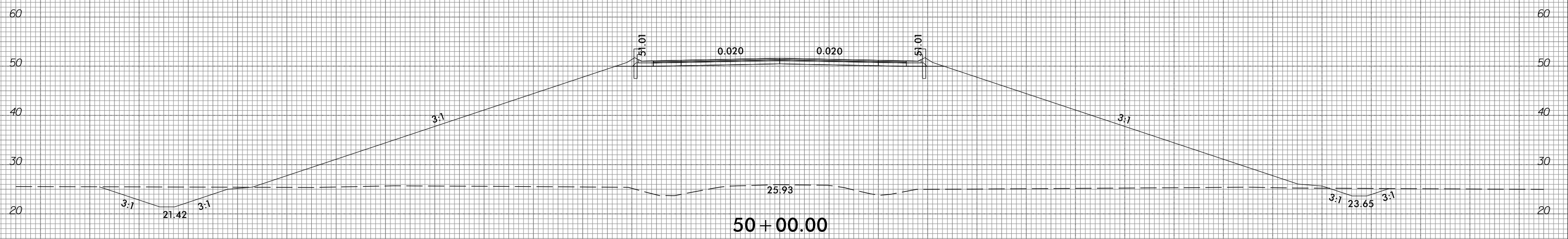

-Y3-

150 140 130 120 110 100 90 80 70 60 50 40 30 20 10 0 10 20 30 40 50 60 70 80 90 100 110 120 130 140 150

6/23/16



PROJ. REFERENCE NO.
R-1015

SHEET NO.
X-340

150 140 130 120 110 100 90 80 70 60 50 40 30 20 10 0 10 20 30 40 50 60 70 80 90 100 110 120 130 140 150

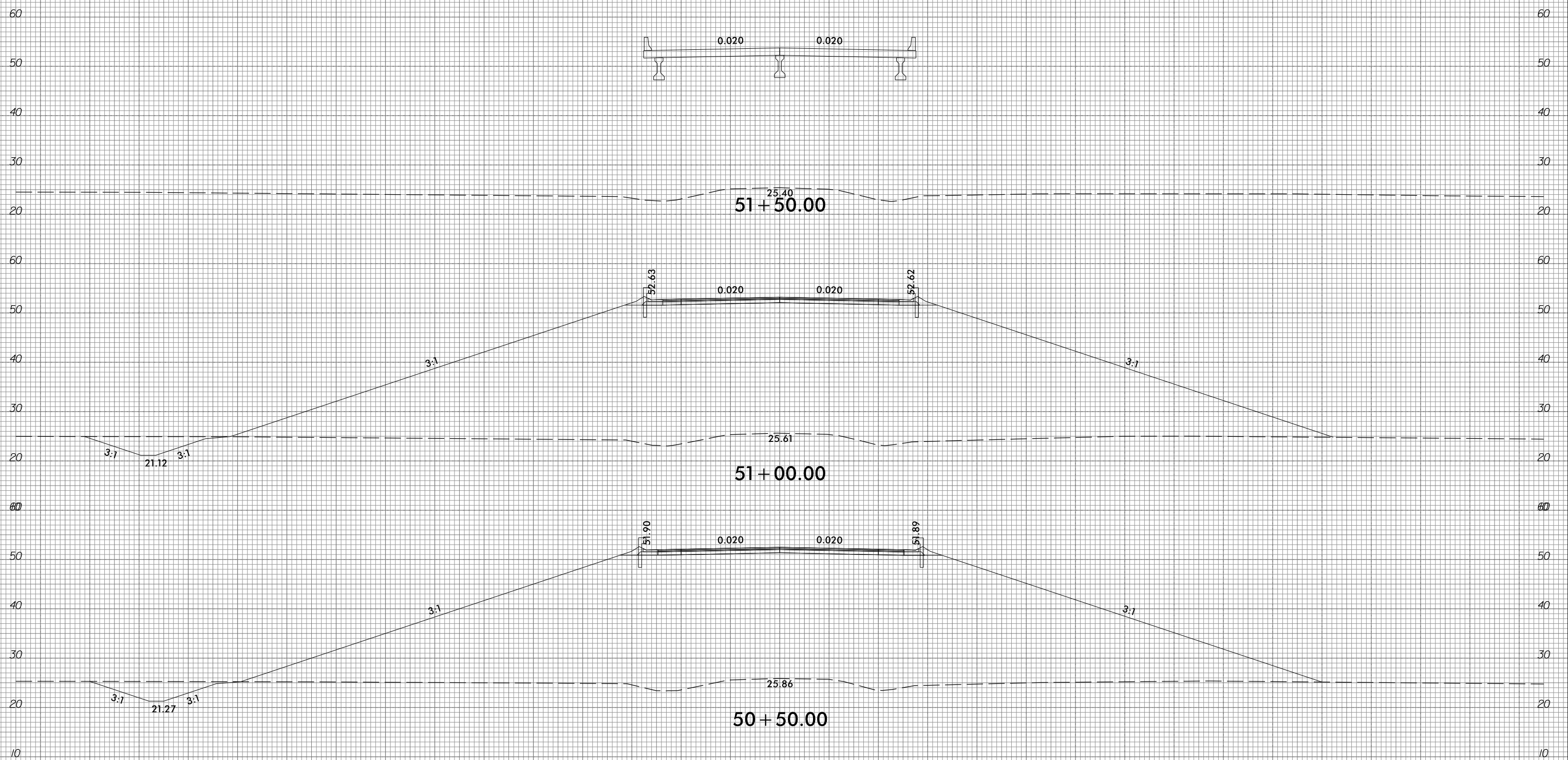

51+50.00

51+00.00

50+50.00

-Y3-

10/31/2018  
 G:\RA\9729-02\CADD\1015\Roadway\XSC\1015\_xp1\_Y3.dgn  
 gmc311r

6/23/16



PROJ. REFERENCE NO.  
R-1015

SHEET NO.  
X-341

150 140 130 120 110 100 90 80 70 60 50 40 30 20 10 0 10 20 30 40 50 60 70 80 90 100 110 120 130 140 150

60 60

50 50

40 40

30 30

20 20

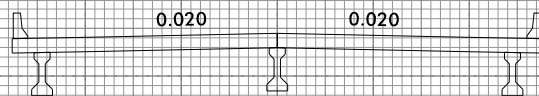

24.84  
53+00.00

60 60

50 50

40 40

30 30

20 20

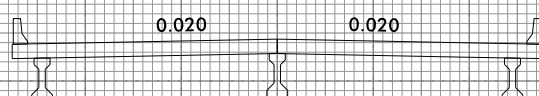

25.05  
52+50.00

60 60

50 50

40 40

30 30

20 20

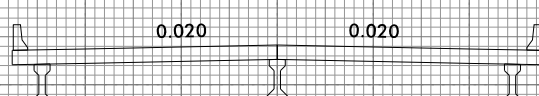

25.22  
52+00.00

-Y3-

150 140 130 120 110 100 90 80 70 60 50 40 30 20 10 0 10 20 30 40 50 60 70 80 90 100 110 120 130 140 150

10/31/2018  
G:\RA\9729-02\CADD\1015\Roadway\XSC\1015\_xp1\_Y3.dgn  
gncdjin

6/23/16



PROJ. REFERENCE NO.  
R-1015

SHEET NO.  
X-342

150 140 130 120 110 100 90 80 70 60 50 40 30 20 10 0 10 20 30 40 50 60 70 80 90 100 110 120 130 140 150

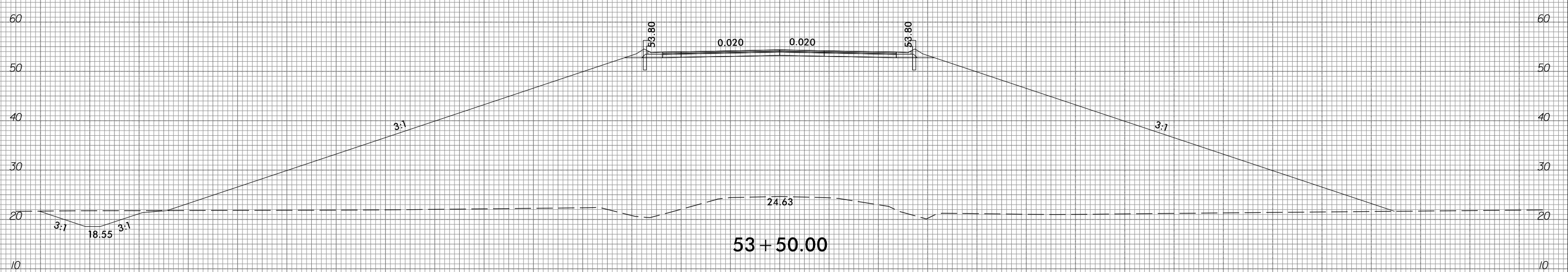
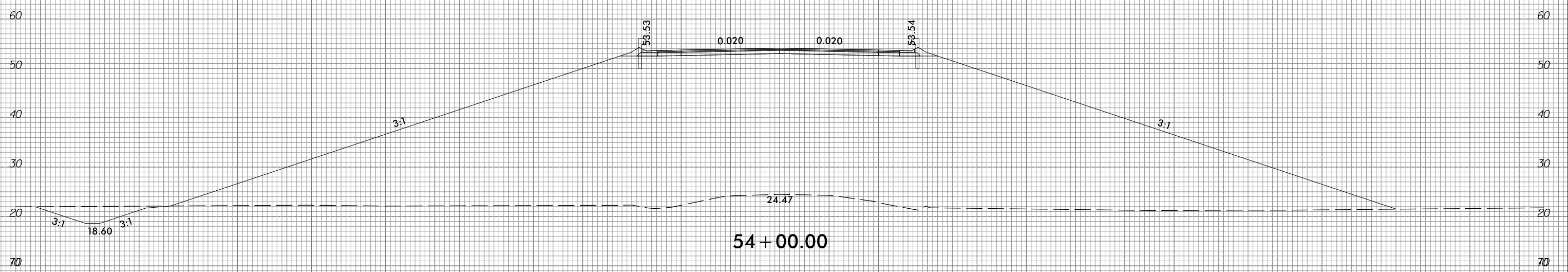
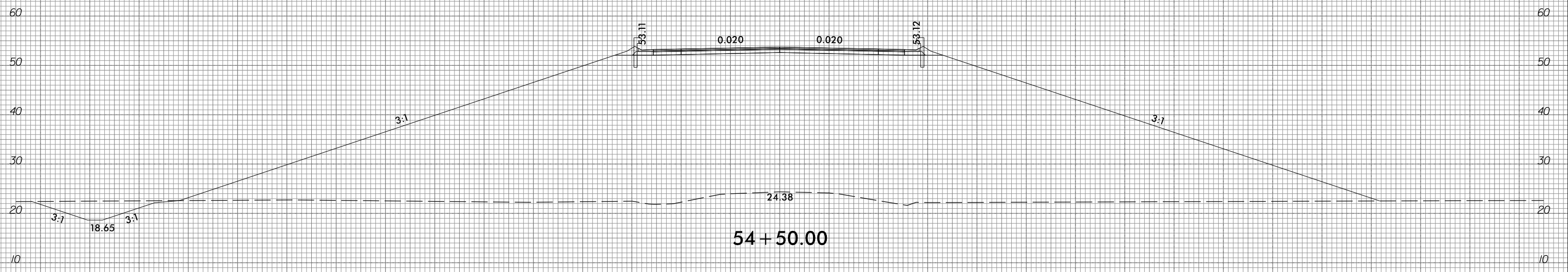

-Y3-

150 140 130 120 110 100 90 80 70 60 50 40 30 20 10 0 10 20 30 40 50 60 70 80 90 100 110 120 130 140 150

10/31/2018  
G:\RA\9729-02\CADD\1015\Roadway\XSC\1015\_xp1\_Y3.dgn  
gncdlin



6/23/16



PROJ. REFERENCE NO.	SHEET NO.
R-1015	X-343

150 140 130 120 110 100 90 80 70 60 50 40 30 20 10 0 10 20 30 40 50 60 70 80 90 100 110 120 130 140 150

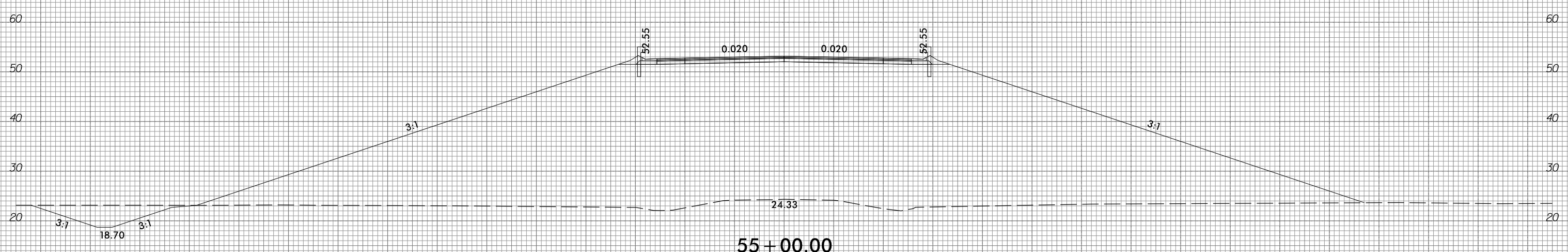
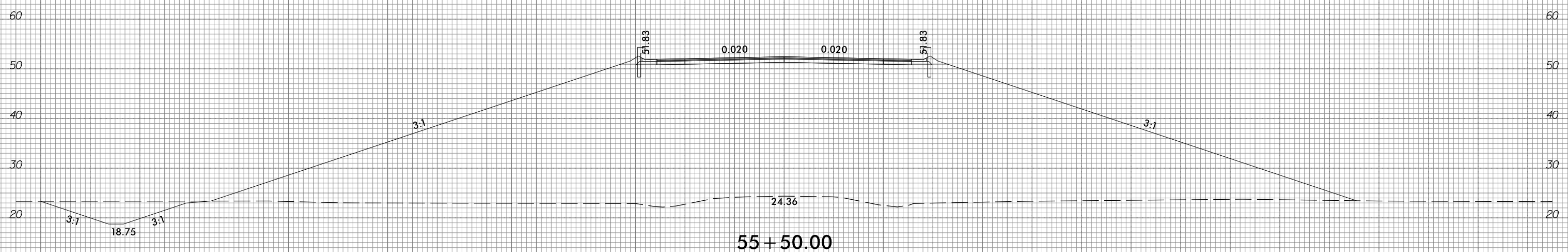
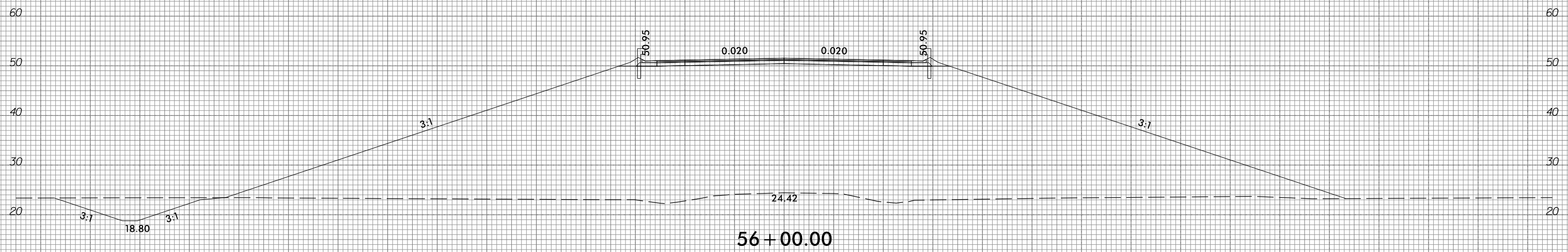

-Y3-

10/31/2018  
G:\RA\9729-02\CADD\1015\Roadway\XSC\1015\_xp1\_Y3.dgn  
gncdlin

6/23/16



PROJ. REFERENCE NO.	SHEET NO.
R-1015	X-344

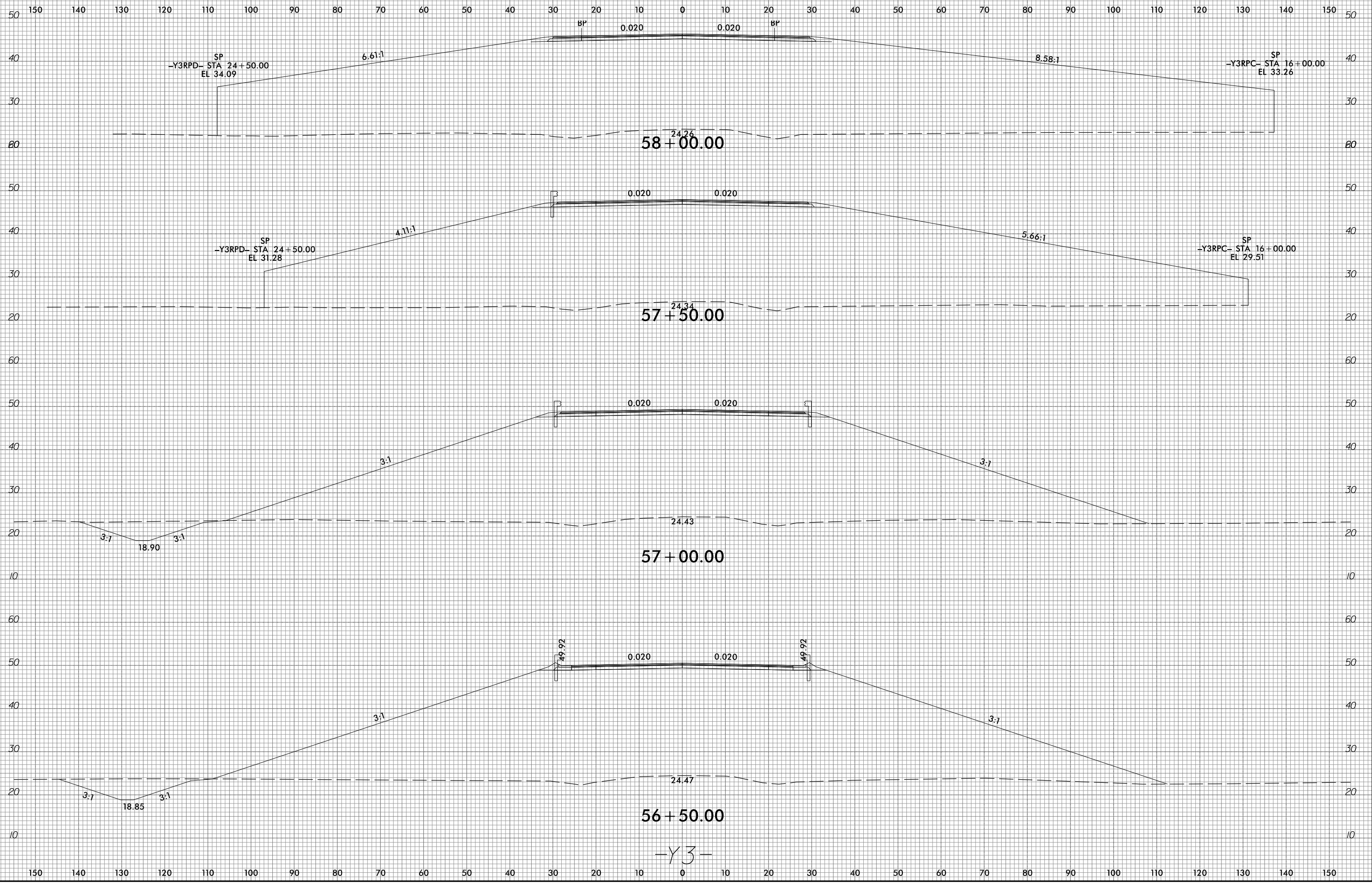

10/31/2018  
G:\RA\9729-02\CADD\1015\Roadway\XSC\1015\_xp1\_Y3.dgn  
gncdlin

6/23/16



PROJ. REFERENCE NO.  
R-1015

SHEET NO.  
X-345

150 140 130 120 110 100 90 80 70 60 50 40 30 20 10 0 10 20 30 40 50 60 70 80 90 100 110 120 130 140 150

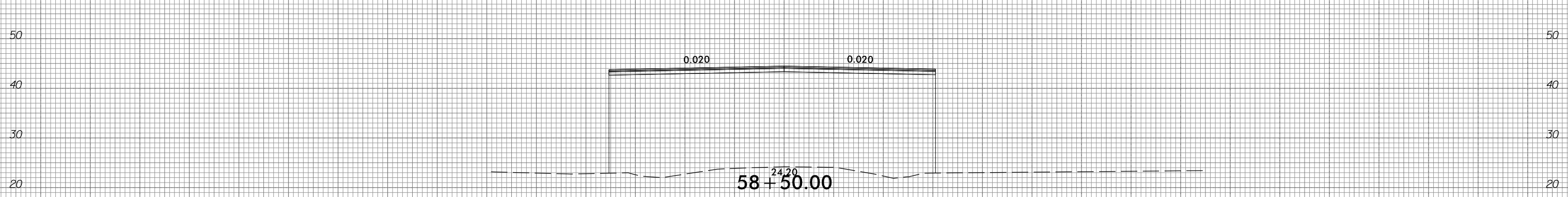
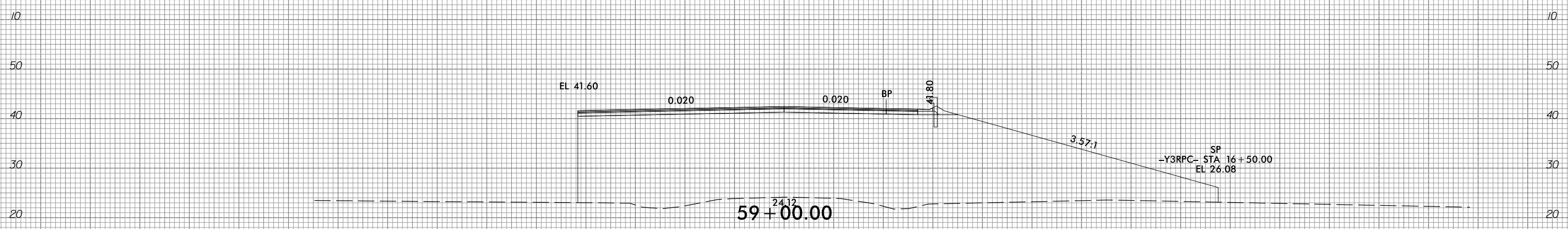
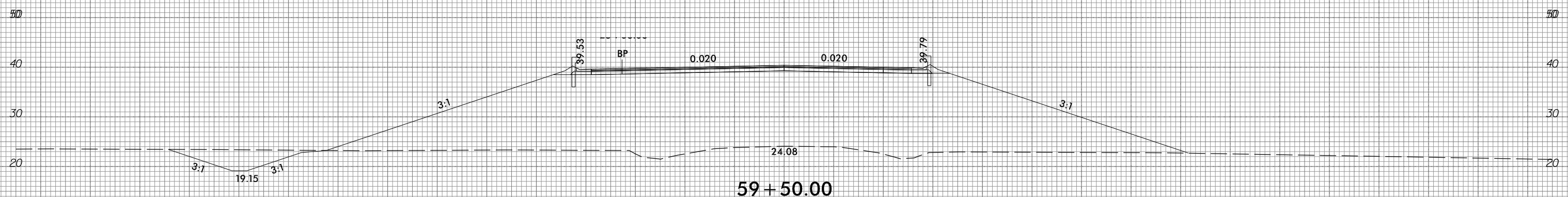
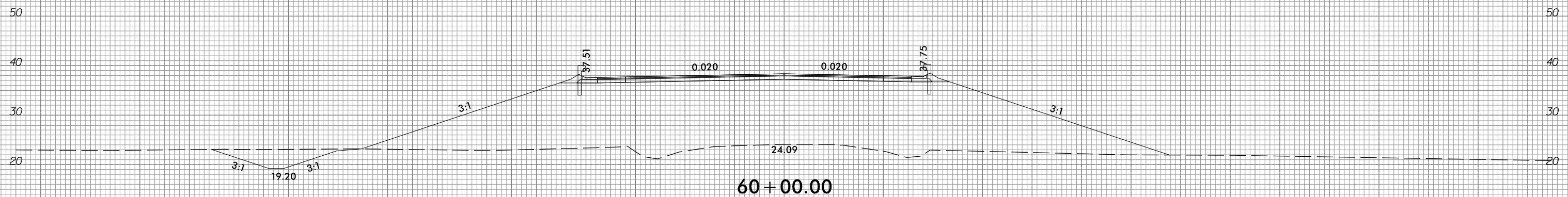

-Y3-

150 140 130 120 110 100 90 80 70 60 50 40 30 20 10 0 10 20 30 40 50 60 70 80 90 100 110 120 130 140 150

10/31/2018  
G:\RA\9729-02\CADD\1015\Roadway\XSC\1015\_xp1\_Y3.dgn  
gncdjin

6/23/16



PROJ. REFERENCE NO.  
R-1015

SHEET NO.  
X-346

150 140 130 120 110 100 90 80 70 60 50 40 30 20 10 0 10 20 30 40 50 60 70 80 90 100 110 120 130 140 150

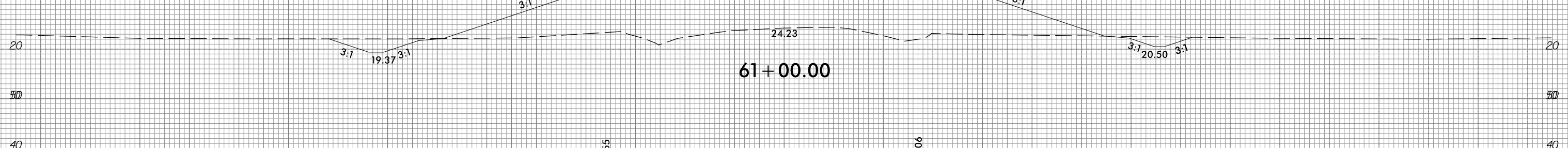
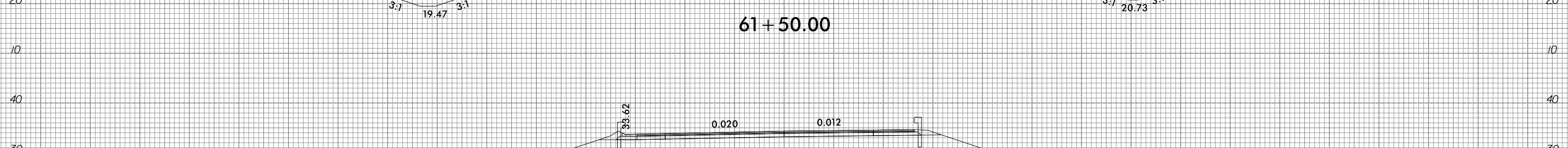
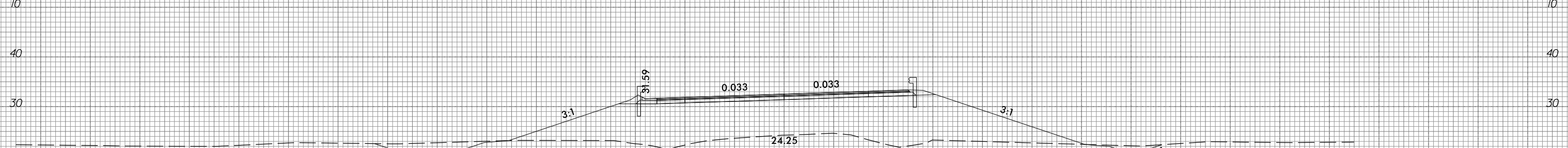
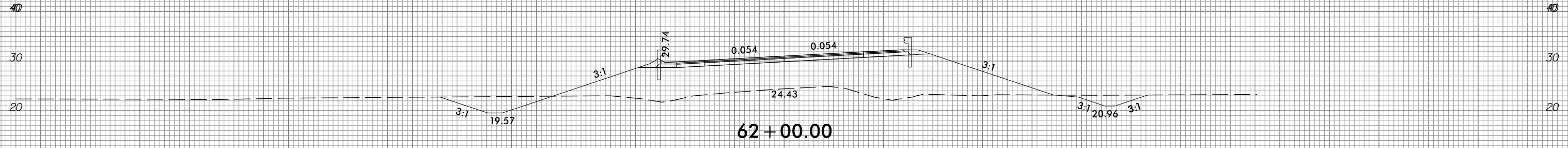
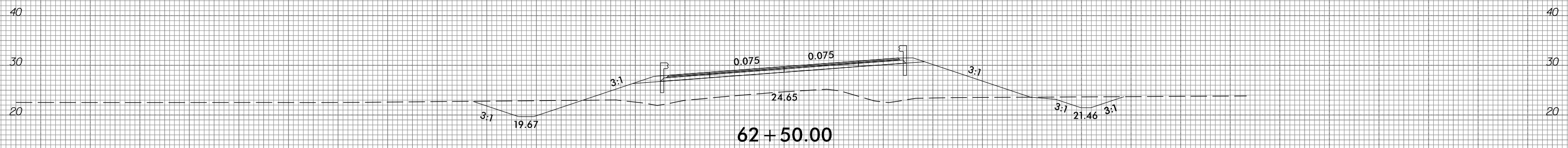

-Y3-

150 140 130 120 110 100 90 80 70 60 50 40 30 20 10 0 10 20 30 40 50 60 70 80 90 100 110 120 130 140 150

10/31/2018  
G:\RA\9729-02\CADD\1015\Roadway\XSC\1015\_xp1\_Y3.dgn  
gncdlin

150 140 130 120 110 100 90 80 70 60 50 40 30 20 10 0 10 20 30 40 50 60 70 80 90 100 110 120 130 140 150

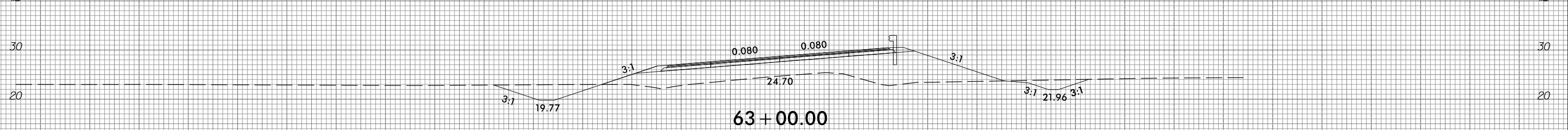
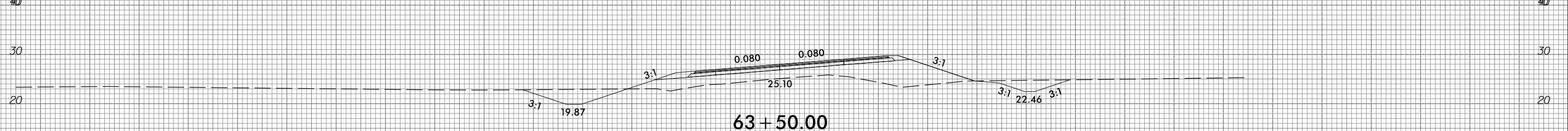
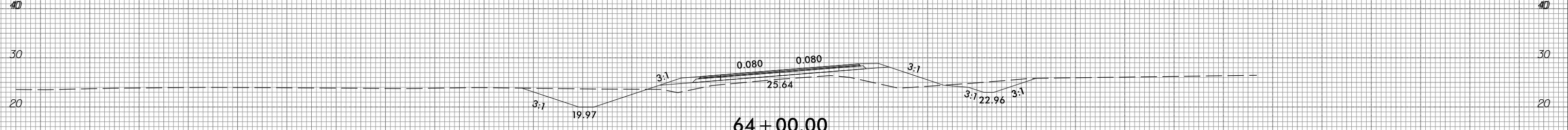
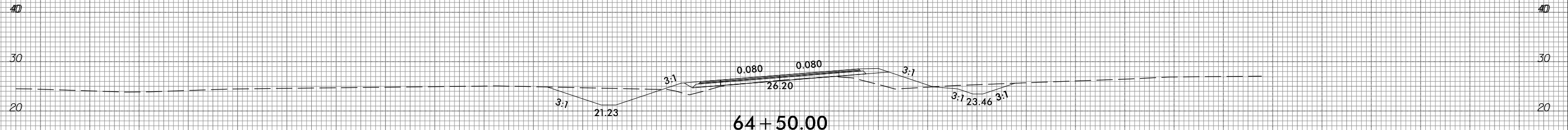
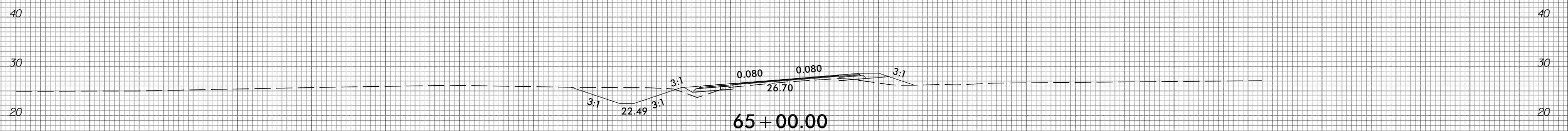
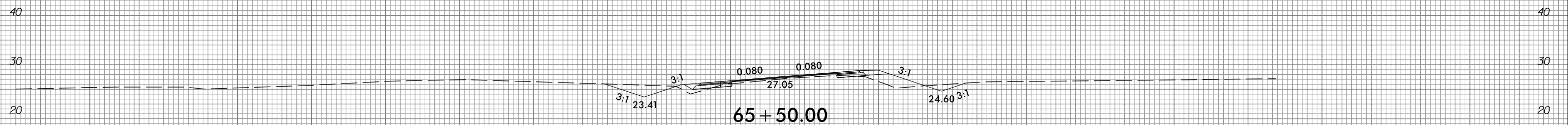

-Y3-

150 140 130 120 110 100 90 80 70 60 50 40 30 20 10 0 10 20 30 40 50 60 70 80 90 100 110 120 130 140 150

6/23/16



PROJ. REFERENCE NO.  
R-1015

SHEET NO.  
X-348

150 140 130 120 110 100 90 80 70 60 50 40 30 20 10 0 10 20 30 40 50 60 70 80 90 100 110 120 130 140 150

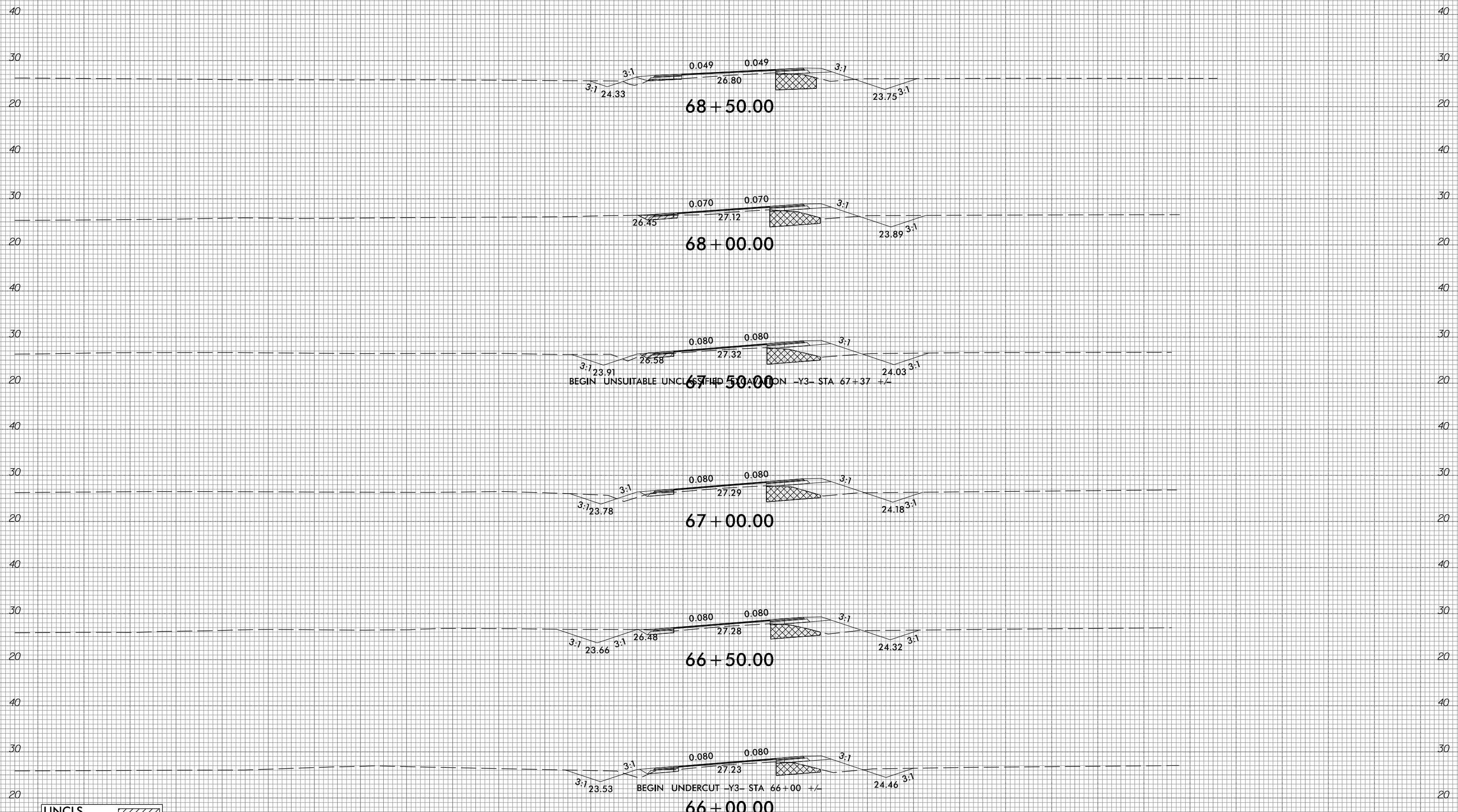

68+50.00

68+00.00

67+50.00

67+00.00

66+50.00

66+00.00

BEGIN UNSUITABLE UNCL. FIELD DRAINAGE ON -Y3- STA. 67+37 +/-

BEGIN UNDERCUT -Y3- STA. 66+00 +/-

-Y3-

UNCLS UNSUIT	
PROPOSED UNDERCUT	

150 140 130 120 110 100 90 80 70 60 50 40 30 20 10 0 10 20 30 40 50 60 70 80 90 100 110 120 130 140 150

10/31/2018  
G:\RA\9729-02\CADD\1015\Roadway\XSC\1015\_xp1\_Y3.dgn  
gncdjin

6/23/16



PROJ. REFERENCE NO.  
R-1015

SHEET NO.  
X-349

150 140 130 120 110 100 90 80 70 60 50 40 30 20 10 0 10 20 30 40 50 60 70 80 90 100 110 120 130 140 150

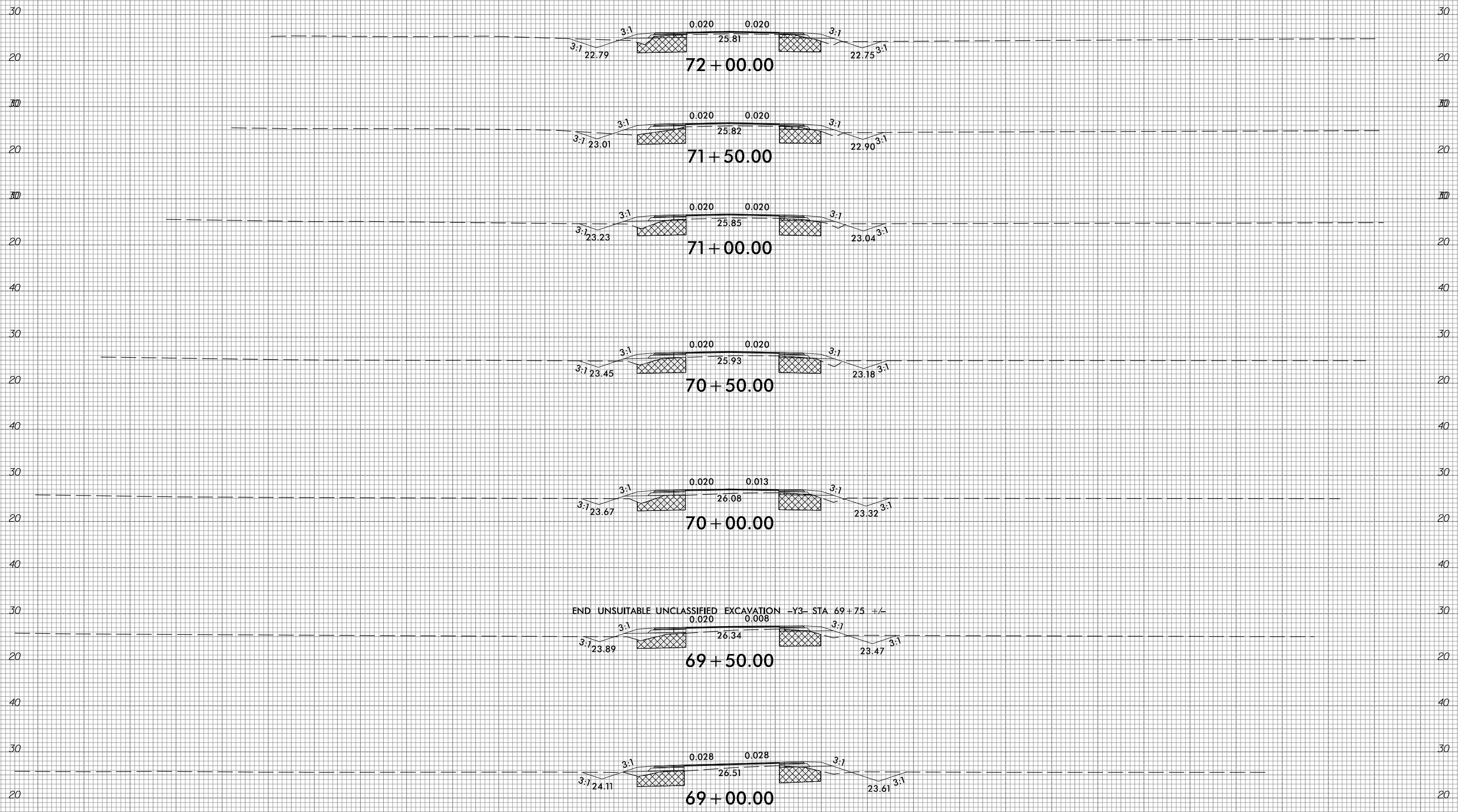

END UNSUITABLE UNCLASSIFIED EXCAVATION -Y3- STA 69+75 +/-

PROPOSED UNDERCUT



-Y3-

150 140 130 120 110 100 90 80 70 60 50 40 30 20 10 0 10 20 30 40 50 60 70 80 90 100 110 120 130 140 150

10/31/2018  
G:\RA\9729-02\CADD\1015\Roadway\XSC\1015\_xp1\_Y3.dgn  
gncdlin

150 140 130 120 110 100 90 80 70 60 50 40 30 20 10 0 10 20 30 40 50 60 70 80 90 100 110 120 130 140 150

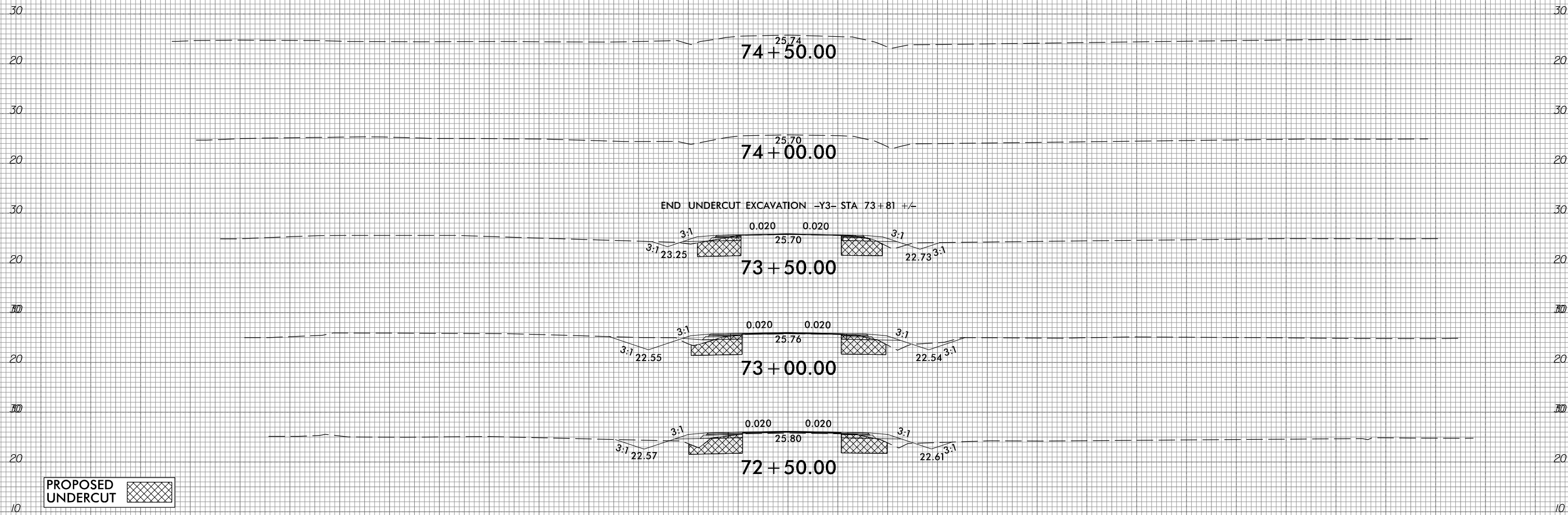

END UNDERCUT EXCAVATION -Y3- STA 73+81 +/-

PROPOSED UNDERCUT

-Y3-

150 140 130 120 110 100 90 80 70 60 50 40 30 20 10 0 10 20 30 40 50 60 70 80 90 100 110 120 130 140 150



6/23/16



PROJ. REFERENCE NO.  
R-1015

SHEET NO.  
X-351

150 140 130 120 110 100 90 80 70 60 50 40 30 20 10 0 10 20 30 40 50 60 70 80 90 100 110 120 130 140 150

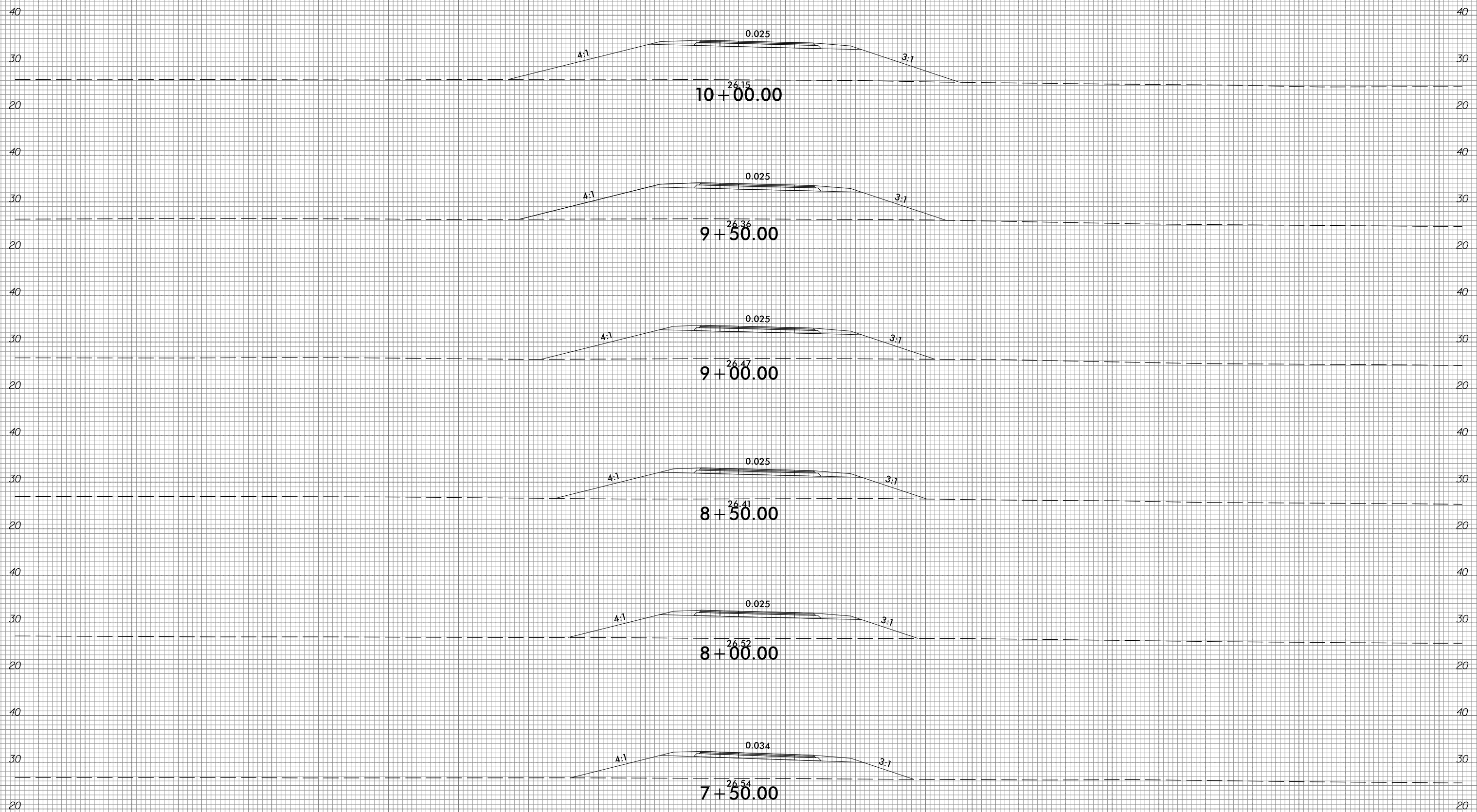

-Y3RPA-

150 140 130 120 110 100 90 80 70 60 50 40 30 20 10 0 10 20 30 40 50 60 70 80 90 100 110 120 130 140 150

10/31/2018  
G:\RA\9729-02\CADD\1015\Roadway\XSC\1015.sp1.Y3RPA.dgn  
gncdlin



150 140 130 120 110 100 90 80 70 60 50 40 30 20 10 0 10 20 30 40 50 60 70 80 90 100 110 120 130 140 150

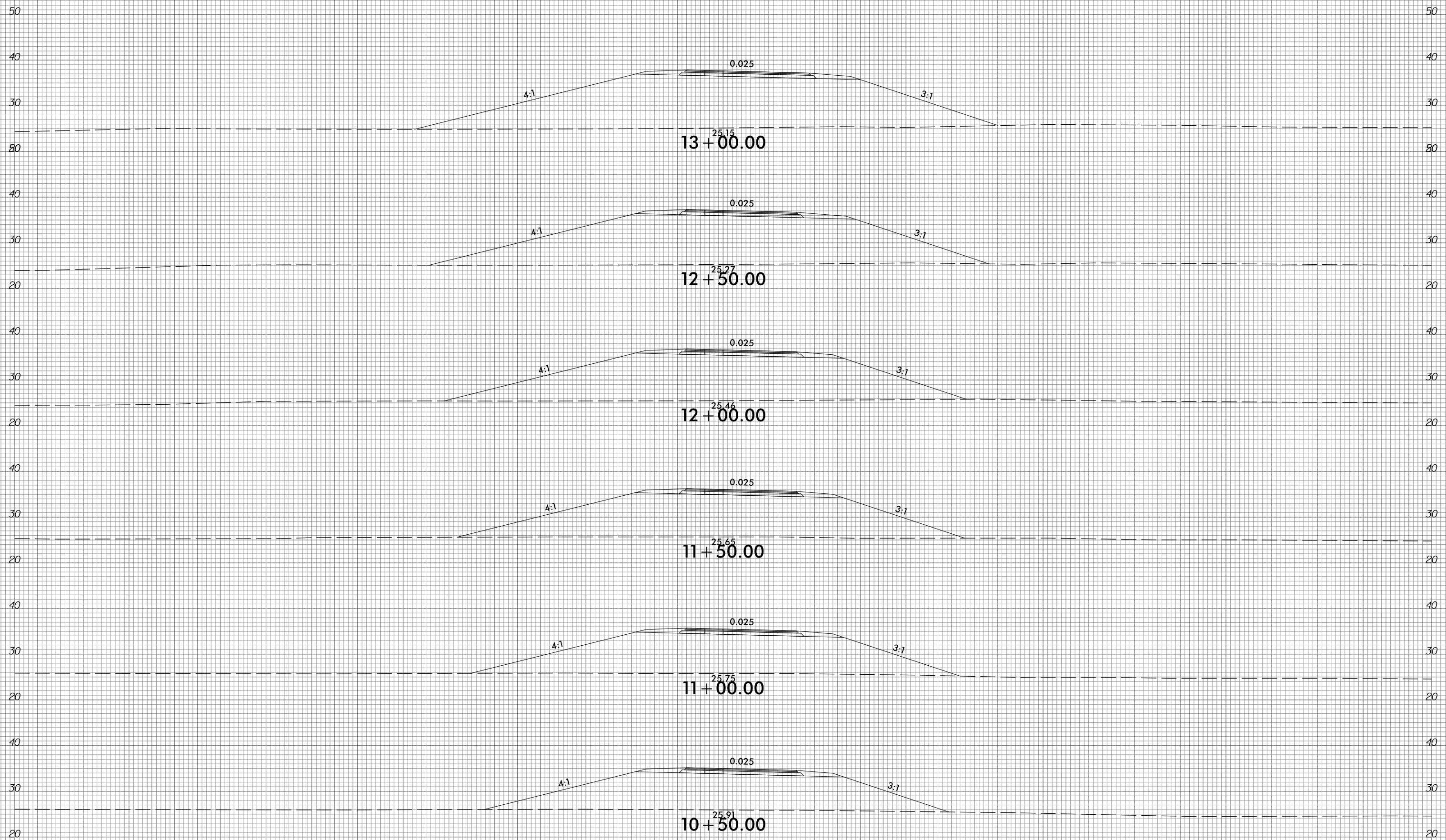

-Y3RPA-

150 140 130 120 110 100 90 80 70 60 50 40 30 20 10 0 10 20 30 40 50 60 70 80 90 100 110 120 130 140 150

6/23/16



PROJ. REFERENCE NO.  
R-1015

SHEET NO.  
X-353

150 140 130 120 110 100 90 80 70 60 50 40 30 20 10 0 10 20 30 40 50 60 70 80 90 100 110 120 130 140 150

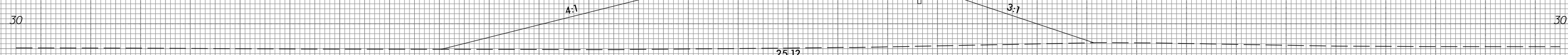
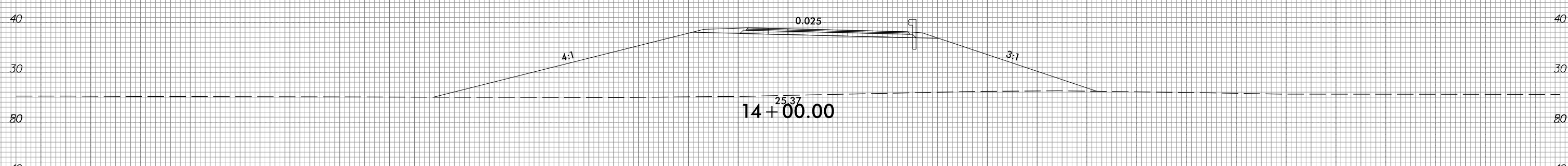
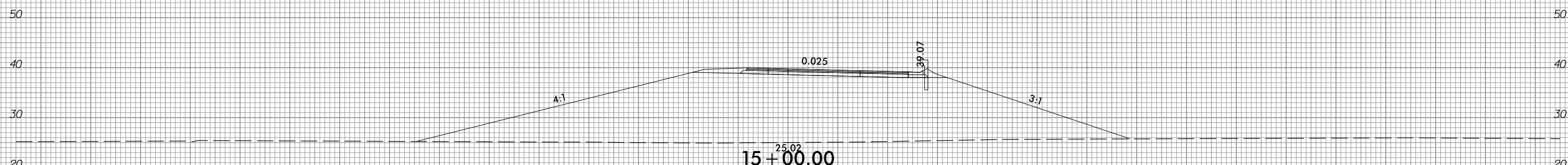
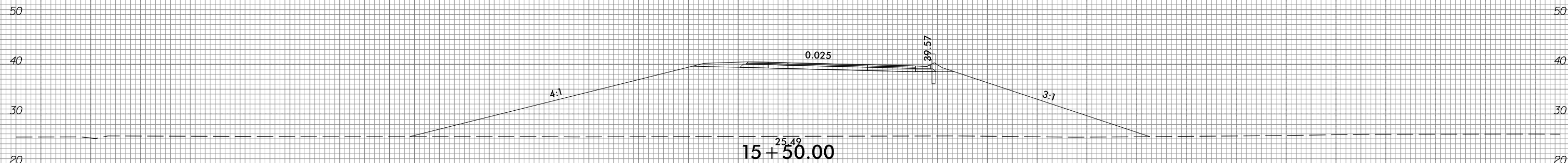

-Y3RPA-

150 140 130 120 110 100 90 80 70 60 50 40 30 20 10 0 10 20 30 40 50 60 70 80 90 100 110 120 130 140 150

10/31/2018  
G:\RA\9729-02\CADD\1015\Roadway\XSC\1015.sp1.Y3RPA.dgn  
gncdlin

6/23/16



PROJ. REFERENCE NO.  
R-1015

SHEET NO.  
X-354

150 140 130 120 110 100 90 80 70 60 50 40 30 20 10 0 10 20 30 40 50 60 70 80 90 100 110 120 130 140 150

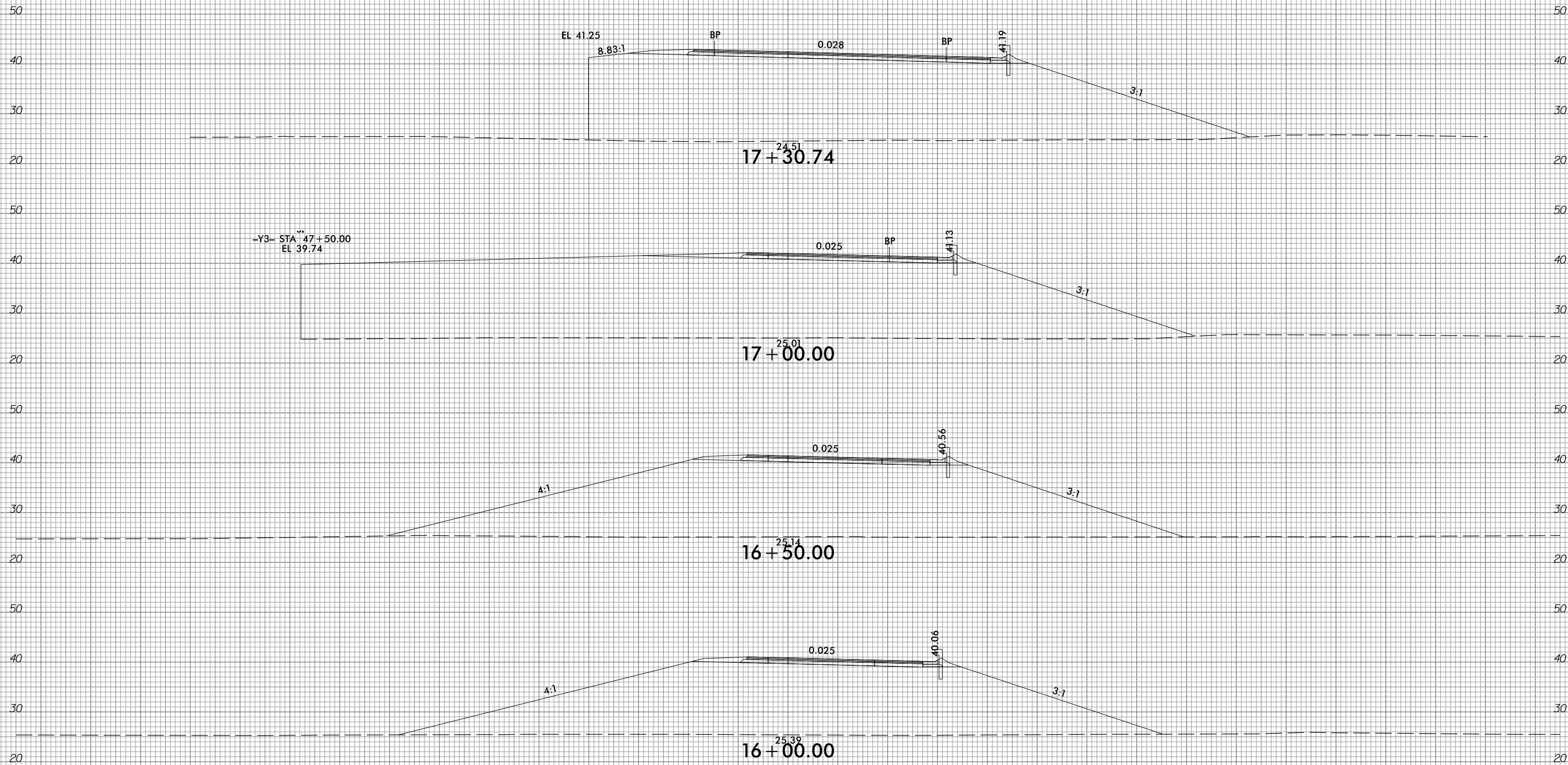

-Y3RPA-

150 140 130 120 110 100 90 80 70 60 50 40 30 20 10 0 10 20 30 40 50 60 70 80 90 100 110 120 130 140 150

10/31/2018  
G:\RA\9729-02\CADD\1015\Roadway\XSC\1015\_xp1\_Y3RPA.dgn  
gncdlin

6/23/16



PROJ. REFERENCE NO.
R-1015

SHEET NO.
X-355

150 140 130 120 110 100 90 80 70 60 50 40 30 20 10 0 10 20 30 40 50 60 70 80 90 100 110 120 130 140 150

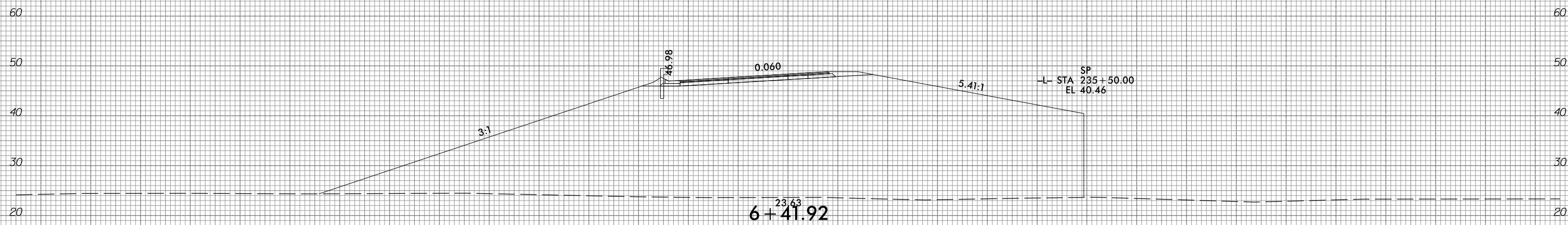
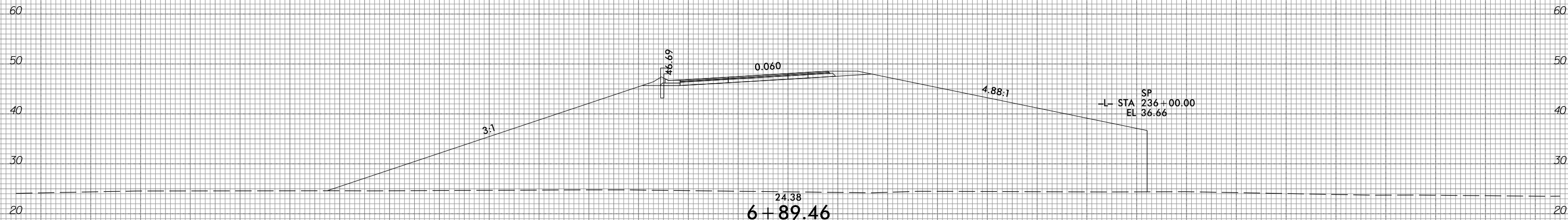
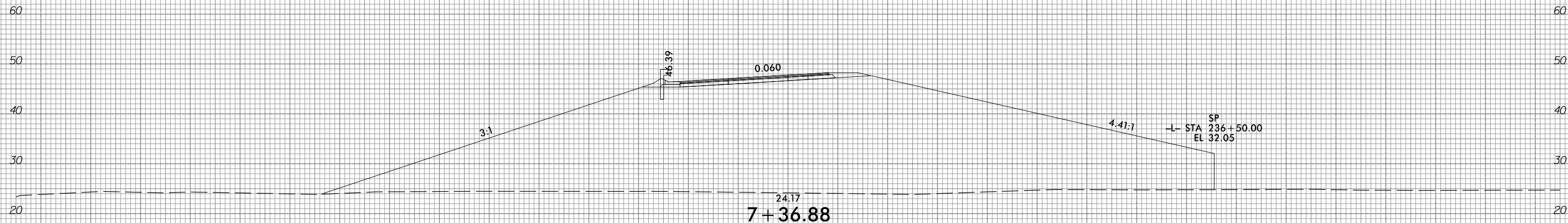

-Y3RPB-

150 140 130 120 110 100 90 80 70 60 50 40 30 20 10 0 10 20 30 40 50 60 70 80 90 100 110 120 130 140 150

10/31/2018  
 G:\RA\9729-02\CADD\1015\Roadway\XSC\1015\_xp1\_Y3RPB.dgn  
 gmc31in

6/23/16



PROJ. REFERENCE NO.
R-1015

SHEET NO.
X-356

150 140 130 120 110 100 90 80 70 60 50 40 30 20 10 0 10 20 30 40 50 60 70 80 90 100 110 120 130 140 150

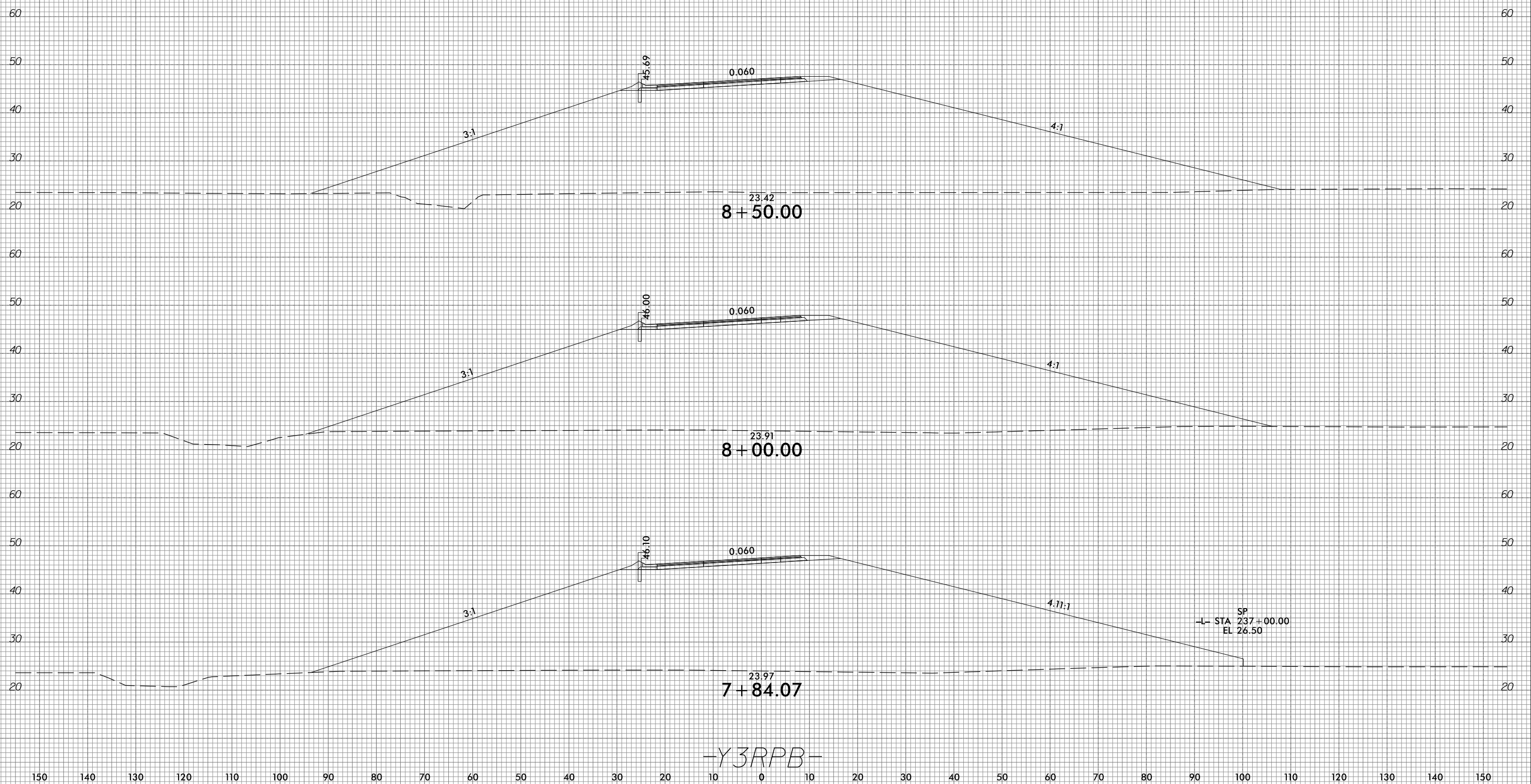

-Y3RPB-

10/31/2018  
G:\RA\9729-02\CADD\1015\Roadway\XSC\1015\_xp1\_Y3RPB.dgn  
gncdlin

6/23/16



PROJ. REFERENCE NO.
R-1015

SHEET NO.
X-357

150 140 130 120 110 100 90 80 70 60 50 40 30 20 10 0 10 20 30 40 50 60 70 80 90 100 110 120 130 140 150

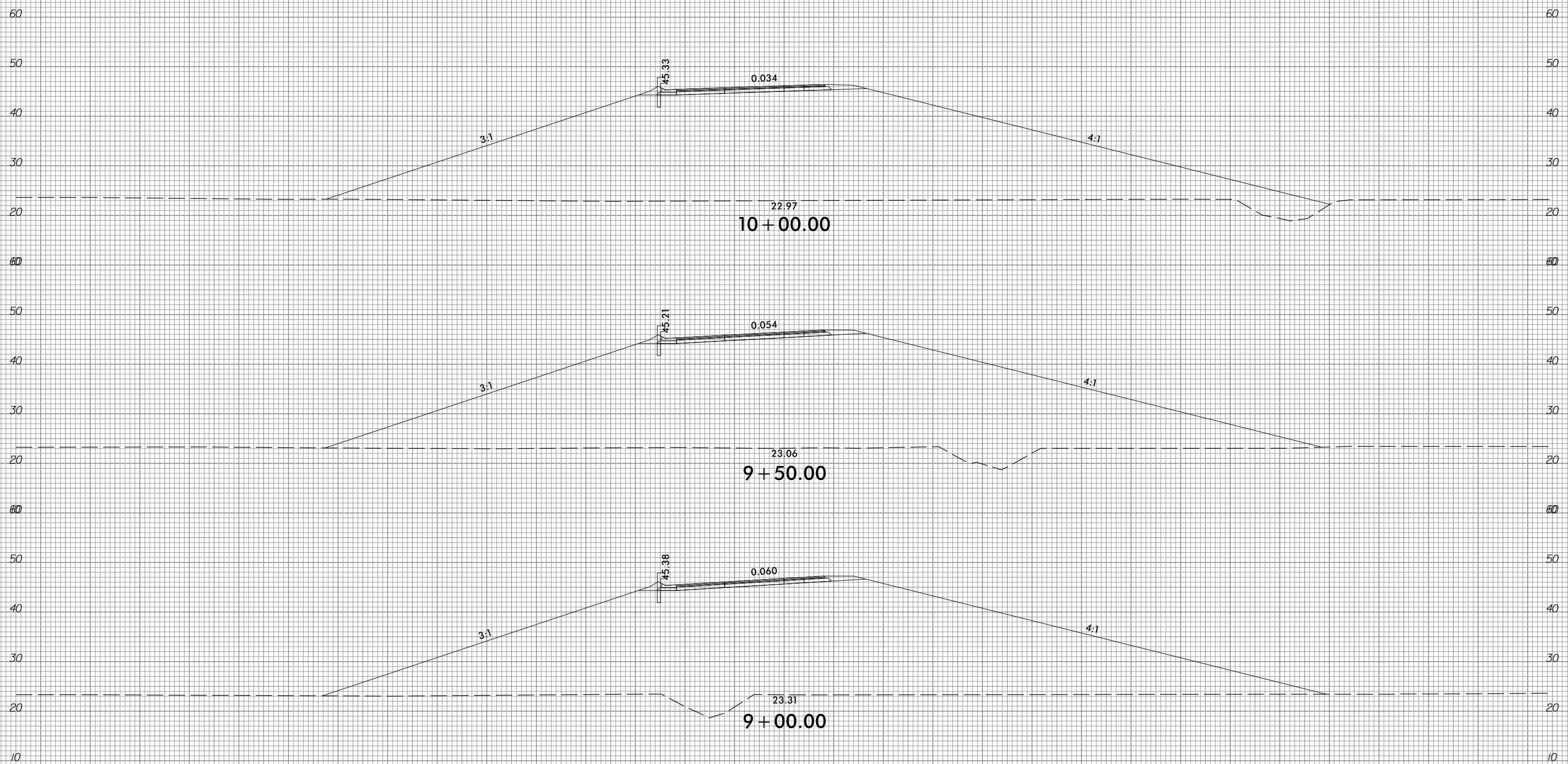

-Y3RPB-

150 140 130 120 110 100 90 80 70 60 50 40 30 20 10 0 10 20 30 40 50 60 70 80 90 100 110 120 130 140 150

10/31/2018  
 G:\RA\9729-02\CAD\1015\Roadway\XSC\1015\_xp1\_Y3RPB.dgn  
 gncdlin

6/23/16



PROJ. REFERENCE NO.	SHEET NO.
R-1015	X-358

150 140 130 120 110 100 90 80 70 60 50 40 30 20 10 0 10 20 30 40 50 60 70 80 90 100 110 120 130 140 150

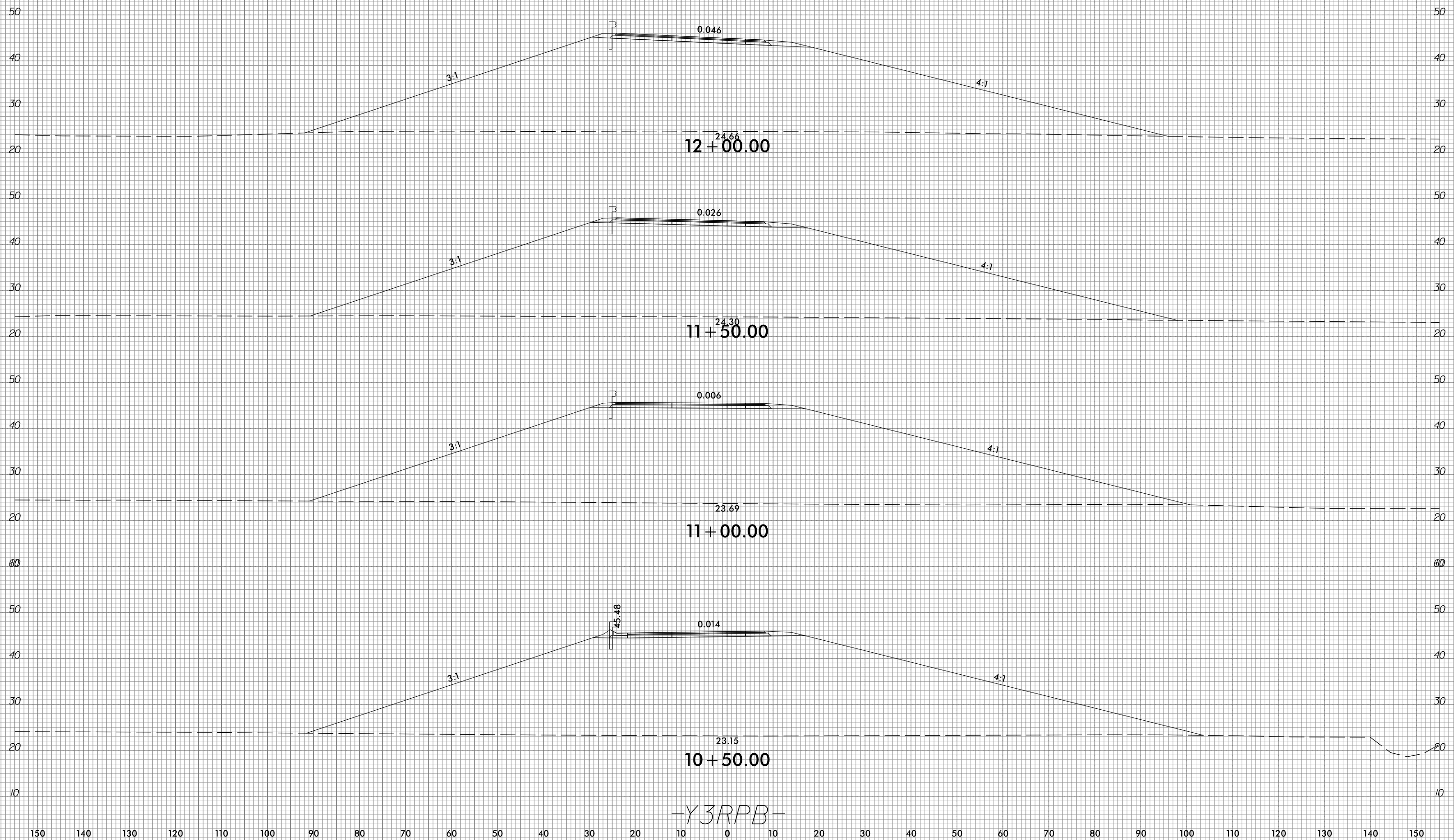

-Y3RPB-

10/31/2018  
 G:\RA\9729-02\CADD\1015\Roadway\XSC\1015\_xp1\_Y3RPB.dgn  
 gmc31in



6/23/16



PROJ. REFERENCE NO.  
R-1015

SHEET NO.  
X-359

150 140 130 120 110 100 90 80 70 60 50 40 30 20 10 0 10 20 30 40 50 60 70 80 90 100 110 120 130 140 150

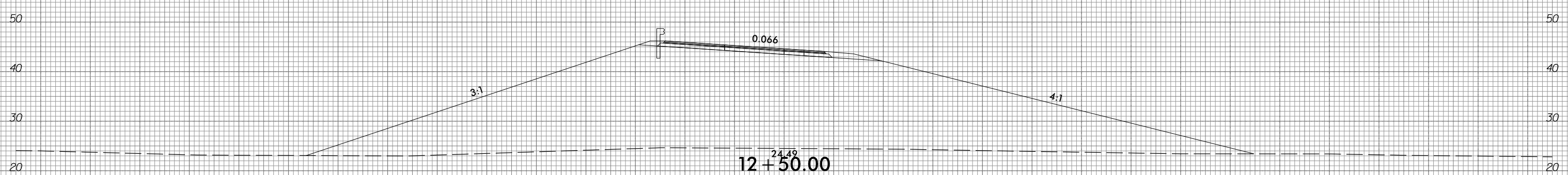
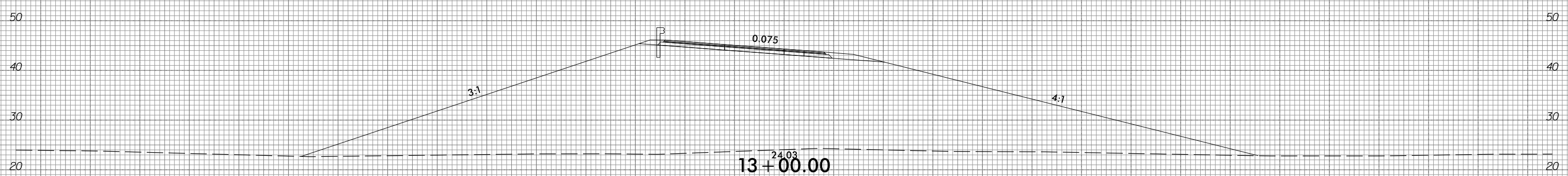
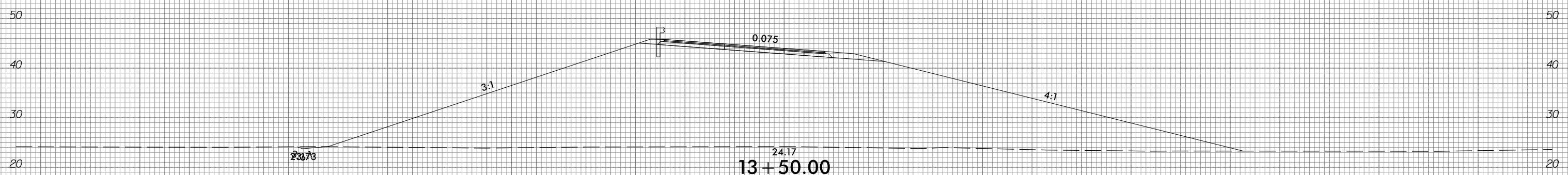
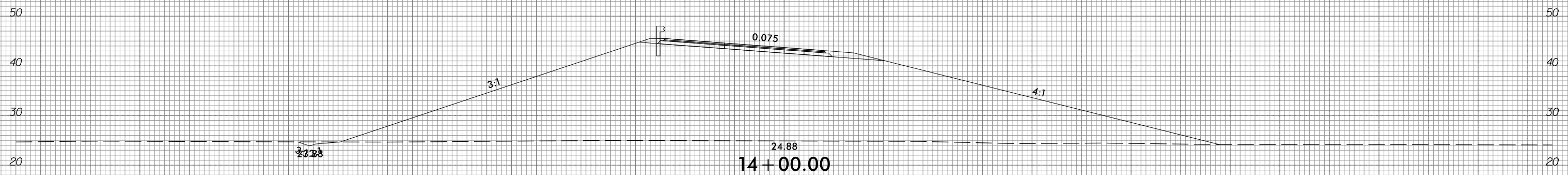

-Y3RPB-

150 140 130 120 110 100 90 80 70 60 50 40 30 20 10 0 10 20 30 40 50 60 70 80 90 100 110 120 130 140 150

10/31/2018  
G:\RA\9729-02\CADD\1015\Roadway\XSC\1015\_xp1\_Y3RPB.dgn  
gncdlin

6/23/16



PROJ. REFERENCE NO.  
R-1015

SHEET NO.  
X-360

150 140 130 120 110 100 90 80 70 60 50 40 30 20 10 0 10 20 30 40 50 60 70 80 90 100 110 120 130 140 150

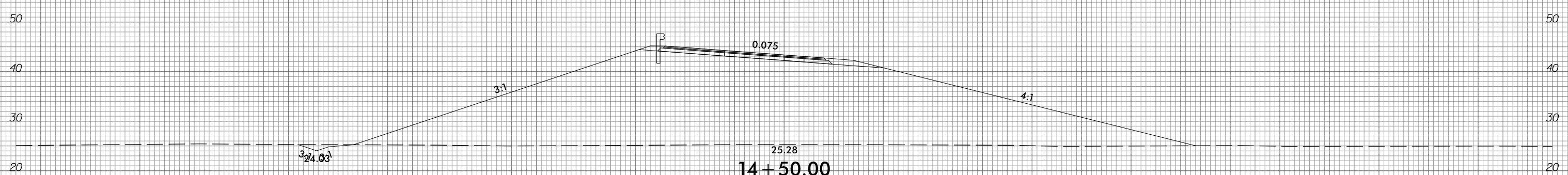
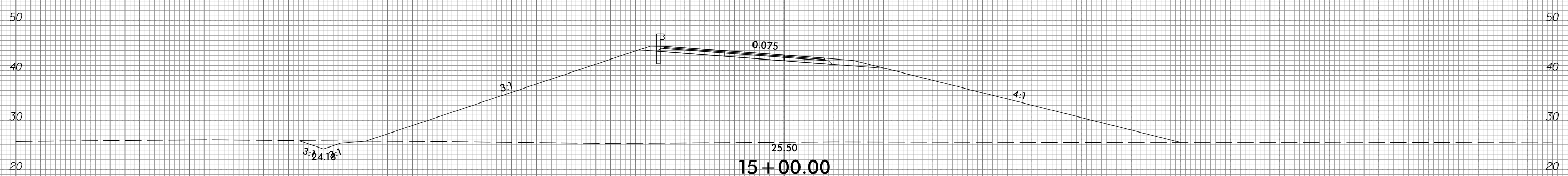
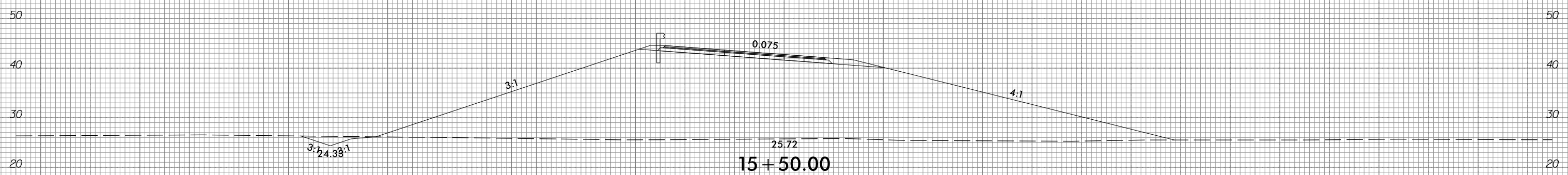
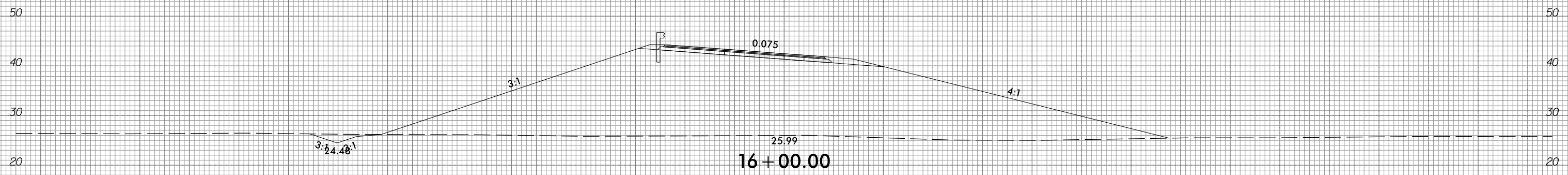

-Y3RPB-

150 140 130 120 110 100 90 80 70 60 50 40 30 20 10 0 10 20 30 40 50 60 70 80 90 100 110 120 130 140 150

10/31/2018  
G:\RA\9729-02\CADD\1015\Roadway\XSC\1015\_xp1\_Y3RPB.dgn  
gncdlin

6/23/16



PROJ. REFERENCE NO.  
R-1015

SHEET NO.  
X-361

150 140 130 120 110 100 90 80 70 60 50 40 30 20 10 0 10 20 30 40 50 60 70 80 90 100 110 120 130 140 150

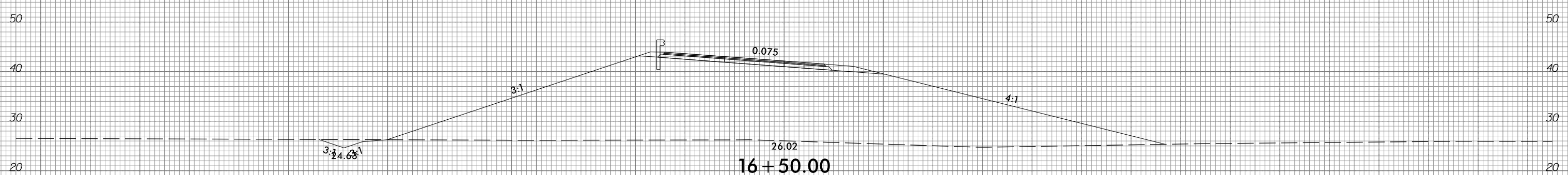
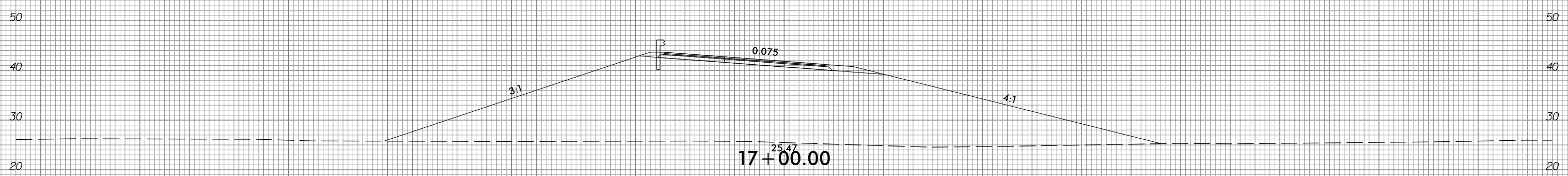
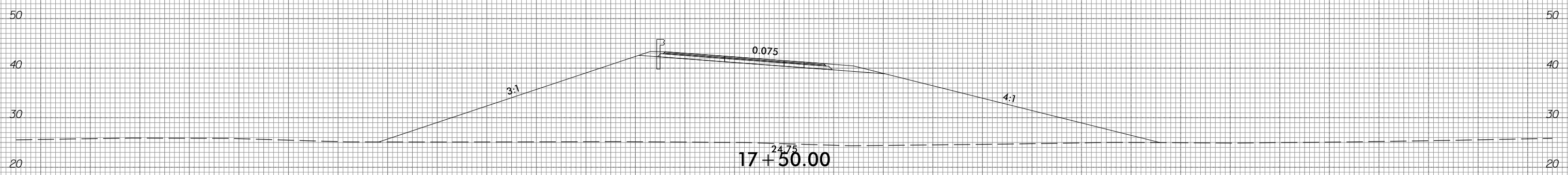
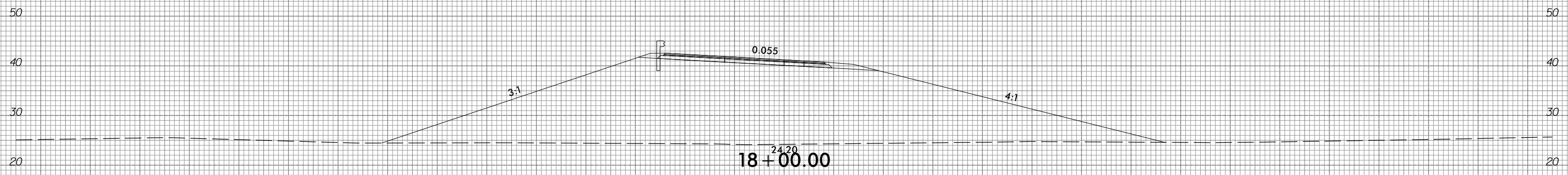

-Y3RPB-

150 140 130 120 110 100 90 80 70 60 50 40 30 20 10 0 10 20 30 40 50 60 70 80 90 100 110 120 130 140 150

10/31/2018  
G:\RA\9729-02\CADD\1015\Roadway\XSC\1015\_xp1\_Y3RPB.dgn  
gncdlin

6/23/16



PROJ. REFERENCE NO.  
R-1015

SHEET NO.  
X-362

150 140 130 120 110 100 90 80 70 60 50 40 30 20 10 0 10 20 30 40 50 60 70 80 90 100 110 120 130 140 150

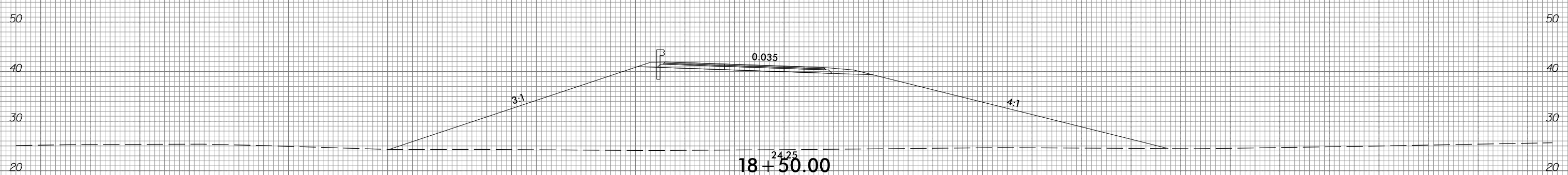
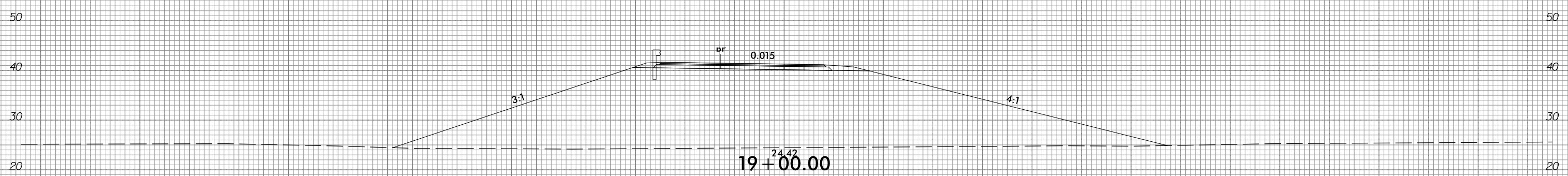
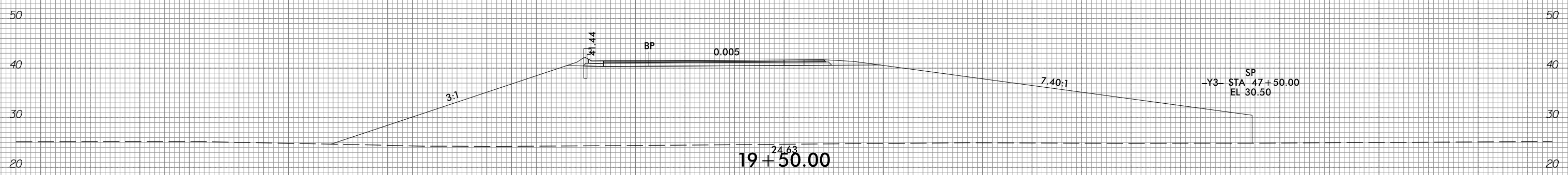
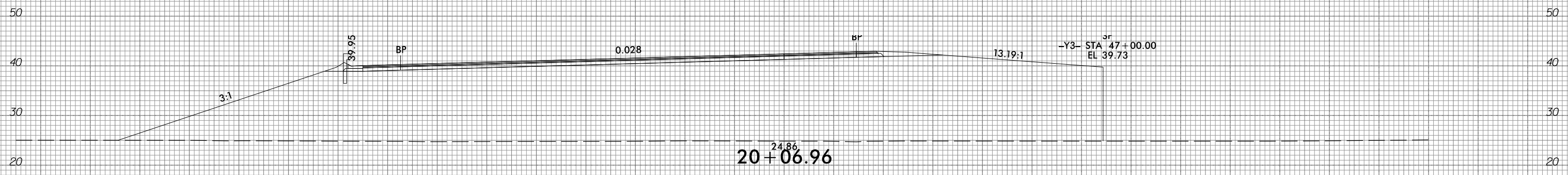

-Y3RPB-

150 140 130 120 110 100 90 80 70 60 50 40 30 20 10 0 10 20 30 40 50 60 70 80 90 100 110 120 130 140 150

10/31/2018  
G:\RA\9729-02\CADD\1015\Roadway\XSC\1015\_xp1\_Y3RPB.dgn  
gncdlin

6/23/16



PROJ. REFERENCE NO.  
R-1015

SHEET NO.  
X-363

150 140 130 120 110 100 90 80 70 60 50 40 30 20 10 0 10 20 30 40 50 60 70 80 90 100 110 120 130 140 150

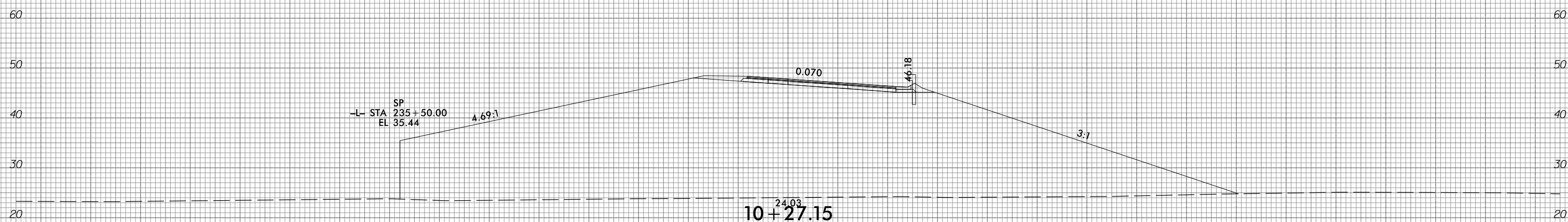
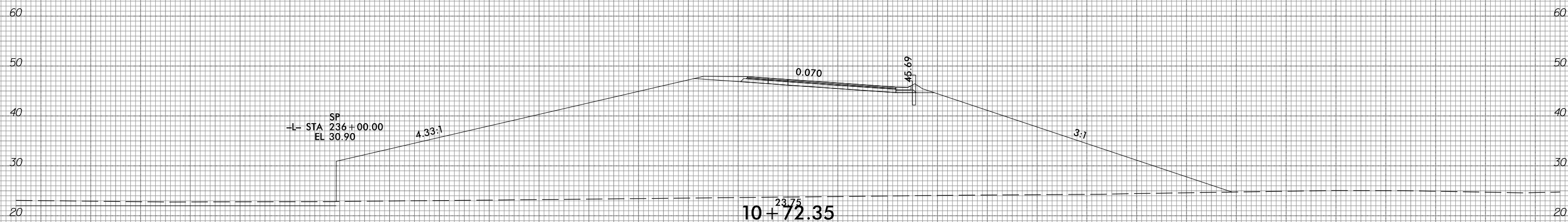
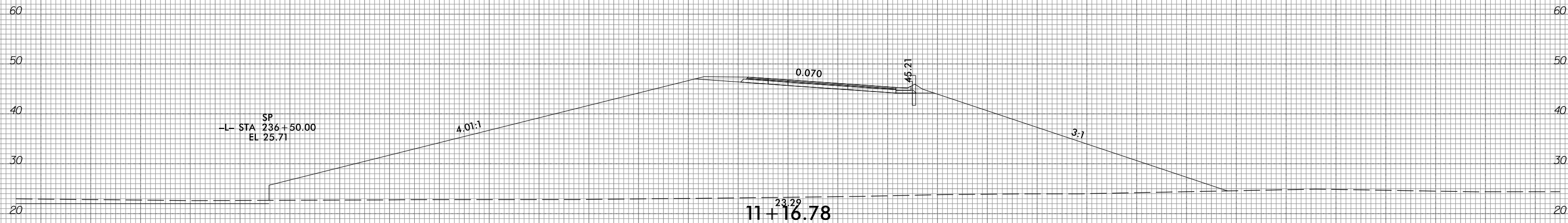

-Y3RPC-

150 140 130 120 110 100 90 80 70 60 50 40 30 20 10 0 10 20 30 40 50 60 70 80 90 100 110 120 130 140 150

10/31/2018  
G:\RA\9729-02\CADD\1015\Roadway\XSC\1015\_xp1\_Y3RPC.dgn  
gncdlin

6/23/16



PROJ. REFERENCE NO.	R-1015
---------------------	--------

SHEET NO.	X-364
-----------	-------

150 140 130 120 110 100 90 80 70 60 50 40 30 20 10 0 10 20 30 40 50 60 70 80 90 100 110 120 130 140 150

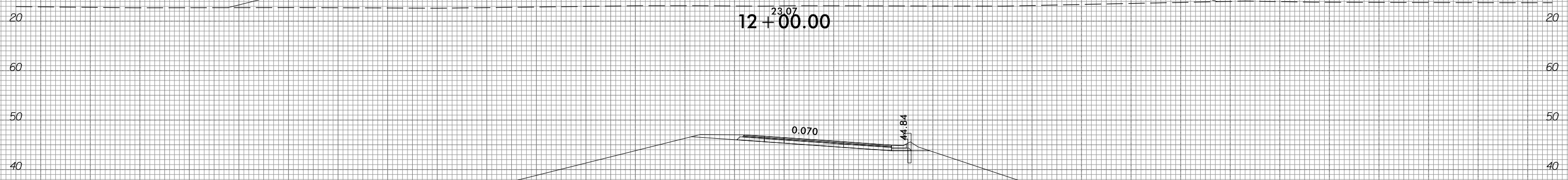
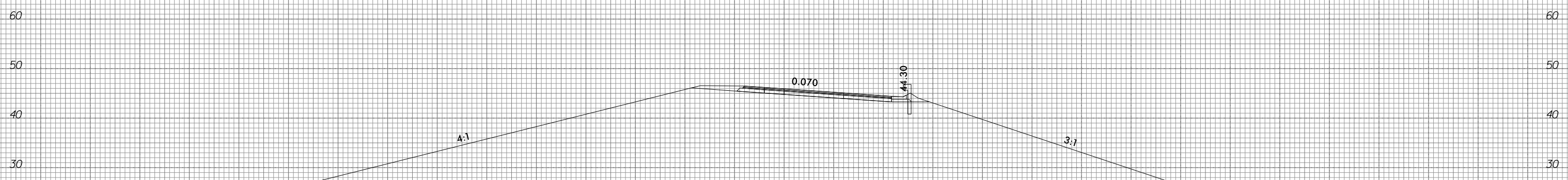
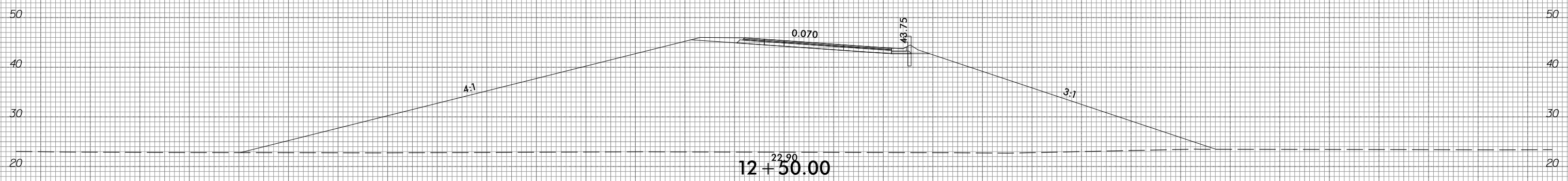
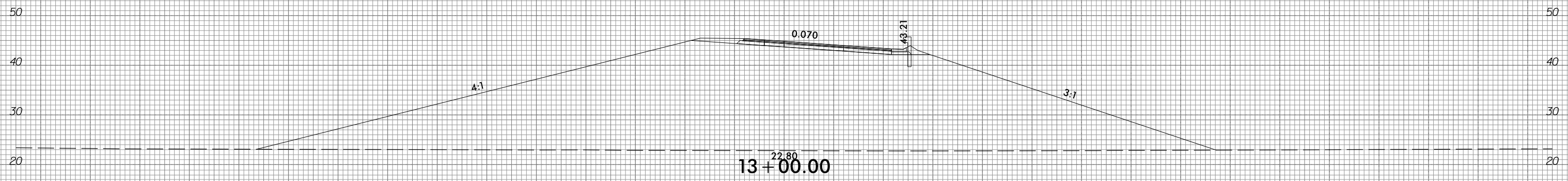

-Y3RPC-

150 140 130 120 110 100 90 80 70 60 50 40 30 20 10 0 10 20 30 40 50 60 70 80 90 100 110 120 130 140 150

10/31/2018  
 G:\RA\9729-02\CADD\1015\Roadway\XSC\1015\_xp1\_Y3RPC.dgn  
 gmc31in

6/23/16



PROJ. REFERENCE NO.  
R-1015

SHEET NO.  
X-365

150 140 130 120 110 100 90 80 70 60 50 40 30 20 10 0 10 20 30 40 50 60 70 80 90 100 110 120 130 140 150

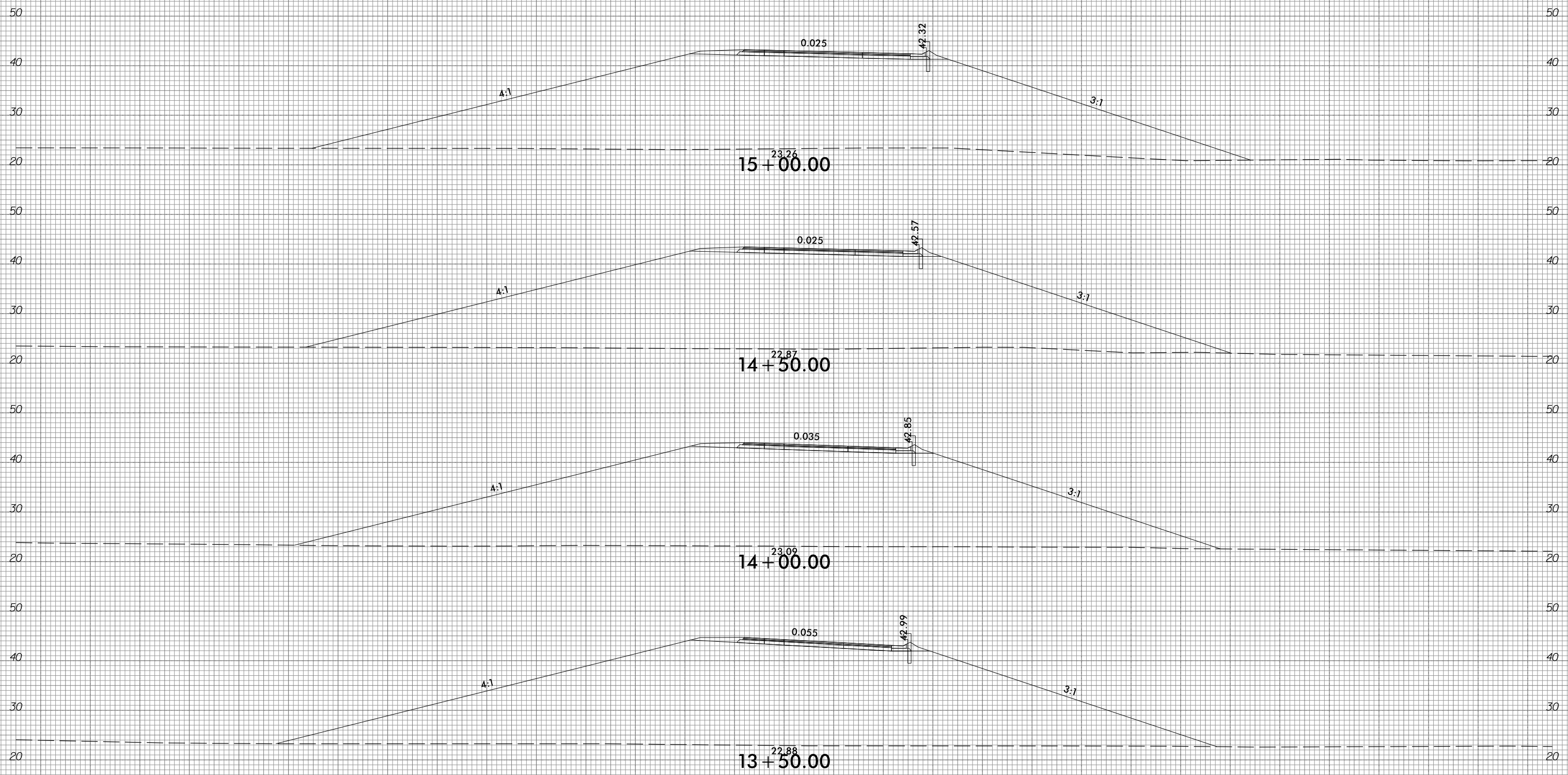

-Y3RPC-

10/31/2018  
G:\RA\9729-02\CADD\1015\Roadway\XSC\1015\_xp1\_Y3RPC.dgn  
gncdlin

6/23/16



PROJ. REFERENCE NO.  
R-1015

SHEET NO.  
X-366

150 140 130 120 110 100 90 80 70 60 50 40 30 20 10 0 10 20 30 40 50 60 70 80 90 100 110 120 130 140 150

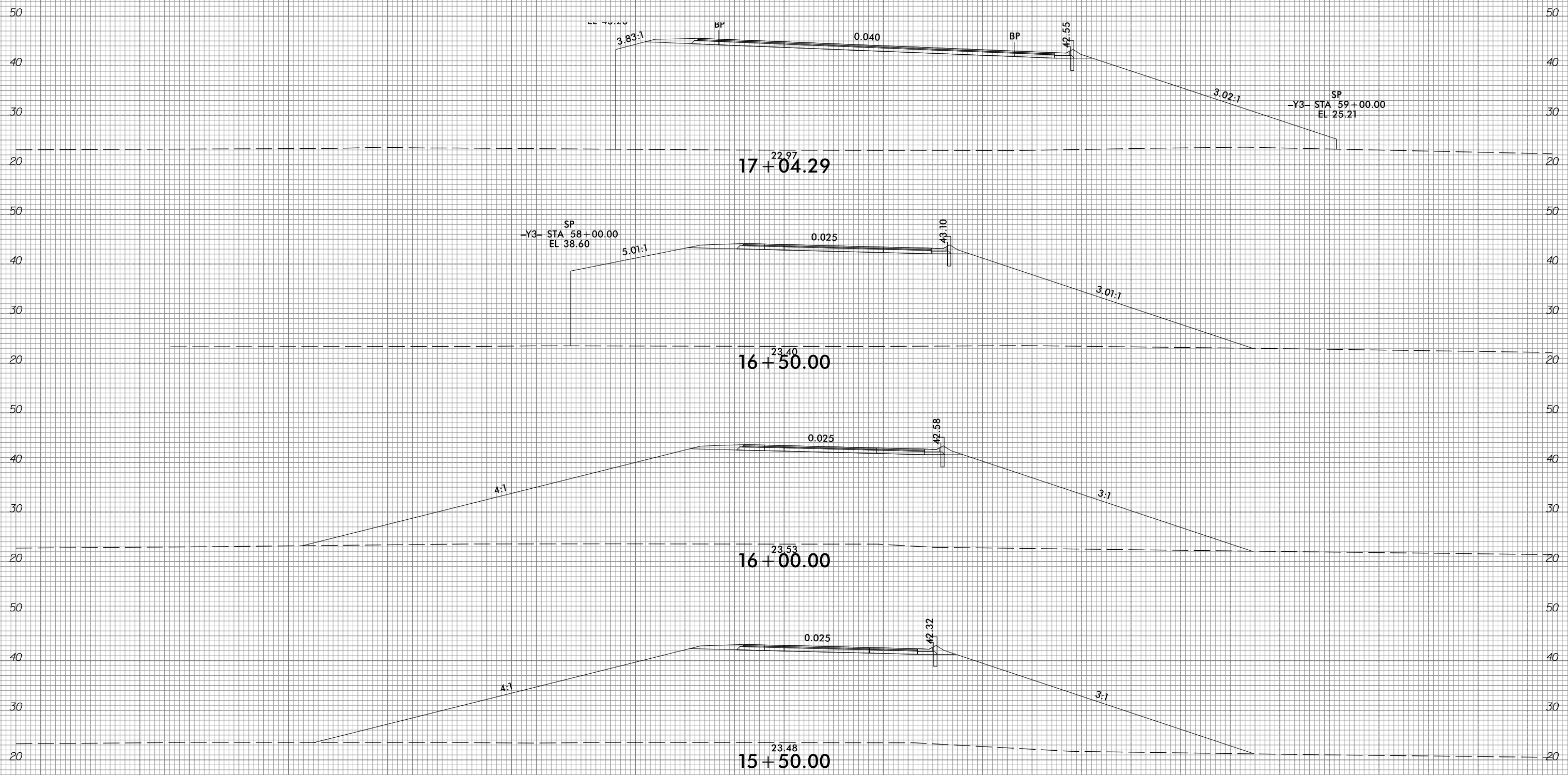

-Y3RPC-

10/31/2018  
G:\RA\9729-02\CADD\1015\Roadway\XSC\1015\_xp1\_Y3RPC.dgn  
gncdlin



6/23/16



PROJ. REFERENCE NO.  
R-1015

SHEET NO.  
X-367

150 140 130 120 110 100 90 80 70 60 50 40 30 20 10 0 10 20 30 40 50 60 70 80 90 100 110 120 130 140 150

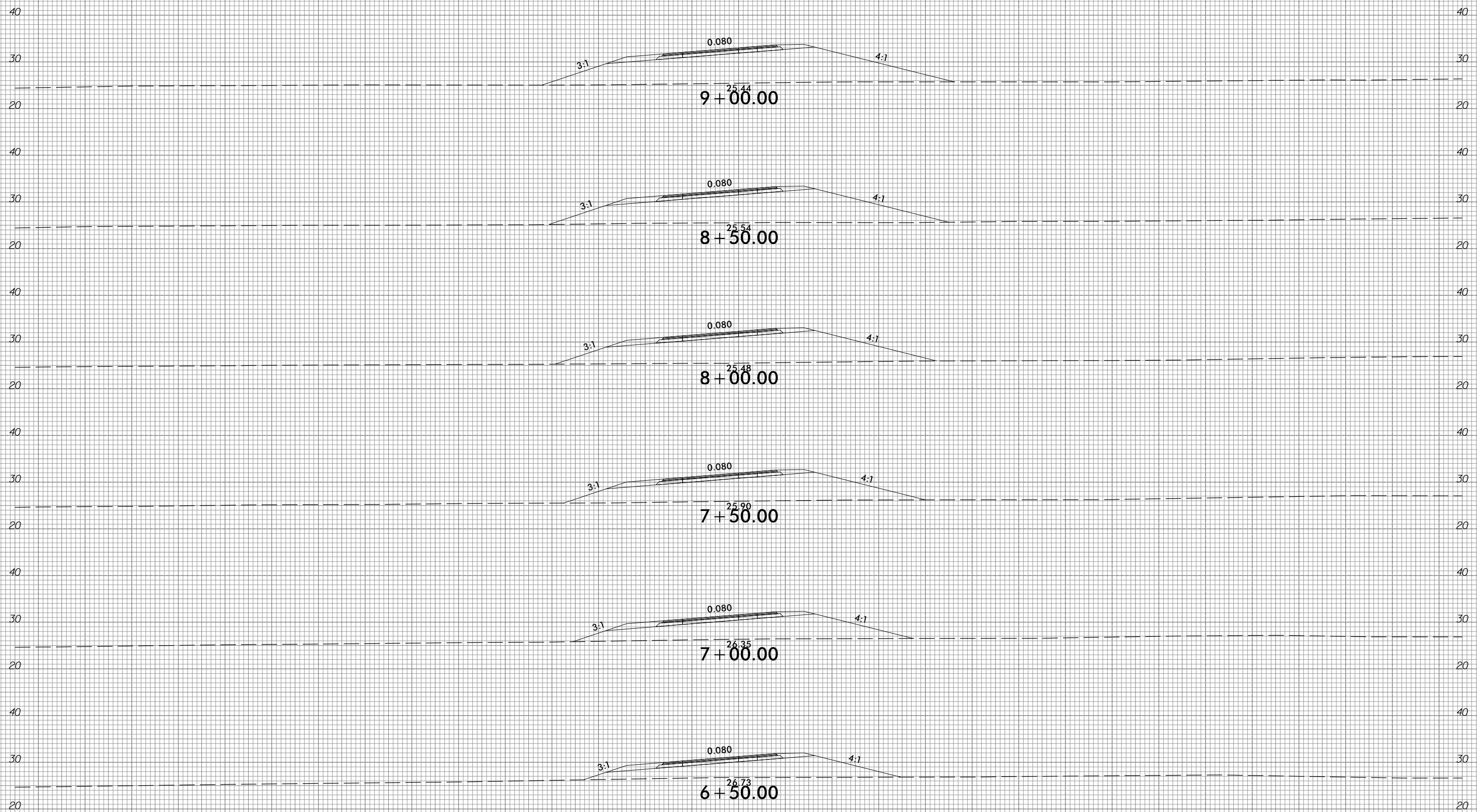

-Y3RPD-

150 140 130 120 110 100 90 80 70 60 50 40 30 20 10 0 10 20 30 40 50 60 70 80 90 100 110 120 130 140 150

10/31/2018  
G:\RA\9729-02\CADD\1015\Roadway\XSC\1015\_xp1\_Y3RPD.dgn  
gncdlin

6/23/16

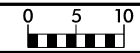

PROJ. REFERENCE NO.  
R-1015

SHEET NO.  
X-368

150 140 130 120 110 100 90 80 70 60 50 40 30 20 10 0 10 20 30 40 50 60 70 80 90 100 110 120 130 140 150

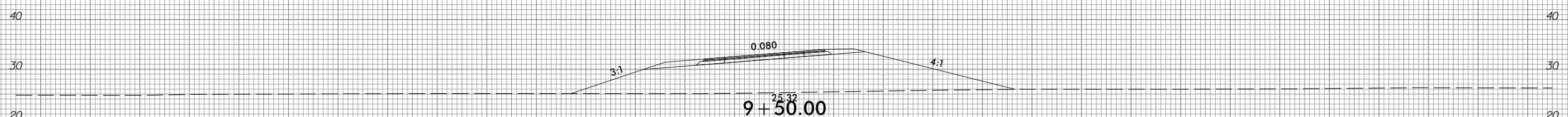
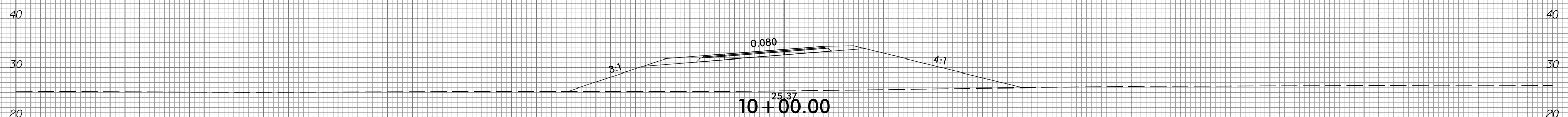
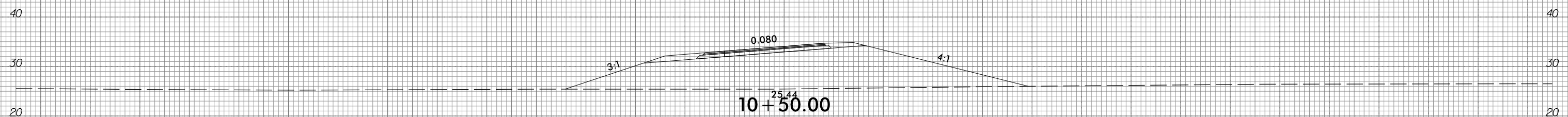
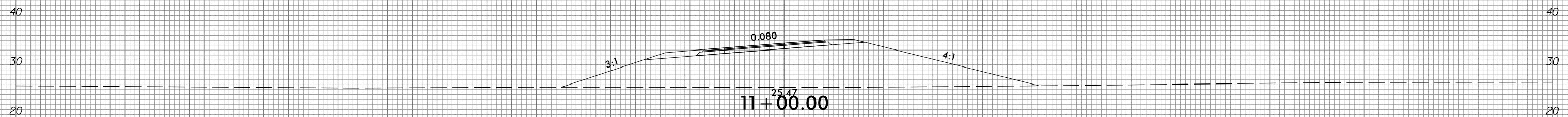
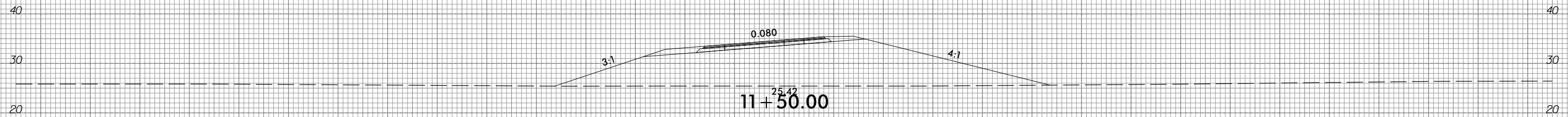
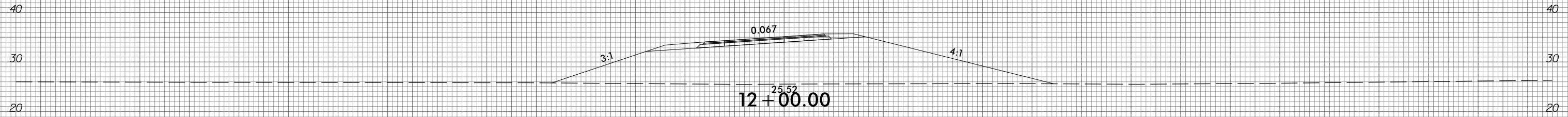

-Y3RPD-

150 140 130 120 110 100 90 80 70 60 50 40 30 20 10 0 10 20 30 40 50 60 70 80 90 100 110 120 130 140 150

10/31/2018  
G:\RA\9729-02\CADD\1015\Roadway\XSC\1015.sp1.Y3RPD.dgn  
gncdlin

6/23/16



PROJ. REFERENCE NO.  
R-1015

SHEET NO.  
X-369

150 140 130 120 110 100 90 80 70 60 50 40 30 20 10 0 10 20 30 40 50 60 70 80 90 100 110 120 130 140 150

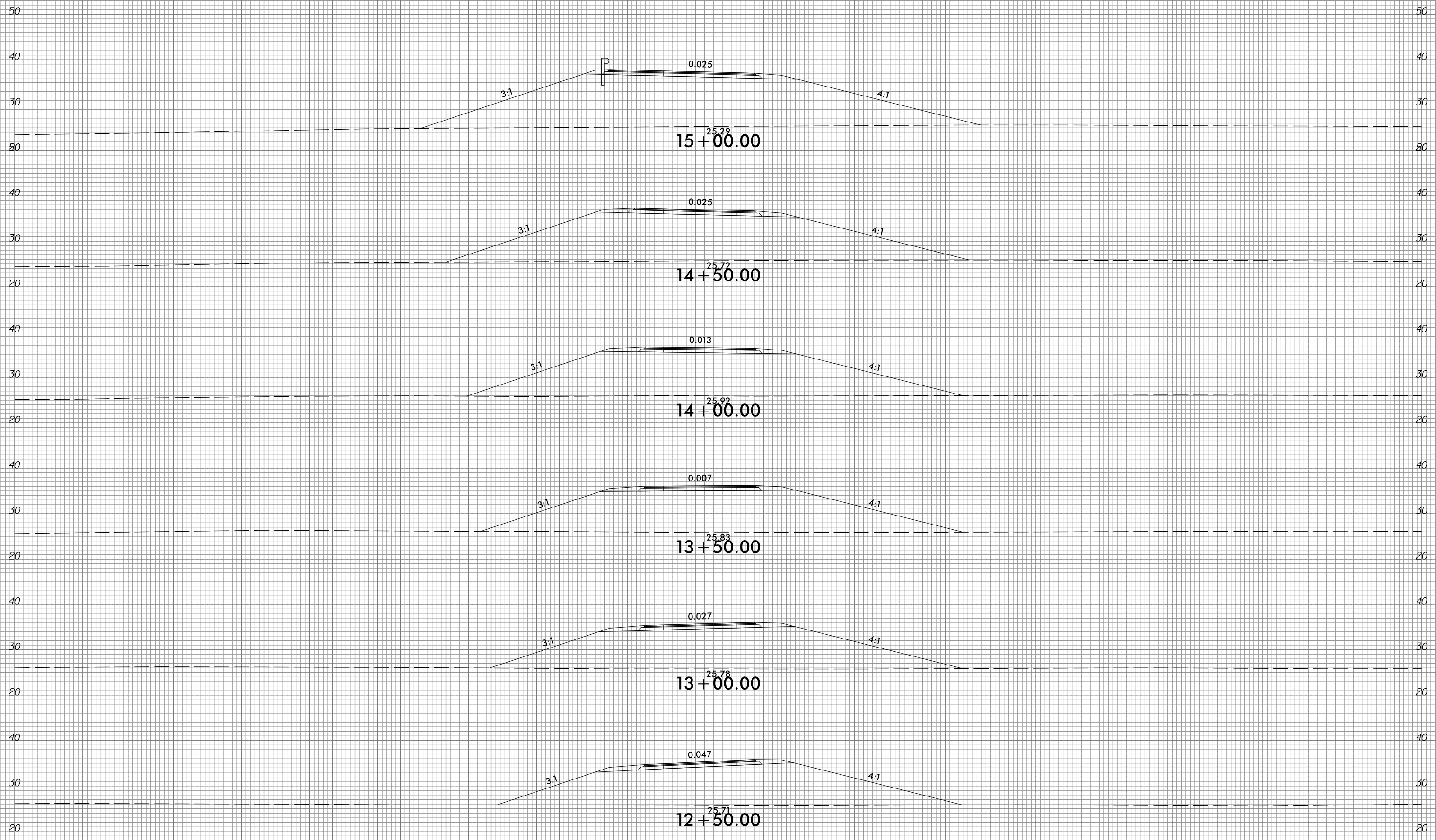

$12+50.00$   
25.71  
-Y3RPD-

150 140 130 120 110 100 90 80 70 60 50 40 30 20 10 0 10 20 30 40 50 60 70 80 90 100 110 120 130 140 150

10/31/2018  
G:\RA\1729-02\CADD\1015\Roadway\XSC\1015\_xp1\_Y3RPD.dgn  
gncdlin

6/23/16



PROJ. REFERENCE NO.	SHEET NO.
R-1015	X-370

150 140 130 120 110 100 90 80 70 60 50 40 30 20 10 0 10 20 30 40 50 60 70 80 90 100 110 120 130 140 150

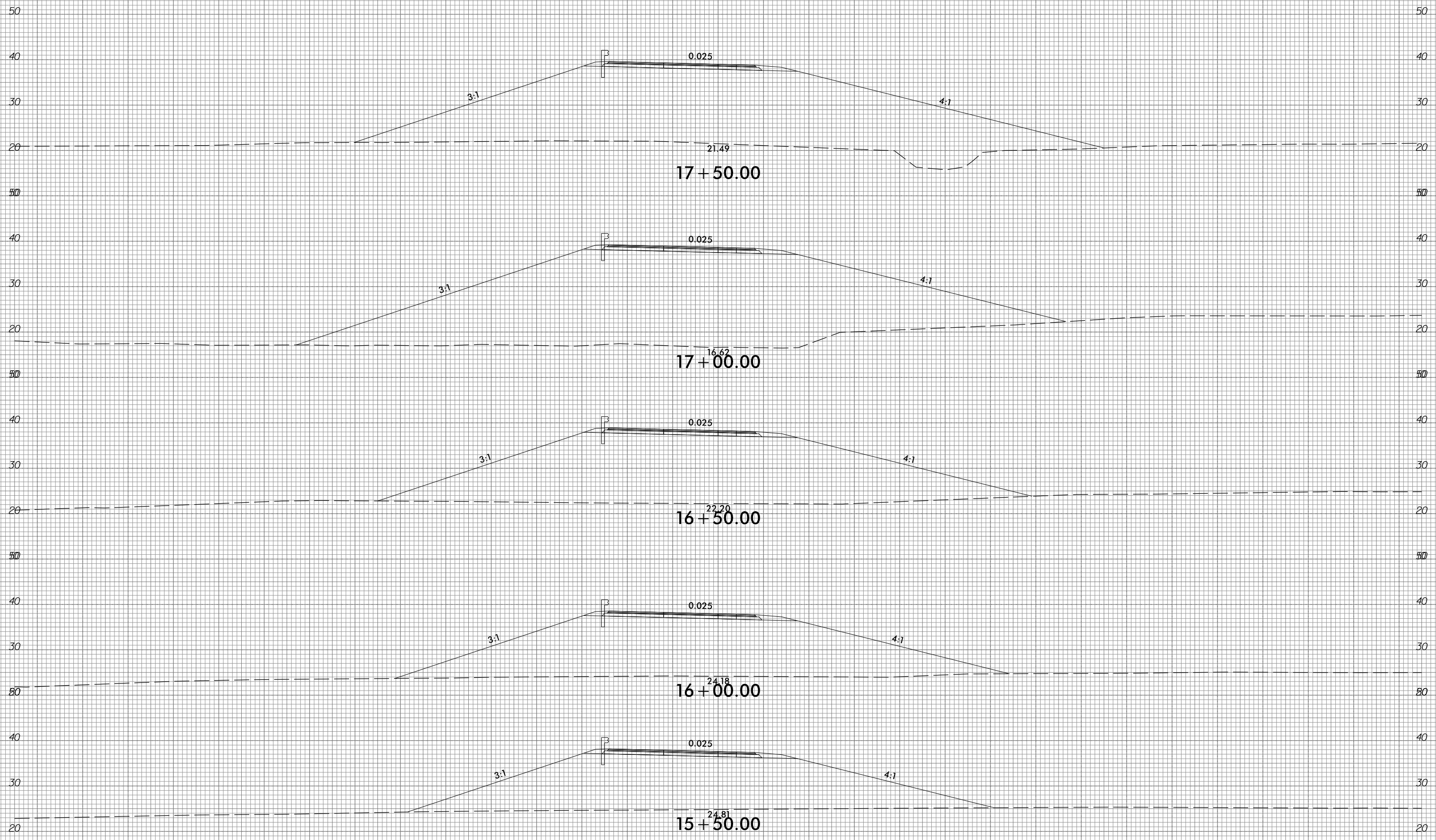

15+50.00  
-Y3RPD-

150 140 130 120 110 100 90 80 70 60 50 40 30 20 10 0 10 20 30 40 50 60 70 80 90 100 110 120 130 140 150

10/31/2018  
G:\RA\1729-02\CADD\1015\Roadway\XSC\1015\_xpl\_Y3RPD.dgn  
gncdlin

6/23/16



PROJ. REFERENCE NO.  
R-1015

SHEET NO.  
X-371

150 140 130 120 110 100 90 80 70 60 50 40 30 20 10 0 10 20 30 40 50 60 70 80 90 100 110 120 130 140 150

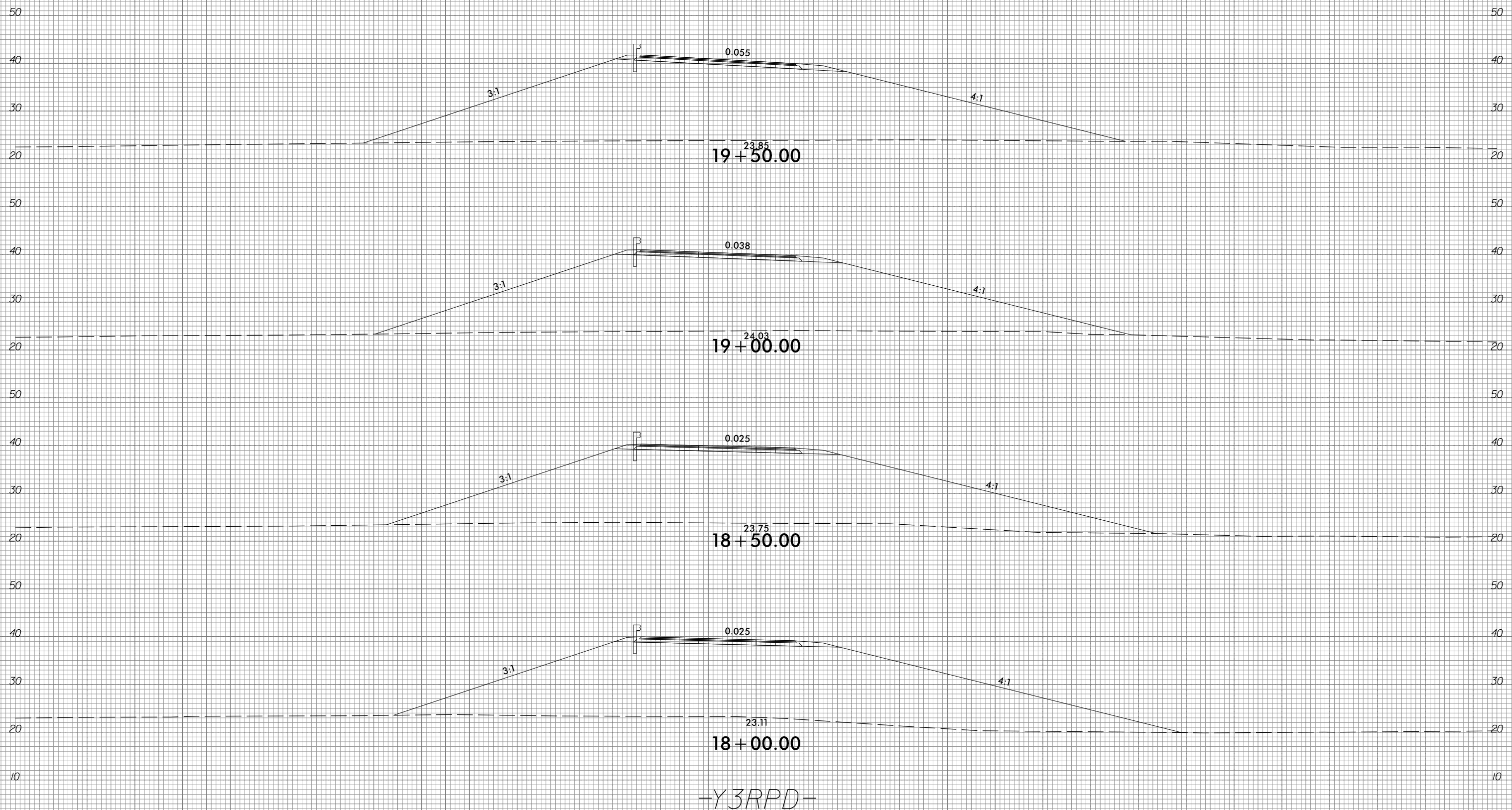

-Y3RPD-

10/31/2018  
G:\RA\9729-02\CADD\1015\Roadway\XSC\1015\_xp1\_Y3RPD.dgn  
gncdlin



150 140 130 120 110 100 90 80 70 60 50 40 30 20 10 0 10 20 30 40 50 60 70 80 90 100 110 120 130 140 150

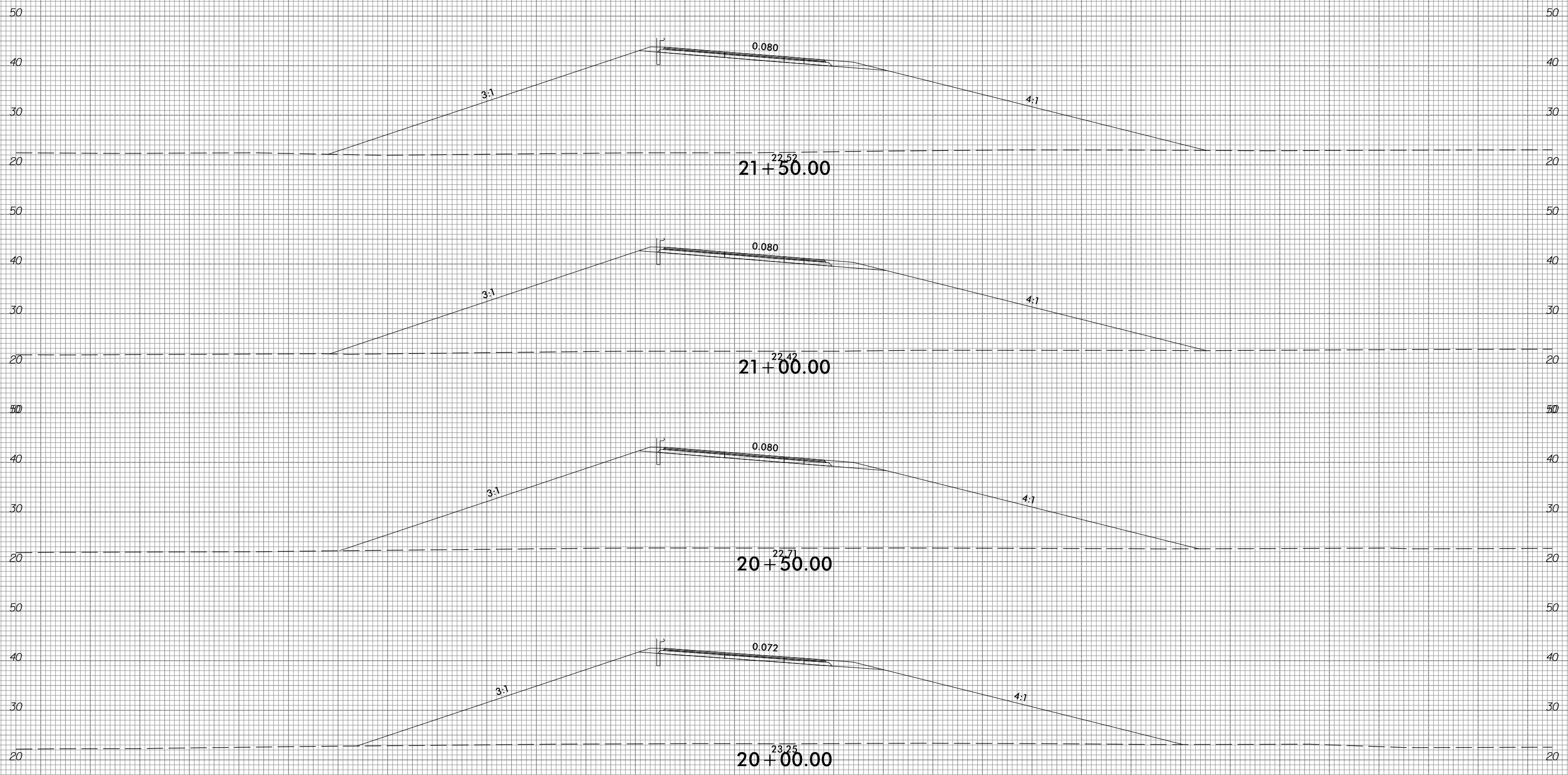

-Y3RPD-

6/23/16



PROJ. REFERENCE NO.
R-1015

SHEET NO.
X-373

150 140 130 120 110 100 90 80 70 60 50 40 30 20 10 0 10 20 30 40 50 60 70 80 90 100 110 120 130 140 150

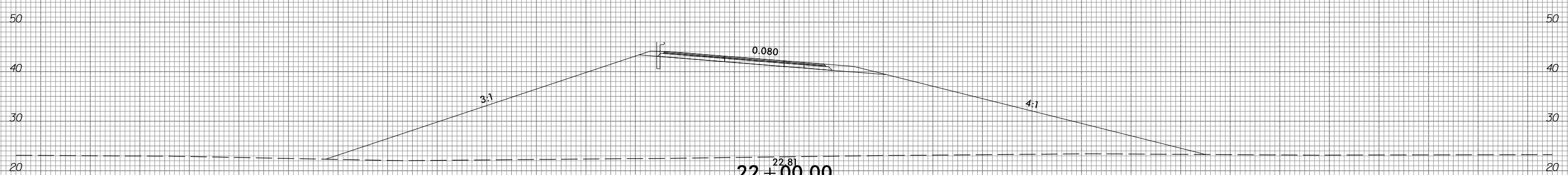
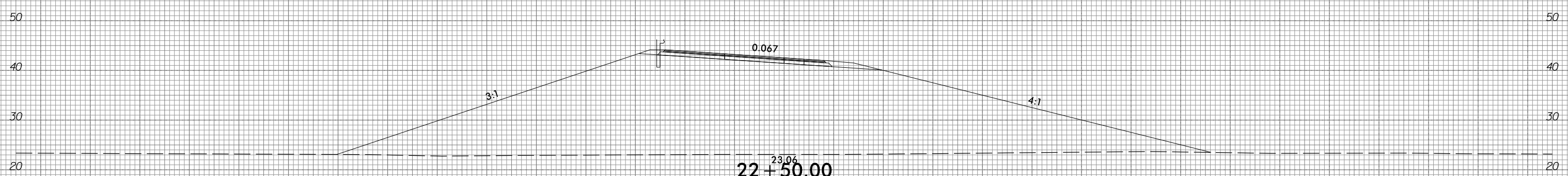
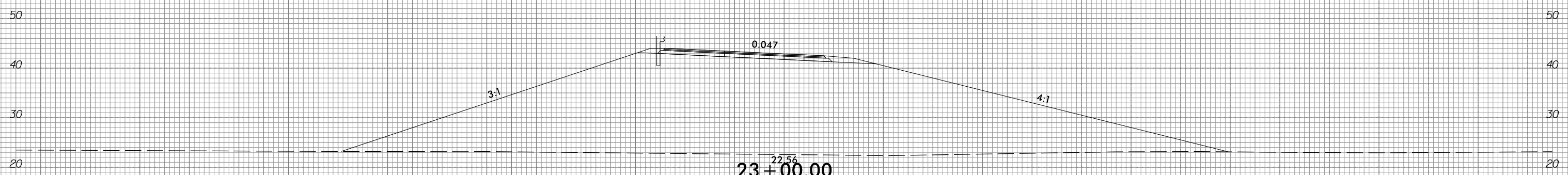
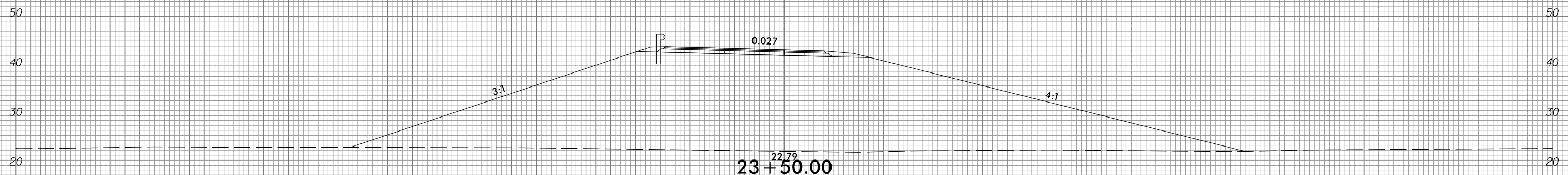

-Y3RPD-

150 140 130 120 110 100 90 80 70 60 50 40 30 20 10 0 10 20 30 40 50 60 70 80 90 100 110 120 130 140 150

10/31/2018  
 G:\RA\9729-02\CADD\1015\Roadway\XSC\1015\_xp1.Y3RPD.dgn  
 gmc31in

6/23/16



PROJ. REFERENCE NO.  
R-1015

SHEET NO.  
X-374

150 140 130 120 110 100 90 80 70 60 50 40 30 20 10 0 10 20 30 40 50 60 70 80 90 100 110 120 130 140 150

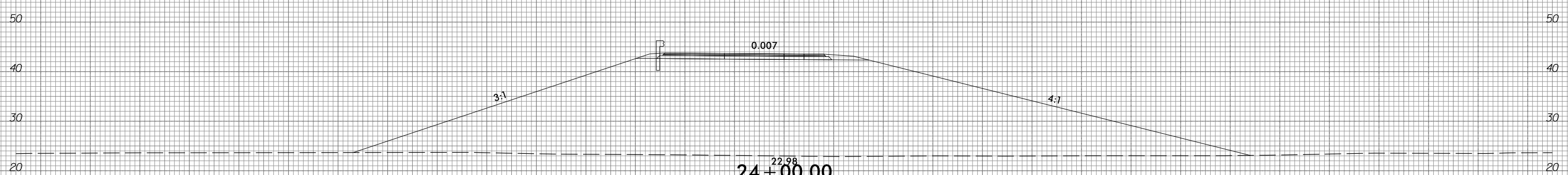
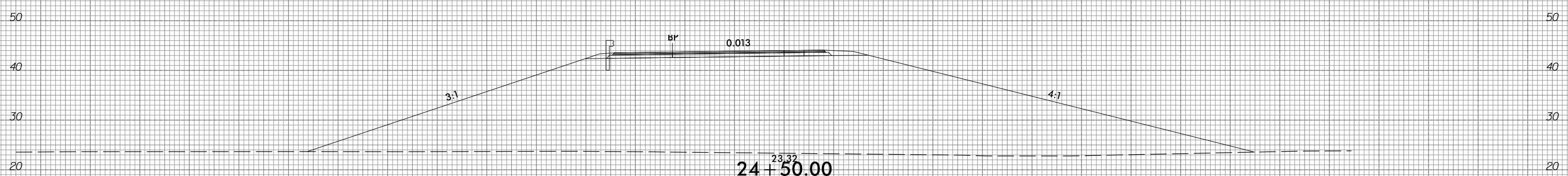
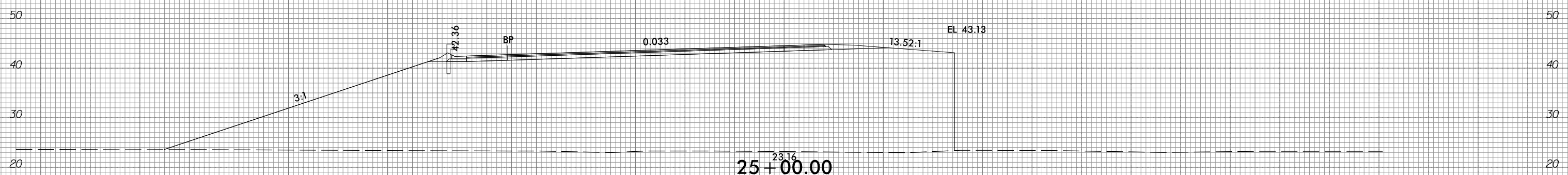

-Y3RPD-

150 140 130 120 110 100 90 80 70 60 50 40 30 20 10 0 10 20 30 40 50 60 70 80 90 100 110 120 130 140 150

10/31/2018  
G:\RA\9729-02\CADD\1015\Roadway\XSC\1015\_xp1\_Y3RPD.dgn  
gncdlin





150 140 130 120 110 100 90 80 70 60 50 40 30 20 10 0 10 20 30 40 50 60 70 80 90 100 110 120 130 140 150

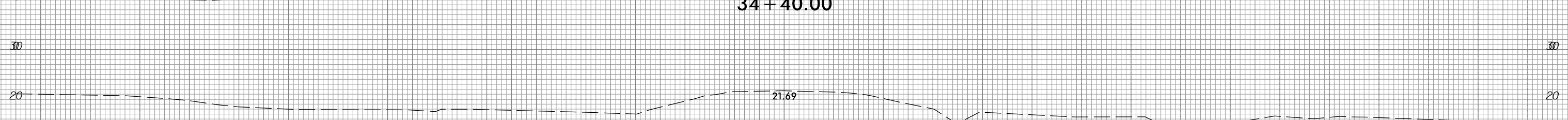
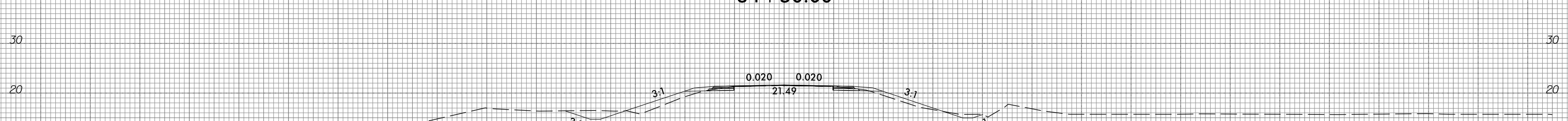
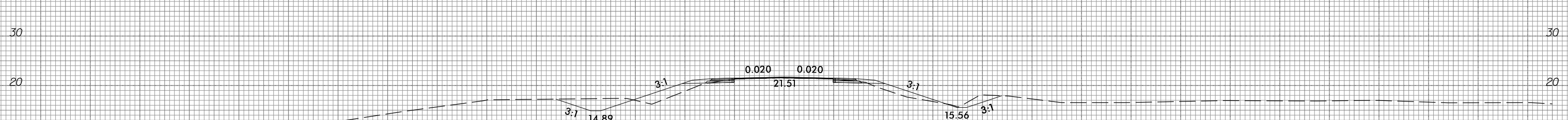
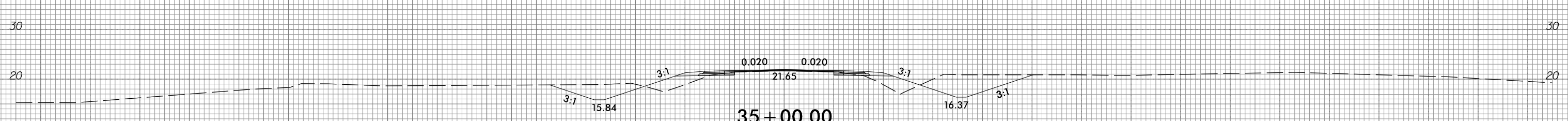
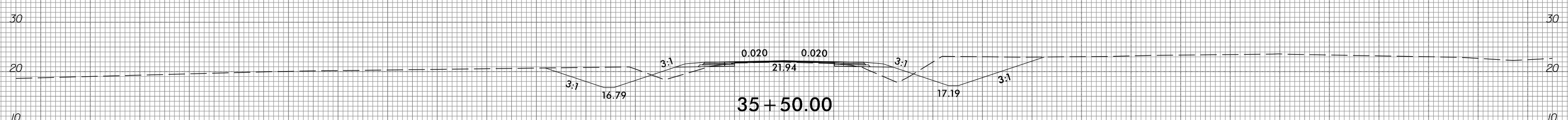
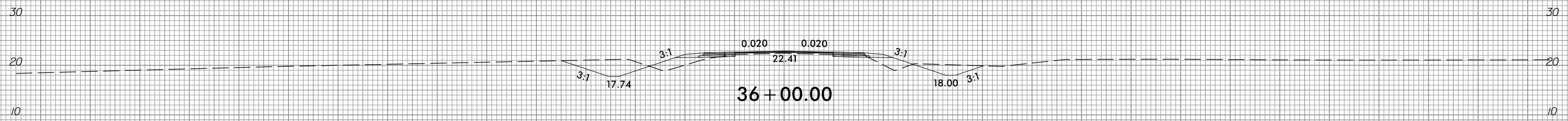

-Y4-

150 140 130 120 110 100 90 80 70 60 50 40 30 20 10 0 10 20 30 40 50 60 70 80 90 100 110 120 130 140 150

6/23/16



PROJ. REFERENCE NO.  
R-1015

SHEET NO.  
X-376

150 140 130 120 110 100 90 80 70 60 50 40 30 20 10 0 10 20 30 40 50 60 70 80 90 100 110 120 130 140 150

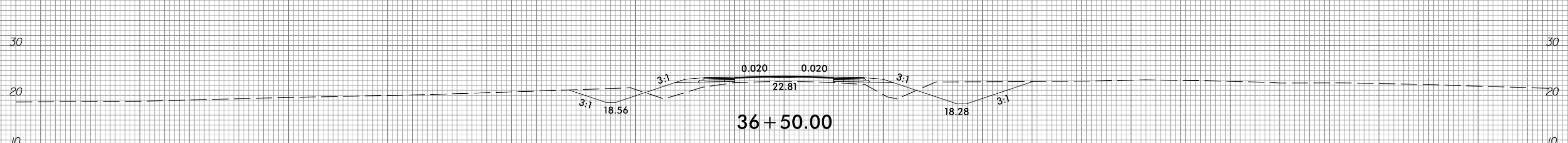
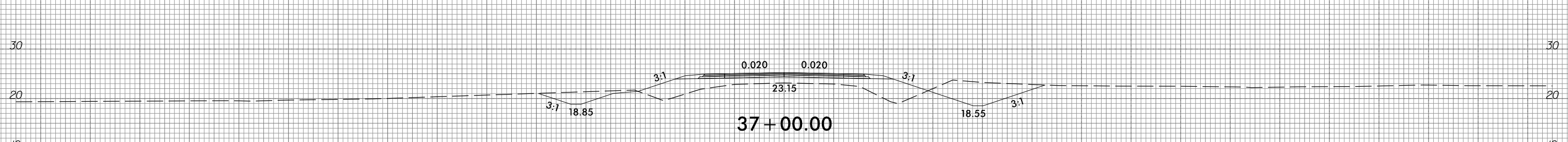
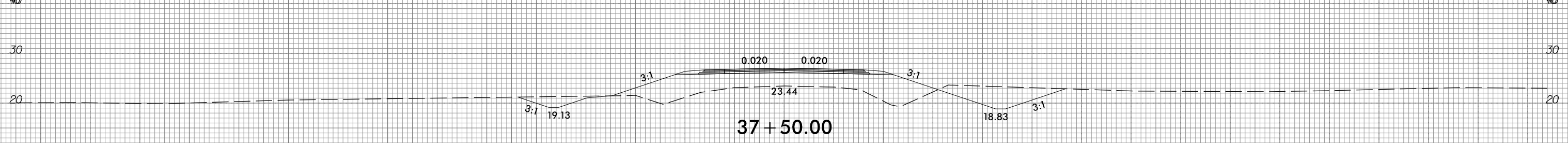
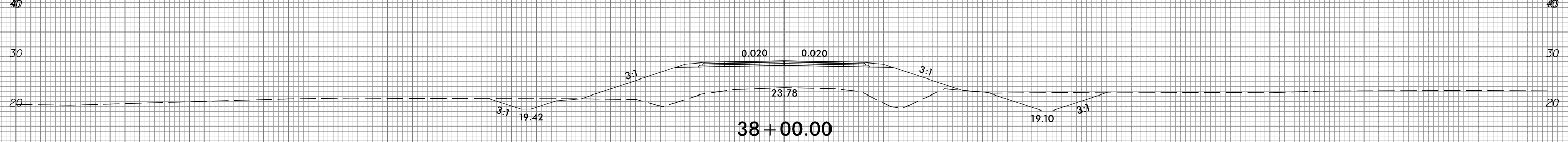
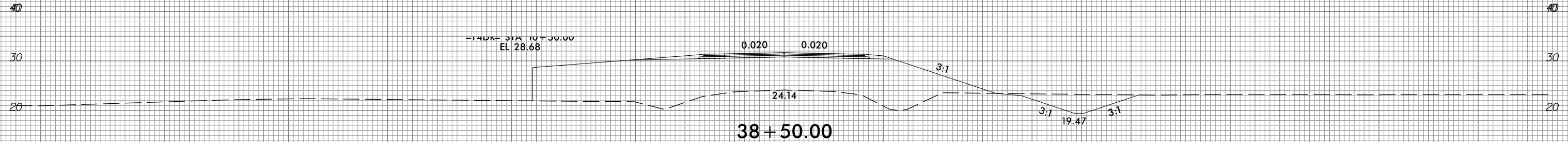
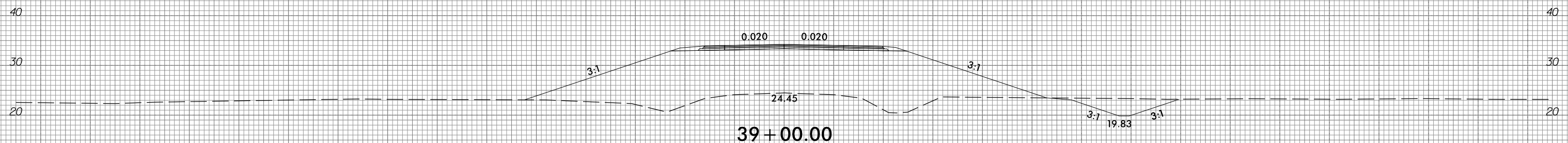

-Y4-

150 140 130 120 110 100 90 80 70 60 50 40 30 20 10 0 10 20 30 40 50 60 70 80 90 100 110 120 130 140 150

10/31/2018  
G:\RA\9729-02\CADD\1015\Roadway\XSC\1015\_xp1\_Y4.dgn  
gncdlin

6/23/16



PROJ. REFERENCE NO.  
R-1015

SHEET NO.  
X-377

150 140 130 120 110 100 90 80 70 60 50 40 30 20 10 0 10 20 30 40 50 60 70 80 90 100 110 120 130 140 150

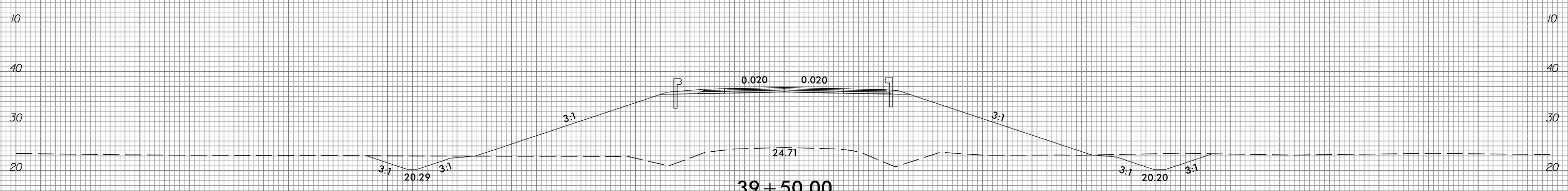
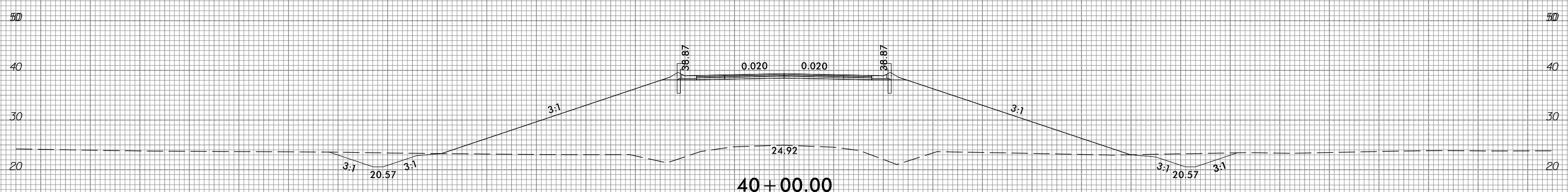
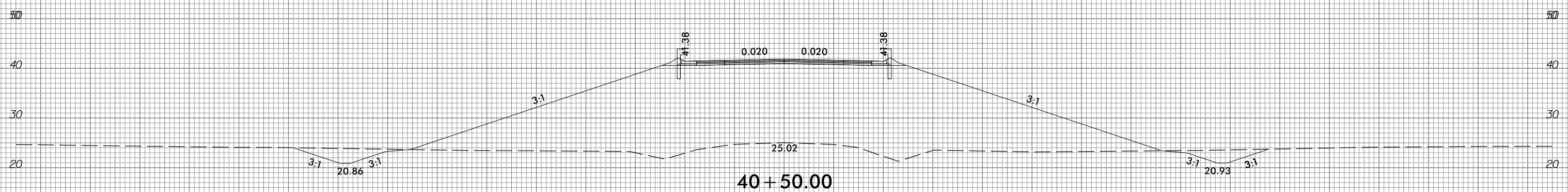
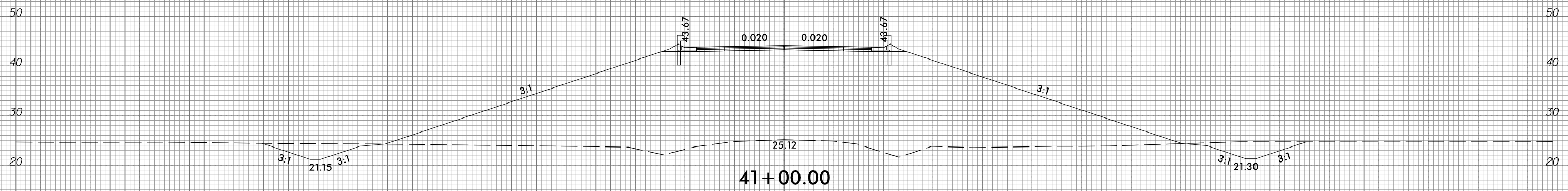

-Y4-

150 140 130 120 110 100 90 80 70 60 50 40 30 20 10 0 10 20 30 40 50 60 70 80 90 100 110 120 130 140 150

10/31/2018  
G:\RA\9729-02\CADD\1015\Roadway\XSC\1015\_xp1\_Y4.dgn  
gncdlin

6/23/16



PROJ. REFERENCE NO.
R-1015

SHEET NO.
X-378

150 140 130 120 110 100 90 80 70 60 50 40 30 20 10 0 10 20 30 40 50 60 70 80 90 100 110 120 130 140 150

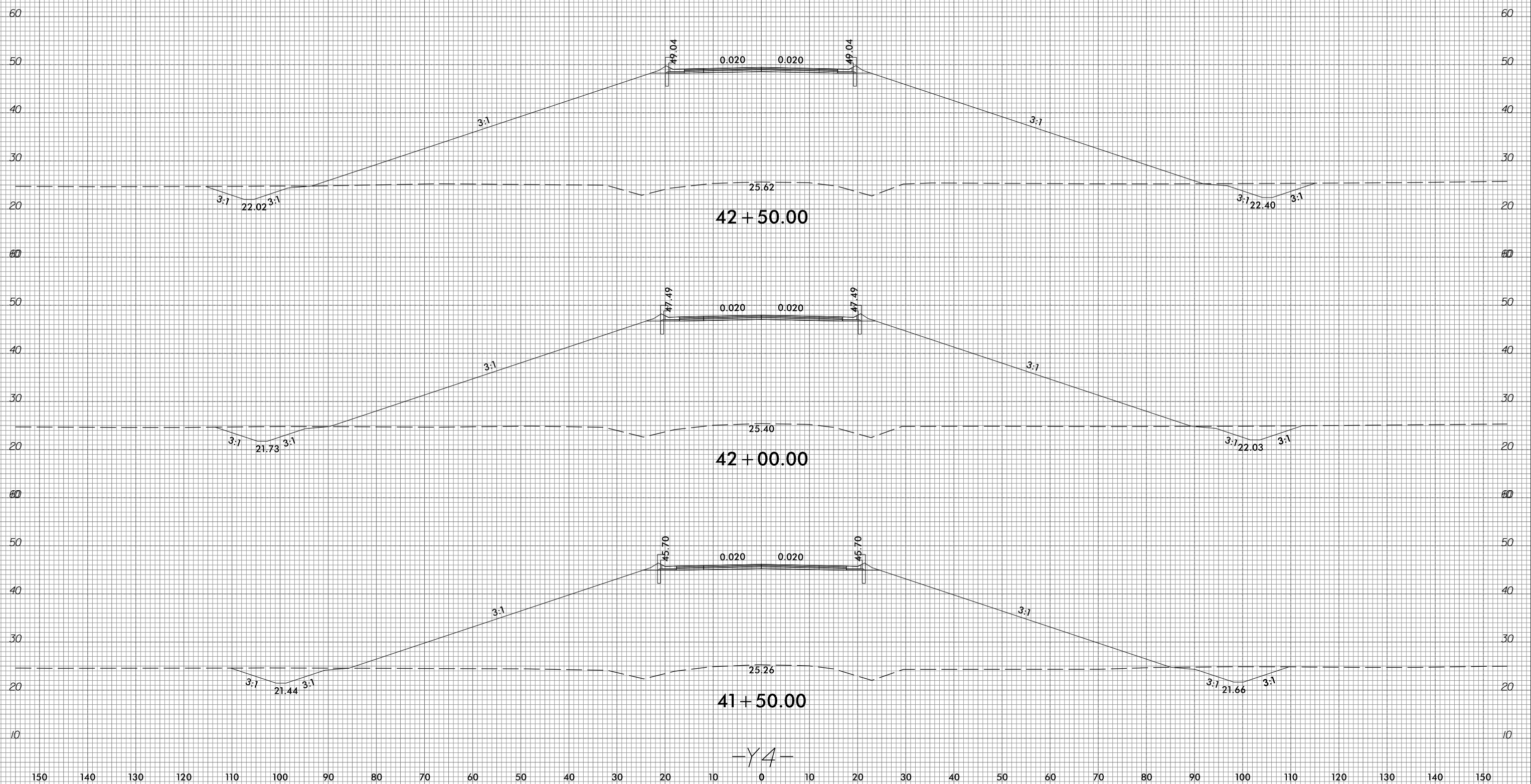

42 + 50.00

42 + 00.00

41 + 50.00

-Y4-

10/31/2018  
 G:\RA\9729-02\CADD\1015\Roadway\XSC\1015\_xp1\_Y4.dgn  
 gncdlin

6/23/16



PROJ. REFERENCE NO.
R-1015

SHEET NO.
X-379

150 140 130 120 110 100 90 80 70 60 50 40 30 20 10 0 10 20 30 40 50 60 70 80 90 100 110 120 130 140 150

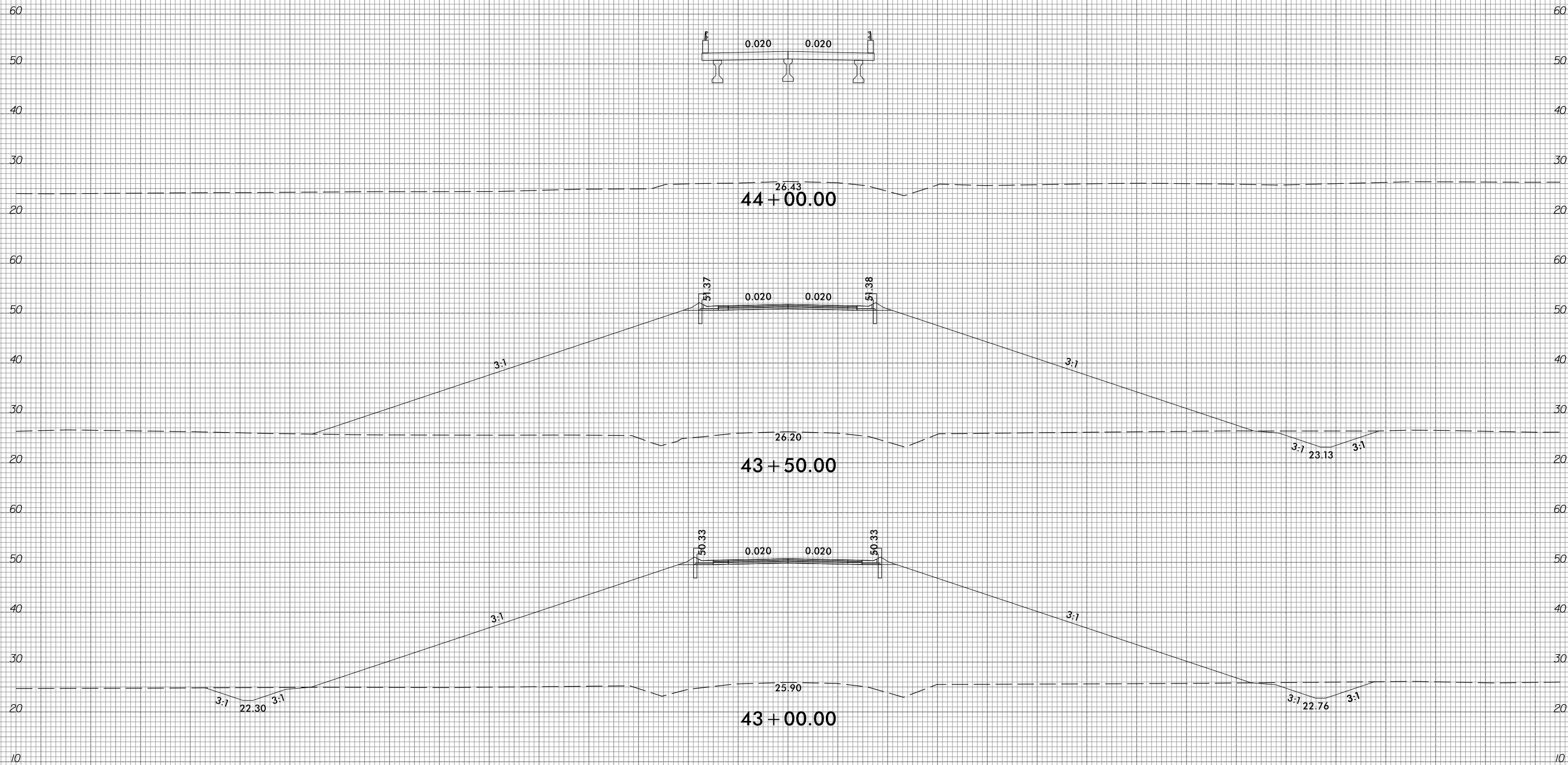

-Y4-

150 140 130 120 110 100 90 80 70 60 50 40 30 20 10 0 10 20 30 40 50 60 70 80 90 100 110 120 130 140 150

10/31/2018  
 G:\RA\9729-02\CADD\1015\Roadway\XSC\1015\_xp1\_Y4.dgn  
 gmc01in

6/23/16



PROJ. REFERENCE NO.	SHEET NO.
R-1015	X-380

PROJ. REFERENCE NO.	SHEET NO.
R-1015	X-380

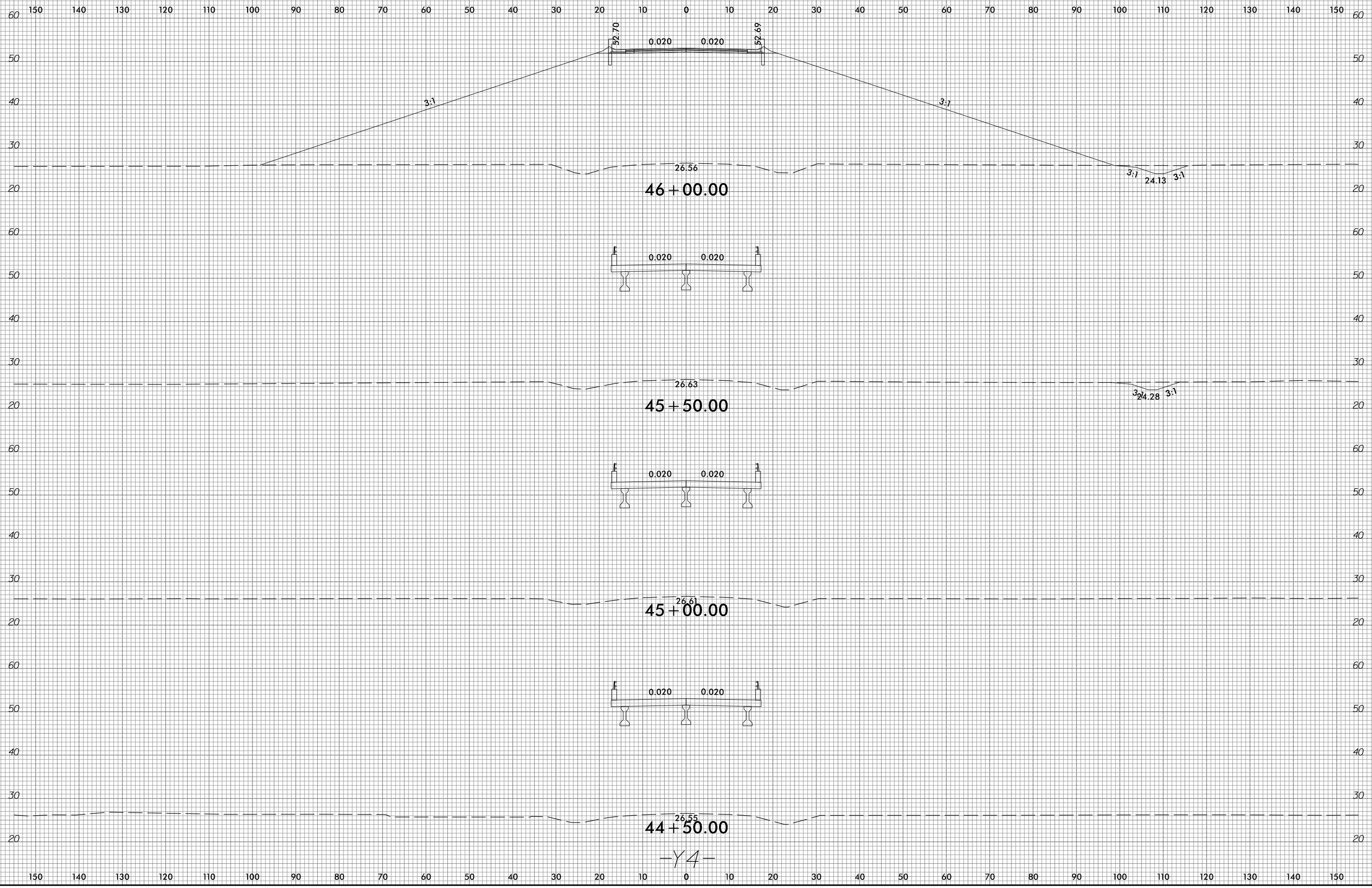

10/31/2018  
 G:\RA\9729-02\CADD\1015\Roadway\XSC\1015\_xpl\_Y4.dgn  
 gncdjin

-Y4-

6/23/16



PROJ. REFERENCE NO.	SHEET NO.
R-1015	X-381

150 140 130 120 110 100 90 80 70 60 50 40 30 20 10 0 10 20 30 40 50 60 70 80 90 100 110 120 130 140 150

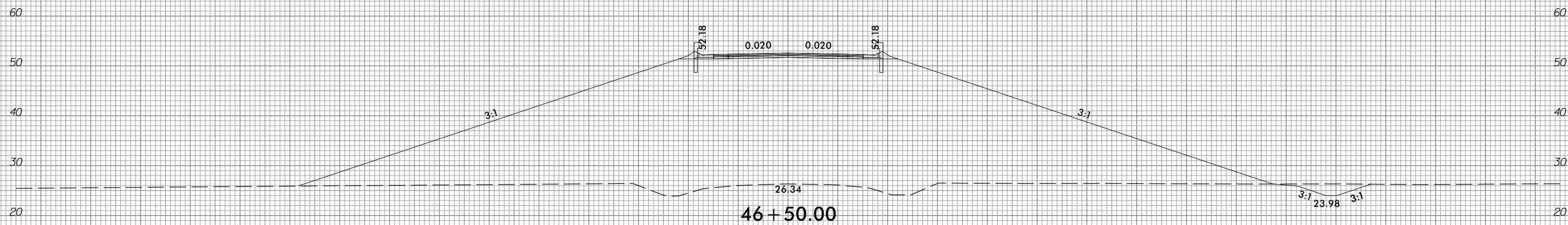
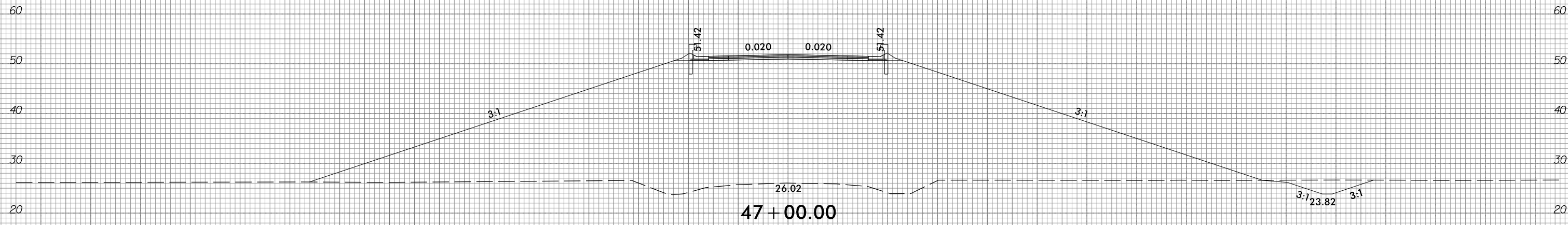
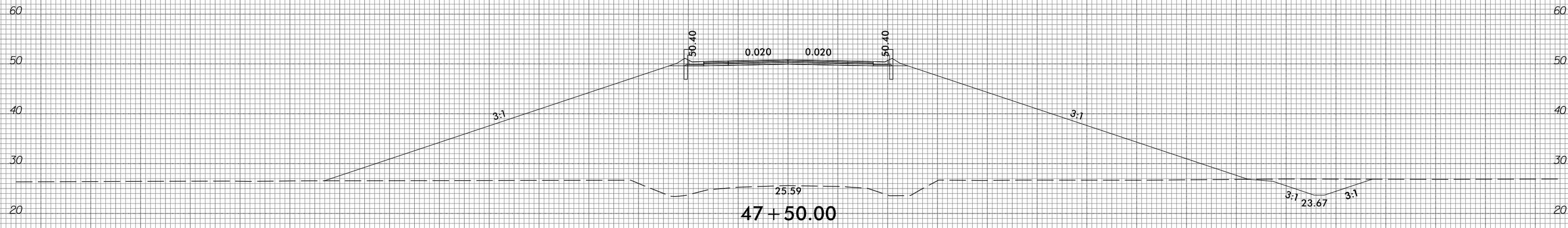

-Y4-

150 140 130 120 110 100 90 80 70 60 50 40 30 20 10 0 10 20 30 40 50 60 70 80 90 100 110 120 130 140 150

10/31/2018  
 G:\RA\9729-02\CAD\00\1015\Roadway\XSC\1015\_xp1\_Y4.dgn  
 gmc01in

6/23/16



PROJ. REFERENCE NO.
R-1015

SHEET NO.
X-382

150 140 130 120 110 100 90 80 70 60 50 40 30 20 10 0 10 20 30 40 50 60 70 80 90 100 110 120 130 140 150

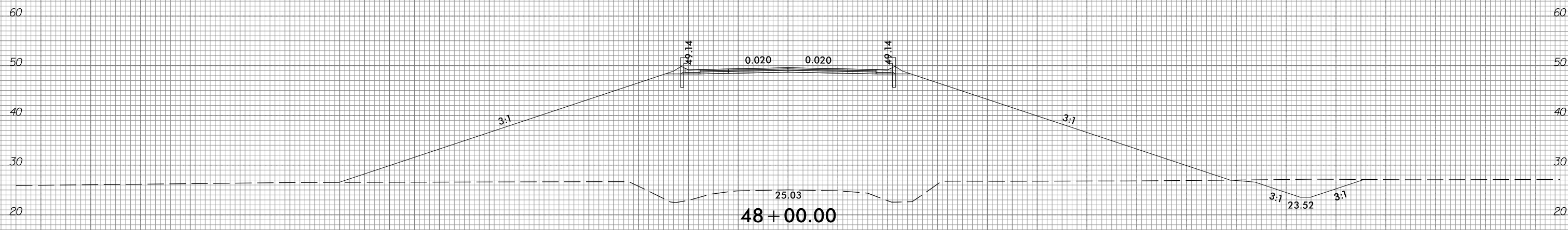
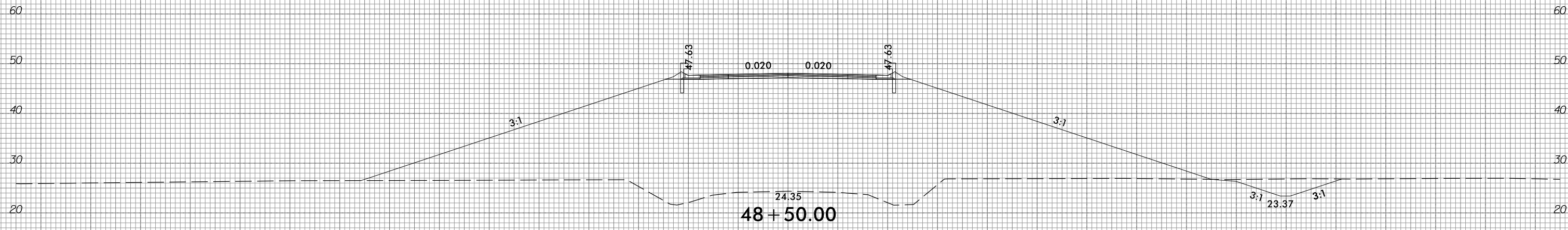
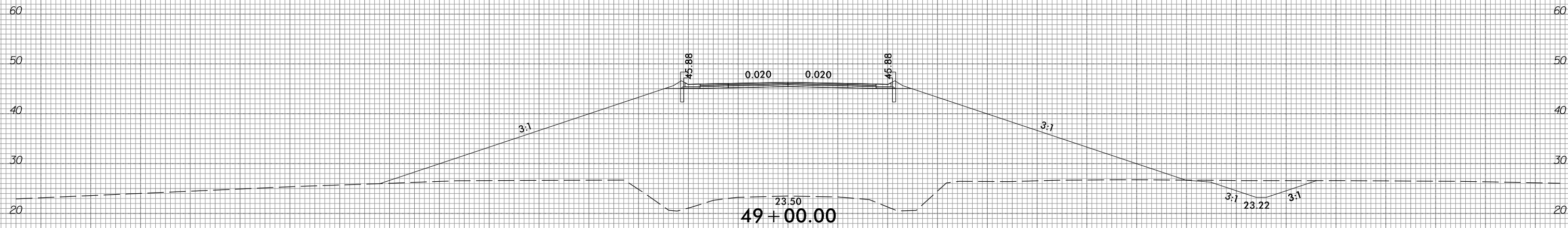

-Y4-

10/31/2018  
 G:\RA\9729-02\CA00\1015\Roadway\XSC\1015\_xp1\_Y4.dgn  
 gmc01in



6/23/16



PROJ. REFERENCE NO.	SHEET NO.
R-1015	X-383

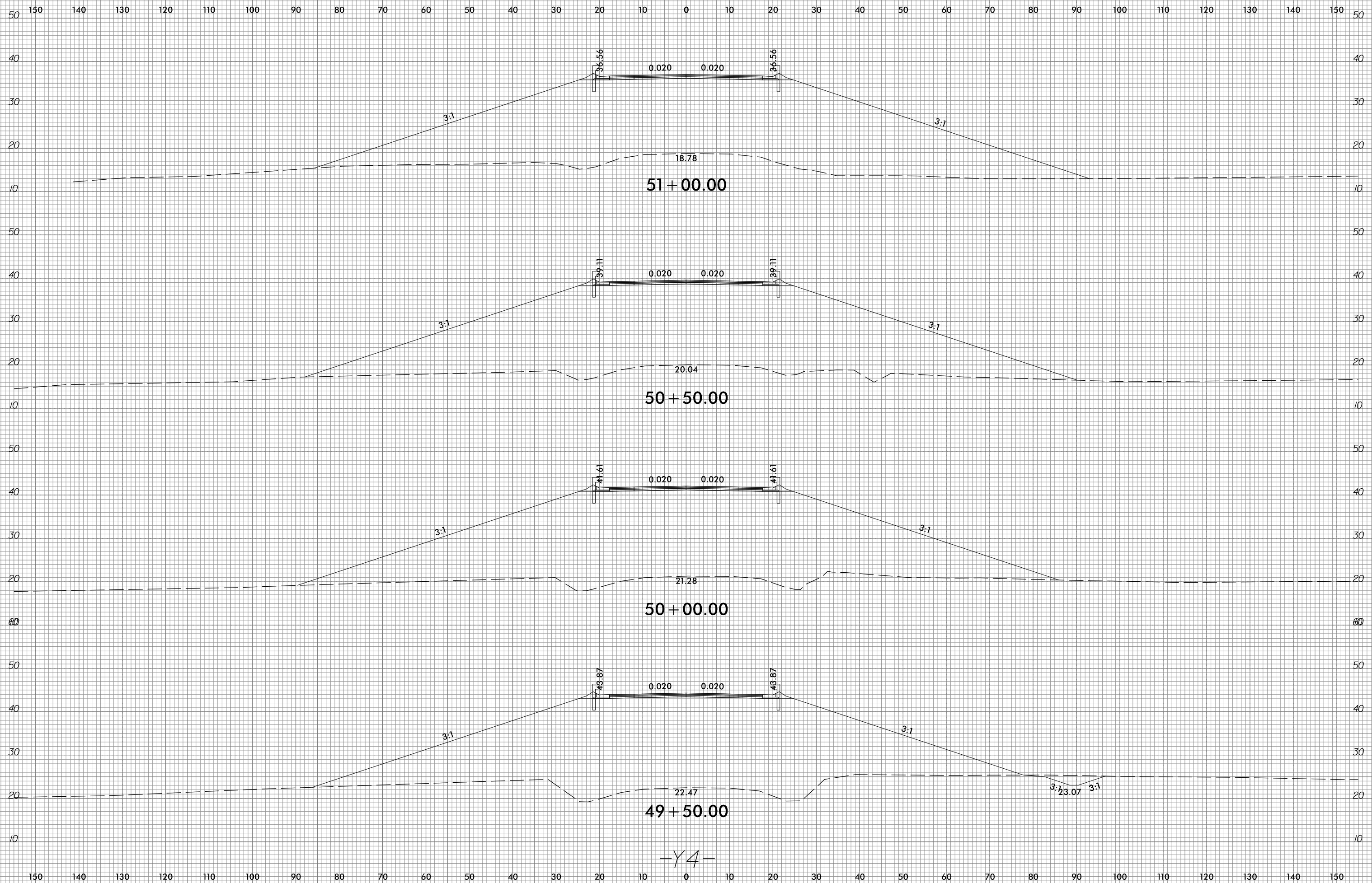

51+00.00

50+50.00

50+00.00

49+50.00

-Y4-

10/31/2018  
G:\RA\9729-02\CADD\1015\Roadway\XSC\1015\_xp1\_Y4.dgn  
gncdjin

6/23/16



PROJ. REFERENCE NO.  
R-1015

SHEET NO.  
X-384

150 140 130 120 110 100 90 80 70 60 50 40 30 20 10 0 10 20 30 40 50 60 70 80 90 100 110 120 130 140 150

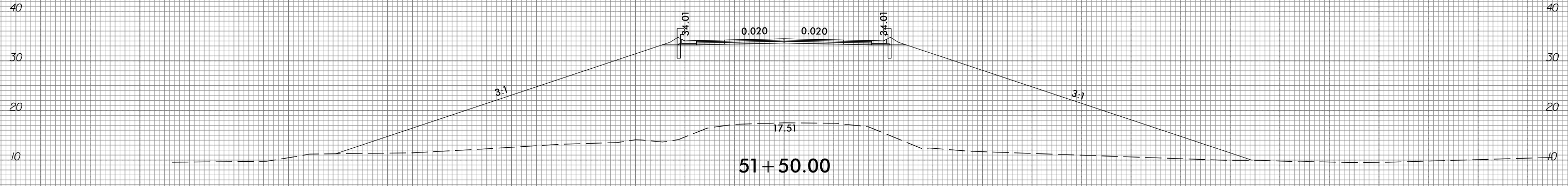
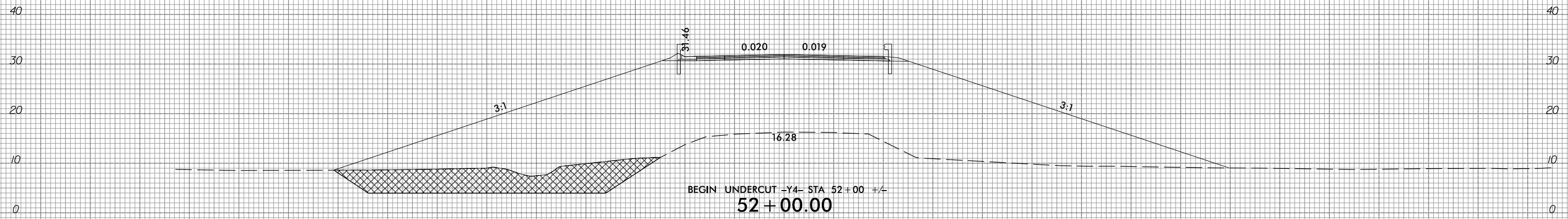
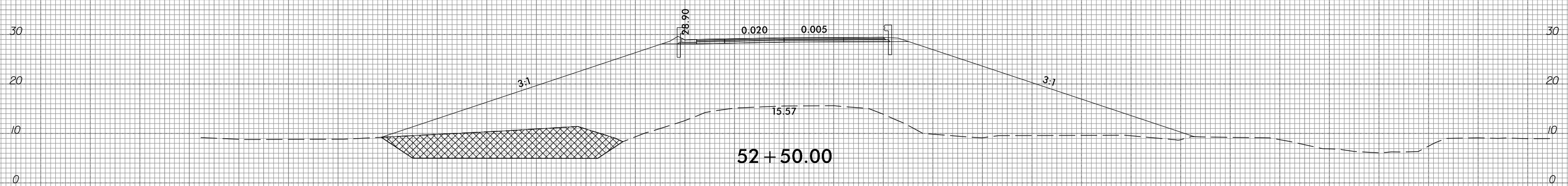
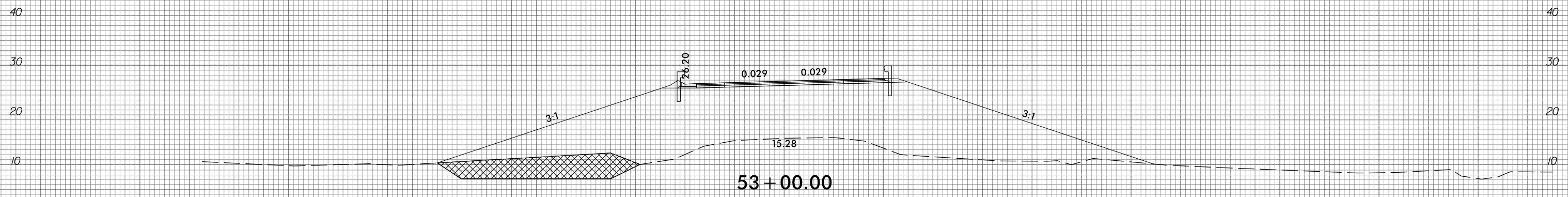

PROPOSED UNDERCUT



-Y4-

150 140 130 120 110 100 90 80 70 60 50 40 30 20 10 0 10 20 30 40 50 60 70 80 90 100 110 120 130 140 150

10/31/2018  
G:\RA\9729-02\CADD\1015\Roadway\XSC\1015\_xp1\_y4.dgn  
gmc311

6/23/16



PROJ. REFERENCE NO.  
R-1015

SHEET NO.  
X-385

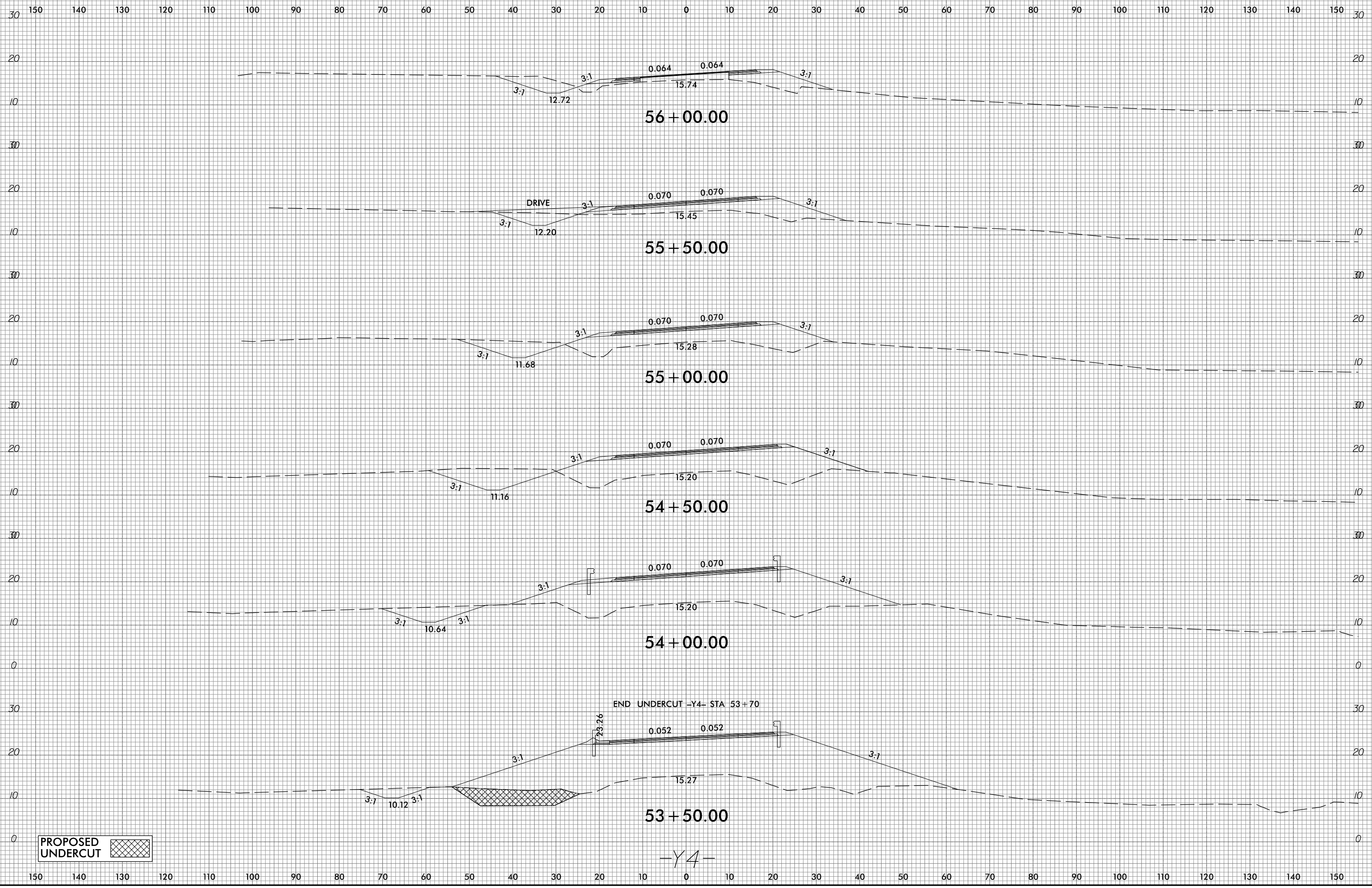

PROPOSED UNDERCUT



10/31/2018  
G:\RA\9729-02\CADD\1015\Roadway\XSC\1015\_xp1\_Y4.dgn  
gncdjin

6/23/16



PROJ. REFERENCE NO.  
R-1015

SHEET NO.  
X-386

150 140 130 120 110 100 90 80 70 60 50 40 30 20 10 0 10 20 30 40 50 60 70 80 90 100 110 120 130 140 150

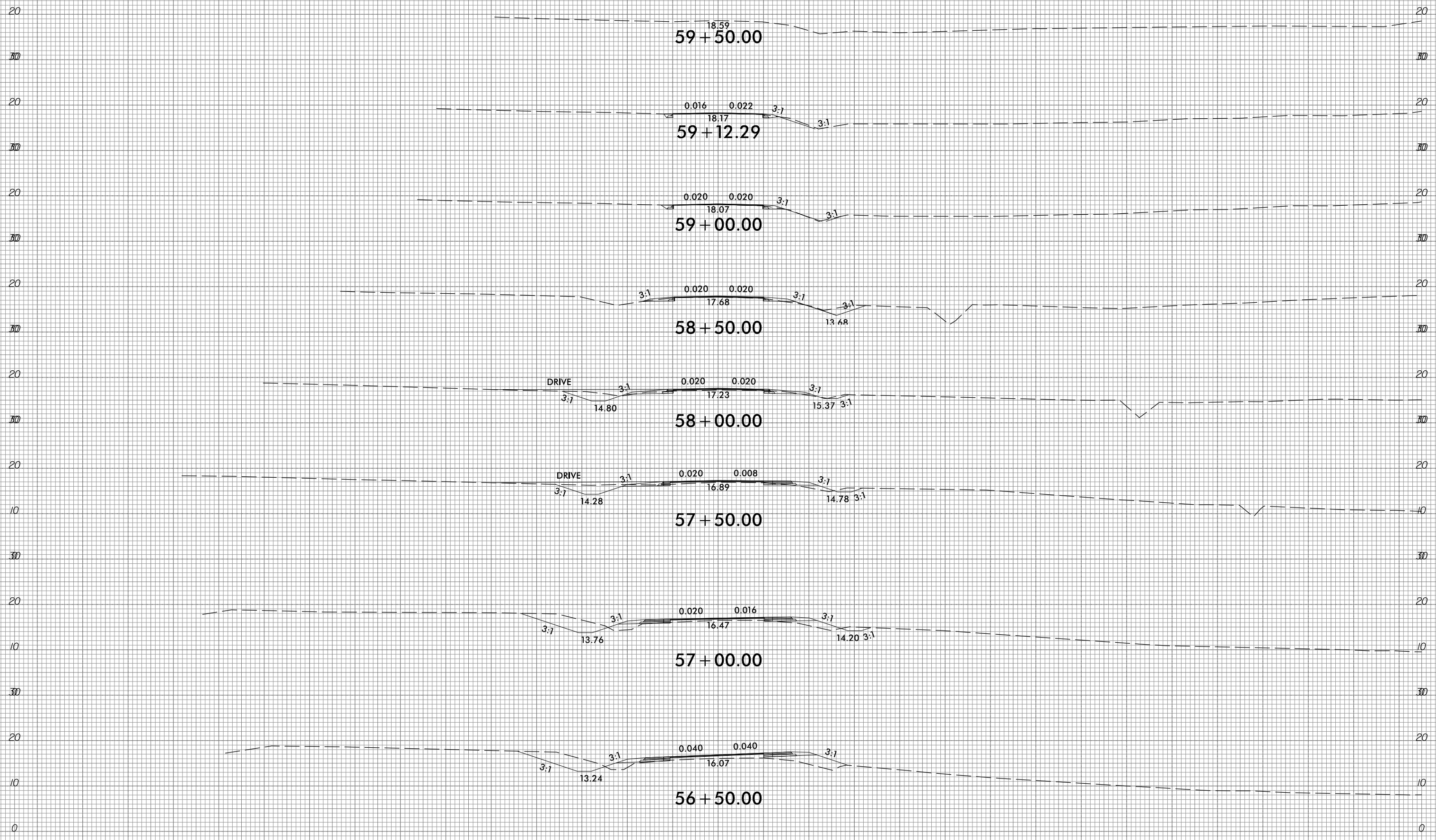

18.59  
**59 + 50.00**

0.016 0.022  
18.17  
**59 + 12.29**

0.020 0.020  
18.07  
**59 + 00.00**

3:1 0.020 0.020 3:1  
17.68  
**58 + 50.00**

DRIVE 3:1 0.020 0.020 3:1  
14.80 17.23 15.37  
**58 + 00.00**

DRIVE 3:1 0.020 0.008 3:1  
14.28 16.89 14.78  
**57 + 50.00**

3:1 0.020 0.016 3:1  
13.76 16.47 14.20  
**57 + 00.00**

3:1 0.040 0.040 3:1  
13.24 16.07  
**56 + 50.00**

-Y4-

150 140 130 120 110 100 90 80 70 60 50 40 30 20 10 0 10 20 30 40 50 60 70 80 90 100 110 120 130 140 150

10/31/2018  
G:\RA\9729-02\CADD\1015\Roadway\XSC\1015\_xp1\_Y4.dgn  
gncdlin

150 140 130 120 110 100 90 80 70 60 50 40 30 20 10 0 10 20 30 40 50 60 70 80 90 100 110 120 130 140 150

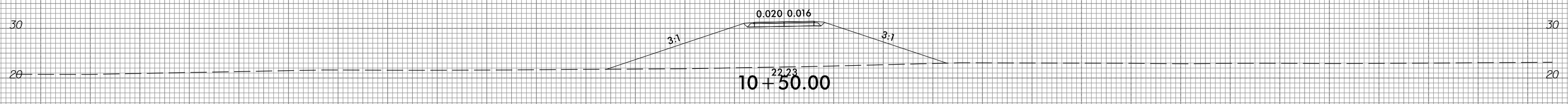
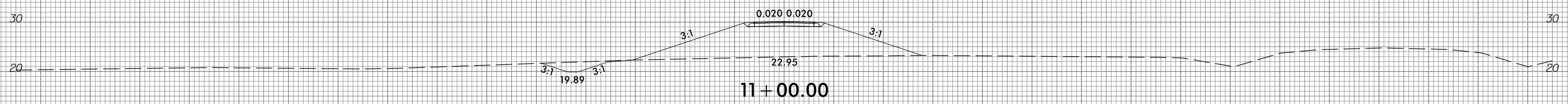
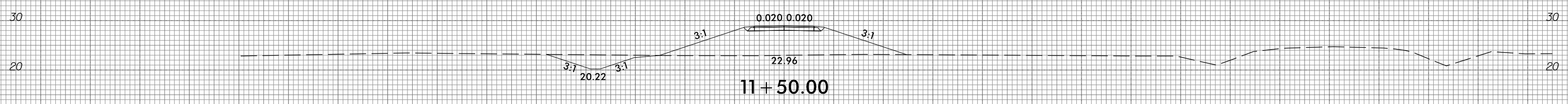
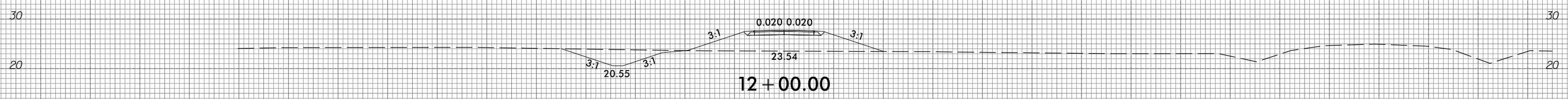
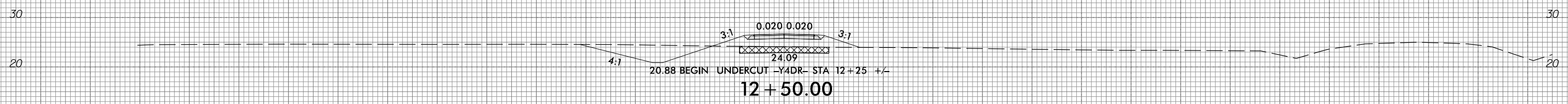
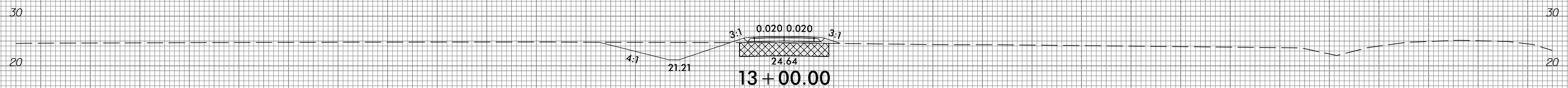

PROPOSED UNDERCUT



-Y4DR-

150 140 130 120 110 100 90 80 70 60 50 40 30 20 10 0 10 20 30 40 50 60 70 80 90 100 110 120 130 140 150

6/23/16



PROJ. REFERENCE NO.  
R-1015

SHEET NO.  
X-388

150 140 130 120 110 100 90 80 70 60 50 40 30 20 10 0 10 20 30 40 50 60 70 80 90 100 110 120 130 140 150

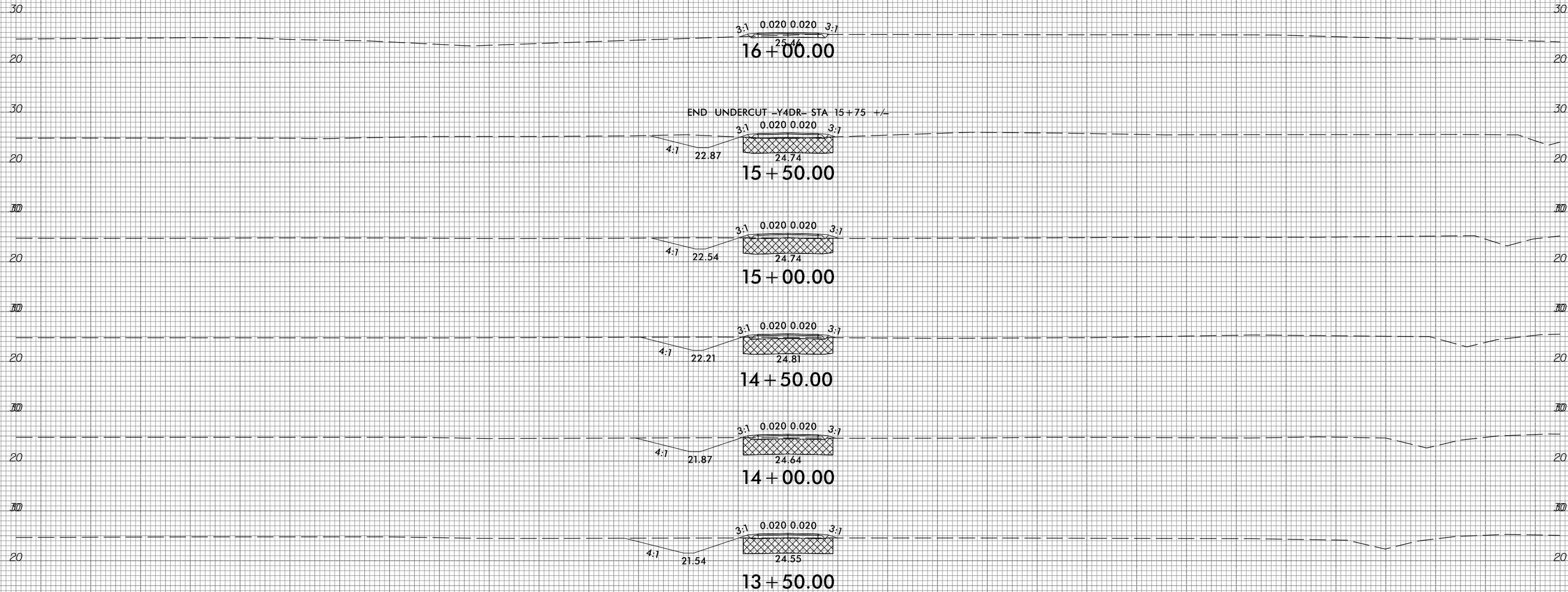

END UNDERCUT -Y4DR- STA 15+75 +/-

PROPOSED UNDERCUT



-Y4DR-

150 140 130 120 110 100 90 80 70 60 50 40 30 20 10 0 10 20 30 40 50 60 70 80 90 100 110 120 130 140 150

10/31/2018  
G:\RA\9729-02\CADD\1015\Roadway\XSC\1015.sp1.Y4DR.dgn  
gncdjin

6/23/16



PROJ. REFERENCE NO.  
R-1015

SHEET NO.  
X-389

150 140 130 120 110 100 90 80 70 60 50 40 30 20 10 0 10 20 30 40 50 60 70 80 90 100 110 120 130 140 150

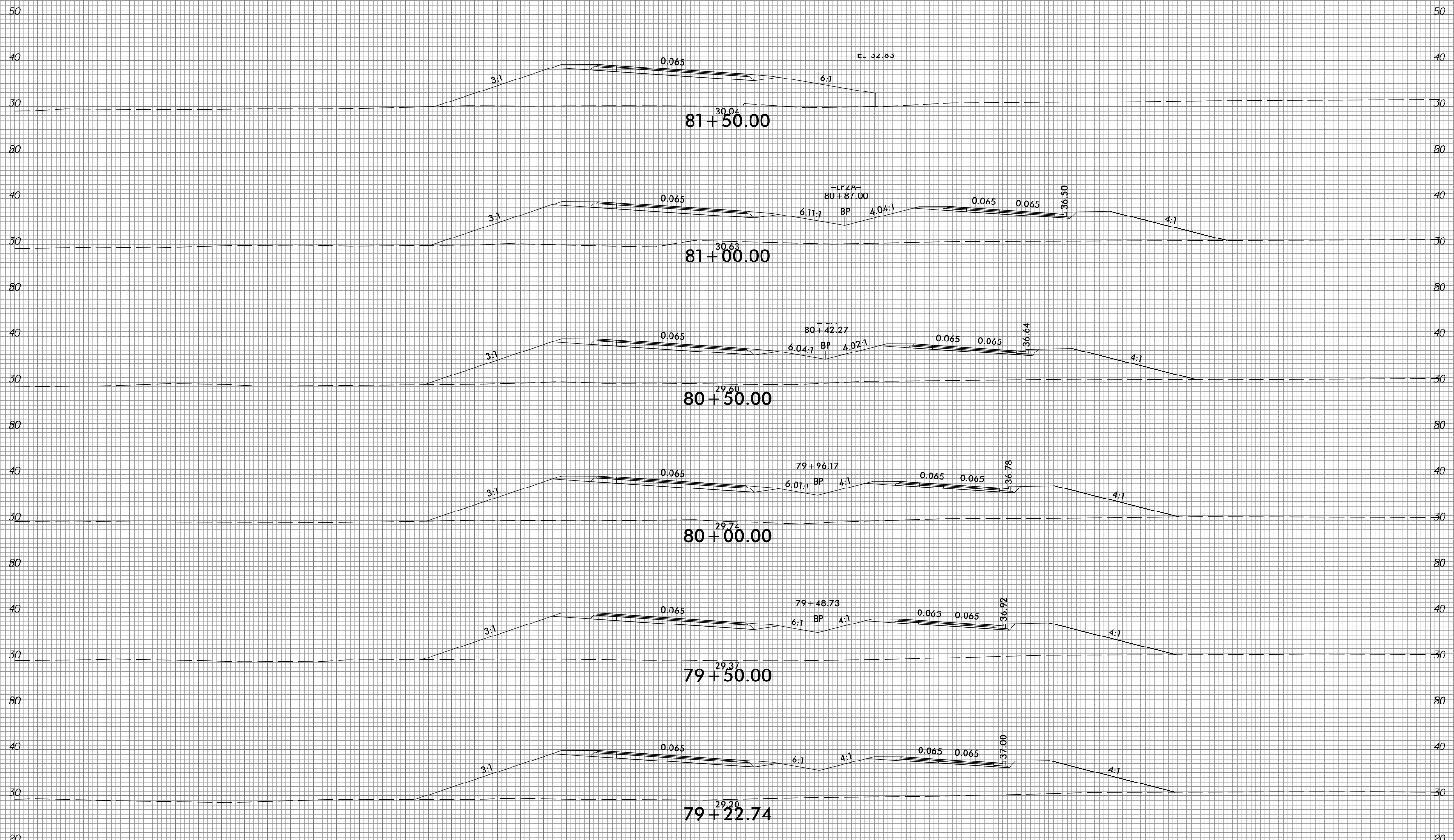

-RP2A-

10/31/2018  
G:\RA\9729-02\CADD\1015\Roadway\XSC\1015\_xp1\_RP2A.dgn  
gncdlin

6/23/16



PROJ. REFERENCE NO.  
R-1015

SHEET NO.  
X-390

150 140 130 120 110 100 90 80 70 60 50 40 30 20 10 0 10 20 30 40 50 60 70 80 90 100 110 120 130 140 150

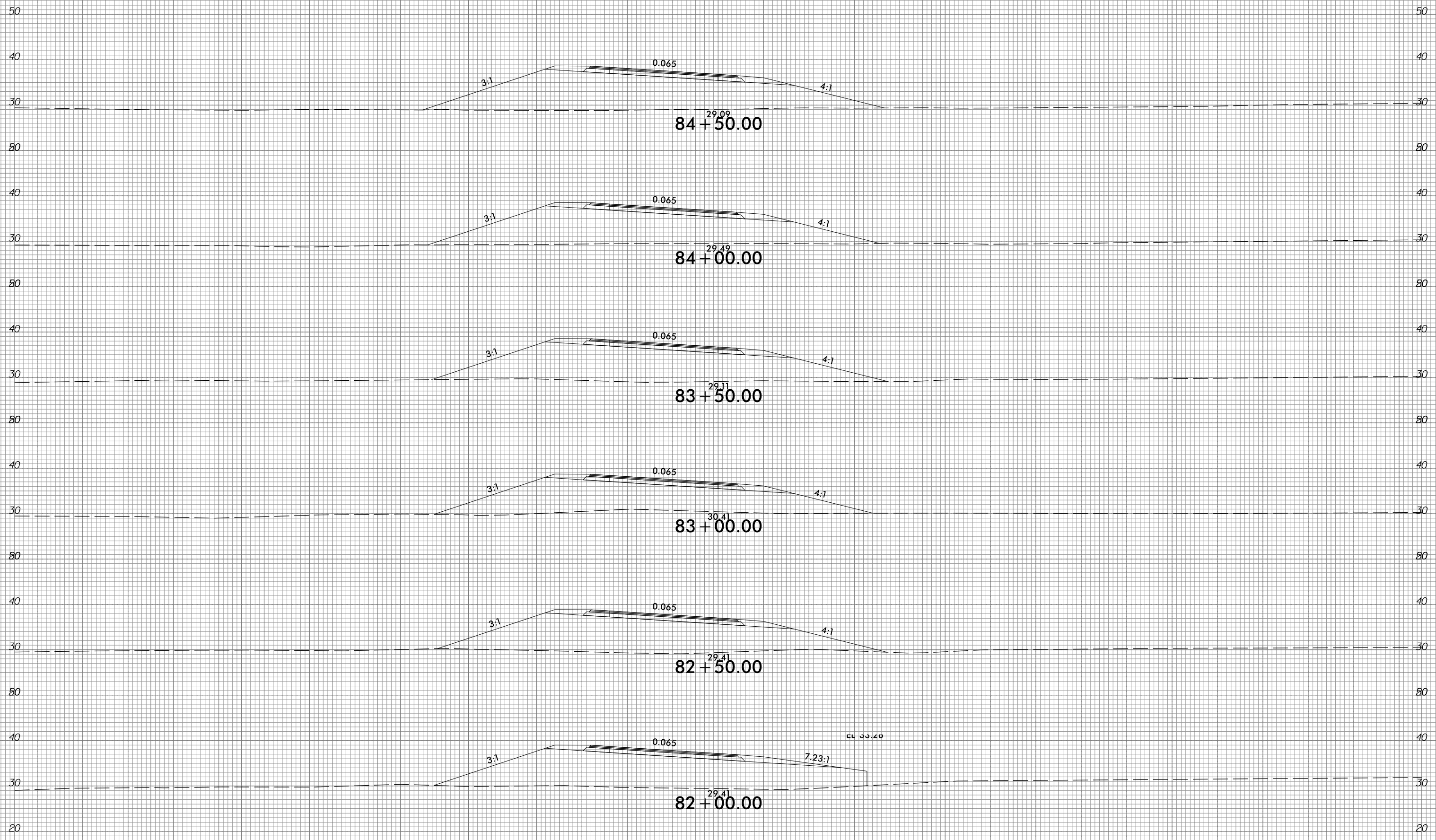

-RP2A-

10/31/2018  
G:\RA\9729-02\CADD\1015\Roadway\XSC\1015\_xp1\_RP2A.dgn  
gncdlin

150 140 130 120 110 100 90 80 70 60 50 40 30 20 10 0 10 20 30 40 50 60 70 80 90 100 110 120 130 140 150



6/23/16



PROJ. REFERENCE NO.  
R-1015

SHEET NO.  
X-391

150 140 130 120 110 100 90 80 70 60 50 40 30 20 10 0 10 20 30 40 50 60 70 80 90 100 110 120 130 140 150

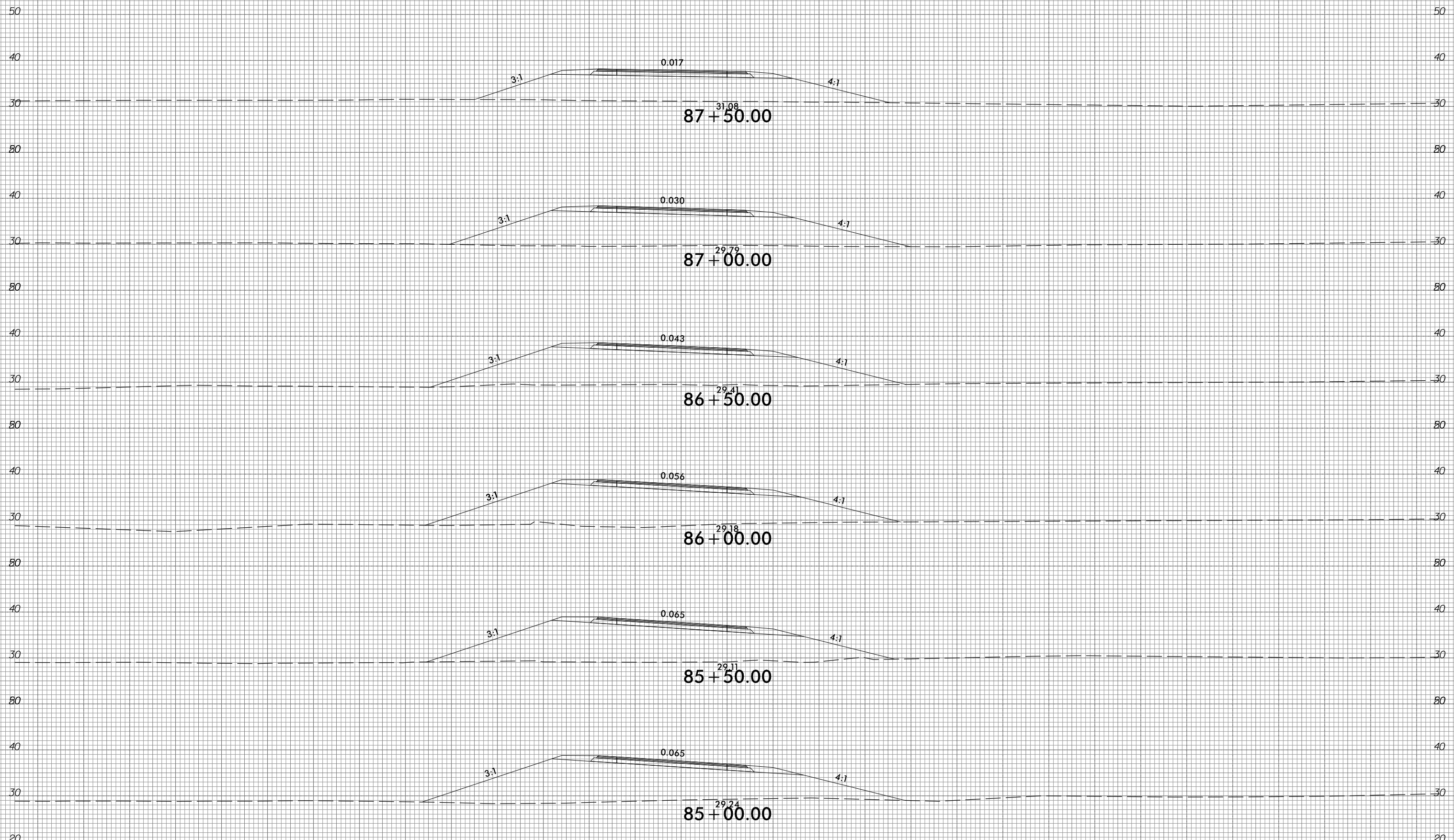

-RP2A-

10/31/2016  
G:\RA\9729-02\CADD\1015\Roadway\XSC\1015\_xp1\_RP2A.dgn  
gncdlin

150 140 130 120 110 100 90 80 70 60 50 40 30 20 10 0 10 20 30 40 50 60 70 80 90 100 110 120 130 140 150

6/23/16



PROJ. REFERENCE NO.
R-1015

SHEET NO.
X-392

150 140 130 120 110 100 90 80 70 60 50 40 30 20 10 0 10 20 30 40 50 60 70 80 90 100 110 120 130 140 150

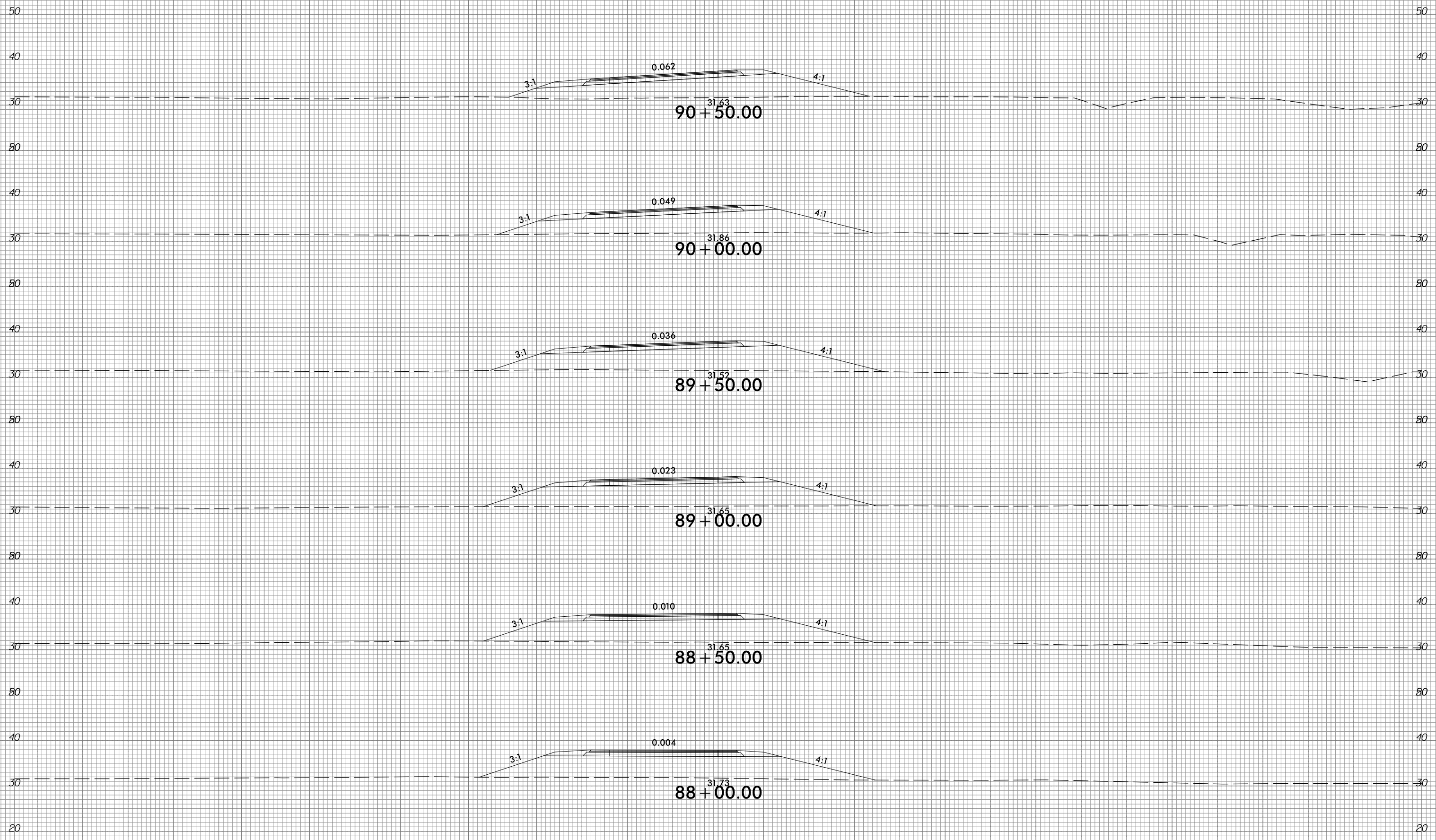

-RP2A-

150 140 130 120 110 100 90 80 70 60 50 40 30 20 10 0 10 20 30 40 50 60 70 80 90 100 110 120 130 140 150

10/31/2018  
 G:\RA\9729-02\CADD\1015\Roadway\XSC\1015\_xp1\_RP2A.dgn  
 gncdlin

6/23/16



PROJ. REFERENCE NO.  
R-1015

SHEET NO.  
X-393

150 140 130 120 110 100 90 80 70 60 50 40 30 20 10 0 10 20 30 40 50 60 70 80 90 100 110 120 130 140 150

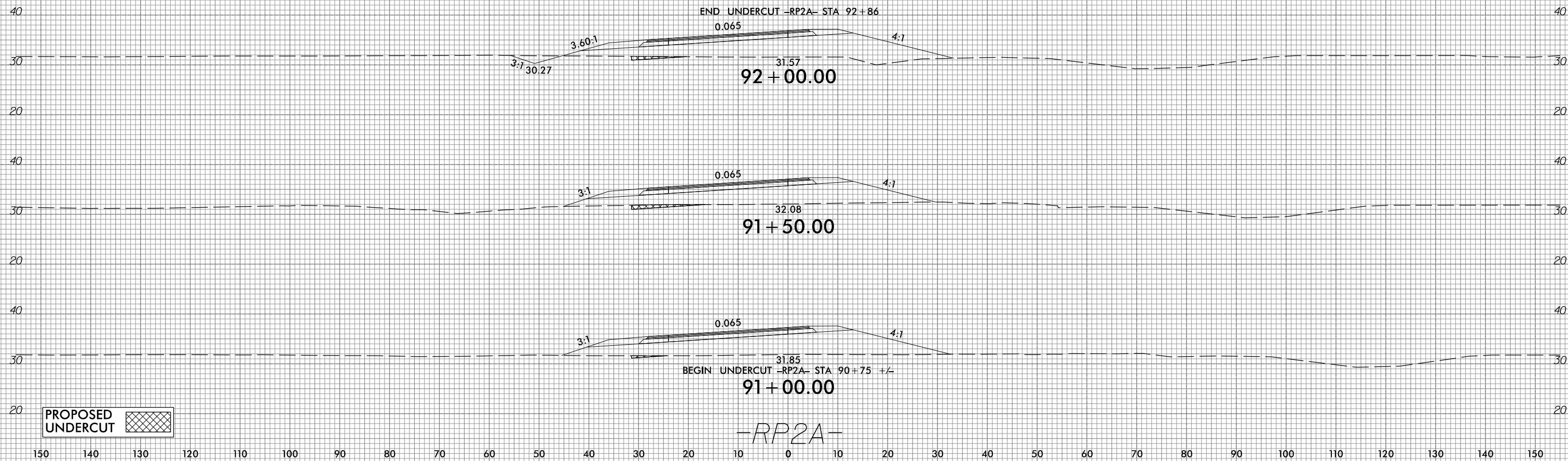

10/31/2018  
G:\RA\9729-02\CADD\1015\Roadway\XSC\1015\_xp1\_RP2A.dgn  
gncdlin

150 140 130 120 110 100 90 80 70 60 50 40 30 20 10 0 10 20 30 40 50 60 70 80 90 100 110 120 130 140 150

6/23/16



PROJ. REFERENCE NO.
R-1015

SHEET NO.
X-394

150 140 130 120 110 100 90 80 70 60 50 40 30 20 10 0 10 20 30 40 50 60 70 80 90 100 110 120 130 140 150

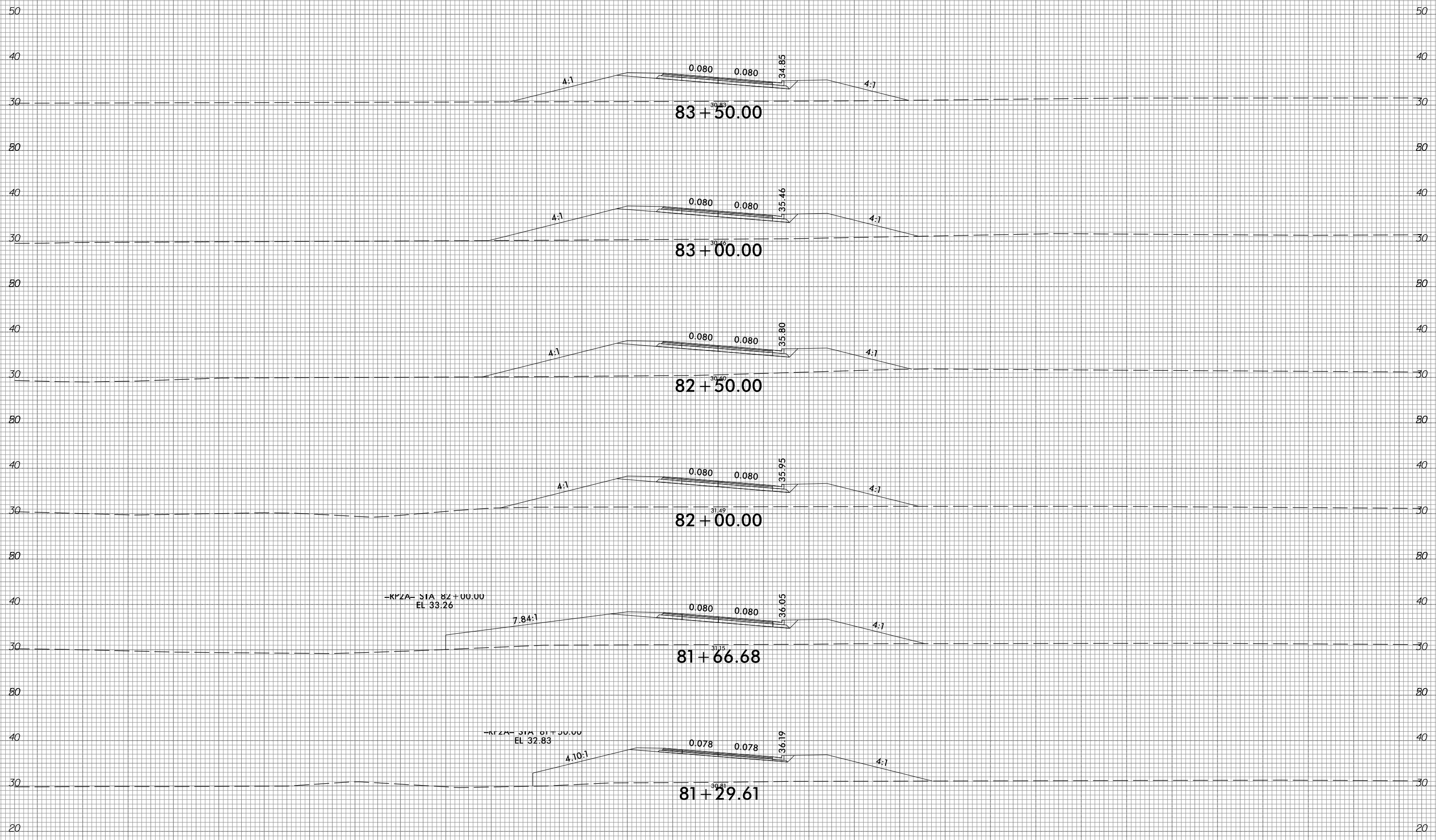

-LP2A-

150 140 130 120 110 100 90 80 70 60 50 40 30 20 10 0 10 20 30 40 50 60 70 80 90 100 110 120 130 140 150

10/31/2018  
 G:\RA\9729-02\CADD\1015\Roadway\XSC\1015\_xp1.LP2A.dgn  
 gncdlin

6/23/16



PROJ. REFERENCE NO.  
R-1015

SHEET NO.  
X-395

150 140 130 120 110 100 90 80 70 60 50 40 30 20 10 0 10 20 30 40 50 60 70 80 90 100 110 120 130 140 150

SP  
-L- STA 528+79.38  
EL 31.88 END UNDERCUT EXCAVATION -LP2A- STA 87+25

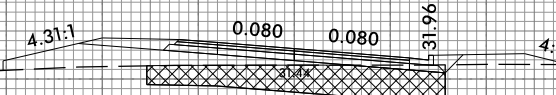

86+00.00

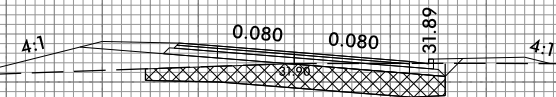

85+50.00

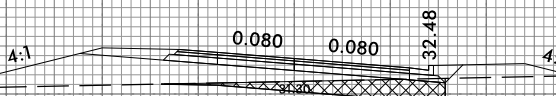

85+00.00

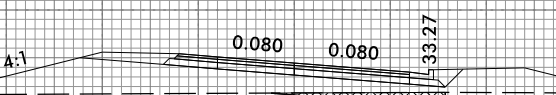

84+50.00

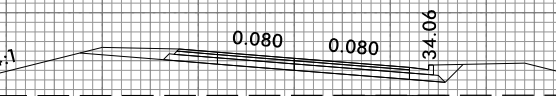

84+00.00

BEGIN UNDERCUT -LP2A- STA 83+75 +/-

-LP2A-

UNCLS  
ACCEPTABLE

PROPOSED  
UNDERCUT

150 140 130 120 110 100 90 80 70 60 50 40 30 20 10 0 10 20 30 40 50 60 70 80 90 100 110 120 130 140 150

10/31/2018  
G:\RA\9729-02\CADD\1015\Roadway\XSC\1015\_xp1.LP2A.dgn  
gmc311

6/23/16



PROJ. REFERENCE NO.  
R-1015

SHEET NO.  
X-396

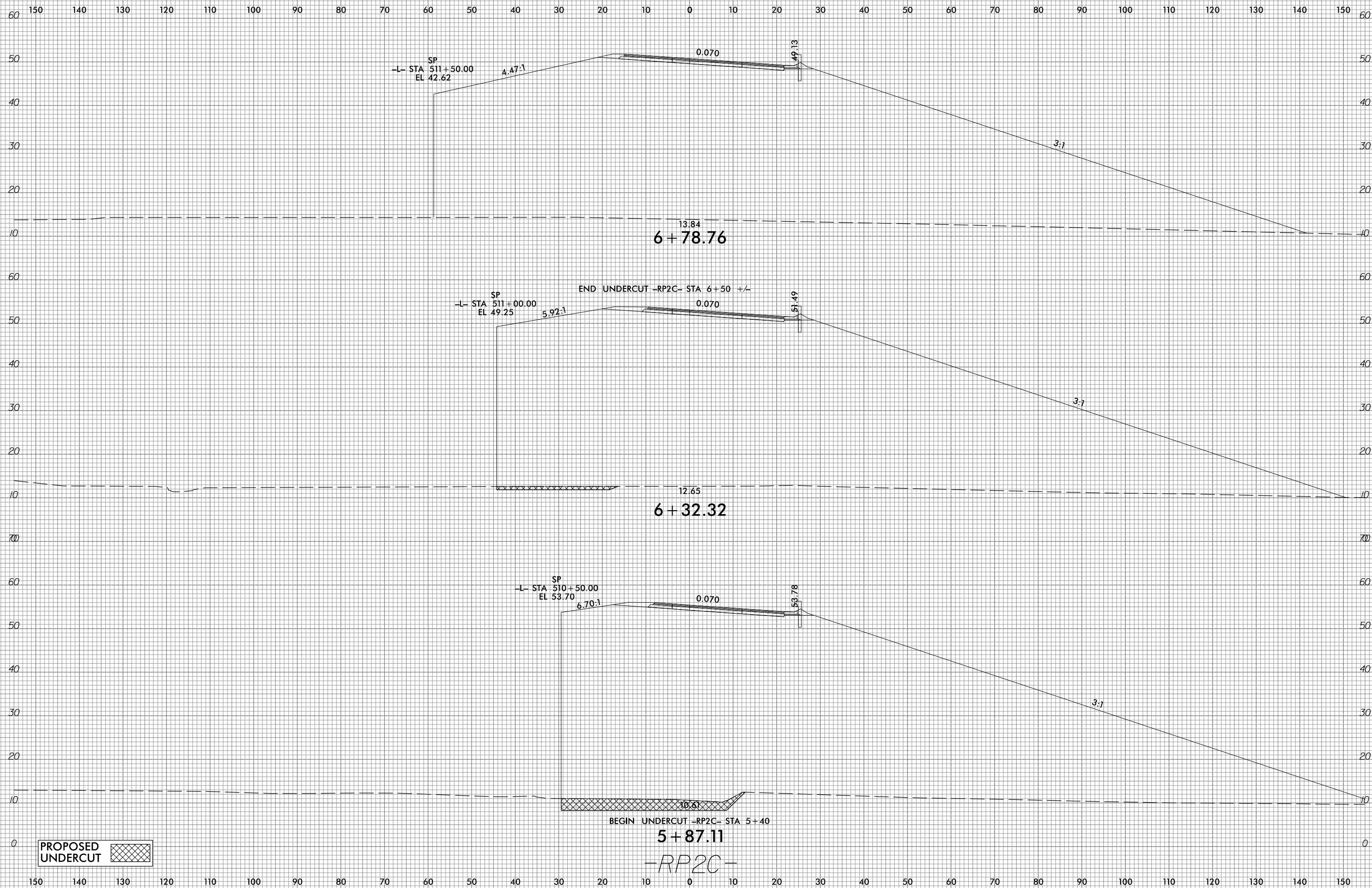

SP  
-L- STA 511+50.00  
EL 42.62

4.47:1

0.070

49.13

3:1

13.84  
6+78.76

SP  
-L- STA 511+00.00  
EL 49.25

END UNDERCUT -RP2C- STA 6+50 +/-

5.92:1

0.070

51.49

3:1

12.65  
6+32.32

SP  
-L- STA 510+50.00  
EL 53.70

6.70:1

0.070

53.78

3:1

BEGIN UNDERCUT -RP2C- STA 5+40

10.61  
5+87.11

-RP2C-

PROPOSED UNDERCUT



10/31/2018  
G:\RA\9729-02\CADD\1015\Roadway\XSC\1015\_xp1\_RP2C.dgn  
gmc311

6/23/16



PROJ. REFERENCE NO.	SHEET NO.
R-1015	X-397

150 140 130 120 110 100 90 80 70 60 50 40 30 20 10 0 10 20 30 40 50 60 70 80 90 100 110 120 130 140 150

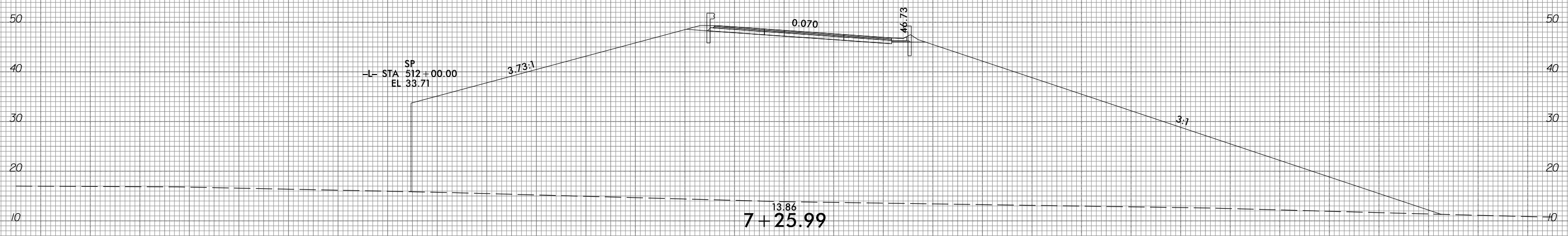
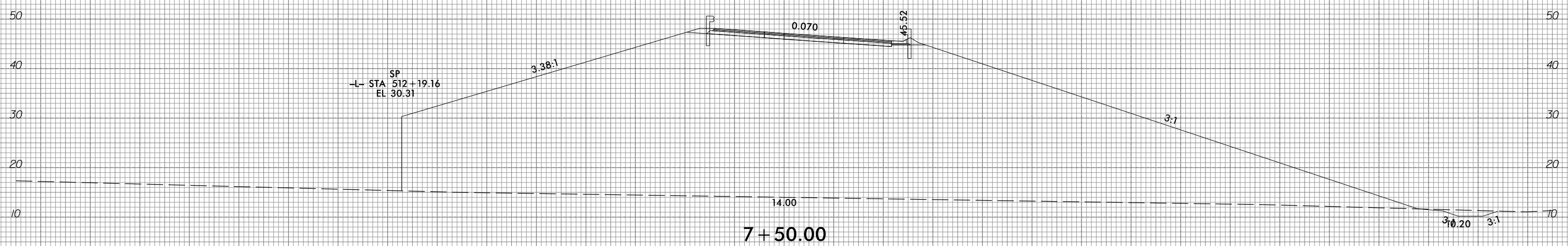
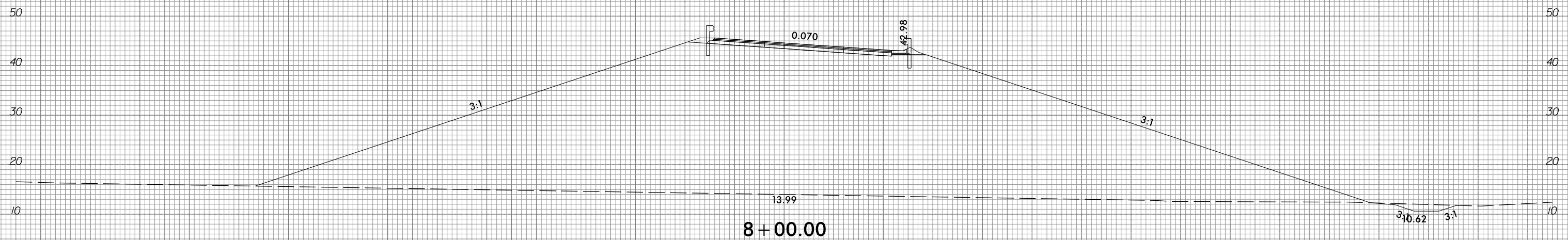

-RP2C-

150 140 130 120 110 100 90 80 70 60 50 40 30 20 10 0 10 20 30 40 50 60 70 80 90 100 110 120 130 140 150

10/31/2018  
 G:\RA\9729-02\CADD\1015\Roadway\XSC\1015\_xp1\_RP2C.dgn  
 gmc311

6/23/16



PROJ. REFERENCE NO.	SHEET NO.
R-1015	X-398

150 140 130 120 110 100 90 80 70 60 50 40 30 20 10 0 10 20 30 40 50 60 70 80 90 100 110 120 130 140 150

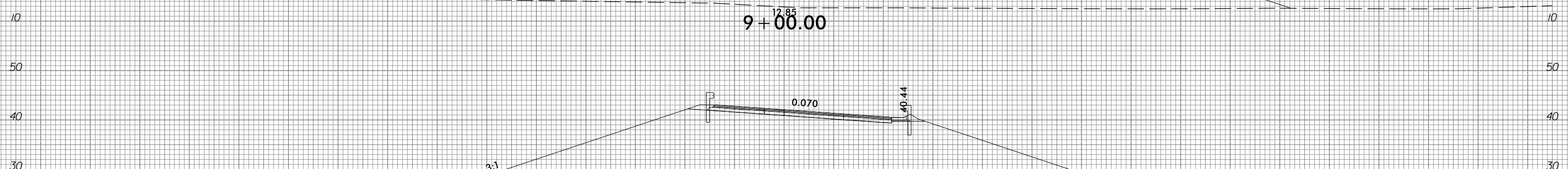
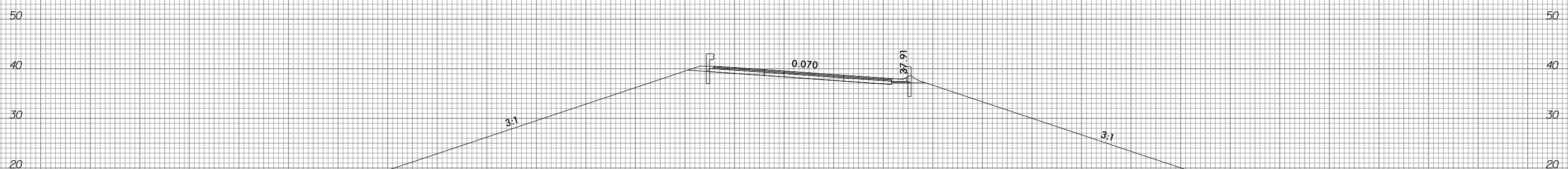
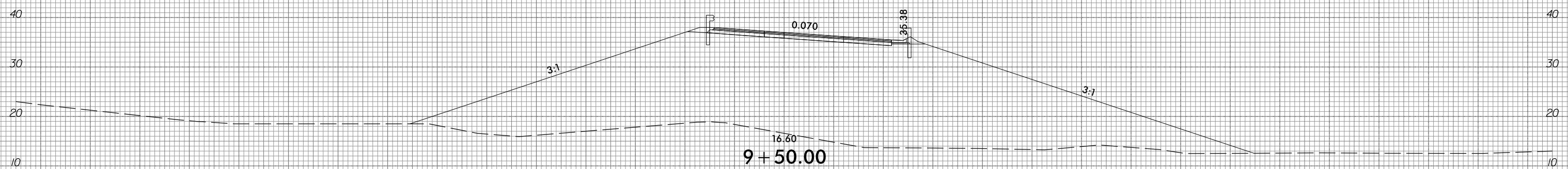
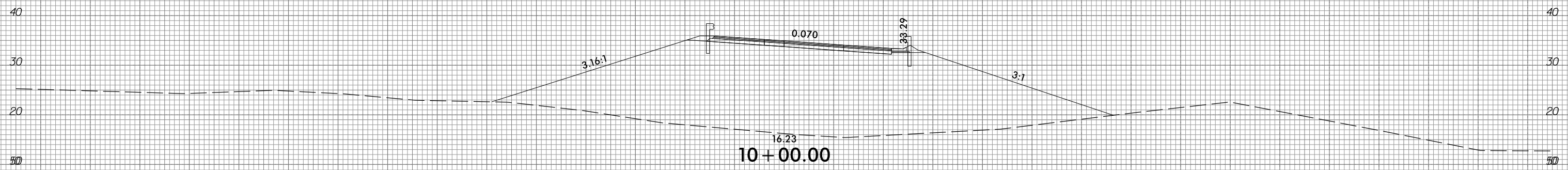

-RP2C-

150 140 130 120 110 100 90 80 70 60 50 40 30 20 10 0 10 20 30 40 50 60 70 80 90 100 110 120 130 140 150

10/31/2018  
 G:\RA\9729-02\CADD\1015\Roadway\XSC\1015\_xp1\_RP2C.dgn  
 gmc011n



6/23/16



PROJ. REFERENCE NO.  
R-1015

SHEET NO.  
X-399

150 140 130 120 110 100 90 80 70 60 50 40 30 20 10 0 10 20 30 40 50 60 70 80 90 100 110 120 130 140 150

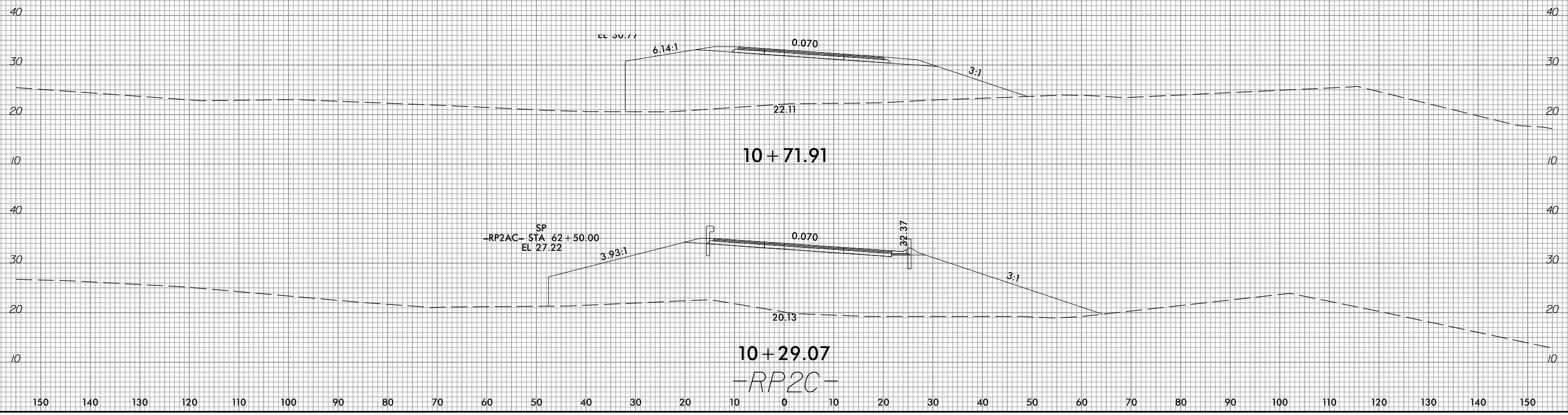

10/31/2018  
G:\RA\9729-02\CADD\1015\Roadway\XSC\1015\_xp1\_RP2C.dgn  
gmc311

150 140 130 120 110 100 90 80 70 60 50 40 30 20 10 0 10 20 30 40 50 60 70 80 90 100 110 120 130 140 150

6/23/16



PROJ. REFERENCE NO.  
R-1015

SHEET NO.  
X-400

150 140 130 120 110 100 90 80 70 60 50 40 30 20 10 0 10 20 30 40 50 60 70 80 90 100 110 120 130 140 150

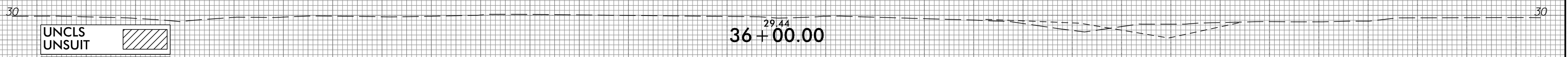
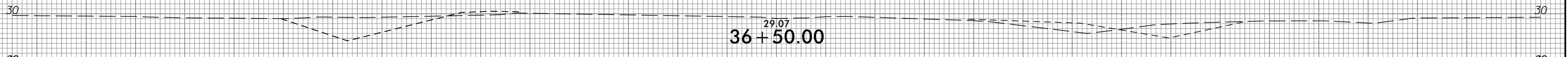
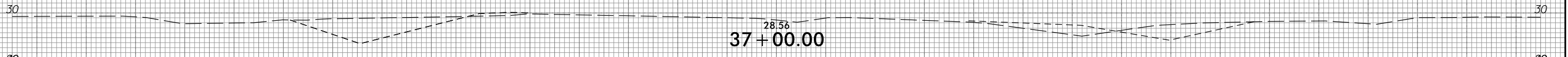
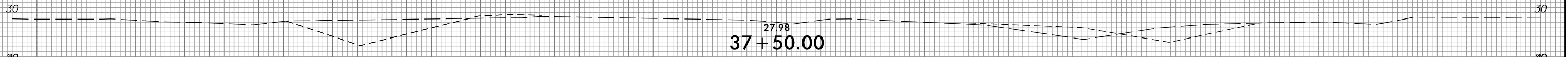
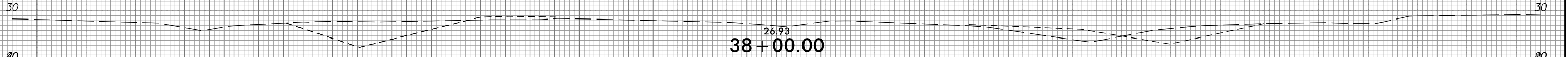
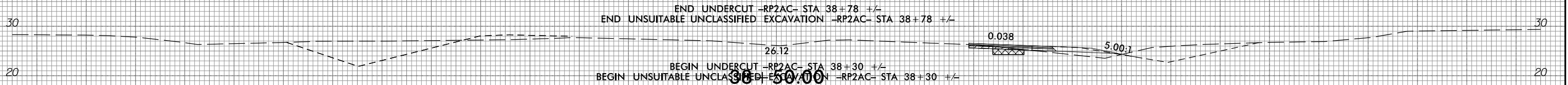
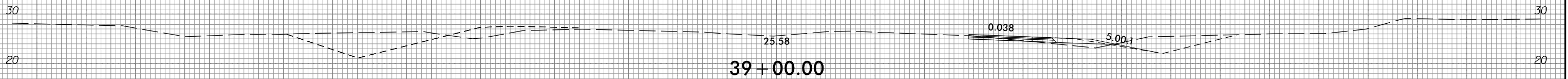
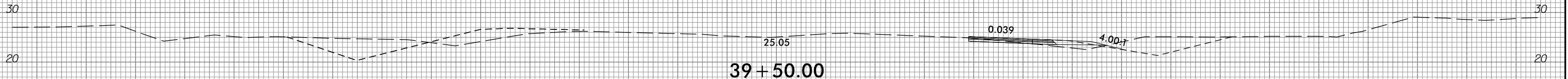

-RP2AC-

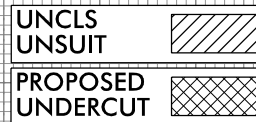

150 140 130 120 110 100 90 80 70 60 50 40 30 20 10 0 10 20 30 40 50 60 70 80 90 100 110 120 130 140 150

I:\1\2018  
g:\NA\9729-02\CA00\F1015\Roadway\XSC\F1015\_xp1\_RP2AC.dgn  
gncdlin

150 140 130 120 110 100 90 80 70 60 50 40 30 20 10 0 10 20 30 40 50 60 70 80 90 100 110 120 130 140 150

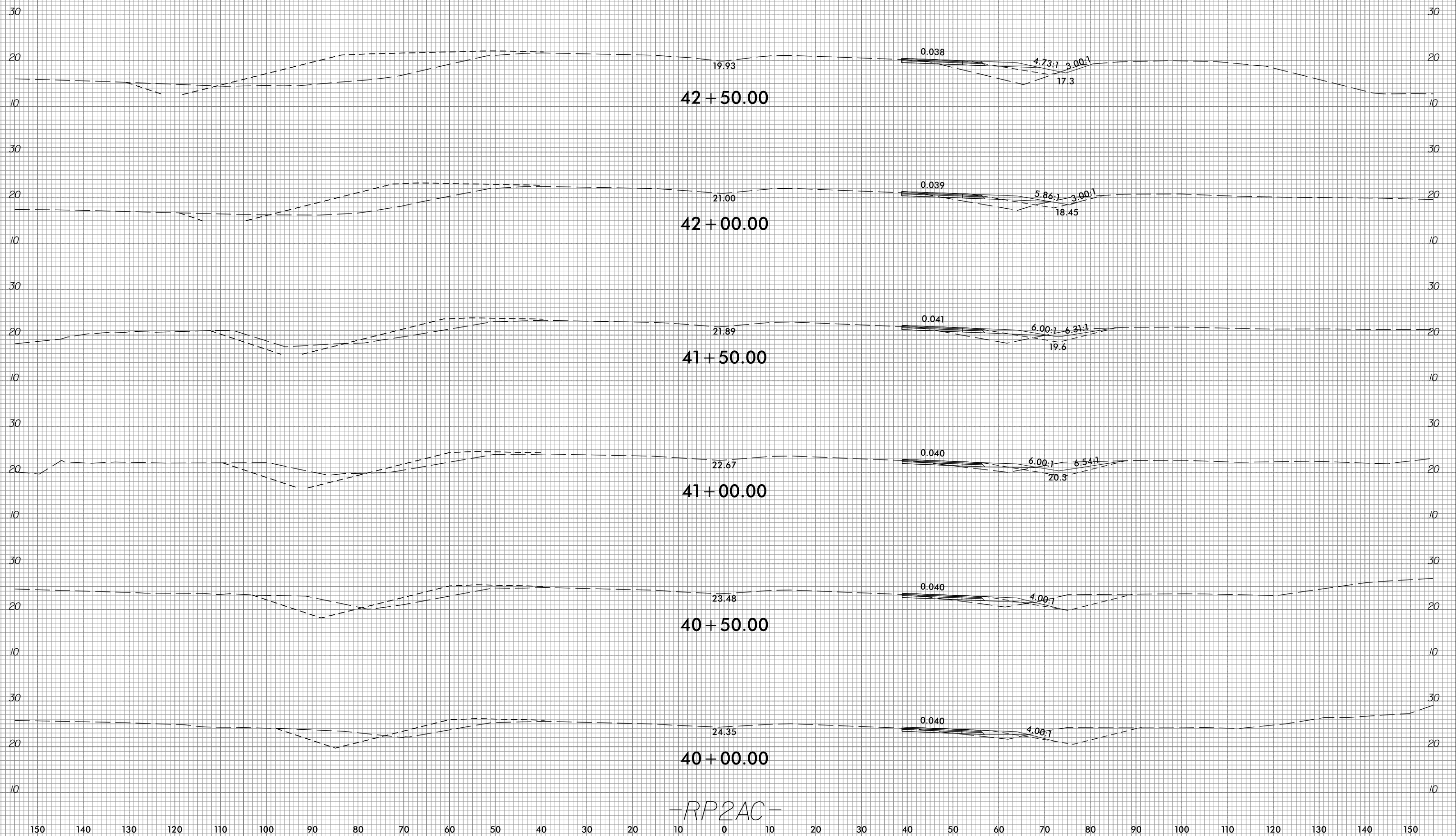

6/23/16



PROJ. REFERENCE NO.  
R-1015

SHEET NO.  
X-402

150 140 130 120 110 100 90 80 70 60 50 40 30 20 10 0 10 20 30 40 50 60 70 80 90 100 110 120 130 140 150

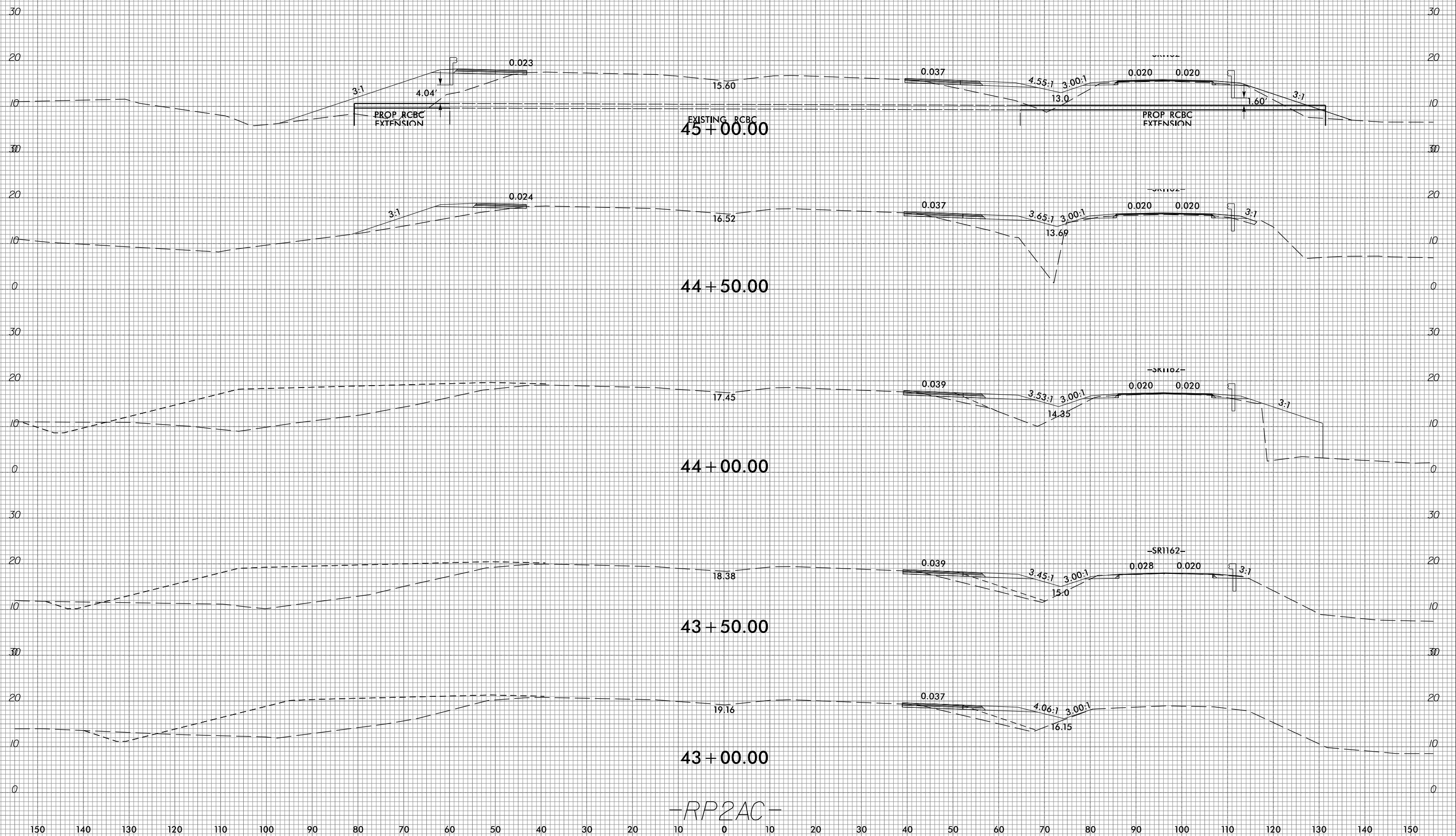

-RP2AC-

I:\2016\11\17\2016-02\CAD00\F1015\Roadway\XSC\F1015\_xp1\_RP2AC.dgn  
gncdlin

6/23/16



PROJ. REFERENCE NO.  
R-1015

SHEET NO.  
X-403

150 140 130 120 110 100 90 80 70 60 50 40 30 20 10 0 10 20 30 40 50 60 70 80 90 100 110 120 130 140 150

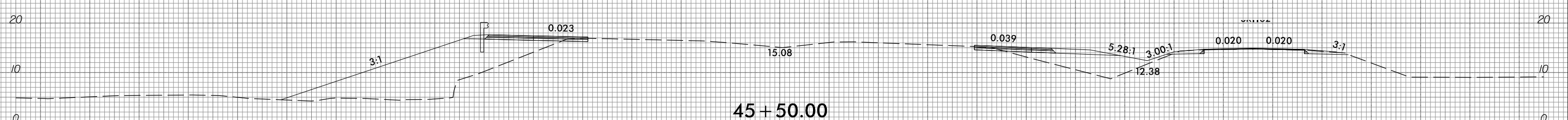
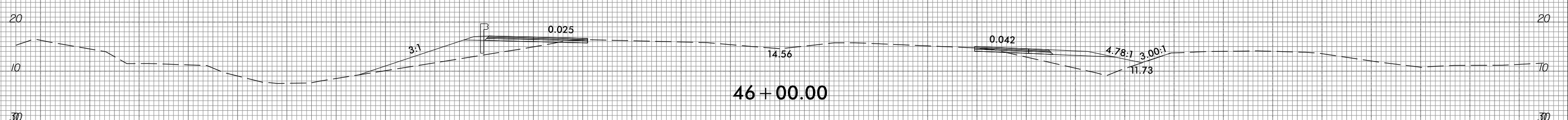
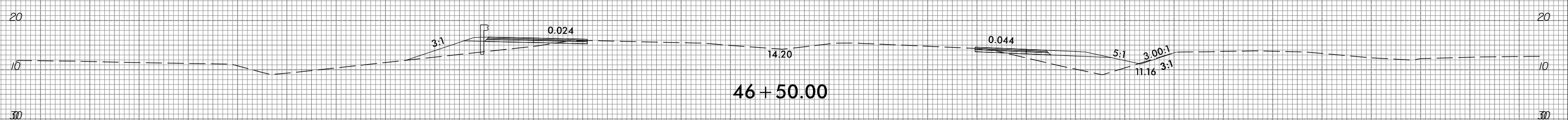
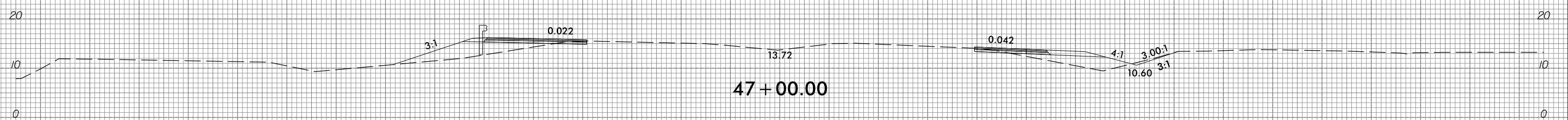
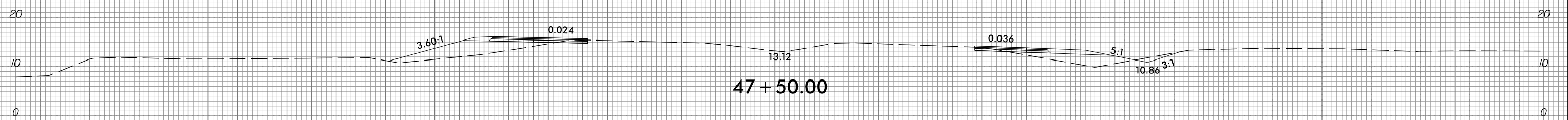
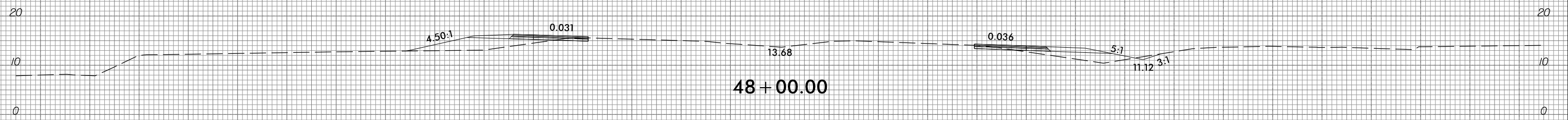

RP2AC

150 140 130 120 110 100 90 80 70 60 50 40 30 20 10 0 10 20 30 40 50 60 70 80 90 100 110 120 130 140 150

I:\2018-19\11-17-2018\11-17-2018-02\CADD\1015\Roadway\XSC\1015\_xp1\_RP2AC.dgn



150 140 130 120 110 100 90 80 70 60 50 40 30 20 10 0 10 20 30 40 50 60 70 80 90 100 110 120 130 140 150

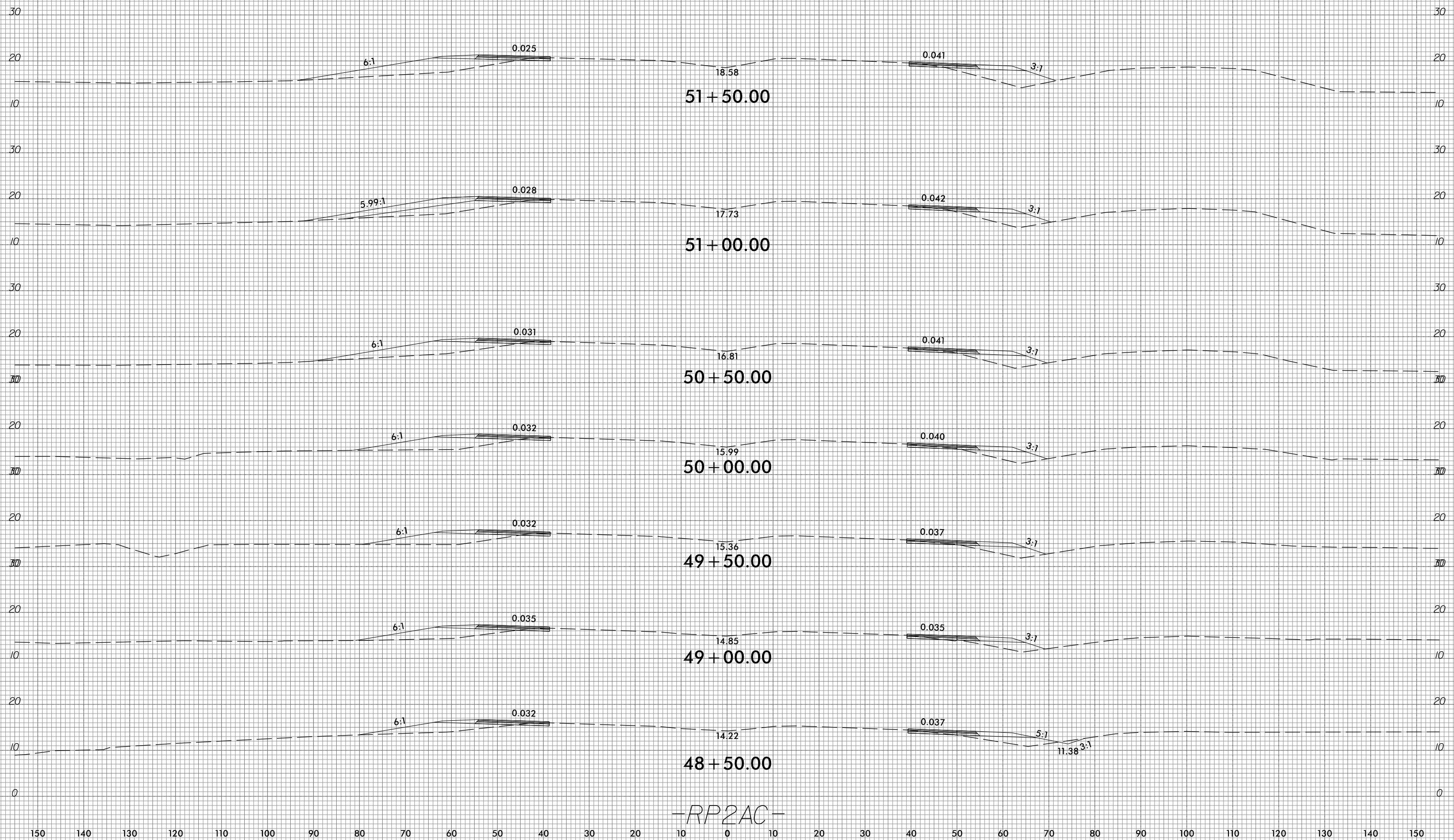

-RP2AC-

6/23/16



PROJ. REFERENCE NO.  
R-1015

SHEET NO.  
X-405

150 140 130 120 110 100 90 80 70 60 50 40 30 20 10 0 10 20 30 40 50 60 70 80 90 100 110 120 130 140 150

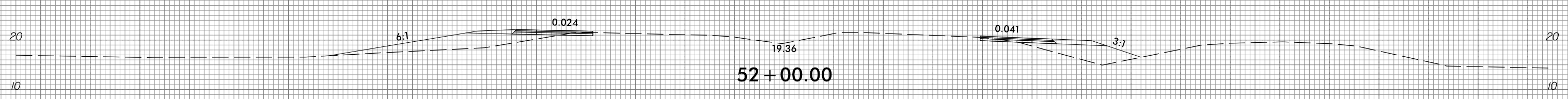
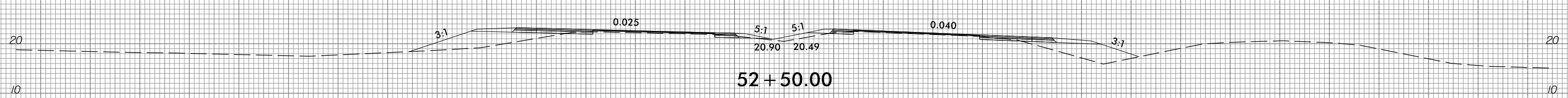
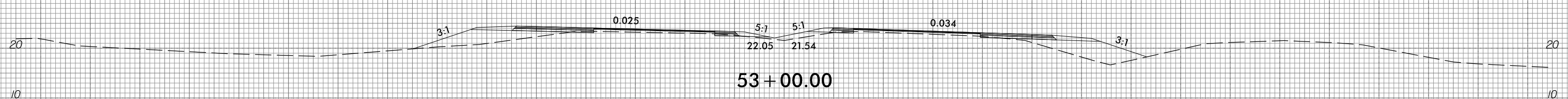
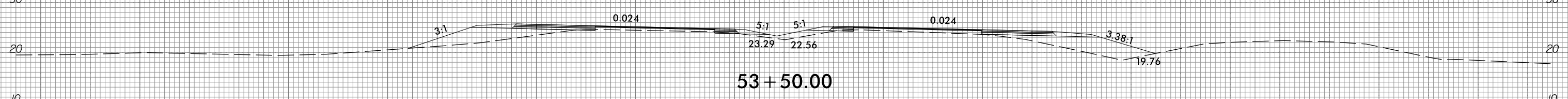
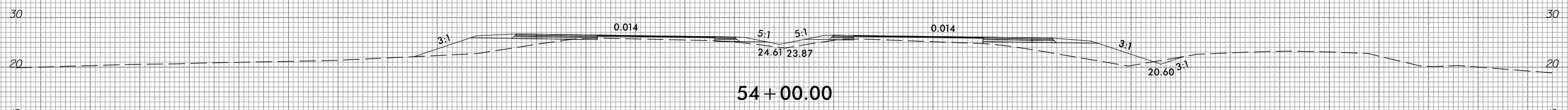
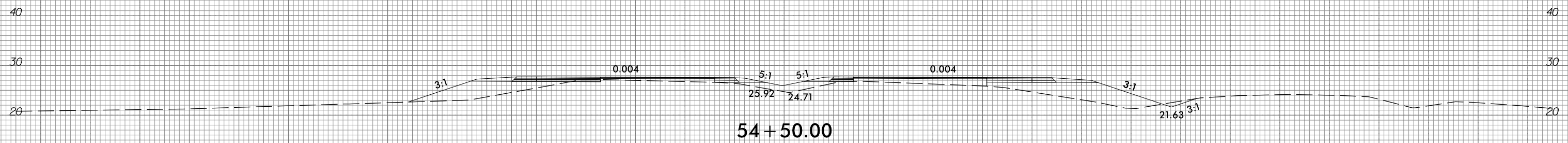

-RP2AC-

150 140 130 120 110 100 90 80 70 60 50 40 30 20 10 0 10 20 30 40 50 60 70 80 90 100 110 120 130 140 150

I:\2018-19\1729-02\CADD\1015\Roadway\XSC\1015\_xp1\_RP2AC.dgn  
gncdjin





6/23/16



PROJ. REFERENCE NO.  
R-1015

SHEET NO.  
X-407

150 140 130 120 110 100 90 80 70 60 50 40 30 20 10 0 10 20 30 40 50 60 70 80 90 100 110 120 130 140 150

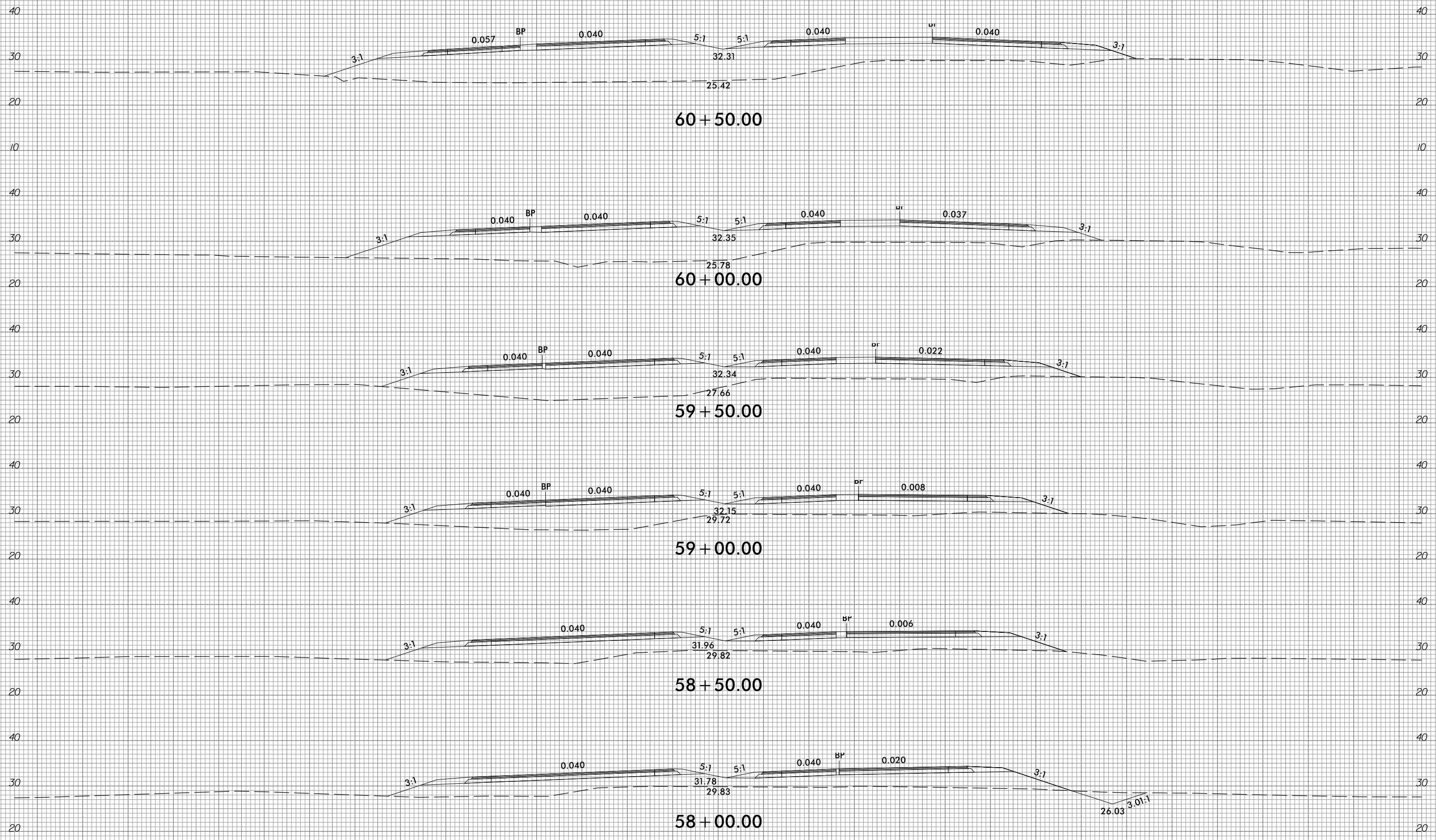

-RP2AC-

I:\2018-19\1729-02\CADD\1015\Roadway\XSC\1015\_xp1\_RP2AC.dgn  
gncdlin

150 140 130 120 110 100 90 80 70 60 50 40 30 20 10 0 10 20 30 40 50 60 70 80 90 100 110 120 130 140 150

6/23/16

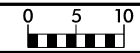

PROJ. REFERENCE NO.  
R-1015

SHEET NO.  
X-408

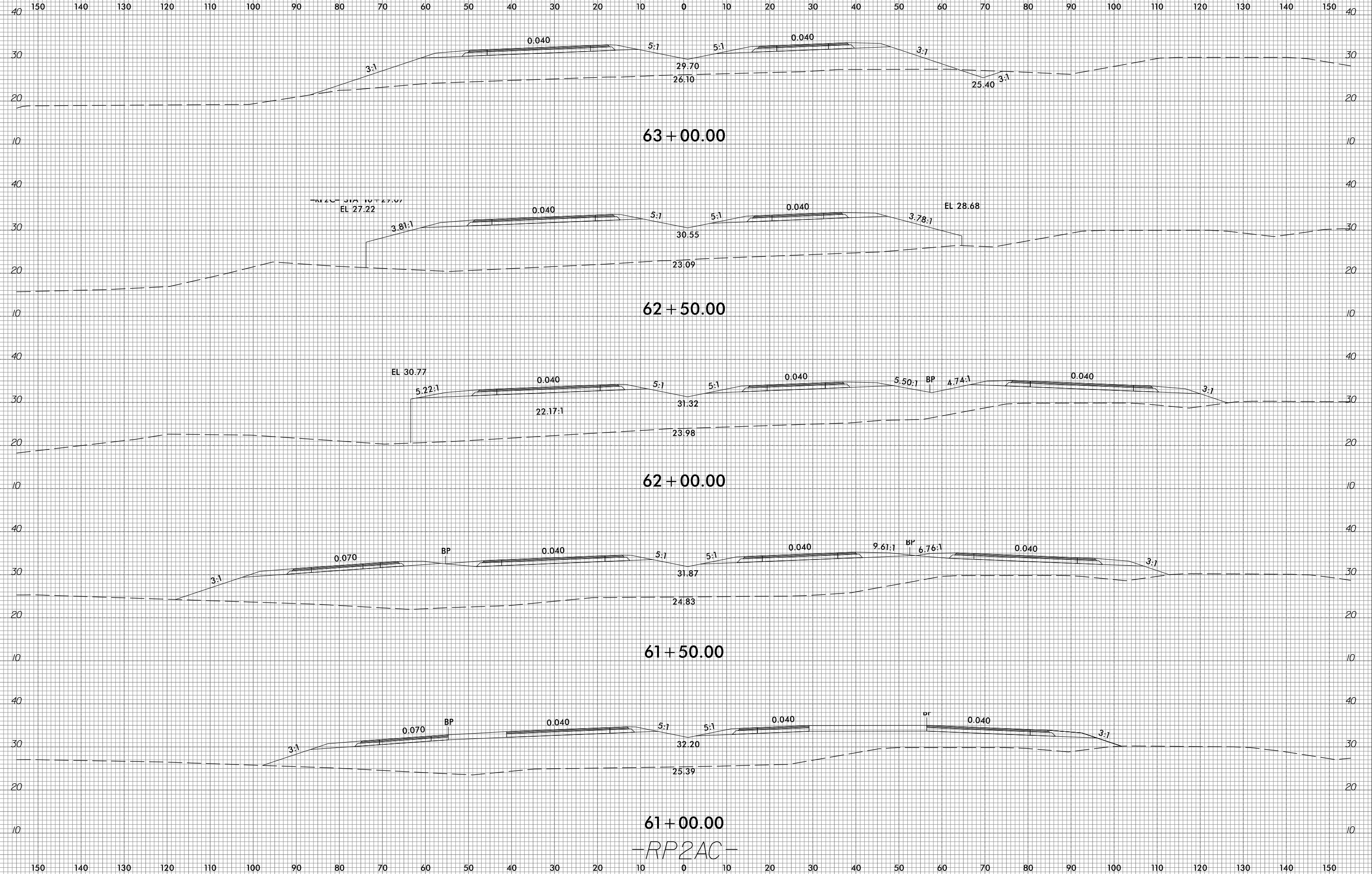

I:\2018-19\1729-02\CADD\1015\Roadway\XSC\1015\_xp1\_RP2AC.dgn  
gmc311

6/23/16



PROJ. REFERENCE NO.  
R-1015

SHEET NO.  
X-409

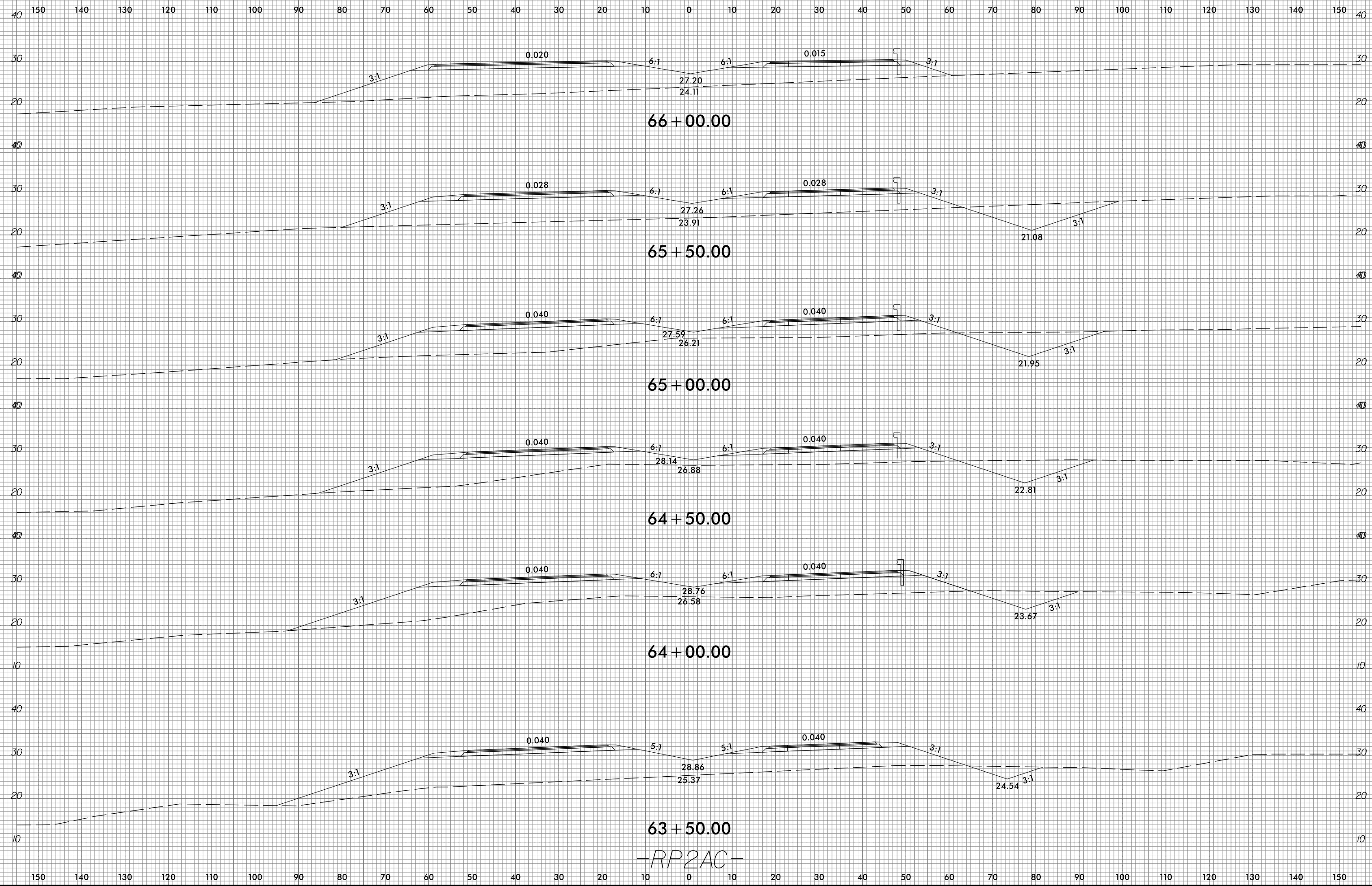

RP2AC

I:\2016\11\2016-02\11\2016-02\CAD\1015\Roadway\XSC\1015\_xp1\_RP2AC.dgn  
gncdlin



150 140 130 120 110 100 90 80 70 60 50 40 30 20 10 0 10 20 30 40 50 60 70 80 90 100 110 120 130 140 150

40 40

30 30

20 20

40 40

30 30

20 20

40 40

30 30

20 20

40 40

30 30

20 20

40 40

30 30

20 20

40 40

30 30

20 20

10 10

150 140 130 120 110 100 90 80 70 60 50 40 30 20 10 0 10 20 30 40 50 60 70 80 90 100 110 120 130 140 150

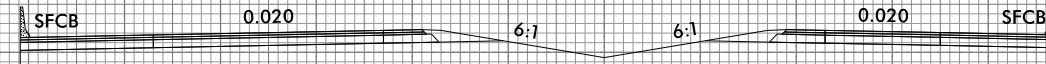

69+00.00

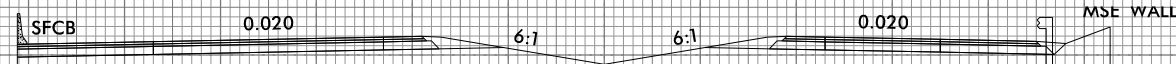

68+50.00

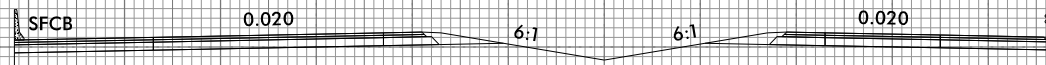

68+00.00

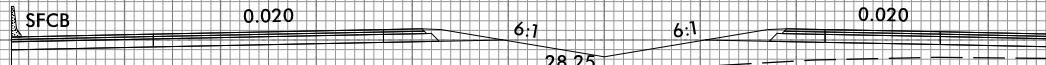

67+50.00

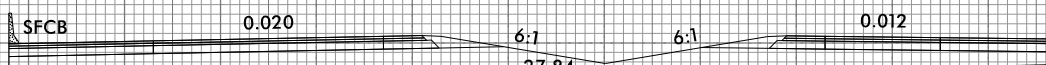

67+00.00

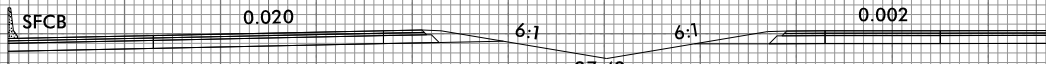

66+50.00

-RP2AC-

6/23/16



PROJ. REFERENCE NO.  
R-1015

SHEET NO.  
X-411

150 140 130 120 110 100 90 80 70 60 50 40 30 20 10 0 10 20 30 40 50 60 70 80 90 100 110 120 130 140 150

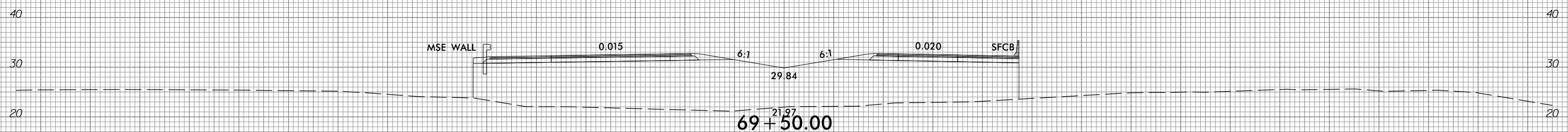
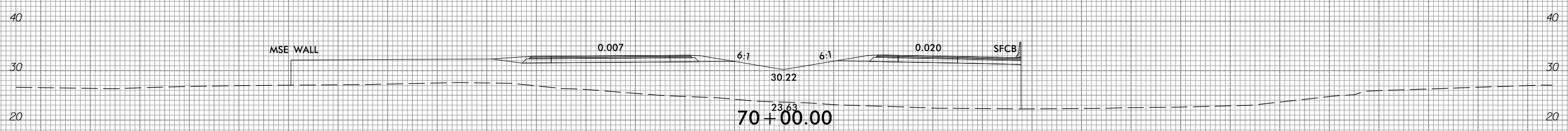
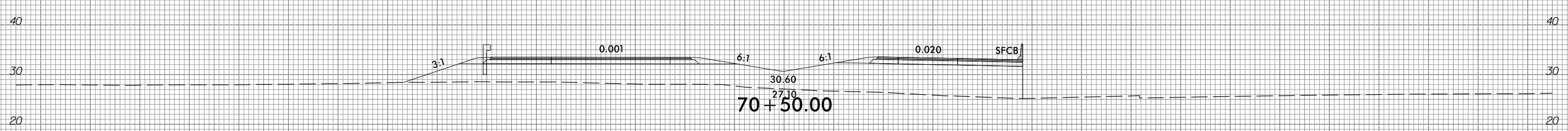
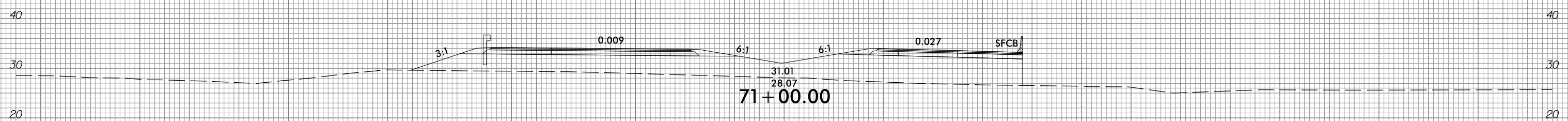
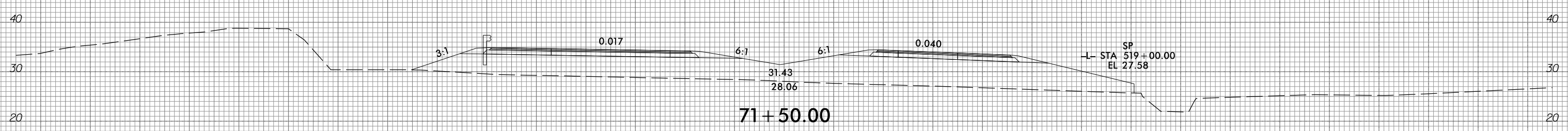
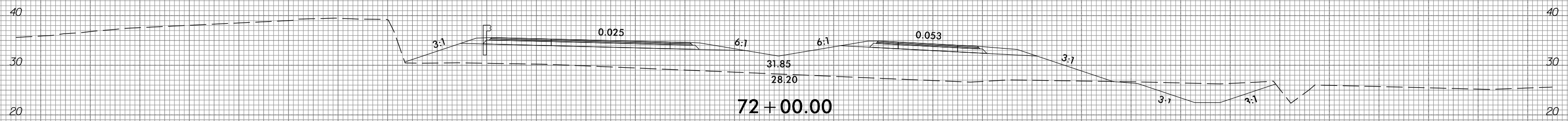

-RP2AC-

150 140 130 120 110 100 90 80 70 60 50 40 30 20 10 0 10 20 30 40 50 60 70 80 90 100 110 120 130 140 150

I:\2016\11\2016-19729-02\CADD\1015\Roadway\XSC\1015\_xp1\_RP2AC.dgn

6/23/16



PROJ. REFERENCE NO.  
R-1015

SHEET NO.  
X-412

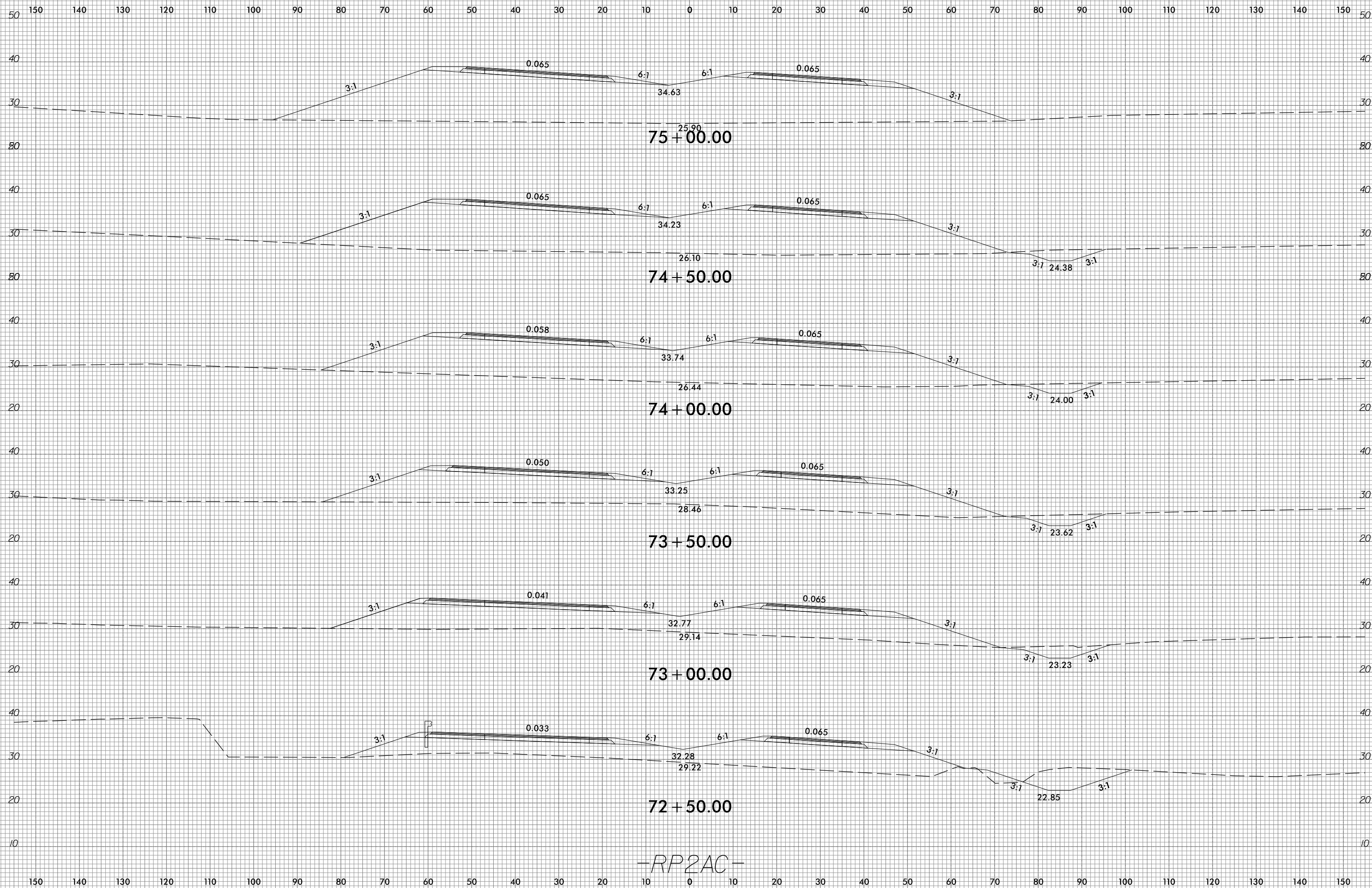

I:\2016\11\2016-02\11\2016-02\CADD\1015\Roadway\XSC\1015\_xp1\_RP2AC.dgn

RP2AC

6/23/16



PROJ. REFERENCE NO.	SHEET NO.
R-1015	X-413

150 140 130 120 110 100 90 80 70 60 50 40 30 20 10 0 10 20 30 40 50 60 70 80 90 100 110 120 130 140 150

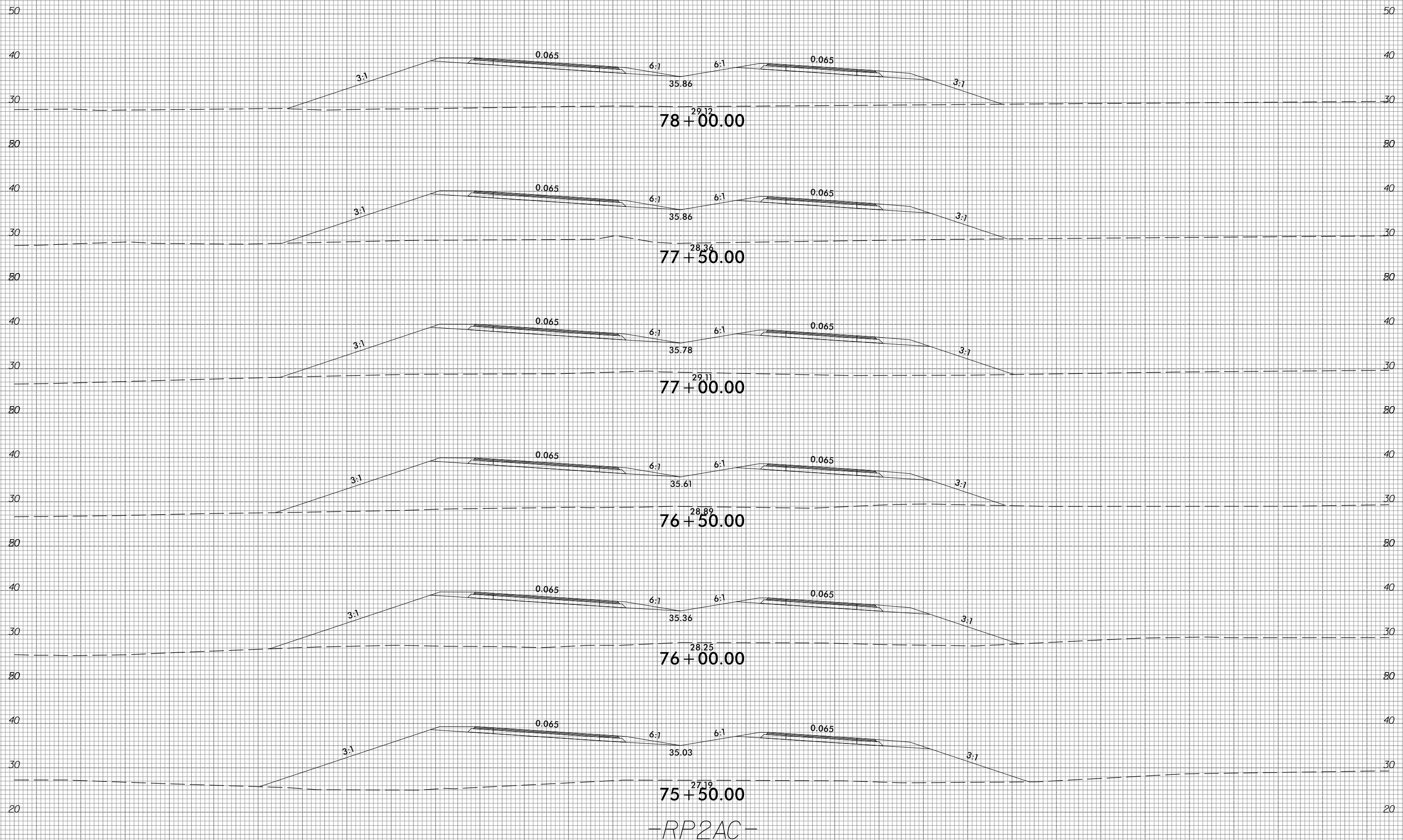

-RP2AC-

I:\2018  
 G:\FA\9729-02\CADD\1015\Roadway\XSC\1015\_xp1\_RP2AC.dgn  
 gncdlin

6/23/16



PROJ. REFERENCE NO.
R-1015

SHEET NO.
X-414

150 140 130 120 110 100 90 80 70 60 50 40 30 20 10 0 10 20 30 40 50 60 70 80 90 100 110 120 130 140 150

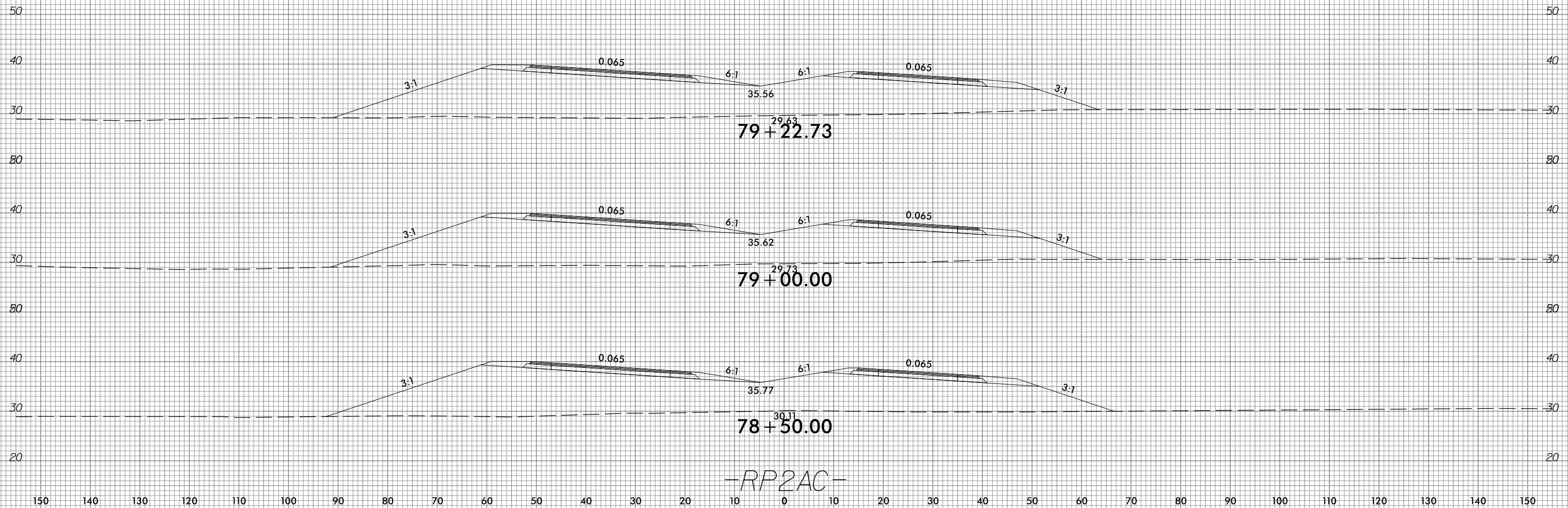

-RP2AC-

I:\2016\11\1\2016-02\CADD\1015\Roadway\XSC\1015\_xp1\_RP2AC.dgn  
gncdlin



6/23/16



PROJ. REFERENCE NO.	SHEET NO.
R-1015	X-415

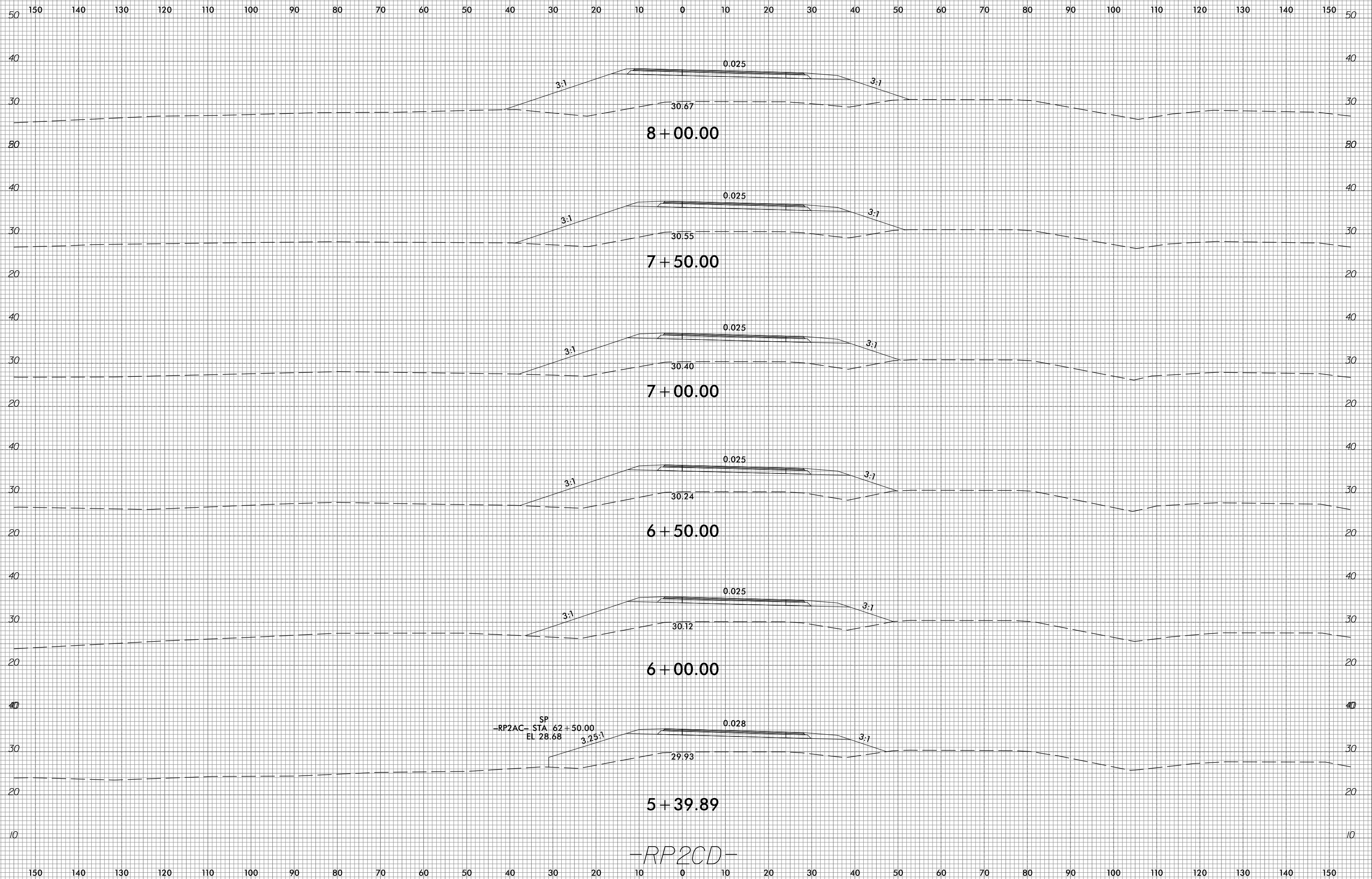

10/31/2018  
G:\RA\9729-02\CADD\1015\Roadway\XSC\1015\_xp1\_RP2CD.dgn  
gncdlin

6/23/16



PROJ. REFERENCE NO.	SHEET NO.
R-1015	X-416

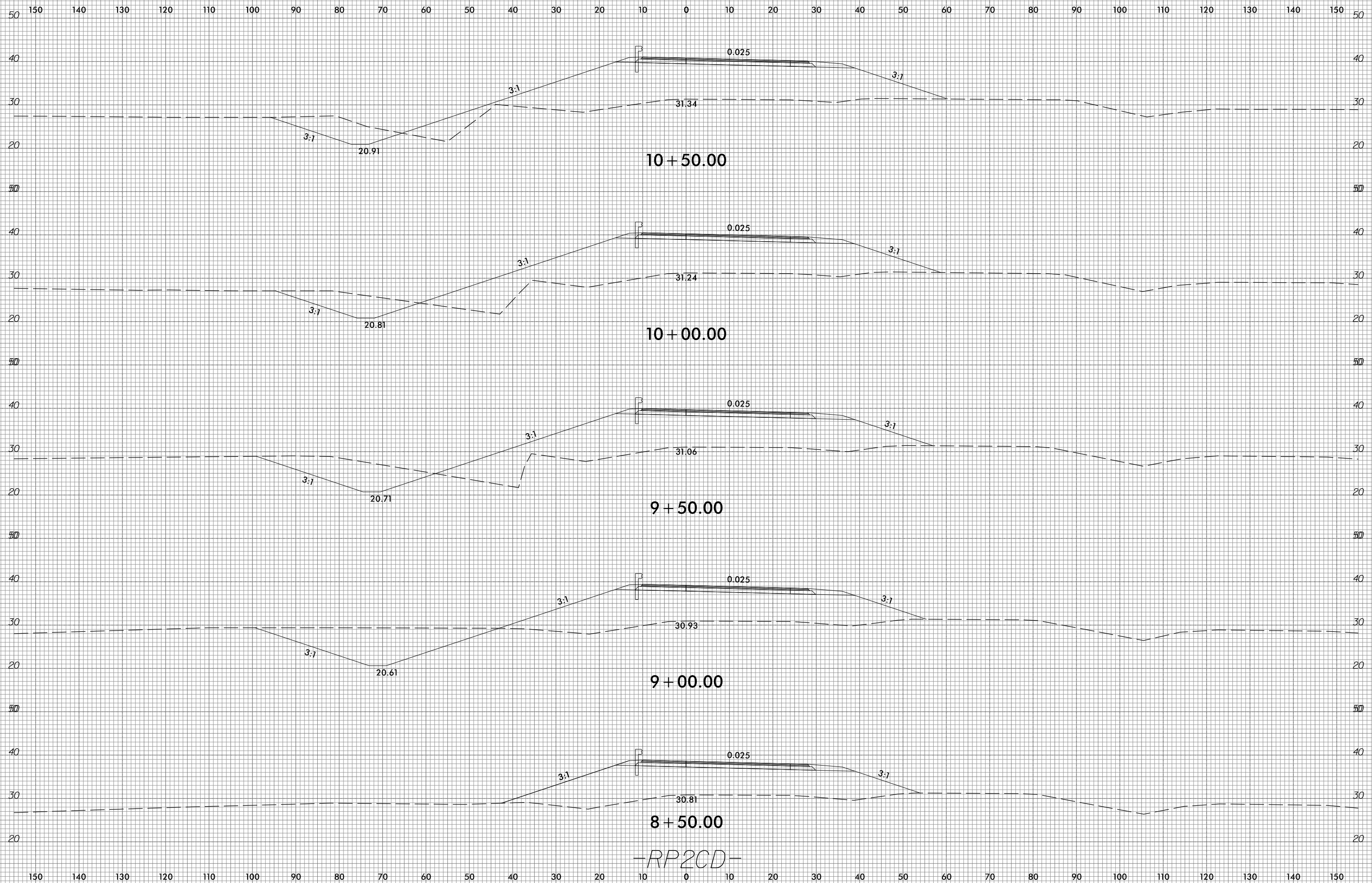

-RP2CD-

10/31/2018  
G:\RA\9729-02\CADD\1015\Roadway\XSC\1015\_xp1\_RP2CD.dgn  
gncdlin



150 140 130 120 110 100 90 80 70 60 50 40 30 20 10 0 10 20 30 40 50 60 70 80 90 100 110 120 130 140 150

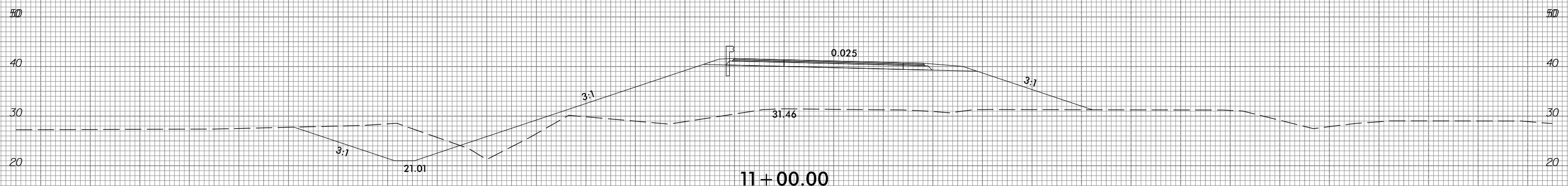
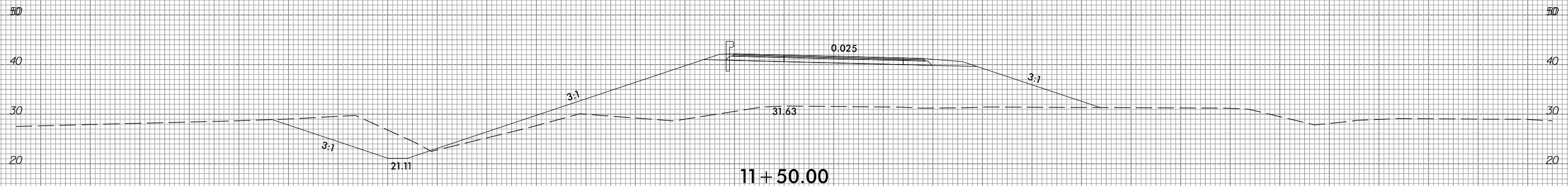
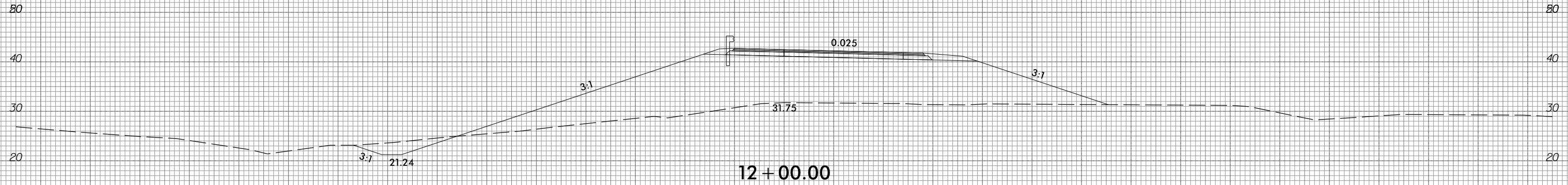
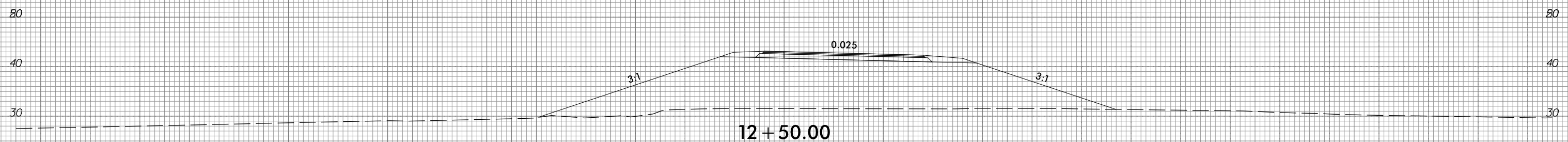
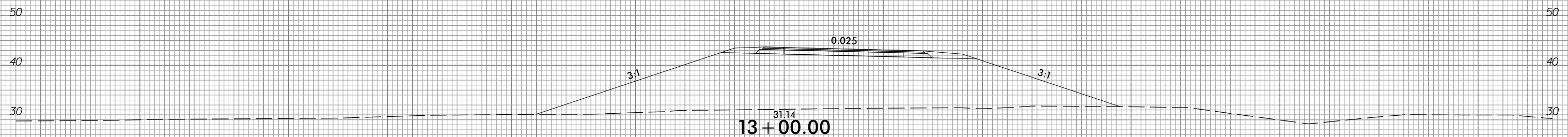

-RP2CD-

150 140 130 120 110 100 90 80 70 60 50 40 30 20 10 0 10 20 30 40 50 60 70 80 90 100 110 120 130 140 150



150 140 130 120 110 100 90 80 70 60 50 40 30 20 10 0 10 20 30 40 50 60 70 80 90 100 110 120 130 140 150

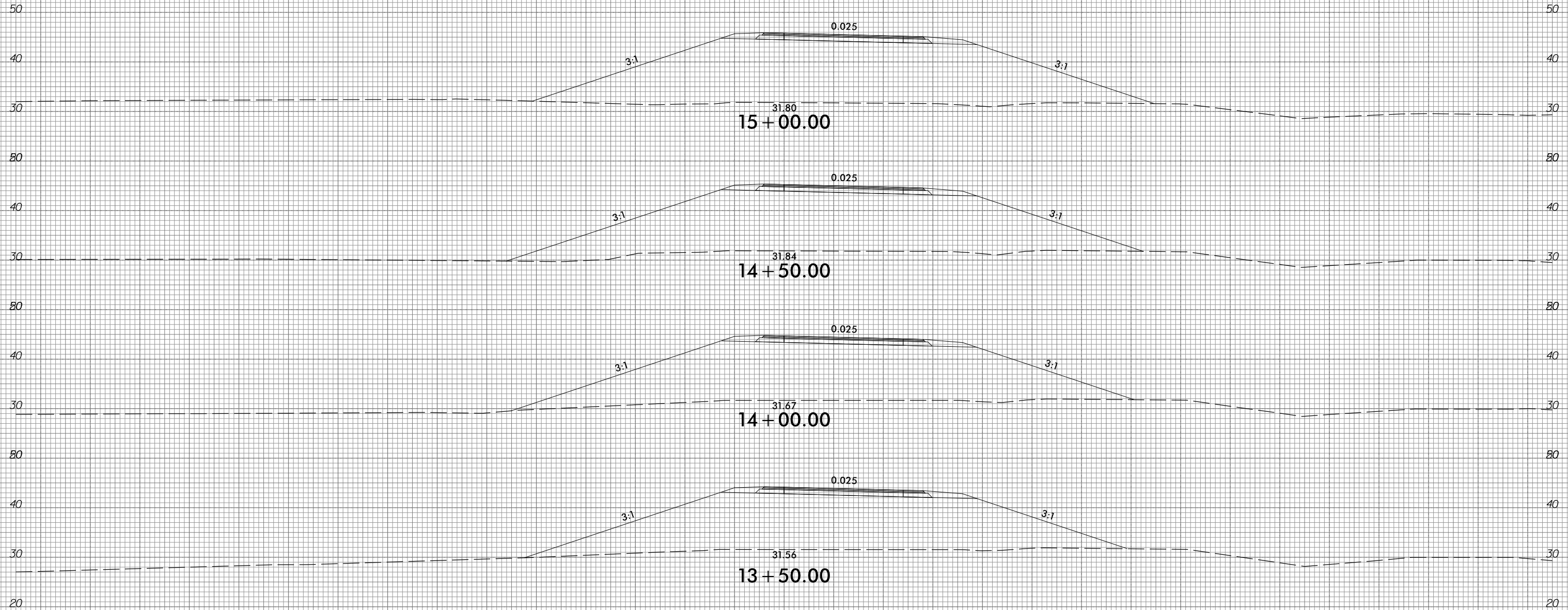

-RP2CD-

150 140 130 120 110 100 90 80 70 60 50 40 30 20 10 0 10 20 30 40 50 60 70 80 90 100 110 120 130 140 150



150 140 130 120 110 100 90 80 70 60 50 40 30 20 10 0 10 20 30 40 50 60 70 80 90 100 110 120 130 140 150

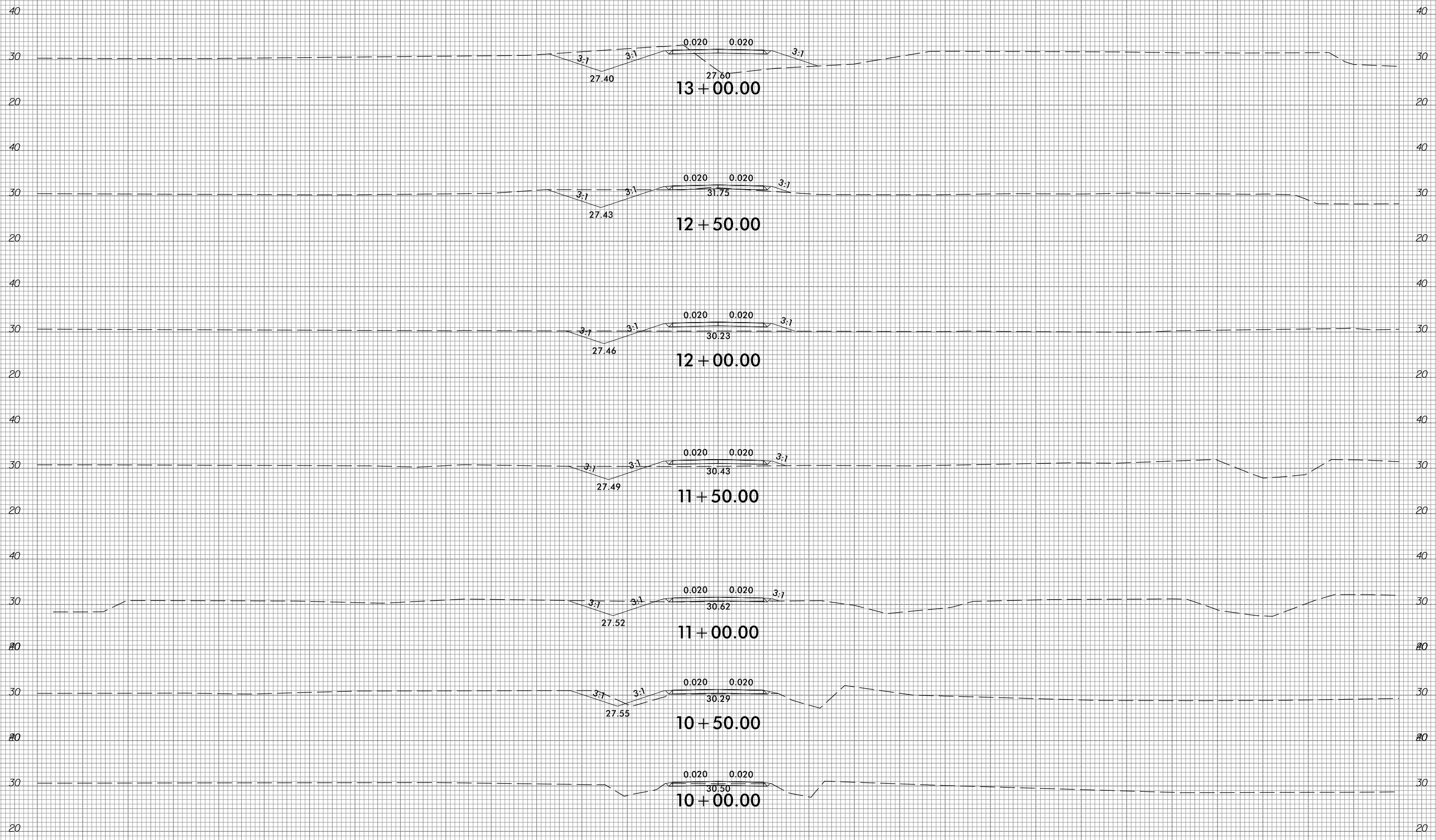

-DRI-

150 140 130 120 110 100 90 80 70 60 50 40 30 20 10 0 10 20 30 40 50 60 70 80 90 100 110 120 130 140 150

6/23/16



PROJ. REFERENCE NO.  
R-1015

SHEET NO.  
X-420

150 140 130 120 110 100 90 80 70 60 50 40 30 20 10 0 10 20 30 40 50 60 70 80 90 100 110 120 130 140 150

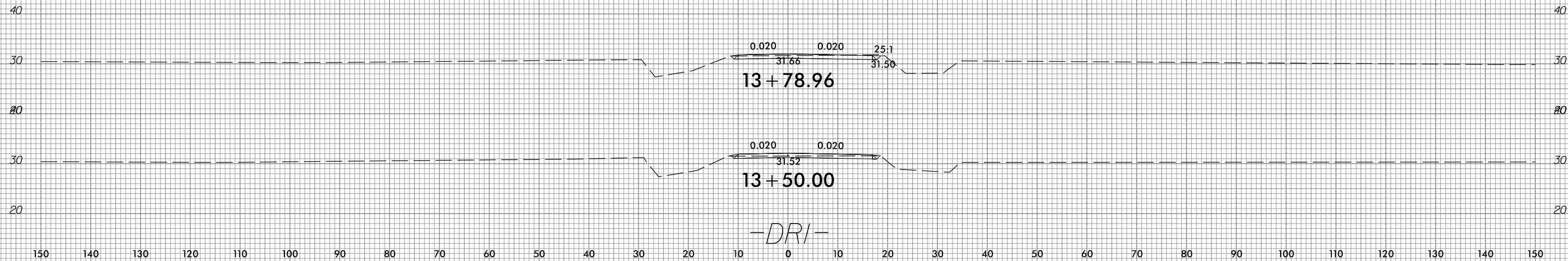

10/31/2018  
G:\RA\9729-02\CADD\1015\Roadway\XSC\1015\_xp1.DRI.dgn  
gncdlin

150 140 130 120 110 100 90 80 70 60 50 40 30 20 10 0 10 20 30 40 50 60 70 80 90 100 110 120 130 140 150

6/23/16



PROJ. REFERENCE NO.  
R-1015

SHEET NO.  
X-421

150 140 130 120 110 100 90 80 70 60 50 40 30 20 10 0 10 20 30 40 50 60 70 80 90 100 110 120 130 140 150

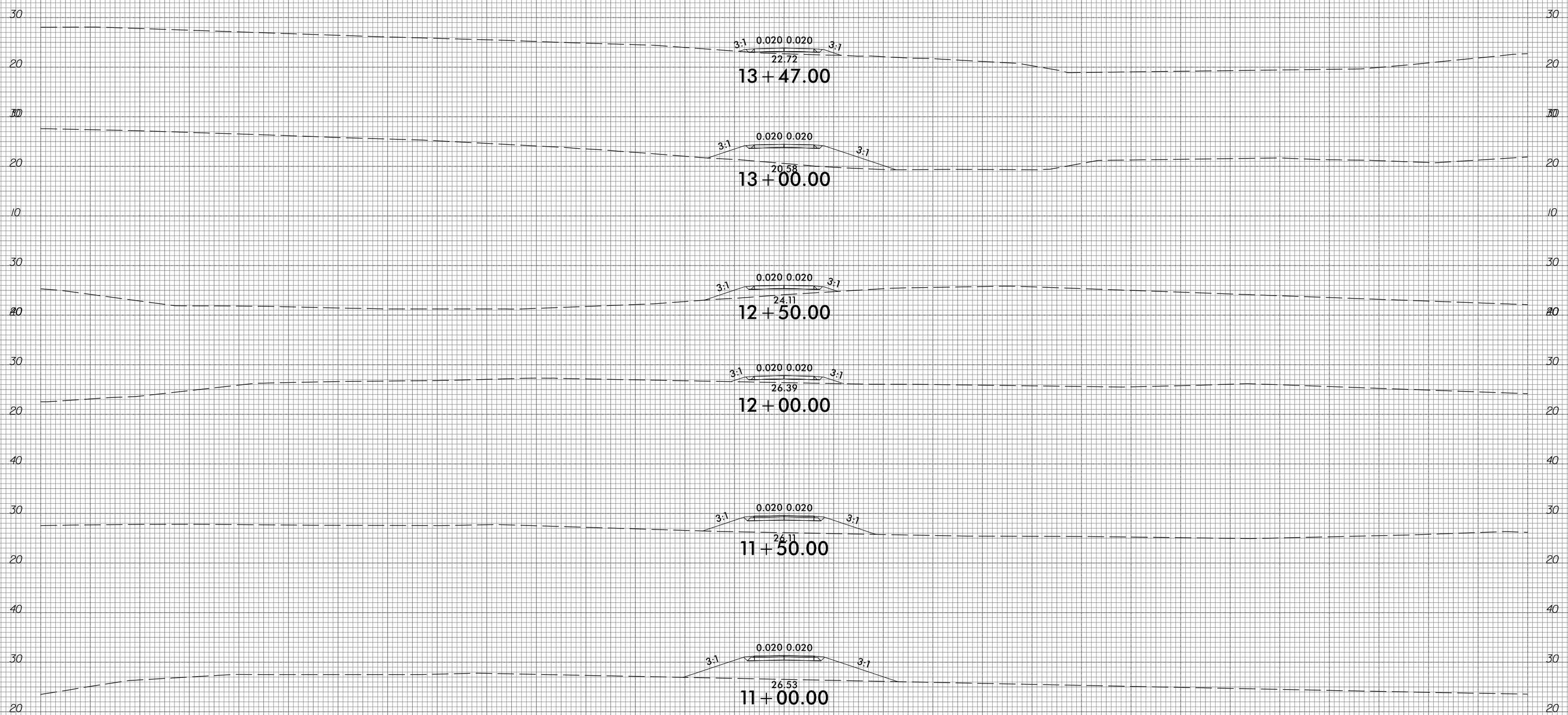

-G/2-

10/31/2018  
G:\RA\9729-02\CADD\1015\Roadway\XSC\1015\_xp1\_G12.dgn  
gncdlin

150 140 130 120 110 100 90 80 70 60 50 40 30 20 10 0 10 20 30 40 50 60 70 80 90 100 110 120 130 140 150

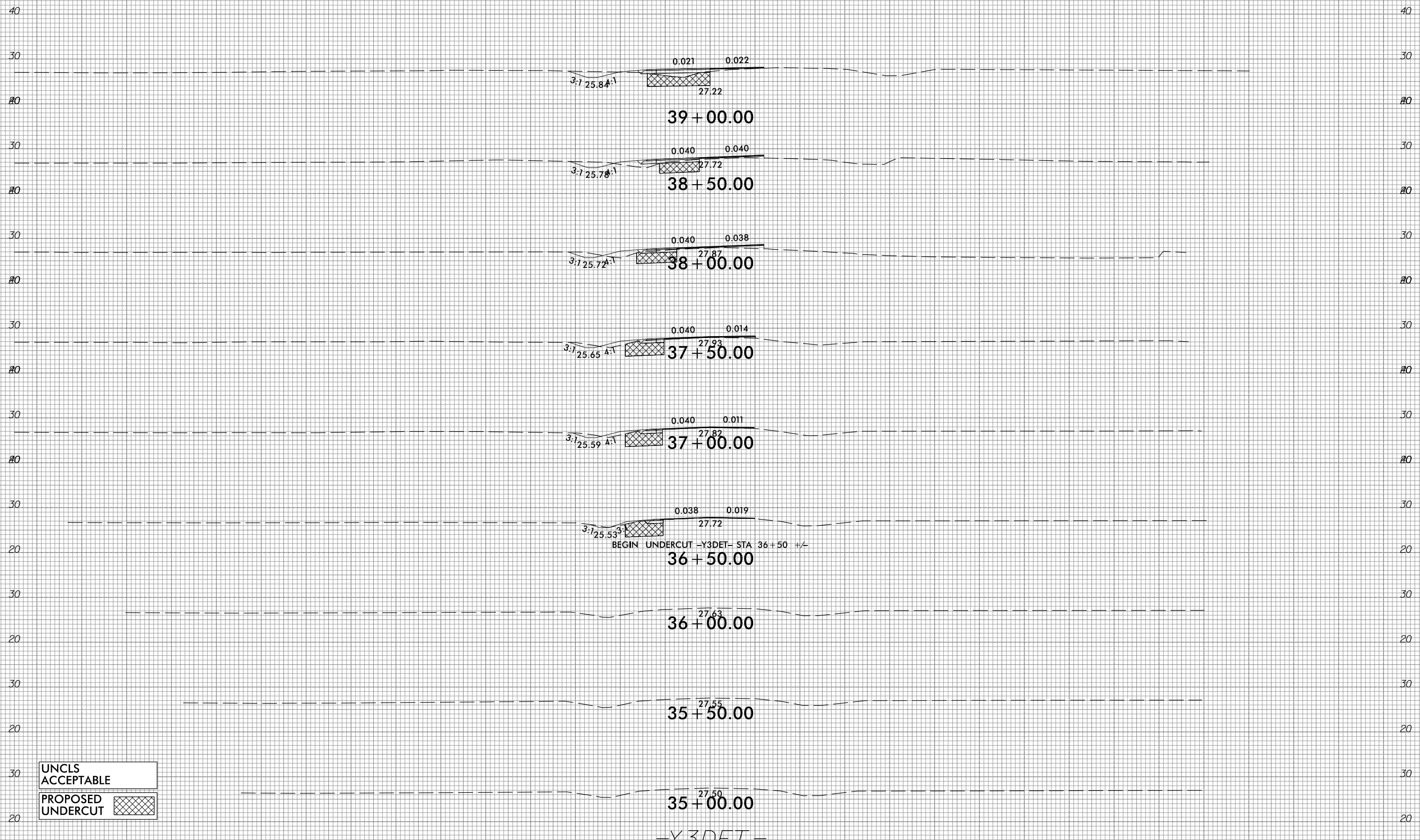

UNCLS  
ACCEPTABLE

PROPOSED  
UNDERCUT

-Y3DET-



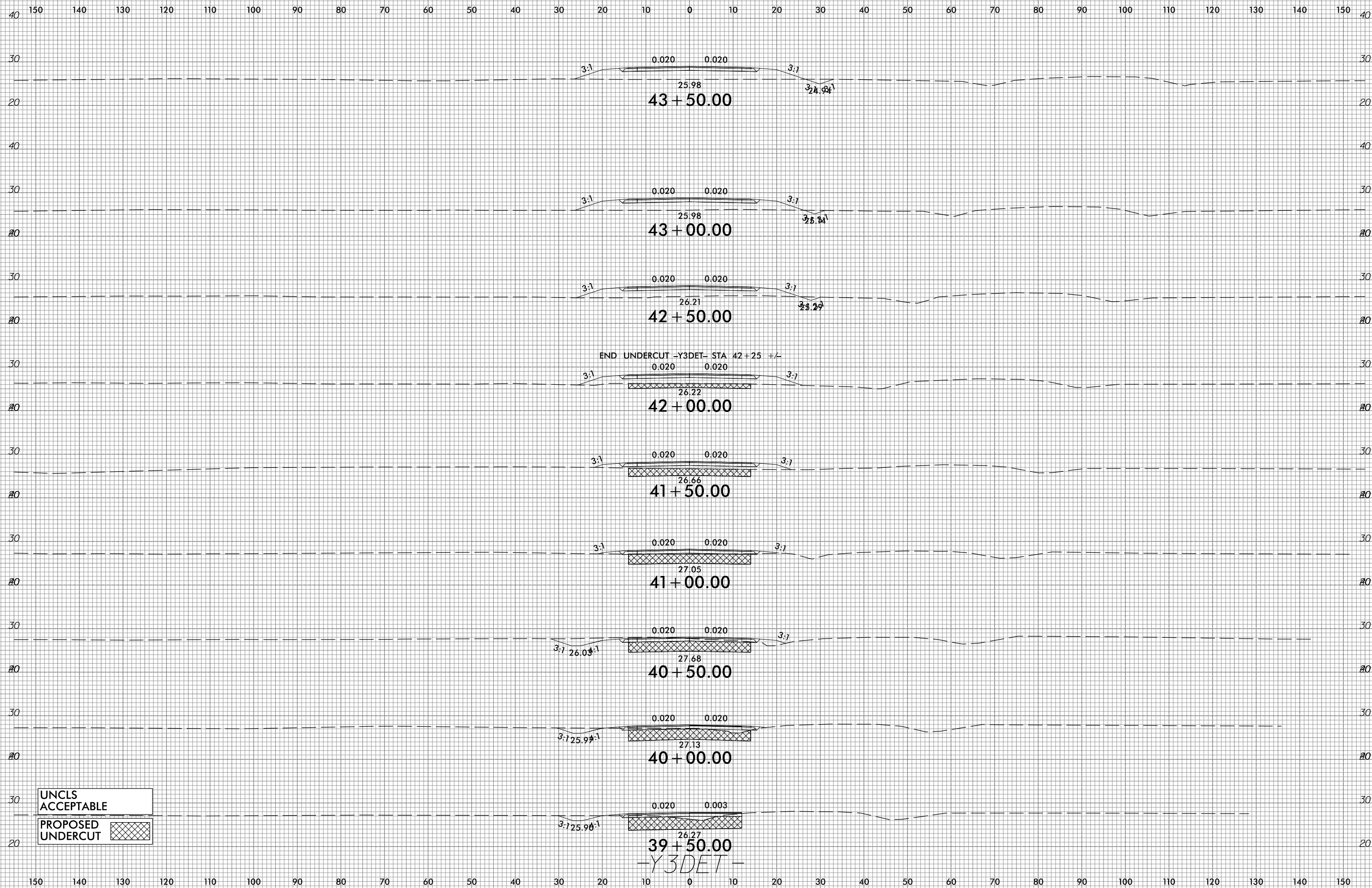

UNCLS  
ACCEPTABLE

PROPOSED  
UNDERCUT



6/23/16



PROJ. REFERENCE NO.  
R-1015

SHEET NO.  
X-424

150 140 130 120 110 100 90 80 70 60 50 40 30 20 10 0 10 20 30 40 50 60 70 80 90 100 110 120 130 140 150

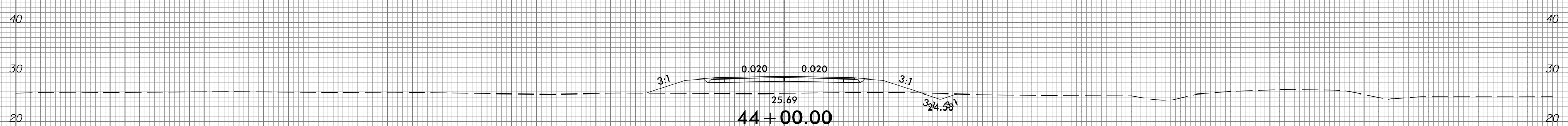
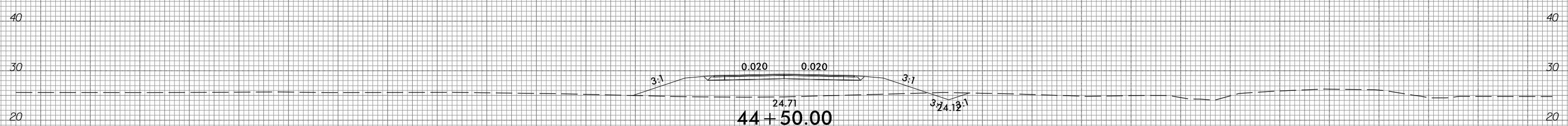
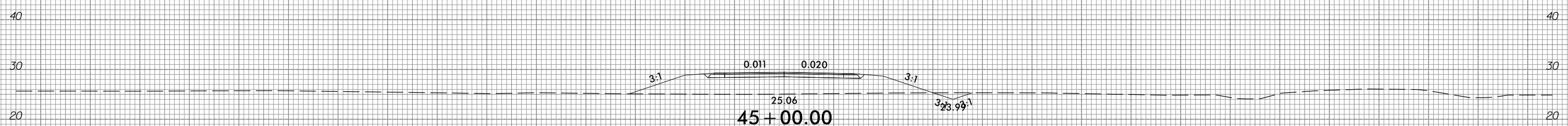
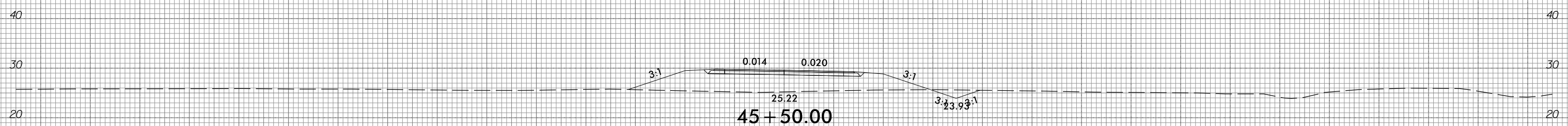
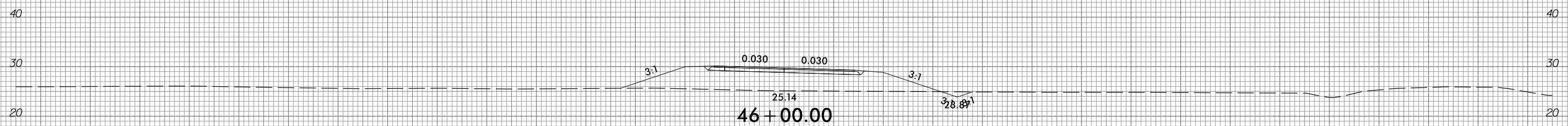
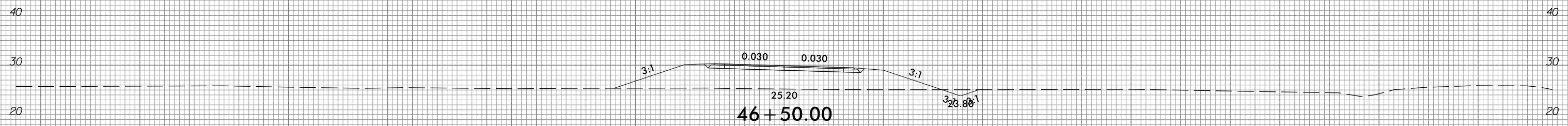

-Y3DET-

150 140 130 120 110 100 90 80 70 60 50 40 30 20 10 0 10 20 30 40 50 60 70 80 90 100 110 120 130 140 150

10/31/2018  
G:\RA\9729-02\CADD\1015\Roadway\XSC\1015\_xp1\_Y3DET.dgn  
gncdlin

6/23/16



PROJ. REFERENCE NO.  
R-1015

SHEET NO.  
X-425

150 140 130 120 110 100 90 80 70 60 50 40 30 20 10 0 10 20 30 40 50 60 70 80 90 100 110 120 130 140 150

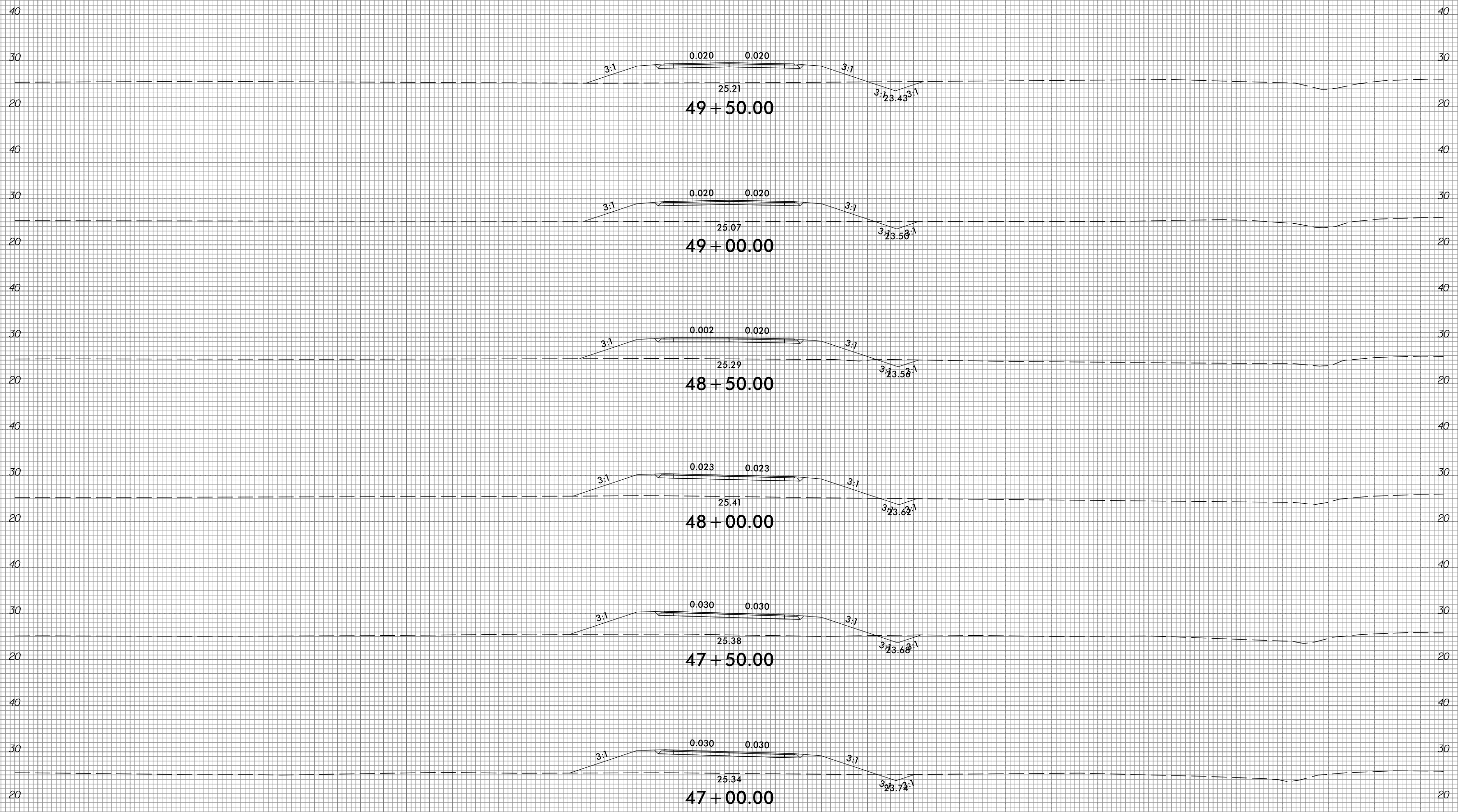

-Y3DET-

10/31/2018  
G:\RA\9729-02\CADD\1015\Roadway\XSC\1015\_xpl.Y3DET.dgn  
gncdlin

6/23/16



PROJ. REFERENCE NO.  
R-1015

SHEET NO.  
X-426

150 140 130 120 110 100 90 80 70 60 50 40 30 20 10 0 10 20 30 40 50 60 70 80 90 100 110 120 130 140 150

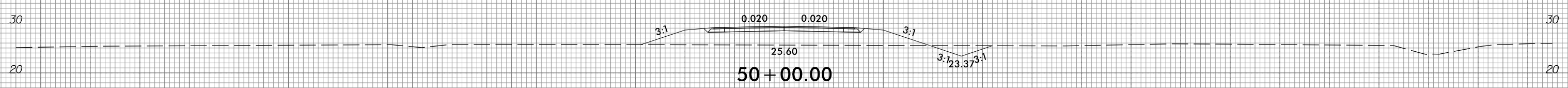
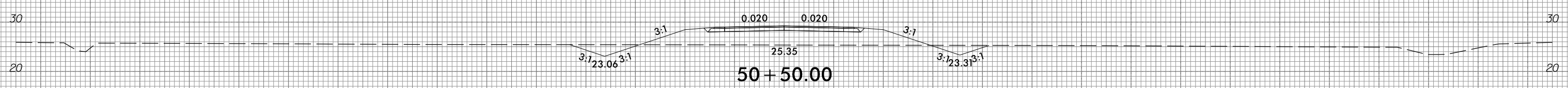
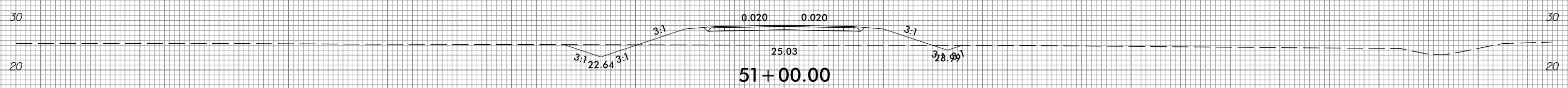
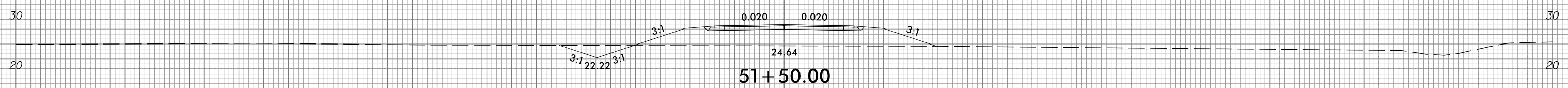
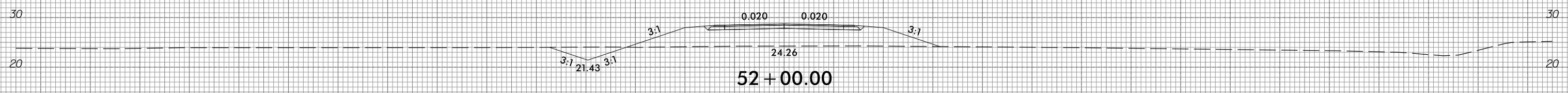
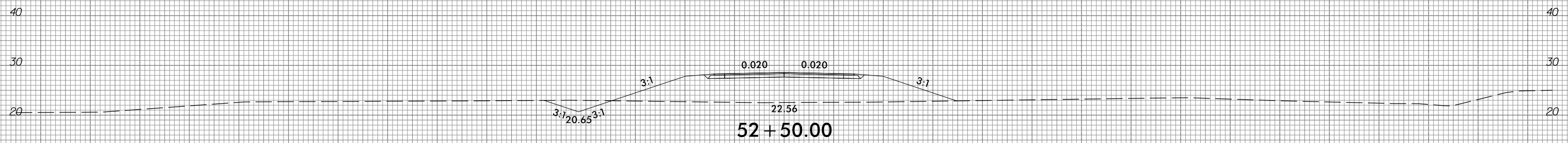

-Y3DET-

150 140 130 120 110 100 90 80 70 60 50 40 30 20 10 0 10 20 30 40 50 60 70 80 90 100 110 120 130 140 150

10/31/2018  
G:\RA\9729-02\CADD\1015\Roadway\XSC\1015\_xpl.Y3DET.dgn  
gncdlin

6/23/16



PROJ. REFERENCE NO.  
R-1015

SHEET NO.  
X-427

150 140 130 120 110 100 90 80 70 60 50 40 30 20 10 0 10 20 30 40 50 60 70 80 90 100 110 120 130 140 150

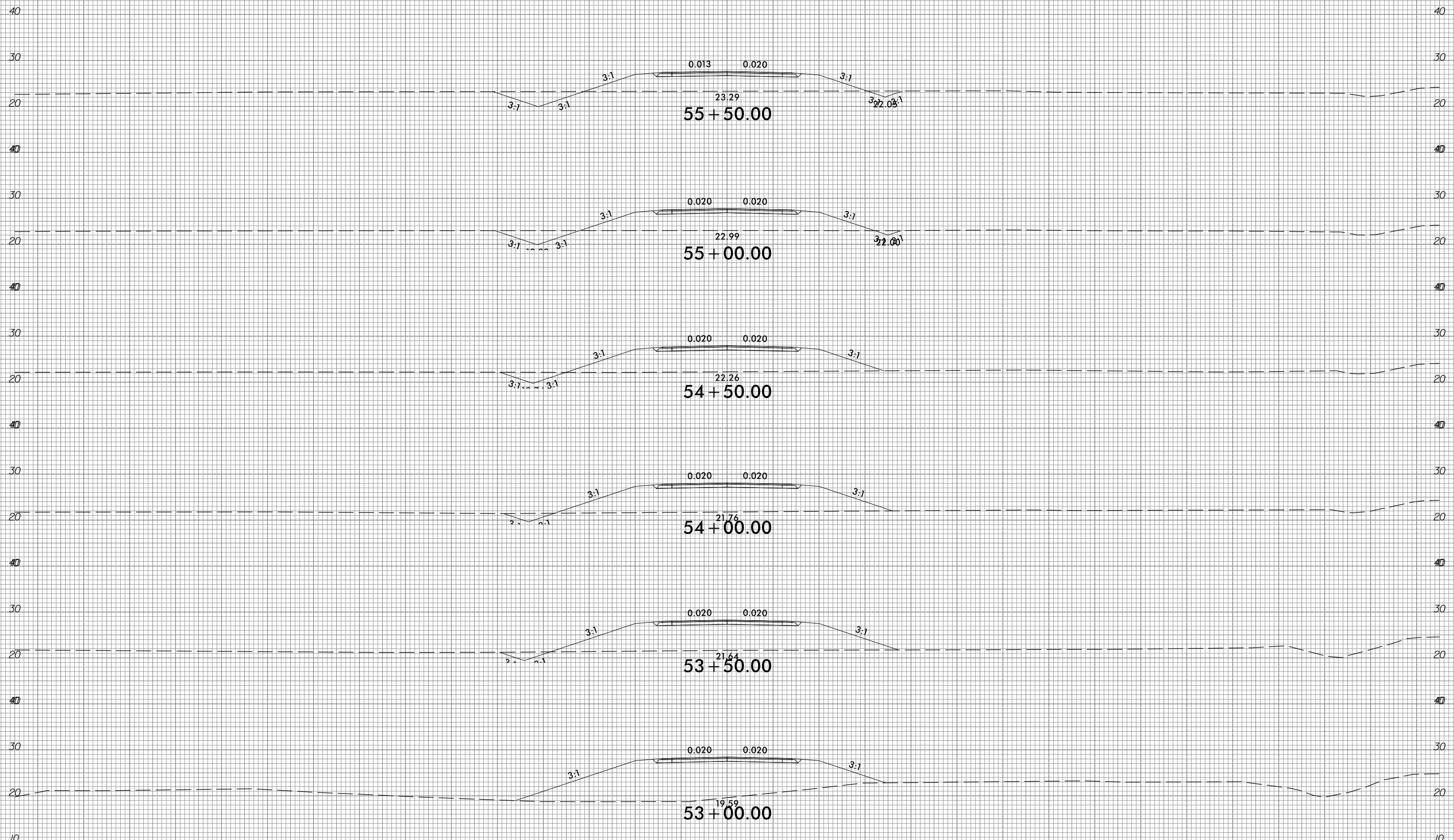

-Y3DET-

10/31/2018  
G:\RA\9729-02\CADD\1015\Roadway\XSC\1015\_xpl.Y3DET.dgn  
gncdlin

6/23/16



PROJ. REFERENCE NO.  
R-1015

SHEET NO.  
X-428

150 140 130 120 110 100 90 80 70 60 50 40 30 20 10 0 10 20 30 40 50 60 70 80 90 100 110 120 130 140 150

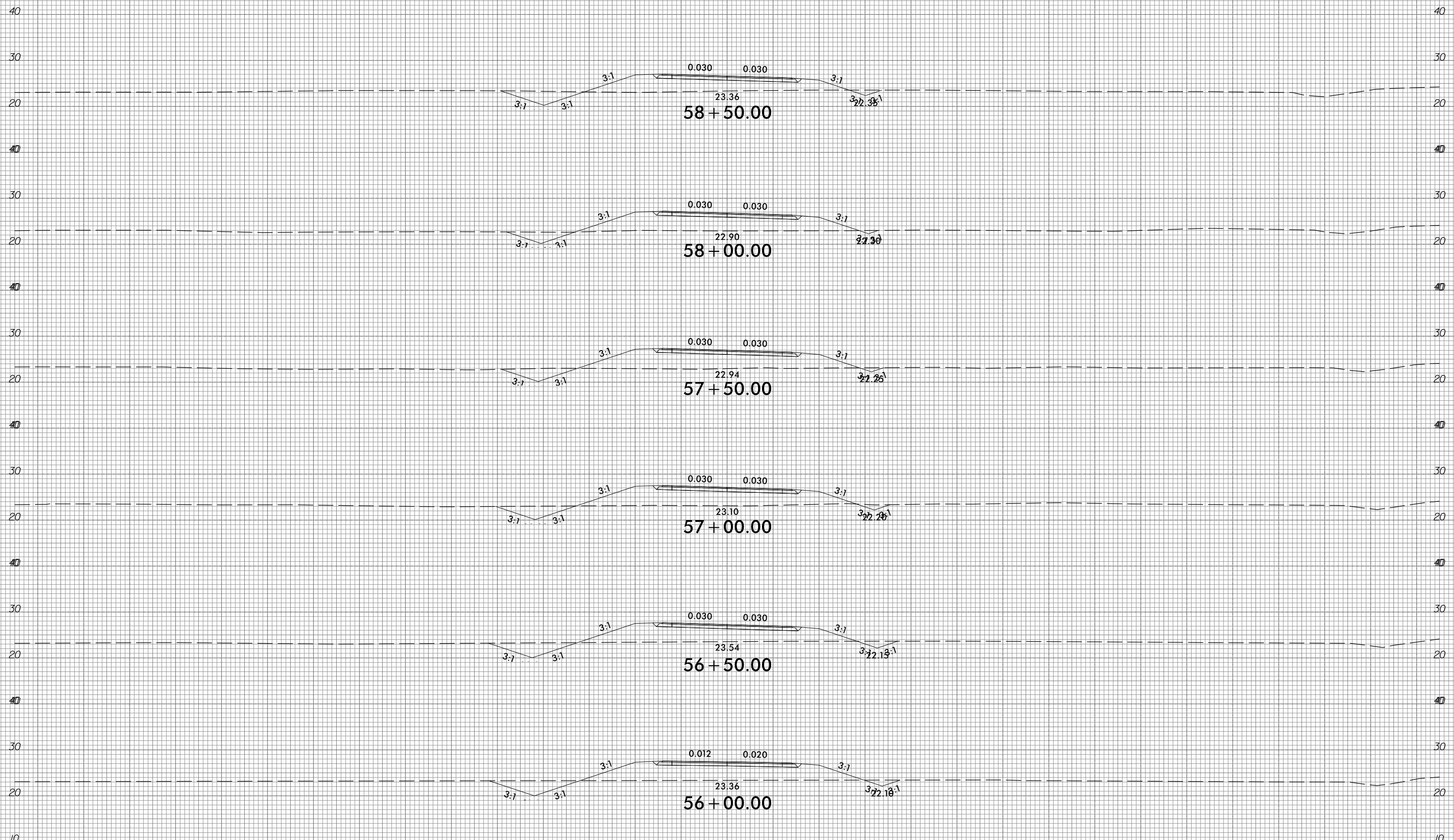

58 + 50.00

58 + 00.00

57 + 50.00

57 + 00.00

56 + 50.00

56 + 00.00

-Y3DET-

10/31/2018  
G:\RA\9729-02\CADD\1015\Roadway\XSC\1015\_xpl.Y3DET.dgn  
gncdlin

6/23/16



PROJ. REFERENCE NO.  
R-1015

SHEET NO.  
X-429

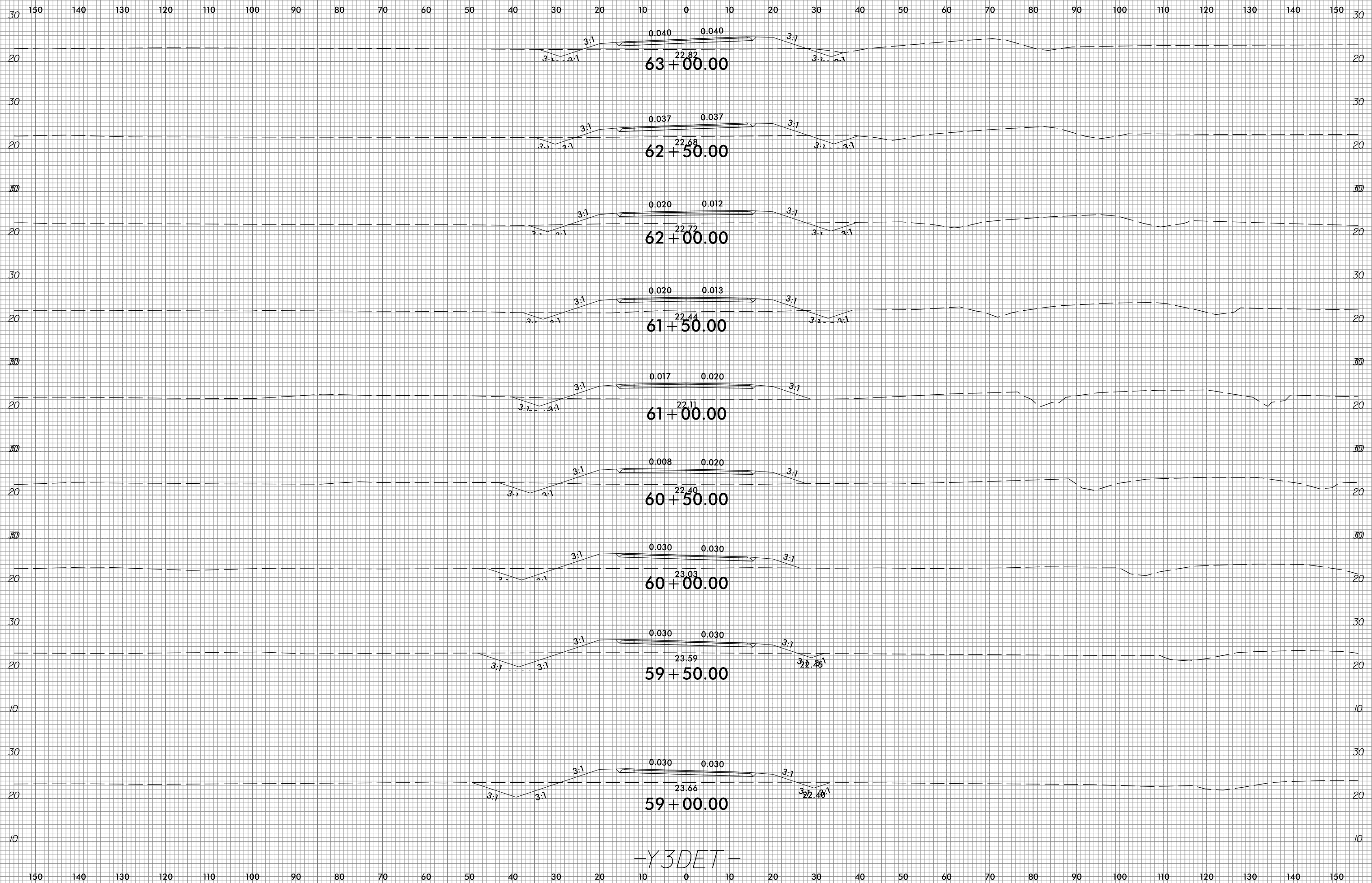

-Y3DET-

10/31/2018  
G:\RA\9729-02\CADD\1015\Roadway\XSC\1015\_xp1\_Y3DET.dgn  
gncdlin

6/23/16



PROJ. REFERENCE NO.  
R-1015

SHEET NO.  
X-430

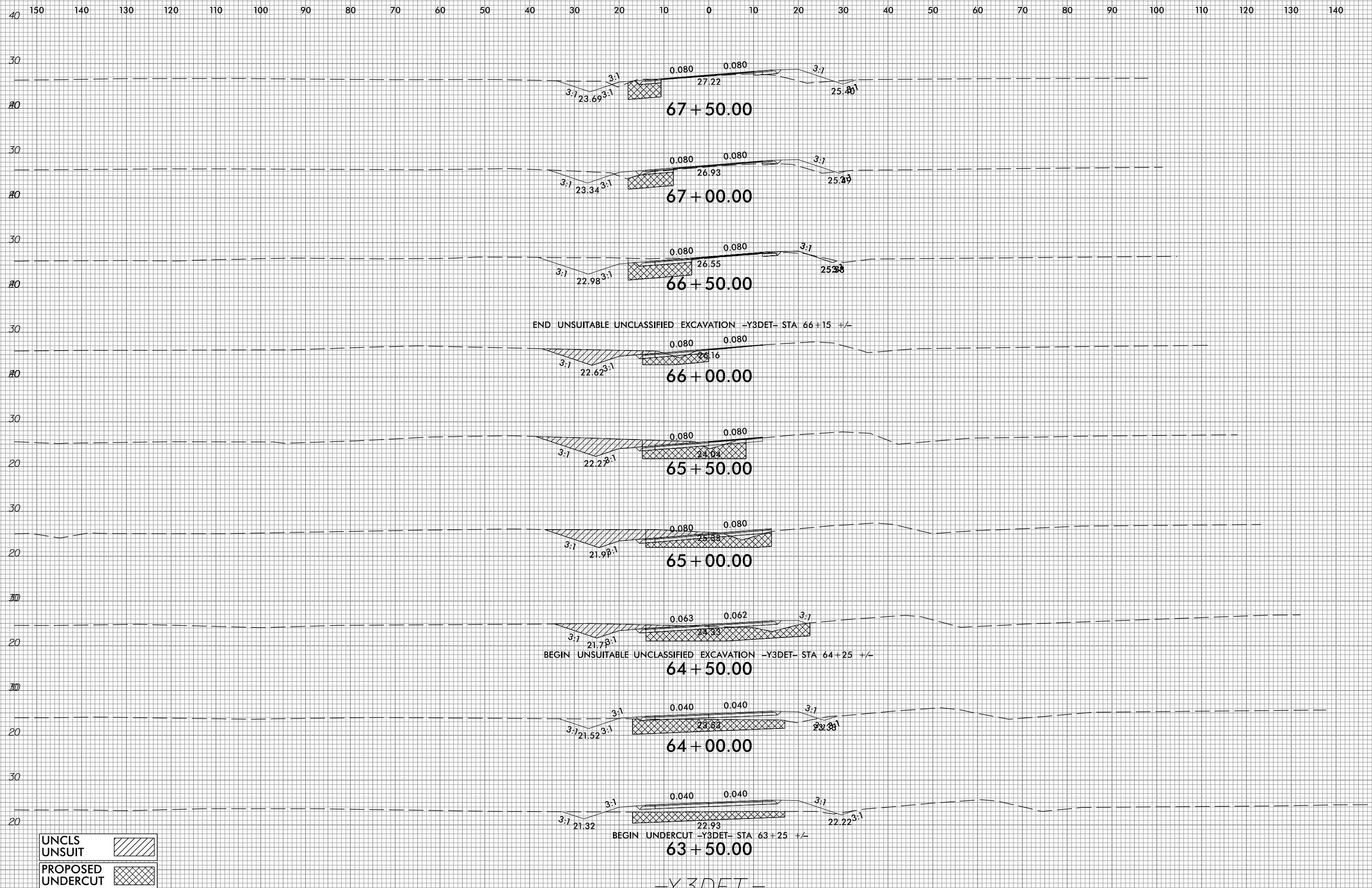

END UNSUITABLE UNCLASSIFIED EXCAVATION -Y3DET- STA 66+15 +/-

BEGIN UNSUITABLE UNCLASSIFIED EXCAVATION -Y3DET- STA 64+25 +/-

BEGIN UNDERCUT -Y3DET- STA 63+25 +/-

-Y3DET-

UNCLS UNSUIT	
PROPOSED UNDERCUT	

10/31/2018  
G:\RA\9729-02\CADD\1015\Roadway\XSC\1015\_xp1\_Y3DET.dgn  
gmc311



150 140 130 120 110 100 90 80 70 60 50 40 30 20 10 0 10 20 30 40 50 60 70 80 90 100 110 120 130 140 150

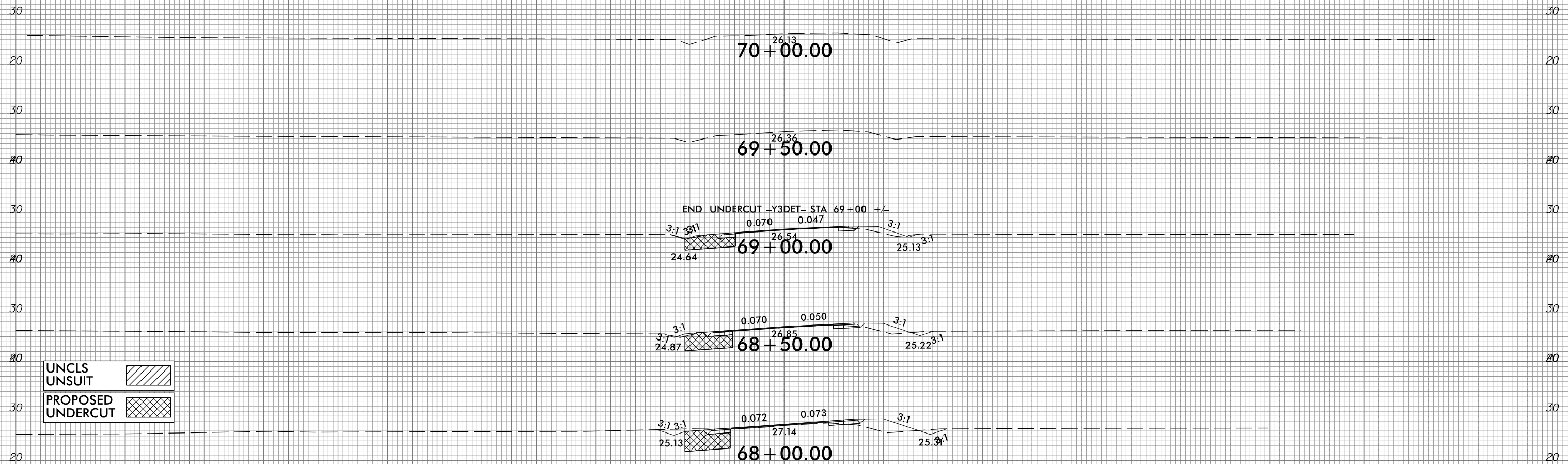

UNCLS UNSUIT	
PROPOSED UNDERCUT	

150 140 130 120 110 100 90 80 70 60 50 40 30 20 10 0 10 20 30 40 50 60 70 80 90 100 110 120 130 140 150



6/23/16



PROJ. REFERENCE NO. R-1015	SHEET NO. X-433
-------------------------------	--------------------

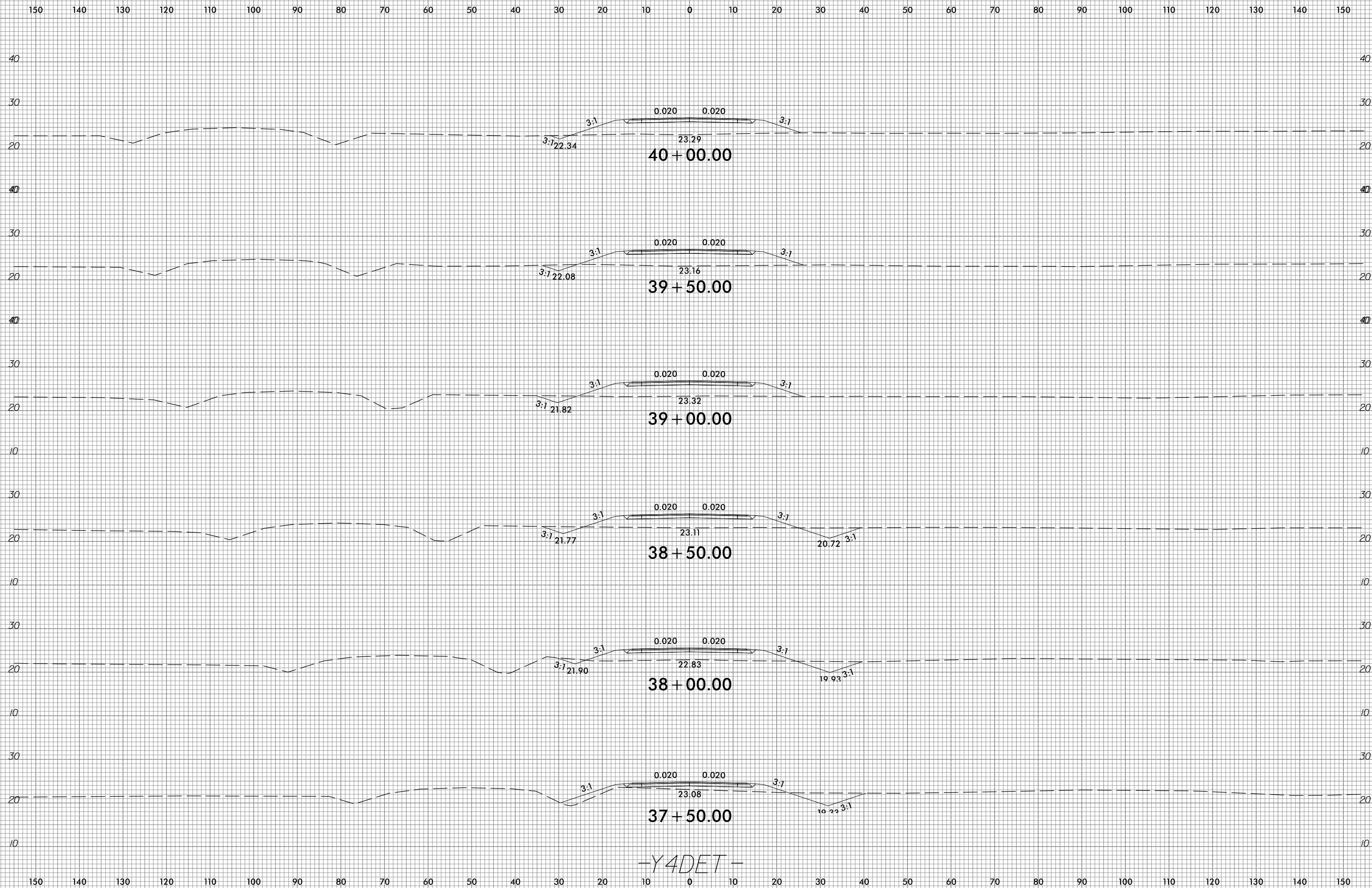

-Y4DET-

I:\2008\11\2\2008\11\2\CA00\1015\Roadway\XSC\1015\_xpl\_Y4DET.dgn  
gnc011

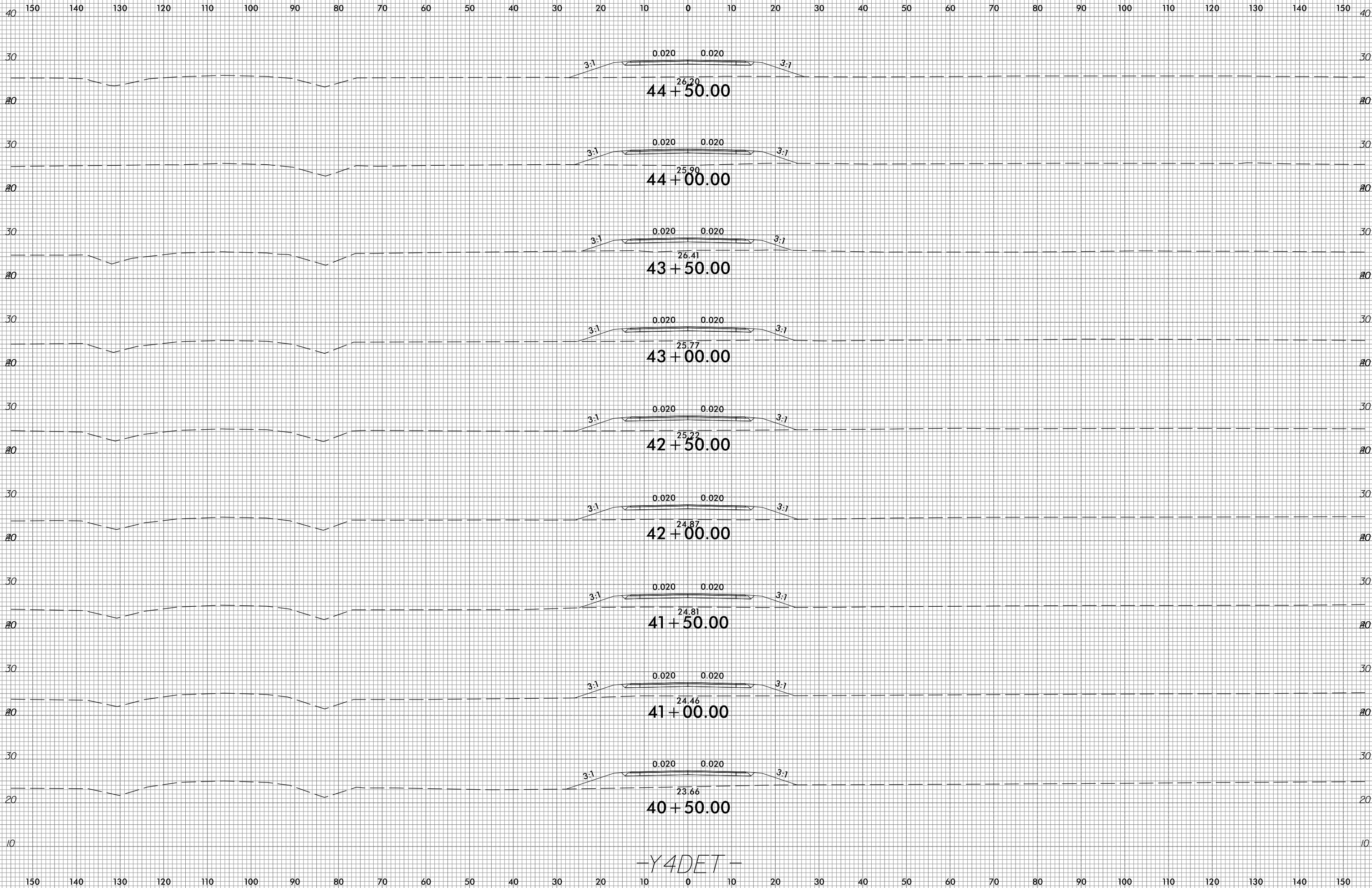

-Y4DET-











