

**This electronic collection of documents is provided
for the convenience of the user
and is Not a Certified Document –**



**The documents contained herein were originally issued
and sealed by the individuals whose names and license
numbers appear on each page, on the dates appearing
with their signature on that page.**

**This file or an individual page
shall not be considered a certified document.**

PROJECT NOTES

- 1 DISPOSAL OF SIGN SYSTEM, OVERHEAD
- 2 DISPOSAL OF SIGN SYSTEM, STEEL BEAM
- 3 DISPOSAL OF SIGN SYSTEM, U-CHANNEL
- 4 DISPOSAL OF SIGN, A OR B (OVERHEAD)
- 5 DISPOSAL OF SIGN, D, E OR F
- 6 DISPOSAL OF LIGHTING SYSTEM
- 7 DISPOSAL OF WALKWAY

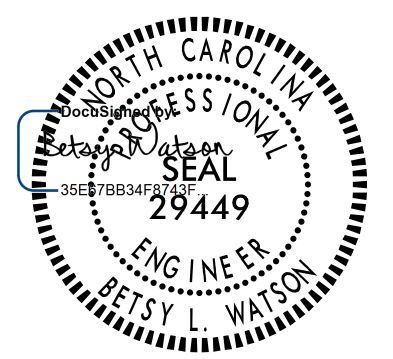
- 8 SIGN ERECTION, TYPE A (OVERHEAD)
- 9 SIGN ERECTION, TYPE B (OVERHEAD)
- 10 SIGN ERECTION, TYPE A (GROUND MOUNTED)
- 11 SIGN ERECTION, TYPE D, E, AND F
- 12 SIGN ERECTION, OVERLAY (OVERHEAD)
- 13 DISPOSAL OF OVERLAY (OVERHEAD)
- 14 CUTTING OF SIGN HANGERS (OVERHEAD)

TIP NO. U-5754	SHEET NO. SIGN - 10
APPROVED: _____	
DATE: _____	
SEAL	
	
1/16/2019	
DOCUMENT NOT CONSIDERED FINAL UNLESS ALL SIGNATURES COMPLETED	
	

MATCHLINE SEE SHEET SIGN-9



I-40 WBL/BUS I-85 SBL

I-40 EBL/BUS I-85 NBL

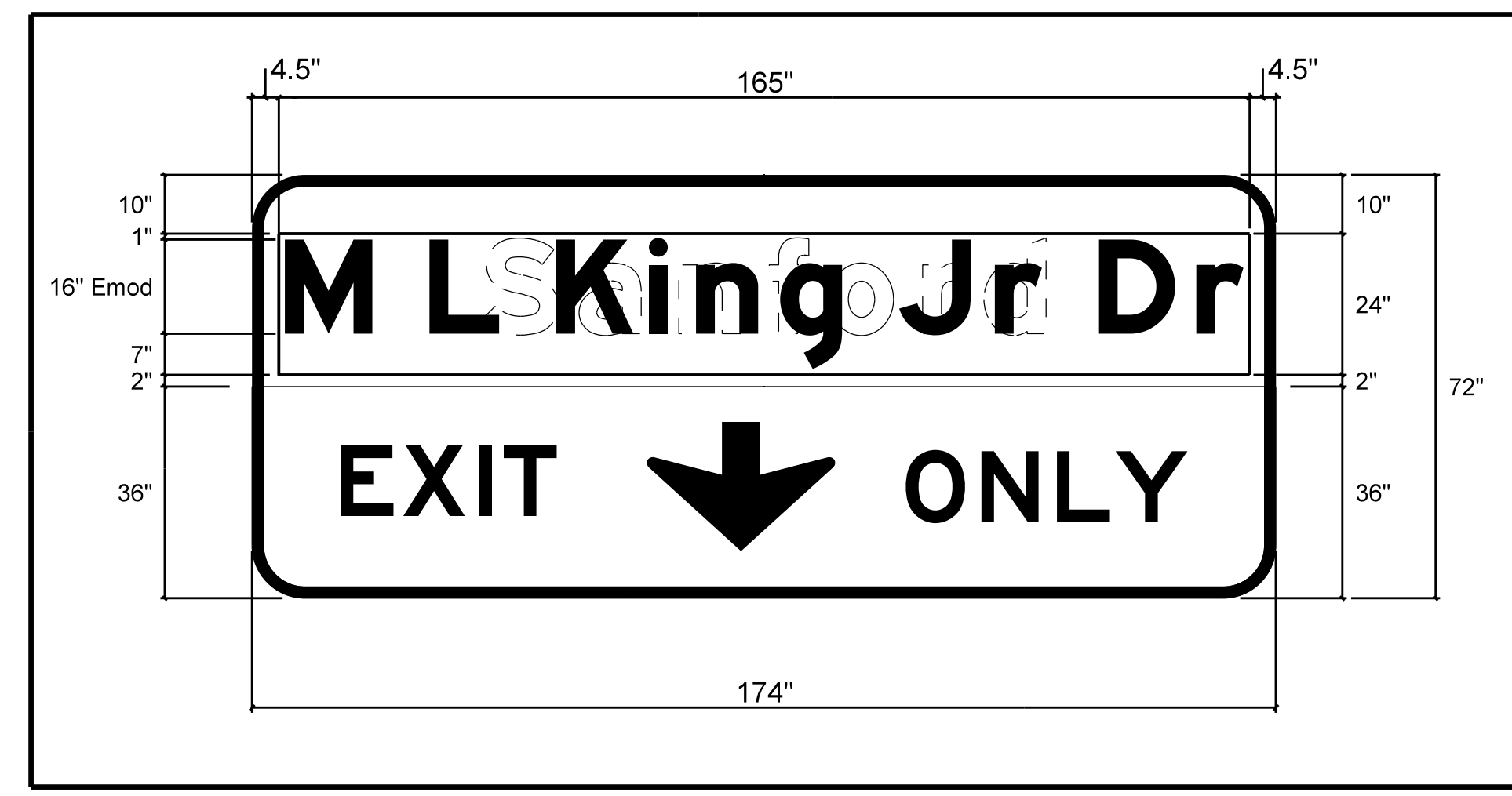
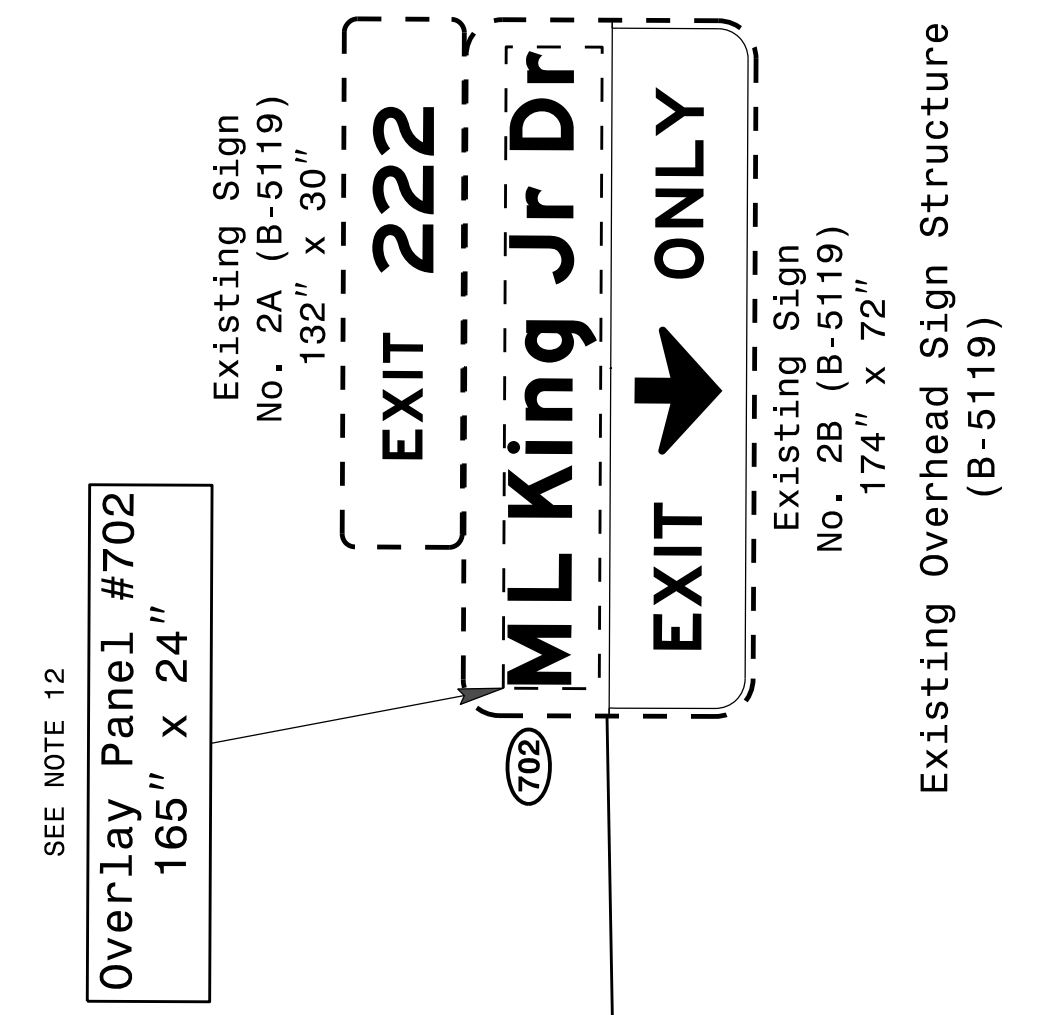

MATCHLINE SEE SHEET SIGN-11



Overlay Placement Detail
Overlay Panel #702
(165" x 24")

EXISTING/PROPOSED SIGNING

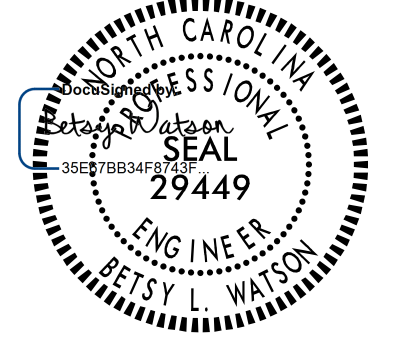
\$\$\$\$\$SYTIME\$\$\$\$\$
\$\$\$\$\$DGN\$\$\$\$\$
\$\$\$\$\$USERNAM\$\$\$\$\$

TIP NO. U-5754	SHEET NO. SIGN - 12
APPROVED: _____	
DATE: _____	
SEAL	
	
1/16/2019	
DOCUMENT NOT CONSIDERED FINAL UNLESS ALL SIGNATURES COMPLETED	
	

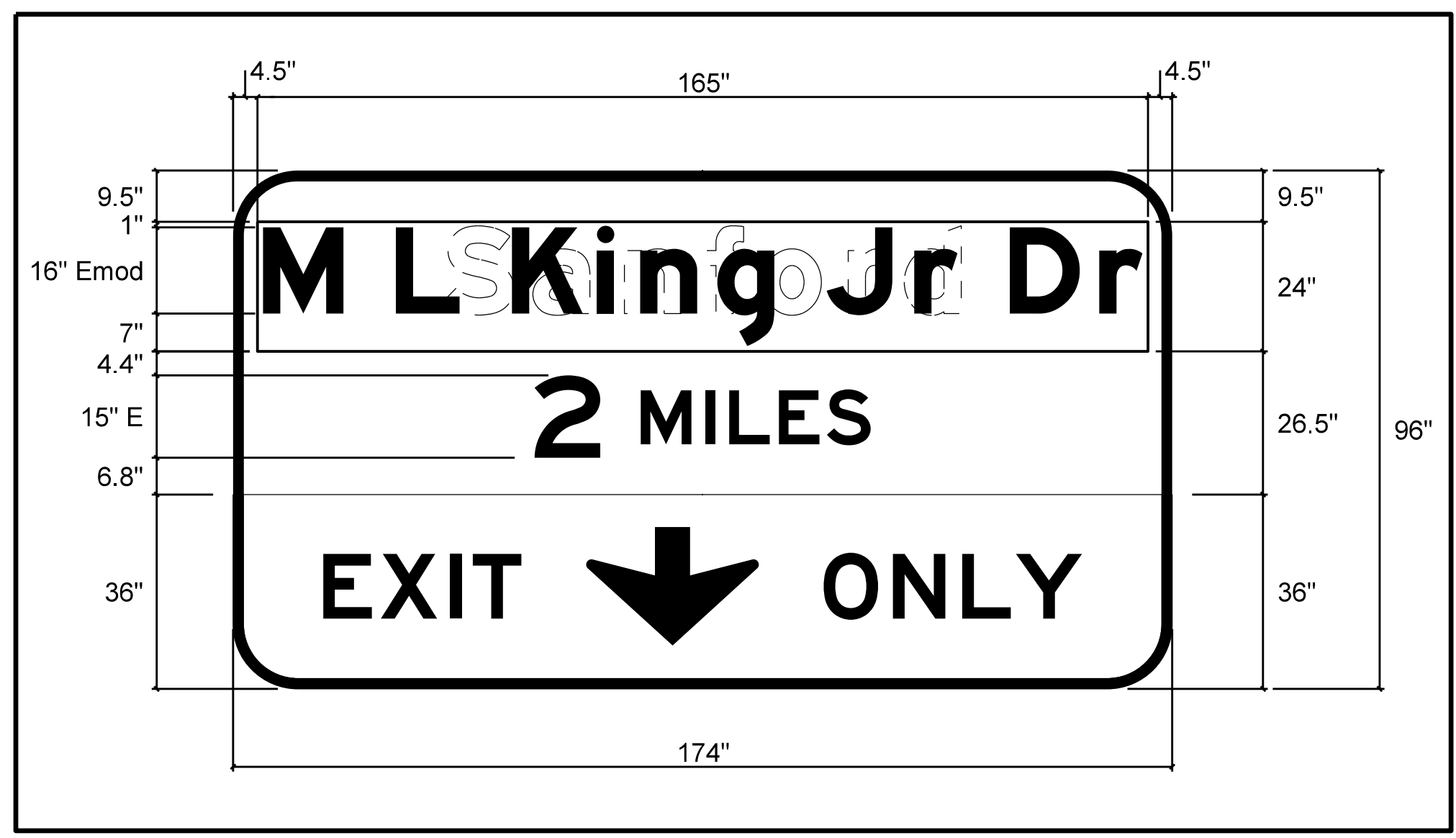

Overlay Placement Detail
Overlay Panel #704
(165" x 24")

BREAKLINE SEE SHEET SIGN-11

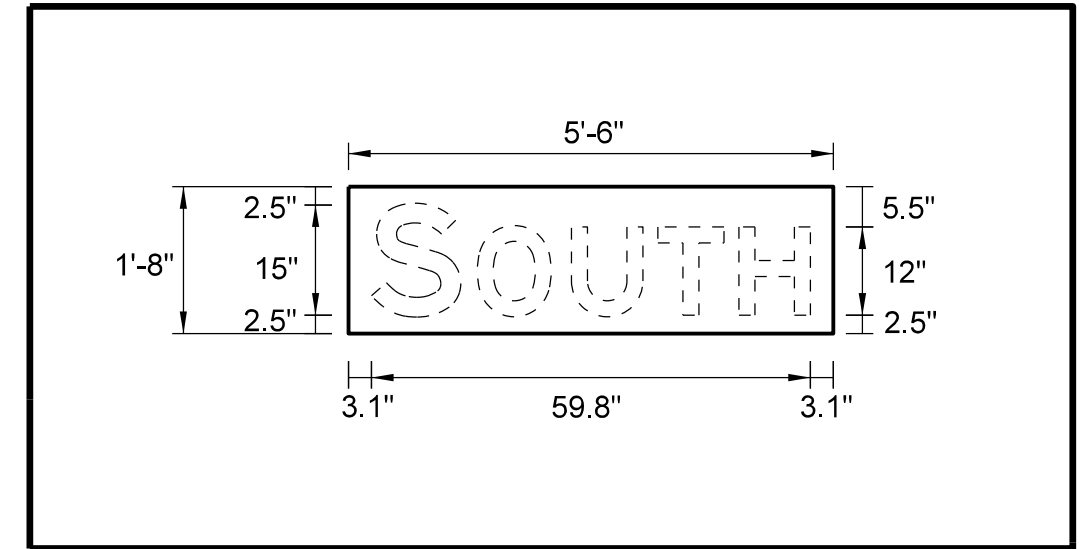
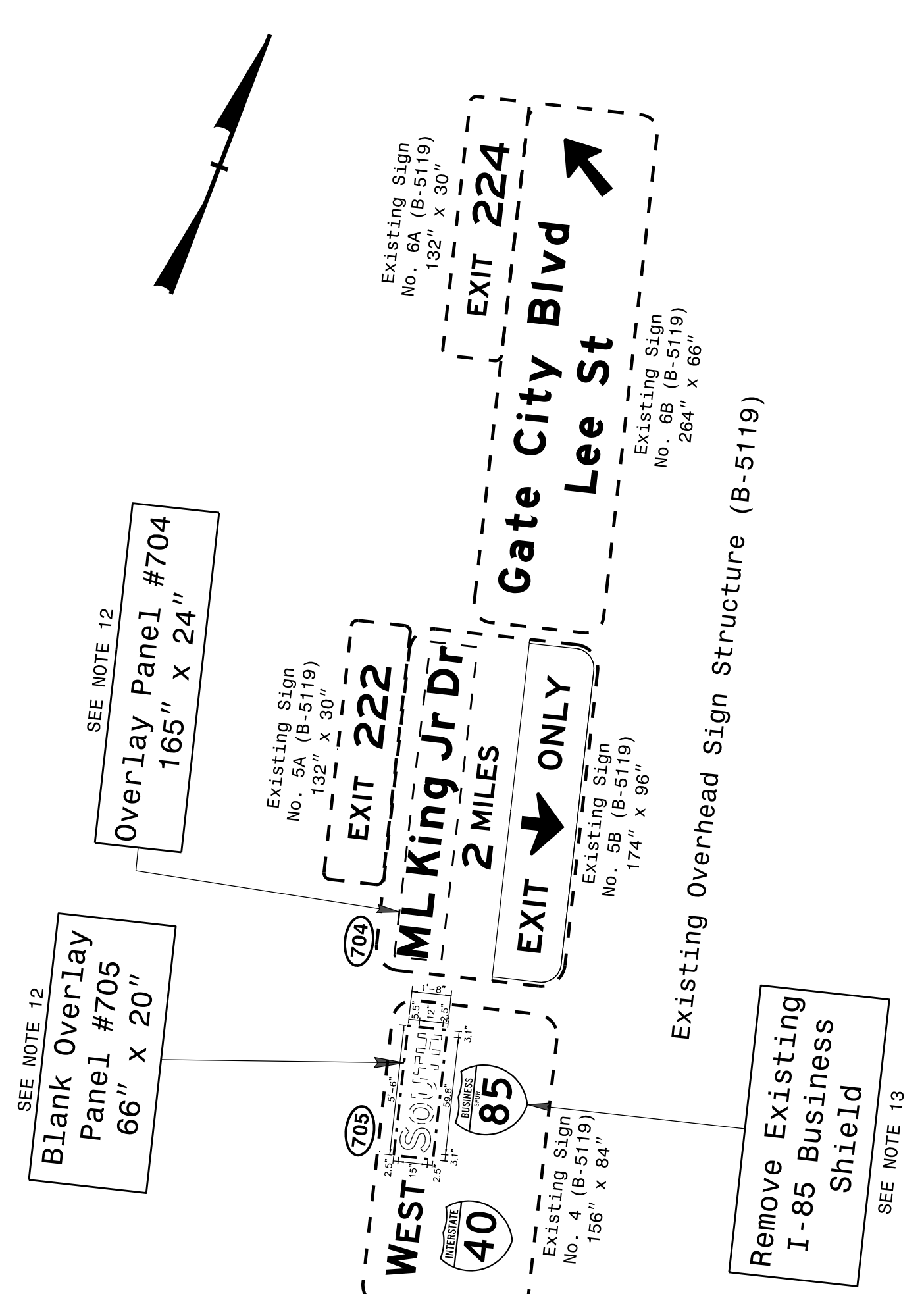
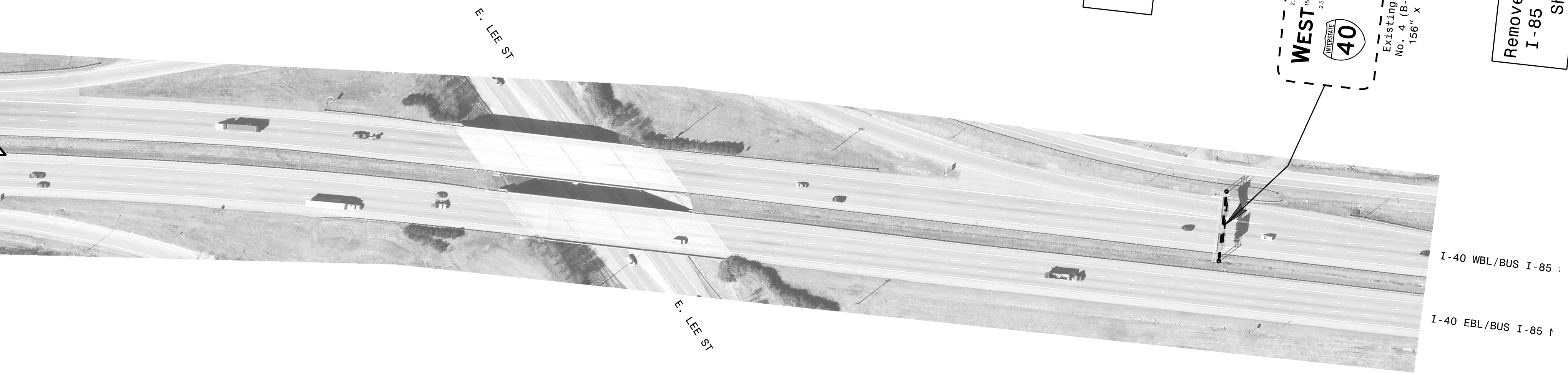

Overlay Placement Detail
Overlay Panel #705
(66" x 20")

PROJECT NOTES

- 1 DISPOSAL OF SIGN SYSTEM, OVERHEAD
- 2 DISPOSAL OF SIGN SYSTEM, STEEL BEAM
- 3 DISPOSAL OF SIGN SYSTEM, U-CHANNEL
- 4 DISPOSAL OF SIGN, A OR B (OVERHEAD)
- 5 DISPOSAL OF SIGN, D, E OR F
- 6 DISPOSAL OF LIGHTING SYSTEM
- 7 DISPOSAL OF WALKWAY

- 8 SIGN ERECTION, TYPE A (OVERHEAD)
- 9 SIGN ERECTION, TYPE B (OVERHEAD)
- 10 SIGN ERECTION, TYPE A (GROUND MOUNTED)
- 11 SIGN ERECTION, TYPE D, E, AND F
- 12 SIGN ERECTION, OVERLAY (OVERHEAD)
- 13 DISPOSAL OF OVERLAY (OVERHEAD)
- 14 CUTTING OF SIGN HANGERS (OVERHEAD)

EXISTING AND PROPOSED SIGNING
EXISTING OVERHEAD SIGN STRUCTURE #5

\$\$\$\$\$SYTIME\$\$\$\$\$
\$\$\$\$\$USER\$\$\$\$\$
\$\$\$\$\$USER\$\$\$\$\$

TIP NO.	SHEET NO.
U-5754	SIGN-13
APPROVED: _____	
DATE: _____	
SEAL	
1/16/2019	
DOCUMENT NOT CONSIDERED FINAL UNLESS ALL SIGNATURES COMPLETED	

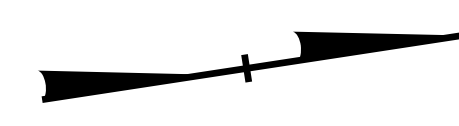
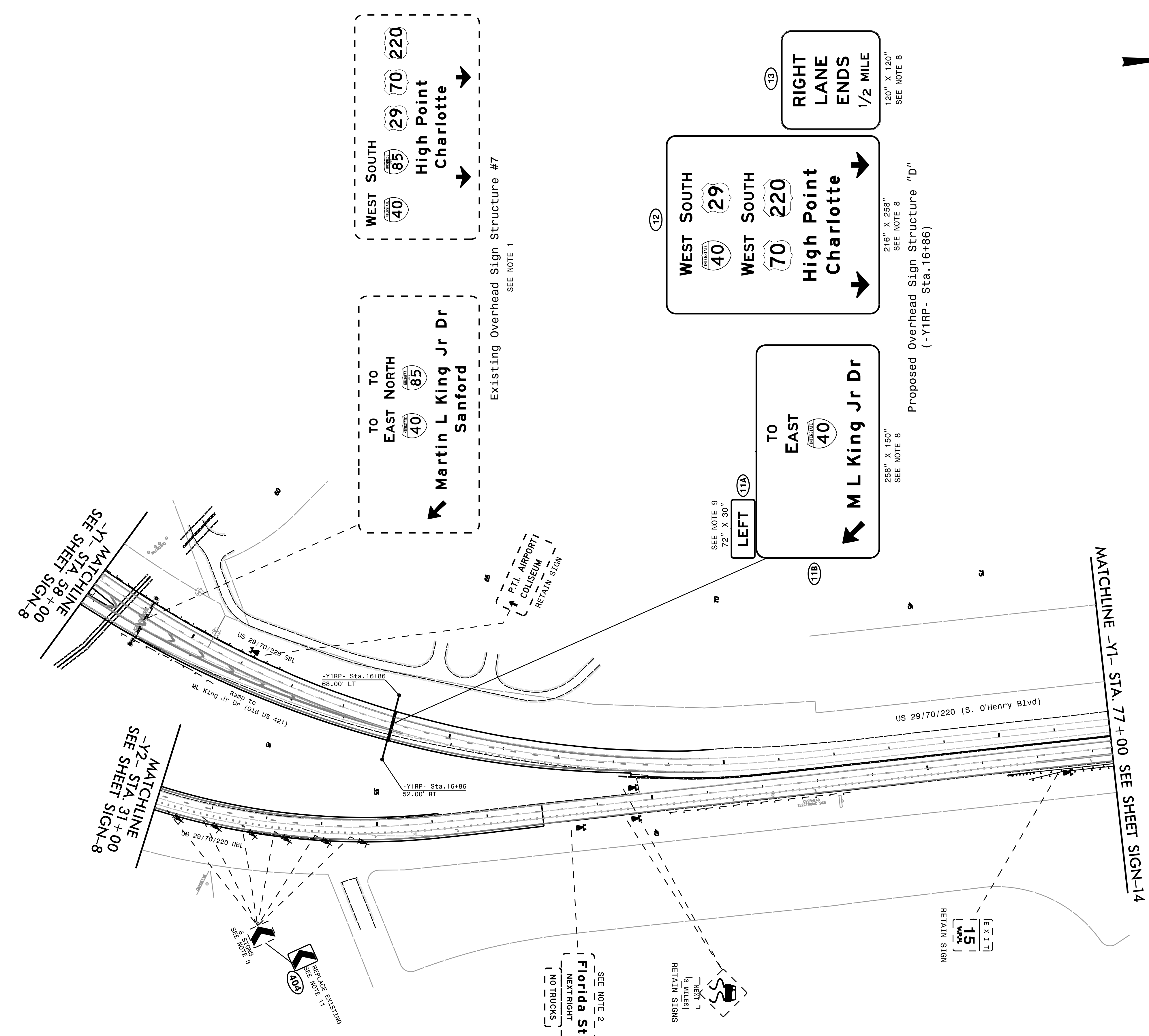

PROJECT NOTES

- 1 DISPOSAL OF SIGN SYSTEM, OVERHEAD
- 2 DISPOSAL OF SIGN SYSTEM, STEEL BEAM
- 3 DISPOSAL OF SIGN SYSTEM, U-CHANNEL
- 4 DISPOSAL OF SIGN, A OR B (OVERHEAD)
- 5 DISPOSAL OF SIGN, D, E OR F
- 6 DISPOSAL OF LIGHTING SYSTEM
- 7 DISPOSAL OF WALKWAY
- 8 SIGN ERECTION, TYPE A (OVERHEAD)
- 9 SIGN ERECTION, TYPE B (OVERHEAD)
- 10 SIGN ERECTION, TYPE A (GROUND MOUNTED)
- 11 SIGN ERECTION, TYPE D, E, AND F
- 12 SIGN ERECTION, OVERLAY (OVERHEAD)
- 13 DISPOSAL OF OVERLAY (OVERHEAD)
- 14 CUTTING OF SIGN HANGERS (OVERHEAD)

EXISTING AND PROPOSED SIGNING
 PROPOSED OVERHEAD SIGN STRUCTURE "D"
 EXISTING OVERHEAD SIGN STRUCTURE #7

\$\$\$\$\$SYTIME\$\$\$\$\$
 \$\$\$DDGN\$\$\$\$\$
 \$\$\$USERNAME\$\$\$\$\$

TIP NO.	SHEET NO.
U-5754	SIGN-14

APPROVED: _____
DATE: _____

SEAL

1/16/2019

**DOCUMENT NOT CONSIDERED FINAL
UNLESS ALL SIGNATURES COMPLETED**

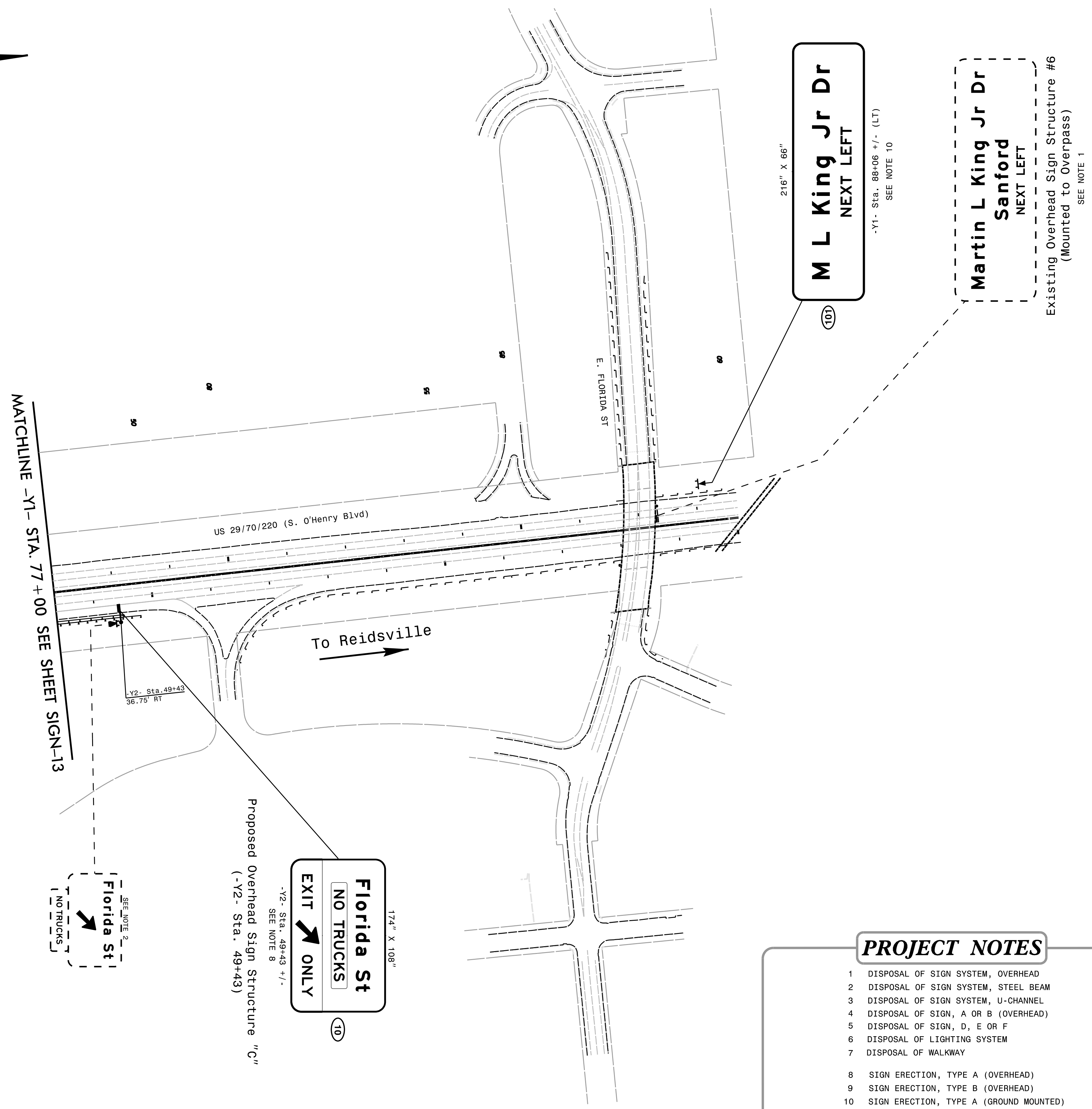
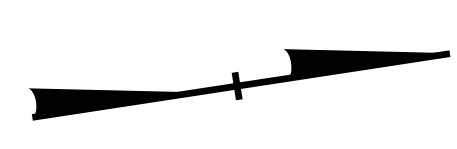

- PROJECT NOTES**
- DISPOSAL OF SIGN SYSTEM, OVERHEAD
 - DISPOSAL OF SIGN SYSTEM, STEEL BEAM
 - DISPOSAL OF SIGN SYSTEM, U-CHANNEL
 - DISPOSAL OF SIGN, A OR B (OVERHEAD)
 - DISPOSAL OF SIGN, D, E OR F
 - DISPOSAL OF LIGHTING SYSTEM
 - DISPOSAL OF WALKWAY
 - SIGN ERECTION, TYPE A (OVERHEAD)
 - SIGN ERECTION, TYPE B (OVERHEAD)
 - SIGN ERECTION, TYPE A (GROUND MOUNTED)
 - SIGN ERECTION, TYPE D, E, AND F
 - SIGN ERECTION, OVERLAY (OVERHEAD)
 - DISPOSAL OF OVERLAY (OVERHEAD)
 - CUTTING OF SIGN HANGERS (OVERHEAD)

**EXISTING AND PROPOSED SIGNING
PROPOSED OVERHEAD SIGN STRUCTURE "C"
EXISTING OVERHEAD SIGN STRUCTURE #6**

\$\$\$\$\$SYTIME\$\$\$\$\$
\$\$\$\$\$DDGN\$\$\$\$\$
\$\$\$\$\$USERNAME\$\$\$\$\$