

**This electronic collection of documents is provided  
for the convenience of the user  
and is Not a Certified Document –**

**The documents contained herein were originally issued  
and sealed by the individuals whose names and license  
numbers appear on each page, on the dates appearing  
with their signature on that page.**

**This file or an individual page  
shall not be considered a certified document.**

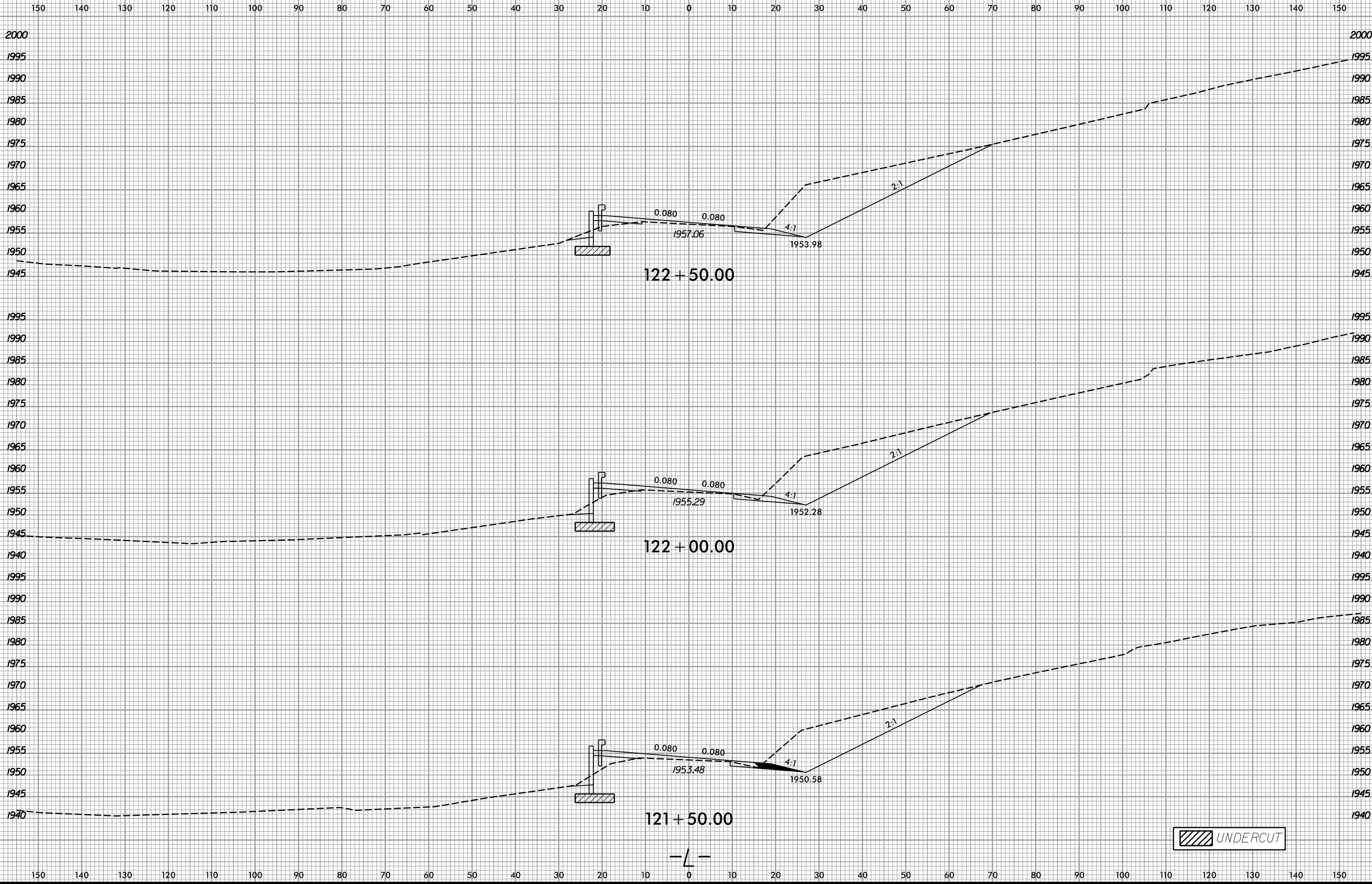

UNDERCUT

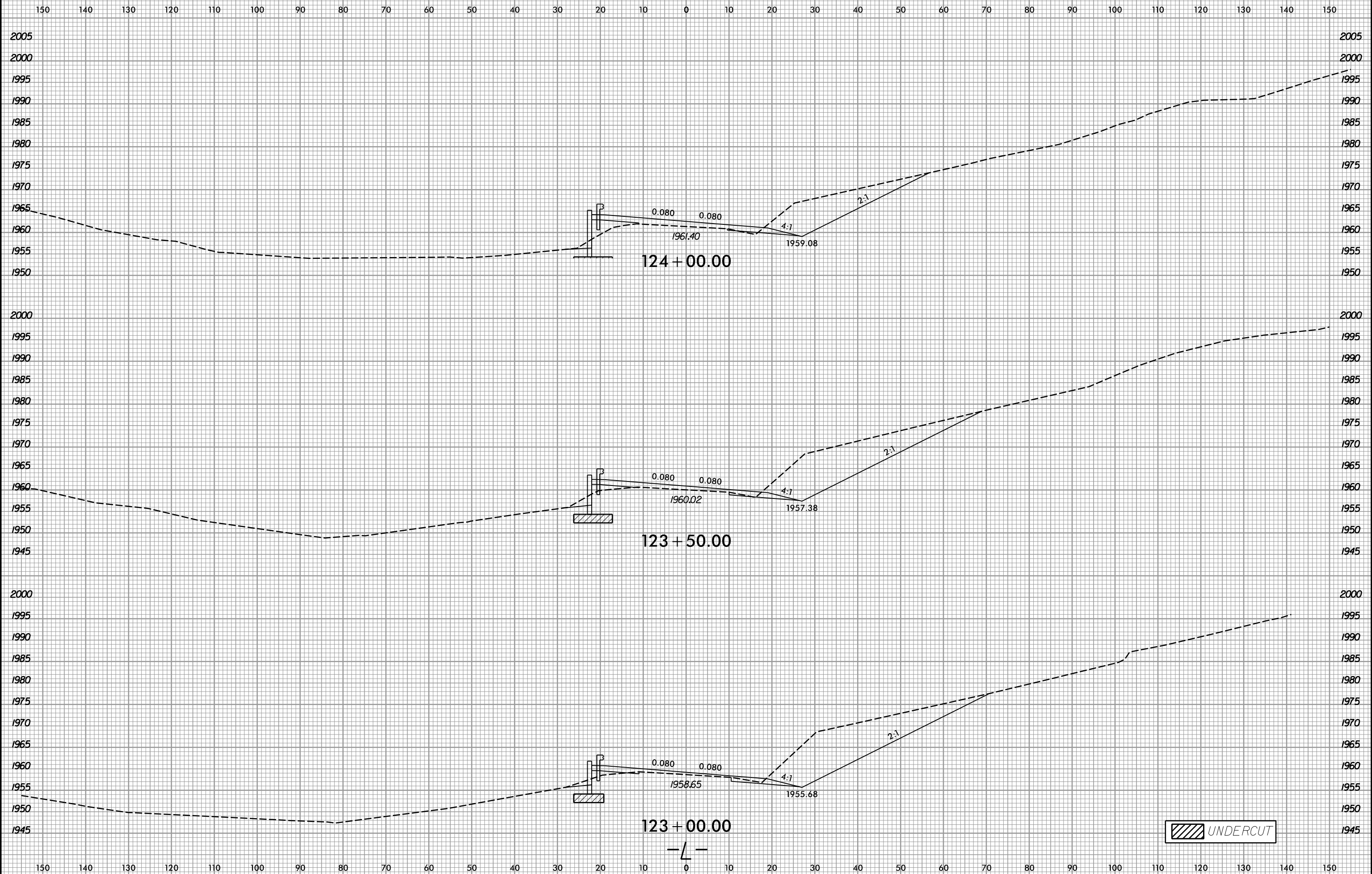

UNDERCUT



150 140 130 120 110 100 90 80 70 60 50 40 30 20 10 0 10 20 30 40 50 60 70 80 90 100 110 120 130 140 150

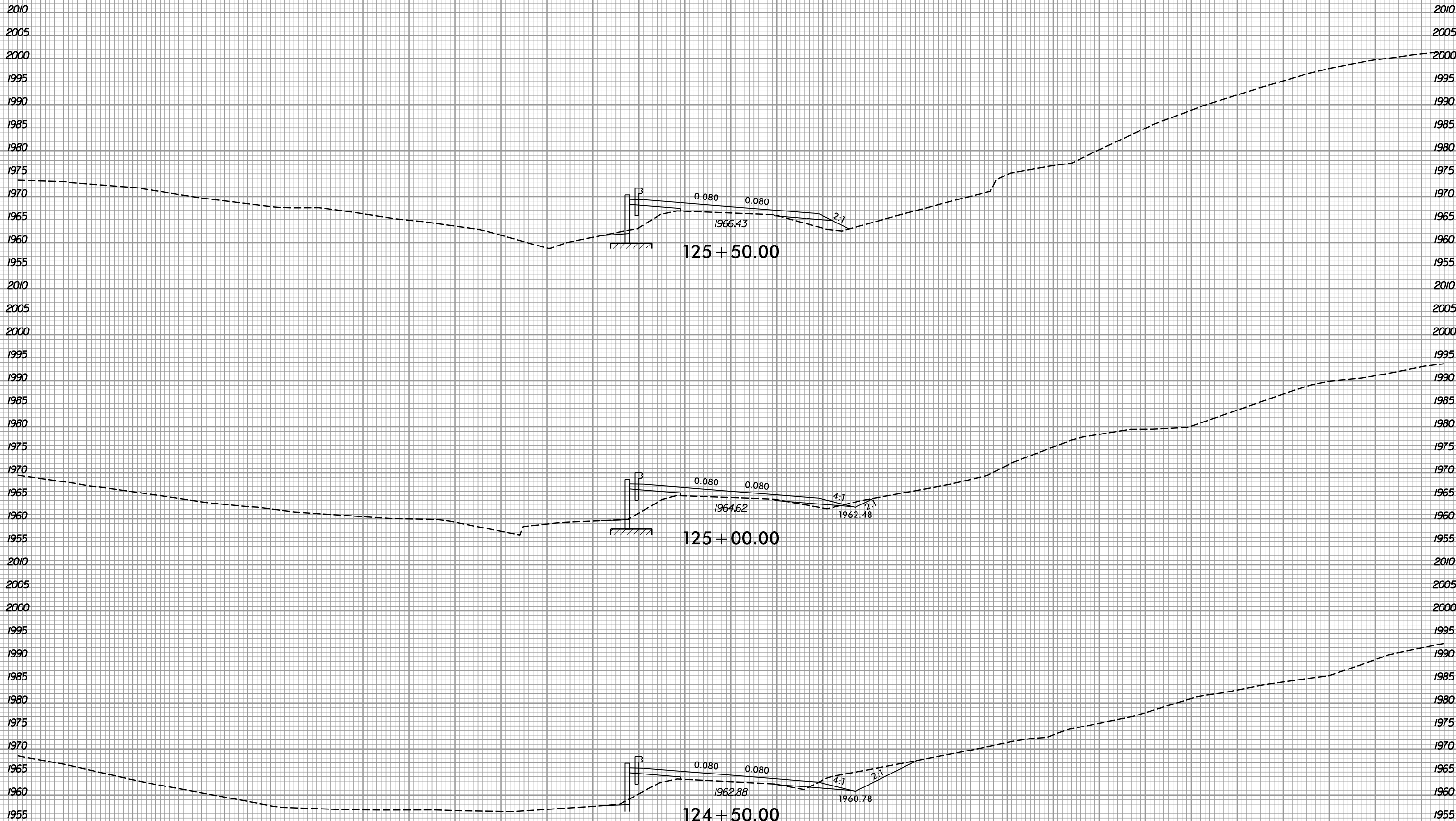

UNDERCUT

-L-

150 140 130 120 110 100 90 80 70 60 50 40 30 20 10 0 10 20 30 40 50 60 70 80 90 100 110 120 130 140 150

6/23/16



PROJ. REFERENCE NO.  
R-5742

SHEET NO.  
X-71

150 140 130 120 110 100 90 80 70 60 50 40 30 20 10 0 10 20 30 40 50 60 70 80 90 100 110 120 130 140 150

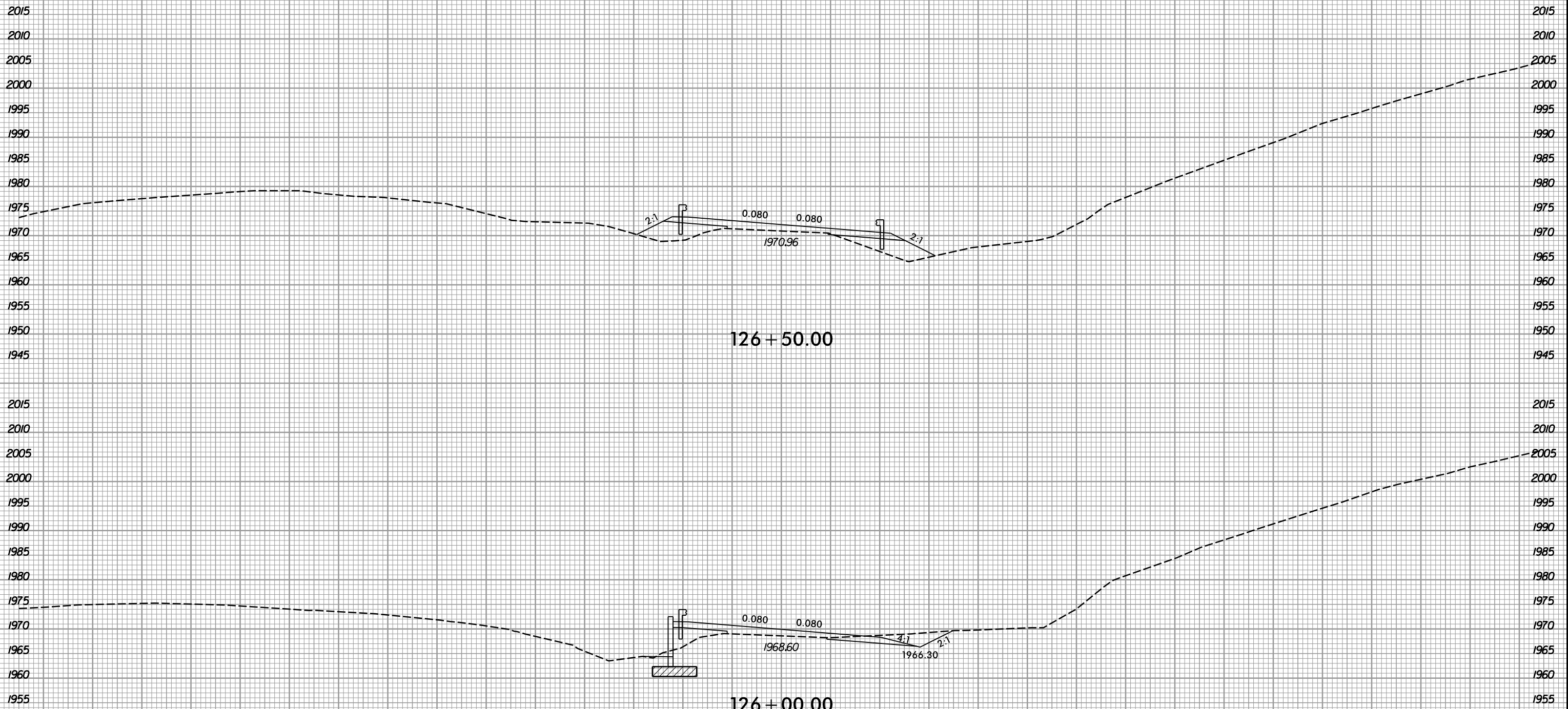

126 + 50.00

126 + 00.00

UNDERCUT

I:\14\2018  
R:\Roadway\Xsc\126+5742.Rdy.L\_xpl.dgn  
gpr/ice

6/23/16



PROJ. REFERENCE NO.  
R-5742

SHEET NO.  
X-72

150 140 130 120 110 100 90 80 70 60 50 40 30 20 10 0 10 20 30 40 50 60 70 80 90 100 110 120 130 140 150

2025  
2020  
2015  
2010  
2005  
2000  
1995  
1990  
1985  
1980  
1975  
1970  
1965  
1960  
1955  
2020  
2015  
2010  
2005  
2000  
1995  
1990  
1985  
1980  
1975  
1970  
1965  
1960  
1955  
1950

2025  
2020  
2015  
2010  
2005  
2000  
1995  
1990  
1985  
1980  
1975  
1970  
1965  
1960  
1955  
2020  
2015  
2010  
2005  
2000  
1995  
1990  
1985  
1980  
1975  
1970  
1965  
1960  
1955  
1950

127 + 50.00

127 + 00.00

-L-

2.7 4:1 0.080 0.080 2.1  
1977.07 1976.67

2.7 4:1 0.080 0.080 1.50:1  
1974.21 1973.72

I:\14\2018  
R:\Roadway\Xsc\18-R-5742-Rdy-L\_xpl.dgn  
gpr/ice



150 140 130 120 110 100 90 80 70 60 50 40 30 20 10 0 10 20 30 40 50 60 70 80 90 100 110 120 130 140 150

2025  
2020  
2015  
2010  
2005  
2000  
1995  
1990  
1985  
1980  
1975  
1970  
1965  
1960  
2025  
2020  
2015  
2010  
2005  
2000  
1995  
1990  
1985  
1980  
1975  
1970  
1965  
1960  
1955

2025  
2020  
2015  
2010  
2005  
2000  
1995  
1990  
1985  
1980  
1975  
1970  
1965  
1960  
2025  
2020  
2015  
2010  
2005  
2000  
1995  
1990  
1985  
1980  
1975  
1970  
1965  
1960  
1955

128 + 50.00

128 + 00.00

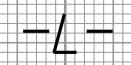

2:1 4:1 0.080 0.080 2:1  
1983.58 1983.18

2:1 4:1 0.080 0.080 2:1  
1980.20 1979.85

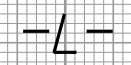
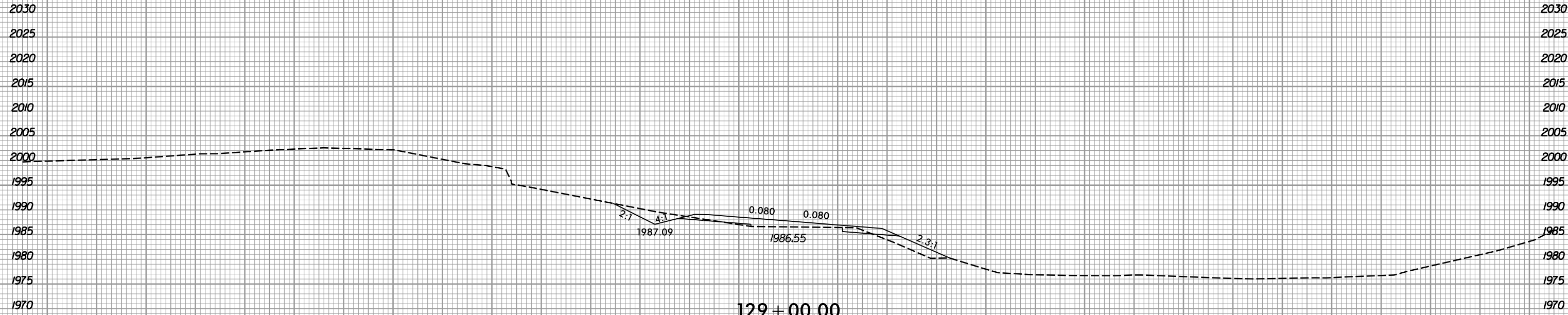
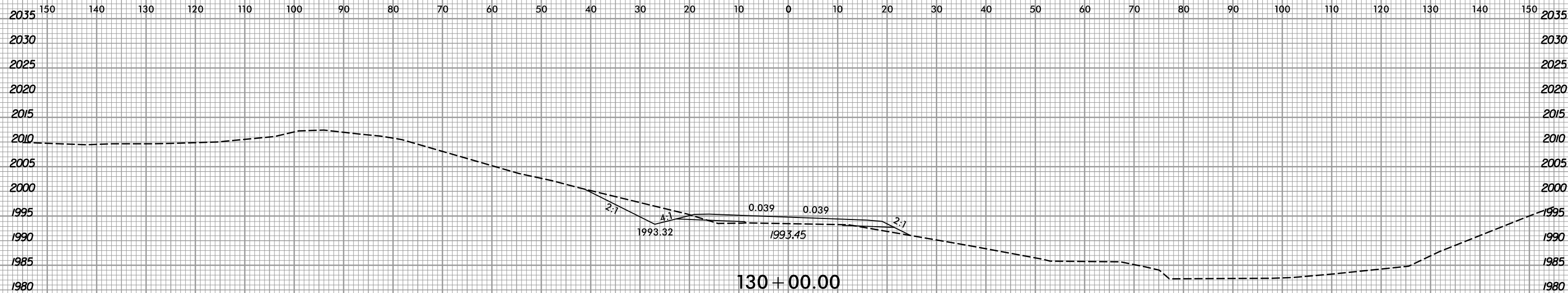



6/23/16



PROJ. REFERENCE NO.  
R-5742

SHEET NO.  
X-75

150 140 130 120 110 100 90 80 70 60 50 40 30 20 10 0 10 20 30 40 50 60 70 80 90 100 110 120 130 140 150

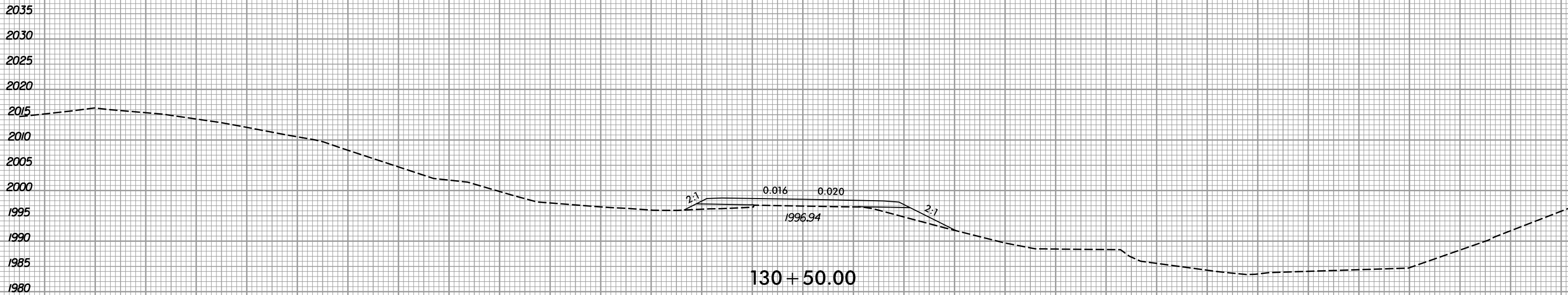
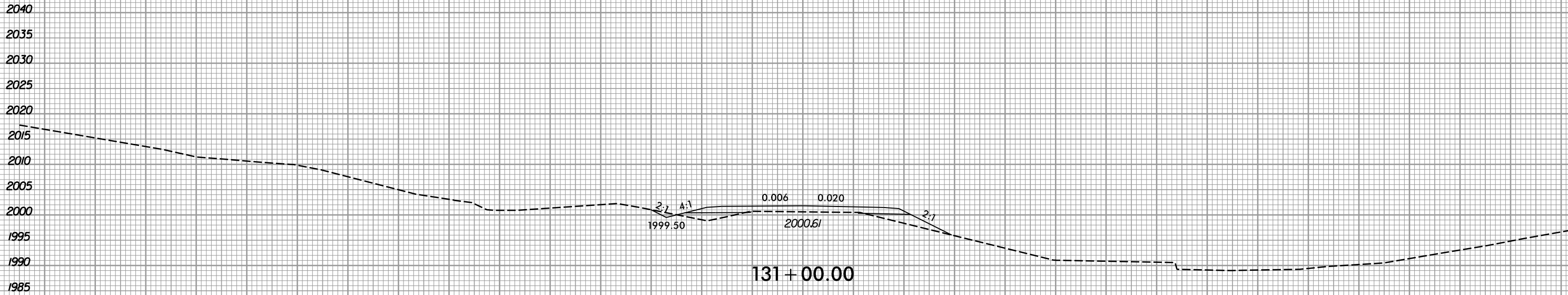
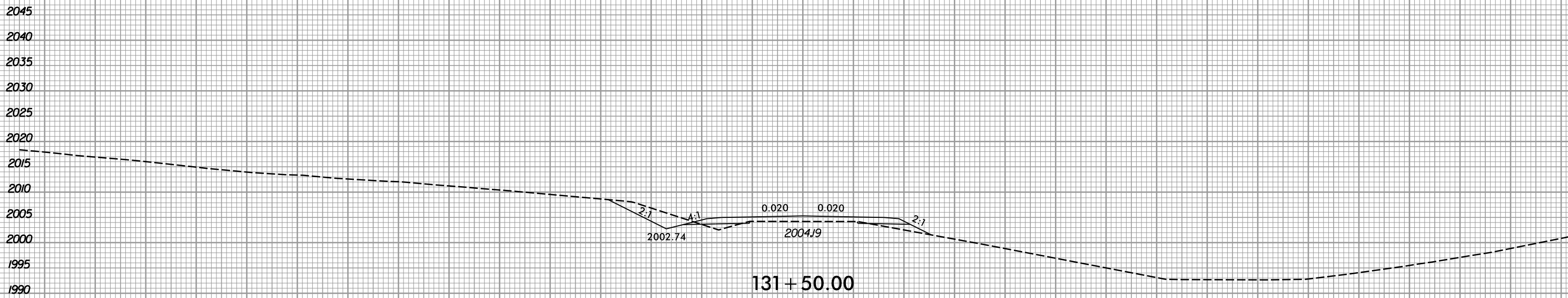

150 140 130 120 110 100 90 80 70 60 50 40 30 20 10 0 10 20 30 40 50 60 70 80 90 100 110 120 130 140 150

I:\14\2018  
R:\Roadway\Xsc\130+5742.Rdy.L\_xpl.dgn  
gprlce

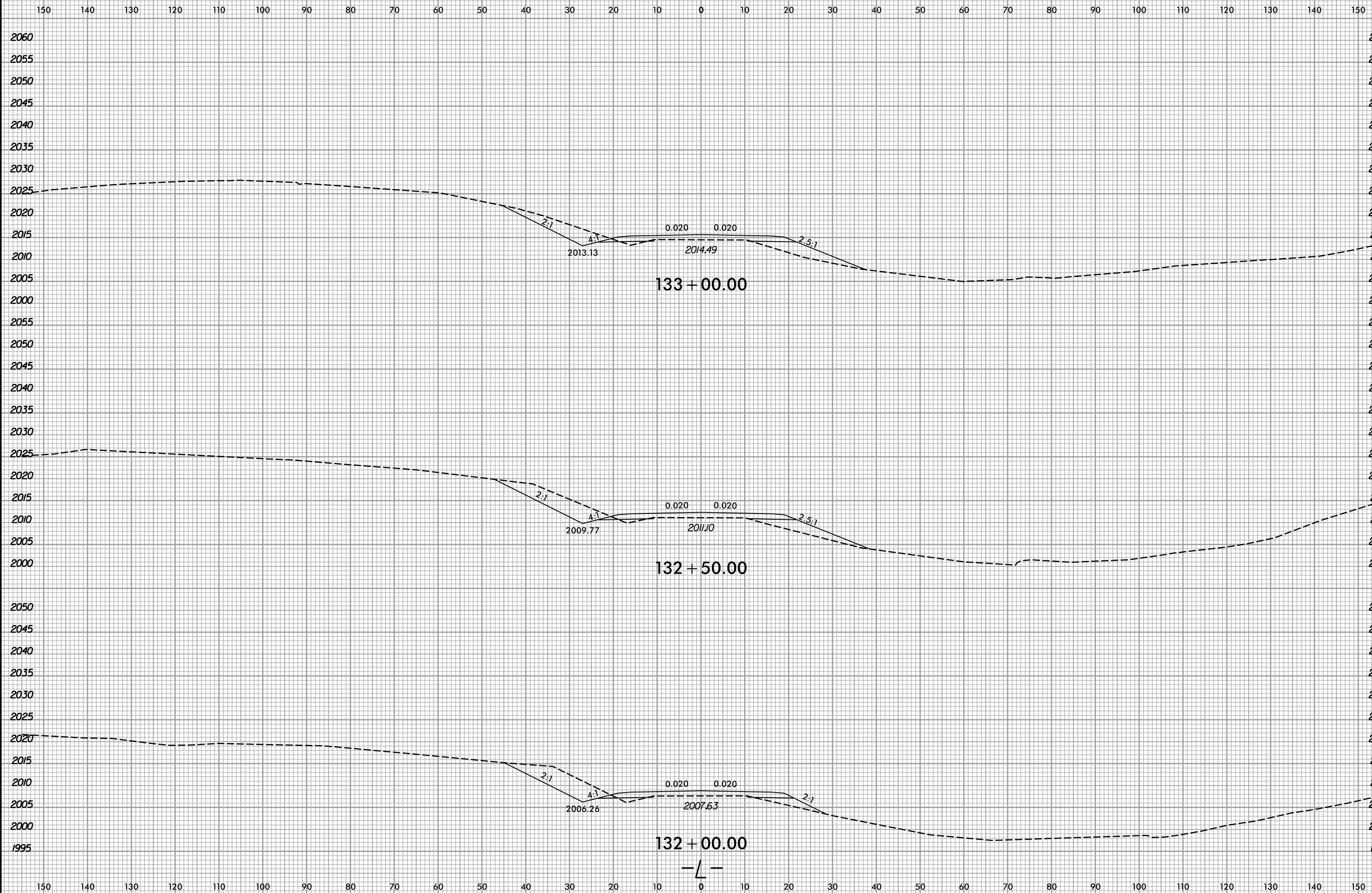

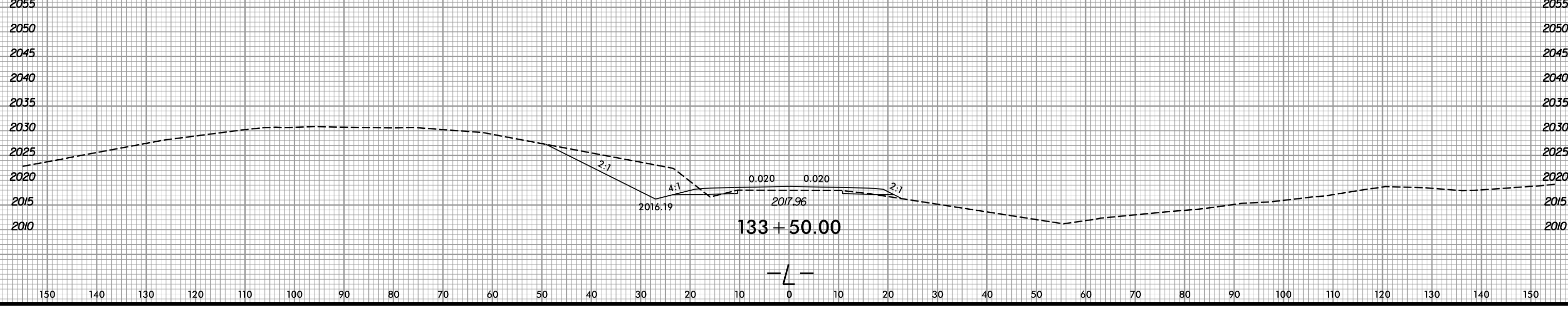
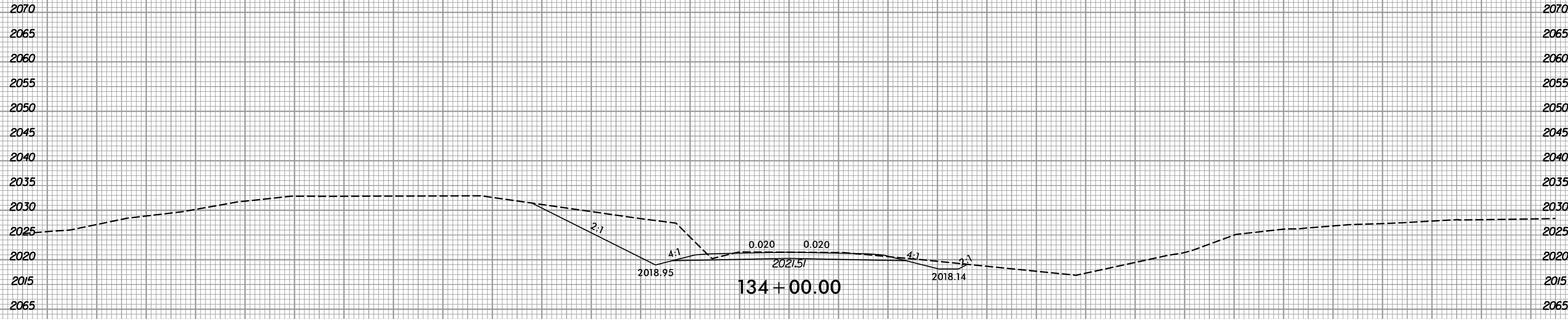
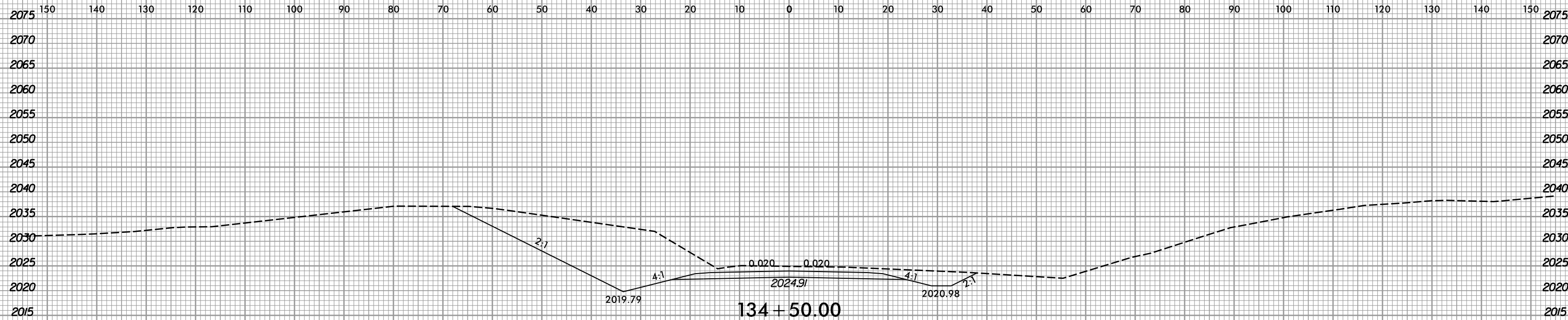

6/23/16



PROJ. REFERENCE NO.  
R-5742

SHEET NO.  
X-78

150 140 130 120 110 100 90 80 70 60 50 40 30 20 10 0 10 20 30 40 50 60 70 80 90 100 110 120 130 140 150

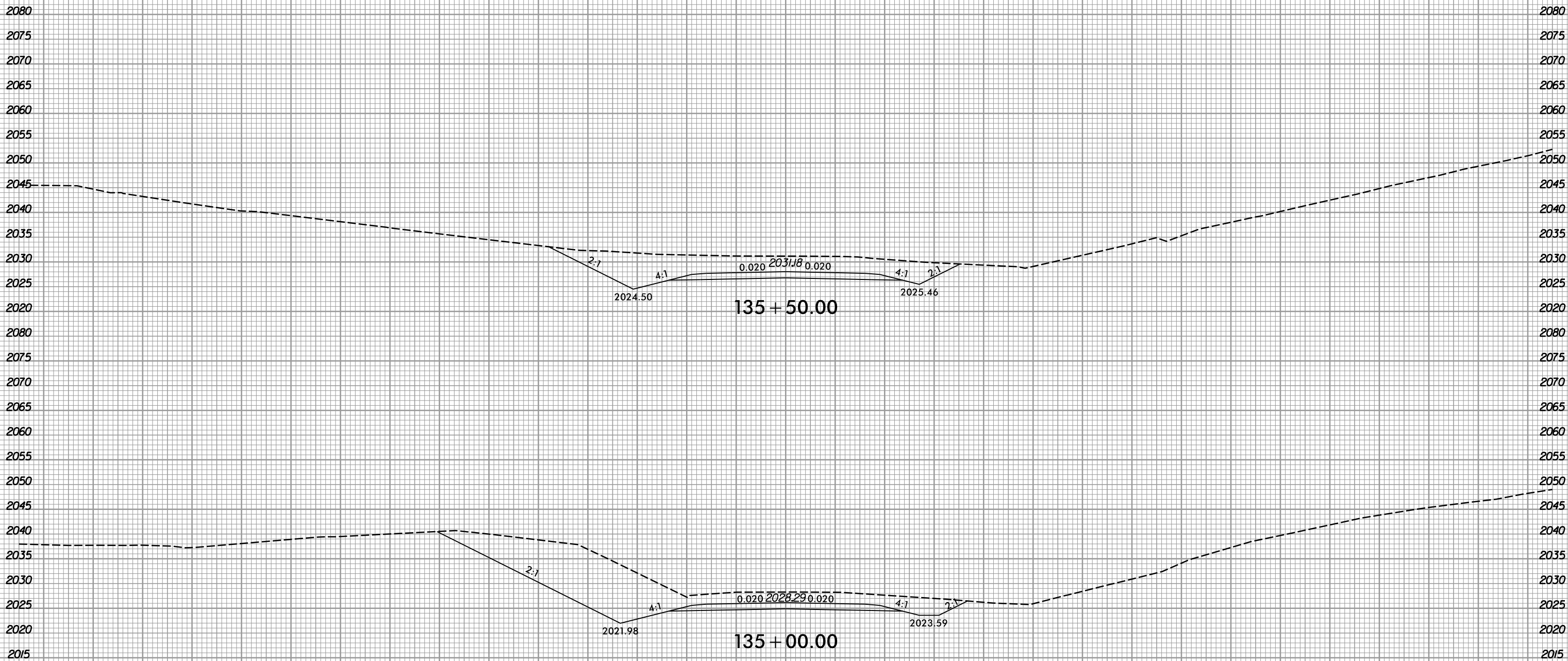

150 140 130 120 110 100 90 80 70 60 50 40 30 20 10 0 10 20 30 40 50 60 70 80 90 100 110 120 130 140 150

I:\14\2018  
R:\Roadway\Xsc\135+5742\_Rdy\_L\_xpl.dgn  
gpr/ice

6/23/16



PROJ. REFERENCE NO.  
R-5742

SHEET NO.  
X-79

150 140 130 120 110 100 90 80 70 60 50 40 30 20 10 0 10 20 30 40 50 60 70 80 90 100 110 120 130 140 150

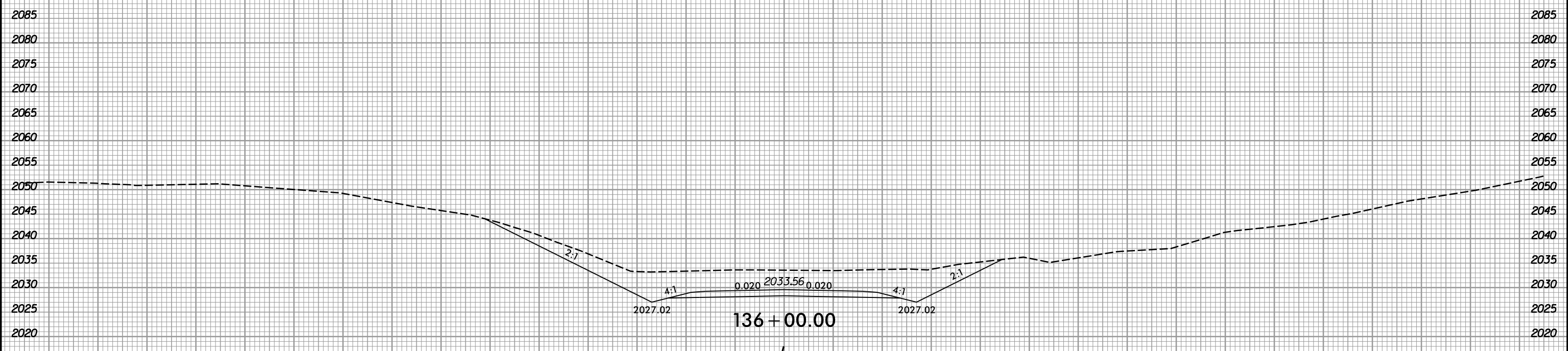

—L—

150 140 130 120 110 100 90 80 70 60 50 40 30 20 10 0 10 20 30 40 50 60 70 80 90 100 110 120 130 140 150

I:\14\2018  
R:\Roadway\Xsc\136+5742\_Rdy\_L\_xpl.dgn  
gprlce



150 140 130 120 110 100 90 80 70 60 50 40 30 20 10 0 10 20 30 40 50 60 70 80 90 100 110 120 130 140 150

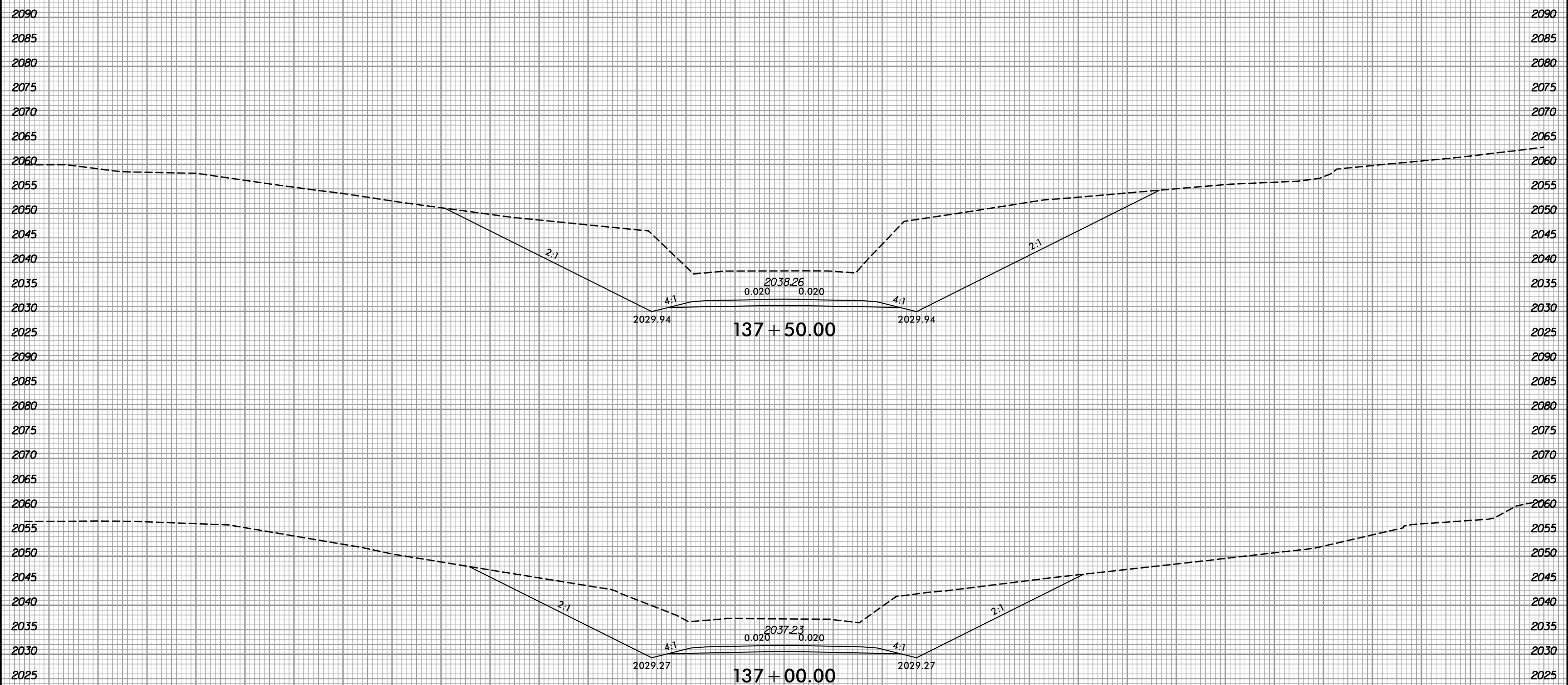

137 + 50.00

137 + 00.00

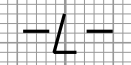



150 140 130 120 110 100 90 80 70 60 50 40 30 20 10 0 10 20 30 40 50 60 70 80 90 100 110 120 130 140 150

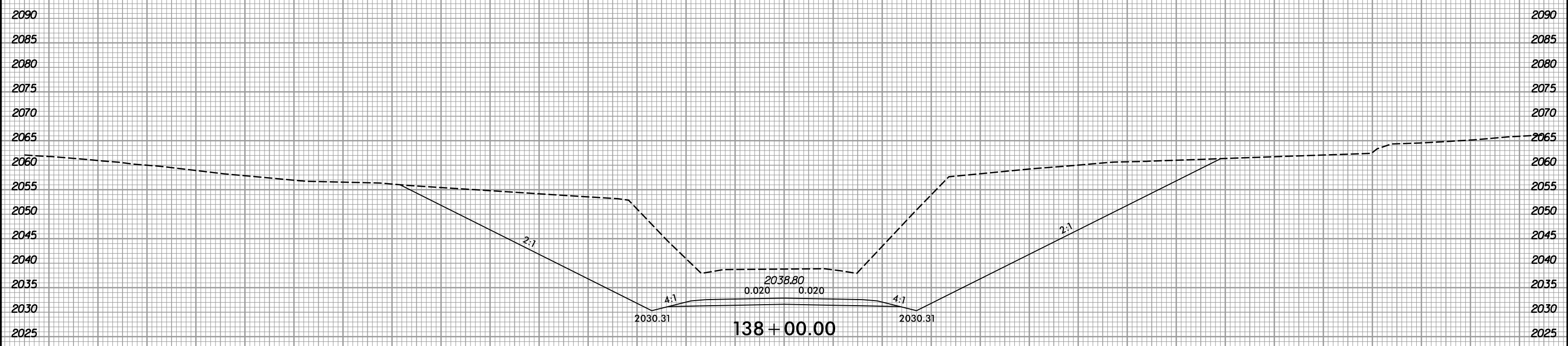
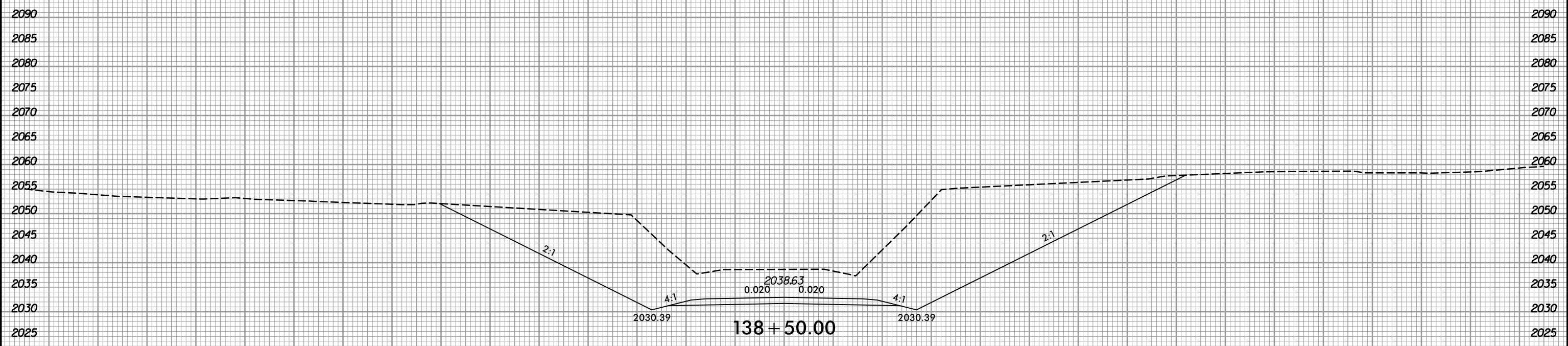

—L—

150 140 130 120 110 100 90 80 70 60 50 40 30 20 10 0 10 20 30 40 50 60 70 80 90 100 110 120 130 140 150

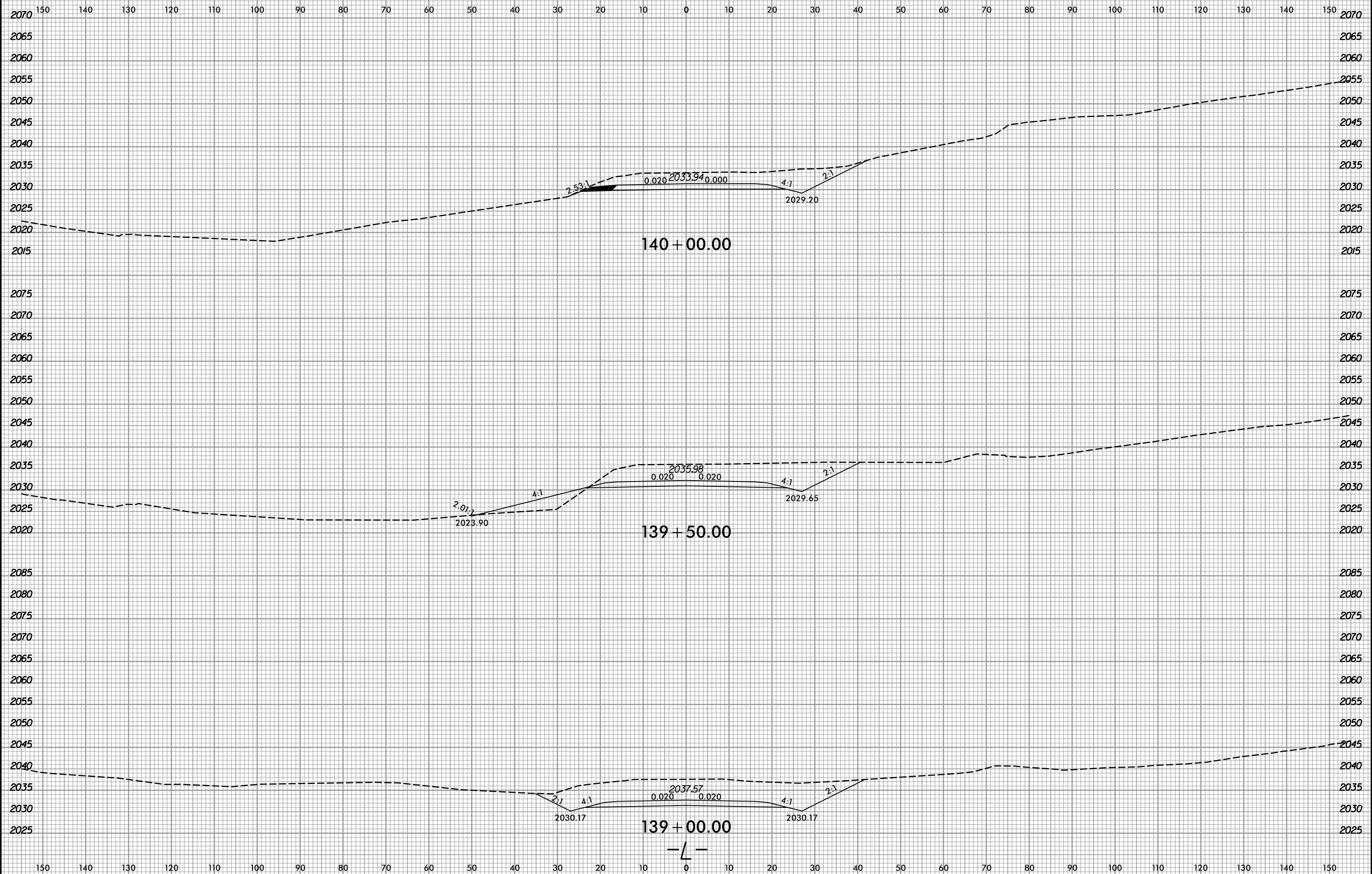



6/23/16



PROJ. REFERENCE NO.  
R-5742

SHEET NO.  
X-83

150 140 130 120 110 100 90 80 70 60 50 40 30 20 10 0 10 20 30 40 50 60 70 80 90 100 110 120 130 140 150

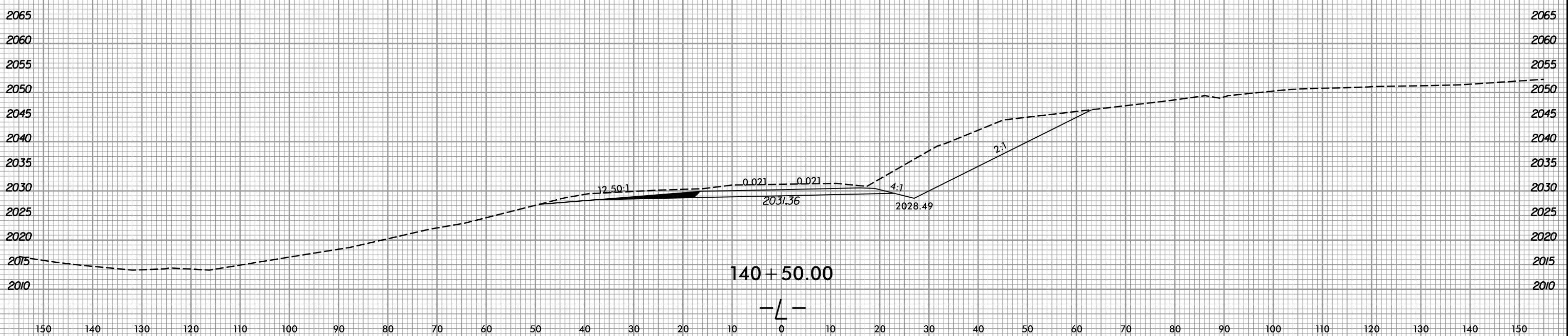
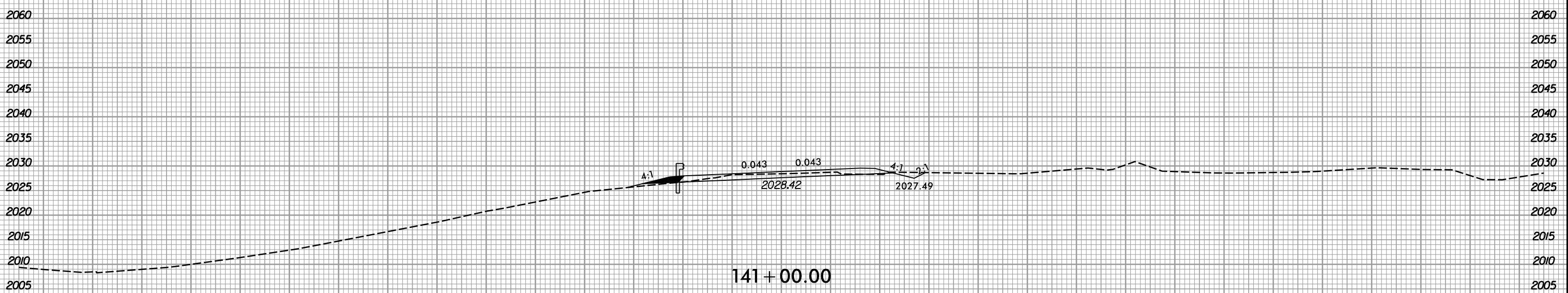
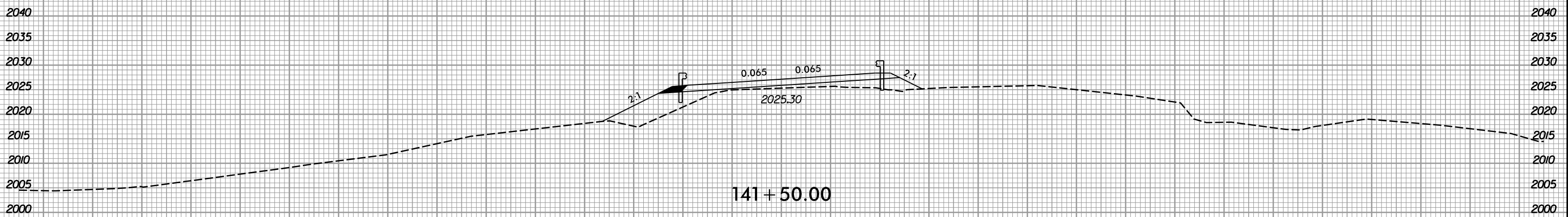

150 140 130 120 110 100 90 80 70 60 50 40 30 20 10 0 10 20 30 40 50 60 70 80 90 100 110 120 130 140 150

I:\14\2018  
R:\Roadway\Xsc\14-R-5742-Rdy-L\_xpl.dgn  
gpr/ice

6/23/16



PROJ. REFERENCE NO.  
R-5742

SHEET NO.  
X-84

150 140 130 120 110 100 90 80 70 60 50 40 30 20 10 0 10 20 30 40 50 60 70 80 90 100 110 120 130 140 150

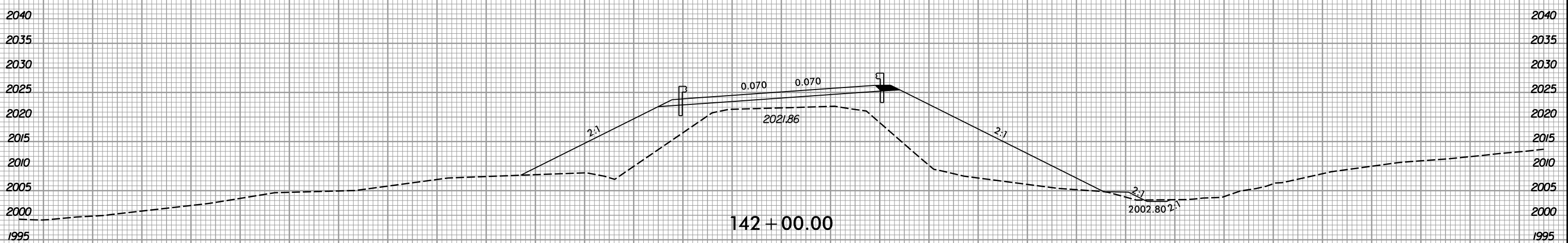
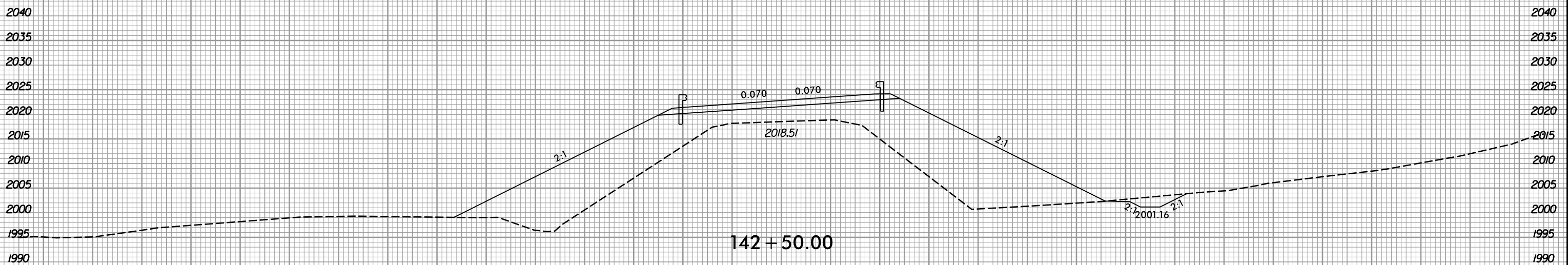
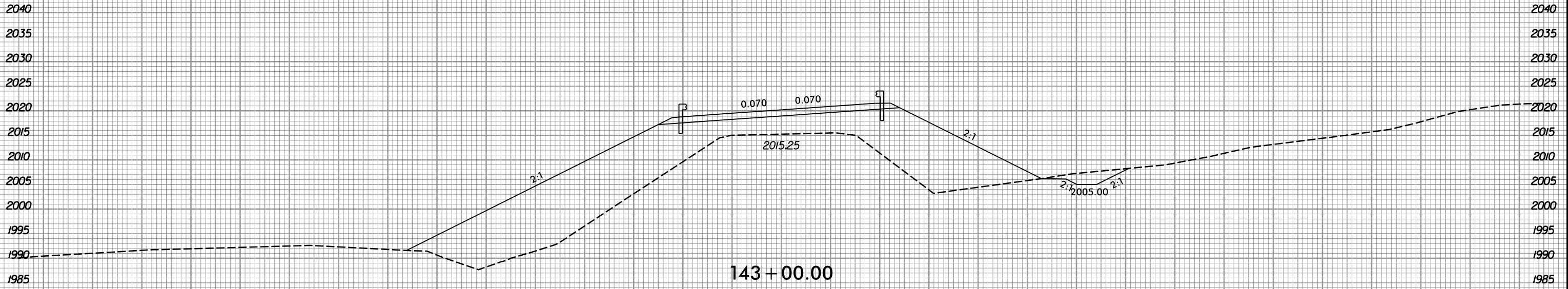

150 140 130 120 110 100 90 80 70 60 50 40 30 20 10 0 10 20 30 40 50 60 70 80 90 100 110 120 130 140 150

I:\14\2018  
R:\Roadway\Xsc\14-R-5742-Rdy\_L\_xpl.dgn  
gprlce

6/23/16

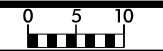

PROJ. REFERENCE NO.  
R-5742

SHEET NO.  
X-85

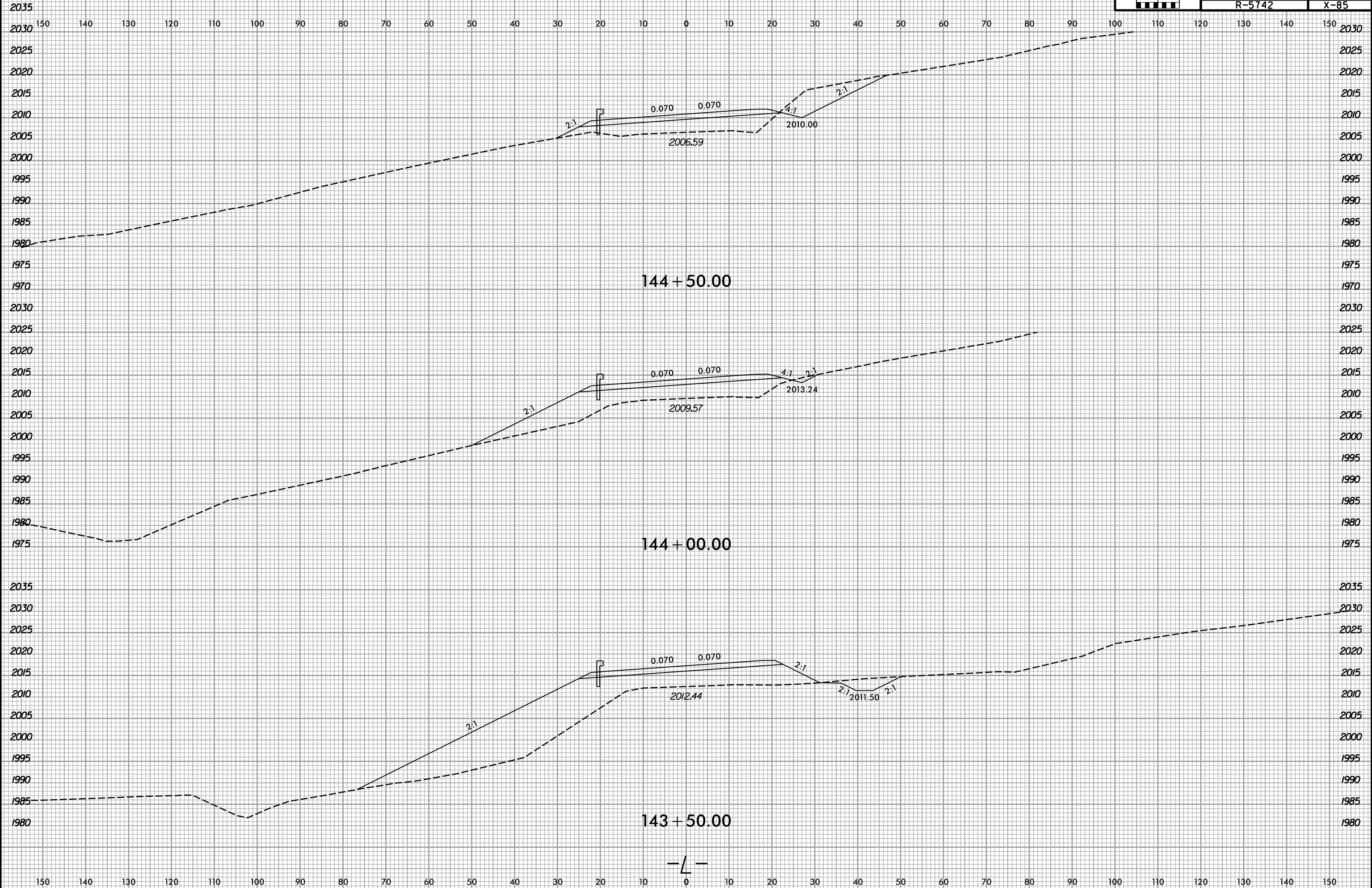

I2/14/2018  
R:\Roadway\Xsc\14-5742.Rdy.L\_xpl.dgn  
gprlce

6/23/16



PROJ. REFERENCE NO.	SHEET NO.
R-5742	X-86

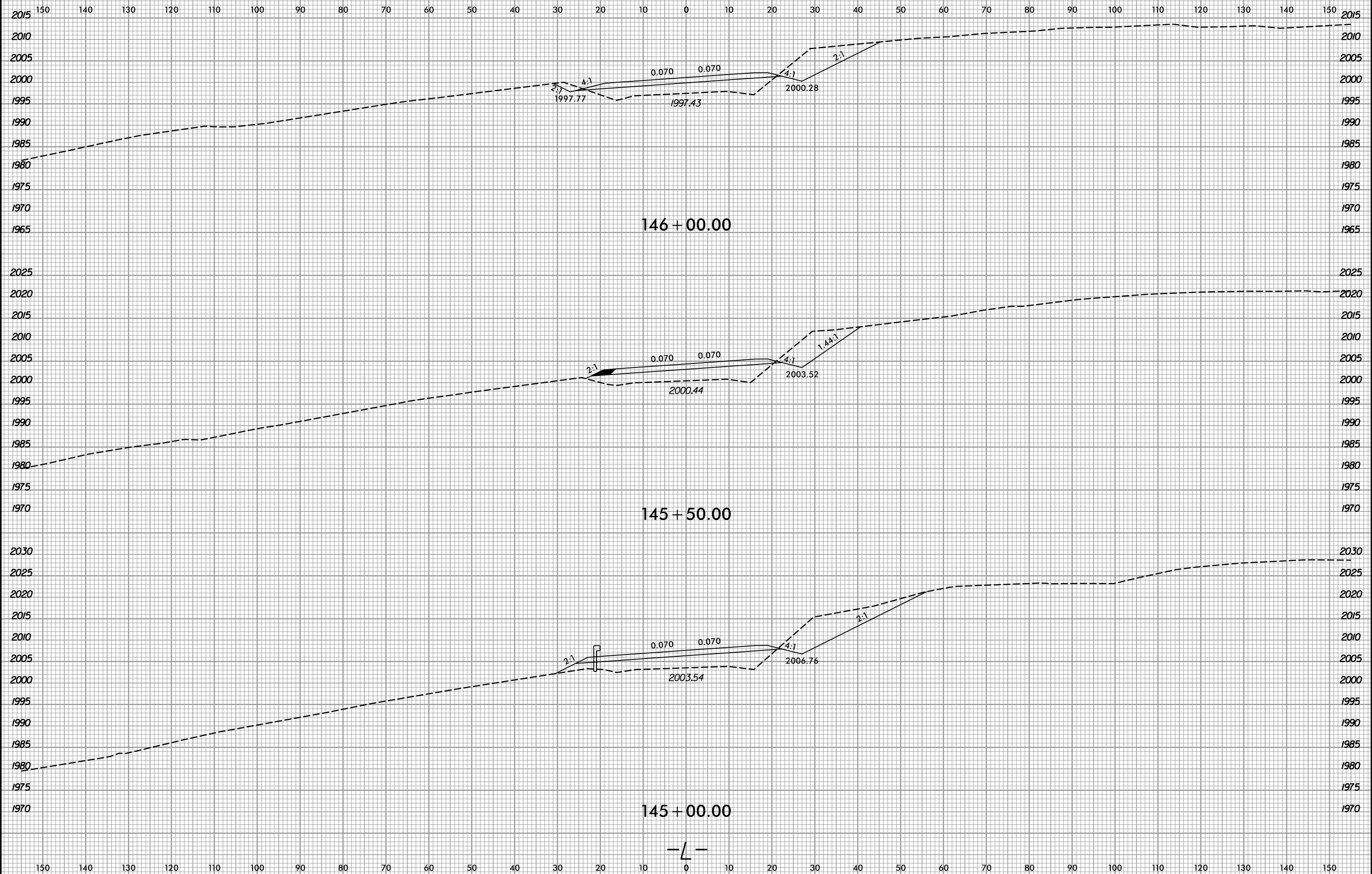

I:\14\2018  
R:\Roadway\Xsc\14-5742.Rdy.L\_xpl.dgn  
gpr/ice

6/23/16



PROJ. REFERENCE NO.	SHEET NO.
R-5742	X-87

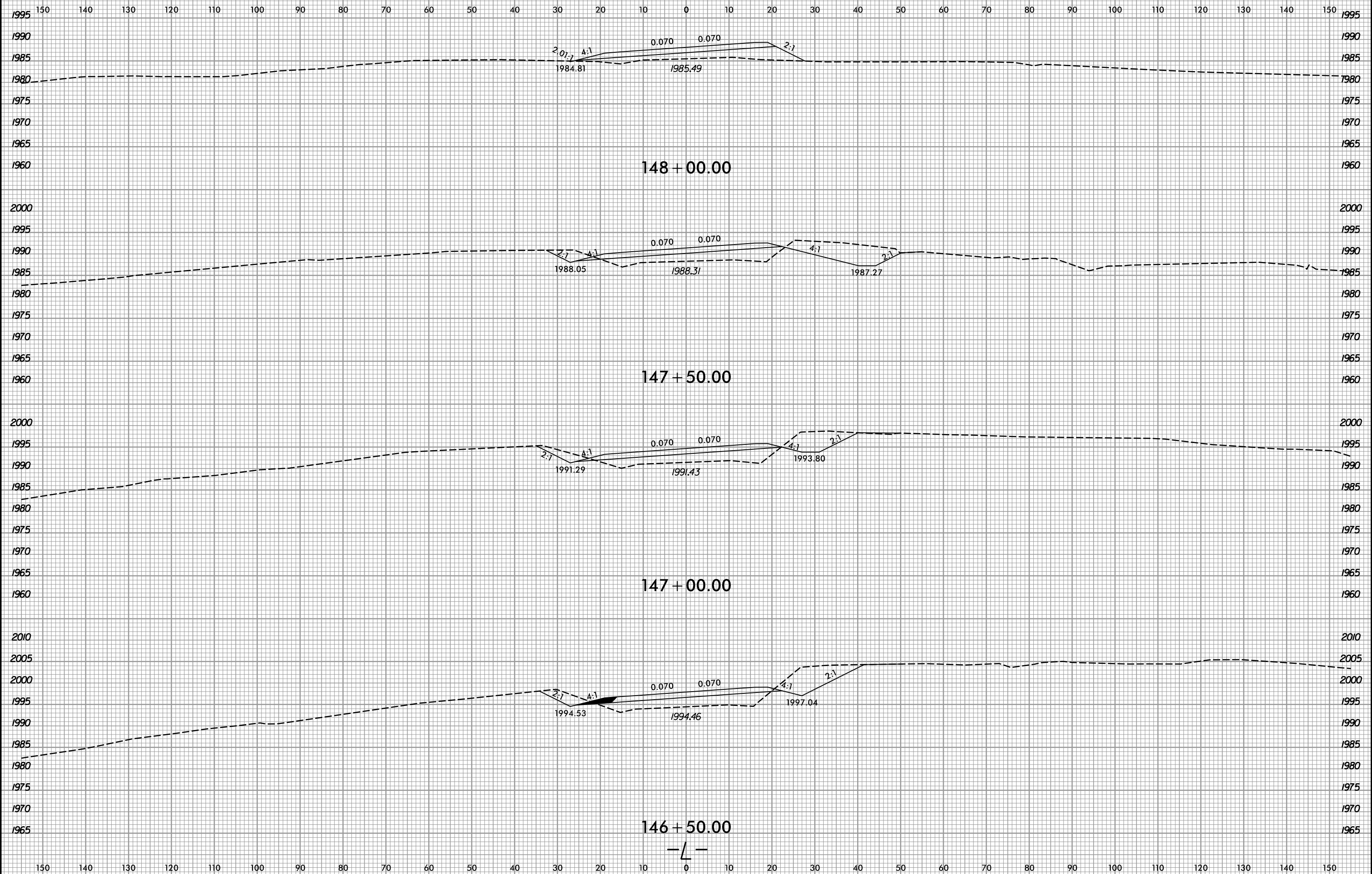

I:\14\2018  
R:\Roadway\Xsc\14-R-5742-Rdy-L\_xpl.dgn  
gprlce



150 140 130 120 110 100 90 80 70 60 50 40 30 20 10 0 10 20 30 40 50 60 70 80 90 100 110 120 130 140 150

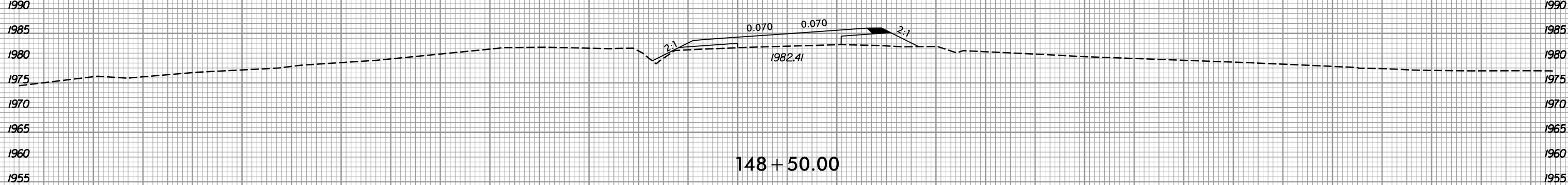
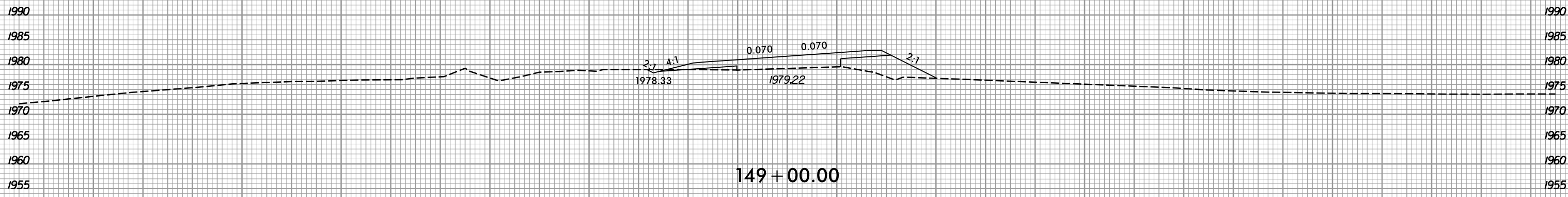
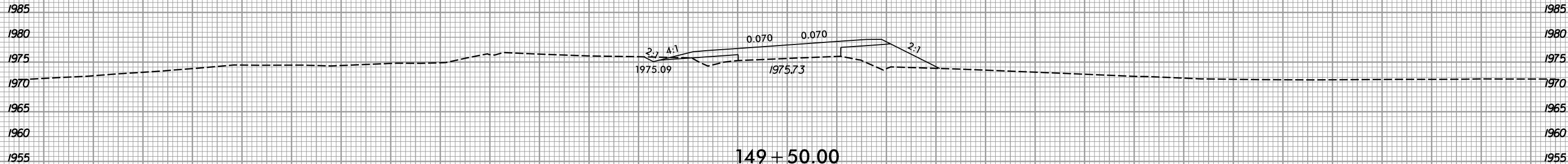

150 140 130 120 110 100 90 80 70 60 50 40 30 20 10 0 10 20 30 40 50 60 70 80 90 100 110 120 130 140 150



150 140 130 120 110 100 90 80 70 60 50 40 30 20 10 0 10 20 30 40 50 60 70 80 90 100 110 120 130 140 150

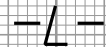
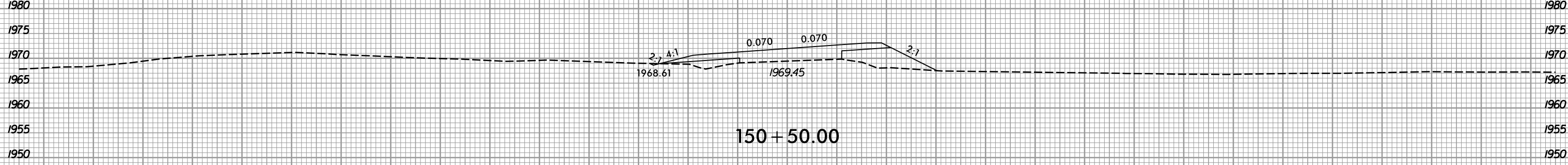
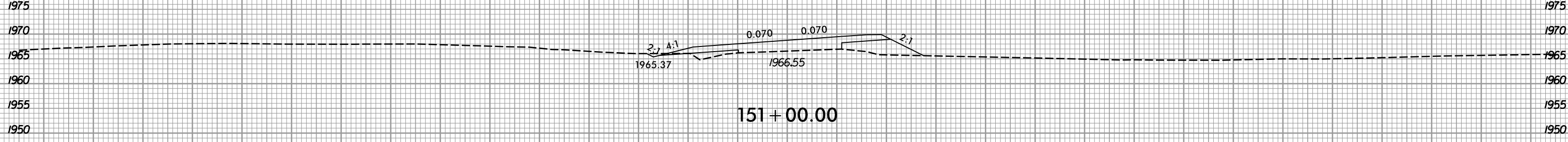
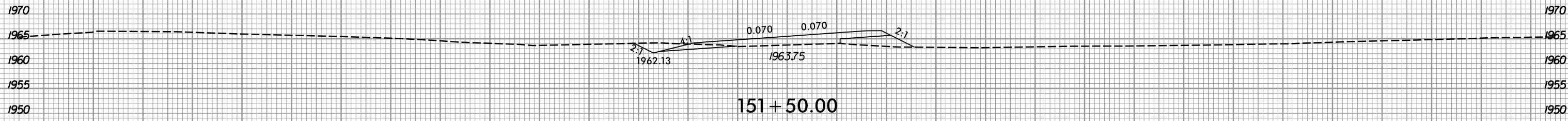
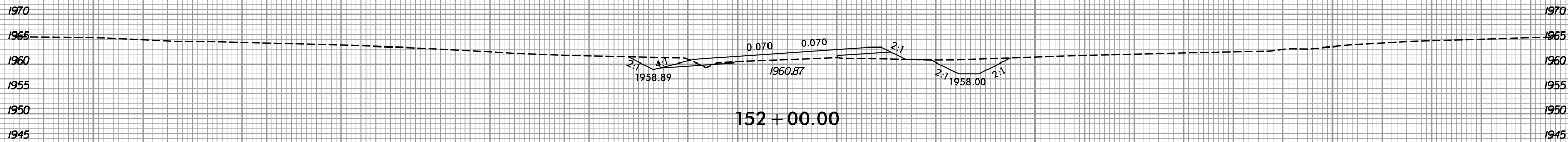
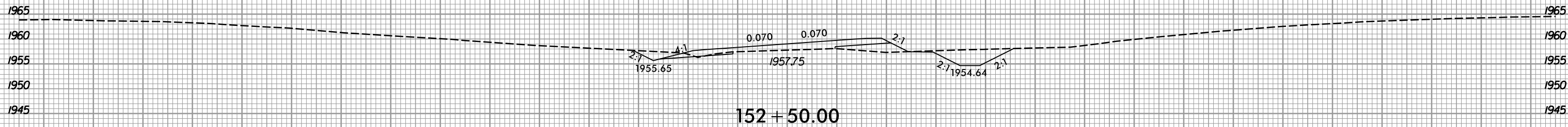

150 140 130 120 110 100 90 80 70 60 50 40 30 20 10 0 10 20 30 40 50 60 70 80 90 100 110 120 130 140 150



150 140 130 120 110 100 90 80 70 60 50 40 30 20 10 0 10 20 30 40 50 60 70 80 90 100 110 120 130 140 150

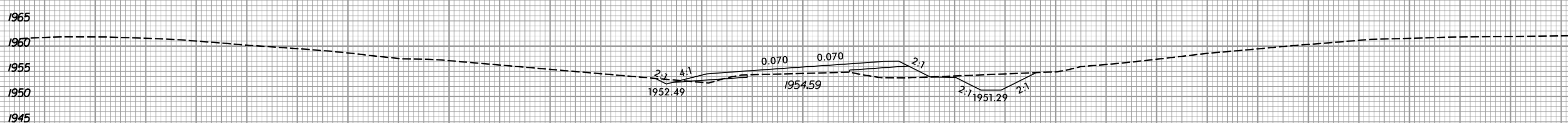
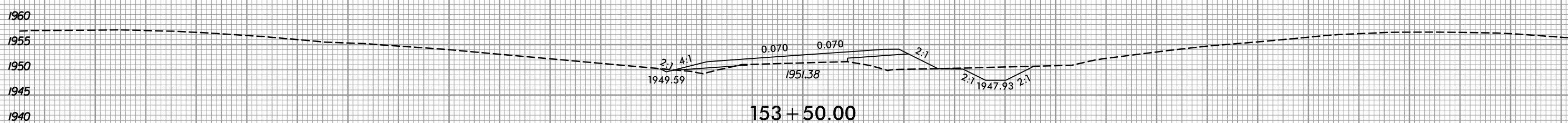
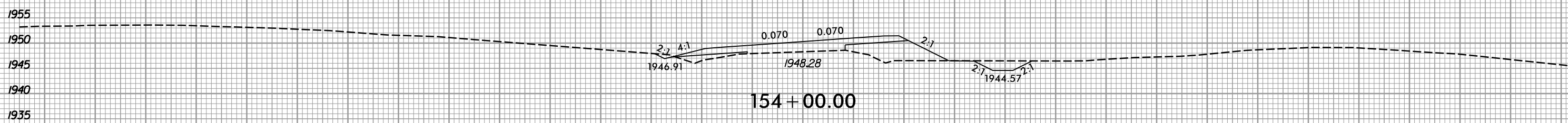
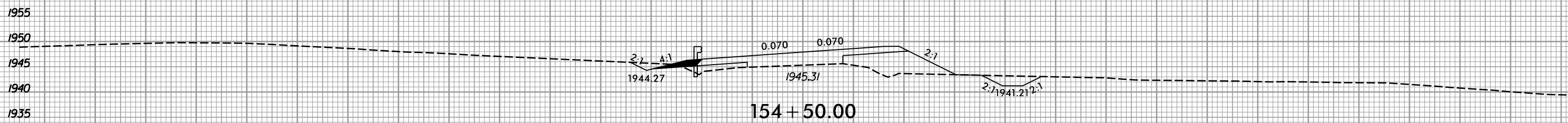
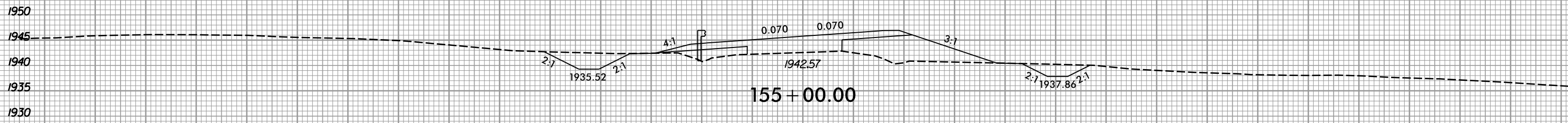
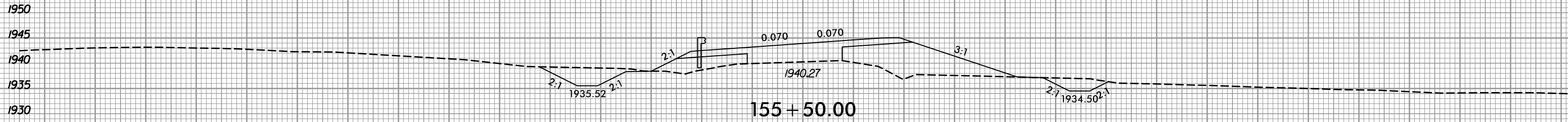

150 140 130 120 110 100 90 80 70 60 50 40 30 20 10 0 10 20 30 40 50 60 70 80 90 100 110 120 130 140 150