



	QUANTITIES			
	ESTIMATE		ACTUAL	
	AREA SQ. FT.	VOLUME CU. FT.	AREA SQ. FT.	VOLUME CU. FT.
SHOTCRETE REPAIRS				
BARREL 1	57.3	28.7		
CONCRETE REPAIRS				
BARREL 1		0.0		
EPOXY RESIN INJECTION				
BARREL 1		6.0		

NOTES

- VALUES IN CHART REPRESENT ESTIMATED REPAIR TOTALS AFTER REMOVAL OF UNSOUND CONCRETE, MINIMUM OF 1" BEHIND REBAR AND MINIMUM 2" CLEARANCE TO SAWCUT. FOR REPAIR DETAILS, SEE "TYPICAL REPAIR DETAILS" SHEET
- REPAIR LOCATIONS AND ESTIMATE OF QUANTITIES ARE BASED ON THE BEST INFORMATION AVAILABLE. IF ADDITIONAL REPAIRS NOT SHOWN ON THE DRAWINGS ARE DEEMED NECESSARY BY THE ENGINEER, THE ENGINEER WILL NOTE ON THE DRAWINGS THE APPROXIMATE LOCATION AND DESCRIPTION OF THE REPAIRS AND ENTER THE ACTUAL QUANTITIES INTO THE AS-BUILT REPAIR QUANTITY TABLE.
- CONCRETE REPAIRS MAY BE SUBSTITUTED IN LIEU OF SHOTCRETE REPAIRS WITH THE APPROVAL OF THE ENGINEER.
- SEE SHEET S-22 FOR CONCRETE REPAIR DETAILS.

-  = SHOTCRETE REPAIR AREA
-  = CONCRETE REPAIR AREA
-  = EPOXY RESIN INJECTION (ERI)

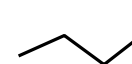
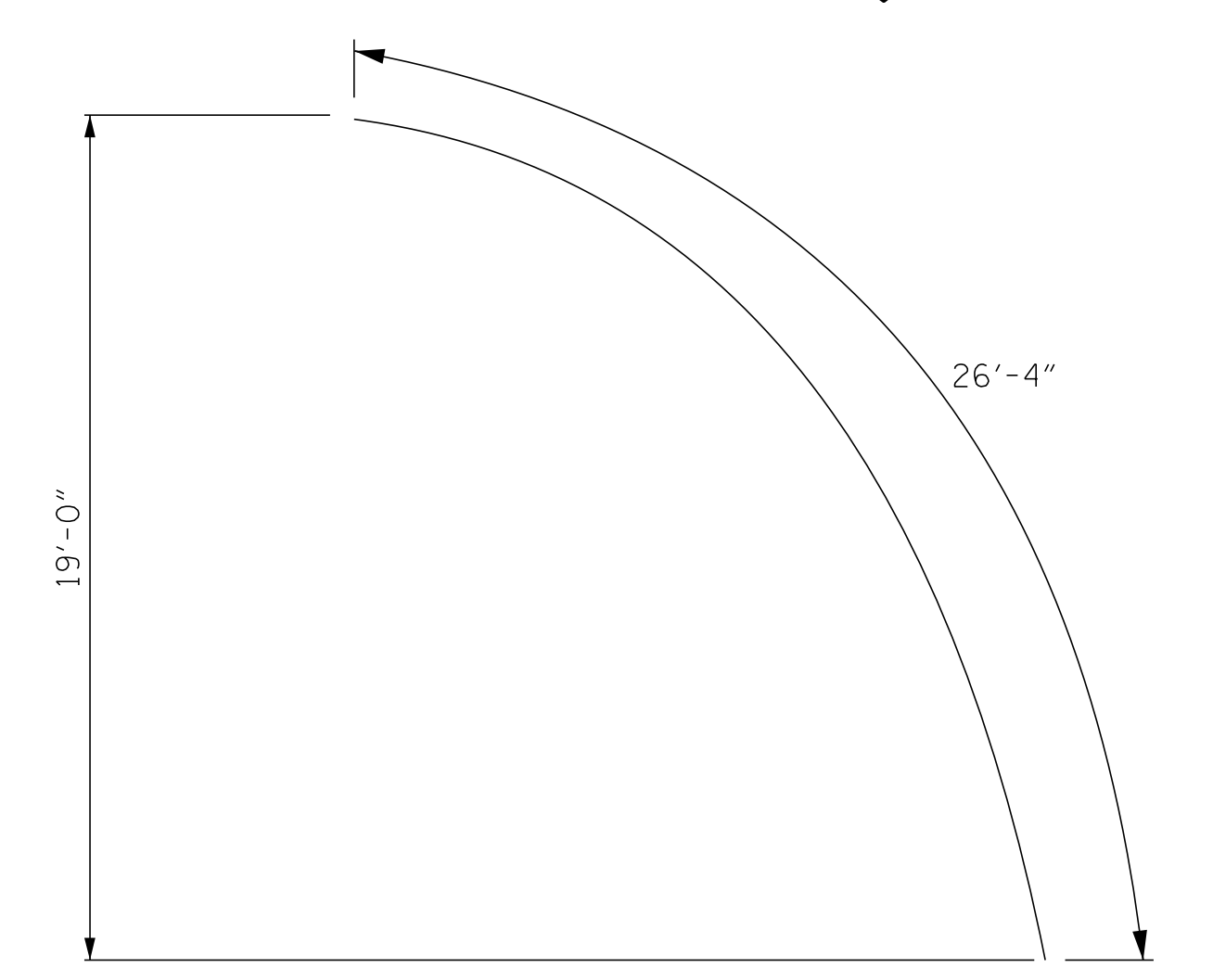
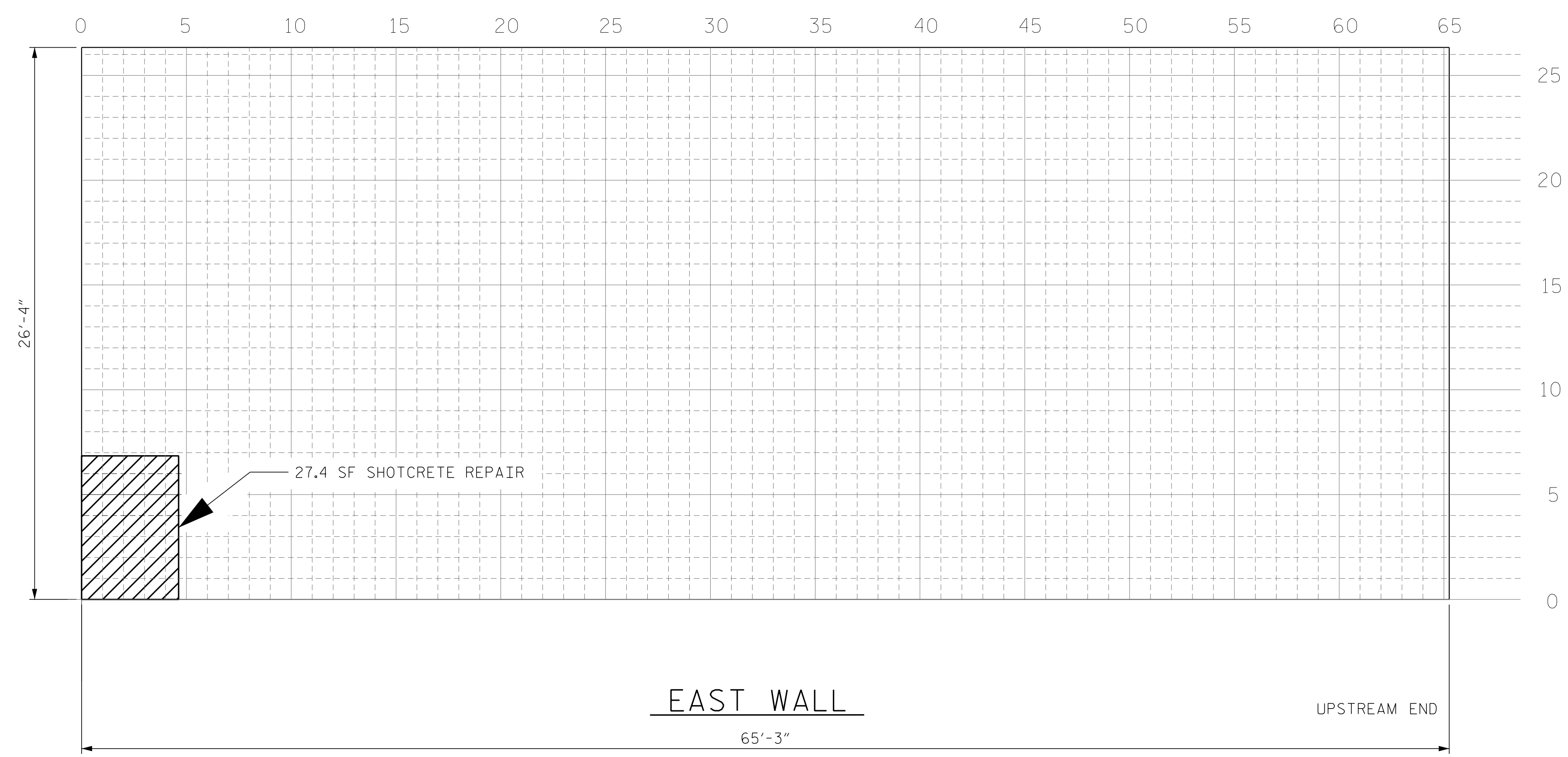
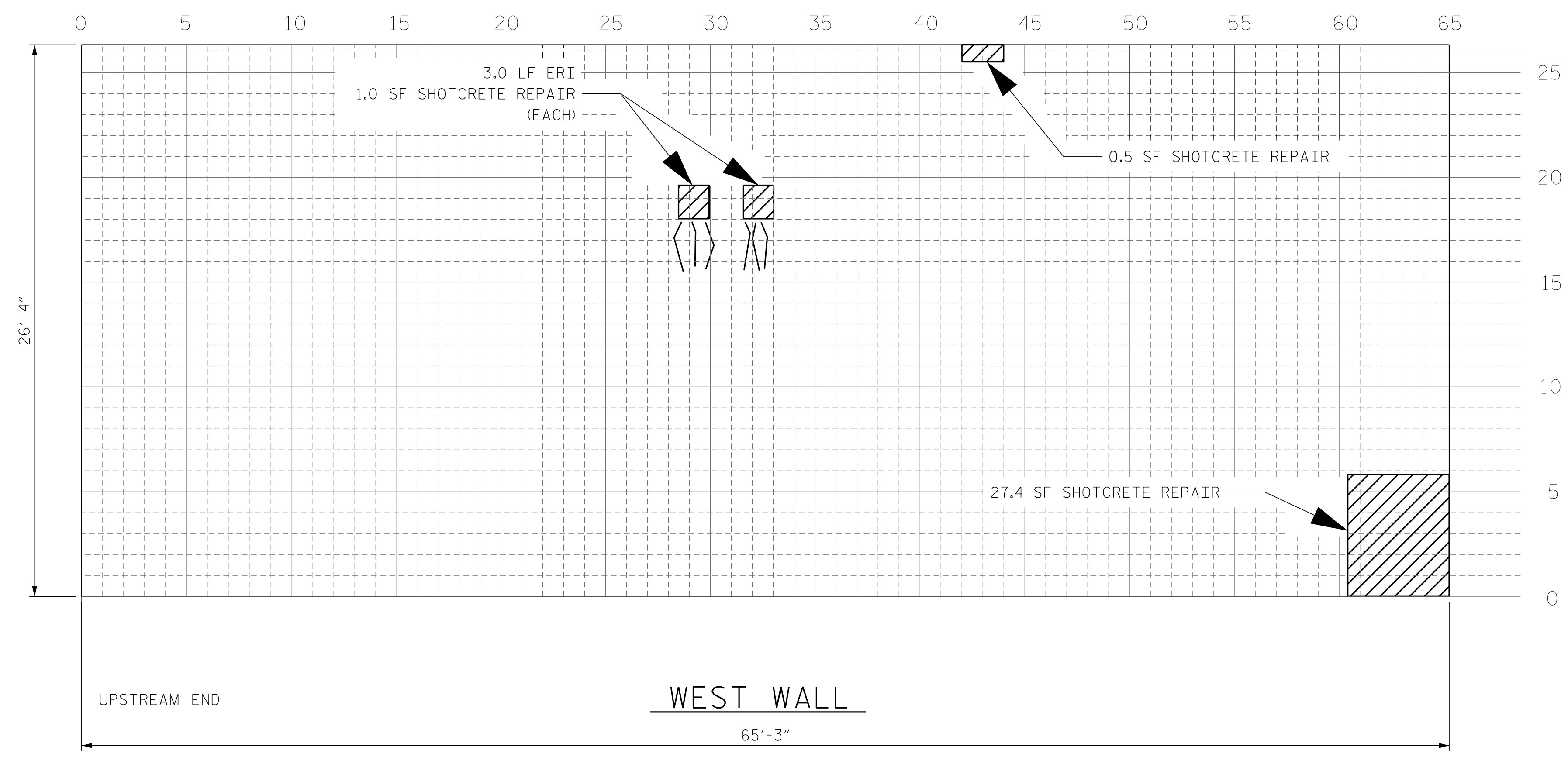

UNWRAPPED ARCH WALL DETAIL

PROJECT NO. 15BPR.32
WATAUGA COUNTY
 STRUCTURE: 940066
 SHEET 3 OF 7

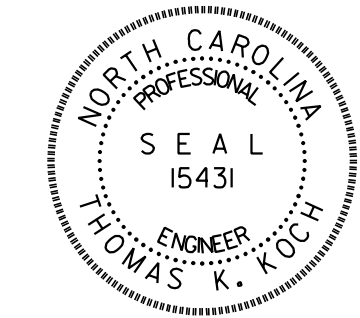
ENGINEER OF RECORD
 12/12/2018

 Thomas K. Koch
 ETHERILL ENGINEERING
 1223 Jones Franklin Rd.
 Raleigh, N.C. 27606
 Bus: 919 851 8077
 Fax: 919 851 8107
 LICENSE NO. F-0377

STATE OF NORTH CAROLINA
 DEPARTMENT OF TRANSPORTATION
 RALEIGH
BARREL EAST AND WEST FACES

REVISIONS						SHEET NO.
NO.	BY:	DATE:	NO.	BY:	DATE:	S-18
1			3			TOTAL SHEETS
2			4			23

DRAWN BY: A. KLINK DATE: 07/18
 CHECKED BY: T. KOCH DATE: 08/18

DOCUMENT NOT CONSIDERED FINAL
 UNLESS ALL SIGNATURES COMPLETED

P:\2018\18153.22_15BPR.32_MCDOT_Culvert Preservation\DWG\WAT AUGA 940066\Watauga 66 Culvert Plan.dgn
 12/12/2018 2:20:36 PM