

**This electronic collection of documents is provided
for the convenience of the user
and is Not a Certified Document –**

**The documents contained herein were originally issued
and sealed by the individuals whose names and license
numbers appear on each page, on the dates appearing
with their signature on that page.**

**This file or an individual page
shall not be considered a certified document.**

PHASING DIAGRAM

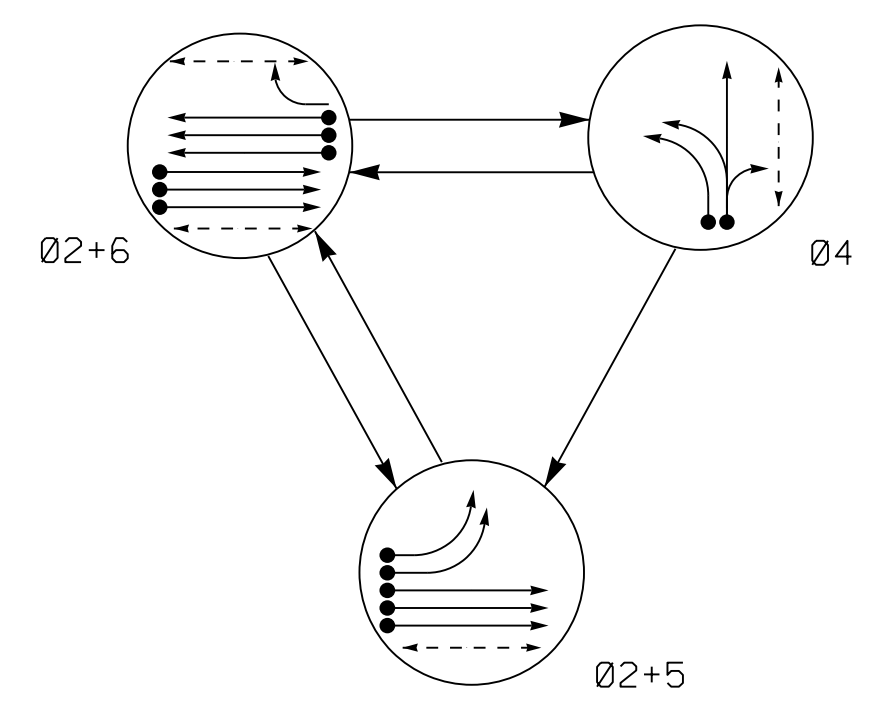

PHASING DIAGRAM DETECTION LEGEND

- DETECTED MOVEMENT
- UNDETECTED MOVEMENT (OVERLAP)
- UNSIGNALIZED MOVEMENT
- ⤴ PEDESTRIAN MOVEMENT

TABLE OF OPERATION

SIGNAL FACE	PHASE			
	02+5	02+6	04	FL HEADS
21,22	G	G	R	Y
41,42	R	R	G	R
51,52	←	←	←	←
61,62,63	R	G	R	Y
P21,P22	W	W	DW	DRK
P41,P42	DW	DW	W	DRK
P43,P44	DW	DW	W	DRK
P61,P62	DW	W	DW	DRK

SIGNAL FACE I.D.

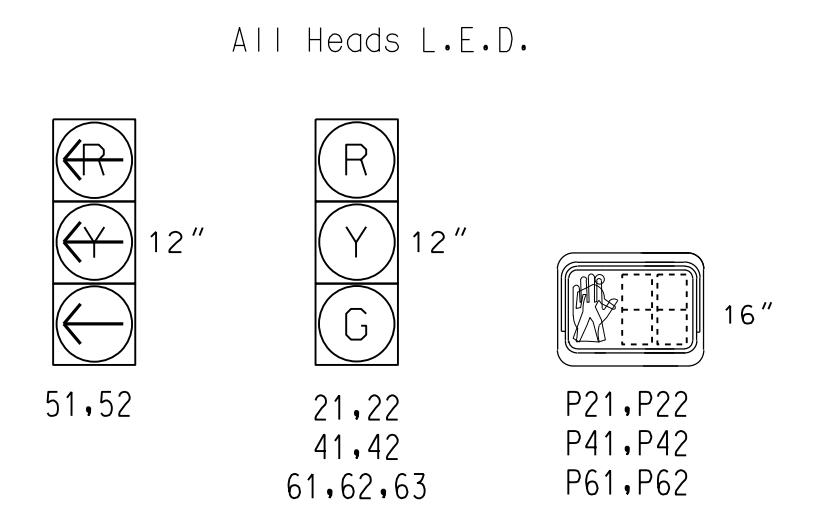

ASC/3 DETECTOR INSTALLATION CHART

LOOP	SIZE (FT)	DISTANCE FROM STOPBAR (FT)	TURNS	NEW LOOP	PROGRAMMING							
					PHASE	CALLING	EXTEND TIME	DELAY TIME	USE ADDED INITIAL	TYPE	LOOP SYSTEM	NEW CARD
2A	6X6	70	4	X	2	Yes	-	-	-	S	-	X
2B	6X6	70	4	X	2	Yes	-	-	-	S	-	X
2C	6X6	70	4	X	2	Yes	-	-	-	S	-	X
4A	6X40	0	2-4-2	X	4	Yes	-	-	-	S	-	X
4B	6X40	0	2-4-2	X	4	Yes	-	10	-	S	-	X
5A	6X40	0	2-4-2	X	5	Yes	-	-	-	S	-	X
5B	6X40	0	2-4-2	X	5	Yes	-	-	-	S	-	X
6A	6X6	70	4	X	6	Yes	-	-	-	S	-	X
6B	6X6	70	4	X	6	Yes	-	-	-	S	-	X
6C	6X6	70	4	X	6	Yes	-	-	-	S	-	X

3 Phase Fully Actuated Fayetteville Signal System

NOTES

- Refer to "Roadway Standard Drawings NCDOT" dated January 2018 and "Standard Specifications for Roads and Structures" dated January 2018.
- Do not program signal for late night flashing operation unless otherwise directed by the Engineer.
- Phase 5 may be lagged.
- Set all detector units to presence mode.
- Omit "WALK" and flashing "DON'T WALK" with no pedestrian calls.
- Program pedestrian heads to countdown the flashing "DON'T WALK" time only.
- Maximum times shown in timing chart are for free-run operation only. Coordinated signal system timing values supersede these values.
- Pedestrian pedestals are conceptual and shown for reference only. See 2018 NCDOT Roadway Standard Drawings 1705.04 Sheets 1-3 for push button location details.

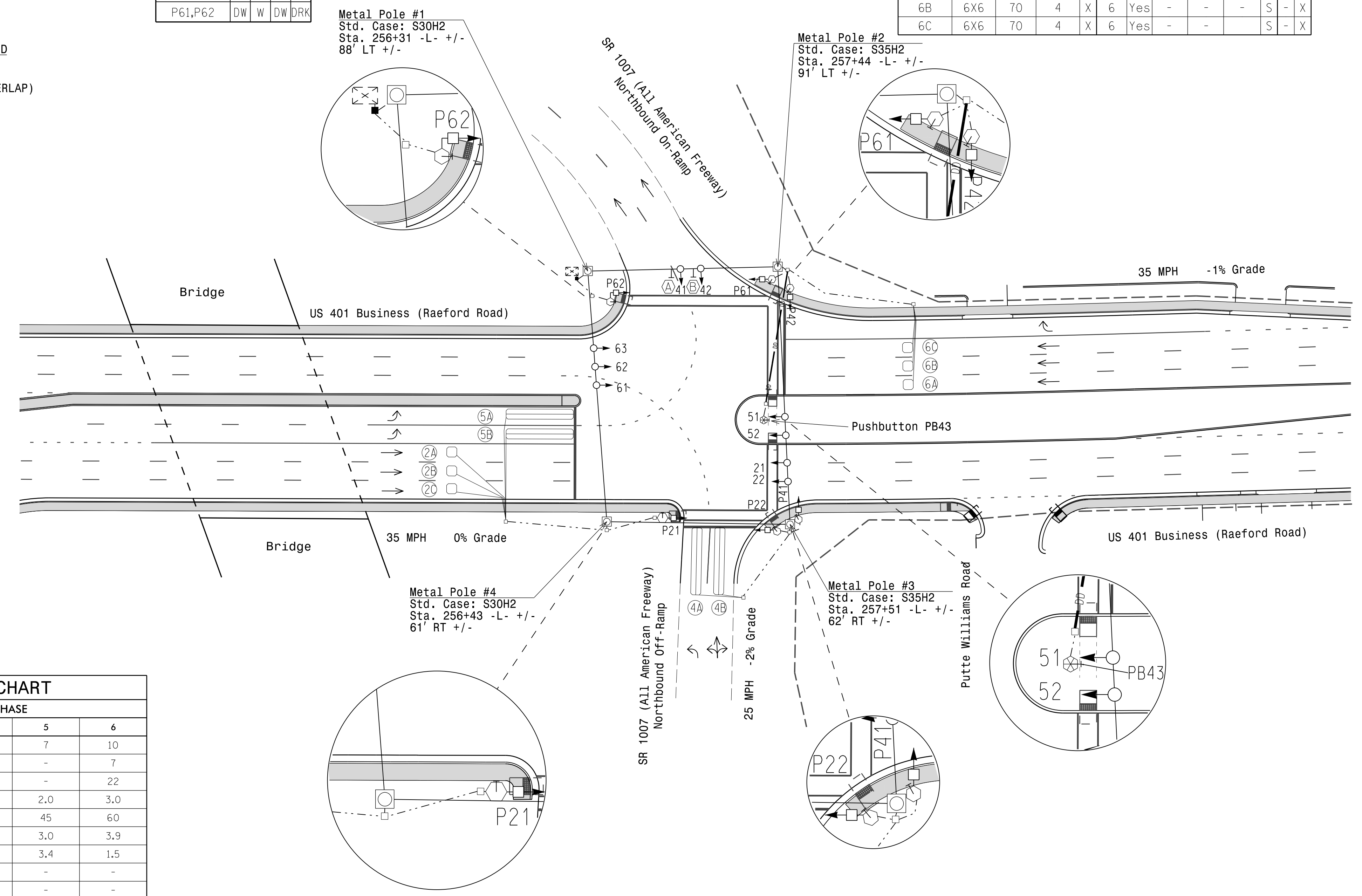

ASC/3 TIMING CHART

FEATURE	PHASE			
	2	4	5	6
Min Green *	10	7	7	10
Walk *	7	7	-	7
Ped Clear	12	34	-	22
Veh. Extension *	3.0	2.0	2.0	3.0
Max I *	60	30	45	60
Yellow	3.8	3.3	3.0	3.9
Red Clear	2.3	3.4	3.4	1.5
Red Revert	-	-	-	-
Actuations B4 Add *	-	-	-	-
Seconds / Actuation *	-	-	-	-
Max Initial *	-	-	-	-
Time Before Reduction *	-	-	-	-
Time To Reduce *	-	-	-	-
Minimum Gap	-	-	-	-
Locking Detector	X	-	-	X
Recall Position	VEH. RECALL	-	-	VEH. RECALL
Dual Entry	-	-	-	-
Simultaneous Gap	X	X	X	X

LEGEND

PROPOSED	EXISTING
○ → Traffic Signal Head	● → Traffic Signal Head
○ → Modified Signal Head	N/A
○ → Pedestrian Signal Head With Push Button & Sign	○ → Pedestrian Signal Head
○ → Signal Pole with Guy	○ → Signal Pole with Sidewalk Guy
□ → Inductive Loop Detector	□ → Junction Box
□ → Controller & Cabinet	□ → 2-in Underground Conduit
□ → Junction Box	□ → Right of Way
→ → Directional Arrow	→ → Directional Drill
○ → Metal Strain Pole	○ → Metal Strain Pole
⊗ → Type I Pushbutton Post	⊗ → Type II Signal Pedestal
○ → Type II Signal Pedestal	○ → Left Arrow "ONLY" Sign (R3-5L)
⊗ → Left Arrow "ONLY" Sign (R3-5L)	⊗ → Dual Turn and Through Arrows Sign
⊗ → Dual Turn and Through Arrows Sign	⊗ → Dual Turn and Through Arrows Sign

Signal Upgrade - Final Design

Stantec

Stantec Consulting Services Inc.
801 Jones Franklin Road-Suite 300
Raleigh, NC 27606
Tel. (919) 851-6866
Fax. (919) 851-7024
www.stantec.com
License No. F-0672

Prepared for the Offices of:
Transportation Mobility and Safety Division
STATE OF NORTH CAROLINA
Signal Design Section

750 N. Greenfield Pkwy, Garner, NC 27526

SCALE
0 40
1" = 40'

US 401 Business (Raeford Road) at SR 1007 (All American Freeway) Northbound Ramps

Division 6 Cumberland County Fayetteville

PLAN DATE: March 2018 REVIEWED BY: E D Harris

PREPARED BY: J HAMBRIGHT REVIEWED BY: B L Watson

REVISIONS	INIT.	DATE

DOCUMENT NOT CONSIDERED FINAL UNLESS ALL SIGNATURES COMPLETED

3/29/2018

DATE 3/29/2018

SIG. INVENTORY NO. 06-0323

3/29/2018
 User: rfmancey
 C:\Users\rfmancey\Documents\Signal Design\4405\Sig\4405-06-0323 Final.dgn

* These values may be field adjusted. Do not adjust Min Green and Extension times for phases 2 and 6 lower than what is shown. Min Green for all other phases should not be lower than 4 seconds.

PHASING DIAGRAM

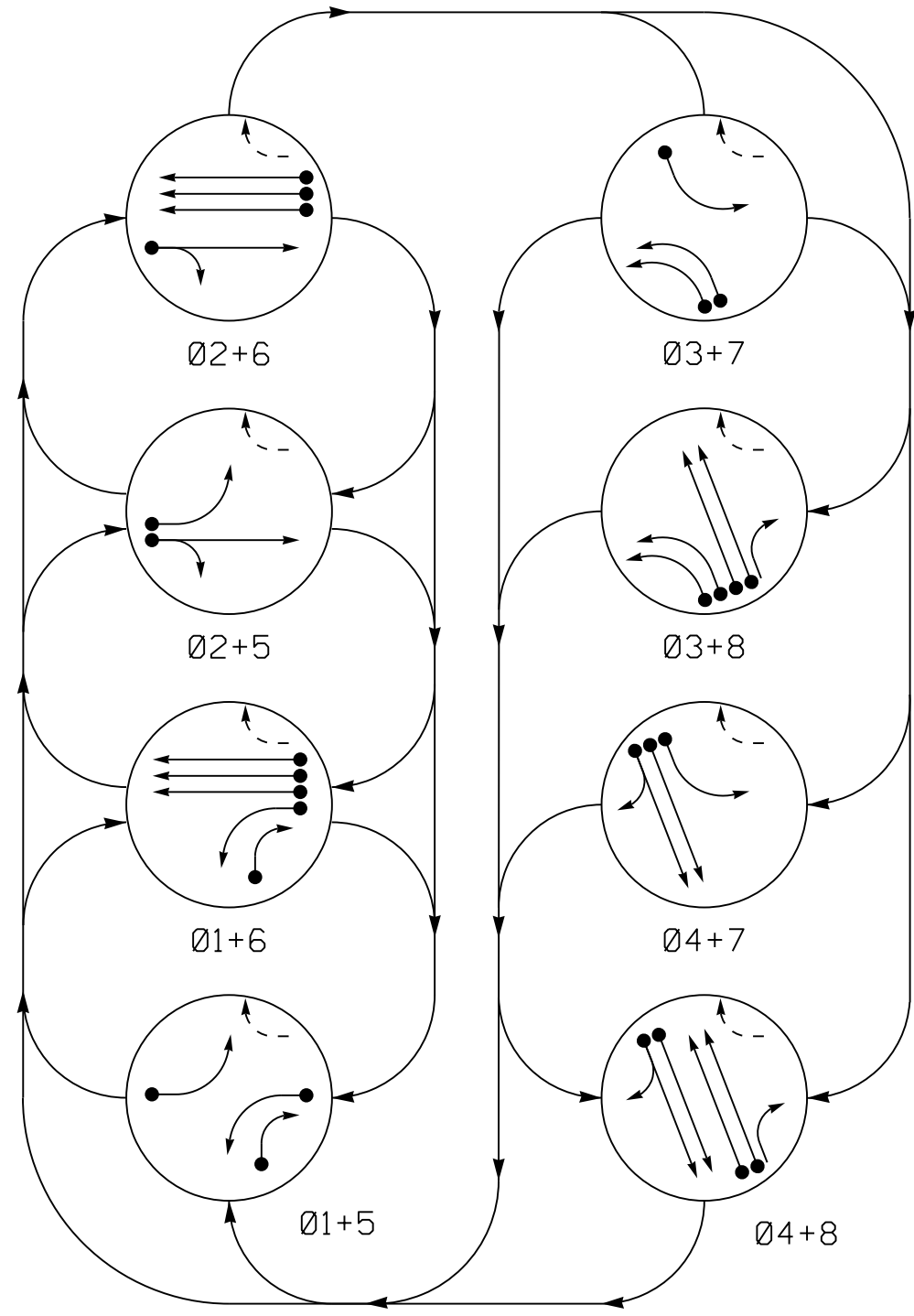

RAIL PREEMPT PHASES (High Priority)

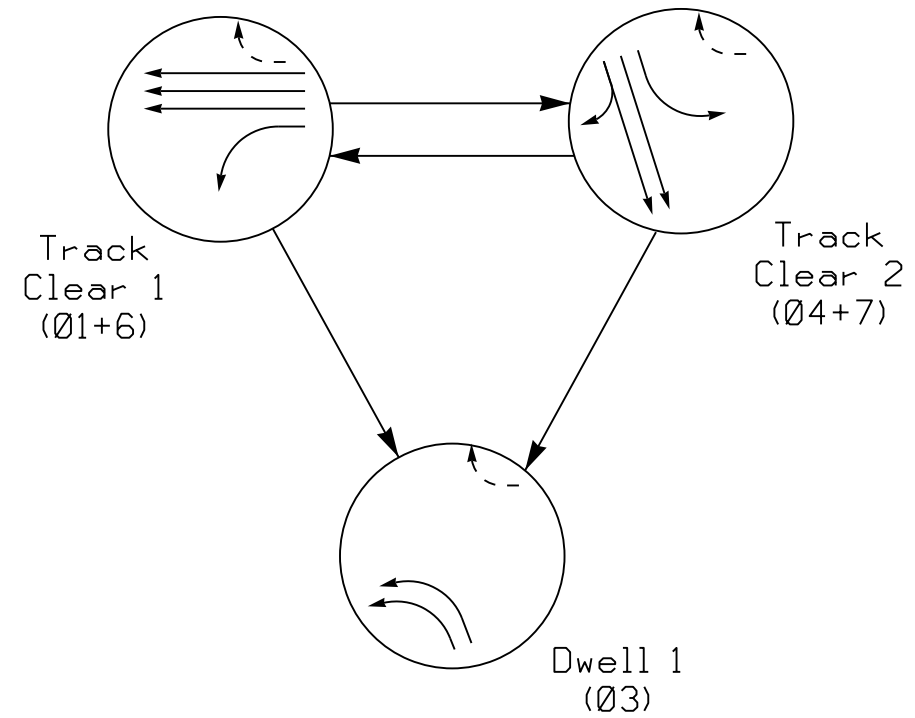

PHASING DIAGRAM DETECTION LEGEND

- DETECTED MOVEMENT
- UNDETECTED MOVEMENT (OVERLAP)
- - - UNSIGNALIZED MOVEMENT
- ◀ - - - PEDESTRIAN MOVEMENT

TABLE OF OPERATION

SIGNAL FACE	PHASE											
	01+5	01+6	02+5	02+6	03+7	03+8	04+7	04+8	1	2	3	4
11	←	←	←	←	←	←	←	←	←	←	←	←
21,22	R	R	G	G	R	R	R	R	R	R	R	Y
31,32	←	←	←	←	←	←	←	←	←	←	←	←
41,42	R	R	R	R	R	R	G	G	R	G	R	R
51	←	←	←	←	←	←	←	←	←	←	←	←
61,62	R	G	R	G	R	R	R	R	G	R	R	Y
71	←	←	←	←	←	←	←	←	←	←	←	←
81	R	R	R	R	R	G	R	G	R	R	R	R
82	←	←	←	←	←	←	←	←	←	←	←	←
Sign (A)	OFF	OFF	OFF	OFF	OFF	OFF	OFF	OFF	ON	ON	ON	*

* See Note 8

ASC/3 DETECTOR INSTALLATION CHART

LOOP	SIZE (FT)	DISTANCE FROM STOPBAR (FT)	TURNS	NEW LOOP	PROGRAMMING							
					PHASE	CALLING	EXTEND TIME	DELAY TIME	USE ADDED INITIAL	TYPE	LOOP	NEW CARD
1A	6X40	0	*	-	1	Yes	-	3	-	S	-	X
1B	6X40	0	*	-	1	Yes	-	15	-	S	-	X
2A	6X6	70	*	-	2	Yes	-	-	-	S	-	X
3A	6X40	0	*	-	3	Yes	-	3	-	S	-	X
3B	6X40	0	*	-	3	Yes	-	-	-	S	-	X
4A	6X40	0	*	-	4	Yes	-	-	-	S	-	X
4B	6X40	0	*	-	4	Yes	-	10	-	S	-	X
4C	6X15	0	*	-	4	Yes	-	15	-	S	-	X
5A	6X40	0	*	-	5	Yes	-	3	-	S	-	X
6A	6X6	70	*	-	6	Yes	-	-	-	S	-	X
6B	6X6	70	*	-	6	Yes	-	-	-	S	-	X
6C	6X6	70	*	-	6	Yes	-	-	-	S	-	X
7A	6X40	0	*	-	7	Yes	-	3	-	S	-	X
8A	6X40	0	*	-	8	Yes	-	-	-	S	-	X
8B	6X40	0	*	-	8	Yes	-	-	-	S	-	X

* Video Detection Area. Camera locations should be confirmed in the filed by the contractor in order to provide detection of the areas indicated.

ASC/3 RR PREEMPT

FUNCTION	SEQUENCE 1	SEQUENCE 2
Exit Phase(s)	4,8	4,8
Preempt Override	OFF	OFF
Delay Time	0	0
Ped Clear Trough Yellow	N	N
Terminate Phases	N	N
Track Clear Reserve	Y	Y
Entrance Walk	255*	255*
Entrance Ped Clear	255*	255*
Entrance Min Green	1	1
Entrance Yellow Change	25.5*	25.5*
Entrance Red Clear	25.5*	25.5*
Track Clear Min Green 1	35	21
Track Clear Yellow Change 1	3.8	4.6
Track Clear Red Clear 1	2.1	1.7
Track Clear Min Green 2	21	35
Track Clear Yellow Change 2	4.6	3.8
Track Clear Red Clear 2	1.7	2.1
Min Dwell Time	7	7
Exit Yellow Change	25.5*	25.5*
Exit Red Clear	25.5*	25.5*

* Time defaults to time used for phase during normal operation.

SIGNAL FACE I.D.

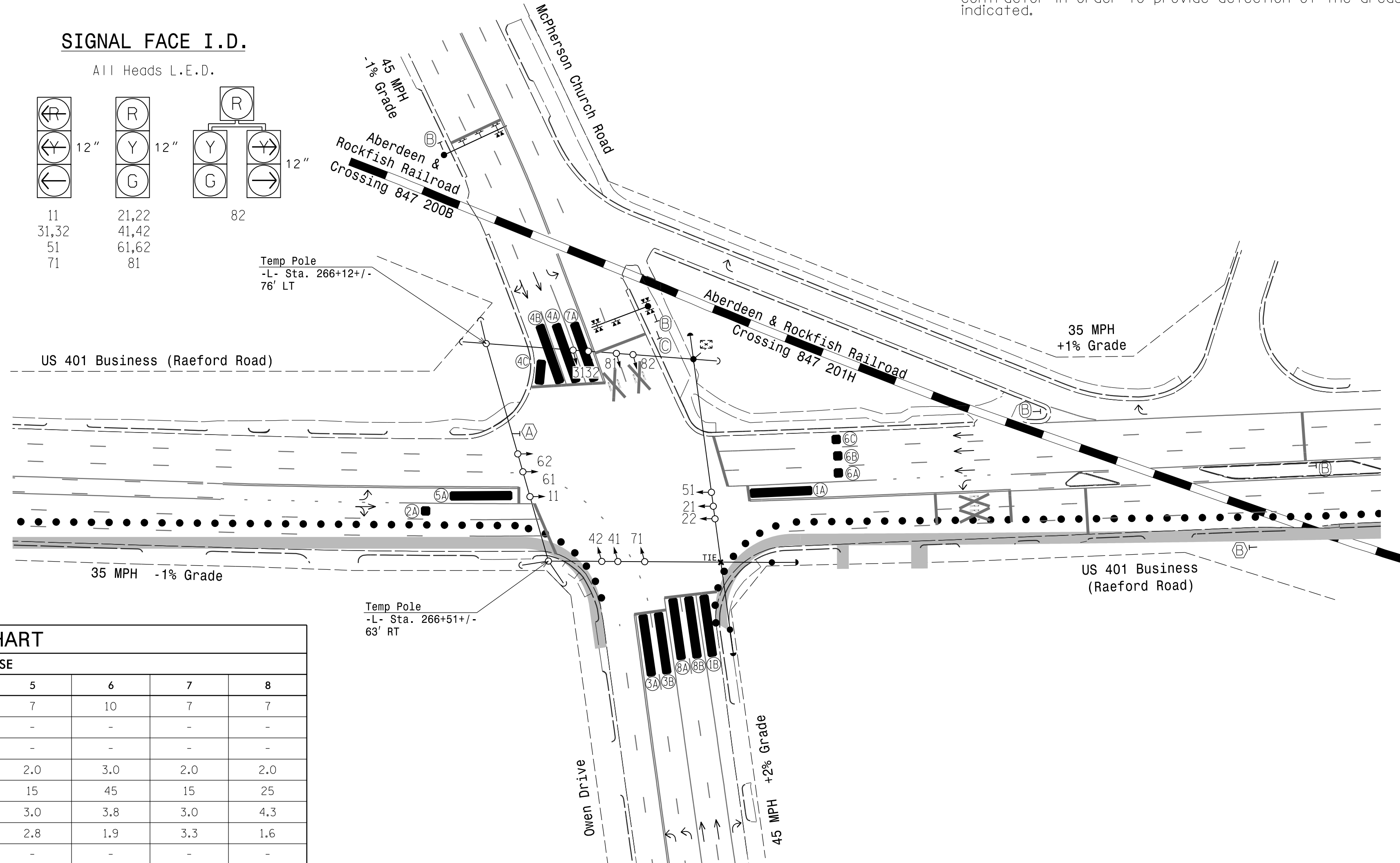
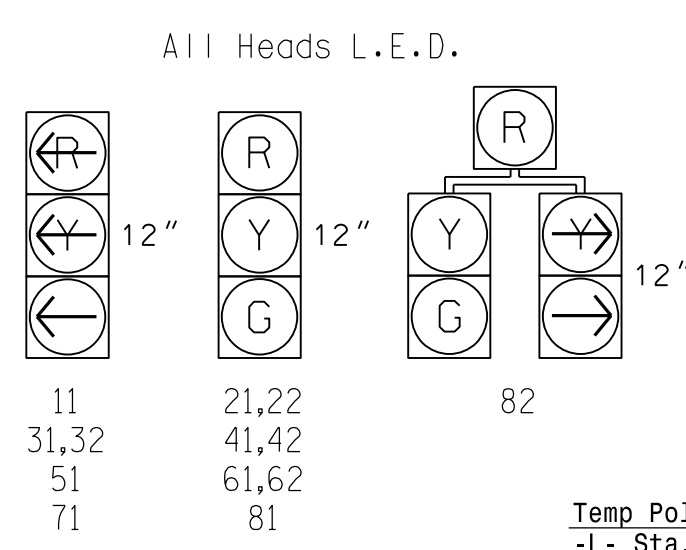

LEGEND

- | PROPOSED | EXISTING |
|----------------------------------------------------|-----------------------------|
| ○ → Traffic Signal Head | ● → Modified Signal Head |
| ○ → Pedestrian Signal Head With Push Button & Sign | ○ → Signal Pole with Guy |
| ○ → Signal Pole with Sidewalk Guy | ○ → Inductive Loop Detector |
| □ → Controller & Cabinet | □ → Junction Box |
| --- 2-in Underground Conduit | --- Right of Way |
| → Directional Arrow | → Railroad Cantilever |
| --- Railroad Tracks | --- Railroad Tracks |
| ■ Video Detection Area | N/A |
| ■ Construction Zone | N/A |
| ● Construction Zone Drums | N/A |
| (A) "NO RIGHT TURN - TRAIN" L.E.D. Blankout Sign | (A) |
| (B) "DO NOT STOP ON TRACKS" Sign (R8-8) | (B) |
| (C) "Stop Here on Red" Sign (R10-6) | (C) |

ASC/3 TIMING CHART

FEATURE	PHASE							
	1	2	3	4	5	6	7	8
Min Green *	7	10	7	7	7	10	7	7
Walk *	-	-	-	-	-	-	-	-
Ped Clear	-	-	-	-	-	-	-	-
Veh. Extension *	2.0	3.0	2.0	2.0	2.0	3.0	2.0	2.0
Max 1 *	15	45	15	25	15	45	15	25
Yellow	3.0	3.9	3.0	4.6	3.0	3.8	3.0	4.3
Red Clear	2.9	2.1	3.3	1.4	2.8	1.9	3.3	1.6
Red Revert	-	-	-	-	-	-	-	-
Actuations B4 Add *	-	-	-	-	-	-	-	-
Seconds /Actuation *	-	-	-	-	-	-	-	-
Max Initial *	-	-	-	-	-	-	-	-
Time Before Reduction *	-	-	-	-	-	-	-	-
Time To Reduce *	-	-	-	-	-	-	-	-
Minimum Gap	-	-	-	-	-	-	-	-
Locking Detector	-	X	-	-	-	X	-	-
Recall Position	-	VEH. RECALL	-	-	-	VEH. RECALL	-	-
Dual Entry	-	-	-	-	-	-	-	-
Simultaneous Gap	X	X	X	X	X	X	X	X

* These values may be field adjusted. Do not adjust Min Green and Extension times for phases 2 and 6 lower than what is shown. Min Green for all other phases should not be lower than 4 seconds.

This signal is designed for simultaneous preemption

Signal Upgrade
Temporary Design 1 - TMP Phase I

<p>Stantec Consulting Services Inc. 801 Jones Franklin Road-Suite 300 Raleigh, NC 27606 Tel. (919) 851-6866 Fax. (919) 851-7024 www.stantec.com License No. F-0672</p>		<p>US 401 Business (Raeford Road) at McPherson Church Road/ Owen Drive</p>		
		<p>Division 6 Cumberland County Fayetteville</p>	<p>PLAN DATE: March 2018 REVIEWED BY: E D Harris</p>	
<p>750 N. Greenfield Pkwy, Garner, NC 27526</p>		<p>SCALE: 0 50 1" = 50'</p>		<p>3/29/2018</p>

DOCUMENT NOT CONSIDERED FINAL UNLESS ALL SIGNATURES COMPLETED

EDI MODEL 2018ECLip-NC CONFLICT MONITOR PROGRAMMING DETAIL

(remove jumpers and set switches as shown)

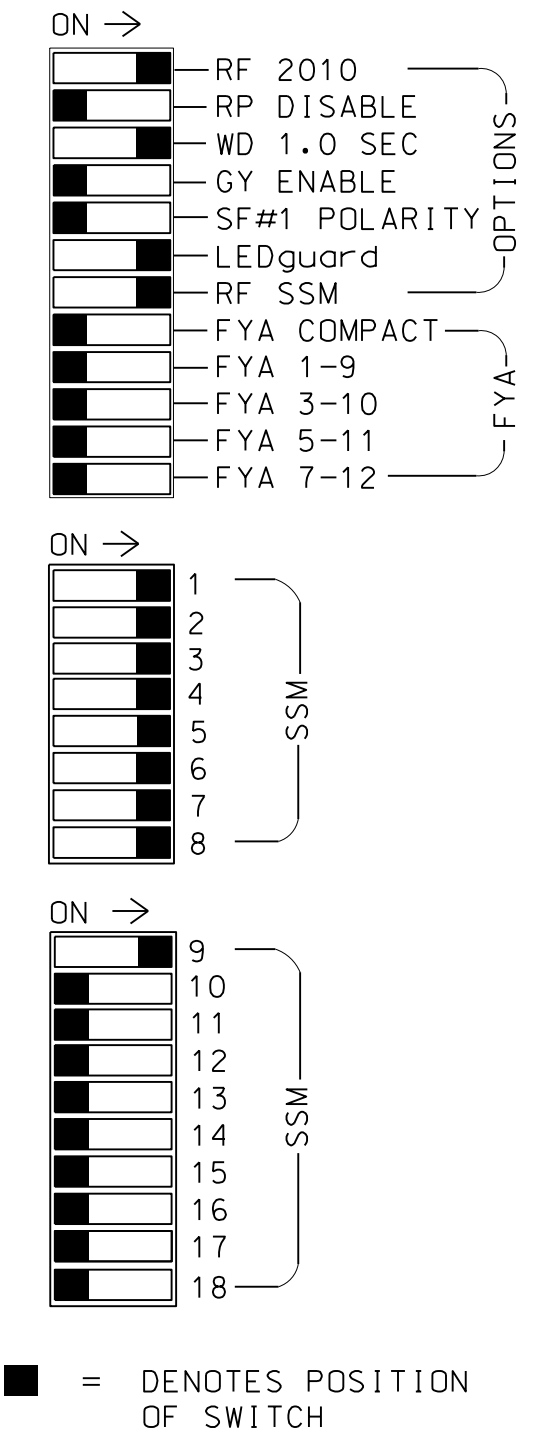
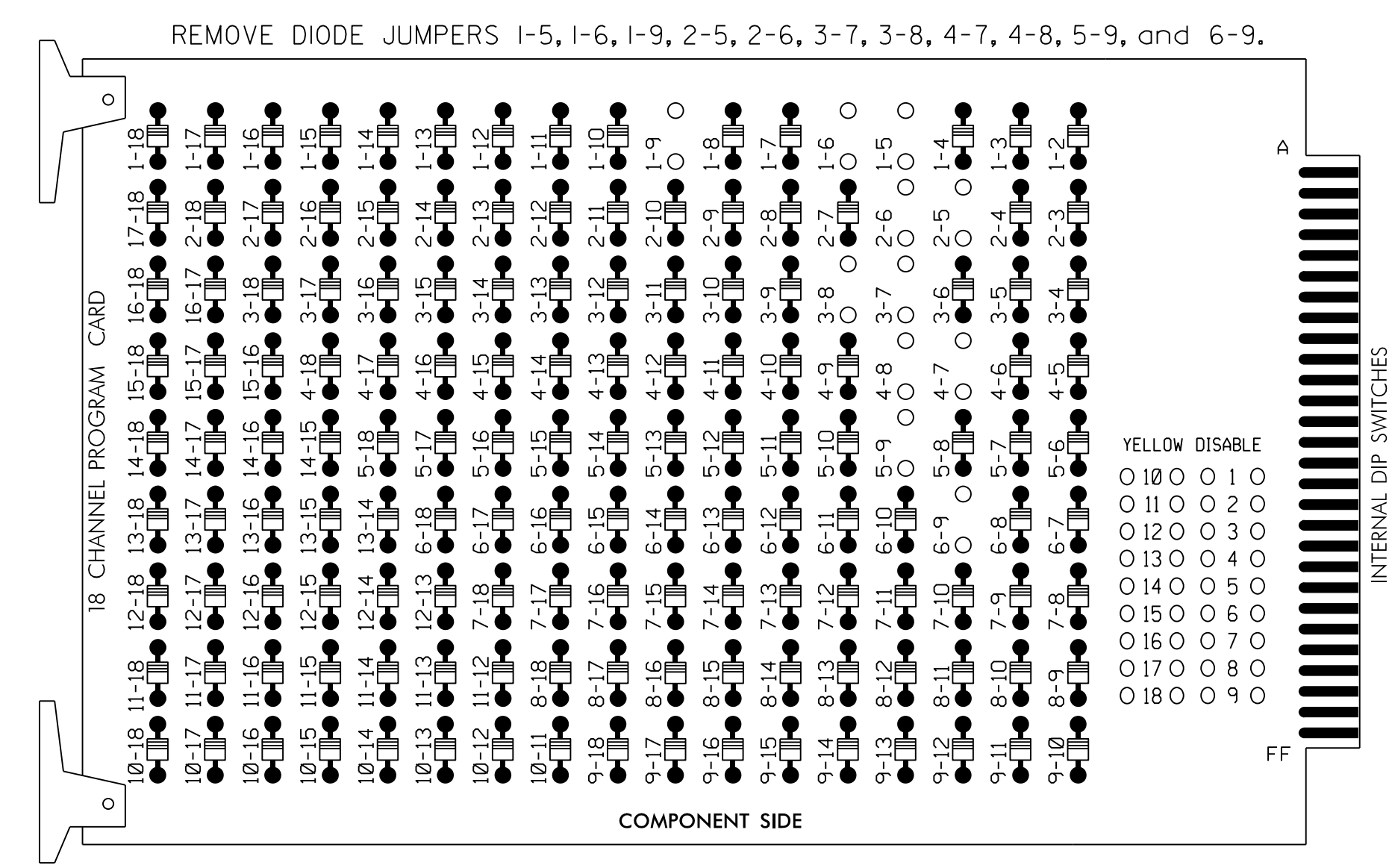

NOTES:

- Card is provided with all diode jumpers in place. Removal of any jumper allows its channels to run concurrently.
- Ensure jumpers SEL2-SEL5 and SEL9 are present on the monitor board.
- Ensure that Red Enable is active at all times during normal operation.
- Integrate monitor with Ethernet network in cabinet.

NOTES

- To prevent "flash-conflict" problems, insert red flash program blocks for all unused vehicle load switches in the output file. The installer shall verify that signal heads flash in accordance with the Signal Plans.
- Program controller to start up in Phase 2 Green and Phase 6 Green.
- The cabinet and controller are part of the Fayetteville Signal System.

EQUIPMENT INFORMATION

CONTROLLER.....2070
 CABINET.....332 W/ AUX
 SOFTWARE.....ECONOLITE ASC/3-2070
 CABINET MOUNT.....BASE
 OUTPUT FILE POSITIONS...18 WITH AUX. OUTPUT FILE
 LOAD SWITCHES USED.....S1,S2,S4,S5,S7,S8,
 S10,S11,AUX S1
 PHASES USED.....1,2,3,4,5,6,7,8
 OVERLAP A.....1
 OVERLAP B.....NOT USED
 OVERLAP C.....NOT USED
 OVERLAP D.....NOT USED

SIGNAL HEAD HOOK-UP CHART

	S1	S2	S3	S4	S5	S6	S7	S8	S9	S10	S11	S12	AUX S1	AUX S2	AUX S3	AUX S4	AUX S5	AUX S6
CMU CHANNEL NO.	1	2	13	3	4	14	5	6	15	7	8	16	9	10	17	11	12	18
PHASE	1	2	2 PED	3	4	4 PED	5	6	6 PED	7	8	8 PED	OLA	OLB	SPARE	OLC	OLD	SPARE
SIGNAL HEAD NO.	11	21,22	NU	31,32	41,42	NU	51	61,62	NU	71	81,82	NU	82					
RED		128			101			134			107		*					
YELLOW		129			102			135			108							
GREEN		130			103			136			109							
RED ARROW	125				116			131			122							
YELLOW ARROW	126				117			132			123		A122					
GREEN ARROW	127				118			133			124		A123					

NU = Not Used

* Denotes install load resistor. See load resistor installation detail this sheet.

ECONOLITE ASC/3-2070 OVERLAP PROGRAMMING DETAIL

(program controller as shown)

- From Main Menu select **2. CONTROLLER**
- From CONTROLLER Submenu select **2. VEHICLE OVERLAPS**

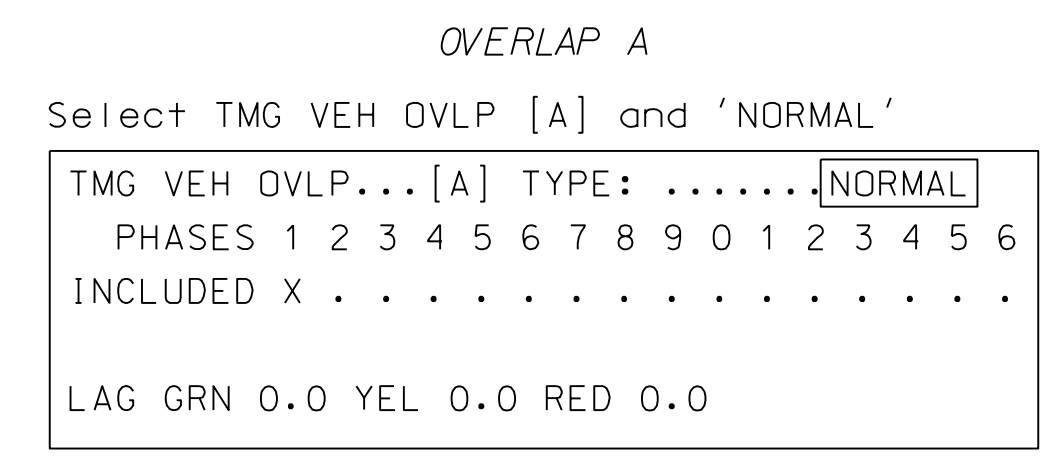

END PROGRAMMING

THIS ELECTRICAL DETAIL IS FOR THE SIGNAL DESIGN: 06-0054T1
 DESIGNED: March 2018
 SEALED: 03-29-2018
 REVISED: N/A

INPUT FILE POSITION LAYOUT

(front view)

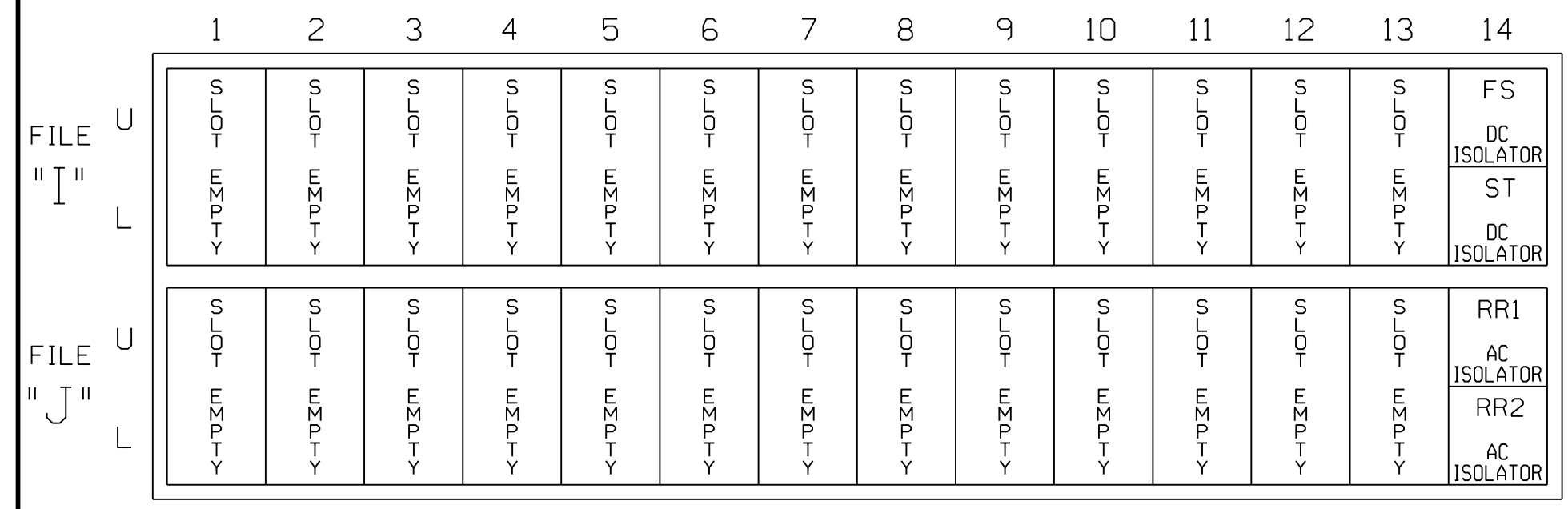

EX.: 1A, 2A, ETC. = LOOP NO.'S

FS = FLASH SENSE
 ST = STOP TIME
 RR1,RR2 = RAILROAD PREEMPTS

NOTE: The RR1 and RR2 preempt inputs have been remapped as detector inputs for use by the Logic Processor. See sheet 5 for details.

SPECIAL DETECTOR NOTE

Install a video detection system for vehicle detection. Perform installation according to manufacturer's directions and NCDOT engineer-approved mounting locations to accomplish the detection schemes shown on the Signal Design Plans.

AC ISOLATOR (MODEL 252) OUTPUT PROGRAMMING DETAIL

(set DIP switches as shown below)

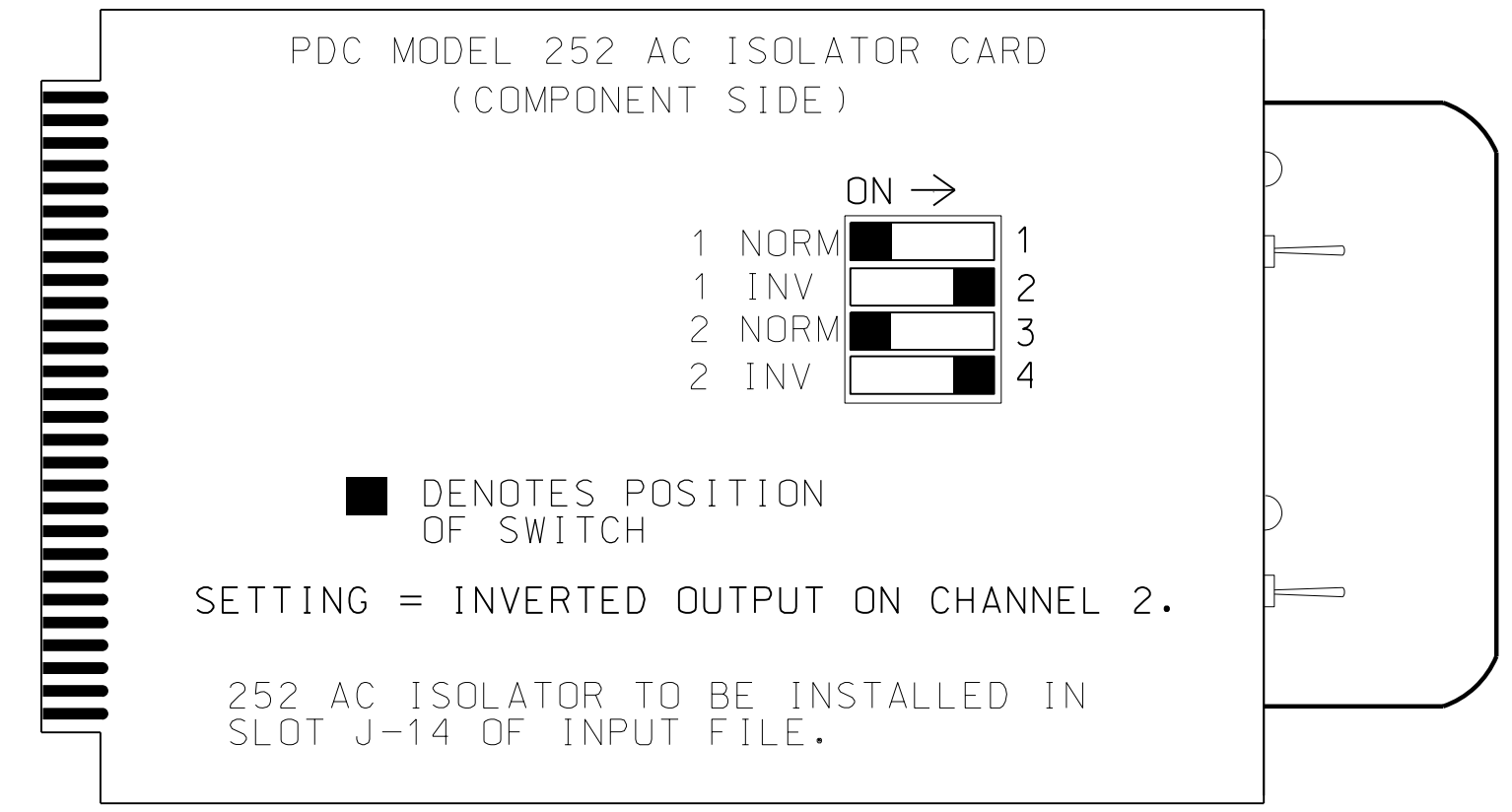

252 AC ISOLATOR TO BE INSTALLED IN SLOT J-14 OF INPUT FILE.

NOTE: IF ANOTHER MANUFACTURER TYPE OF AC ISOLATOR IS USED, OUTPUT PROGRAMMING IS LIKELY NOT TO EQUATE TO THAT SHOWN ABOVE.

LOAD RESISTOR INSTALLATION DETAIL

(install resistor as shown)

ACCEPTABLE VALUES	
VALUE (ohms)	WATTAGE
1.5K - 1.9K	25W (min)
2.0K - 3.0K	10W (min)

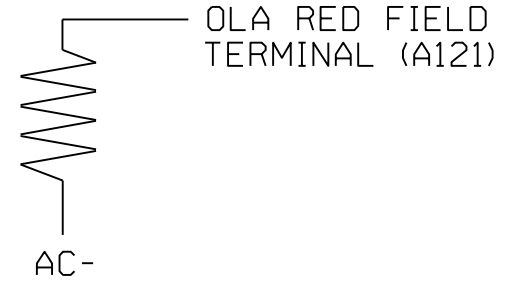

Temporary Design 1 - TMP Phase I Electrical Detail - Sheet 1 of 5

US 401 Business (Raeford Road) at McPherson Church Road/ Owen Drive
 Division 6 Cumberland County Fayetteville
 PLAN DATE: March 2018 REVIEWED BY: L Overn
 PREPARED BY: G B Spell REVIEWED BY:

SEAL
 NORTH CAROLINA PROFESSIONAL ENGINEER
 LAWRENCE E. OVERN
 3/29/2018
 DATE
 SIG. INVENTORY NO. 06-0054T1

RAILROAD PREEMPTION WIRING DETAIL FOR RR1 (LINKED RR PREEMPTS 1 & 2)

(wire as shown below)

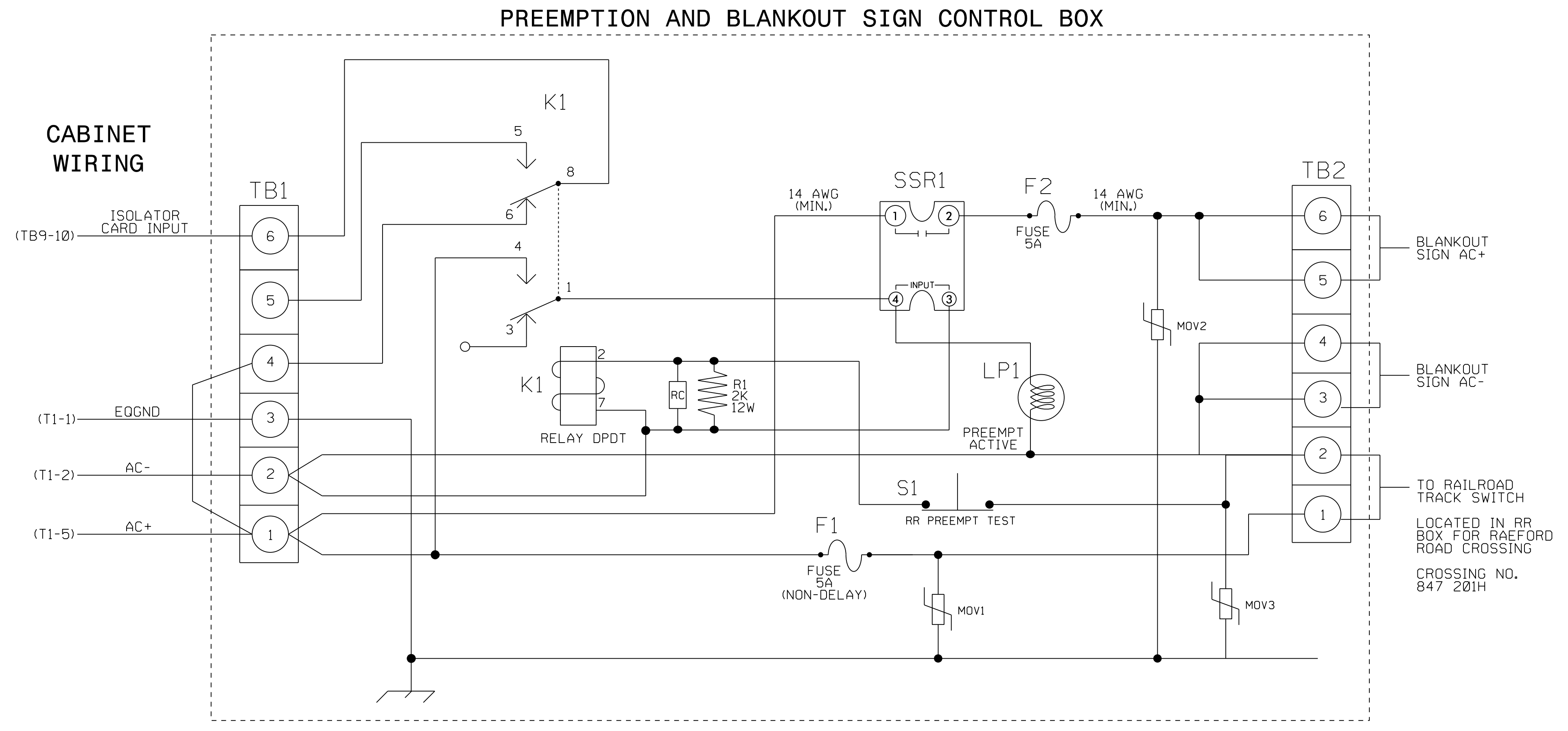

NOTES

1. Relay K1 is shown in the energized (Preempt not active) normal operation state.
2. Relay K1 is a DPDT with 120VAC coil with octal base.
3. Relay SSR1 is a SPST (normally open) Solid State Relay with AC input and AC (25 amp) output.
4. AC Isolator Card shall activate preemption upon removal of AC+ from the input (as shown above). To accomplish this set invert dip switch on AC Isolator card. See AC Isolator Output Programming Detail on Sheet 1.
5. IMPORTANT! A jumper must be added between input file terminals J4-E and J4-K if not already present. Also, terminal TB9-12 (on input panel) shall be connected to AC neutral (jumper may have to be added).

FRONT VIEW

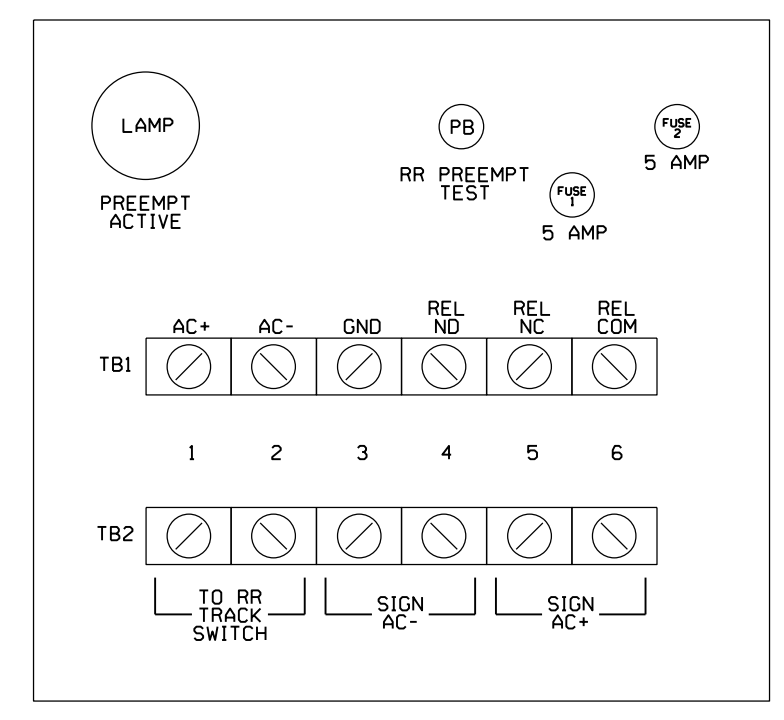

THIS ELECTRICAL DETAIL IS FOR
THE SIGNAL DESIGN: 06-0054T1
DESIGNED: March 2018
SEALED: 03-29-2018
REVISED: N/A

Temporary Design 1 - TMP Phase I
Electrical Detail - Sheet 2 of 5

Stantec Consulting Services Inc.
801 Jones Franklin Road-Suite 300
Raleigh, NC 27606
Tel. (919) 851-6866
Fax. (919) 851-7024
www.stantec.com
License No. F-0672

ELECTRICAL AND PROGRAMMING
DETAILS FOR:

Prepared in the Offices of:

750 N. Greenfield Pkwy, Garner, NC 27529

US 401 Business (Raeford Road)
at
McPherson Church Road/
Owen Drive

Division 6 Cumberland County Fayetteville

PLAN DATE: March 2018	REVIEWED BY: L Overn
PREPARED BY: G B Spell	REVIEWED BY:

REVISIONS	INIT.	DATE

SEAL

3/29/2018

DATE

SIG. INVENTORY NO. 06-0054T1

DATE: 03/29/2018 10:45:11 AM User: rmluncey

RAILROAD PREEMPTION WIRING DETAIL FOR RR2 (LINKED RR PREEMPTS 3 & 4)

(wire as shown below)

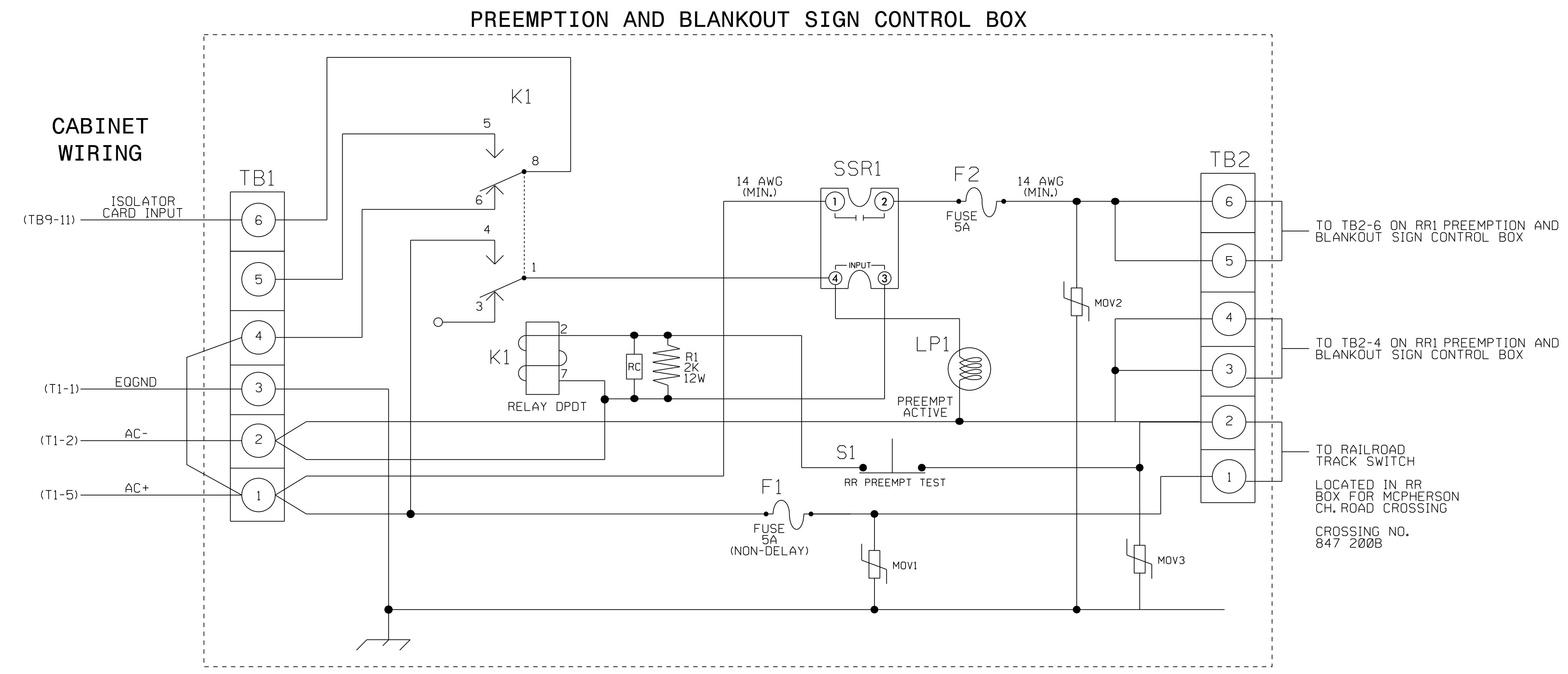

NOTES

1. Relay K1 is shown in the energized (Preempt not active) normal operation state.
2. Relay K1 is a DPDT with 120VAC coil with octabase.
3. Relay SSR1 is a SPST (normally open) Solid State Relay with AC input and AC (25 amp) output.
4. AC Isolator Card shall activate preemption upon removal of AC+ from the input (as shown above). To accomplish this set invert dip switch on AC Isolator Card. See AC Isolator Output Programming Detail on Sheet 1.

FRONT VIEW

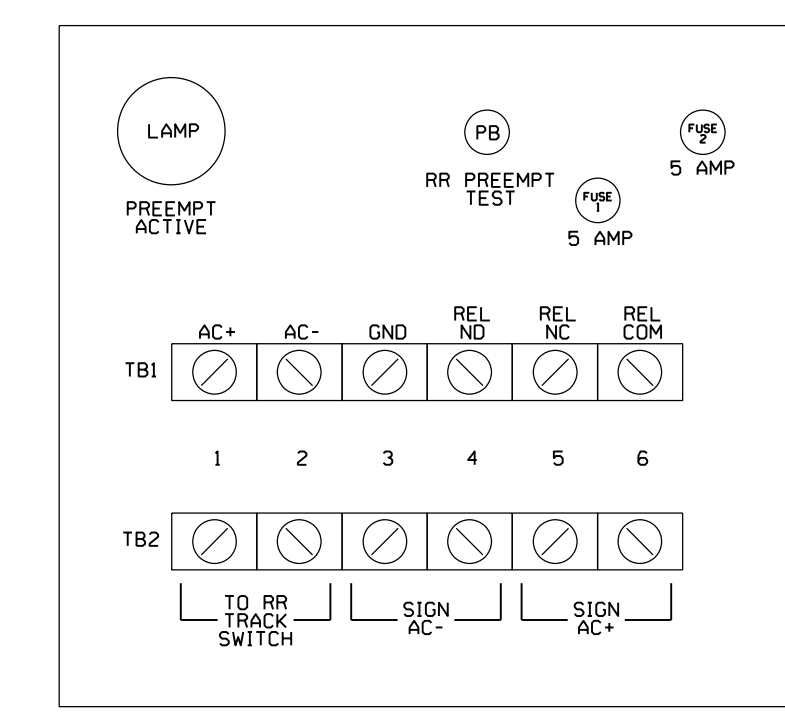

THIS ELECTRICAL DETAIL IS FOR THE SIGNAL DESIGN: 06-0054T1
DESIGNED: March 2018
SEALED: 03-29-2018
REVISED: N/A

Temporary Design 1 - TMP Phase I
Electrical Detail - Sheet 3 of 5

Stantec Consulting Services Inc.
801 Jones Franklin Road-Suite 300
Raleigh, NC 27606
Tel. (919) 851-6866
Fax. (919) 851-7024
www.stantec.com
License No. F-0672

Prepared in the Offices of:

750 N. Greenfield Pkwy, Garner, NC 27529

US 401 Business (Raeford Road)
at
McPherson Church Road/
Owen Drive
Division 6 Cumberland County Fayetteville

PLAN DATE: March 2018	REVIEWED BY: L Overn
PREPARED BY: G B Spell	REVIEWED BY:

REVISIONS	INIT.	DATE

SEAL
NORTH CAROLINA
PROFESSIONAL
ENGINEER
LAWRENCE E. OVERN
045933
3/29/2018
DATE
SIG. INVENTORY NO. 06-0054T1

DATE: 03/29/2018 11:00:00 AM User: rfmancey

ECONOLITE ASC/3-2070 RAILROAD PREEMPT PROGRAMMING DETAIL

(program controller as shown)

- From Main Menu select **4. PREEMPTOR/TSP**
- From PREEMPTOR/TSP/SCP Submenu select **1. PREEMPT PLAN 1-10**

Place cursor in [] next to Preempt Plan and press 1. Then press the right cursor arrow and toggle the controller to YES. Next cursor down. This will select Railroad Preempt #1.

Place cursor in [] next to Preempt Plan and press 2. Then press the right cursor arrow and toggle the controller to YES. Next cursor down. This will select Railroad Preempt #2.

Place cursor in [] next to Preempt Plan and press 3. Then press the right cursor arrow and toggle the controller to YES. Next cursor down. This will select Railroad Preempt #3.

Place cursor in [] next to Preempt Plan and press 4. Then press the right cursor arrow and toggle the controller to YES. Next cursor down. This will select Railroad Preempt #4.

```

PREEMPT PLAN [ 1]  ENABLE....YES
VEH/PED 1 2 3 4 5 6 7 8 9 0 1 2 3 4 5 6
OVERLAP A B C D E F G H I J K L M N O P
TRKCLR V . . . X . . X . . . . . . . . . .
TRKCLR O . . . . . . . . . . . . . . . . .
ENA TRL . . . . . . . . . . . . . . . . .
DWEL VEH . . X . . . . . . . . . . . . . .
DWEL PED . . . . . . . . . . . . . . . . .
DWEL OLP . . . . . . . . . . . . . . . . .
CYC VEH . . . . . . . . . . . . . . . . .
CYC PED . . . . . . . . . . . . . . . . .
CYC OLP . . . . . . . . . . . . . . . . .
EXIT PH . . . X . . . X . . . . . . . . . .
EXIT CAL . . . . . . . . . . . . . . . . .
SP FUNC . . . . . . . . . . . . . . . . .

ENABLE... YESIPMT OVRIDE..IINTERLOCK. NO
DET LOCK... .IDELAY.. 0IINHIBIT... 0
OVERRIDE FL. .IDURATION 0ICLR-GRN... NO
TERM OLP. NOIPC>YEL NOITERM PH NO
PED DARK.. NOITC RESRV YESIDWELL FL OFF
LINK PMT...0IX FLCOLR REDIEXIT OPT. OFF
X TMG PLN...OIRE-SERV.. 0IFLT TYPE.HARD
FREE DUR PMTIR1 NOIR2 NOIR3 NOIR4 NO
--TIMING-----WALKIPED CLIMN GRI YELI RED
ENTRANCE TM. 255I 255I 1125.5125.5
-----MIN GRIEXT GRIMX GRI YELI RED
TRACK CLEAR 21I 0I 0I 4.6I 1.7
-----MIN DLIPMTEXTIMX TMI YELI RED
DWL/CYC-EXIT 7I 0.0I 0I25.5I25.5
PMT ACTIVE OUT..ON PMT ACT DWELL...NO
OTHER - PRI PMT.OFF NON-PRI PMT....OFF
INH EXT TIME... 0.0 PED PR RETURN...OFF
PRIORITY RETURN.OFF QUEUE DELAY.... OFF
COND DELAY.....OFF
PHASES 1 2 3 4 5 6 7 8
PR RTN% 0 0 0 0 0 0 0 0
PHASES 9 10 11 12 13 14 15 16
PR RTN% 0 0 0 0 0 0 0 0

```

```

PREEMPT PLAN [ 2]  ENABLE....YES
VEH/PED 1 2 3 4 5 6 7 8 9 0 1 2 3 4 5 6
OVERLAP A B C D E F G H I J K L M N O P
TRKCLR V X . . . . . X . . . . . . . . . .
TRKCLR O . . . . . . . . . . . . . . . . .
ENA TRL . . . . . . . . . . . . . . . . .
DWEL VEH . . X . . . . . . . . . . . . . .
DWEL PED . . . . . . . . . . . . . . . . .
DWEL OLP . . . . . . . . . . . . . . . . .
CYC VEH . . . . . . . . . . . . . . . . .
CYC PED . . . . . . . . . . . . . . . . .
CYC OLP . . . . . . . . . . . . . . . . .
EXIT PH . . . X . . . X . . . . . . . . . .
EXIT CAL . . . . . . . . . . . . . . . . .
SP FUNC . . . . . . . . . . . . . . . . .

ENABLE... YESIPMT OVRIDE..IINTERLOCK. NO
DET LOCK... .IDELAY.. 0IINHIBIT... 0
OVERRIDE FL. .IDURATION 0ICLR-GRN... NO
TERM OLP. NOIPC>YEL NOITERM PH NO
PED DARK.. NOITC RESRV YESIDWELL FL OFF
LINK PMT...1IX FLCOLR REDIEXIT OPT. OFF
X TMG PLN...OIRE-SERV.. 0IFLT TYPE.HARD
FREE DUR PMTIR1 NOIR2 NOIR3 NOIR4 NO
--TIMING-----WALKIPED CLIMN GRI YELI RED
ENTRANCE TM. 255I 255I 1125.5125.5
-----MIN GRIEXT GRIMX GRI YELI RED
TRACK CLEAR 35I 0I 0I 3.8I 2.1
-----MIN DLIPMTEXTIMX TMI YELI RED
DWL/CYC-EXIT 0I 0.0I 0I25.5I25.5
PMT ACTIVE OUT..ON PMT ACT DWELL...NO
OTHER - PRI PMT.OFF NON-PRI PMT....OFF
INH EXT TIME... 0.0 PED PR RETURN...OFF
PRIORITY RETURN.OFF QUEUE DELAY.... OFF
COND DELAY.....OFF
PHASES 1 2 3 4 5 6 7 8
PR RTN% 0 0 0 0 0 0 0 0
PHASES 9 10 11 12 13 14 15 16
PR RTN% 0 0 0 0 0 0 0 0

```

```

PREEMPT PLAN [ 3]  ENABLE....YES
VEH/PED 1 2 3 4 5 6 7 8 9 0 1 2 3 4 5 6
OVERLAP A B C D E F G H I J K L M N O P
TRKCLR V X . . . . . X . . . . . . . . . .
TRKCLR O . . . . . . . . . . . . . . . . .
ENA TRL . . . . . . . . . . . . . . . . .
DWEL VEH . . X . . . . . . . . . . . . . .
DWEL PED . . . . . . . . . . . . . . . . .
DWEL OLP . . . . . . . . . . . . . . . . .
CYC VEH . . . . . . . . . . . . . . . . .
CYC PED . . . . . . . . . . . . . . . . .
CYC OLP . . . . . . . . . . . . . . . . .
EXIT PH . . . X . . . X . . . . . . . . . .
EXIT CAL . . . . . . . . . . . . . . . . .
SP FUNC . . . . . . . . . . . . . . . . .

ENABLE... YESIPMT OVRIDE..IINTERLOCK. NO
DET LOCK... .IDELAY.. 0IINHIBIT... 0
OVERRIDE FL. .IDURATION 0ICLR-GRN... NO
TERM OLP. NOIPC>YEL NOITERM PH NO
PED DARK.. NOITC RESRV YESIDWELL FL OFF
LINK PMT...0IX FLCOLR REDIEXIT OPT. OFF
X TMG PLN...OIRE-SERV.. 0IFLT TYPE.HARD
FREE DUR PMTIR1 NOIR2 NOIR3 NOIR4 NO
--TIMING-----WALKIPED CLIMN GRI YELI RED
ENTRANCE TM. 255I 255I 1125.5125.5
-----MIN GRIEXT GRIMX GRI YELI RED
TRACK CLEAR 35I 0I 0I 3.8I 2.1
-----MIN DLIPMTEXTIMX TMI YELI RED
DWL/CYC-EXIT 7I 0.0I 0I25.5I25.5
PMT ACTIVE OUT..ON PMT ACT DWELL...NO
OTHER - PRI PMT.OFF NON-PRI PMT....OFF
INH EXT TIME... 0.0 PED PR RETURN...OFF
PRIORITY RETURN.OFF QUEUE DELAY.... OFF
COND DELAY.....OFF
PHASES 1 2 3 4 5 6 7 8
PR RTN% 0 0 0 0 0 0 0 0
PHASES 9 10 11 12 13 14 15 16
PR RTN% 0 0 0 0 0 0 0 0

```

```

PREEMPT PLAN [ 4]  ENABLE....YES
VEH/PED 1 2 3 4 5 6 7 8 9 0 1 2 3 4 5 6
OVERLAP A B C D E F G H I J K L M N O P
TRKCLR V . . . X . . X . . . . . . . . . .
TRKCLR O . . . . . . . . . . . . . . . . .
ENA TRL . . . . . . . . . . . . . . . . .
DWEL VEH . . X . . . . . . . . . . . . . .
DWEL PED . . . . . . . . . . . . . . . . .
DWEL OLP . . . . . . . . . . . . . . . . .
CYC VEH . . . . . . . . . . . . . . . . .
CYC PED . . . . . . . . . . . . . . . . .
CYC OLP . . . . . . . . . . . . . . . . .
EXIT PH . . . X . . . X . . . . . . . . . .
EXIT CAL . . . . . . . . . . . . . . . . .
SP FUNC . . . . . . . . . . . . . . . . .

ENABLE... YESIPMT OVRIDE..IINTERLOCK. NO
DET LOCK... .IDELAY.. 0IINHIBIT... 0
OVERRIDE FL. .IDURATION 0ICLR-GRN... NO
TERM OLP. NOIPC>YEL NOITERM PH NO
PED DARK.. NOITC RESRV YESIDWELL FL OFF
LINK PMT...3IX FLCOLR REDIEXIT OPT. OFF
X TMG PLN...OIRE-SERV.. 0IFLT TYPE.HARD
FREE DUR PMTIR1 NOIR2 NOIR3 NOIR4 NO
--TIMING-----WALKIPED CLIMN GRI YELI RED
ENTRANCE TM. 255I 255I 1125.5125.5
-----MIN GRIEXT GRIMX GRI YELI RED
TRACK CLEAR 21I 0I 0I 4.6I 1.7
-----MIN DLIPMTEXTIMX TMI YELI RED
DWL/CYC-EXIT 0I 0.0I 0I25.5I25.5
PMT ACTIVE OUT..ON PMT ACT DWELL...NO
OTHER - PRI PMT.OFF NON-PRI PMT....OFF
INH EXT TIME... 0.0 PED PR RETURN...OFF
PRIORITY RETURN.OFF QUEUE DELAY.... OFF
COND DELAY.....OFF
PHASES 1 2 3 4 5 6 7 8
PR RTN% 0 0 0 0 0 0 0 0
PHASES 9 10 11 12 13 14 15 16
PR RTN% 0 0 0 0 0 0 0 0

```

NOTICE LINK PMT 1 →

NOTICE LINK PMT 3 →

Linked preempts 1 and 2 make up preempt RR1

Linked preempts 3 and 4 make up preempt RR2

Temporary Design 1 - TMP Phase I
Electrical Detail - Sheet 4 of 5

DOCUMENT NOT CONSIDERED FINAL
UNLESS ALL SIGNATURES COMPLETED

ECONOLITE ASC/3-2070 PREEMPT FILTERING

- From Main Menu select **4. PREEMPTOR/TSP**
- From PREEMPTOR/TSP/SCP Submenu select **2. ENABLE PREEMPT FILTERING & TSP/SCP**
- Ensure all preempt entries are set to BYPASSED for both SOLID and PULSING.

THIS ELECTRICAL DETAIL IS FOR THE SIGNAL DESIGN: 06-0054T1
DESIGNED: March 2018
SEALED: 03-29-2018
REVISED: N/A



Stantec Consulting Services Inc.
801 Jones Franklin Road-Suite 300
Raleigh, NC 27606
Tel. (919) 851-6866
Fax. (919) 851-7024
www.stantec.com
License No. F-0672

ELECTRICAL AND PROGRAMMING DETAILS FOR:

Prepared in the Offices of:

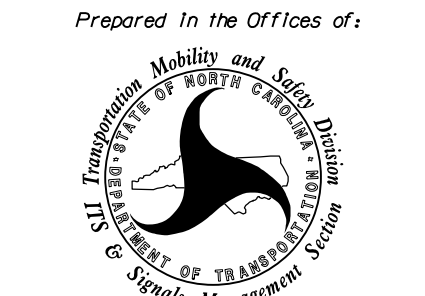

750 N. Greenfield Pkwy, Garner, NC 27529

US 401 Business (Raeford Road)
at
McPherson Church Road/
Owen Drive
Division 6 Cumberland County Fayetteville

PLAN DATE: March 2018 REVIEWED BY: L Overn
PREPARED BY: G B Spell REVIEWED BY:

REVISIONS	INIT.	DATE

SEAL

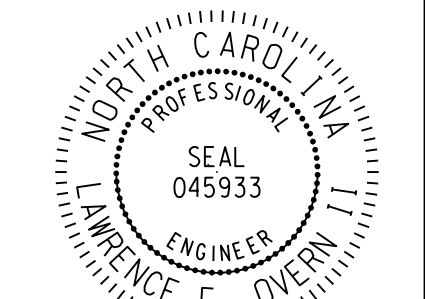

3/29/2018
DATE
SIG. INVENTORY NO. 06-0054T1

DATE: 03/29/2018 10:40:11 AM
User: rfmancey

ECONOLITE ASC/3-2070 LOGIC PROCESSOR PROGRAMMING DETAIL

(program controller as shown)

- From Main Menu select **1. CONFIGURATION**
- From CONFIGURATION Submenu select **8. LOGIC PROCESSOR**
- From LOGIC PROCESSOR Submenu select **2. LOGIC STATEMENTS**

ENTER A "1" IN THE LP# FIELD, PRESS 'ENTER', AND PROGRAM AS SHOWN.

```

LP#: 1 COPY FROM: 1 ACTIVE: M
IF DET 52 IS ON

THEN LP SET LOGIC FLAG 1 ON

ELSE

```

IF RR1 PREEMPT (REMAPPED AS DET 52) INPUT IS ACTIVE, SET LOGIC FLAG 1 ON.

ENTER A "2" IN THE LP# FIELD, PRESS 'ENTER', AND PROGRAM AS SHOWN.

```

LP#: 2 COPY FROM: 2 ACTIVE: M
IF LP FLAG 1 IS ON

THEN PMT CALL PMT SEQ 2 ON

ELSE

```

IF LOGIC FLAG 1 IS ON, THEN INITIATE PREEMPT 2 SEQUENCE. THE PREEMPT MAY OR MAY NOT ACTUALLY BE SERVED DEPENDING ON THE STATE OF THE OTHER RR PREEMPT INPUT.

ENTER A "3" IN THE LP# FIELD, PRESS 'ENTER', AND PROGRAM AS SHOWN.

```

LP#: 3 COPY FROM: 3 ACTIVE: M
IF DET 54 IS ON

THEN LP SET LOGIC FLAG 2 ON

ELSE

```

IF RR2 PREEMPT (REMAPPED AS DET 54) INPUT IS ACTIVE, SET LOGIC FLAG 2 ON.

ENTER A "4" IN THE LP# FIELD, PRESS 'ENTER', AND PROGRAM AS SHOWN.

```

LP#: 4 COPY FROM: 4 ACTIVE: M
IF LP FLAG 2 IS ON

THEN PMT CALL PMT SEQ 4 ON

ELSE

```

IF LOGIC FLAG 2 IS ON, THEN INITIATE PREEMPT 4 SEQUENCE. THE PREEMPT MAY OR MAY NOT ACTUALLY BE SERVED DEPENDING ON THE STATE OF THE OTHER RR PREEMPT INPUT.

ENTER A "5" IN THE LP# FIELD, PRESS 'ENTER', AND PROGRAM AS SHOWN.

```

LP#: 5 COPY FROM: 5 ACTIVE: M
IF DET 52 IS OFF
AND DET 54 IS OFF

THEN LP SET LOGIC FLAG 1 OFF
THEN LP SET LOGIC FLAG 2 OFF

ELSE

```

WHEN BOTH PREEMPT INPUTS GO INACTIVE, THIS LOGIC RESETS THE LOGIC FLAG THAT IS HOLDING THE ACTIVE PREEMPT ACTIVE, AND RESETS THE OTHER LOGIC FLAG TO PREVENT IT FROM CALLING THE OTHER PREEMPT.

END PROGRAMMING

- From Main Menu select **1. CONFIGURATION**
- From CONFIGURATION Submenu select **8. LOGIC PROCESSOR**
- From LOGIC PROCESSOR Submenu select **1. LOGIC STATEMENT CONTROL**

ENABLE LOGIC PROCESSOR STATEMENTS 1-5 BY POSITIONING THE CURSOR OVER THE FIELDS SHOWN BELOW AND USING THE TOGGLE KEY TO ENABLE THEM.

LOGIC STATEMENT CONTROL	
	1 2 3 4 5 6 7 8 9 0 1 2 3 4 5
LP 1-15	E E E E E
LP 16-30
LP 31-45
LP 46-60
LP 61-75
LP 76-90

END PROGRAMMING

ECONOLITE ASC/3-2070 I/O PIN REMAPPING FOR RR1 AND RR2 PREEMPT INPUTS

The ASC/3 Configurator utility program must be used to remap the I/O pins as shown below. Consult the ASC/3 Configurator User Guide for specific instructions on software use.

- Run the Configurator utility. Load a file as the Current DB.
- Choose the C1-in tab to change the I/O mapping as needed. Use the drop down list within the program to select the assigned function for the pins shown below.
- Save the database file and download it to the controller.

C1	DEFAULT	ASSIGNED FUNCTION
PIN #	FUNCTION	

PIN 51-PREEMPT 1 CALL →

PIN 52-PREEMPT 2 CALL →

NOTE: PREEMPT INPUTS REMAPPED AS DETECTORS

NOTE: The steps below can be used to view changes to I/O pins within the controller. Any I/O pins that have been remapped will display and show their default function in addition to the current assigned function.

- From Main Menu select **7. STATUS DISPLAY**
- From STATUS DISPLAY Submenu select **8. INPUTS/OUTPUTS**
- From INPUT/OUTPUT Submenu select **9. I/O DIFFERENCES**

ECONOLITE ASC/3-2070 VEHICLE DETECTOR SETUP PROGRAMMING DETAIL FOR REMAPPED DETECTORS

(program controller as shown)

The preempt inputs remapped as detectors that are to be used by the logic processor are assigned to a dummy phase 9 as shown in the detector setup programming below.

- From Main Menu select **6. DETECTORS**
- From DETECTOR Submenu select **2. VEHICLE DETECTOR SETUP**

- Place cursor in VEH DETECTOR [] position and enter "52".

```

VEH DETECTOR [52] VEH DET PLAN [ 1]
TYPE: S-STANDARD
TS2 DETECTOR..... ECPI LOG..... NO
DET PH - 1 2 3 4 5 6 7 8 9 0 1 2 3 4 5 6
52 9 . . . . .
EXTEND TIME... 0.0 DELAY TIME... 0.0
USE ADDED INITIAL . CROSS SWITCH PH.. 0
LOCK IN..... NONE NTCIP VOL . OR OCC .
PMT QUEUE DELAY. NO

```

DISABLE TS2 DETECTOR →
ASSIGN PHASE 9 →

- Place cursor in VEH DETECTOR [] position and enter "54".

```

VEH DETECTOR [54] VEH DET PLAN [ 1]
TYPE: S-STANDARD
TS2 DETECTOR..... ECPI LOG..... NO
DET PH - 1 2 3 4 5 6 7 8 9 0 1 2 3 4 5 6
54 9 . . . . .
EXTEND TIME... 0.0 DELAY TIME... 0.0
USE ADDED INITIAL . CROSS SWITCH PH.. 0
LOCK IN..... NONE NTCIP VOL . OR OCC .
PMT QUEUE DELAY. NO

```

DISABLE TS2 DETECTOR →
ASSIGN PHASE 9 →

END PROGRAMMING

THIS ELECTRICAL DETAIL IS FOR THE SIGNAL DESIGN: 06-0054T1
DESIGNED: March 2018
SEALED: 03-29-2018
REVISED: N/A

Temporary Design 1 - TMP Phase I
Electrical Detail - Sheet 5 of 5

Stantec Consulting Services Inc.
801 Jones Franklin Road-Suite 300
Raleigh, NC 27606
Tel. (919) 851-6866
Fax. (919) 851-7024
www.stantec.com
License No. F-0672

ELECTRICAL AND PROGRAMMING DETAILS FOR:

Prepared in the Offices of:

750 N. Greenfield Pkwy, Garner, NC 27529

US 401 Business (Raeford Road)
at
McPherson Church Road/
Owen Drive
Division 6 Cumberland County Fayetteville

PLAN DATE: March 2018 REVIEWED BY: L Overn
PREPARED BY: G B Spell REVIEWED BY:

REVISIONS	INIT.	DATE

SEAL

3/29/2018
DATE

SIG. INVENTORY NO. 06-0054T1

DATE: U:\Projects\Signal\Signal\Temp\Phase 1\U-4405-sig.ele_06-0054T1.dgn User: rmlunicy

DOCUMENT NOT CONSIDERED FINAL UNLESS ALL SIGNATURES COMPLETED

PHASING DIAGRAM

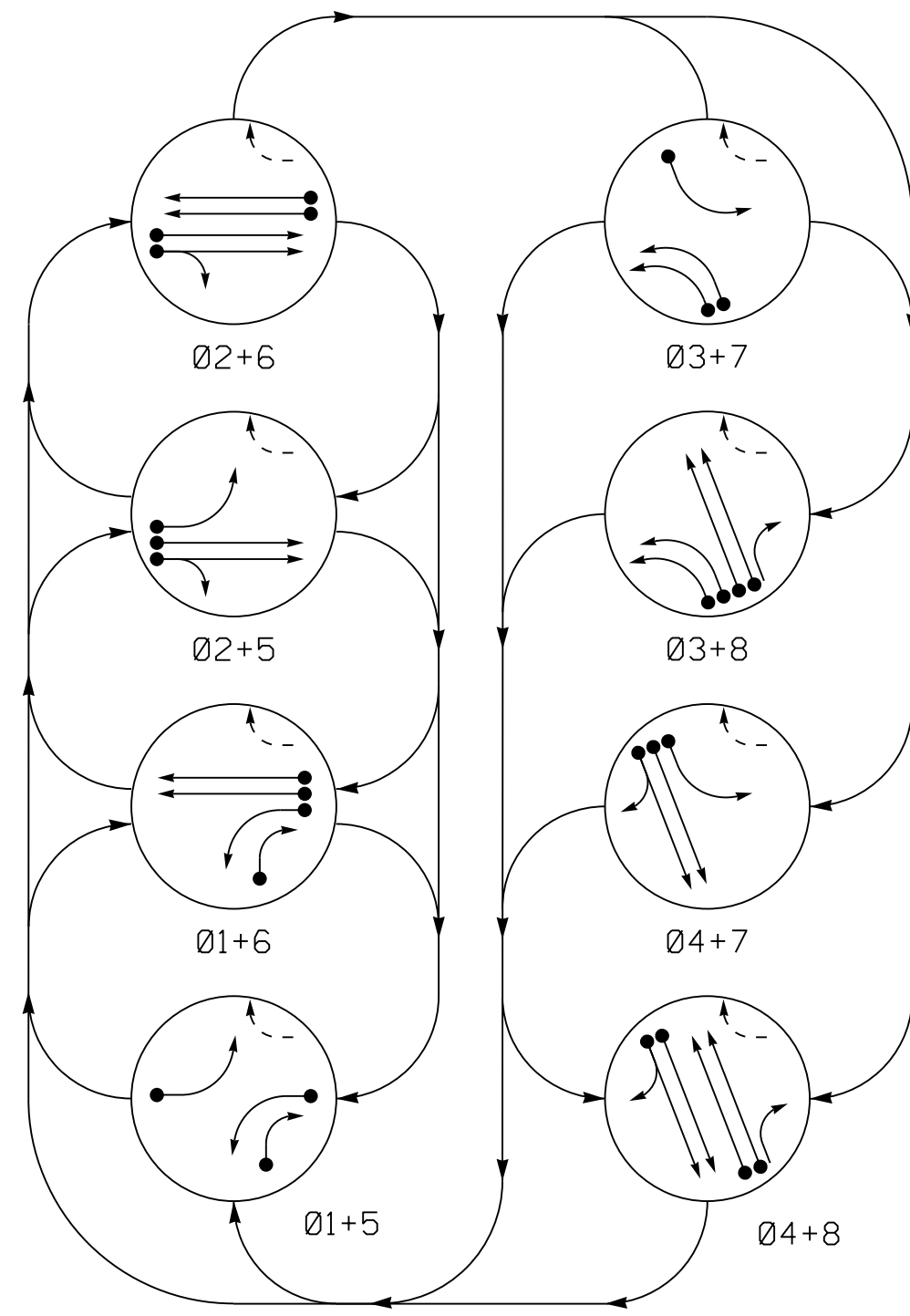

RAIL PREEMPT PHASES (High Priority)

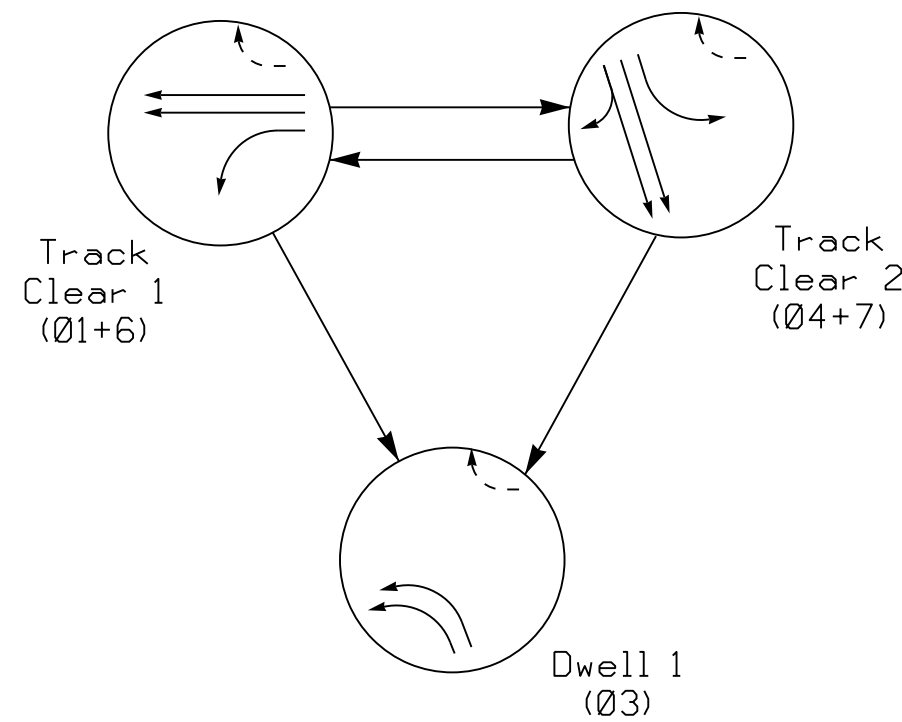

PHASING DIAGRAM DETECTION LEGEND

- DETECTED MOVEMENT
- UNDETECTED MOVEMENT (OVERLAP)
- - - UNSIGNALIZED MOVEMENT
- ◀ - - - PEDESTRIAN MOVEMENT

SIGNAL FACE	PHASE											
	01+5	01+6	02+5	02+6	03+7	03+8	04+7	04+8	01	02	03	04
11	←	←	←	←	←	←	←	←	←	←	←	←
21,22	R	R	G	G	R	R	R	R	R	R	R	Y
31,32	←	←	←	←	←	←	←	←	←	←	←	←
41,42	R	R	R	R	R	R	G	G	R	G	R	R
51	←	←	←	←	←	←	←	←	←	←	←	←
61,62	R	G	R	G	R	R	R	R	G	R	R	Y
71	←	←	←	←	←	←	←	←	←	←	←	←
81	R	R	R	R	R	G	R	G	R	R	R	R
82	←	←	←	←	←	←	←	←	←	←	←	←
Sign (A)	OFF	OFF	OFF	OFF	OFF	OFF	OFF	OFF	ON	ON	ON	*

* See Note 7

ASC/3 DETECTOR INSTALLATION CHART											
DETECTOR				PROGRAMMING							
LOOP	SIZE (FT)	DISTANCE FROM STOPBAR (FT)	TURNS	NEW LOOP	PHASE	CALLING	EXTEND TIME	DELAY TIME	USE ADDED INITIAL	TYPE	LOOP
1A	6X40	0	*	-	1	Yes	-	3	-	S	-
1B	6X40	0	*	-	1	Yes	-	15	-	S	-
2A	6X6	70	*	-	2	Yes	-	-	-	S	-
2B	6X6	70	*	-	2	Yes	-	-	-	S	-
3A	6X40	0	*	-	3	Yes	-	3	-	S	-
3B	6X40	0	*	-	3	Yes	-	-	-	S	-
4A	6X40	0	*	-	4	Yes	-	-	-	S	-
4B	6X40	0	*	-	4	Yes	-	10	-	S	-
4C	6X15	0	*	-	4	Yes	-	15	-	S	-
5A	6X40	0	*	-	5	Yes	-	3	-	S	-
6A	6X6	70	*	-	6	Yes	-	-	-	S	-
6B	6X6	70	*	-	6	Yes	-	-	-	S	-
7A	6X40	0	*	-	7	Yes	-	3	-	S	-
8A	6X40	0	*	-	8	Yes	-	-	-	S	-
8B	6X40	0	*	-	8	Yes	-	-	-	S	-

* Video Detection Area. Camera locations should be confirmed in the filed by the contractor in order to provide detection of the areas indicated.

ASC/3 RR PREEMPT		
FUNCTION	SEQUENCE 1	SEQUENCE 2
Exit Phase(s)	4,8	4,8
Preempt Override	OFF	OFF
Delay Time	0	0
Ped Clear Trough Yellow	N	N
Terminate Phases	N	N
Track Clear Reserve	Y	Y
Entrance Walk	255*	255*
Entrance Ped Clear	255*	255*
Entrance Min Green	1	1
Entrance Yellow Change	25.5*	25.5*
Entrance Red Clear	25.5*	25.5*
Track Clear Min Green 1	35	21
Track Clear Yellow Change 1	3.8	4.6
Track Clear Red Clear 1	2.1	1.7
Track Clear Min Green 2	21	35
Track Clear Yellow Change 2	4.6	3.8
Track Clear Red Clear 2	1.7	2.1
Min Dwell Time	7	7
Exit Yellow Change	25.5*	25.5*
Exit Red Clear	25.5*	25.5*

* Time defaults to time used for phase during normal operation.

SIGNAL FACE I.D.

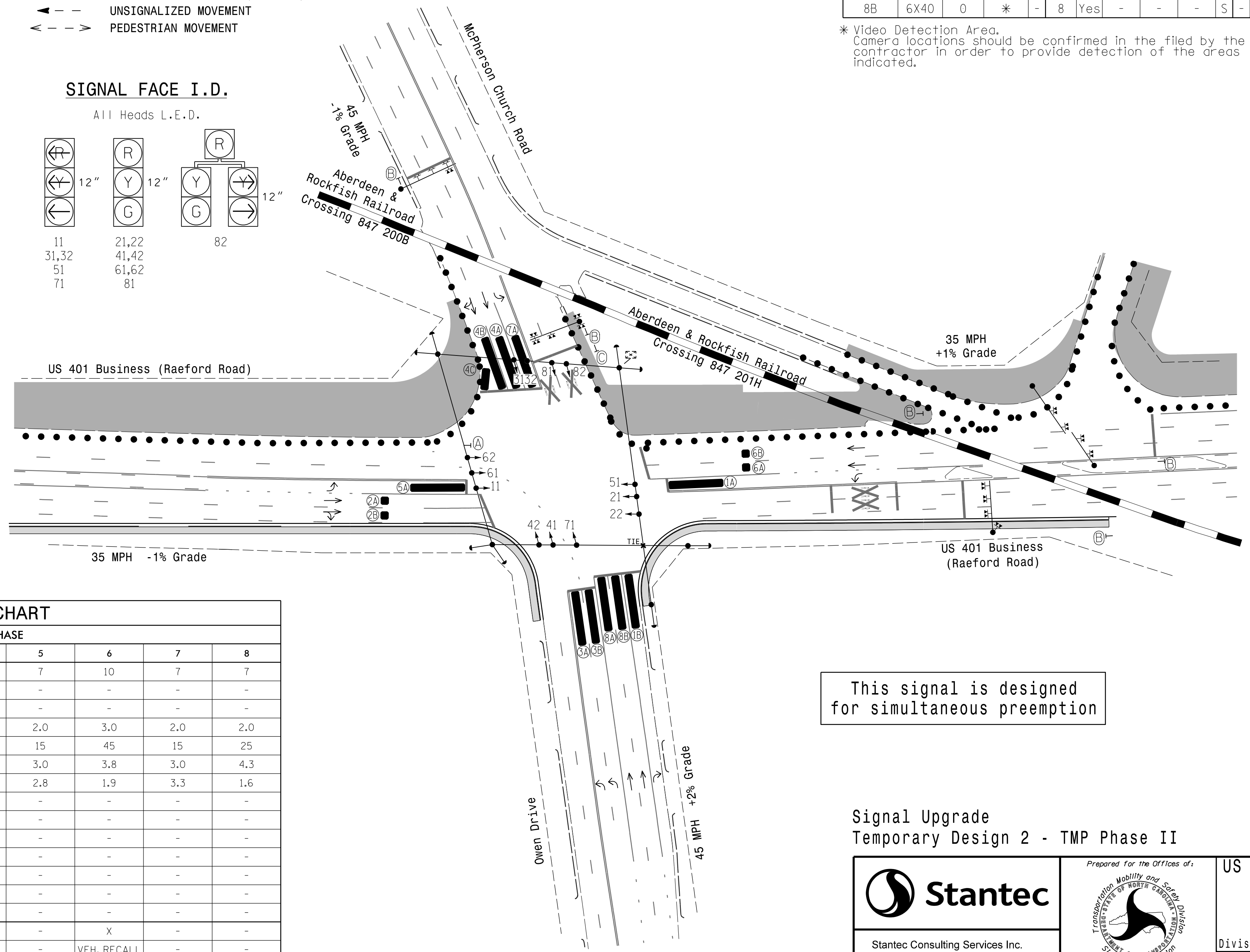
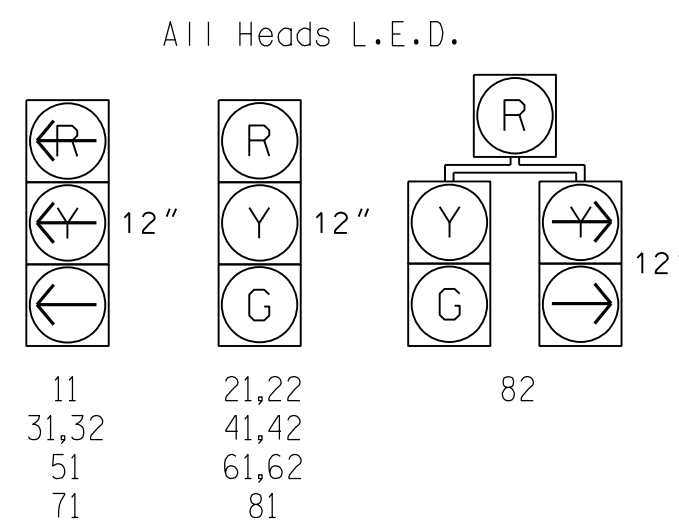

This signal is designed for simultaneous preemption

LEGEND

- | PROPOSED | EXISTING |
|----------------------------------------------------|-----------|
| ○ → Traffic Signal Head | ● → N/A |
| ○ → Modified Signal Head | ○ → N/A |
| ○ → Pedestrian Signal Head With Push Button & Sign | ○ → N/A |
| ○ → Signal Pole with Guy | ○ → N/A |
| ○ → Signal Pole with Sidewalk Guy | ○ → N/A |
| □ → Inductive Loop Detector | □ → N/A |
| □ → Controller & Cabinet | □ → N/A |
| □ → Junction Box | □ → N/A |
| --- 2-in Underground Conduit | --- N/A |
| N/A → Right of Way | --- N/A |
| N/A → Directional Arrow | → N/A |
| N/A → Railroad Cantilever | --- N/A |
| N/A → Railroad Tracks | --- N/A |
| ■ → Video Detection Area | ■ → N/A |
| ■ → Construction Zone | ■ → N/A |
| ● → Construction Zone Drums | ● → N/A |
| (A) → "NO RIGHT TURN - TRAIN" L.E.D. Blankout Sign | (A) → N/A |
| (B) → "DO NOT STOP ON TRACKS" Sign (R8-B) | (B) → N/A |
| (C) → "Stop Here on Red" Sign (R10-6) | (C) → N/A |

ASC/3 TIMING CHART

FEATURE	PHASE							
	1	2	3	4	5	6	7	8
Min Green *	7	10	7	7	7	10	7	7
Walk *	-	-	-	-	-	-	-	-
Ped Clear	-	-	-	-	-	-	-	-
Veh. Extension *	2.0	3.0	2.0	2.0	2.0	3.0	2.0	2.0
Max 1 *	15	45	15	25	15	45	15	25
Yellow	3.0	3.9	3.0	4.6	3.0	3.8	3.0	4.3
Red Clear	2.9	2.1	3.3	1.6	2.8	1.9	3.3	1.6
Red Revert	-	-	-	-	-	-	-	-
Actuations B4 Add *	-	-	-	-	-	-	-	-
Seconds /Actuation *	-	-	-	-	-	-	-	-
Max Initial *	-	-	-	-	-	-	-	-
Time Before Reduction *	-	-	-	-	-	-	-	-
Time To Reduce *	-	-	-	-	-	-	-	-
Minimum Gap	-	-	-	-	-	-	-	-
Locking Detector	-	X	-	-	-	X	-	-
Recall Position	-	VEH. RECALL	-	-	-	VEH. RECALL	-	-
Dual Entry	-	-	-	-	-	-	-	-
Simultaneous Gap	X	X	X	X	X	X	X	X

* These values may be field adjusted. Do not adjust Min Green and Extension times for phases 2 and 6 lower than what is shown. Min Green for all other phases should not be lower than 4 seconds.

**Signal Upgrade
Temporary Design 2 - TMP Phase II**

Stantec
Stantec Consulting Services Inc.
801 Jones Franklin Road-Suite 300
Raleigh, NC 27606
Tel. (919) 851-6866
Fax. (919) 851-7024
www.stantec.com
License No. F-0672

Prepared for the Offices of:
Transportation Mobility and Safety Division
STATE OF NORTH CAROLINA
SIGNAL DESIGN SECTION
750 N. Greenfield Pkwy, Garner, NC 27526
SCALE: 0 50
1"=50'

**US 401 Business (Raeford Road)
at
McPherson Church Road/
Owen Drive**
Division 6 Cumberland County Fayetteville
PLAN DATE: March 2018 REVIEWED BY: E D Harris
PREPARED BY: G B Spell REVIEWED BY: B L Watson

**DOCUMENT NOT CONSIDERED FINAL
UNLESS ALL SIGNATURES COMPLETED**

Professional Engineer Seal: 29449
Professional Engineer: Eddy J. Watson
DATE: 3/29/2018
SIG. INVENTORY NO. 06-005472

3/29/2018 10:11:11 AM User: rfmuncy

EDI MODEL 2018ECLip-NC CONFLICT MONITOR PROGRAMMING DETAIL

(remove jumpers and set switches as shown)

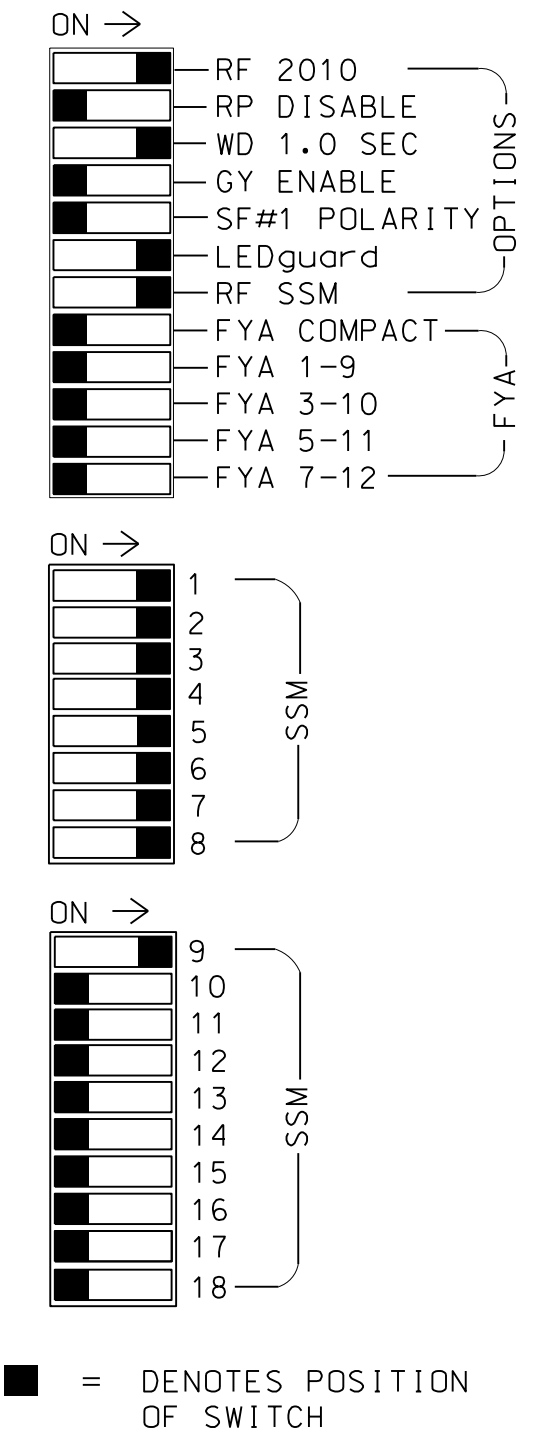
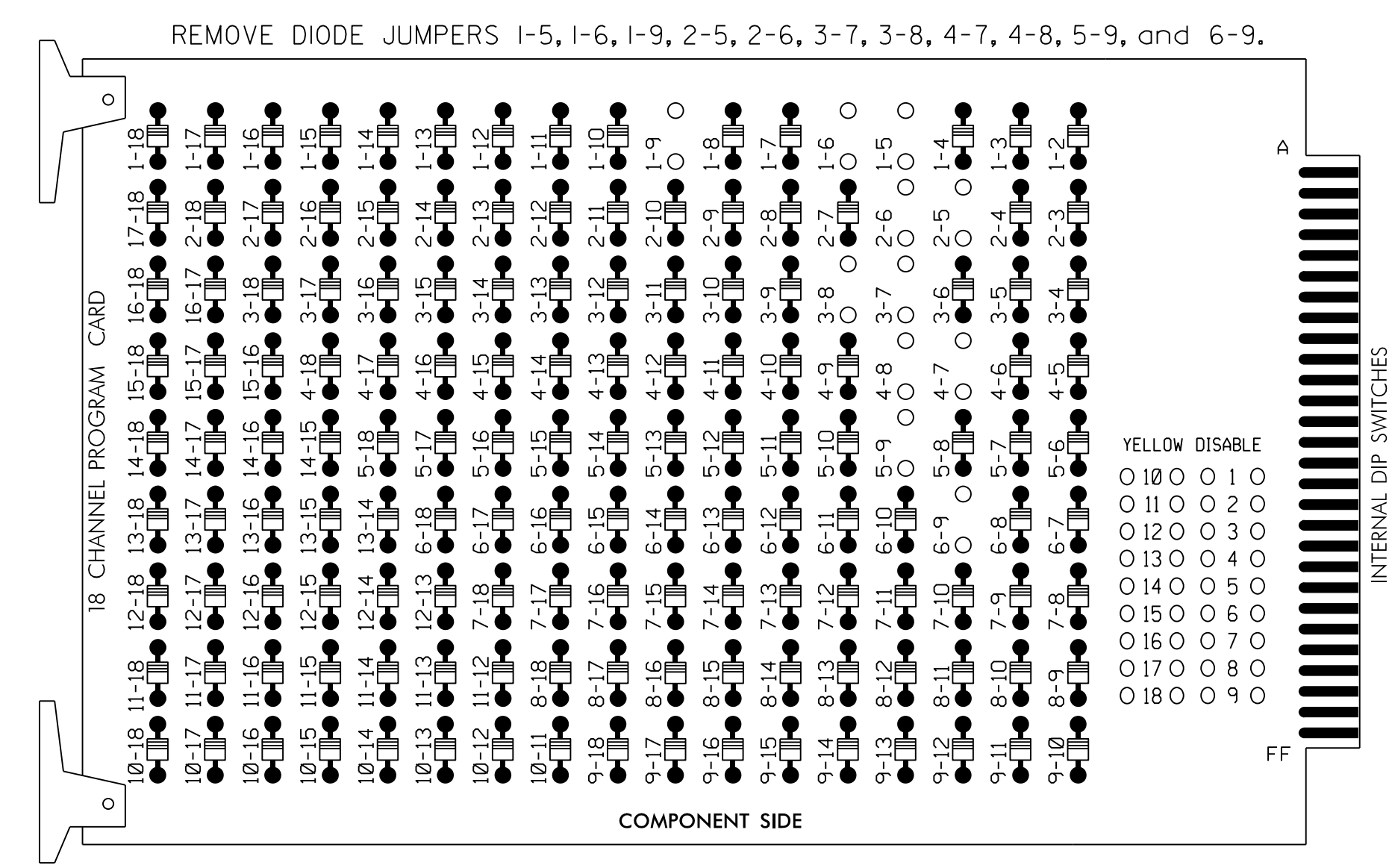

- NOTES:
- Card is provided with all diode jumpers in place. Removal of any jumper allows its channels to run concurrently.
 - Ensure jumpers SEL2-SEL5 and SEL9 are present on the monitor board.
 - Ensure that Red Enable is active at all times during normal operation.
 - Integrate monitor with Ethernet network in cabinet.

NOTES

- To prevent "flash-conflict" problems, insert red flash program blocks for all unused vehicle load switches in the output file. The installer shall verify that signal heads flash in accordance with the Signal Plans.
- Program controller to start up in Phase 2 Green and Phase 6 Green.
- The cabinet and controller are part of the Fayetteville Signal System.

SIGNAL HEAD HOOK-UP CHART

	S1	S2	S3	S4	S5	S6	S7	S8	S9	S10	S11	S12	AUX S1	AUX S2	AUX S3	AUX S4	AUX S5	AUX S6
CMU CHANNEL NO.	1	2	13	3	4	14	5	6	15	7	8	16	9	10	17	11	12	18
PHASE	1	2	2 PED	3	4	4 PED	5	6	6 PED	7	8	8 PED	OLA	OLB	SPARE	OLC	OLD	SPARE
SIGNAL HEAD NO.	11	21,22	NU	31,32	41,42	NU	51	61,62	NU	71	81,82	NU	82					
RED		128			101			134			107		*					
YELLOW		129			102			135			108							
GREEN		130			103			136			109							
RED ARROW	125			116			131			122								
YELLOW ARROW	126			117			132			123			A122					
GREEN ARROW	127			118			133			124			A123					

NU = Not Used
 * Denotes install load resistor. See load resistor installation detail this sheet.

EQUIPMENT INFORMATION

CONTROLLER.....2070
 CABINET.....332 W/ AUX
 SOFTWARE.....ECONOLITE ASC/3-2070
 CABINET MOUNT.....BASE
 OUTPUT FILE POSITIONS...18 WITH AUX. OUTPUT FILE
 LOAD SWITCHES USED.....S1,S2,S4,S5,S7,S8,
 S10,S11,AUX S1
 PHASES USED.....1,2,3,4,5,6,7,8
 OVERLAP A.....1
 OVERLAP B.....NOT USED
 OVERLAP C.....NOT USED
 OVERLAP D.....NOT USED

ECONOLITE ASC/3-2070 OVERLAP PROGRAMMING DETAIL

(program controller as shown)

- From Main Menu select **2. CONTROLLER**
- From CONTROLLER Submenu select **2. VEHICLE OVERLAPS**

OVERLAP A
 Select TMG VEH OVLP [A] and 'NORMAL'
 TMG VEH OVLP...[A] TYPE:**NORMAL**
 PHASES 1 2 3 4 5 6 7 8 9 0 1 2 3 4 5 6
 INCLUDED X
 LAG GRN 0.0 YEL 0.0 RED 0.0

END PROGRAMMING

THIS ELECTRICAL DETAIL IS FOR THE SIGNAL DESIGN: 06-005412
 DESIGNED: March 2018
 SEALED: 03-29-2018
 REVISED: N/A

INPUT FILE POSITION LAYOUT

(front view)

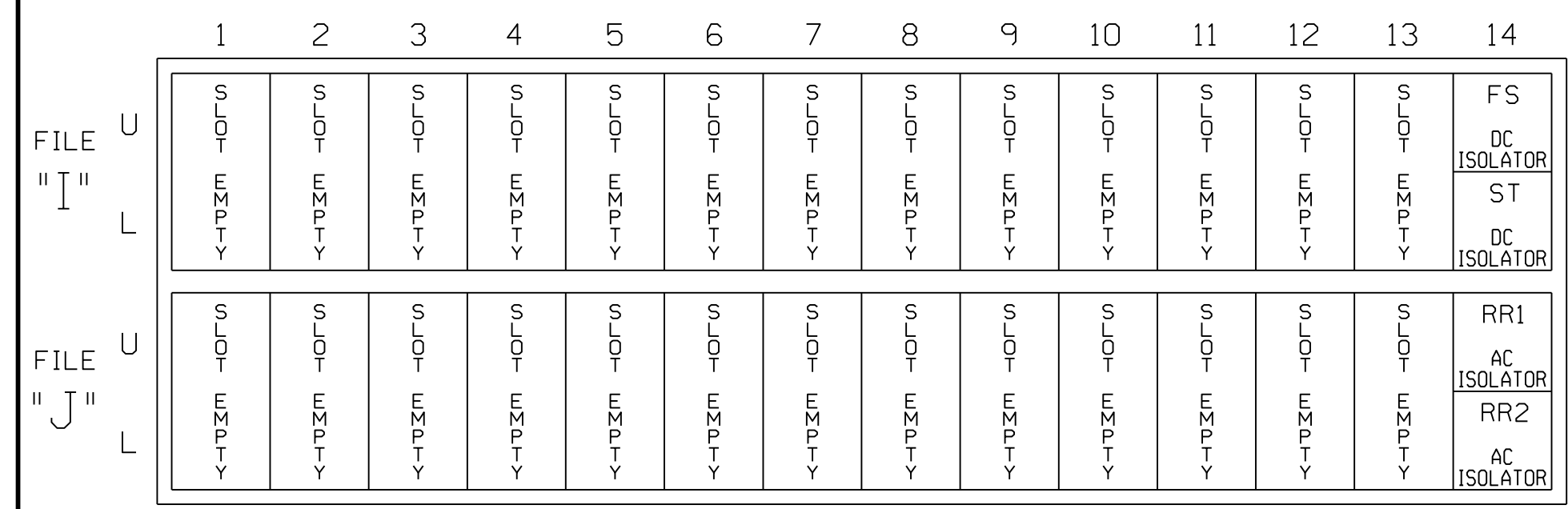

EX. : 1A, 2A, ETC. = LOOP NO.'S
 FS = FLASH SENSE
 ST = STOP TIME
 RRI,RR2 = RAILROAD PREEMPTS

NOTE: The RRI and RR2 preempt inputs have been remapped as detector inputs for use by the Logic Processor. See sheet 5 for details.

SPECIAL DETECTOR NOTE

Install a video detection system for vehicle detection. Perform installation according to manufacturer's directions and NCDOT engineer-approved mounting locations to accomplish the detection schemes shown on the Signal Design Plans.

AC ISOLATOR (MODEL 252) OUTPUT PROGRAMMING DETAIL

(set DIP switches as shown below)

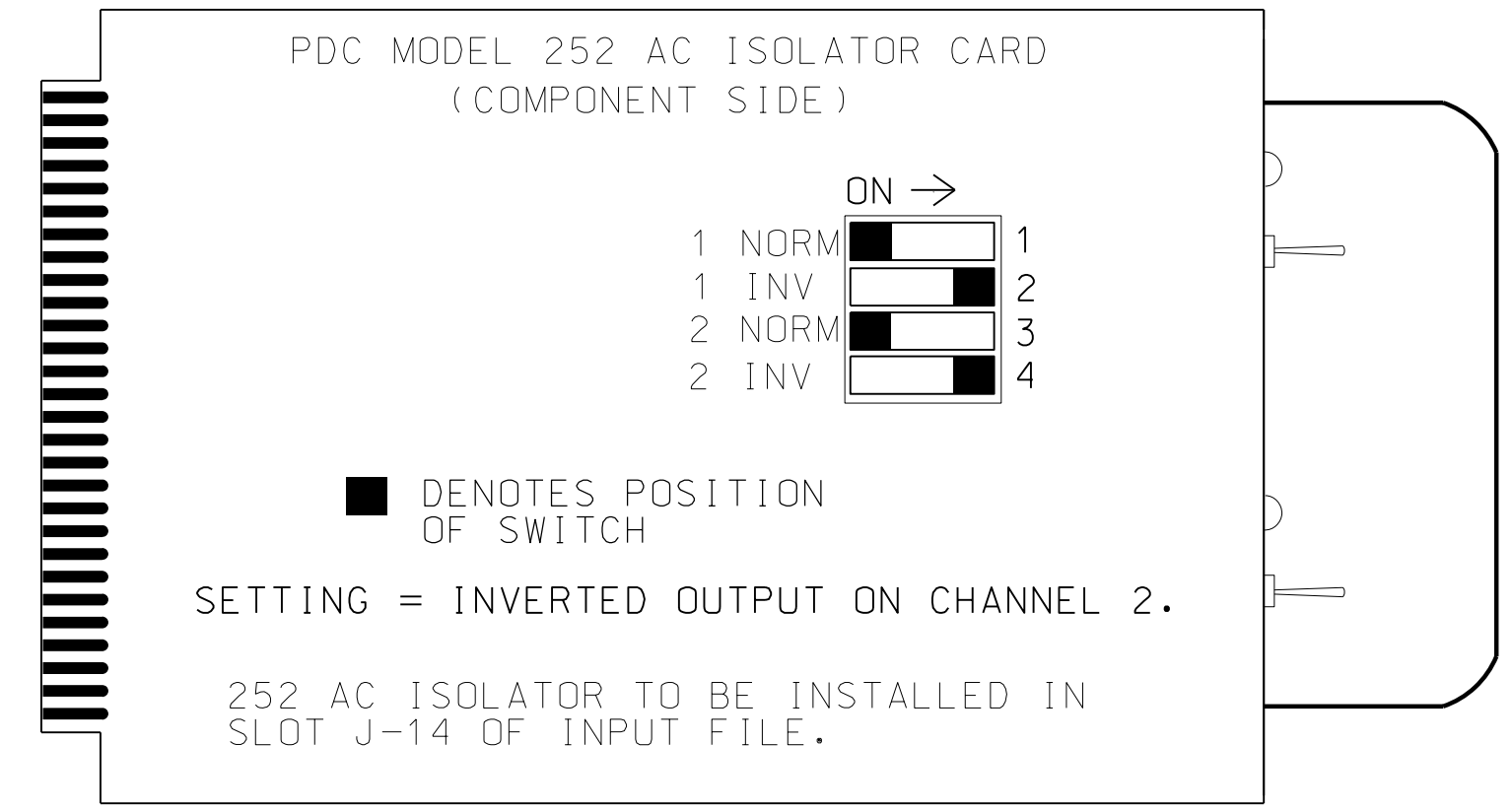

NOTE: IF ANOTHER MANUFACTURER TYPE OF AC ISOLATOR IS USED, OUTPUT PROGRAMMING IS LIKELY NOT TO EQUATE TO THAT SHOWN ABOVE.

LOAD RESISTOR INSTALLATION DETAIL

(install resistor as shown)

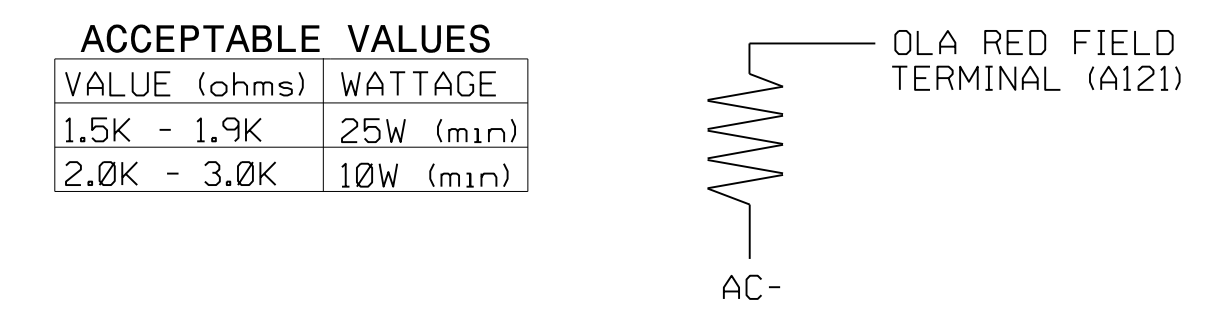

Temporary Design 2 - TMP Phase II Electrical Detail - Sheet 1 of 5

ELECTRICAL AND PROGRAMMING DETAILS FOR:
 Prepared in the Offices of:

US 401 Business (Raeford Road) at McPherson Church Road/ Owen Drive
 Division 6 Cumberland County Fayetteville
 PLAN DATE: March 2018 REVIEWED BY: L Overn
 PREPARED BY: G B Spell REVIEWED BY:
 REVISIONS: INIT. DATE

DOCUMENT NOT CONSIDERED FINAL UNLESS ALL SIGNATURES COMPLETED
 SEAL
 NORTH CAROLINA PROFESSIONAL ENGINEER
 LAWRENCE E. OVERN
 3/29/2018
 DATE
 SIG. INVENTORY NO. 06-005412

RAILROAD PREEMPTION WIRING DETAIL FOR RR1 (LINKED RR PREEMPTS 1 & 2)

(wire as shown below)

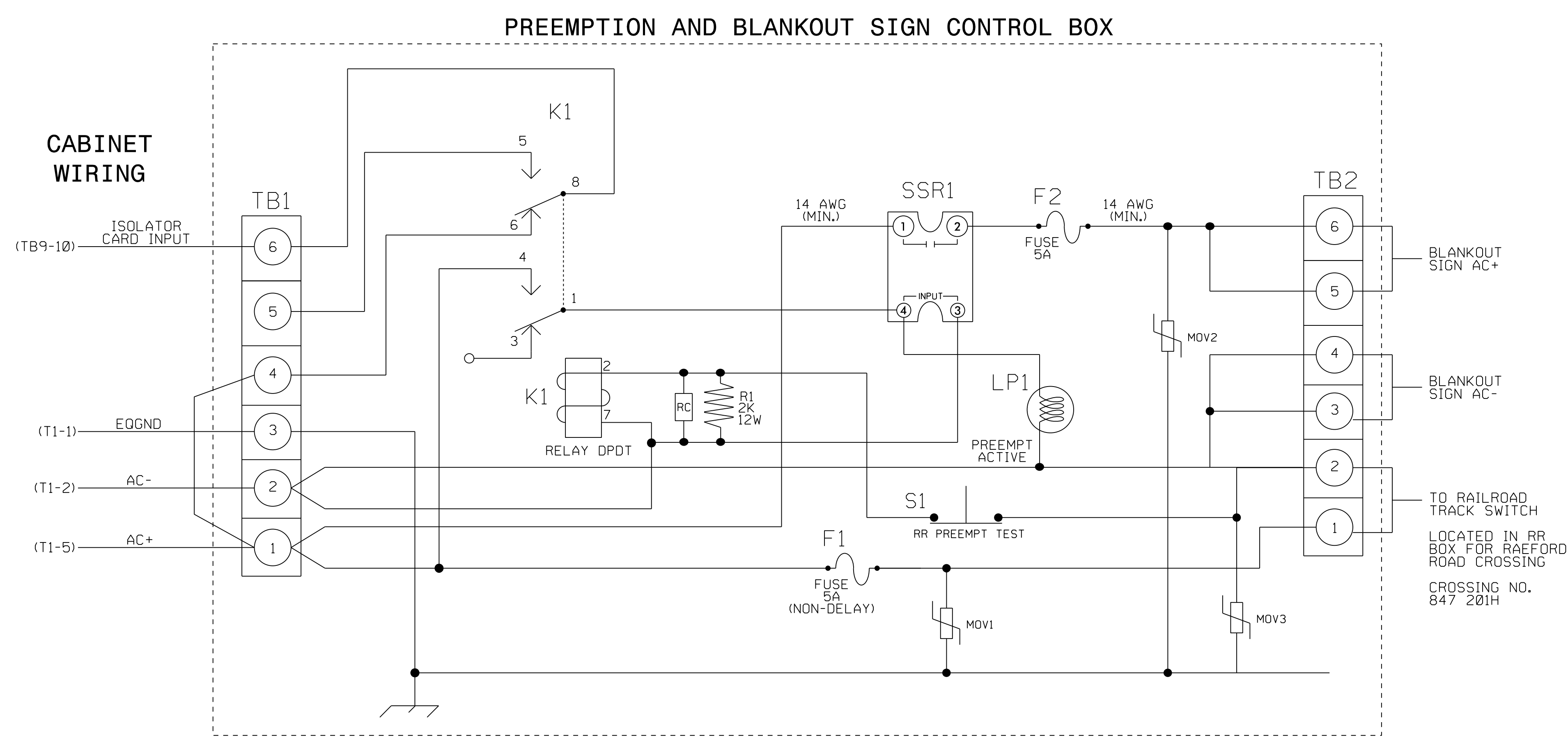

NOTES

1. Relay K1 is shown in the energized (Preempt not active) normal operation state.
2. Relay K1 is a DPDT with 120VAC coil with octal base.
3. Relay SSR1 is a SPST (normally open) Solid State Relay with AC input and AC (25 amp) output.
4. AC Isolator Card shall activate preemption upon removal of AC+ from the input (as shown above). To accomplish this set invert dip switch on AC Isolator card. See AC Isolator Output Programming Detail on Sheet 1.
5. IMPORTANT! A jumper must be added between input file terminals J4-E and J4-K if not already present. Also, terminal TB9-12 (on input panel) shall be connected to AC neutral (jumper may have to be added).

FRONT VIEW

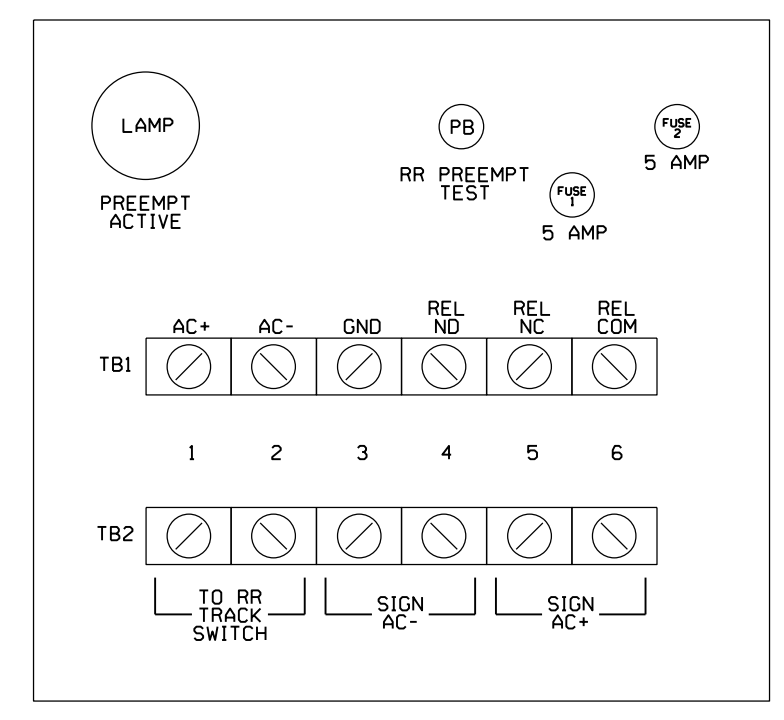

Temporary Design 2 - TMP Phase II
Electrical Detail - Sheet 2 of 5

THIS ELECTRICAL DETAIL IS FOR
THE SIGNAL DESIGN: 06-0054T2
DESIGNED: March 2018
SEALED: 03-29-2018
REVISED: N/A

Stantec Consulting Services Inc.
801 Jones Franklin Road-Suite 300
Raleigh, NC 27606
Tel. (919) 851-6866
Fax. (919) 851-7024
www.stantec.com
License No. F-0672

ELECTRICAL AND PROGRAMMING
DETAILS FOR:

Prepared in the Offices of:

750 N. Greenfield Pkwy, Garner, NC 27529

US 401 Business (Raeford Road)
at
McPherson Church Road/
Owen Drive

Division 6 Cumberland County Fayetteville

PLAN DATE: March 2018 REVIEWED BY: L Overn

PREPARED BY: G B Spell REVIEWED BY:

REVISIONS	INIT.	DATE

DOCUMENT NOT CONSIDERED FINAL
UNLESS ALL SIGNATURES COMPLETED

SEAL

NORTH CAROLINA
PROFESSIONAL
ENGINEER
LAWRENCE E. OVERN
045933

3/29/2018

SIG. INVENTORY NO. 06-0054T2

DATE: 03/29/2018 10:45:12 AM User: rmluncey

RAILROAD PREEMPTION WIRING DETAIL FOR RR2 (LINKED RR PREEMPTS 3 & 4)

(wire as shown below)

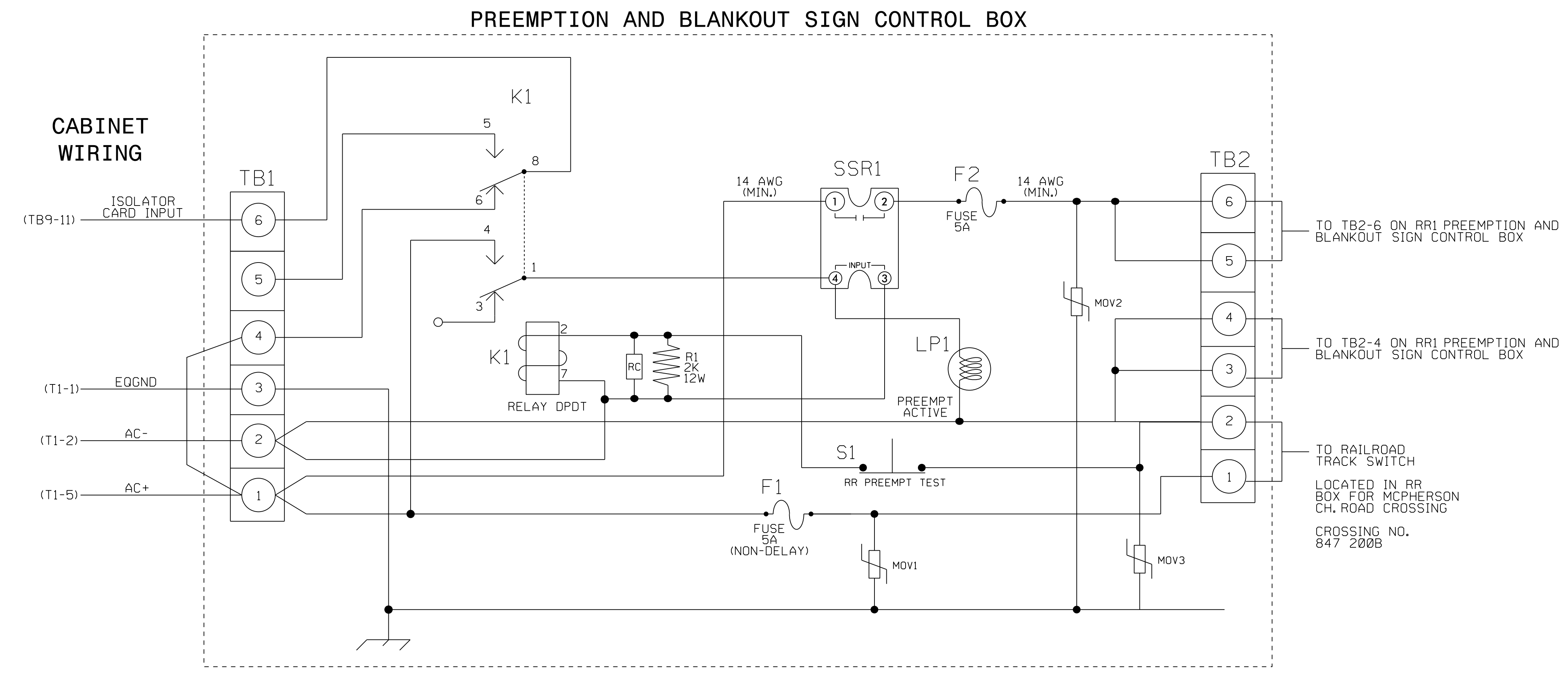

NOTES

1. Relay K1 is shown in the energized (Preempt and active) normal operation state.
2. Relay K1 is a DPDT with 120VAC coil with octabase.
3. Relay SSR1 is a SPST (normally open) Solid State Relay with AC input and AC (25 amp) output.
4. AC Isolator Card shall activate preemption upon removal of AC+ from the input (as shown above). To accomplish this set invert dip switch on AC Isolator Card. See AC Isolator Output Programming Detail on Sheet 1.

FRONT VIEW

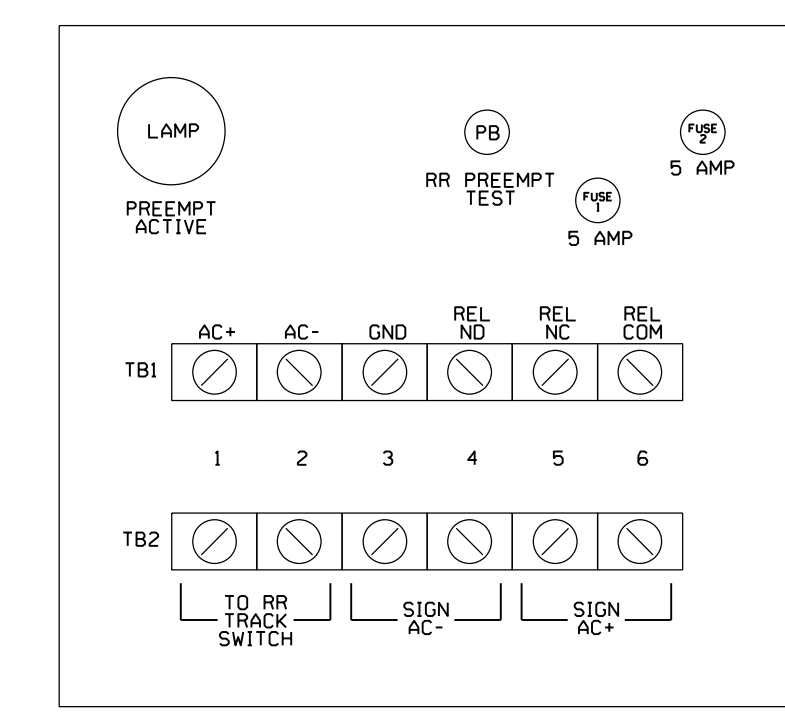

THIS ELECTRICAL DETAIL IS FOR THE SIGNAL DESIGN: 06-0054T2
DESIGNED: March 2018
SEALED: 03-29-2018
REVISED: N/A

Temporary Design 2 - TMP Phase II
Electrical Detail - Sheet 3 of 5

Stantec

Stantec Consulting Services Inc.
801 Jones Franklin Road-Suite 300
Raleigh, NC 27606
Tel. (919) 851-6866
Fax. (919) 851-7024
www.stantec.com
License No. F-0672

ELECTRICAL AND PROGRAMMING DETAILS FOR:

Prepared in the Offices of:

750 N. Greenfield Pkwy, Garner, NC 27529

US 401 Business (Raeford Road)
at
McPherson Church Road/
Owen Drive

Division 6 Cumberland County Fayetteville

PLAN DATE: March 2018 REVIEWED BY: L Overn

PREPARED BY: G B Spell REVIEWED BY:

REVISIONS	INIT.	DATE

SEAL

NORTH CAROLINA
PROFESSIONAL
SEAL
045933
ENGINEER
LAWRENCE E. OVERN

3/29/2018

DATE

SIG. INVENTORY NO. 06-0054T2

DATE: 03/29/2018 10:45:12 AM User: rfmancey

ECONOLITE ASC/3-2070 RAILROAD PREEMPT PROGRAMMING DETAIL

(program controller as shown)

- From Main Menu select **4. PREEMPTOR/TSP**
- From PREEMPTOR/TSP/SCP Submenu select **1. PREEMPT PLAN 1-10**

Place cursor in [] next to Preempt Plan and press 1. Then press the right cursor arrow and toggle the controller to YES. Next cursor down. This will select Railroad Preempt #1.

Place cursor in [] next to Preempt Plan and press 2. Then press the right cursor arrow and toggle the controller to YES. Next cursor down. This will select Railroad Preempt #2.

Place cursor in [] next to Preempt Plan and press 3. Then press the right cursor arrow and toggle the controller to YES. Next cursor down. This will select Railroad Preempt #3.

Place cursor in [] next to Preempt Plan and press 4. Then press the right cursor arrow and toggle the controller to YES. Next cursor down. This will select Railroad Preempt #4.

```

PREEMPT PLAN [ 1]  ENABLE....YES
VEH/PED 1 2 3 4 5 6 7 8 9 0 1 2 3 4 5 6
OVERLAP A B C D E F G H I J K L M N O P
TRKCLR V . . . X . . X . . . . . . . . . .
TRKCLR O . . . . . . . . . . . . . . . .
ENA TRL . . . . . . . . . . . . . . . .
DWEL VEH . . X . . . . . . . . . . . . . .
DWEL PED . . . . . . . . . . . . . . . .
DWEL OLP . . . . . . . . . . . . . . . .
CYC VEH . . . . . . . . . . . . . . . .
CYC PED . . . . . . . . . . . . . . . .
CYC OLP . . . . . . . . . . . . . . . .
EXIT PH . . . X . . . X . . . . . . . . . .
EXIT CAL . . . . . . . . . . . . . . . .
SP FUNC . . . . . . . . . . . . . . . .

ENABLE... YESIPMT OVRIDE..IINTERLOCK. NO
DET LOCK... .IDELAY.. 0IINHIBIT... 0
OVERRIDE FL. .IDURATION 0ICLR-GRN... NO
TERM OLP. NOIPC>YEL NOITERM PH NO
PED DARK.. NOITC RESRV YESIDWELL FL OFF
LINK PMT...0IX FLCOLR REDIEXIT OPT. OFF
X TMG PLN...OIRE-SERV.. 0IFLT TYPE.HARD
FREE DUR PMTIR1 NOIR2 NOIR3 NOIR4 NO
--TIMING-----WALKIPED CLIMN GRI YELI RED
ENTRANCE TM. 255I 255I 1125.5125.5
-----MIN GRIEXT GRIMX GRI YELI RED
TRACK CLEAR 21I 0I 0I 4.6I 1.7
-----MIN DLIPMTEXTIMX TMI YELI RED
DWL/CYC-EXIT 7I 0.0I 0I25.5I25.5
PMT ACTIVE OUT..ON PMT ACT DWELL...NO
OTHER - PRI PMT.OFF NON-PRI PMT....OFF
INH EXT TIME... 0.0 PED PR RETURN...OFF
PRIORITY RETURN.OFF QUEUE DELAY.... OFF
COND DELAY.....OFF
PHASES 1 2 3 4 5 6 7 8
PR RTN% 0 0 0 0 0 0 0 0
PHASES 9 10 11 12 13 14 15 16
PR RTN% 0 0 0 0 0 0 0 0

```

```

PREEMPT PLAN [ 2]  ENABLE....YES
VEH/PED 1 2 3 4 5 6 7 8 9 0 1 2 3 4 5 6
OVERLAP A B C D E F G H I J K L M N O P
TRKCLR V X . . . . . X . . . . . . . . . .
TRKCLR O . . . . . . . . . . . . . . . .
ENA TRL . . . . . . . . . . . . . . . .
DWEL VEH . . X . . . . . . . . . . . . . .
DWEL PED . . . . . . . . . . . . . . . .
DWEL OLP . . . . . . . . . . . . . . . .
CYC VEH . . . . . . . . . . . . . . . .
CYC PED . . . . . . . . . . . . . . . .
CYC OLP . . . . . . . . . . . . . . . .
EXIT PH . . . X . . . X . . . . . . . . . .
EXIT CAL . . . . . . . . . . . . . . . .
SP FUNC . . . . . . . . . . . . . . . .

ENABLE... YESIPMT OVRIDE..IINTERLOCK. NO
DET LOCK... .IDELAY.. 0IINHIBIT... 0
OVERRIDE FL. .IDURATION 0ICLR-GRN... NO
TERM OLP. NOIPC>YEL NOITERM PH NO
PED DARK.. NOITC RESRV YESIDWELL FL OFF
LINK PMT...1IX FLCOLR REDIEXIT OPT. OFF
X TMG PLN...OIRE-SERV.. 0IFLT TYPE.HARD
FREE DUR PMTIR1 NOIR2 NOIR3 NOIR4 NO
--TIMING-----WALKIPED CLIMN GRI YELI RED
ENTRANCE TM. 255I 255I 1125.5125.5
-----MIN GRIEXT GRIMX GRI YELI RED
TRACK CLEAR 35I 0I 0I 3.8I 2.1
-----MIN DLIPMTEXTIMX TMI YELI RED
DWL/CYC-EXIT 0I 0.0I 0I25.5I25.5
PMT ACTIVE OUT..ON PMT ACT DWELL...NO
OTHER - PRI PMT.OFF NON-PRI PMT....OFF
INH EXT TIME... 0.0 PED PR RETURN...OFF
PRIORITY RETURN.OFF QUEUE DELAY.... OFF
COND DELAY.....OFF
PHASES 1 2 3 4 5 6 7 8
PR RTN% 0 0 0 0 0 0 0 0
PHASES 9 10 11 12 13 14 15 16
PR RTN% 0 0 0 0 0 0 0 0

```

```

PREEMPT PLAN [ 3]  ENABLE....YES
VEH/PED 1 2 3 4 5 6 7 8 9 0 1 2 3 4 5 6
OVERLAP A B C D E F G H I J K L M N O P
TRKCLR V X . . . . . X . . . . . . . . . .
TRKCLR O . . . . . . . . . . . . . . . .
ENA TRL . . . . . . . . . . . . . . . .
DWEL VEH . . X . . . . . . . . . . . . . .
DWEL PED . . . . . . . . . . . . . . . .
DWEL OLP . . . . . . . . . . . . . . . .
CYC VEH . . . . . . . . . . . . . . . .
CYC PED . . . . . . . . . . . . . . . .
CYC OLP . . . . . . . . . . . . . . . .
EXIT PH . . . X . . . X . . . . . . . . . .
EXIT CAL . . . . . . . . . . . . . . . .
SP FUNC . . . . . . . . . . . . . . . .

ENABLE... YESIPMT OVRIDE..IINTERLOCK. NO
DET LOCK... .IDELAY.. 0IINHIBIT... 0
OVERRIDE FL. .IDURATION 0ICLR-GRN... NO
TERM OLP. NOIPC>YEL NOITERM PH NO
PED DARK.. NOITC RESRV YESIDWELL FL OFF
LINK PMT...0IX FLCOLR REDIEXIT OPT. OFF
X TMG PLN...OIRE-SERV.. 0IFLT TYPE.HARD
FREE DUR PMTIR1 NOIR2 NOIR3 NOIR4 NO
--TIMING-----WALKIPED CLIMN GRI YELI RED
ENTRANCE TM. 255I 255I 1125.5125.5
-----MIN GRIEXT GRIMX GRI YELI RED
TRACK CLEAR 35I 0I 0I 3.8I 2.1
-----MIN DLIPMTEXTIMX TMI YELI RED
DWL/CYC-EXIT 7I 0.0I 0I25.5I25.5
PMT ACTIVE OUT..ON PMT ACT DWELL...NO
OTHER - PRI PMT.OFF NON-PRI PMT....OFF
INH EXT TIME... 0.0 PED PR RETURN...OFF
PRIORITY RETURN.OFF QUEUE DELAY.... OFF
COND DELAY.....OFF
PHASES 1 2 3 4 5 6 7 8
PR RTN% 0 0 0 0 0 0 0 0
PHASES 9 10 11 12 13 14 15 16
PR RTN% 0 0 0 0 0 0 0 0

```

```

PREEMPT PLAN [ 4]  ENABLE....YES
VEH/PED 1 2 3 4 5 6 7 8 9 0 1 2 3 4 5 6
OVERLAP A B C D E F G H I J K L M N O P
TRKCLR V . . . X . . X . . . . . . . . . .
TRKCLR O . . . . . . . . . . . . . . . .
ENA TRL . . . . . . . . . . . . . . . .
DWEL VEH . . X . . . . . . . . . . . . . .
DWEL PED . . . . . . . . . . . . . . . .
DWEL OLP . . . . . . . . . . . . . . . .
CYC VEH . . . . . . . . . . . . . . . .
CYC PED . . . . . . . . . . . . . . . .
CYC OLP . . . . . . . . . . . . . . . .
EXIT PH . . . X . . . X . . . . . . . . . .
EXIT CAL . . . . . . . . . . . . . . . .
SP FUNC . . . . . . . . . . . . . . . .

ENABLE... YESIPMT OVRIDE..IINTERLOCK. NO
DET LOCK... .IDELAY.. 0IINHIBIT... 0
OVERRIDE FL. .IDURATION 0ICLR-GRN... NO
TERM OLP. NOIPC>YEL NOITERM PH NO
PED DARK.. NOITC RESRV YESIDWELL FL OFF
LINK PMT...3IX FLCOLR REDIEXIT OPT. OFF
X TMG PLN...OIRE-SERV.. 0IFLT TYPE.HARD
FREE DUR PMTIR1 NOIR2 NOIR3 NOIR4 NO
--TIMING-----WALKIPED CLIMN GRI YELI RED
ENTRANCE TM. 255I 255I 1125.5125.5
-----MIN GRIEXT GRIMX GRI YELI RED
TRACK CLEAR 21I 0I 0I 4.6I 1.7
-----MIN DLIPMTEXTIMX TMI YELI RED
DWL/CYC-EXIT 0I 0.0I 0I25.5I25.5
PMT ACTIVE OUT..ON PMT ACT DWELL...NO
OTHER - PRI PMT.OFF NON-PRI PMT....OFF
INH EXT TIME... 0.0 PED PR RETURN...OFF
PRIORITY RETURN.OFF QUEUE DELAY.... OFF
COND DELAY.....OFF
PHASES 1 2 3 4 5 6 7 8
PR RTN% 0 0 0 0 0 0 0 0
PHASES 9 10 11 12 13 14 15 16
PR RTN% 0 0 0 0 0 0 0 0

```

NOTICE LINK PMT 1 →

NOTICE LINK PMT 3 →

Linked preempts 1 and 2 make up preempt RR1

Linked preempts 3 and 4 make up preempt RR2

ECONOLITE ASC/3-2070 PREEMPT FILTERING

- From Main Menu select **4. PREEMPTOR/TSP**
- From PREEMPTOR/TSP/SCP Submenu select **2. ENABLE PREEMPT FILTERING & TSP/SCP**
- Ensure all preempt entries are set to BYPASSED for both SOLID and PULSING.

THIS ELECTRICAL DETAIL IS FOR THE SIGNAL DESIGN: 06-005412
DESIGNED: March 2018
SEALED: 03-29-2018
REVISED: N/A



Stantec Consulting Services Inc.
801 Jones Franklin Road-Suite 300
Raleigh, NC 27606
Tel. (919) 851-6866
Fax. (919) 851-7024
www.stantec.com
License No. F-0672

ELECTRICAL AND PROGRAMMING DETAILS FOR:

Prepared in the Offices of:

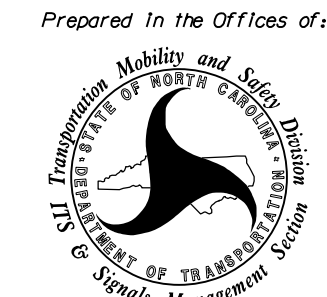

750 N. Greenfield Pkwy, Garner, NC 27529

US 401 Business (Raeford Road)
at
McPherson Church Road/
Owen Drive
Division 6 Cumberland County Fayetteville

PLAN DATE: March 2018 REVIEWED BY: L Overn
PREPARED BY: G B Spell REVIEWED BY:

REVISIONS	INIT.	DATE

DOCUMENT NOT CONSIDERED FINAL UNLESS ALL SIGNATURES COMPLETED

SEAL
NORTH CAROLINA PROFESSIONAL ENGINEER
SEAL 045933
LAWRENCE E. OVERN
3/29/2018
DATE
SIG. INVENTORY NO. 06-005412

DATE: 03/29/2018 10:00:00 AM
USER: rfmancey

ECONOLITE ASC/3-2070 LOGIC PROCESSOR PROGRAMMING DETAIL

(program controller as shown)

- From Main Menu select **1. CONFIGURATION**
- From CONFIGURATION Submenu select **8. LOGIC PROCESSOR**
- From LOGIC PROCESSOR Submenu select **2. LOGIC STATEMENTS**

ENTER A "1" IN THE LP# FIELD, PRESS 'ENTER', AND PROGRAM AS SHOWN.

```

LP#: 1 COPY FROM: 1 ACTIVE: M
IF DET 52 IS ON

THEN LP SET LOGIC FLAG 1 ON

ELSE

```

IF RR1 PREEMPT (REMAPPED AS DET 52) INPUT IS ACTIVE, SET LOGIC FLAG 1 ON.

ENTER A "2" IN THE LP# FIELD, PRESS 'ENTER', AND PROGRAM AS SHOWN.

```

LP#: 2 COPY FROM: 2 ACTIVE: M
IF LP FLAG 1 IS ON

THEN PMT CALL PMT SEQ 2 ON

ELSE

```

IF LOGIC FLAG 1 IS ON, THEN INITIATE PREEMPT 2 SEQUENCE. THE PREEMPT MAY OR MAY NOT ACTUALLY BE SERVED DEPENDING ON THE STATE OF THE OTHER RR PREEMPT INPUT.

ENTER A "3" IN THE LP# FIELD, PRESS 'ENTER', AND PROGRAM AS SHOWN.

```

LP#: 3 COPY FROM: 3 ACTIVE: M
IF DET 54 IS ON

THEN LP SET LOGIC FLAG 2 ON

ELSE

```

IF RR2 PREEMPT (REMAPPED AS DET 54) INPUT IS ACTIVE, SET LOGIC FLAG 2 ON.

ENTER A "4" IN THE LP# FIELD, PRESS 'ENTER', AND PROGRAM AS SHOWN.

```

LP#: 4 COPY FROM: 4 ACTIVE: M
IF LP FLAG 2 IS ON

THEN PMT CALL PMT SEQ 4 ON

ELSE

```

IF LOGIC FLAG 2 IS ON, THEN INITIATE PREEMPT 4 SEQUENCE. THE PREEMPT MAY OR MAY NOT ACTUALLY BE SERVED DEPENDING ON THE STATE OF THE OTHER RR PREEMPT INPUT.

ENTER A "5" IN THE LP# FIELD, PRESS 'ENTER', AND PROGRAM AS SHOWN.

```

LP#: 5 COPY FROM: 5 ACTIVE: M
IF DET 52 IS OFF
AND DET 54 IS OFF

THEN LP SET LOGIC FLAG 1 OFF
THEN LP SET LOGIC FLAG 2 OFF

ELSE

```

WHEN BOTH PREEMPT INPUTS GO INACTIVE, THIS LOGIC RESETS THE LOGIC FLAG THAT IS HOLDING THE ACTIVE PREEMPT ACTIVE, AND RESETS THE OTHER LOGIC FLAG TO PREVENT IT FROM CALLING THE OTHER PREEMPT.

END PROGRAMMING

- From Main Menu select **1. CONFIGURATION**
- From CONFIGURATION Submenu select **8. LOGIC PROCESSOR**
- From LOGIC PROCESSOR Submenu select **1. LOGIC STATEMENT CONTROL**

ENABLE LOGIC PROCESSOR STATEMENTS 1-5 BY POSITIONING THE CURSOR OVER THE FIELDS SHOWN BELOW AND USING THE TOGGLE KEY TO ENABLE THEM.

LOGIC STATEMENT CONTROL	
	1 2 3 4 5 6 7 8 9 0 1 2 3 4 5
LP 1-15	E E E E E
LP 16-30
LP 31-45
LP 46-60
LP 61-75
LP 76-90

END PROGRAMMING

ECONOLITE ASC/3-2070 I/O PIN REMAPPING FOR RR1 AND RR2 PREEMPT INPUTS

The ASC/3 Configurator utility program must be used to remap the I/O pins as shown below. Consult the ASC/3 Configurator User Guide for specific instructions on software use.

- Run the Configurator utility. Load a file as the Current DB.
- Choose the C1-in tab to change the I/O mapping as needed. Use the drop down list within the program to select the assigned function for the pins shown below.
- Save the database file and download it to the controller.

C1 PIN #	DEFAULT FUNCTION	ASSIGNED FUNCTION
----------	------------------	-------------------

PIN 51-PREEMPT 1 CALL →

PIN 52-PREEMPT 2 CALL →

NOTE: PREEMPT INPUTS REMAPPED AS DETECTORS

NOTE: The steps below can be used to view changes to I/O pins within the controller. Any I/O pins that have been remapped will display and show their default function in addition to the current assigned function.

- From Main Menu select **7. STATUS DISPLAY**
- From STATUS DISPLAY Submenu select **8. INPUTS/OUTPUTS**
- From INPUT/OUTPUT Submenu select **9. I/O DIFFERENCES**

ECONOLITE ASC/3-2070 VEHICLE DETECTOR SETUP PROGRAMMING DETAIL FOR REMAPPED DETECTORS

(program controller as shown)

The preempt inputs remapped as detectors that are to be used by the logic processor are assigned to a dummy phase 9 as shown in the detector setup programming below.

- From Main Menu select **6. DETECTORS**
- From DETECTOR Submenu select **2. VEHICLE DETECTOR SETUP**

- Place cursor in VEH DETECTOR [] position and enter "52".

DISABLE TS2 DETECTOR →

ASSIGN PHASE 9 →

```

VEH DETECTOR [52] VEH DET PLAN [ 1]
TYPE: S-STANDARD
TS2 DETECTOR..... ECPI LOG..... NO
DET PH - 1 2 3 4 5 6 7 8 9 0 1 2 3 4 5 6
52 9 . . . . .
EXTEND TIME... 0.0 DELAY TIME... 0.0
USE ADDED INITIAL . CROSS SWITCH PH.. 0
LOCK IN..... NONE NTCIP VOL . OR OCC .
PMT QUEUE DELAY. NO

```

- Place cursor in VEH DETECTOR [] position and enter "54".

DISABLE TS2 DETECTOR →

ASSIGN PHASE 9 →

```

VEH DETECTOR [54] VEH DET PLAN [ 1]
TYPE: S-STANDARD
TS2 DETECTOR..... ECPI LOG..... NO
DET PH - 1 2 3 4 5 6 7 8 9 0 1 2 3 4 5 6
54 9 . . . . .
EXTEND TIME... 0.0 DELAY TIME... 0.0
USE ADDED INITIAL . CROSS SWITCH PH.. 0
LOCK IN..... NONE NTCIP VOL . OR OCC .
PMT QUEUE DELAY. NO

```

END PROGRAMMING

THIS ELECTRICAL DETAIL IS FOR THE SIGNAL DESIGN: 06-0054T2 DESIGNED: March 2018 SEALED: 03-29-2018 REVISED: N/A

Temporary Design 2 - TMP Phase II Electrical Detail - Sheet 5 of 5

DATE: U:\Projects\Signal\Signal\Temp\Phase 2\U-4405-sig-67.5-06-0054T2.dgn User: rmlunicy

Stantec Consulting Services Inc.
801 Jones Franklin Road-Suite 300
Raleigh, NC 27606
Tel. (919) 851-6866
Fax. (919) 851-7024
www.stantec.com
License No. F-0672

ELECTRICAL AND PROGRAMMING DETAILS FOR:

Prepared in the Offices of:

750 N. Greenfield Pkwy, Garner, NC 27529

US 401 Business (Raeford Road) at McPherson Church Road/ Owen Drive

Division 6 Cumberland County Fayetteville

PLAN DATE: March 2018 REVIEWED BY: L Overn

PREPARED BY: G B Spell REVIEWED BY:

REVISIONS	INIT.	DATE

DOCUMENT NOT CONSIDERED FINAL UNLESS ALL SIGNATURES COMPLETED

SEAL

3/29/2018

SIG. INVENTORY NO. 06-0054T2

PHASING DIAGRAM

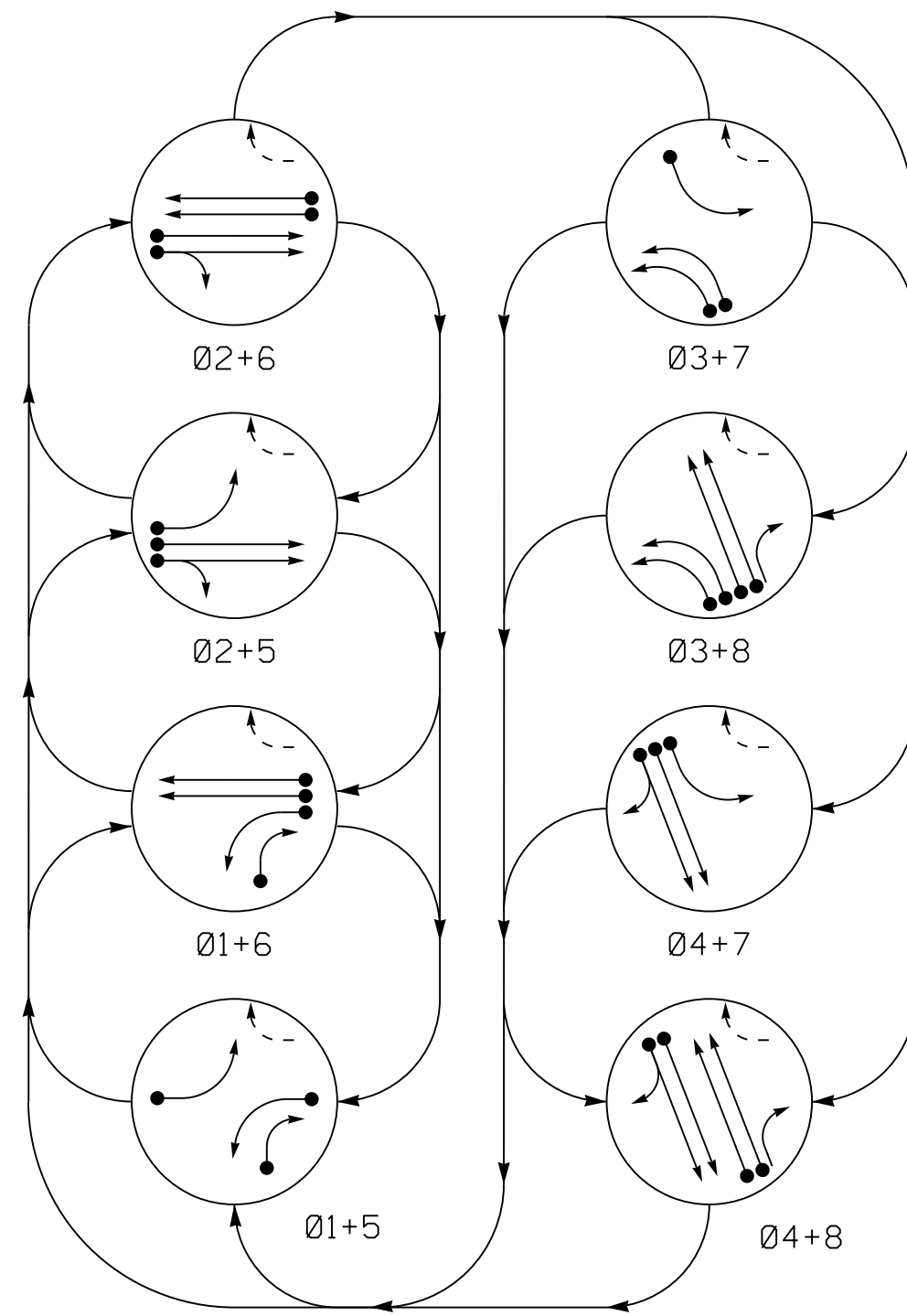

RAIL PREEMPT PHASES (High Priority)

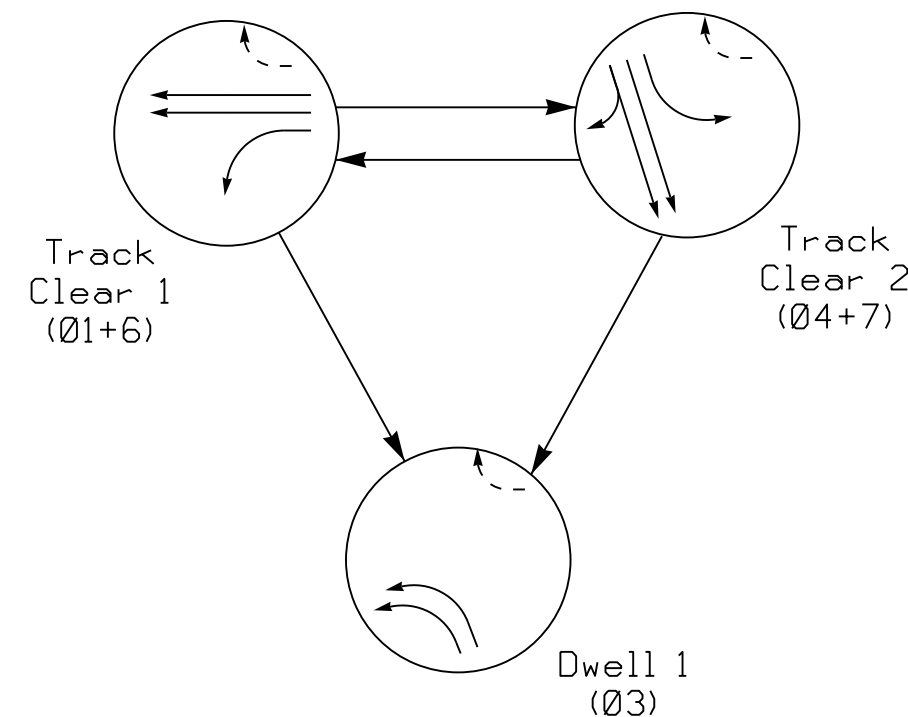

PHASING DIAGRAM DETECTION LEGEND

- DETECTED MOVEMENT
- UNDETECTED MOVEMENT (OVERLAP)
- UNSIGNALIZED MOVEMENT
- ⚡ PEDESTRIAN MOVEMENT

TABLE OF OPERATION

SIGNAL FACE	PHASE											
	Ø1+5	Ø1+6	Ø2+5	Ø2+6	Ø3+7	Ø3+8	Ø4+7	Ø4+8	Ø1+5	Ø1+6	Ø2+5	Ø2+6
11	←	←	←	←	←	←	←	←	←	←	←	←
21,22	R	R	G	G	R	R	R	R	R	R	R	Y
31,32	←	←	←	←	←	←	←	←	←	←	←	←
41,42	R	R	R	R	R	R	R	G	G	R	G	R
51	←	←	←	←	←	←	←	←	←	←	←	←
61,62	R	G	R	G	R	R	R	R	G	R	R	Y
71	←	←	←	←	←	←	←	←	←	←	←	←
81	R	R	R	R	R	G	R	G	R	R	R	R
82	R	R	R	R	R	G	R	G	R	R	R	R

Sign (A) OFF OFF OFF OFF OFF OFF OFF OFF OFF ON ON ON ON *

* See Note 7

ASC/3 DETECTOR INSTALLATION CHART

LOOP	SIZE (FT)	DISTANCE FROM STOPBAR (FT)	TURNS	NEW LOOP	PROGRAMMING							
					PHASE	CALLING	EXTEND TIME	DELAY TIME	USE ADDED INITIAL	TYPE	LOOP	NEW CARD
1A	6X40	0	*	-	1	Yes	-	-	-	S	-	-
1B	6X40	0	*	-	1	Yes	-	15	-	S	-	-
2A	6X6	70	*	-	2	Yes	-	-	-	S	-	-
2B	6X6	70	*	-	2	Yes	-	-	-	S	-	-
3A	6X40	0	*	-	3	Yes	-	3	-	S	-	-
3B	6X40	0	*	-	3	Yes	-	-	-	S	-	-
4A	6X40	0	*	-	4	Yes	-	-	-	S	-	-
4B	6X40	0	*	-	4	Yes	-	10	-	S	-	-
4C	6X15	0	*	-	4	Yes	-	15	-	S	-	-
5A	6X40	0	*	-	5	Yes	-	-	-	S	-	-
6A	6X6	70	*	-	6	Yes	-	-	-	S	-	-
6B	6X6	70	*	-	6	Yes	-	-	-	S	-	-
7A	6X40	0	*	-	7	Yes	-	3	-	S	-	-
8A	6X40	0	*	-	8	Yes	-	-	-	S	-	-
8B	6X40	0	*	-	8	Yes	-	-	-	S	-	-

* Video Detection Area. Camera locations should be confirmed in the field by the contractor in order to provide detection of the areas indicated.

ASC/3 RR PREEMPT

FUNCTION	SEQUENCE 1	SEQUENCE 2
Exit Phase(s)	4,8	4,8
Preempt Override	OFF	OFF
Delay Time	0	0
Ped Clear Trough Yellow	N	N
Terminate Phases	N	N
Track Clear Reserve	Y	Y
Entrance Walk	255*	255*
Entrance Ped Clear	255*	255*
Entrance Min Green	1	1
Entrance Yellow Change	25.5*	25.5*
Entrance Red Clear	25.5*	25.5*
Track Clear Min Green 1	35	19
Track Clear Yellow Change 1	3.8	4.6
Track Clear Red Clear 1	2.5	2.3
Track Clear Min Green 2	19	35
Track Clear Yellow Change 2	4.6	3.8
Track Clear Red Clear 2	2.3	2.5
Min Dwell Time	7	7
Exit Yellow Change	25.5*	25.5*
Exit Red Clear	25.5*	25.5*

* Time defaults to time used for phase during normal operation.

SIGNAL FACE I.D.

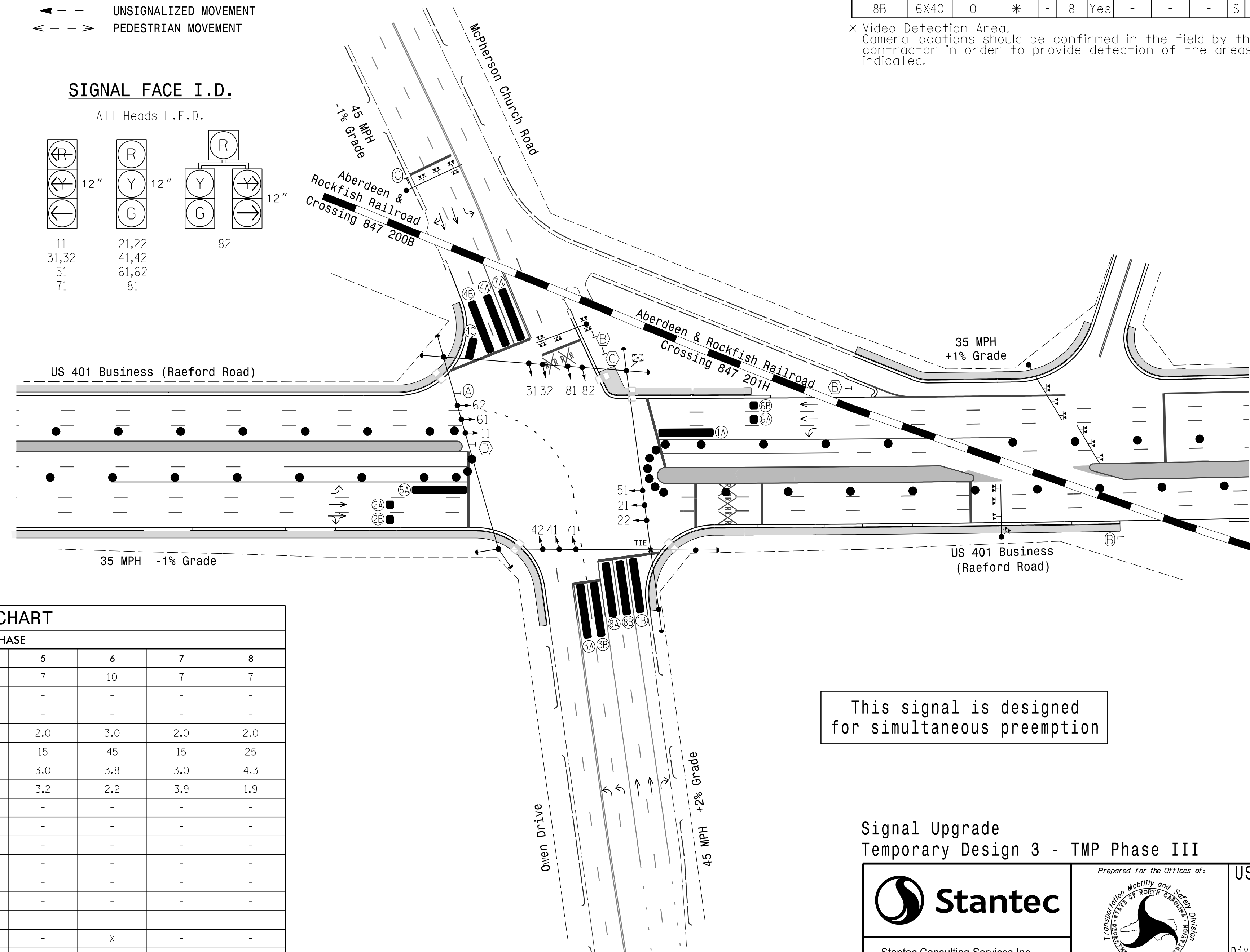
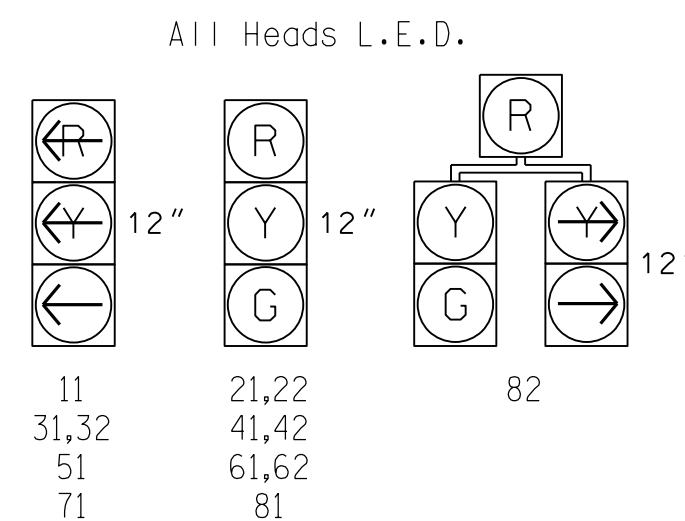

This signal is designed for simultaneous preemption

LEGEND

- | PROPOSED | EXISTING |
|----------------------------------------------------|----------|
| ○ → Traffic Signal Head | ● → N/A |
| ○ → Modified Signal Head | ○ → N/A |
| ○ → Pedestrian Signal Head With Push Button & Sign | ○ → N/A |
| ○ → Signal Pole with Guy | ○ → N/A |
| ○ → Signal Pole with Sidewalk Guy | ○ → N/A |
| ○ → Inductive Loop Detector | ○ → N/A |
| ○ → Controller & Cabinet | ○ → N/A |
| ○ → Junction Box | ○ → N/A |
| --- 2-in Underground Conduit | --- N/A |
| N/A Right of Way | N/A |
| N/A Directional Arrow | N/A |
| N/A Railroad Cantilever | N/A |
| N/A Railroad Tracks | N/A |
| ■ Video Detection Area | N/A |
| ■ Construction Zone | N/A |
| ● Construction Zone Drums | N/A |
| (A) "NO RIGHT TURN - TRAIN" L.E.D. Blankout Sign | (A) |
| (B) "DO NOT STOP ON TRACKS" Sign (R8-8) | (B) |
| (C) "Stop Here on Red" Sign (R10-6) | (C) |
| (D) "U-TURN YIELD TO RIGHT TURN" Sign (R10-16) | (D) |

ASC/3 TIMING CHART

FEATURE	PHASE							
	1	2	3	4	5	6	7	8
Min Green *	7	10	7	7	7	10	7	7
Walk *	-	-	-	-	-	-	-	-
Ped Clear	-	-	-	-	-	-	-	-
Veh. Extension *	2.0	3.0	2.0	2.0	2.0	3.0	2.0	2.0
Max 1 *	15	45	15	25	15	45	15	25
Yellow	3.0	3.9	3.0	4.6	3.0	3.8	3.0	4.3
Red Clear	3.3	2.4	4.0	2.1	3.2	2.2	3.9	1.9
Red Revert	-	-	-	-	-	-	-	-
Actuations B4 Add *	-	-	-	-	-	-	-	-
Seconds /Actuation *	-	-	-	-	-	-	-	-
Max Initial *	-	-	-	-	-	-	-	-
Time Before Reduction *	-	-	-	-	-	-	-	-
Time To Reduce *	-	-	-	-	-	-	-	-
Minimum Gap	-	-	-	-	-	-	-	-
Locking Detector	-	X	-	-	-	X	-	-
Recall Position	-	VEH. RECALL	-	-	-	VEH. RECALL	-	-
Dual Entry	-	-	-	-	-	-	-	-
Simultaneous Gap	X	X	X	X	X	X	X	X

* These values may be field adjusted. Do not adjust Min Green and Extension times for phases 2 and 6 lower than what is shown. Min Green for all other phases should not be lower than 4 seconds.

Signal Upgrade Temporary Design 3 - TMP Phase III

Stantec
 Stantec Consulting Services Inc.
 801 Jones Franklin Road-Suite 300
 Raleigh, NC 27606
 Tel. (919) 851-6866
 Fax. (919) 851-7024
 www.stantec.com
 License No. F-0672

Prepared for the Offices of:

 750 N. Greenfield Pkwy, Garner, NC 27526
 SCALE: 0 50
 1"=50'

US 401 Business (Raeford Road) at McPherson Church Road/ Owen Drive
 Division 6 Cumberland County Fayetteville
 PLAN DATE: March 2018 REVIEWED BY: E D Harris
 PREPARED BY: G B Spell REVIEWED BY: B L Watson

DOCUMENT NOT CONSIDERED FINAL UNLESS ALL SIGNATURES COMPLETED

REVISIONS: INIT. DATE

DATE: 3/29/2018
 DATE: _____
 DATE: _____

SIG. INVENTORY NO. 06-005413

3/29/2018 10:43:11 AM
 User: rfmccoy
 C:\Users\rfmccoy\Documents\Signal Design\Phase 3\U-4405.sia.dgn, 06-005413.dgn

EDI MODEL 2018ECLip-NC CONFLICT MONITOR PROGRAMMING DETAIL

(remove jumpers and set switches as shown)

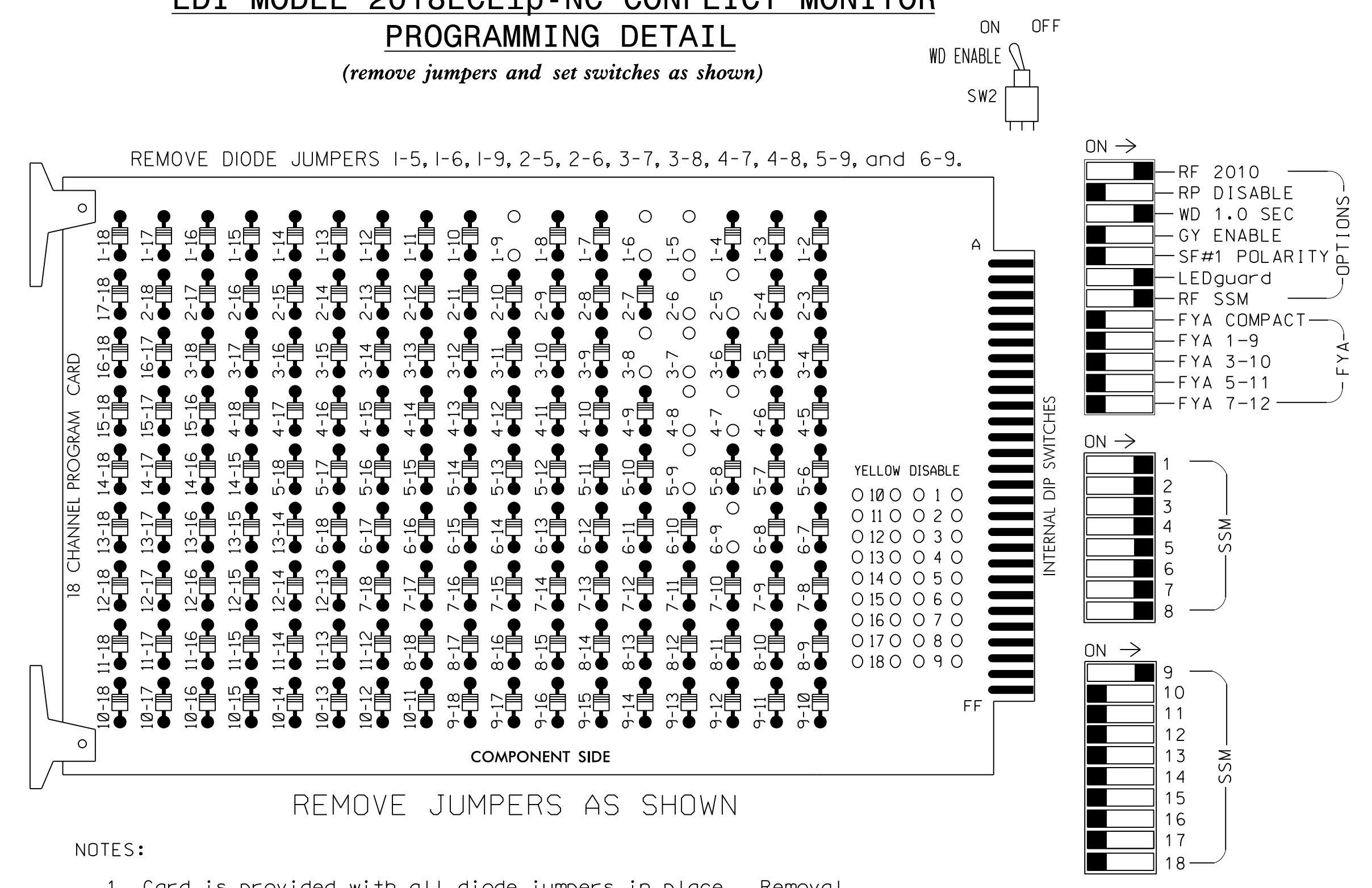

NOTES

- To prevent "flash-conflict" problems, insert red flash program blocks for all unused vehicle load switches in the output file. The installer shall verify that signal heads flash in accordance with the Signal Plans.
- Program controller to start up in Phase 2 Green and Phase 6 Green.
- The cabinet and controller are part of the Fayetteville Signal System.

SIGNAL HEAD HOOK-UP CHART

	S1	S2	S3	S4	S5	S6	S7	S8	S9	S10	S11	S12	AUX S1	AUX S2	AUX S3	AUX S4	AUX S5	AUX S6
CMU CHANNEL NO.	1	2	13	3	4	14	5	6	15	7	8	16	9	10	17	11	12	18
PHASE	1	2	2 PED	3	4	4 PED	5	6	6 PED	7	8	8 PED	OLA	OLB	SPARE	OLC	OLD	SPARE
SIGNAL HEAD NO.	11	21,22	NU	31,32	41,42	NU	51	61,62	NU	71	81,82	NU	82					
RED		128			101			134			107		*					
YELLOW		129			102			135			108							
GREEN		130			103			136			109							
RED ARROW	125			116			131			122								
YELLOW ARROW	126			117			132			123			A122					
GREEN ARROW	127			118			133			124			A123					

NU = Not Used

* Denotes install load resistor. See load resistor installation detail this sheet.

EQUIPMENT INFORMATION

CONTROLLER.....2070
 CABINET.....332 W/ AUX
 SOFTWARE.....ECONOLITE ASC/3-2070
 CABINET MOUNT.....BASE
 OUTPUT FILE POSITIONS...18 WITH AUX. OUTPUT FILE
 LOAD SWITCHES USED.....S1,S2,S4,S5,S7,S8,
 S10,S11,AUX S1
 PHASES USED.....1,2,3,4,5,6,7,8
 OVERLAP A.....1
 OVERLAP B.....NOT USED
 OVERLAP C.....NOT USED
 OVERLAP D.....NOT USED

ECONOLITE ASC/3-2070 OVERLAP PROGRAMMING DETAIL

(program controller as shown)

- From Main Menu select **2. CONTROLLER**
- From CONTROLLER Submenu select **2. VEHICLE OVERLAPS**

OVERLAP A

Select TMG VEH OVLP [A] and 'NORMAL'

TMG VEH OVLP...[A] TYPE:**NORMAL**

PHASES 1 2 3 4 5 6 7 8 9 0 1 2 3 4 5 6

INCLUDED X

LAG GRN 0.0 YEL 0.0 RED 0.0

END PROGRAMMING

THIS ELECTRICAL DETAIL IS FOR THE SIGNAL DESIGN: 06-0054T3
 DESIGNED: March 2018
 SEALED: 03-29-2018
 REVISED: N/A

INPUT FILE POSITION LAYOUT

(front view)

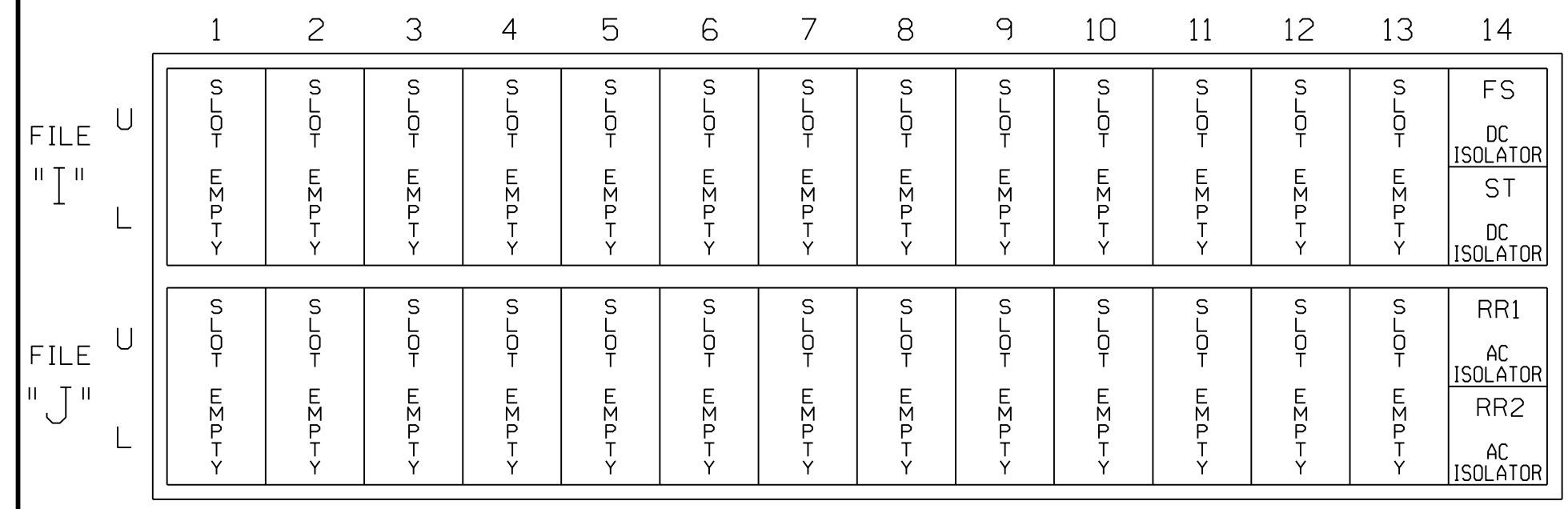

NOTE: The RR1 and RR2 preempt inputs have been remapped as detector inputs for use by the Logic Processor. See sheet 5 for details.

SPECIAL DETECTOR NOTE

Install a video detection system for vehicle detection. Perform installation according to manufacturer's directions and NCDOT engineer-approved mounting locations to accomplish the detection schemes shown on the Signal Design Plans.

AC ISOLATOR (MODEL 252) OUTPUT PROGRAMMING DETAIL

(set DIP switches as shown below)

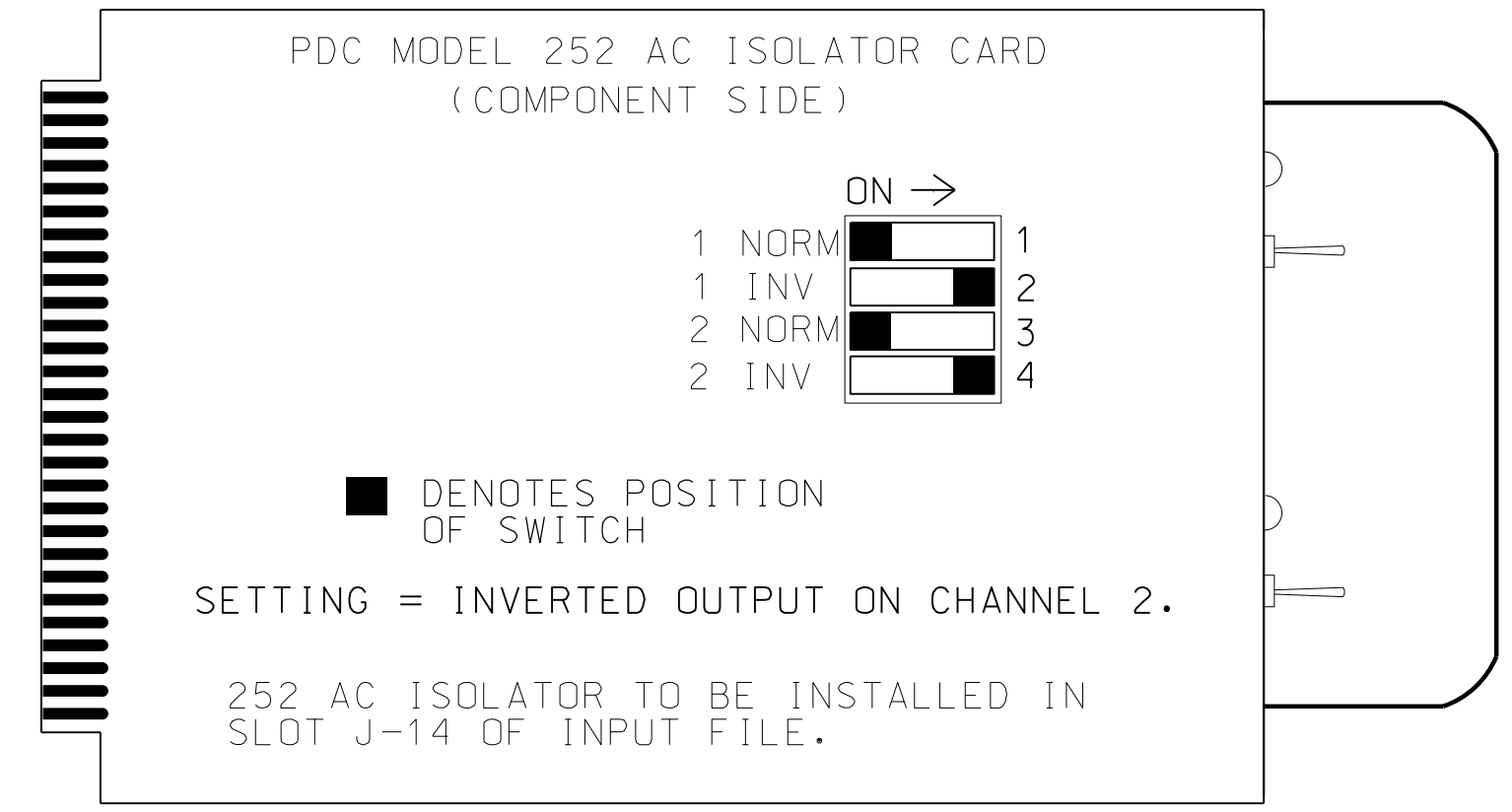

NOTE: IF ANOTHER MANUFACTURER TYPE OF AC ISOLATOR IS USED, OUTPUT PROGRAMMING IS LIKELY NOT TO EQUATE TO THAT SHOWN ABOVE.

LOAD RESISTOR INSTALLATION DETAIL

(install resistor as shown)

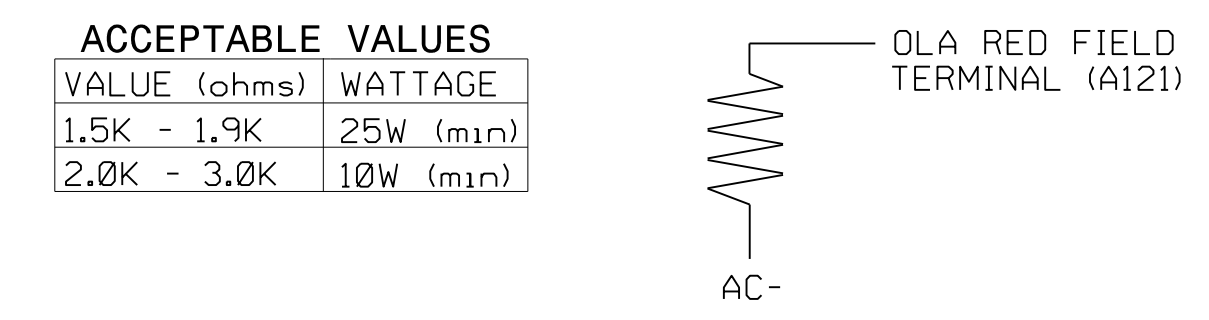

Temporary Design 3 - TMP Phase III Electrical Detail - Sheet 1 of 5

Stantec Consulting Services Inc.
 801 Jones Franklin Road-Suite 300
 Raleigh, NC 27606
 Tel. (919) 851-6866
 Fax. (919) 851-7024
 www.stantec.com
 License No. F-0672

Lawrence E. Overn
 Professional Engineer
 State of North Carolina
 License No. 045933

US 401 Business (Raeford Road)
 at
 McPherson Church Road/
 Owen Drive
 Division 6 Cumberland County Fayetteville

PLAN DATE: March 2018 REVIEWED BY: L Overn
 PREPARED BY: G B Spell REVIEWED BY:

REVISIONS	INIT.	DATE

SEAL
 NORTH CAROLINA
 PROFESSIONAL ENGINEER
 LAWRENCE E. OVERN
 License No. 045933
 DATE: 3/29/2018
 SIG. INVENTORY NO. 06-0054T3

RAILROAD PREEMPTION WIRING DETAIL FOR RR1 (LINKED RR PREEMPTS 1 & 2)

(wire as shown below)

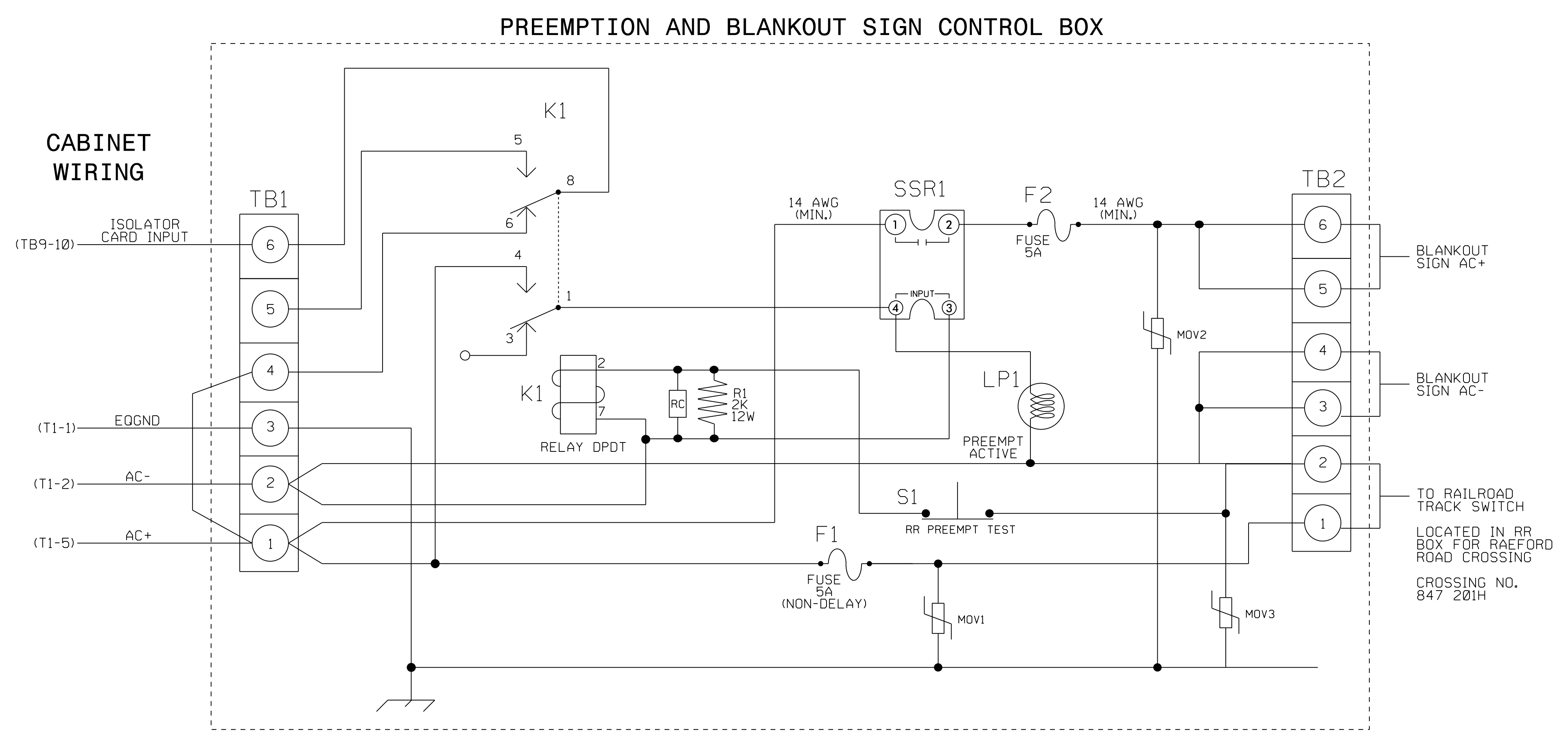

NOTES

1. Relay K1 is shown in the energized (Preempt not active) normal operation state.
2. Relay K1 is a DPDT with 120VAC coil with octal base.
3. Relay SSR1 is a SPST (normally open) Solid State Relay with AC input and AC (25 amp) output.
4. AC Isolator Card shall activate preemption upon removal of AC+ from the input (as shown above). To accomplish this set invert dip switch on AC Isolator card. See AC Isolator Output Programming Detail on Sheet 1.
5. IMPORTANT! A jumper must be added between input file terminals J4-E and J4-K if not already present. Also, terminal TB9-12 (on input panel) shall be connected to AC neutral (jumper may have to be added).

FRONT VIEW

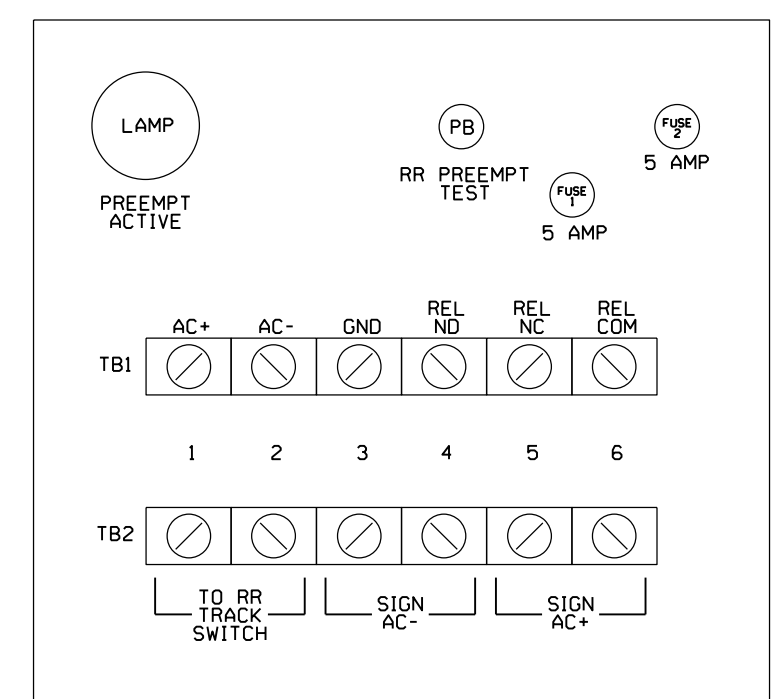

THIS ELECTRICAL DETAIL IS FOR
THE SIGNAL DESIGN: 06-0054T3
DESIGNED: March 2018
SEALED: 03-29-2018
REVISED: N/A

Temporary Design 3 - TMP Phase III
Electrical Detail - Sheet 2 of 5

Stantec Consulting Services Inc.
801 Jones Franklin Road-Suite 300
Raleigh, NC 27606
Tel. (919) 851-6866
Fax. (919) 851-7024
www.stantec.com
License No. F-0672

ELECTRICAL AND PROGRAMMING
DETAILS FOR:

Prepared in the Offices of:

750 N. Greenfield Pkwy, Garner, NC 27529

US 401 Business (Raeford Road)
at
McPherson Church Road/
Owen Drive
Division 6 Cumberland County Fayetteville

PLAN DATE: March 2018 REVIEWED BY: L Overn
PREPARED BY: G B Spell REVIEWED BY:

REVISIONS	INIT.	DATE

DOCUMENT NOT CONSIDERED FINAL
UNLESS ALL SIGNATURES COMPLETED

SEAL
NORTH CAROLINA
PROFESSIONAL
ENGINEER
LAWRENCE E. OVERN
045933
3/29/2018
DATE
SIG. INVENTORY NO. 06-0054T3

DATE: 03/29/2018 10:45:13 AM User: rfmancey

RAILROAD PREEMPTION WIRING DETAIL FOR RR2 (LINKED RR PREEMPTS 3 & 4)

(wire as shown below)

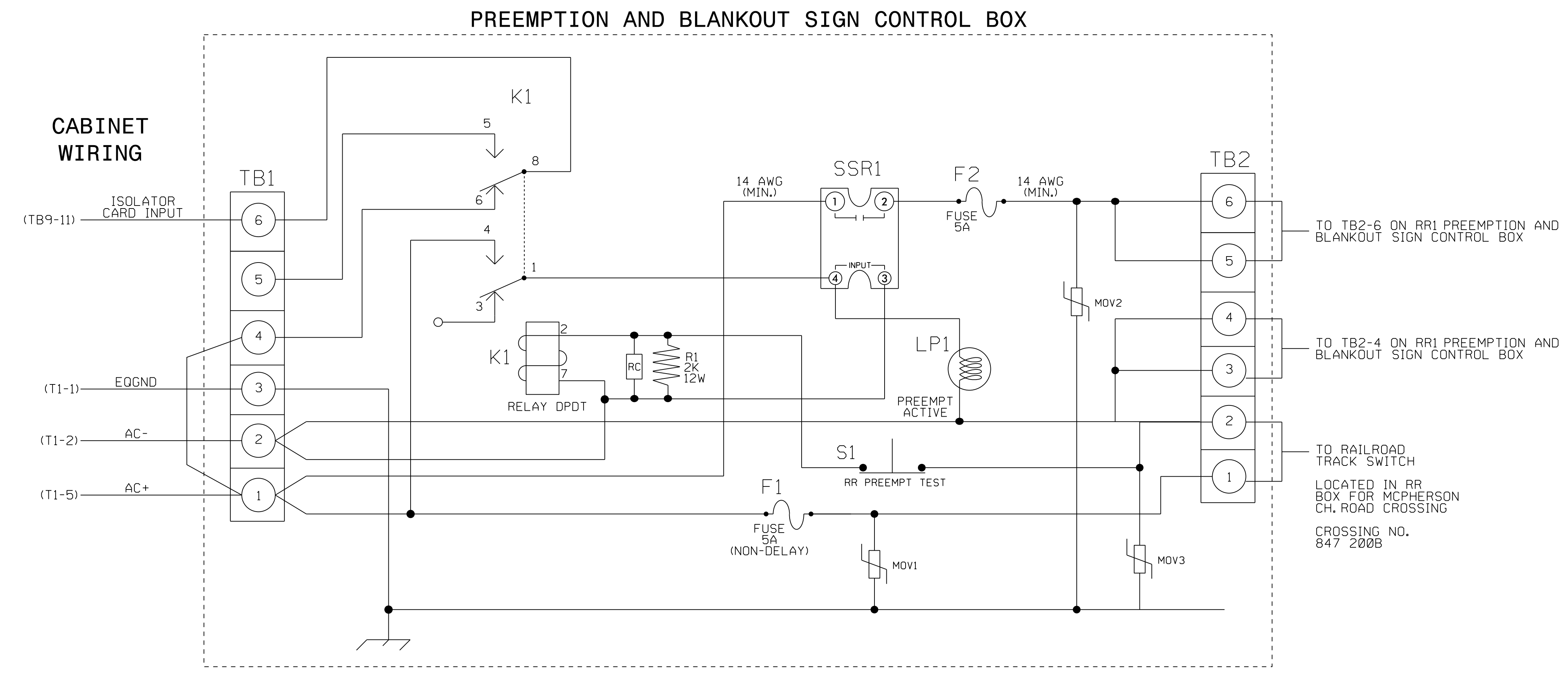

NOTES

1. Relay K1 is shown in the energized (Preempt not active) normal operation state.
2. Relay K1 is a DPDT with 120VAC coil with octabase.
3. Relay SSR1 is a SPST (normally open) Solid State Relay with AC input and AC (25 amp) output.
4. AC Isolator Card shall activate preemption upon removal of AC+ from the input (as shown above). To accomplish this set invert dip switch on AC Isolator Card. See AC Isolator Output Programming Detail on Sheet 1.

FRONT VIEW

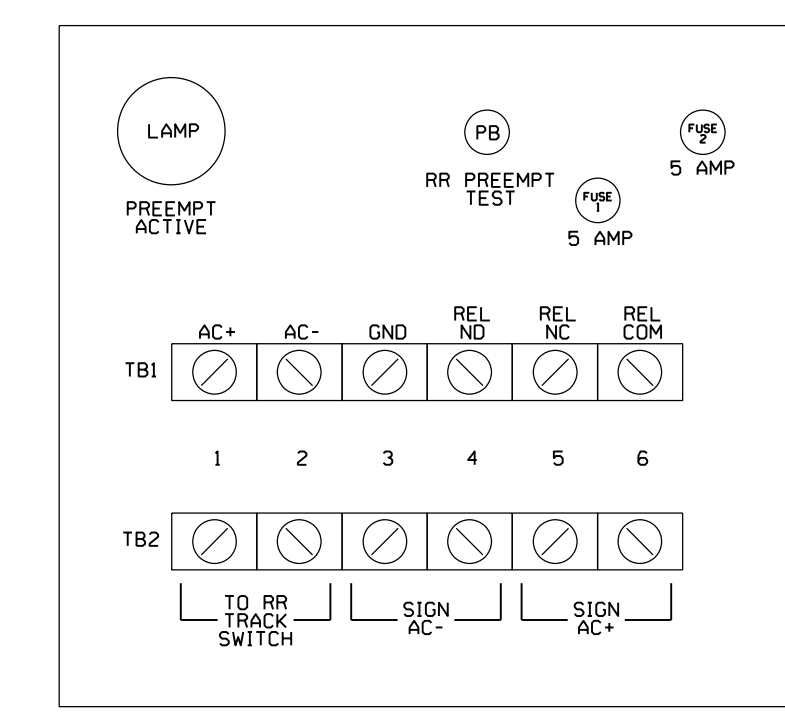

THIS ELECTRICAL DETAIL IS FOR THE SIGNAL DESIGN: 06-0054T3
DESIGNED: March 2018
SEALED: 03-29-2018
REVISED: N/A

Temporary Design 3 - TMP Phase III
Electrical Detail - Sheet 3 of 5

Stantec Consulting Services Inc.
801 Jones Franklin Road-Suite 300
Raleigh, NC 27606
Tel. (919) 851-6866
Fax. (919) 851-7024
www.stantec.com
License No. F-0672

Prepared in the Offices of:

750 N. Greenfield Pkwy, Garner, NC 27529

ELECTRICAL AND PROGRAMMING DETAILS FOR:		US 401 Business (Raeford Road) at McPherson Church Road/ Owen Drive	
Division 6 Cumberland County Fayetteville		Division 6 Cumberland County Fayetteville	
PLAN DATE: March 2018	REVIEWED BY: L Overn	PREPARED BY: G B Spell	REVIEWED BY:
REVISIONS		INIT.	DATE

DOCUMENT NOT CONSIDERED FINAL
UNLESS ALL SIGNATURES COMPLETED

SEAL

3/29/2018

DATE

SIG. INVENTORY NO. 06-0054T3

DATE: 03/29/2018 10:45:11 AM User: rfmancey

ECONOLITE ASC/3-2070 RAILROAD PREEMPT PROGRAMMING DETAIL

(program controller as shown)

- From Main Menu select **4. PREEMPTOR/TSP**
- From PREEMPTOR/TSP/SCP Submenu select **1. PREEMPT PLAN 1-10**

Place cursor in [] next to Preempt Plan and press 1. Then press the right cursor arrow and toggle the controller to YES. Next cursor down. This will select Railroad Preempt #1.

Place cursor in [] next to Preempt Plan and press 2. Then press the right cursor arrow and toggle the controller to YES. Next cursor down. This will select Railroad Preempt #2.

Place cursor in [] next to Preempt Plan and press 3. Then press the right cursor arrow and toggle the controller to YES. Next cursor down. This will select Railroad Preempt #3.

Place cursor in [] next to Preempt Plan and press 4. Then press the right cursor arrow and toggle the controller to YES. Next cursor down. This will select Railroad Preempt #4.

```

PREEMPT PLAN [ 1]  ENABLE....YES
VEH/PED 1 2 3 4 5 6 7 8 9 0 1 2 3 4 5 6
OVERLAP A B C D E F G H I J K L M N O P
TRKCLR V . . . X . . X . . . . . . . . . .
TRKCLR O . . . . . . . . . . . . . . . .
ENA TRL . . . . . . . . . . . . . . . .
DWEL VEH . . X . . . . . . . . . . . . . .
DWEL PED . . . . . . . . . . . . . . . .
DWEL OLP . . . . . . . . . . . . . . . .
CYC VEH . . . . . . . . . . . . . . . .
CYC PED . . . . . . . . . . . . . . . .
CYC OLP . . . . . . . . . . . . . . . .
EXIT PH . . . X . . . X . . . . . . . . . .
EXIT CAL . . . . . . . . . . . . . . . .
SP FUNC . . . . . . . . . . . . . . . .

ENABLE... YESIPMT OVRIDE..IINTERLOCK. NO
DET LOCK... .IDELAY.. 0IINHIBIT... 0
OVERIDE FL. .IDURATION 0ICLR-GRN... NO
TERM OLP. NOIPC>YEL NOITERM PH NO
PED DARK.. NOITC RESRV YESIDWELL FL OFF
LINK PMT...0IX FLCOLR REDIEXIT OPT. OFF
X TMG PLN...OIRE-SERV.. 0IFLT TYPE.HARD
FREE DUR PMTIR1 NOIR2 NOIR3 NOIR4 NO
--TIMING-----WALKIPED CLIMN GRI YELI RED
ENTRANCE TM. 255I 255I 1125.5125.5
-----MIN GRIEXT GRIMX GRI YELI RED
TRACK CLEAR 19I 0I 0I 4.6I 2.3
-----MIN DLIPMTEXTIMX TMI YELI RED
DWL/CYC-EXIT 7I 0.0I 0I25.5I25.5
PMT ACTIVE OUT..ON PMT ACT DWELL...NO
OTHER - PRI PMT.OFF NON-PRI PMT....OFF
INH EXT TIME... 0.0 PED PR RETURN...OFF
PRIORITY RETURN.OFF QUEUE DELAY.... OFF
COND DELAY.....OFF
PHASES 1 2 3 4 5 6 7 8
PR RTN% 0 0 0 0 0 0 0 0
PHASES 9 10 11 12 13 14 15 16
PR RTN% 0 0 0 0 0 0 0 0

```

```

PREEMPT PLAN [ 2]  ENABLE....YES
VEH/PED 1 2 3 4 5 6 7 8 9 0 1 2 3 4 5 6
OVERLAP A B C D E F G H I J K L M N O P
TRKCLR V X . . . . . X . . . . . . . . . .
TRKCLR O . . . . . . . . . . . . . . . .
ENA TRL . . . . . . . . . . . . . . . .
DWEL VEH . . X . . . . . . . . . . . . . .
DWEL PED . . . . . . . . . . . . . . . .
DWEL OLP . . . . . . . . . . . . . . . .
CYC VEH . . . . . . . . . . . . . . . .
CYC PED . . . . . . . . . . . . . . . .
CYC OLP . . . . . . . . . . . . . . . .
EXIT PH . . . X . . . X . . . . . . . . . .
EXIT CAL . . . . . . . . . . . . . . . .
SP FUNC . . . . . . . . . . . . . . . .

ENABLE... YESIPMT OVRIDE..IINTERLOCK. NO
DET LOCK... .IDELAY.. 0IINHIBIT... 0
OVERIDE FL. .IDURATION 0ICLR-GRN... NO
TERM OLP. NOIPC>YEL NOITERM PH NO
PED DARK.. NOITC RESRV YESIDWELL FL OFF
LINK PMT...1IX FLCOLR REDIEXIT OPT. OFF
X TMG PLN...OIRE-SERV.. 0IFLT TYPE.HARD
FREE DUR PMTIR1 NOIR2 NOIR3 NOIR4 NO
--TIMING-----WALKIPED CLIMN GRI YELI RED
ENTRANCE TM. 255I 255I 1125.5125.5
-----MIN GRIEXT GRIMX GRI YELI RED
TRACK CLEAR 35I 0I 0I 3.8I 2.5
-----MIN DLIPMTEXTIMX TMI YELI RED
DWL/CYC-EXIT 0I 0.0I 0I25.5I25.5
PMT ACTIVE OUT..ON PMT ACT DWELL...NO
OTHER - PRI PMT.OFF NON-PRI PMT....OFF
INH EXT TIME... 0.0 PED PR RETURN...OFF
PRIORITY RETURN.OFF QUEUE DELAY.... OFF
COND DELAY.....OFF
PHASES 1 2 3 4 5 6 7 8
PR RTN% 0 0 0 0 0 0 0 0
PHASES 9 10 11 12 13 14 15 16
PR RTN% 0 0 0 0 0 0 0 0

```

```

PREEMPT PLAN [ 3]  ENABLE....YES
VEH/PED 1 2 3 4 5 6 7 8 9 0 1 2 3 4 5 6
OVERLAP A B C D E F G H I J K L M N O P
TRKCLR V X . . . . . X . . . . . . . . . .
TRKCLR O . . . . . . . . . . . . . . . .
ENA TRL . . . . . . . . . . . . . . . .
DWEL VEH . . X . . . . . . . . . . . . . .
DWEL PED . . . . . . . . . . . . . . . .
DWEL OLP . . . . . . . . . . . . . . . .
CYC VEH . . . . . . . . . . . . . . . .
CYC PED . . . . . . . . . . . . . . . .
CYC OLP . . . . . . . . . . . . . . . .
EXIT PH . . . X . . . X . . . . . . . . . .
EXIT CAL . . . . . . . . . . . . . . . .
SP FUNC . . . . . . . . . . . . . . . .

ENABLE... YESIPMT OVRIDE..IINTERLOCK. NO
DET LOCK... .IDELAY.. 0IINHIBIT... 0
OVERIDE FL. .IDURATION 0ICLR-GRN... NO
TERM OLP. NOIPC>YEL NOITERM PH NO
PED DARK.. NOITC RESRV YESIDWELL FL OFF
LINK PMT...0IX FLCOLR REDIEXIT OPT. OFF
X TMG PLN...OIRE-SERV.. 0IFLT TYPE.HARD
FREE DUR PMTIR1 NOIR2 NOIR3 NOIR4 NO
--TIMING-----WALKIPED CLIMN GRI YELI RED
ENTRANCE TM. 255I 255I 1125.5125.5
-----MIN GRIEXT GRIMX GRI YELI RED
TRACK CLEAR 35I 0I 0I 3.8I 2.5
-----MIN DLIPMTEXTIMX TMI YELI RED
DWL/CYC-EXIT 7I 0.0I 0I25.5I25.5
PMT ACTIVE OUT..ON PMT ACT DWELL...NO
OTHER - PRI PMT.OFF NON-PRI PMT....OFF
INH EXT TIME... 0.0 PED PR RETURN...OFF
PRIORITY RETURN.OFF QUEUE DELAY.... OFF
COND DELAY.....OFF
PHASES 1 2 3 4 5 6 7 8
PR RTN% 0 0 0 0 0 0 0 0
PHASES 9 10 11 12 13 14 15 16
PR RTN% 0 0 0 0 0 0 0 0

```

```

PREEMPT PLAN [ 4]  ENABLE....YES
VEH/PED 1 2 3 4 5 6 7 8 9 0 1 2 3 4 5 6
OVERLAP A B C D E F G H I J K L M N O P
TRKCLR V . . . X . . X . . . . . . . . . .
TRKCLR O . . . . . . . . . . . . . . . .
ENA TRL . . . . . . . . . . . . . . . .
DWEL VEH . . X . . . . . . . . . . . . . .
DWEL PED . . . . . . . . . . . . . . . .
DWEL OLP . . . . . . . . . . . . . . . .
CYC VEH . . . . . . . . . . . . . . . .
CYC PED . . . . . . . . . . . . . . . .
CYC OLP . . . . . . . . . . . . . . . .
EXIT PH . . . X . . . X . . . . . . . . . .
EXIT CAL . . . . . . . . . . . . . . . .
SP FUNC . . . . . . . . . . . . . . . .

ENABLE... YESIPMT OVRIDE..IINTERLOCK. NO
DET LOCK... .IDELAY.. 0IINHIBIT... 0
OVERIDE FL. .IDURATION 0ICLR-GRN... NO
TERM OLP. NOIPC>YEL NOITERM PH NO
PED DARK.. NOITC RESRV YESIDWELL FL OFF
LINK PMT...3IX FLCOLR REDIEXIT OPT. OFF
X TMG PLN...OIRE-SERV.. 0IFLT TYPE.HARD
FREE DUR PMTIR1 NOIR2 NOIR3 NOIR4 NO
--TIMING-----WALKIPED CLIMN GRI YELI RED
ENTRANCE TM. 255I 255I 1125.5125.5
-----MIN GRIEXT GRIMX GRI YELI RED
TRACK CLEAR 19I 0I 0I 4.6I 2.3
-----MIN DLIPMTEXTIMX TMI YELI RED
DWL/CYC-EXIT 0I 0.0I 0I25.5I25.5
PMT ACTIVE OUT..ON PMT ACT DWELL...NO
OTHER - PRI PMT.OFF NON-PRI PMT....OFF
INH EXT TIME... 0.0 PED PR RETURN...OFF
PRIORITY RETURN.OFF QUEUE DELAY.... OFF
COND DELAY.....OFF
PHASES 1 2 3 4 5 6 7 8
PR RTN% 0 0 0 0 0 0 0 0
PHASES 9 10 11 12 13 14 15 16
PR RTN% 0 0 0 0 0 0 0 0

```

NOTICE LINK PMT 1 →

NOTICE LINK PMT 3 →

Linked preempts 1 and 2 make up preempt RR1

Linked preempts 3 and 4 make up preempt RR2

ECONOLITE ASC/3-2070 PREEMPT FILTERING

- From Main Menu select **4. PREEMPTOR/TSP**
- From PREEMPTOR/TSP/SCP Submenu select **2. ENABLE PREEMPT FILTERING & TSP/SCP**
- Ensure all preempt entries are set to BYPASSED for both SOLID and PULSING.

THIS ELECTRICAL DETAIL IS FOR THE SIGNAL DESIGN: 06-0054T3
DESIGNED: March 2018
SEALED: 03-29-2018
REVISED: N/A



Stantec Consulting Services Inc.
801 Jones Franklin Road-Suite 300
Raleigh, NC 27606
Tel. (919) 851-6866
Fax. (919) 851-7024
www.stantec.com
License No. F-0672

ELECTRICAL AND PROGRAMMING DETAILS FOR:

Prepared in the Offices of:

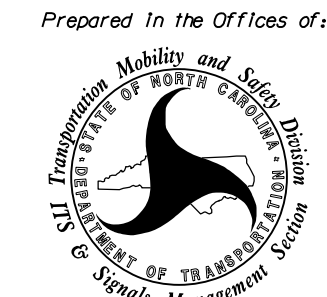

750 N. Greenfield Pkwy, Garner, NC 27529

US 401 Business (Raeford Road)
at
McPherson Church Road/
Owen Drive
Division 6 Cumberland County Fayetteville

PLAN DATE: March 2018 REVIEWED BY: L Overn
PREPARED BY: G B Spell REVIEWED BY:

REVISIONS	INIT.	DATE

DOCUMENT NOT CONSIDERED FINAL UNLESS ALL SIGNATURES COMPLETED

SEAL
NORTH CAROLINA PROFESSIONAL ENGINEER
SEAL 045933
LAWRENCE E. OVERN
3/29/2018
DATE
SIG. INVENTORY NO. 06-0054T3

DATE: 03/29/2018 10:05:13 AM
USER: rfmancey

ECONOLITE ASC/3-2070 LOGIC PROCESSOR PROGRAMMING DETAIL

(program controller as shown)

- From Main Menu select **1. CONFIGURATION**
- From CONFIGURATION Submenu select **8. LOGIC PROCESSOR**
- From LOGIC PROCESSOR Submenu select **2. LOGIC STATEMENTS**

ENTER A "1" IN THE LP# FIELD, PRESS 'ENTER', AND PROGRAM AS SHOWN.

```

LP#:  1 COPY FROM:  1 ACTIVE:  M
IF   DET              52 IS ON

THEN LP SET LOGIC FLAG  1      ON

ELSE
    
```

IF RR1 PREEMPT (REMAPPED AS DET 52) INPUT IS ACTIVE, SET LOGIC FLAG 1 ON.

ENTER A "2" IN THE LP# FIELD, PRESS 'ENTER', AND PROGRAM AS SHOWN.

```

LP#:  2 COPY FROM:  2 ACTIVE:  M
IF   LP FLAG          1      IS ON

THEN PMT CALL PMT SEQ  2      ON

ELSE
    
```

IF LOGIC FLAG 1 IS ON, THEN INITIATE PREEMPT 2 SEQUENCE. THE PREEMPT MAY OR MAY NOT ACTUALLY BE SERVED DEPENDING ON THE STATE OF THE OTHER RR PREEMPT INPUT.

ENTER A "3" IN THE LP# FIELD, PRESS 'ENTER', AND PROGRAM AS SHOWN.

```

LP#:  3 COPY FROM:  3 ACTIVE:  M
IF   DET              54 IS ON

THEN LP SET LOGIC FLAG  2      ON

ELSE
    
```

IF RR2 PREEMPT (REMAPPED AS DET 54) INPUT IS ACTIVE, SET LOGIC FLAG 2 ON.

ENTER A "4" IN THE LP# FIELD, PRESS 'ENTER', AND PROGRAM AS SHOWN.

```

LP#:  4 COPY FROM:  4 ACTIVE:  M
IF   LP FLAG          2      IS ON

THEN PMT CALL PMT SEQ  4      ON

ELSE
    
```

IF LOGIC FLAG 2 IS ON, THEN INITIATE PREEMPT 4 SEQUENCE. THE PREEMPT MAY OR MAY NOT ACTUALLY BE SERVED DEPENDING ON THE STATE OF THE OTHER RR PREEMPT INPUT.

ENTER A "5" IN THE LP# FIELD, PRESS 'ENTER', AND PROGRAM AS SHOWN.

```

LP#:  5 COPY FROM:  5 ACTIVE:  M
IF   DET              52 IS OFF
AND  DET              54 IS OFF

THEN LP SET LOGIC FLAG  1      OFF
THEN LP SET LOGIC FLAG  2      OFF

ELSE
    
```

WHEN BOTH PREEMPT INPUTS GO INACTIVE, THIS LOGIC RESETS THE LOGIC FLAG THAT IS HOLDING THE ACTIVE PREEMPT ACTIVE, AND RESETS THE OTHER LOGIC FLAG TO PREVENT IT FROM CALLING THE OTHER PREEMPT.

END PROGRAMMING

- From Main Menu select **1. CONFIGURATION**
- From CONFIGURATION Submenu select **8. LOGIC PROCESSOR**
- From LOGIC PROCESSOR Submenu select **1. LOGIC STATEMENT CONTROL**

ENABLE LOGIC PROCESSOR STATEMENTS 1-5 BY POSITIONING THE CURSOR OVER THE FIELDS SHOWN BELOW AND USING THE TOGGLE KEY TO ENABLE THEM.

LOGIC STATEMENT CONTROL	
	1 2 3 4 5 6 7 8 9 0 1 2 3 4 5
LP 1-15	E E E E E
LP 16-30
LP 31-45
LP 46-60
LP 61-75
LP 76-90

END PROGRAMMING

ECONOLITE ASC/3-2070 I/O PIN REMAPPING FOR RR1 AND RR2 PREEMPT INPUTS

The ASC/3 Configurator utility program must be used to remap the I/O pins as shown below. Consult the ASC/3 Configurator User Guide for specific instructions on software use.

- Run the Configurator utility. Load a file as the Current DB.
- Choose the C1-in tab to change the I/O mapping as needed. Use the drop down list within the program to select the assigned function for the pins shown below.
- Save the database file and download it to the controller.

C1	DEFAULT	ASSIGNED FUNCTION
PIN #	FUNCTION	

PIN 51-PREEMPT 1 CALL	→	DETECTOR 52	▼
PIN 52-PREEMPT 2 CALL	→	DETECTOR 54	▼

NOTE: PREEMPT INPUTS REMAPPED AS DETECTORS

NOTE: The steps below can be used to view changes to I/O pins within the controller. Any I/O pins that have been remapped will display and show their default function in addition to the current assigned function.

- From Main Menu select **7. STATUS DISPLAY**
- From STATUS DISPLAY Submenu select **8. INPUTS/OUTPUTS**
- From INPUT/OUTPUT Submenu select **9. I/O DIFFERENCES**

ECONOLITE ASC/3-2070 VEHICLE DETECTOR SETUP PROGRAMMING DETAIL FOR REMAPPED DETECTORS

(program controller as shown)

The preempt inputs remapped as detectors that are to be used by the logic processor are assigned to a dummy phase 9 as shown in the detector setup programming below.

- From Main Menu select **6. DETECTORS**
- From DETECTOR Submenu select **2. VEHICLE DETECTOR SETUP**

- Place cursor in VEH DETECTOR [] position and enter "52".

	VEH DETECTOR [52]	VEH DET PLAN [1]			
	TYPE: S-STANDARD				
DISABLE TS2 DETECTOR →	TS2 DETECTOR.....	ECPI LOG.....	NO		
ASSIGN PHASE 9 →	DET PH - 1 2 3 4 5 6 7 8 9 0 1 2 3 4 5 6				
	52 9				
	EXTEND TIME... 0.0	DELAY TIME... 0.0			
	USE ADDED INITIAL .	CROSS SWITCH PH.. 0			
	LOCK IN.....	NONE NTCIP VOL . OR OCC .			
	PMT QUEUE DELAY. NO				

- Place cursor in VEH DETECTOR [] position and enter "54".

	VEH DETECTOR [54]	VEH DET PLAN [1]			
	TYPE: S-STANDARD				
DISABLE TS2 DETECTOR →	TS2 DETECTOR.....	ECPI LOG.....	NO		
ASSIGN PHASE 9 →	DET PH - 1 2 3 4 5 6 7 8 9 0 1 2 3 4 5 6				
	54 9				
	EXTEND TIME... 0.0	DELAY TIME... 0.0			
	USE ADDED INITIAL .	CROSS SWITCH PH.. 0			
	LOCK IN.....	NONE NTCIP VOL . OR OCC .			
	PMT QUEUE DELAY. NO				

END PROGRAMMING

THIS ELECTRICAL DETAIL IS FOR THE SIGNAL DESIGN: 06-0054T3
DESIGNED: March 2018
SEALED: 03-29-2018
REVISED: N/A

Temporary Design 3 - TMP Phase III
Electrical Detail - Sheet 5 of 5

DOCUMENT NOT CONSIDERED FINAL
UNLESS ALL SIGNATURES COMPLETED

 Stantec Consulting Services Inc. 801 Jones Franklin Road-Suite 300 Raleigh, NC 27606 Tel. (919) 851-6866 Fax. (919) 851-7024 www.stantec.com License No. F-0672	Prepared in the Offices of: Mobility and Safety Division NORTH CAROLINA PROFESSIONAL ENGINEERS LAWRENCE E. OVERN 750 N. Greenfield Pkwy, Garner, NC 27529	US 401 Business (Raeford Road) at McPherson Church Road/ Owen Drive Division 6 Cumberland County Fayetteville PLAN DATE: March 2018 REVIEWED BY: L Overn PREPARED BY: G B Spell REVIEWED BY:	SEAL 3/29/2018 DATE SIG. INVENTORY NO. 06-0054T3
REVISIONS _____ INIT. DATE		DATE	

DATE: U:\Projects\Signal\Signal\Temp\Phase 3\U-4405.sig\ele_06-0054T3.dgn User: rmlunicy

PHASING DIAGRAM

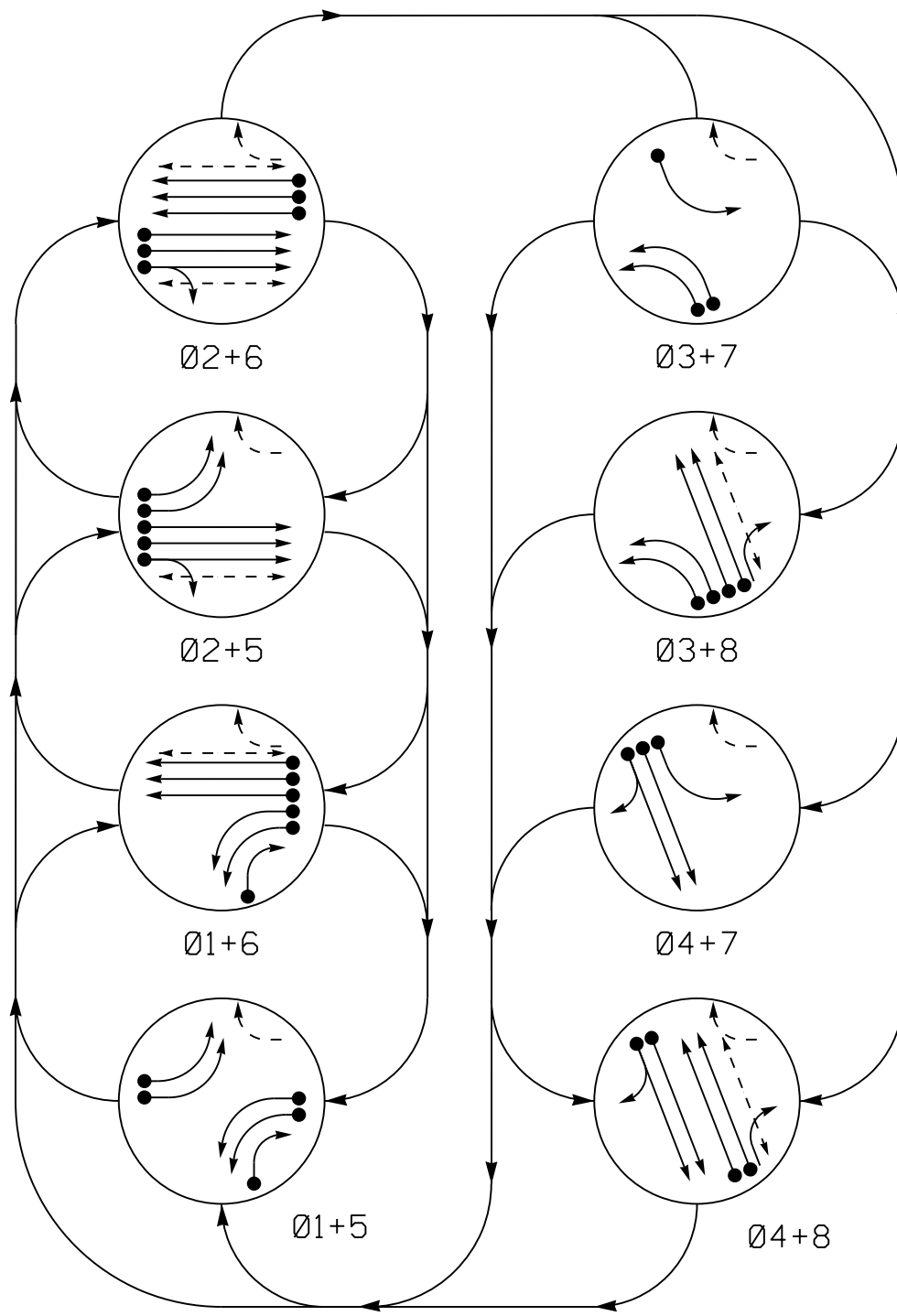

RAIL PREEMPT PHASES
(High Priority)

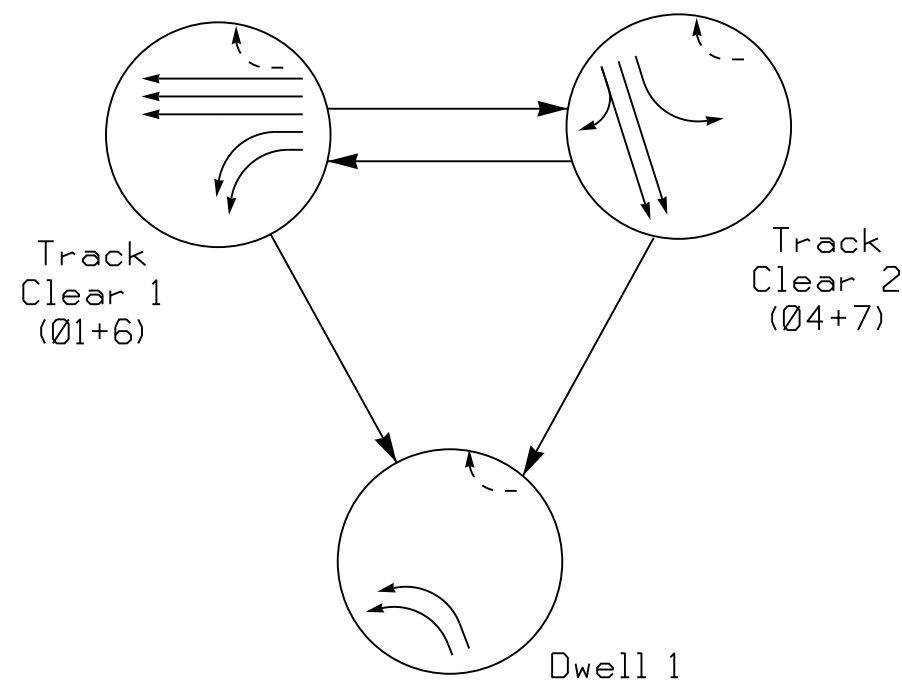

PHASING DIAGRAM DETECTION LEGEND

- DETECTED MOVEMENT
- ◀ UNDETECTED MOVEMENT (OVERLAP)
- UNSIGNALIZED MOVEMENT
- ◀ --- PEDESTRIAN MOVEMENT

SIGNAL FACE I.D.

All Heads L.E.D.

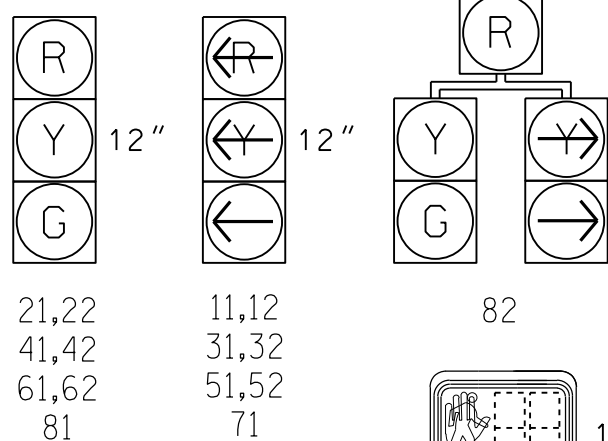

TABLE OF OPERATION

SIGNAL FACE	PHASE											
	01+5	01+6	02+5	02+6	03+7	03+8	04+7	04+8	01+5	01+6	04+7	04+8
11,12	←	←	←	←	←	←	←	←	←	←	←	←
21,22	R	R	G	G	R	R	R	R	R	R	R	Y
31,32	←	←	←	←	←	←	←	←	←	←	←	←
41,42	R	R	R	R	G	G	R	G	R	R	R	R
51,52	←	←	←	←	←	←	←	←	←	←	←	←
61,62	R	G	R	G	R	R	R	R	G	R	R	Y
71	←	←	←	←	←	←	←	←	←	←	←	←
81	R	R	R	R	R	G	R	G	R	R	R	R
82	R	R	R	R	R	G	R	G	R	R	R	R
P21,P22	DW	DW	W	W	DW	DW	DW	DW	DW	DRK	DRK	DRK
P61,P62	DW	W	DW	W	DW	DW	DW	DW	DW	DRK	DRK	DRK
P81,P82	DW	DW	DW	DW	DW	W	DW	W	DW	DW	DRK	DRK
Sign (A)	OFF	OFF	OFF	OFF	OFF	OFF	OFF	OFF	ON	ON	ON	*

* See Note 8

ASC/3 DETECTOR INSTALLATION CHART

LOOP	SIZE (FT)	DISTANCE FROM STOPBAR (FT)	TURNS	NEW LOOP	PROGRAMMING							
					PHASE	CALLING	EXTEND TIME	DELAY TIME	USE ADDED INITIAL	TYPE	SYSTEM LOOP	NEW CARD
1A	6X40	0	2-4-2	X	1	Yes	-	-	-	S	-	X
1B	6X40	0	2-4-2	X	1	Yes	-	-	-	S	-	X
1C	6X40	0	2-4-2	X	1	Yes	-	15	-	S	-	X
2A	6X6	70	5	X	2	Yes	-	-	-	S	-	X
2B	6X6	70	5	X	2	Yes	-	-	-	S	-	X
2C	6X6	70	5	X	2	Yes	-	-	-	S	-	X
3A	6X40	0	2-4-2	X	3	Yes	-	3	-	S	-	X
3B	6X40	0	2-4-2	X	3	Yes	-	-	-	S	-	X
4A	6X6	0	4	X	4	Yes	-	-	-	S	-	X
4B	6X6	0	4	X	4	Yes	-	10	-	S	-	X
4C	6X15	0	2-4-2	X	4	Yes	-	15	-	S	-	X
5A	6X40	0	2-4-2	X	5	Yes	-	-	-	S	-	X
5B	6X40	0	2-4-2	X	5	Yes	-	-	-	S	-	X
6A	6X6	70	3	X	6	Yes	-	-	-	S	-	X
6B	6X6	70	3	X	6	Yes	-	-	-	S	-	X
6C	6X6	70	3	X	6	Yes	-	-	-	S	-	X
7A	6X40	0	2-4-2	X	7	Yes	-	3	-	S	-	X
8A	6X6	0	4	X	8	Yes	-	-	-	S	-	X
8B	6X6	0	4	X	8	Yes	-	-	-	S	-	X

8 Phase Fully Actuated w/ Railroad Preemption Fayetteville Signal System

NOTES

- Refer to "Roadway Standard Drawings NCDOT" dated January 2018 and "Standard Specifications for Roads and Structures" dated January 2018.
- This location contains railroad preemption phasing. Do not program signal for late night flashing operation.
- Phase 1 and/or Phase 5 may be lagged.
- Phase 3 and/or Phase 7 may be lagged.
- Set all detector units to presence mode.
- Omit "WALK" and flashing "DON'T WALK" with no pedestrian calls.
- Program pedestrian heads to countdown the flashing "DON'T WALK" time only.
- Ensure flashing operation does not alter operation of blankout signs.
- Maximum times shown in timing chart are for free-run operation only. Coordinated signal system timing values supersede these values.
- Pedestrian pedestals are conceptual and shown for reference only. See 2018 NCDOT Roadway Standard Drawings 1705.04 Sheets 1-3 for push button location details.
- Directional clearance shall be provided during preemption to allow crossing closest to approaching train to clear first. Sequence 1 shall clear crossing 847 201H (Raeford Road) first. Sequence 2 shall clear crossing 847 200B (McPherson Church Road) first.

ASC/3 RR PREEMPT

FUNCTION	SEQUENCE 1	SEQUENCE 2
Exit Phase(s)	4,8	4,8
Preempt Override	OFF	OFF
Delay Time	0	0
Ped Clear Trough Yellow	Y	Y
Terminate Phases	N	N
Track Clear Reserve	Y	Y
Entrance Walk	1	1
Entrance Ped Clear	3.0	3.0
Entrance Min Green	1	1
Entrance Yellow Change	25.5*	25.5*
Entrance Red Clear	25.5*	25.5*
Track Clear Min Green 1	35	19
Track Clear Yellow Change 1	3.8	4.6
Track Clear Red Clear 1	2.5	2.3
Track Clear Min Green 2	19	35
Track Clear Yellow Change 2	4.6	3.8
Track Clear Red Clear 2	2.3	2.5
Min Dwell Time	7	7
Exit Yellow Change	25.5*	25.5*
Exit Red Clear	25.5*	25.5*

* Time defaults to time used for phase during normal operation.

ASC/3 TIMING CHART

FEATURE	PHASE							
	1	2	3	4	5	6	7	8
Min Green *	7	10	7	7	7	10	7	7
Walk *	-	10	-	-	-	10	-	7
Ped Clear	-	28	-	-	-	30	-	28
Veh. Extension *	2.0	3.0	2.0	2.0	2.0	3.0	2.0	2.0
Max I *	15	45	15	25	15	45	15	25
Yellow	3.0	3.9	3.0	4.6	3.0	3.8	3.0	4.3
Red Clear	3.3	2.8	3.9	2.2	3.3	2.2	3.9	2.0
Red Revert	-	-	-	-	-	-	-	-
Actuations B4 Add *	-	-	-	-	-	-	-	-
Seconds /Actuation *	-	-	-	-	-	-	-	-
Max Initial *	-	-	-	-	-	-	-	-
Time Before Reduction *	-	-	-	-	-	-	-	-
Time To Reduce *	-	-	-	-	-	-	-	-
Minimum Gap	-	-	-	-	-	-	-	-
Locking Detector	-	X	-	-	-	X	-	-
Recall Position	-	VEH. RECALL	-	-	-	VEH. RECALL	-	-
Dual Entry	-	-	-	-	-	-	-	-
Simultaneous Gap	X	X	X	X	X	X	X	X

* These values may be field adjusted. Do not adjust Min Green and Extension times for phases 2 and 6 lower than what is shown. Min Green for all other phases should not be lower than 4 seconds.

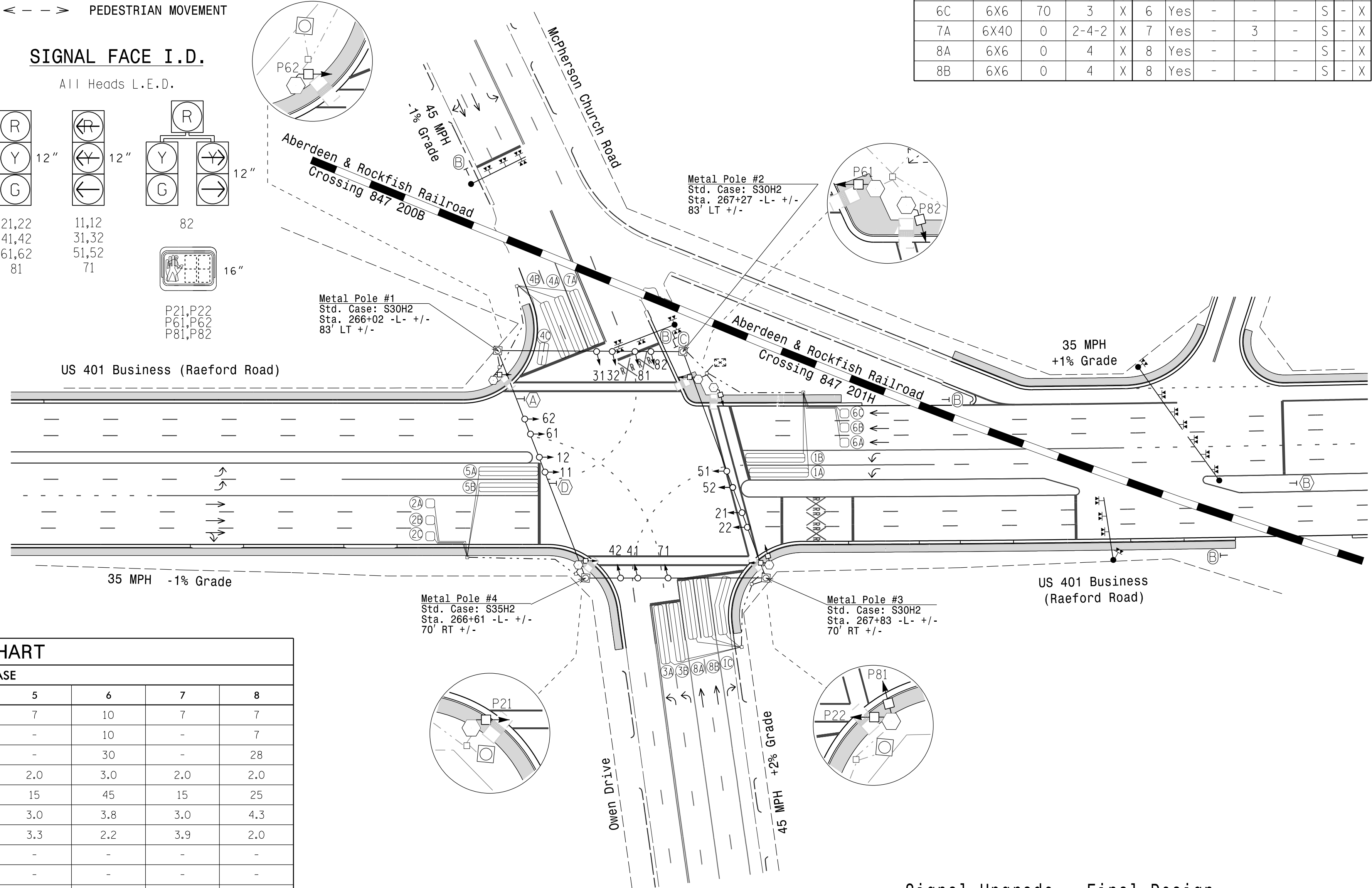

LEGEND

PROPOSED	EXISTING
○ → Traffic Signal Head	● → N/A
○ → Modified Signal Head	○ → N/A
○ → Pedestrian Signal Head With Push Button & Sign	○ → N/A
○ → Signal Pole with Guy	○ → N/A
○ → Signal Pole with Sidewalk Guy	○ → N/A
○ → Inductive Loop Detector	○ → N/A
○ → Controller & Cabinet	○ → N/A
○ → Junction Box	○ → N/A
○ → 2-in Underground Conduit	○ → N/A
○ → Right of Way	○ → N/A
○ → Directional Arrow	○ → N/A
○ → Metal Strain Pole	○ → N/A
○ → Railroad Cantilever	○ → N/A
○ → Railroad Tracks	○ → N/A
○ → Type II Signal Pedestal	○ → N/A
○ → "NO RIGHT TURN - TRAIN" L.E.D. Blankout Sign	○ → N/A
○ → "DO NOT STOP ON TRACKS" Sign (R8-8)	○ → N/A
○ → "Stop Here on Red" Sign (R10-6)	○ → N/A
○ → "U-TURN YIELD TO RIGHT TURN" Sign (R10-16)	○ → N/A

This signal is designed for simultaneous preemption

Signal Upgrade - Final Design

<p>Stantec Consulting Services Inc. 801 Jones Franklin Road-Suite 300 Raleigh, NC 27606 Tel. (919) 851-6866 Fax. (919) 851-7024 www.stantec.com License No. F-0672</p>		<p>US 401 Business (Raeford Road) at McPherson Church Road/ Owen Drive</p>	
		<p>Division 6 Cumberland County Fayetteville</p> <p>PLAN DATE: March 2018 REVIEWED BY: E D Harris</p> <p>PREPARED BY: G B Spell REVIEWED BY: B L Watson</p>	<p>3/29/2018</p> <p>DATE</p>

3/29/2018
 U:\Projects\4405\SIG\4405_SIG_06-0054_Final.dgn
 User: rfmancey

DOCUMENT NOT CONSIDERED FINAL UNLESS ALL SIGNATURES COMPLETED

SIG. INVENTORY NO. 06-0054

EDI MODEL 2018ECLIP-NC CONFLICT MONITOR PROGRAMMING DETAIL

(remove jumpers and set switches as shown)

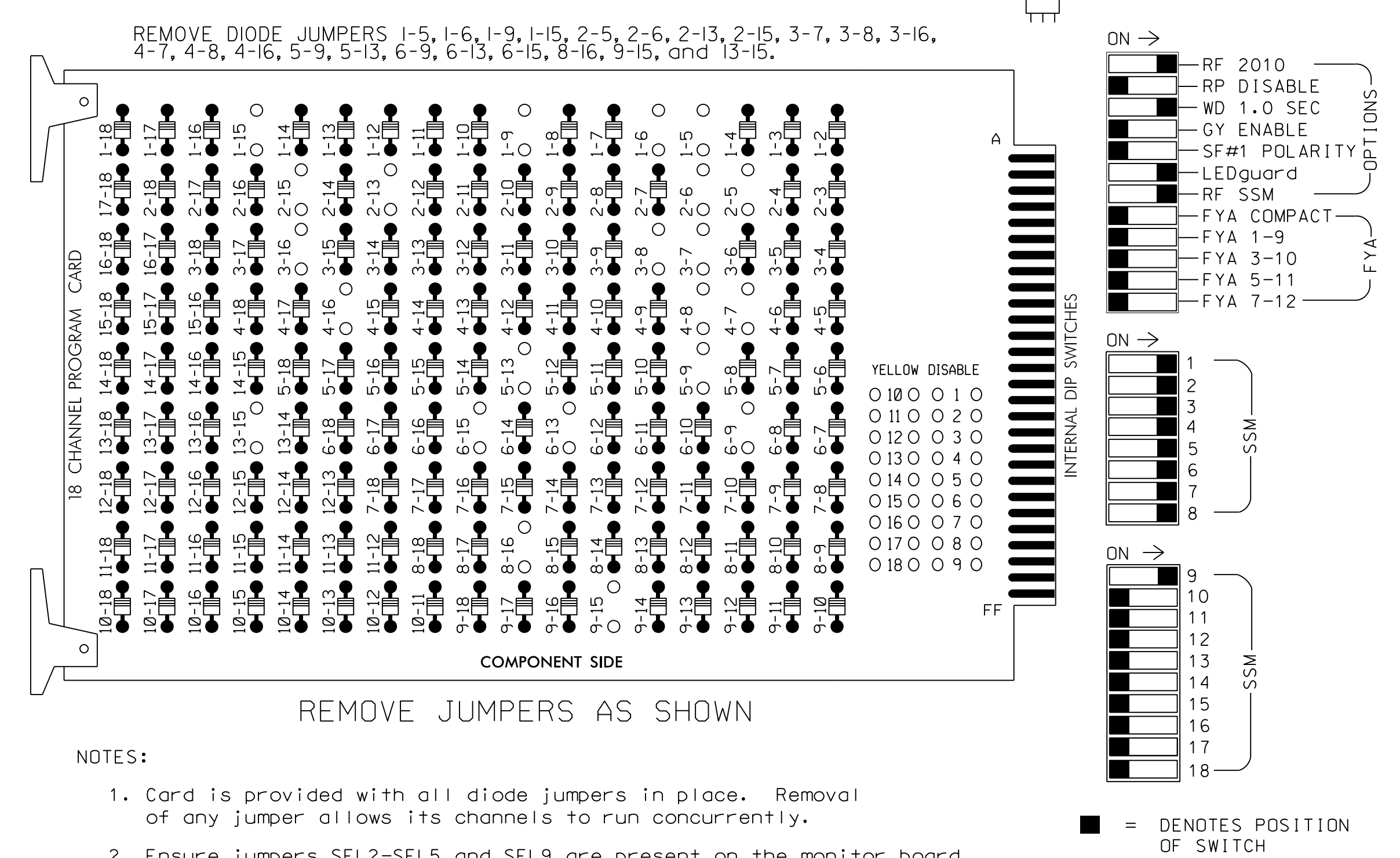

NOTES

- To prevent "flash-conflict" problems, insert red flash program blocks for all unused vehicle load switches in the output file. The installer shall verify that signal heads flash in accordance with the Signal Plans.
- Program controller to start up in Phase 2 Walk and Phase 6 Walk.
- The cabinet and controller are part of the Fayetteville Signal System.

EQUIPMENT INFORMATION

CONTROLLER.....2070
 CABINET.....332 W/ AUX
 SOFTWARE.....ECONOLITE ASC/3-2070
 CABINET MOUNT.....BASE
 OUTPUT FILE POSITIONS...18 WITH AUX. OUTPUT FILE
 LOAD SWITCHES USED.....S1,S2,S3,S4,S5,S7,S8,S9,
 S10,S11,S12,AUX S1
 PHASES USED.....1,2,2PED,3,4,5,6,6PED,7,
 8,8PED

OVERLAP A.....5
 OVERLAP B.....NOT USED
 OVERLAP C.....NOT USED
 OVERLAP D.....NOT USED

SIGNAL HEAD HOOK-UP CHART

LOAD SWITCH NO.	S1	S2	S3	S4	S5	S6	S7	S8	S9	S10	S11	S12	AUX S1	AUX S2	AUX S3	AUX S4	AUX S5	AUX S6
CHU CHANNEL NO.	1	2	13	3	4	14	5	6	15	7	8	16	9	10	17	11	12	18
PHASE	1	2	2 PED	3	4	4 PED	5	6	6 PED	7	8	8 PED	OLA	OLB	SPARE	OLC	OLD	SPARE
SIGNAL HEAD NO.	11,12	21,22	P21, P22	31,32	41,42	NU	51,52	61,62	P61, P62	71	81,82	P81, P82	82	NU	NU	NU	NU	NU
RED		128			101			134			107		*					
YELLOW		129			102			135			108							
GREEN		130			103			136			109							
RED ARROW	125				116			131			122							
YELLOW ARROW	126				117			132			123		A122					
GREEN ARROW	127				118			133			124		A123					
Hand					113						119		110					
Walking Person					115						121		112					

NU = Not Used
 * Denotes install load resistor. See load resistor installation detail this sheet.

INPUT FILE POSITION LAYOUT

(front view)

FILE "I"	1	2	3	4	5	6	7	8	9	10	11	12	13	14
U	∅ 1	∅ 1	∅ 2	∅ 2	∅ 3	∅ 3	∅ 4	∅ 4	S	S	S	∅ 2 PED	∅ 6 PED	FS
L	1A	1C	2A	2C	3A	3B	4A	4C	-	-	-	DC ISOLATOR	DC ISOLATOR	DC ISOLATOR
U	∅ 1	NOT USED	∅ 2	NOT USED	NOT USED	NOT USED	∅ 4	NOT USED	∅ 5	∅ 6	∅ 6	∅ 7	∅ 8	RR1
L	1B	2B	3B	4B	5A	6A	6C	7A	8A	8B	8C	RR2	RR2	RR2
U	∅ 5	∅ 6	NOT USED	NOT USED	∅ 8	∅ 8	∅ 8	∅ 8	∅ 8	∅ 8	∅ 8	∅ 8	∅ 8	RR2
L	5B	6B	7B	8B	9B	10B	11B	12B	13B	14B	15B	16B	17B	RR2

EX. : 1A, 2A, ETC. = LOOP NO.'S

FS = FLASH SENSE
 ST = STOP TIME
 RR1,RR2 = RAILROAD PREEMPTS

NOTE: The RR1 and RR2 preempt inputs have been remapped as detector inputs for use by the Logic Processor. See sheet 5 for details.

INPUT FILE CONNECTION & PROGRAMMING CHART

LOOP NO.	LOOP TERMINAL	INPUT FILE POS.	PIN NO.	DETECTOR NO.	NEMA PHASE	CALL	EXTEND TIME	DELAY TIME	ADDED INITIAL	DETECTOR TYPE
1A	TB2-1,2	I1U	56	1	1	YES				S
1B	TB2-3,4	I1L	56	1	1	YES				S
1C	TB2-5,6	I2U	39	2	1	YES		15		S
2A	TB2-9,10	I3U	63	32	2	YES				S
2B	TB2-11,12	I3L	76	42	2	YES				S
2C	TB4-1,2	I4U	47	22	2	YES				S
3A	TB4-5,6	I5U	58	3	3	YES		3		S
3B	TB4-9,10	I6U	41	4	3	YES				S
4A	TB6-1,2	I7U	65	34	4	YES				S
4B	TB6-3,4	I7L	78	44	4	YES		10		S
4C	TB6-5,6	I8U	49	24	4	YES		15		S
5A	TB3-1,2	J1U	55	5	5	YES				S
5B	TB3-3,4	J1L	55	5	5	YES				S
6A	TB3-5,6	J2U	40	6	6	YES				S
6B	TB3-7,8	J2L	44	16	6	YES				S
6C	TB3-9,10	J3U	64	36	6	YES				S
7A	TB5-5,6	J5U	57	7	7	YES		3		S
8A	TB5-9,10	J6U	42	8	8	YES				S
8B	TB5-11,12	J6L	46	18	8	YES				S
PED PUSH BUTTONS										
P21,P22	TB8-4,6	I12U	67	PED 2	2 PED					
P61,P62	TB8-7,9	I13U	68	PED 6	6 PED					
P81,P82	TB8-8,9	I13L	70	PED 8	8 PED					

NOTE: INSTALL DC ISOLATORS IN INPUT FILE SLOTS I12 AND I13.

INPUT FILE POSITION LEGEND: J2L

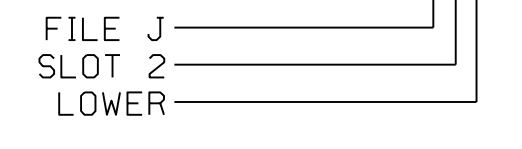

LOAD RESISTOR INSTALLATION DETAIL

(install resistor as shown)

ACCEPTABLE VALUES

VALUE (ohms)	WATTAGE
1.5K - 1.9K	25W (min)
2.0K - 3.0K	10W (min)

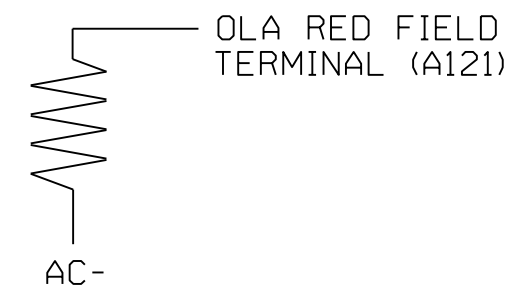

COUNTDOWN PEDESTRIAN SIGNAL OPERATION

Countdown Ped Signals are required to display timing only during Ped Clearance Interval. Consult Ped Signal Module user's manual for instructions on selecting this feature.

THIS ELECTRICAL DETAIL IS FOR THE SIGNAL DESIGN: 06-0054
 DESIGNED: March 2018
 SEALED: 03-29-2018
 REVISED: N/A

Final Design
 Electrical Detail - Sheet 1 of 6

Stantec Consulting Services Inc.
 801 Jones Franklin Road-Suite 300
 Raleigh, NC 27606
 Tel. (919) 851-6866
 Fax. (919) 851-7024
 www.stantec.com
 License No. F-0672

Prepared in the Offices of:

750 N. Greenfield Pkwy, Garner, NC 27529

US 401 Business (Raeford Road)
 at
 McPherson Church Road/
 Owen Drive
 Division 6 Cumberland County Fayetteville

PLAN DATE: March 2018 REVIEWED BY: L Overn
 PREPARED BY: G B Spell REVIEWED BY:

REVISIONS	INIT.	DATE

DOCUMENT NOT CONSIDERED FINAL UNLESS ALL SIGNATURES COMPLETED

SEAL
 NORTH CAROLINA PROFESSIONAL ENGINEER
 LAWRENCE E. OVERN
 045933
 3/29/2018
 DATE
 SIG. INVENTORY NO. 06-0054

RAILROAD PREEMPTION WIRING DETAIL FOR RR1 (LINKED RR PREEMPTS 1 & 2)

(wire as shown below)

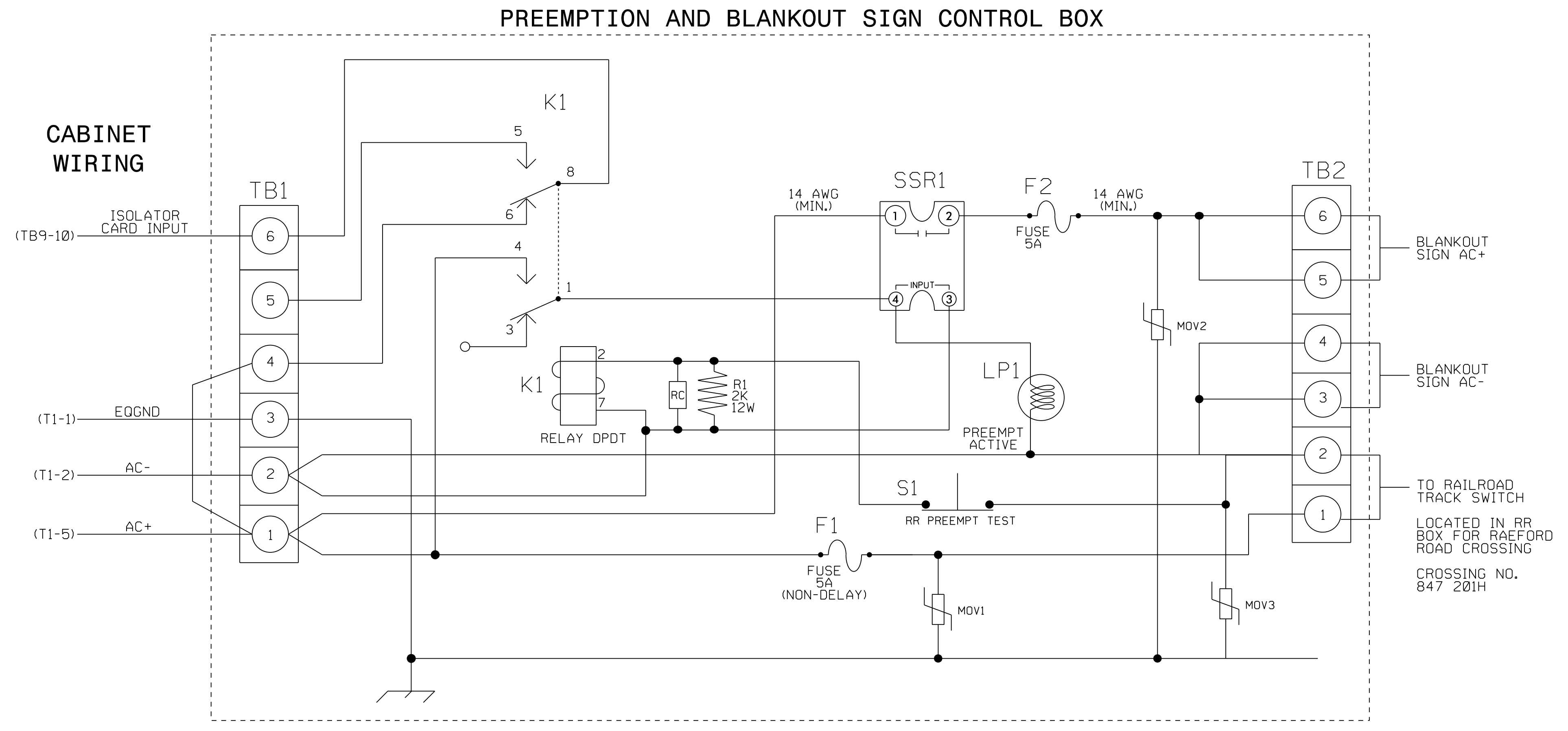

NOTES

1. Relay K1 is shown in the energized (Preempt not active) normal operation state.
2. Relay K1 is a DPDT with 120VAC coil with octal base.
3. Relay SSR1 is a SPST (normally open) Solid State Relay with AC input and AC (25 amp) output.
4. AC Isolator Card shall activate preemption upon removal of AC+ from the input (as shown above). To accomplish this set invert dip switch on AC Isolator card. See AC Isolator Output Programming Detail on Sheet 6.
5. IMPORTANT! A jumper must be added between input file terminals J4-E and J4-K if not already present. Also, terminal TB9-12 (on input panel) shall be connected to AC neutral (jumper may have to be added).

FRONT VIEW

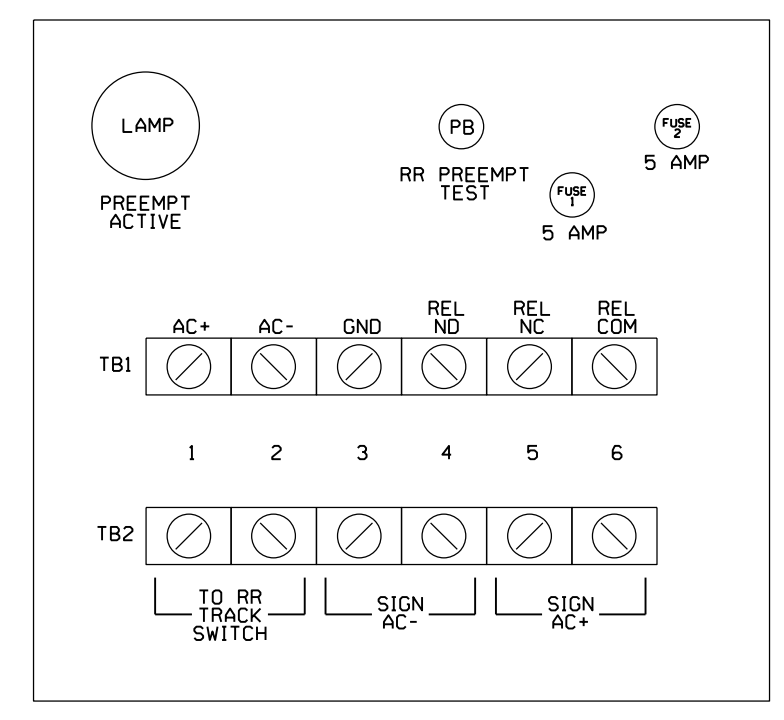

THIS ELECTRICAL DETAIL IS FOR
THE SIGNAL DESIGN: 06-0054
DESIGNED: March 2018
SEALED: 03-29-2018
REVISED: N/A

Final Design
Electrical Detail - Sheet 2 of 6

Stantec Consulting Services Inc.
801 Jones Franklin Road-Suite 300
Raleigh, NC 27606
Tel. (919) 851-6866
Fax. (919) 851-7024
www.stantec.com
License No. F-0672

ELECTRICAL AND PROGRAMMING
DETAILS FOR:

Prepared in the Offices of:

750 N. Greenfield Pkwy, Garner, NC 27529

US 401 Business (Raeford Road)
at
McPherson Church Road/
Owen Drive
Division 6 Cumberland County Fayetteville

PLAN DATE: March 2018 REVIEWED BY: L Overn
PREPARED BY: G B Spell REVIEWED BY:

REVISIONS	INIT.	DATE

DOCUMENT NOT CONSIDERED FINAL
UNLESS ALL SIGNATURES COMPLETED

SEAL
NORTH CAROLINA
PROFESSIONAL
ENGINEER
LAWRENCE E. OVERN
045933
3/29/2018
DATE
SIG. INVENTORY NO. 06-0054

DATE: 03/29/2018 11:45:11 AM User: rfmancey

RAILROAD PREEMPTION WIRING DETAIL FOR RR2 (LINKED RR PREEMPTS 3 & 4)

(wire as shown below)

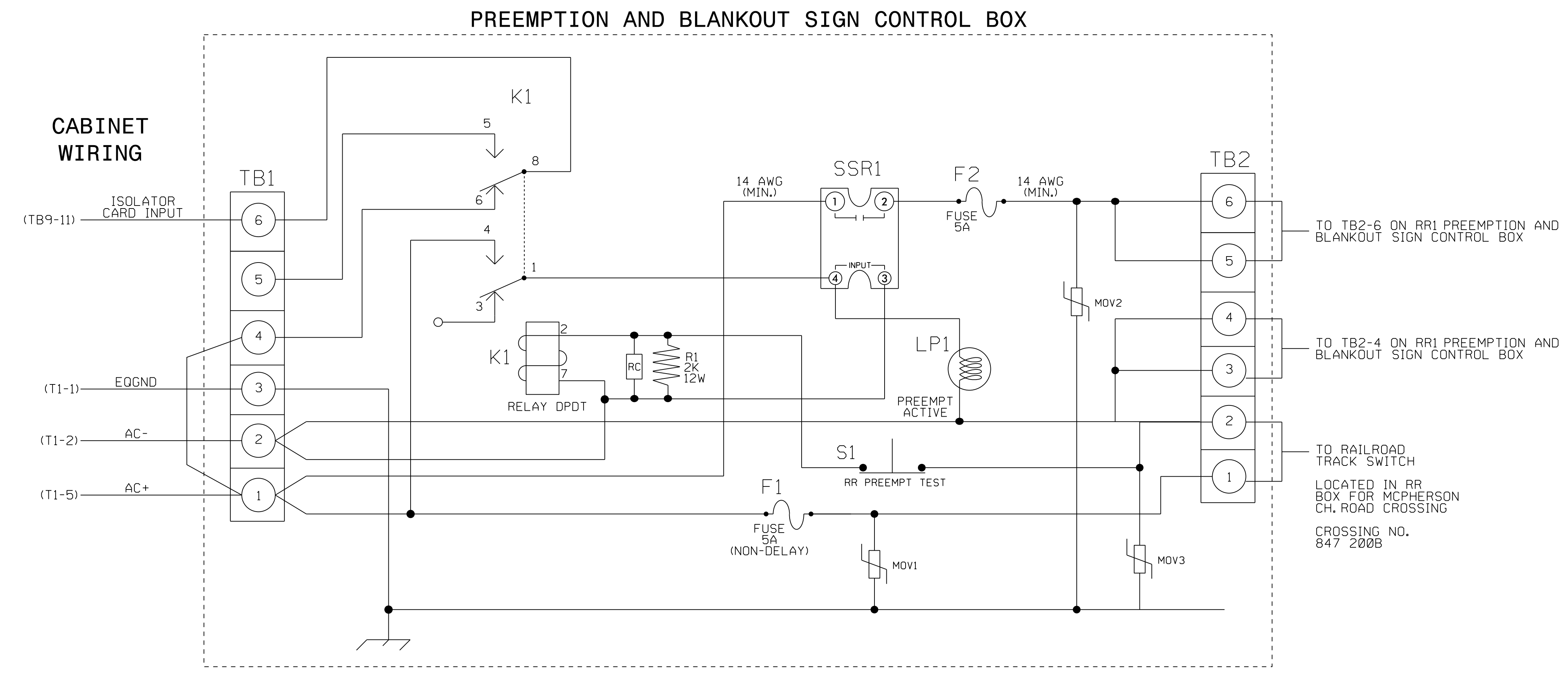

NOTES

1. Relay K1 is shown in the energized (Preempt and active) normal operation state.
2. Relay K1 is a DPDT with 120VAC coil with octabase.
3. Relay SSR1 is a SPST (normally open) Solid State Relay with AC input and AC (25 amp) output.
4. AC Isolator Card shall activate preemption upon removal of AC+ from the input (as shown above). To accomplish this set invert dip switch on AC Isolator Card. See AC Isolator Output Programming Detail on Sheet 6.

FRONT VIEW

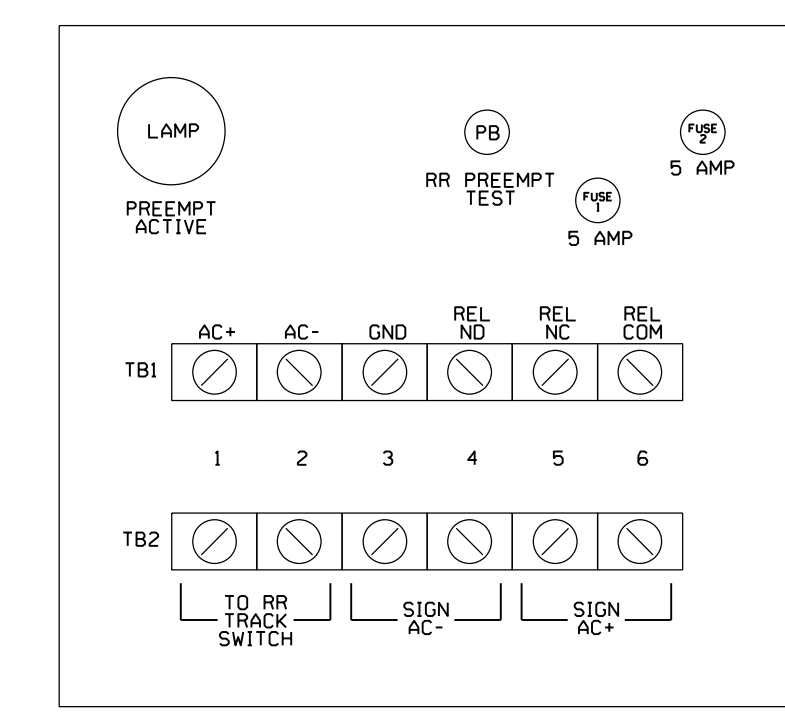

THIS ELECTRICAL DETAIL IS FOR THE SIGNAL DESIGN: 06-0054
DESIGNED: March 2018
SEALED: 03-29-2018
REVISED: N/A

Final Design
Electrical Detail - Sheet 3 of 6

Stantec Consulting Services Inc.
801 Jones Franklin Road-Suite 300
Raleigh, NC 27606
Tel. (919) 851-6866
Fax. (919) 851-7024
www.stantec.com
License No. F-0672

ELECTRICAL AND PROGRAMMING
DETAILS FOR:

Prepared in the Offices of:

750 N. Greenfield Pkwy, Garner, NC 27529

US 401 Business (Raeford Road)
at
McPherson Church Road/
Owen Drive
Division 6 Cumberland County Fayetteville

PLAN DATE: March 2018 REVIEWED BY: L Overn
PREPARED BY: G B Spell REVIEWED BY:

REVISIONS	INIT.	DATE

SEAL
NORTH CAROLINA
PROFESSIONAL
ENGINEER
LAWRENCE E. OVERN
045933

3/29/2018
DATE

SIG. INVENTORY NO. 06-0054

DATE: 03/29/2018 11:00:00 AM User: rfmancey

ECONOLITE ASC/3-2070 RAILROAD PREEMPT PROGRAMMING DETAIL

(program controller as shown)

- 1. From Main Menu select **4. PREEMPTOR/TSP**
- 2. From PREEMPTOR/TSP/SCP Submenu select **1. PREEMPT PLAN 1-10**

Place cursor in [] next to Preempt Plan and press 1. Then press the right cursor arrow and toggle the controller to YES. Next cursor down. This will select Railroad Preempt #1.

Place cursor in [] next to Preempt Plan and press 2. Then press the right cursor arrow and toggle the controller to YES. Next cursor down. This will select Railroad Preempt #2.

Place cursor in [] next to Preempt Plan and press 3. Then press the right cursor arrow and toggle the controller to YES. Next cursor down. This will select Railroad Preempt #3.

Place cursor in [] next to Preempt Plan and press 4. Then press the right cursor arrow and toggle the controller to YES. Next cursor down. This will select Railroad Preempt #4.

```

PREEMPT PLAN [ 1]  ENABLE....YES
VEH/PED 1 2 3 4 5 6 7 8 9 0 1 2 3 4 5 6
OVERLAP A B C D E F G H I J K L M N O P
TRKCLR V . . . X . . X . . . . . . . . . .
TRKCLR O . . . . . . . . . . . . . . . . .
ENA TRL . . . . . . . . . . . . . . . . .
DWEL VEH . . X . . . . . . . . . . . . . .
DWEL PED . . . . . . . . . . . . . . . . .
DWEL OLP . . . . . . . . . . . . . . . . .
CYC VEH . . . . . . . . . . . . . . . . .
CYC PED . . . . . . . . . . . . . . . . .
CYC OLP . . . . . . . . . . . . . . . . .
EXIT PH . . . X . . . X . . . . . . . . . .
EXIT CAL . . . . . . . . . . . . . . . . .
SP FUNC . . . . . . . . . . . . . . . . .

ENABLE... YESIPMT OVRIDE..IINTERLOCK. NO
DET LOCK... .IDELAY.. 0IINHIBIT... 0
OVERRIDE FL. .IDURATION 0ICLR-GRN... NO
TERM OLP. NOIPC>YEL YESITERM PH NO
PED DARK.. NOITC RESRV YESIDWELL FL OFF
LINK PMT...0IX FLCOLR REDIEXIT OPT. OFF
X TMG PLN...OIRE-SERV.. 0IFLT TYPE.HARD
FREE DUR PMTIR1 NOIR2 NOIR3 NOIR4 NO
--TIMING-----WALKIPED CLIMN GRI YELI RED
ENTRANCE TM. 11 3.01 1125.5125.5
-----MIN GRIEXT GRIMX GRI YELI RED
TRACK CLEAR 191 01 01 4.61 2.3
-----MIN DLIPMTEXTIMX TMI YELI RED
DWL/CYC-EXIT 71 0.01 0125.5125.5
PMT ACTIVE OUT..ON PMT ACT DWELL...NO
OTHER - PRI PMT.OFF NON-PRI PMT....OFF
INH EXT TIME... 0.0 PED PR RETURN...OFF
PRIORITY RETURN.OFF QUEUE DELAY.... OFF
COND DELAY.....OFF
PHASES 1 2 3 4 5 6 7 8
PR RTN% 0 0 0 0 0 0 0 0
PHASES 9 10 11 12 13 14 15 16
PR RTN% 0 0 0 0 0 0 0 0

```

```

PREEMPT PLAN [ 2]  ENABLE....YES
VEH/PED 1 2 3 4 5 6 7 8 9 0 1 2 3 4 5 6
OVERLAP A B C D E F G H I J K L M N O P
TRKCLR V X . . . . . X . . . . . . . . . .
TRKCLR O . . . . . . . . . . . . . . . . .
ENA TRL . . . . . . . . . . . . . . . . .
DWEL VEH . . X . . . . . . . . . . . . . .
DWEL PED . . . . . . . . . . . . . . . . .
DWEL OLP . . . . . . . . . . . . . . . . .
CYC VEH . . . . . . . . . . . . . . . . .
CYC PED . . . . . . . . . . . . . . . . .
CYC OLP . . . . . . . . . . . . . . . . .
EXIT PH . . . X . . . X . . . . . . . . . .
EXIT CAL . . . . . . . . . . . . . . . . .
SP FUNC . . . . . . . . . . . . . . . . .

ENABLE... YESIPMT OVRIDE..IINTERLOCK. NO
DET LOCK... .IDELAY.. 0IINHIBIT... 0
OVERRIDE FL. .IDURATION 0ICLR-GRN... NO
TERM OLP. NOIPC>YEL NOITERM PH NO
PED DARK.. NOITC RESRV YESIDWELL FL OFF
LINK PMT...1IX FLCOLR REDIEXIT OPT. OFF
X TMG PLN...OIRE-SERV.. 0IFLT TYPE.HARD
FREE DUR PMTIR1 NOIR2 NOIR3 NOIR4 NO
--TIMING-----WALKIPED CLIMN GRI YELI RED
ENTRANCE TM. 2551 2551 1125.5125.5
-----MIN GRIEXT GRIMX GRI YELI RED
TRACK CLEAR 351 01 01 3.81 2.5
-----MIN DLIPMTEXTIMX TMI YELI RED
DWL/CYC-EXIT 01 0.01 0125.5125.5
PMT ACTIVE OUT..ON PMT ACT DWELL...NO
OTHER - PRI PMT.OFF NON-PRI PMT....OFF
INH EXT TIME... 0.0 PED PR RETURN...OFF
PRIORITY RETURN.OFF QUEUE DELAY.... OFF
COND DELAY.....OFF
PHASES 1 2 3 4 5 6 7 8
PR RTN% 0 0 0 0 0 0 0 0
PHASES 9 10 11 12 13 14 15 16
PR RTN% 0 0 0 0 0 0 0 0

```

```

PREEMPT PLAN [ 3]  ENABLE....YES
VEH/PED 1 2 3 4 5 6 7 8 9 0 1 2 3 4 5 6
OVERLAP A B C D E F G H I J K L M N O P
TRKCLR V X . . . . . X . . . . . . . . . .
TRKCLR O . . . . . . . . . . . . . . . . .
ENA TRL . . . . . . . . . . . . . . . . .
DWEL VEH . . X . . . . . . . . . . . . . .
DWEL PED . . . . . . . . . . . . . . . . .
DWEL OLP . . . . . . . . . . . . . . . . .
CYC VEH . . . . . . . . . . . . . . . . .
CYC PED . . . . . . . . . . . . . . . . .
CYC OLP . . . . . . . . . . . . . . . . .
EXIT PH . . . X . . . X . . . . . . . . . .
EXIT CAL . . . . . . . . . . . . . . . . .
SP FUNC . . . . . . . . . . . . . . . . .

ENABLE... YESIPMT OVRIDE..IINTERLOCK. NO
DET LOCK... .IDELAY.. 0IINHIBIT... 0
OVERRIDE FL. .IDURATION 0ICLR-GRN... NO
TERM OLP. NOIPC>YEL YESITERM PH NO
PED DARK.. NOITC RESRV YESIDWELL FL OFF
LINK PMT...0IX FLCOLR REDIEXIT OPT. OFF
X TMG PLN...OIRE-SERV.. 0IFLT TYPE.HARD
FREE DUR PMTIR1 NOIR2 NOIR3 NOIR4 NO
--TIMING-----WALKIPED CLIMN GRI YELI RED
ENTRANCE TM. 11 3.01 1125.5125.5
-----MIN GRIEXT GRIMX GRI YELI RED
TRACK CLEAR 351 01 01 3.81 2.5
-----MIN DLIPMTEXTIMX TMI YELI RED
DWL/CYC-EXIT 71 0.01 0125.5125.5
PMT ACTIVE OUT..ON PMT ACT DWELL...NO
OTHER - PRI PMT.OFF NON-PRI PMT....OFF
INH EXT TIME... 0.0 PED PR RETURN...OFF
PRIORITY RETURN.OFF QUEUE DELAY.... OFF
COND DELAY.....OFF
PHASES 1 2 3 4 5 6 7 8
PR RTN% 0 0 0 0 0 0 0 0
PHASES 9 10 11 12 13 14 15 16
PR RTN% 0 0 0 0 0 0 0 0

```

```

PREEMPT PLAN [ 4]  ENABLE....YES
VEH/PED 1 2 3 4 5 6 7 8 9 0 1 2 3 4 5 6
OVERLAP A B C D E F G H I J K L M N O P
TRKCLR V . . . X . . X . . . . . . . . . .
TRKCLR O . . . . . . . . . . . . . . . . .
ENA TRL . . . . . . . . . . . . . . . . .
DWEL VEH . . X . . . . . . . . . . . . . .
DWEL PED . . . . . . . . . . . . . . . . .
DWEL OLP . . . . . . . . . . . . . . . . .
CYC VEH . . . . . . . . . . . . . . . . .
CYC PED . . . . . . . . . . . . . . . . .
CYC OLP . . . . . . . . . . . . . . . . .
EXIT PH . . . X . . . X . . . . . . . . . .
EXIT CAL . . . . . . . . . . . . . . . . .
SP FUNC . . . . . . . . . . . . . . . . .

ENABLE... YESIPMT OVRIDE..IINTERLOCK. NO
DET LOCK... .IDELAY.. 0IINHIBIT... 0
OVERRIDE FL. .IDURATION 0ICLR-GRN... NO
TERM OLP. NOIPC>YEL NOITERM PH NO
PED DARK.. NOITC RESRV YESIDWELL FL OFF
LINK PMT...3IX FLCOLR REDIEXIT OPT. OFF
X TMG PLN...OIRE-SERV.. 0IFLT TYPE.HARD
FREE DUR PMTIR1 NOIR2 NOIR3 NOIR4 NO
--TIMING-----WALKIPED CLIMN GRI YELI RED
ENTRANCE TM. 2551 2551 1125.5125.5
-----MIN GRIEXT GRIMX GRI YELI RED
TRACK CLEAR 191 01 01 4.61 2.3
-----MIN DLIPMTEXTIMX TMI YELI RED
DWL/CYC-EXIT 01 0.01 0125.5125.5
PMT ACTIVE OUT..ON PMT ACT DWELL...NO
OTHER - PRI PMT.OFF NON-PRI PMT....OFF
INH EXT TIME... 0.0 PED PR RETURN...OFF
PRIORITY RETURN.OFF QUEUE DELAY.... OFF
COND DELAY.....OFF
PHASES 1 2 3 4 5 6 7 8
PR RTN% 0 0 0 0 0 0 0 0
PHASES 9 10 11 12 13 14 15 16
PR RTN% 0 0 0 0 0 0 0 0

```

NOTICE LINK PMT 1 →

NOTICE LINK PMT 3 →

Linked preempts 1 and 2 make up preempt RR1

Linked preempts 3 and 4 make up preempt RR2

ECONOLITE ASC/3-2070 PREEMPT FILTERING

- 1. From Main Menu select **4. PREEMPTOR/TSP**
- 2. From PREEMPTOR/TSP/SCP Submenu select **2. ENABLE PREEMPT FILTERING & TSP/SCP**
- 3. Ensure all preempt entries are set to BYPASSED for both SOLID and PULSING.

THIS ELECTRICAL DETAIL IS FOR THE SIGNAL DESIGN: 06-0054
DESIGNED: March 2018
SEALED: 03-29-2018
REVISED: N/A

Final Design
Electrical Detail - Sheet 4 of 6



Stantec Consulting Services Inc.
801 Jones Franklin Road-Suite 300
Raleigh, NC 27606
Tel. (919) 851-6866
Fax. (919) 851-7024
www.stantec.com
License No. F-0672

ELECTRICAL AND PROGRAMMING DETAILS FOR:

Prepared in the Offices of:

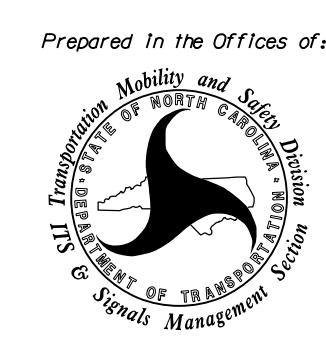

750 N. Greenfield Pkwy, Garner, NC 27529

US 401 Business (Raeford Road)
at
McPherson Church Road/
Owen Drive
Division 6 Cumberland County Fayetteville

PLAN DATE: March 2018 REVIEWED BY: L Overn
PREPARED BY: G B Spell REVIEWED BY:

REVISIONS	INIT.	DATE

SEAL

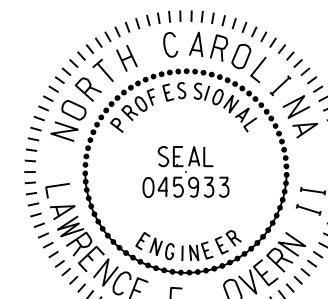

3/29/2018
DATE
SIG. INVENTORY NO. 06-0054

DATE: 03/29/2018 10:05:10 AM
USER: rfmancey

ECONOLITE ASC/3-2070 LOGIC PROCESSOR PROGRAMMING DETAIL

(program controller as shown)

- From Main Menu select **1. CONFIGURATION**
- From CONFIGURATION Submenu select **8. LOGIC PROCESSOR**
- From LOGIC PROCESSOR Submenu select **2. LOGIC STATEMENTS**

ENTER A "1" IN THE LP# FIELD, PRESS 'ENTER', AND PROGRAM AS SHOWN.

```

LP#: 1 COPY FROM: 1 ACTIVE: M
IF DET 52 IS ON

THEN LP SET LOGIC FLAG 1 ON

ELSE

```

IF RR1 PREEMPT (REMAPPED AS DET 52) INPUT IS ACTIVE, SET LOGIC FLAG 1 ON.

ENTER A "2" IN THE LP# FIELD, PRESS 'ENTER', AND PROGRAM AS SHOWN.

```

LP#: 2 COPY FROM: 2 ACTIVE: M
IF LP FLAG 1 IS ON

THEN PMT CALL PMT SEQ 2 ON

ELSE

```

IF LOGIC FLAG 1 IS ON, THEN INITIATE PREEMPT 2 SEQUENCE. THE PREEMPT MAY OR MAY NOT ACTUALLY BE SERVED DEPENDING ON THE STATE OF THE OTHER RR PREEMPT INPUT.

ENTER A "3" IN THE LP# FIELD, PRESS 'ENTER', AND PROGRAM AS SHOWN.

```

LP#: 3 COPY FROM: 3 ACTIVE: M
IF DET 54 IS ON

THEN LP SET LOGIC FLAG 2 ON

ELSE

```

IF RR2 PREEMPT (REMAPPED AS DET 54) INPUT IS ACTIVE, SET LOGIC FLAG 2 ON.

ENTER A "4" IN THE LP# FIELD, PRESS 'ENTER', AND PROGRAM AS SHOWN.

```

LP#: 4 COPY FROM: 4 ACTIVE: M
IF LP FLAG 2 IS ON

THEN PMT CALL PMT SEQ 4 ON

ELSE

```

IF LOGIC FLAG 2 IS ON, THEN INITIATE PREEMPT 4 SEQUENCE. THE PREEMPT MAY OR MAY NOT ACTUALLY BE SERVED DEPENDING ON THE STATE OF THE OTHER RR PREEMPT INPUT.

ENTER A "5" IN THE LP# FIELD, PRESS 'ENTER', AND PROGRAM AS SHOWN.

```

LP#: 5 COPY FROM: 5 ACTIVE: M
IF DET 52 IS OFF
AND DET 54 IS OFF

THEN LP SET LOGIC FLAG 1 OFF
THEN LP SET LOGIC FLAG 2 OFF

ELSE

```

WHEN BOTH PREEMPT INPUTS GO INACTIVE, THIS LOGIC RESETS THE LOGIC FLAG THAT IS HOLDING THE ACTIVE PREEMPT ACTIVE, AND RESETS THE OTHER LOGIC FLAG TO PREVENT IT FROM CALLING THE OTHER PREEMPT.

END PROGRAMMING

- From Main Menu select **1. CONFIGURATION**
- From CONFIGURATION Submenu select **8. LOGIC PROCESSOR**
- From LOGIC PROCESSOR Submenu select **1. LOGIC STATEMENT CONTROL**

ENABLE LOGIC PROCESSOR STATEMENTS 1-5 BY POSITIONING THE CURSOR OVER THE FIELDS SHOWN BELOW AND USING THE TOGGLE KEY TO ENABLE THEM.

LOGIC STATEMENT CONTROL	
	1 2 3 4 5 6 7 8 9 0 1 2 3 4 5
LP 1-15	E E E E E
LP 16-30
LP 31-45
LP 46-60
LP 61-75
LP 76-90

END PROGRAMMING

ECONOLITE ASC/3-2070 I/O PIN REMAPPING FOR RR1 AND RR2 PREEMPT INPUTS

The ASC/3 Configurator utility program must be used to remap the I/O pins as shown below. Consult the ASC/3 Configurator User Guide for specific instructions on software use.

- Run the Configurator utility. Load a file as the Current DB.
- Choose the C1-in tab to change the I/O mapping as needed. Use the drop down list within the program to select the assigned function for the pins shown below.
- Save the database file and download it to the controller.

C1 PIN #	DEFAULT FUNCTION	ASSIGNED FUNCTION
----------	------------------	-------------------

PIN 51-PREEMPT 1 CALL →

PIN 52-PREEMPT 2 CALL →

NOTE: PREEMPT INPUTS REMAPPED AS DETECTORS

NOTE: The steps below can be used to view changes to I/O pins within the controller. Any I/O pins that have been remapped will display and show their default function in addition to the current assigned function.

- From Main Menu select **7. STATUS DISPLAY**
- From STATUS DISPLAY Submenu select **8. INPUTS/OUTPUTS**
- From INPUT/OUTPUT Submenu select **9. I/O DIFFERENCES**

ECONOLITE ASC/3-2070 VEHICLE DETECTOR SETUP PROGRAMMING DETAIL FOR REMAPPED DETECTORS

(program controller as shown)

The preempt inputs remapped as detectors that are to be used by the logic processor are assigned to a dummy phase 9 as shown in the detector setup programming below.

- From Main Menu select **6. DETECTORS**
- From DETECTOR Submenu select **2. VEHICLE DETECTOR SETUP**

- Place cursor in VEH DETECTOR [] position and enter "52".

DISABLE TS2 DETECTOR →

ASSIGN PHASE 9 →

```

VEH DETECTOR [52] VEH DET PLAN [ 1]
TYPE: S-STANDARD
TS2 DETECTOR..... ECPI LOG..... NO
DET PH - 1 2 3 4 5 6 7 8 9 0 1 2 3 4 5 6
52 9 . . . . .
EXTEND TIME... 0.0 DELAY TIME... 0.0
USE ADDED INITIAL . CROSS SWITCH PH.. 0
LOCK IN..... NONE NTCIP VOL . OR OCC .
PMT QUEUE DELAY. NO

```

- Place cursor in VEH DETECTOR [] position and enter "54".

DISABLE TS2 DETECTOR →

ASSIGN PHASE 9 →

```

VEH DETECTOR [54] VEH DET PLAN [ 1]
TYPE: S-STANDARD
TS2 DETECTOR..... ECPI LOG..... NO
DET PH - 1 2 3 4 5 6 7 8 9 0 1 2 3 4 5 6
54 9 . . . . .
EXTEND TIME... 0.0 DELAY TIME... 0.0
USE ADDED INITIAL . CROSS SWITCH PH.. 0
LOCK IN..... NONE NTCIP VOL . OR OCC .
PMT QUEUE DELAY. NO

```

END PROGRAMMING

THIS ELECTRICAL DETAIL IS FOR THE SIGNAL DESIGN: 06-0054 DESIGNED: March 2018 SEALED: 03-29-2018 REVISED: N/A

Final Design Electrical Detail - Sheet 5 of 6

DATE: 03/29/2018 11:04:11 AM User: rmluncey

Stantec Consulting Services Inc.
801 Jones Franklin Road-Suite 300
Raleigh, NC 27606
Tel. (919) 851-6866
Fax. (919) 851-7024
www.stantec.com
License No. F-0672

ELECTRICAL AND PROGRAMMING DETAILS FOR:

Prepared in the Offices of:

750 N. Greenfield Pkwy, Garner, NC 27529

US 401 Business (Raeford Road) at McPherson Church Road/ Owen Drive

Division 6 Cumberland County Fayetteville

PLAN DATE: March 2018 REVIEWED BY: L Overn

PREPARED BY: G B Spell REVIEWED BY:

REVISIONS	INIT.	DATE

SEAL

3/29/2018

SIG. INVENTORY NO. 06-0054

DOCUMENT NOT CONSIDERED FINAL UNLESS ALL SIGNATURES COMPLETED

AC ISOLATOR (MODEL 252) OUTPUT PROGRAMMING DETAIL

(set DIP switches as shown below)

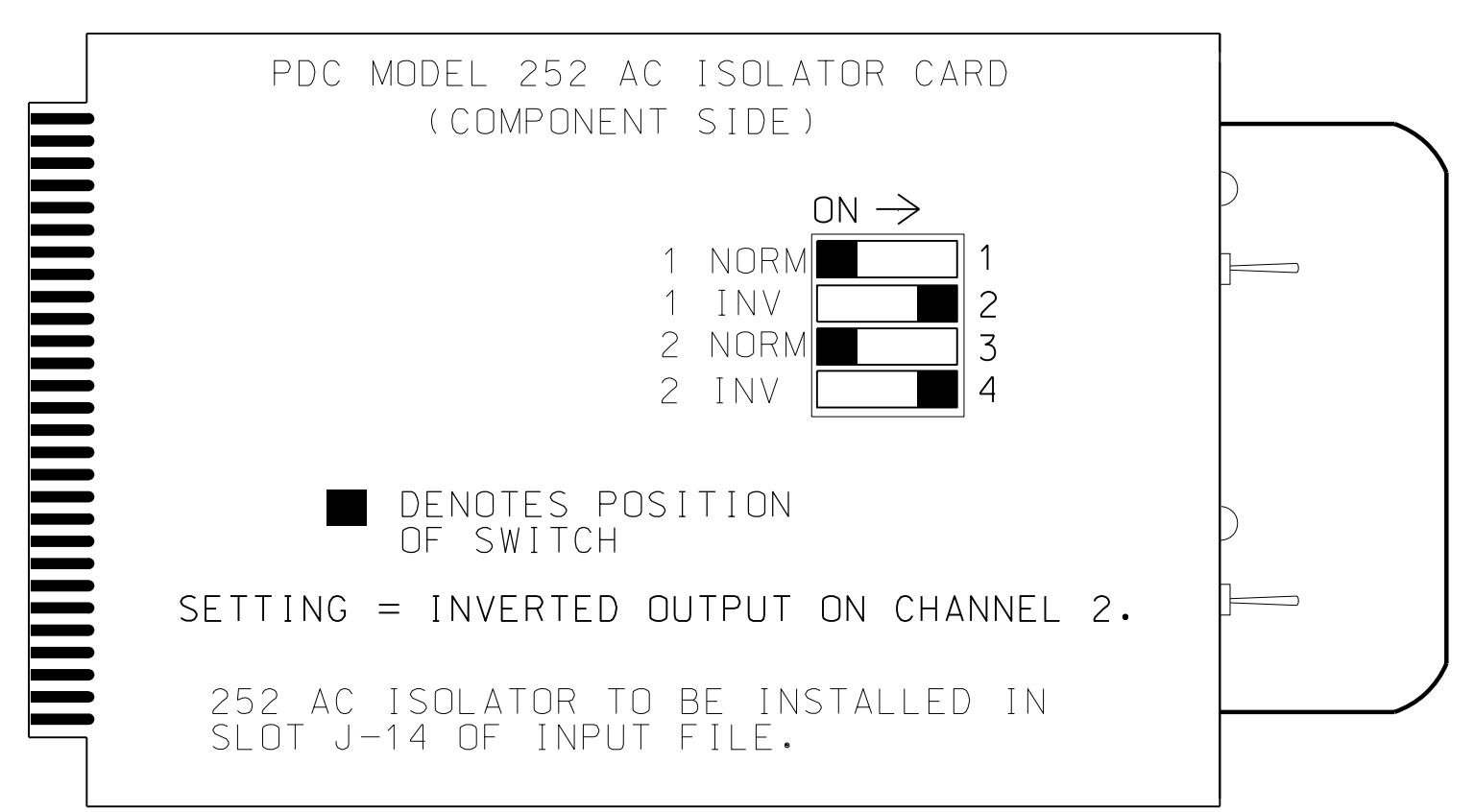

NOTE: IF ANOTHER MANUFACTURER TYPE OF AC ISOLATOR IS USED, OUTPUT PROGRAMMING IS LIKELY NOT TO EQUATE TO THAT SHOWN ABOVE.

ECONOLITE ASC/3-2070 OVERLAP PROGRAMMING DETAIL

(program controller as shown)

- From Main Menu select
- From CONTROLLER Submenu select

OVERLAP A

Select TMG VEH OVLP [A] and 'NORMAL'

```

TMG VEH OVLP...[A] TYPE: .....NORMAL
PHASES 1 2 3 4 5 6 7 8 9 0 1 2 3 4 5 6
INCLUDED X . . . . .
LAG GRN 0.0 YEL 0.0 RED 0.0
  
```

END PROGRAMMING

THIS ELECTRICAL DETAIL IS FOR
THE SIGNAL DESIGN: 06-0054
DESIGNED: March 2018
SEALED: 03-29-2018
REVISED: N/A

Final Design
Electrical Detail - Sheet 6 of 6

DOCUMENT NOT CONSIDERED FINAL
UNLESS ALL SIGNATURES COMPLETED

<p>Stantec Consulting Services Inc. 801 Jones Franklin Road-Suite 300 Raleigh, NC 27606 Tel. (919) 851-6866 Fax. (919) 851-7024 www.stantec.com License No. F-0672</p>	<p>750 N. Greenfield Pkwy, Garner, NC 27529</p>	<p>ELECTRICAL AND PROGRAMMING DETAILS FOR:</p> <p>US 401 Business (Raeford Road) at McPherson Church Road/ Owen Drive</p>	<p>SEAL</p> <p>3/29/2018</p>										
		<p>Division 6 Cumberland County Fayetteville</p> <p>PLAN DATE: March 2018 REVIEWED BY: L Overn</p> <p>PREPARED BY: G B Spell REVIEWED BY:</p> <table border="1"> <thead> <tr> <th>REVISIONS</th> <th>INIT.</th> <th>DATE</th> </tr> </thead> <tbody> <tr> <td> </td> <td> </td> <td> </td> </tr> <tr> <td> </td> <td> </td> <td> </td> </tr> <tr> <td> </td> <td> </td> <td> </td> </tr> </tbody> </table>		REVISIONS	INIT.	DATE							
REVISIONS	INIT.	DATE											

DATE: 03/29/2018 10:41:11 AM User: rfmancey

EDI MODEL 2018ECLip-NC CONFLICT MONITOR PROGRAMMING DETAIL

(remove jumpers and set switches as shown)

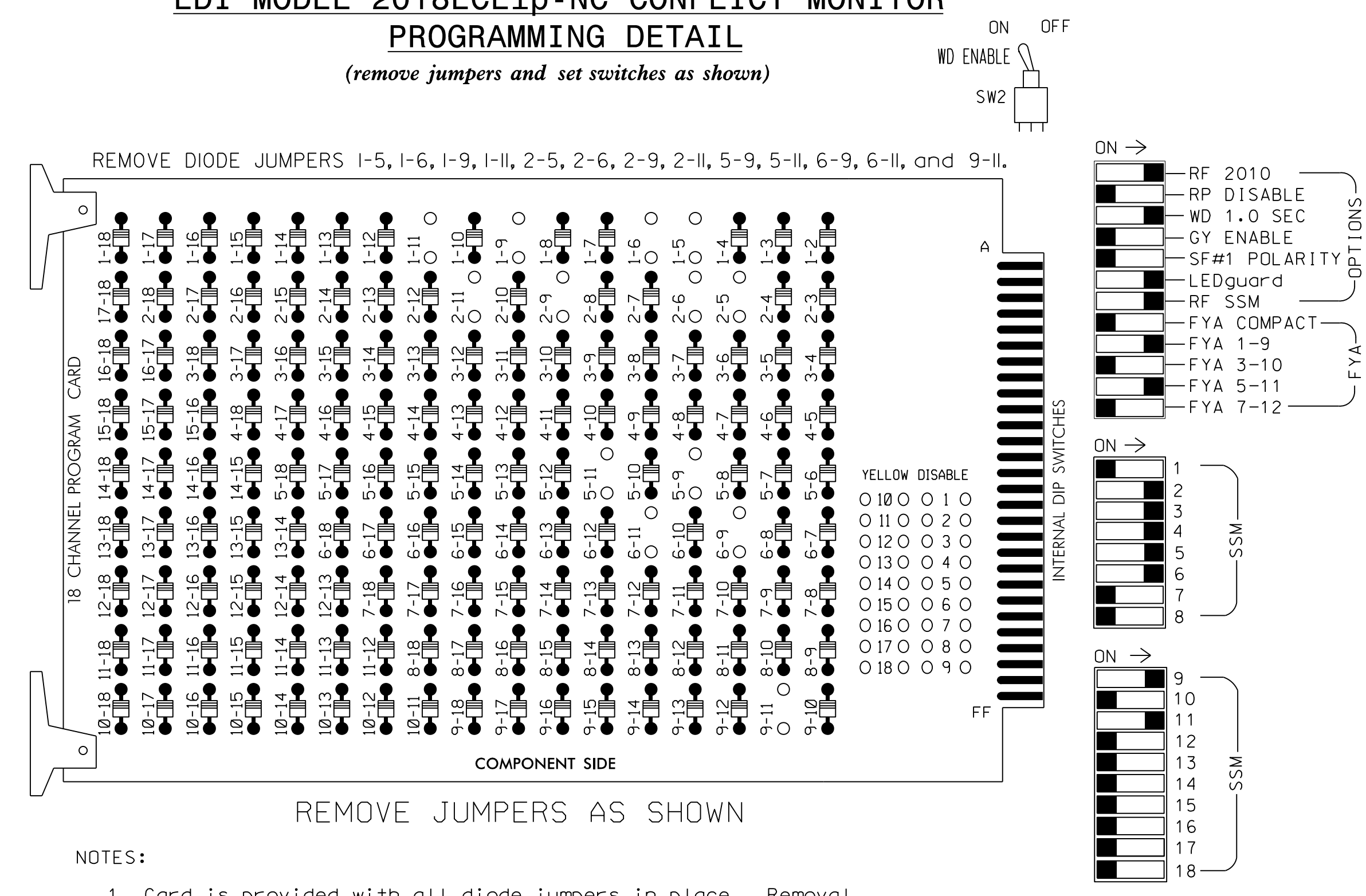

NOTES:

1. Card is provided with all diode jumpers in place. Removal of any jumper allows its channels to run concurrently.
2. Ensure jumpers SEL2-SEL5 and SEL9 are present on the monitor board.
3. Ensure that Red Enable is active at all times during normal operation.
4. Integrate monitor with Ethernet network in cabinet.

NOTES

1. To prevent "flash-conflict" problems, insert red flash program blocks for all unused vehicle load switches in the output file. The installer shall verify that signal heads flash in accordance with the Signal Plans.
2. Program controller to start up in Phase 2 Green and Phase 6 Green.
3. The cabinet and controller are part of the Fayetteville Signal System.

EQUIPMENT INFORMATION

CONTROLLER.....2070
 CABINET.....332 W/AUX
 SOFTWARE.....ECONOLITE ASC/3-2070
 CABINET MOUNT.....BASE
 OUTPUT FILE POSITIONS...18 WITH AUX. OUTPUT FILE
 LOAD SWITCHES USED.....S1,S2,S4,S5,S7,S8,
 AUX S1,AUX S4
 PHASES USED.....1,2,3,4,5,6
 OVERLAP A.....*
 OVERLAP B.....NOT USED
 OVERLAP C.....*
 OVERLAP D.....NOT USED
 * See Overlap Programming Detail on Sheet 2

SIGNAL HEAD HOOK-UP CHART

LOAD SWITCH NO.	S1	S2	S3	S4	S5	S6	S7	S8	S9	S10	S11	S12	AUX S1	AUX S2	AUX S3	AUX S4	AUX S5	AUX S6				
CMU CHANNEL NO.	1	2	13	3	4	14	5	6	15	7	8	16	9	10	17	11	12	18				
PHASE	1	2	2 PED	3	3	4	4	4 PED	5	4	6	6 PED	7	8	8 PED	OLA	OLB	SPARE	OLC	OLD	SPARE	
SIGNAL HEAD NO.	11*	21,22	NU	31	32	41	42	NU	51*	42	61,62,63	NU	NU	NU	NU	11*	NU	NU	51*	NU	NU	
RED		128		116	116	101	101		*		134											
YELLOW	*	129		117	117	102	102				135											
GREEN		130		118	118	103	103				136											
RED ARROW																A121				A114		
YELLOW ARROW										132						A122				A115		
FLASHING YELLOW ARROW																A123				A116		
GREEN ARROW	127			118		103				133	133											

NU = Not Used
 * Denotes install load resistor. See load resistor installation detail this sheet.
 ★ See pictorial of head wiring in detail below.

DETECTOR NOTES

1. For all loops install a video detection system for vehicle detection. Perform installation according to manufacturer's directions and NCDOT engineer-approved mounting locations to accomplish the detection schemes shown on the Signal Design Plans.
2. For loops 1A and 5A detector card placements and slots reserved for wired inputs are typical for a NCDOT installation. Inputs associated with these slots are compatible with time of day instructions located on sheet 2 of this electrical detail.

INPUT FILE POSITION LAYOUT

(front view)

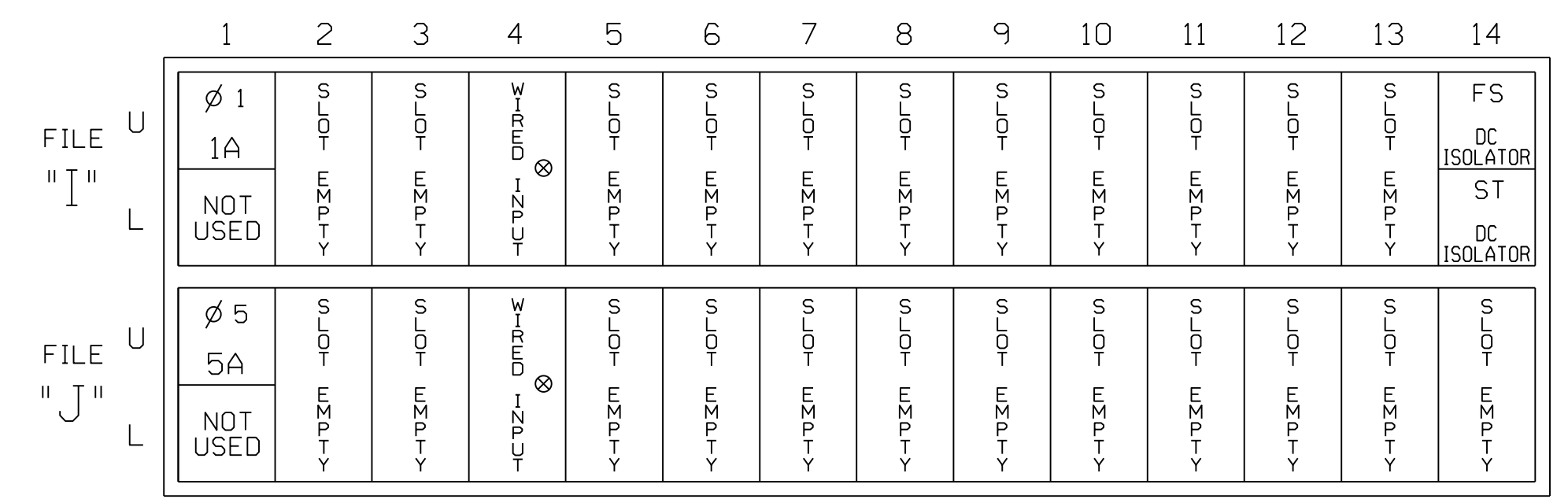

EX.: 1A, 2A, ETC. = LOOP NO.'S
 FS = FLASH SENSE
 ST = STOP TIME
 ⊗ Wired Input - Do not populate slot with detector card

FYA SIGNAL WIRING DETAIL

(wire signal heads as shown)

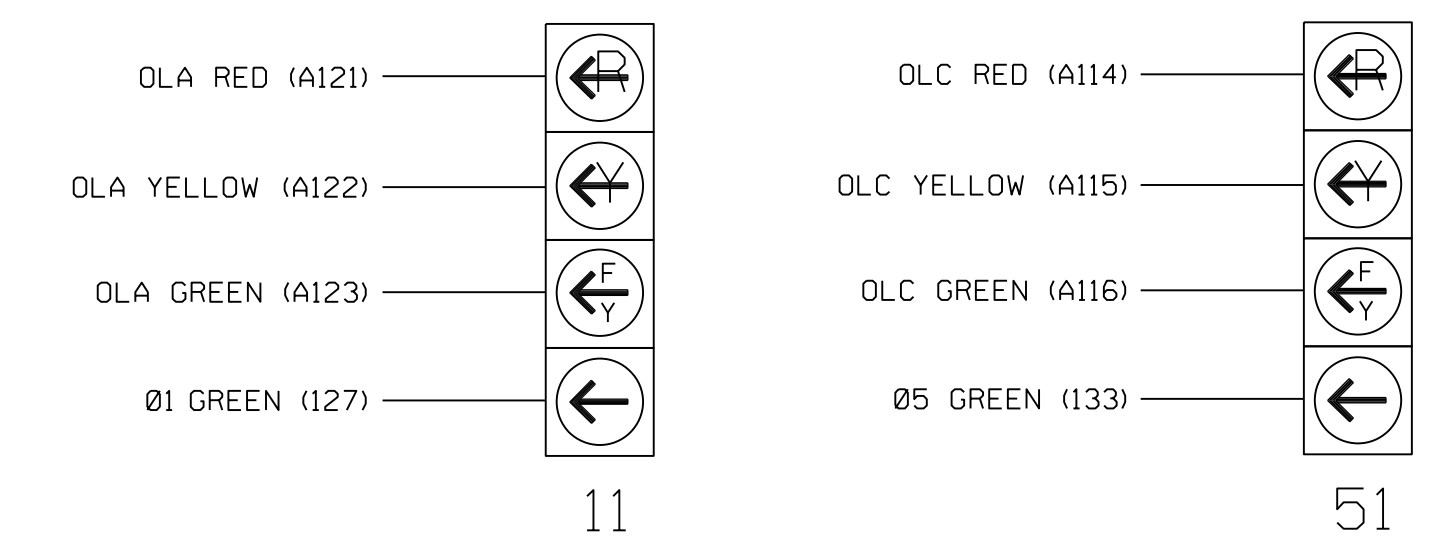

INPUT FILE CONNECTION & PROGRAMMING CHART

LOOP NO.	LOOP TERMINAL	INPUT FILE POS.	PIN NO.	DETECTOR NO.	NEMA PHASE	CALL	EXTEND TIME	DELAY TIME	ADDED INITIAL	DETECTOR TYPE
1A ¹	-	I1U	56	1 ★	1	YES		15		S
	-	J4U	48	26 ★	6	YES				S
5A ²	-	J1U	55	5 ★	5	YES		15		S
	-	I4U	47	22 ★	2	YES				S

¹Add jumper from I1-W to J4-W, on rear of input file.
²Add jumper from J1-W to I4-W, on rear of input file.
 ★ For the detectors to work as shown on the signal design plan, see the Vehicle Detector Setup Programming Detail for Alternate Phasing on sheet 2.

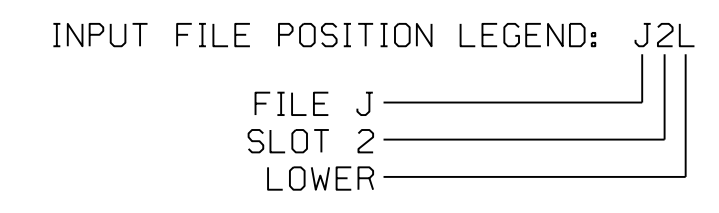

LOAD RESISTOR INSTALLATION DETAIL

(install resistors as shown)

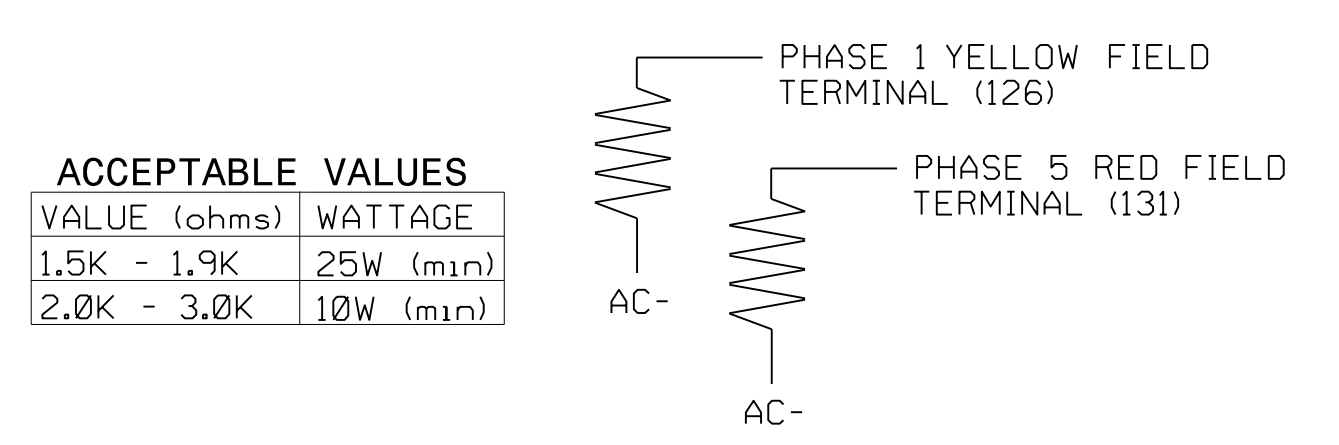

ACCEPTABLE VALUES	
VALUE (ohms)	WATTAGE
1.5K - 1.9K	25W (min)
2.0K - 3.0K	10W (min)

THIS ELECTRICAL DETAIL IS FOR THE SIGNAL DESIGN: 06-00011
 DESIGNED: March 2018
 SEALED: 03-29-2018
 REVISED: N/A

Temporary Design 1 - TMP Phase I
 Electrical Detail - Sheet 1 of 2

Stantec Consulting Services Inc.
 801 Jones Franklin Road-Suite 300
 Raleigh, NC 27606
 Tel. (919) 851-6866
 Fax. (919) 851-7024
 www.stantec.com
 License No. F-0672

Prepared in the Offices of:

750 N. Greenfield Pkwy, Garner, NC 27529

US 401 Business (Raeford Road)
 at
 Fairfield Road/
 United Methodist Church
 Division 6 Cumberland County Fayetteville

PLAN DATE: March 2018 REVIEWED BY: L Overn
 PREPARED BY: G B Spell REVIEWED BY:

REVISIONS	INIT.	DATE

SEAL
 NORTH CAROLINA
 PROFESSIONAL ENGINEER
 LAWRENCE E. OVERN
 045933
 3/29/2018
 DATE
 SIG. INVENTORY NO. 06-000111

DATE: U:\Projects\Signal\Signal\Detail\18*Temporary_Signals\Phase 1\U-4405.sig.ele_06-000111.dgn User: rfmuncy

EDI MODEL 2018ECLip-NC CONFLICT MONITOR PROGRAMMING DETAIL

(remove jumpers and set switches as shown)

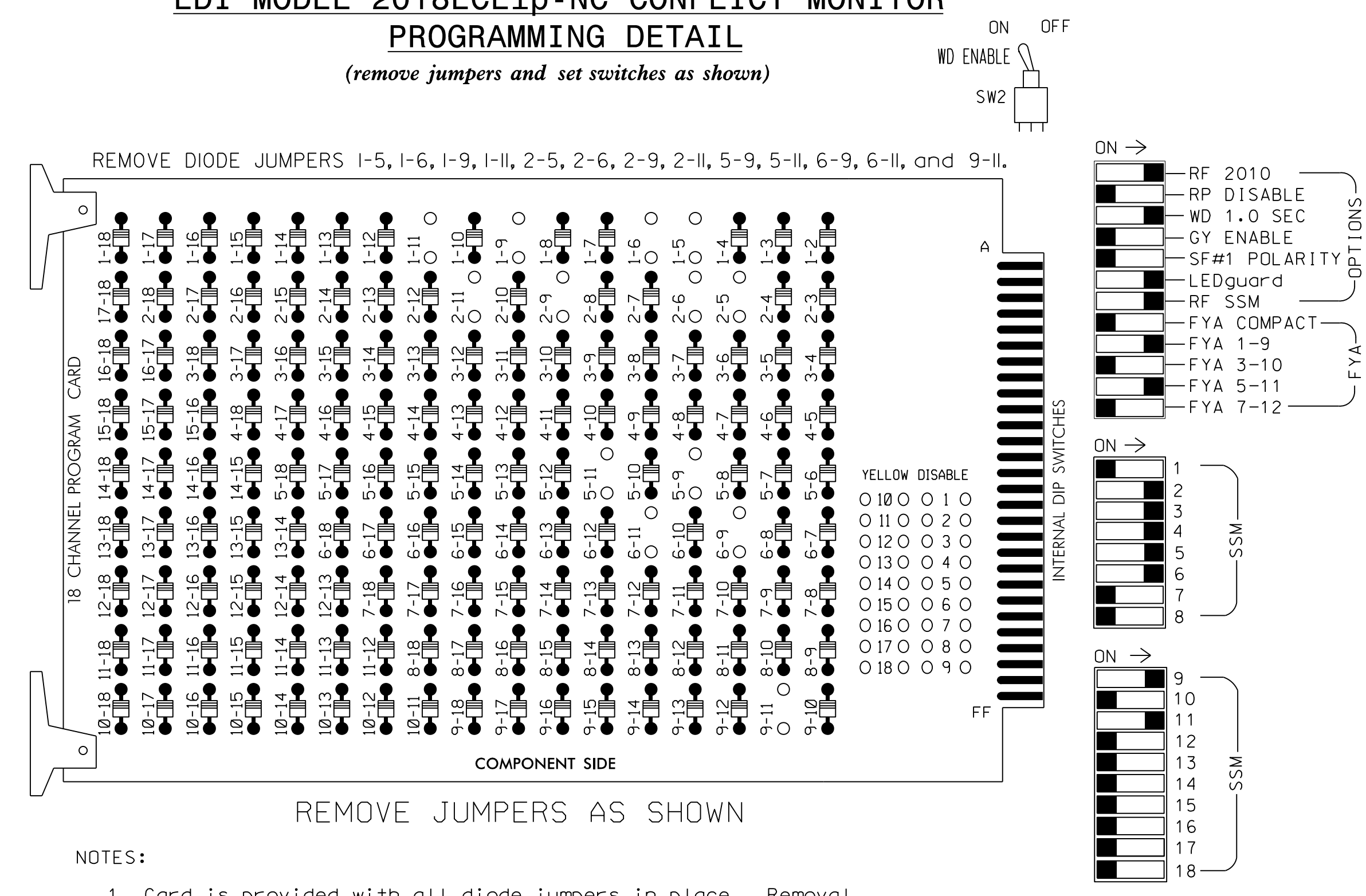

NOTES:

1. Card is provided with all diode jumpers in place. Removal of any jumper allows its channels to run concurrently.
2. Ensure jumpers SEL2-SEL5 and SEL9 are present on the monitor board.
3. Ensure that Red Enable is active at all times during normal operation.
4. Integrate monitor with Ethernet network in cabinet.

NOTES

1. To prevent "flash-conflict" problems, insert red flash program blocks for all unused vehicle load switches in the output file. The installer shall verify that signal heads flash in accordance with the Signal Plans.
2. Program controller to start up in Phase 2 Green and Phase 6 Green.
3. The cabinet and controller are part of the Fayetteville Signal System.

EQUIPMENT INFORMATION

CONTROLLER.....2070
 CABINET.....332 W/AUX
 SOFTWARE.....ECONOLITE ASC/3-2070
 CABINET MOUNT.....BASE
 OUTPUT FILE POSITIONS...18 WITH AUX. OUTPUT FILE
 LOAD SWITCHES USED.....S1,S2,S4,S5,S7,S8,
 AUX S1,AUX S4
 PHASES USED.....1,2,3,4,5,6
 OVERLAP A.....*
 OVERLAP B.....NOT USED
 OVERLAP C.....*
 OVERLAP D.....NOT USED
 * See Overlap Programming Detail on Sheet 2

SIGNAL HEAD HOOK-UP CHART

LOAD SWITCH NO.	S1	S2	S3	S4	S5	S6	S7	S8	S9	S10	S11	S12	AUX S1	AUX S2	AUX S3	AUX S4	AUX S5	AUX S6				
CMU CHANNEL NO.	1	2	13	3	4	14	5	6	15	7	8	16	9	10	17	11	12	18				
PHASE	1	2	2 PED	3	3	4	4	4 PED	5	4	6	6 PED	7	8	8 PED	OLA	OLB	SPARE	OLC	OLD	SPARE	
SIGNAL HEAD NO.	11*	21,22	NU	31	32	41	42	NU	51*	42	61,62	NU	NU	NU	NU	11*	NU	NU	51*	NU	NU	
RED		128		116	116	101	101		*		134											
YELLOW	*	129		117	117	102	102				135											
GREEN		130		118	118	103	103				136											
RED ARROW																A121				A114		
YELLOW ARROW										132						A122				A115		
FLASHING YELLOW ARROW																A123				A116		
GREEN ARROW	127			118		103				133	133											

NU = Not Used
 * Denotes install load resistor. See load resistor installation detail this sheet.
 ★ See pictorial of head wiring in detail below.

DETECTOR NOTES

1. For all loops install a video detection system for vehicle detection. Perform installation according to manufacturer's directions and NCDOT engineer-approved mounting locations to accomplish the detection schemes shown on the Signal Design Plans.
2. For loops 1A and 5A detector card placements and slots reserved for wired inputs are typical for a NCDOT installation. Inputs associated with these slots are compatible with time of day instructions located on sheet 2 of this electrical detail.

INPUT FILE POSITION LAYOUT

(front view)

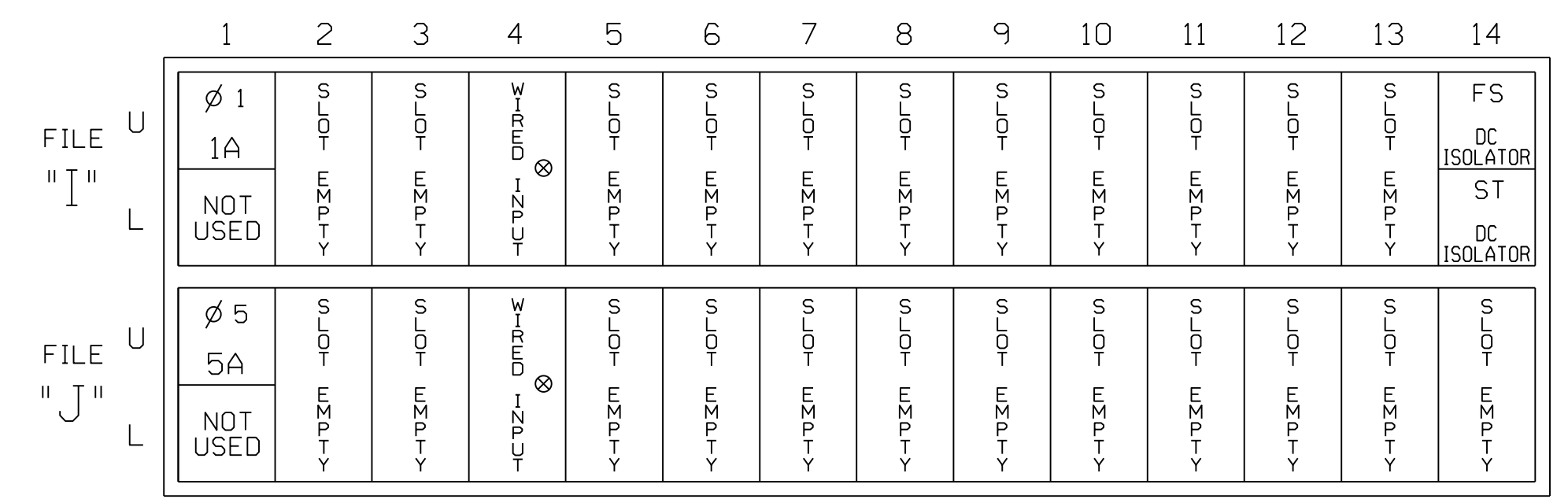

⊗ Wired Input - Do not populate slot with detector card

INPUT FILE CONNECTION & PROGRAMMING CHART

LOOP NO.	LOOP TERMINAL	INPUT FILE POS.	PIN NO.	DETECTOR NO.	NEMA PHASE	CALL	EXTEND TIME	DELAY TIME	ADDED INITIAL	DETECTOR TYPE
1A ¹	-	I1U	56	1 ★	1	YES		15		S
	-	J4U	48	26 ★	6	YES				S
5A ²	-	J1U	55	5 ★	5	YES		15		S
	-	I4U	47	22 ★	2	YES				S

¹Add jumper from I1-W to J4-W, on rear of input file.
²Add jumper from J1-W to I4-W, on rear of input file.

★ For the detectors to work as shown on the signal design plan, see the Vehicle Detector Setup Programming Detail for Alternate Phasing on sheet 2.

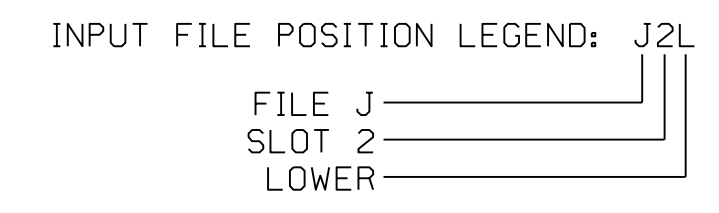

LOAD RESISTOR INSTALLATION DETAIL

(install resistors as shown)

ACCEPTABLE VALUES	
VALUE (ohms)	WATTAGE
1.5K - 1.9K	25W (min)
2.0K - 3.0K	10W (min)

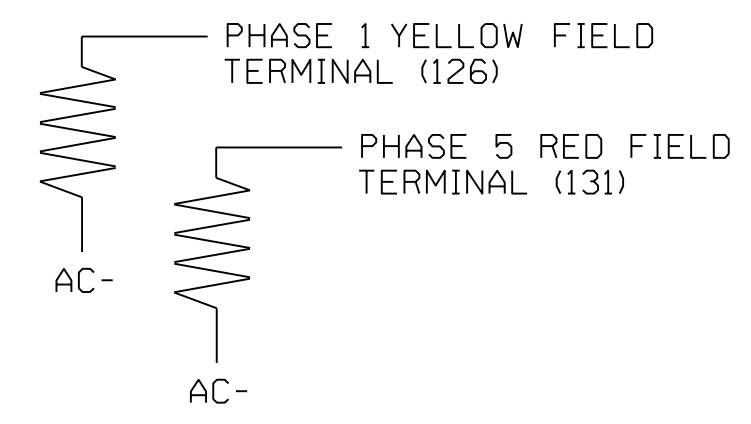

FYA SIGNAL WIRING DETAIL

(wire signal heads as shown)

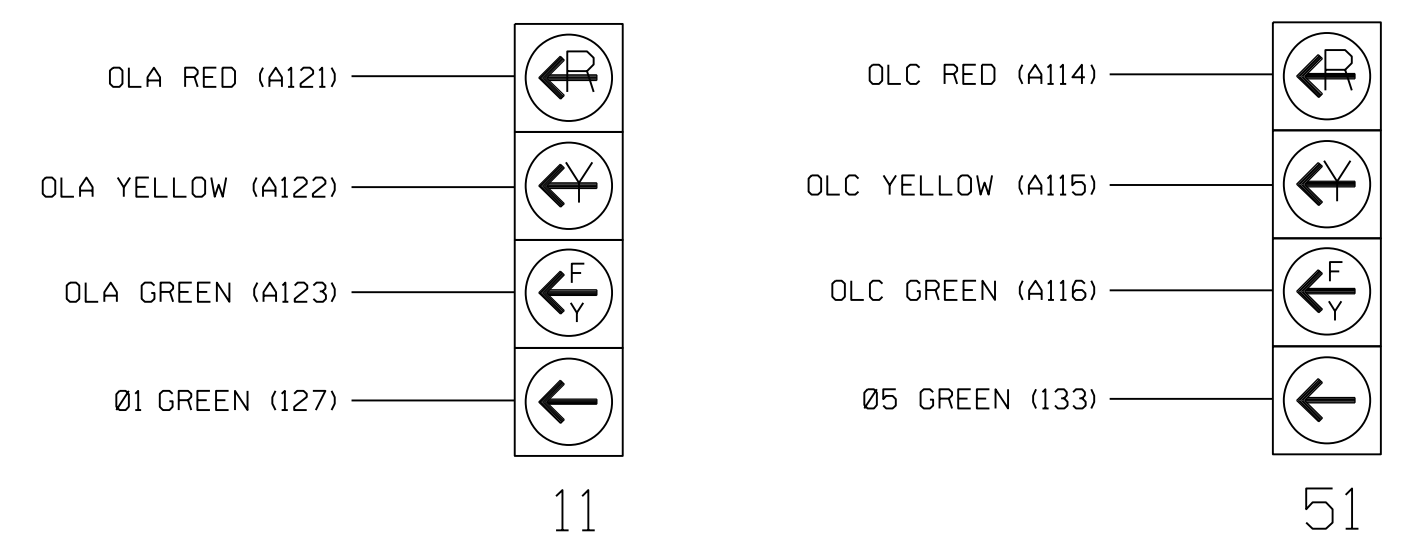

THIS ELECTRICAL DETAIL IS FOR THE SIGNAL DESIGN: 06-0001T2
 DESIGNED: March 2018
 SEALED: 03-29-2018
 REVISED: N/A

Temporary Design 2 - TMP Phase II
 Electrical Detail - Sheet 1 of 2

<p>Stantec Consulting Services Inc. 801 Jones Franklin Road-Suite 300 Raleigh, NC 27606 Tel. (919) 851-6866 Fax. (919) 851-7024 www.stantec.com License No. F-0672</p>	ELECTRICAL AND PROGRAMMING DETAILS FOR: Prepared in the Offices of: 	US 401 Business (Raeford Road) at Fairfield Road/ United Methodist Church Division 6 Cumberland County Fayetteville PLAN DATE: March 2018 REVIEWED BY: L Overn PREPARED BY: G B Spell REVIEWED BY:	SEAL NORTH CAROLINA PROFESSIONAL ENGINEER LAWRENCE E. OVERN 3/29/2018 DATE
	REVISIONS INIT. DATE	REVISIONS INIT. DATE	REVISIONS INIT. DATE

DATE: U:\Projects\Signal\Signal\Temp\Signal\Phase 2\U-4405.sig.ele.06-0001T2.dgn User: rrmuncey

ECONOLITE ASC/3-2070 VEHICLE DETECTOR SETUP PROGRAMMING DETAIL

FOR ALTERNATE PHASING LOOPS 1A, 5A (program controller as shown)

IMPORTANT!

Program detectors per the input file connection and programming chart shown on sheet 1 before proceeding.

- From Main Menu select **8. UTILITIES**
- From UTILITIES Submenu select **1. COPY/CLEAR**
- Copy from DETECTOR PLAN "1" to DETECTOR PLAN "2".

```

COPY / CLEAR UTILITY
FROM          TO
PHASE TIMING... > PHASE TIMING...
TIMING PLAN... > TIMING PLAN...
PH DET OPT PLAN... > PH DET OPT PLAN...
DETECTOR PLAN... 1 > DETECTOR PLAN... 2
TOGGLE TO SELECT A "FROM" AND A "TO"
THEN PRESS ENTER
  
```

- From Main Menu select **6. DETECTORS**
- From DETECTOR Submenu select **2. VEHICLE DETECTOR SETUP**
- Place cursor in VEH DET PLAN [] position and enter "2".

- Place cursor in VEH DETECTOR [] position and enter "1".
 - Set delay time to "3.0".

```

VEH DETECTOR [ 1 ]  VEH DET PLAN [ 2 ]
TYPE: S-STANDARD
TS2 DETECTOR..... ECPI LOG..... NO
DET PH - 1 2 3 4 5 6 7 8 9 0 1 2 3 4 5 6
1 1
EXTEND TIME... 0.0 DELAY TIME... 3.0
USE ADDED INITIAL . CROSS SWITCH PH.. 0
LOCK IN..... NONE NTCIP VOL . OR OCC .
PMT QUEUE DELAY. NO
  
```

- Place cursor in VEH DETECTOR [] position and enter "26".
 - Set assigned phase to "0".

```

VEH DETECTOR [26]  VEH DET PLAN [ 2 ]
TYPE: S-STANDARD
TS2 DETECTOR..... ECPI LOG..... NO
DET PH - 1 2 3 4 5 6 7 8 9 0 1 2 3 4 5 6
26 0
EXTEND TIME... 0.0 DELAY TIME... 0.0
USE ADDED INITIAL . CROSS SWITCH PH.. 0
LOCK IN..... NONE NTCIP VOL . OR OCC .
PMT QUEUE DELAY. NO
  
```

- Place cursor in VEH DETECTOR [] position and enter "5".
 - Set delay time to "3.0".

```

VEH DETECTOR [ 5 ]  VEH DET PLAN [ 2 ]
TYPE: S-STANDARD
TS2 DETECTOR..... ECPI LOG..... NO
DET PH - 1 2 3 4 5 6 7 8 9 0 1 2 3 4 5 6
5 5
EXTEND TIME... 0.0 DELAY TIME... 3.0
USE ADDED INITIAL . CROSS SWITCH PH.. 0
LOCK IN..... NONE NTCIP VOL . OR OCC .
PMT QUEUE DELAY. NO
  
```

- Place cursor in VEH DETECTOR [] position and enter "22".
 - Set assigned phase to "0".

```

VEH DETECTOR [22]  VEH DET PLAN [ 2 ]
TYPE: S-STANDARD
TS2 DETECTOR..... ECPI LOG..... NO
DET PH - 1 2 3 4 5 6 7 8 9 0 1 2 3 4 5 6
22 0
EXTEND TIME... 0.0 DELAY TIME... 0.0
USE ADDED INITIAL . CROSS SWITCH PH.. 0
LOCK IN..... NONE NTCIP VOL . OR OCC .
PMT QUEUE DELAY. NO
  
```

END PROGRAMMING

ALTERNATE PHASING ACTIVATION DETAIL

TO RUN ALT. PHASING DURING FREE RUN - PROGRAM CHANGES (SHOWN BELOW) IN A TIME BASED ACTION PLAN. SCHEDULE A DAY PLAN THAT INCLUDES THE ACTION PLAN PROGRAMMED TO SELECT VEH DET PLAN 2 AND ENABLE SF BITS 1 and 5.

TO RUN ALT. PHASING DURING COORDINATION - SELECT THE TIME BASED ACTION PLAN THAT IS PROGRAMMED TO SELECT VEH DET PLAN 2 AND ENABLE SF BITS 1 and 5.

PHASING	VEH DET PLAN	SF BITS ENABLED
ACTIONS REQUIRED TO RUN <u>DEFAULT PHASING</u>	1	NONE
ACTIONS REQUIRED TO RUN <u>ALTERNATE PHASING</u>	2	1, 5

IMPORTANT: IF ALT. PHASING IS USED DURING FREE RUN AND COORDINATION, DO NOT OPERATE TIME OF DAY EVENTS CONCURRENTLY WITH COORDINATION PLAN EVENTS IN THE EVENT SCHEDULER. (EX. FREE RUN EVENT SHOULD END BEFORE COORDINATION PLAN EVENT STARTS AND VICE-VERSA).

ALTERNATE PHASING CHANGE SUMMARY

THE FOLLOWING IS A SUMMARY OF WHAT TAKES PLACE WHEN SF BITS 1 AND 5 AND VEH DET PLAN 2 ACTIVATE TO CALL THE "ALTERNATE PHASING":

SF BITS 1,5: Modifies overlap parent phases for heads 11 and 51 to run protected turns only.

VEH DET PLAN 2: Disables phase 6 call on loop 1A and reduces delay time for phase 1 call on loop 1A to 3 seconds.

Disables phase 2 call on loop 5A and reduces delay time for phase 5 call on loop 5A to 3 seconds.

ECONOLITE ASC/3-2070 OVERLAP PROGRAMMING DETAIL (program controller as shown)

- From Main Menu select **2. CONTROLLER**
- From CONTROLLER Submenu select **2. VEHICLE OVERLAPS**

OVERLAP A

Select TMG VEH OVLP [A] and 'PPLT FYA'

```

TMG VEH OVLP...[A] TYPE: ....PPLT FYA
PROTECTED LEFT TURN.... PHASE 1
OPPOSING THROUGH..... PHASE 2

FLASHING ARROW OUTPUT....CH9 ISOLATE
DELAY START OF: FYA..0.0 CLEARANCE..0.0
ACTION PLAN SF BIT DISABLE..... 1
  
```

OVERLAP C

Select TMG VEH OVLP [C] and 'PPLT FYA'

```

TMG VEH OVLP...[C] TYPE: ....PPLT FYA
PROTECTED LEFT TURN.... PHASE 5
OPPOSING THROUGH..... PHASE 6

FLASHING ARROW OUTPUT....CH11 ISOLATE
DELAY START OF: FYA..0.0 CLEARANCE..0.0
ACTION PLAN SF BIT DISABLE..... 5
  
```

END PROGRAMMING

ECONOLITE ASC/3-2070 ACTION PLAN PROGRAMMING DETAIL

- From Main Menu select **5. TIME BASE**
- From TIME BASE Submenu select **2. ACTION PLAN**

```

ACTION PLAN...[ 1 ]
PATTERN.....AUTO SYS OVERRIDE... NO
TIMING PLAN..... 0 SEQUENCE..... 0
VEH DETECTOR PLAN.. 2 DET LOG.....NONE
FLASH..... -- RED REST..... NO
VEH DET DIAG PLN.. 0 PED DET DIAG PLN..0
DIMMING ENABLE.. NO PRIORITY RETURN. NO
PED PR RETURN.. NO QUEUE DELAY..... NO
PMT COND DELAY NO
PHASE 1 2 3 4 5 6 7 8 9 0 1 2 3 4 5 6
PED RCL . . . . .
WALK 2 . . . . .
VEX 2 . . . . .
VEH RCL . . . . .
MAX RCL . . . . .
MAX 2 . . . . .
MAX 3 . . . . .
CS INH . . . . .
OMIT . . . . .
SPC FCT X . . . X . . . (1-8)
AUX FCT . . . (1-3)
1 2 3 4 5 6 7 8 9 0 1 2 3 4 5
LP 1-15 . . . . .
LP 16-30 . . . . .
LP 31-45 . . . . .
LP 46-60 . . . . .
LP 61-75 . . . . .
LP 76-90 . . . . .
LP 91-100 . . . . .
  
```

THIS ELECTRICAL DETAIL IS FOR THE SIGNAL DESIGN: 06-0001T2
 DESIGNED: March 2018
 SEALED: 03-29-2018
 REVISED: N/A

Temporary Design 2 - TMP Phase II
 Electrical Detail - Sheet 2 of 2

Stantec Consulting Services Inc.
 801 Jones Franklin Road-Suite 300
 Raleigh, NC 27606
 Tel. (919) 851-6866
 Fax. (919) 851-7024
 www.stantec.com
 License No. F-0672

ELECTRICAL AND PROGRAMMING DETAILS FOR:

Prepared in the Offices of:
 Mobility and Signal Division
 STATE OF NORTH CAROLINA
 DEPARTMENT OF TRANSPORTATION
 Signal Management Section
 750 N. Greenfield Pkwy, Garner, NC 27529

US 401 Business (Raeford Road)
 at
 Fairfield Road/
 United Methodist Church
 Division 6 Cumberland County Fayetteville

PLAN DATE: March 2018 REVIEWED BY: L Overn
 PREPARED BY: G B Spell REVIEWED BY:

REVISIONS	INIT.	DATE

SEAL
 NORTH CAROLINA
 PROFESSIONAL ENGINEER
 LAWRENCE E. OVERN
 045933
 3/29/2018
 DATE
 SIG. INVENTORY NO. 06-0001T2

DATE: U:\Projects\Signal\Signal\Electrical\Detail\Signal\Phase 2\U-4405.sig.ele.06-0001T2.dgn User: rfmuncy

PHASING DIAGRAM

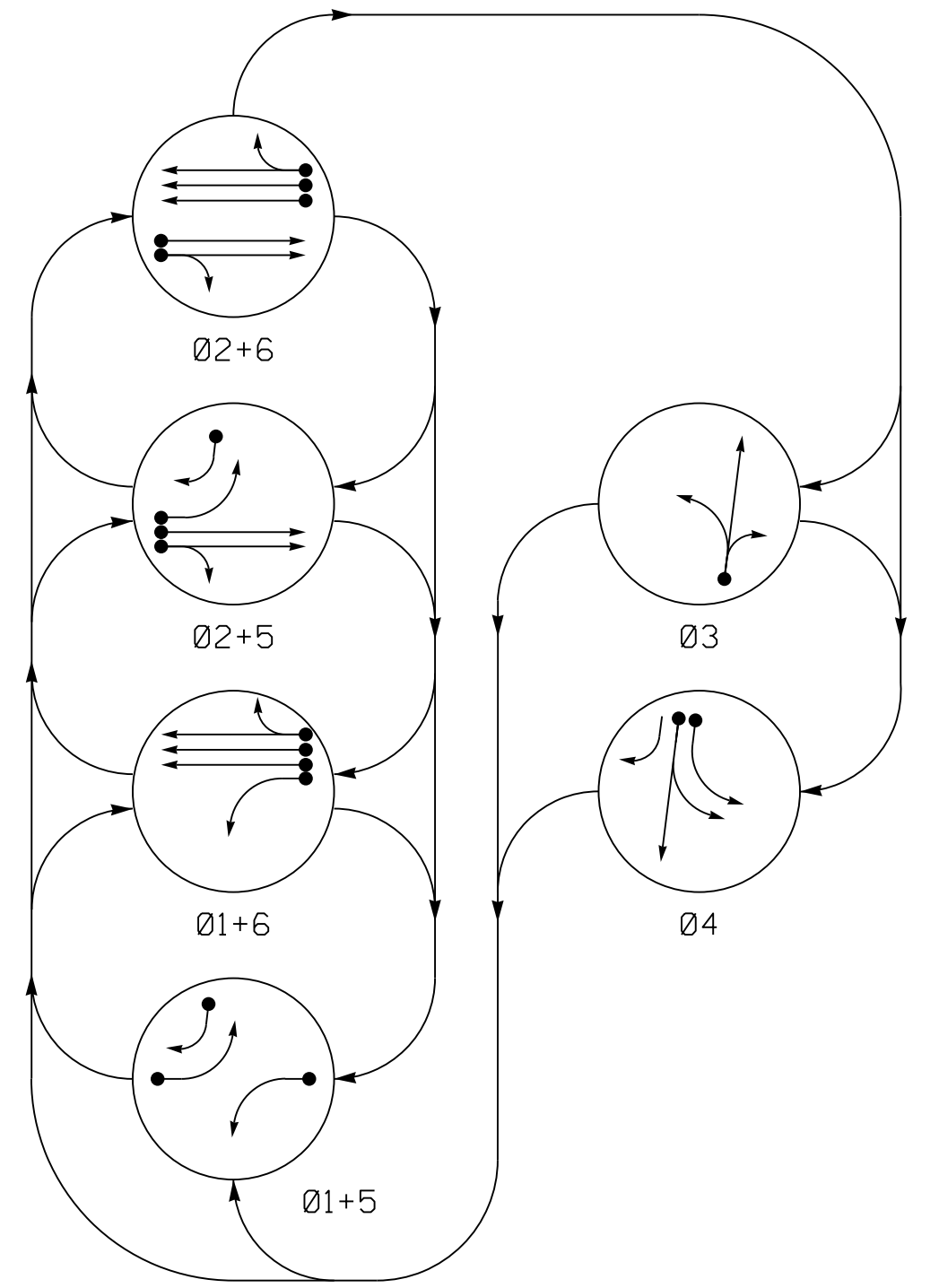

PHASING DIAGRAM DETECTION LEGEND

- ← DETECTED MOVEMENT
- ← UNDETECTED MOVEMENT (OVERLAP)
- UNSIGNALIZED MOVEMENT
- ⚡ --- PEDESTRIAN MOVEMENT

TABLE OF OPERATION

SIGNAL FACE	PHASE					
	Ø 1+5	Ø 1+6	Ø 2+5	Ø 2+6	Ø 3	Ø 4
11	←	←	←	←	←	←
21,22	R	R	G	G	R	R
31	R	R	R	R	G	R
32	R	R	R	R	G	R
41	R	R	R	R	G	R
42	R	R	R	R	G	R
51	←	←	←	←	←	←
61,62	R	G	R	G	R	R

SIGNAL FACE I.D.

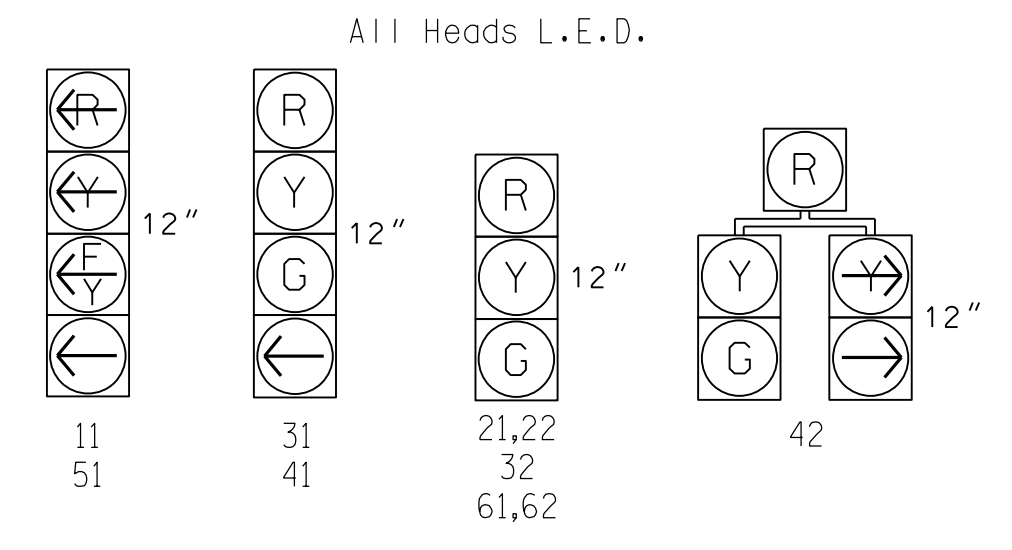

ASC/3 DETECTOR INSTALLATION CHART

LOOP	SIZE (FT)	DISTANCE FROM STOPBAR (FT)	TURNS	PROGRAMMING							
				NEW LOOP	PHASE	CALLING	EXTEND TIME	DELAY TIME	USE ADDED INITIAL	TYPE	SYSTEM LOOP NEW CARD
1A	6X40	0	*	-	1	Yes	-	-	-	S	-
2A	6X6	70	*	-	2	Yes	-	-	-	S	-
2B	6X6	70	*	-	2	Yes	-	-	-	S	-
3A	6X40	0	*	-	3	Yes	-	5	-	S	-
4A	6X40	0	*	-	4	Yes	-	3	-	S	-
4B	6X40	0	*	-	4	Yes	-	-	-	S	-
5A	6X40	0	*	-	5	Yes	-	-	-	S	-
5B	6X40	0	*	-	5	Yes	-	15	-	S	-
6A	6X6	70	*	-	6	Yes	-	-	-	S	-
6B	6X6	70	*	-	6	Yes	-	-	-	S	-
6C	6X6	70	*	-	6	Yes	-	-	-	S	-

* Video Detection Area. Camera locations should be confirmed in the field by the contractor in order to provide detection of the areas indicated.

6 Phase Fully Actuated Fayetteville Signal System

NOTES

- Refer to "Roadway Standard Drawings NCDOT" dated January 2018 and "Standard Specifications for Roads and Structures" dated January 2018.
- Do not program signal for late night flashing operation unless otherwise directed by the Engineer.
- Phase 1 and/or Phase 5 may be lagged.
- The order of Phase 3 and Phase 4 may be reversed.
- Reposition existing signal heads numbered 21,22,61 and 62.
- Set all detector units to presence mode.
- Maximum times shown in timing chart are for free-run operation only. Coordinated signal system timing values supersede these values.

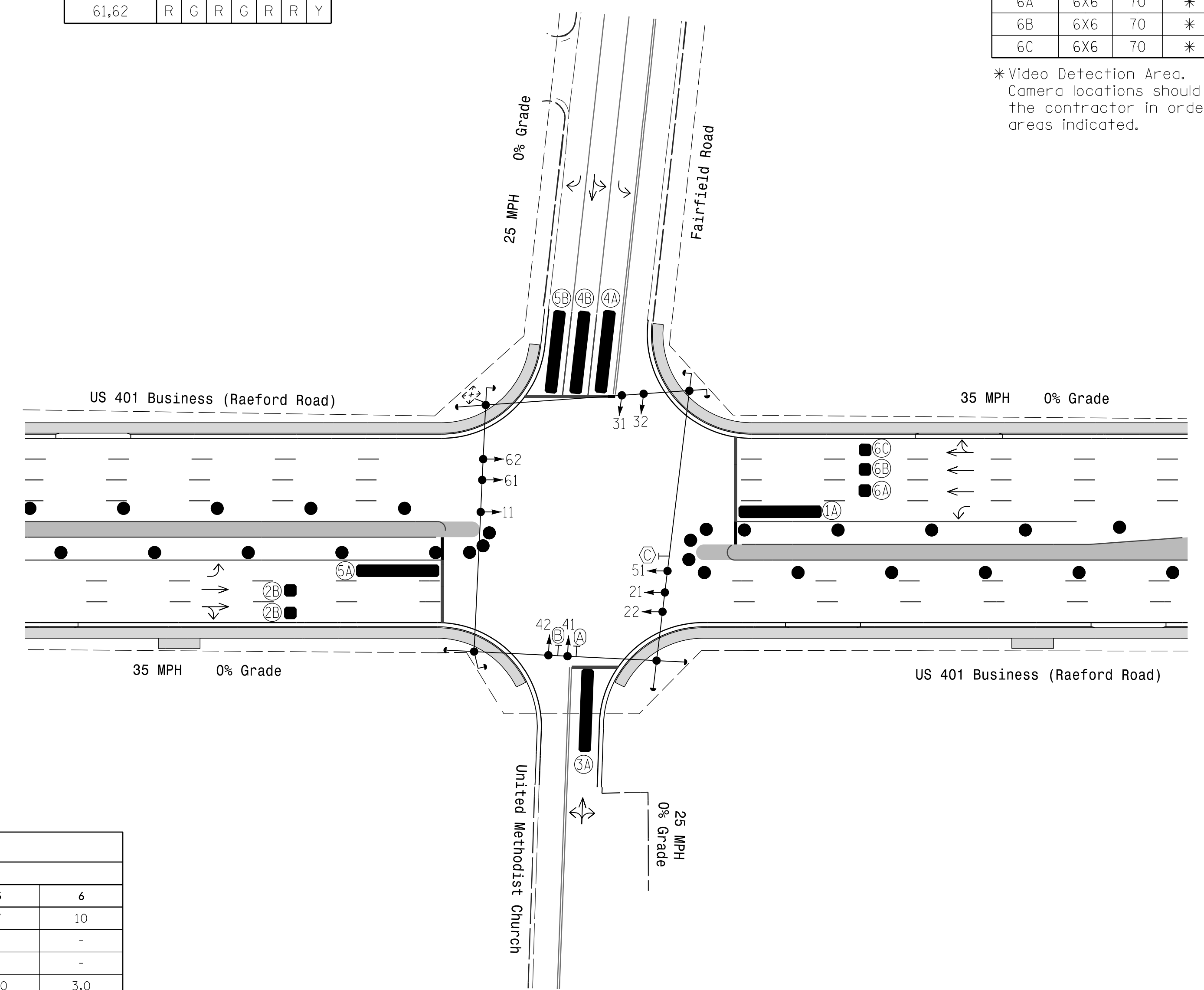

ASC/3 TIMING CHART

FEATURE	PHASE					
	1	2	3	4	5	6
Min Green *	7	10	7	7	7	10
Walk *	-	-	-	-	-	-
Ped Clear	-	-	-	-	-	-
Veh. Extension *	2.0	3.0	2.0	2.0	2.0	3.0
Max 1 *	15	45	20	15	15	45
Yellow	3.0	3.8	3.2	3.2	3.0	3.8
Red Clear	3.3	2.0	3.1	3.1	3.5	2.0
Red Revert	-	-	-	-	-	-
Actuations B4 Add *	-	-	-	-	-	-
Seconds / Actuation *	-	-	-	-	-	-
Max Initial *	-	-	-	-	-	-
Time Before Reduction *	-	-	-	-	-	-
Time To Reduce *	-	-	-	-	-	-
Minimum Gap	-	-	-	-	-	-
Locking Detector	-	X	-	-	-	X
Recall Position	-	VEH. RECALL	-	-	-	VEH. RECALL
Dual Entry	-	-	-	-	-	-
Simultaneous Gap	X	X	X	X	X	X

* These values may be field adjusted. Do not adjust Min Green and Extension times for phases 2 and 6 lower than what is shown. Min Green for all other phases should not be lower than 4 seconds.

LEGEND

PROPOSED	EXISTING
○ → Traffic Signal Head	● → Traffic Signal Head
● → Modified Signal Head	N/A
⊥ → Sign	⊥ → Sign
⊥ → Pedestrian Signal Head With Push Button & Sign	⊥ → Pedestrian Signal Head With Push Button & Sign
⊥ → Signal Pole with Guy	⊥ → Signal Pole with Guy
⊥ → Signal Pole with Sidewalk Guy	⊥ → Signal Pole with Sidewalk Guy
⊥ → Inductive Loop Detector	⊥ → Inductive Loop Detector
⊥ → Controller & Cabinet	⊥ → Controller & Cabinet
⊥ → Junction Box	⊥ → Junction Box
⊥ → 2-in Underground Conduit	⊥ → 2-in Underground Conduit
N/A → Right of Way	→ → Right of Way
→ → Directional Arrow	→ → Directional Arrow
■ → Video Detection Area	N/A
■ → Construction Zone	N/A
● → Construction Zone Drums	N/A
Ⓐ → Left Arrow "ONLY" Sign (R3-5L)	Ⓐ → Left Arrow "ONLY" Sign (R3-5L)
Ⓑ → Combined Through and Left Arrow Sign (R3-6L)	Ⓑ → Combined Through and Left Arrow Sign (R3-6L)
Ⓒ → "U-TURN YIELD TO RIGHT TURN" Sign (R10-16)	Ⓒ → "U-TURN YIELD TO RIGHT TURN" Sign (R10-16)

Signal Upgrade Temporary Signal Design 3 - TMP Phase III

Stantec
 Stantec Consulting Services Inc.
 801 Jones Franklin Road-Suite 300
 Raleigh, NC 27606
 Tel. (919) 851-6866
 Fax. (919) 851-7024
 www.stantec.com
 License No. F-0672

Prepared for the Offices of:
 Transportation Mobility and Safety Division
 STATE OF NORTH CAROLINA
 Signal Design Section
 750 N. Greenfield Pkwy, Garner, NC 27526

US 401 Business (Raeford Road) at Fairfield Road/ United Methodist Church
 Division 6 Cumberland County Fayetteville
 PLAN DATE: March 2018 REVIEWED BY: E D Harris
 PREPARED BY: G B Spell REVIEWED BY: B L Watson

PROFESSIONAL SEAL 29449
 JEFFREY L. WATSON
 ENGINEER
 3/29/2018
 DATE

3/29/2018 10:41:00 AM
 User: rfmancey
 Path: \\c:\projects\signal\design\phase_3\4405\signal\design\06-000113.dgn

DOCUMENT NOT CONSIDERED FINAL UNLESS ALL SIGNATURES COMPLETED

REVISIONS	INIT.	DATE

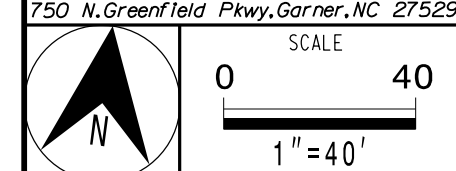

EDI MODEL 2018ECLip-NC CONFLICT MONITOR PROGRAMMING DETAIL

(remove jumpers and set switches as shown)

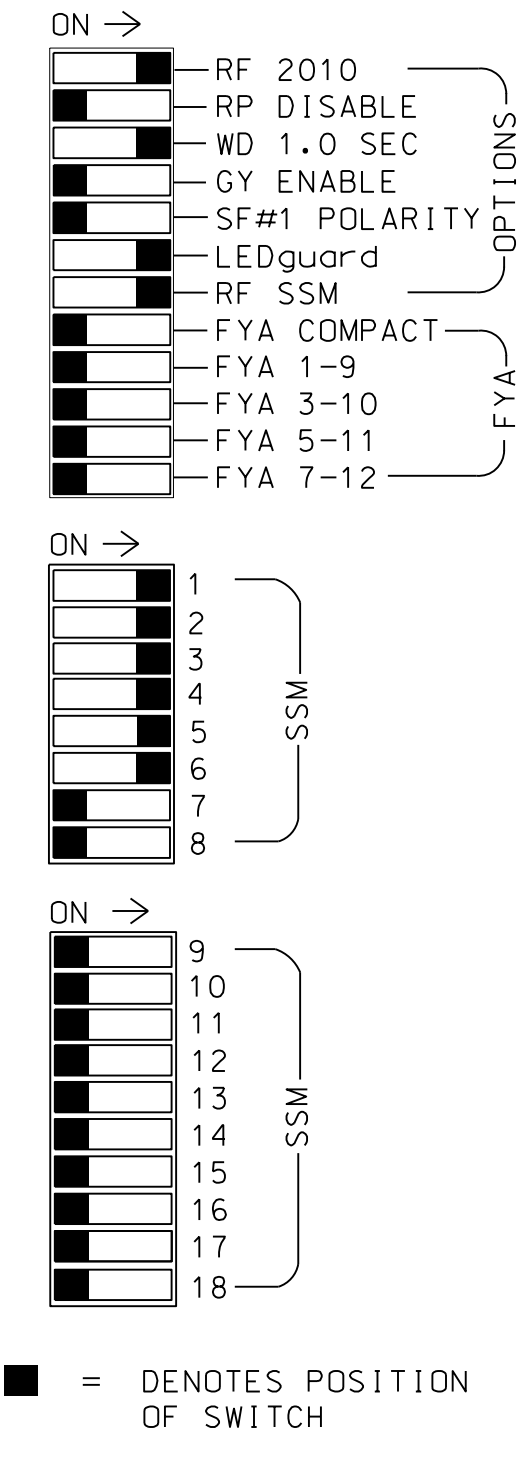
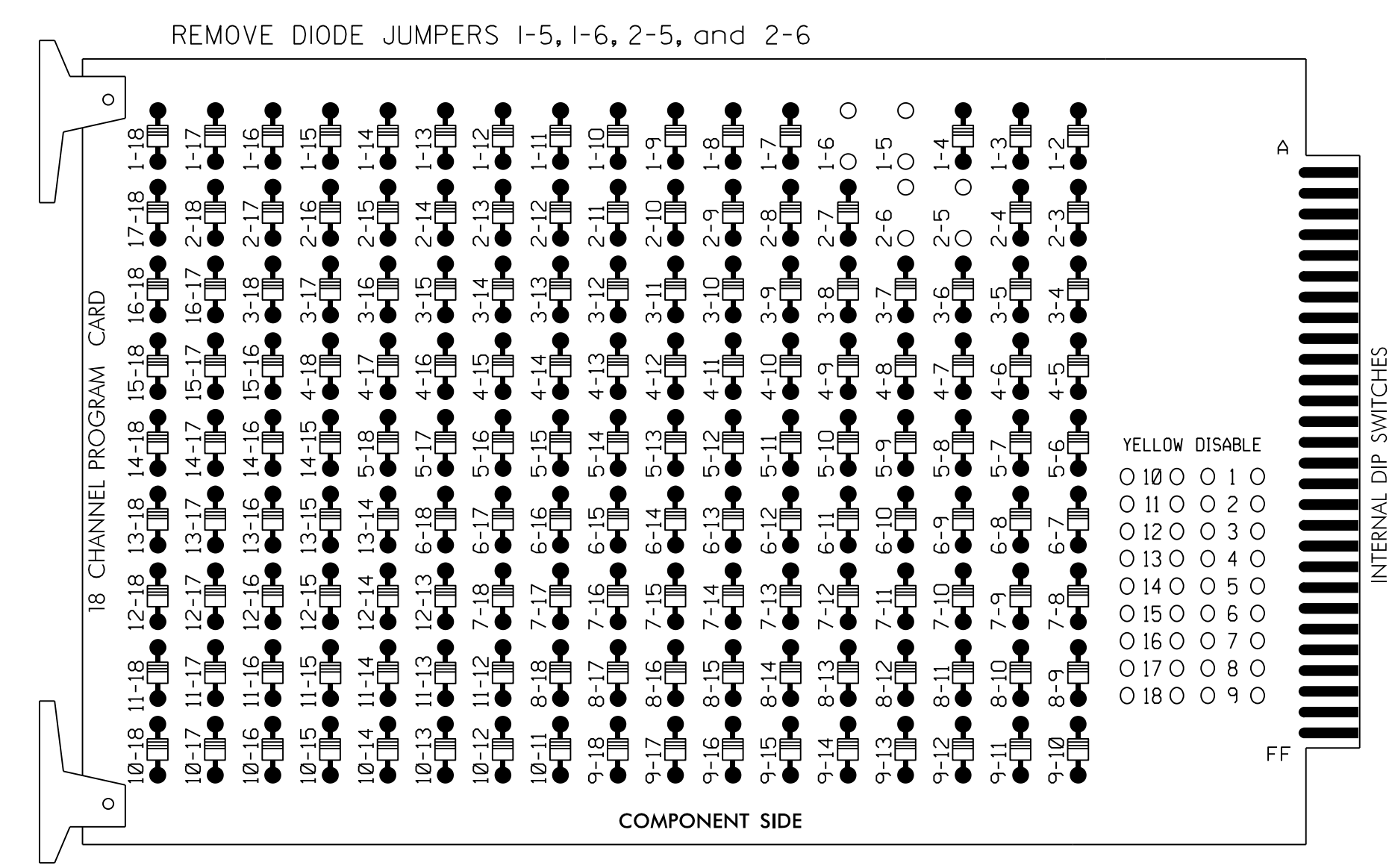

NOTES:

1. Card is provided with all diode jumpers in place. Removal of any jumper allows its channels to run concurrently.
2. Ensure jumpers SEL2-SEL5 and SEL9 are present on the monitor board.
3. Ensure that Red Enable is active at all times during normal operation.
4. Integrate monitor with Ethernet network in cabinet.

NOTES

1. To prevent "flash-conflict" problems, insert red flash program blocks for all unused vehicle load switches in the output file. The installer shall verify that signal heads flash in accordance with the Signal Plans.
2. Return controller to Factory Defaults before programming per this electrical detail.
3. Program controller to start up in Phase 2 Green and Phase 6 Green.
4. The cabinet and controller are part of the Fayetteville Signal System.

EQUIPMENT INFORMATION

CONTROLLER.....2070
 CABINET.....332 W/AUX
 SOFTWARE.....ECONOLITE ASC/3-2070
 CABINET MOUNT.....BASE
 OUTPUT FILE POSITIONS...18 WITH AUX. OUTPUT FILE
 LOAD SWITCHES USED.....S1,S2,S4,S5,S7,S8
 PHASES USED.....1,2,3,4,5,6
 OVERLAP A.....NOT USED
 OVERLAP B.....NOT USED
 OVERLAP C.....NOT USED
 OVERLAP D.....NOT USED

SIGNAL HEAD HOOK-UP CHART

LOAD SWITCH NO.	S1	S2	S3	S4	S5	S6	S7	S8	S9	S10	S11	S12	AUX S1	AUX S2	AUX S3	AUX S4	AUX S5	AUX S6			
CMU CHANNEL NO.	1	2	13	3	4	14	5	6	15	7	8	16	9	10	17	11	12	18			
PHASE	1	2	2 PED	3	3	4	4	4 PED	5	4	6	6 PED	7	8	8 PED	OLA	OLB	SPARE	OLC	OLD	SPARE
SIGNAL HEAD NO.	11	21,22	NU	31	32	41	42	NU	51	42	61,62	NU	NU	NU	NU	NU	NU	NU	NU	NU	NU
RED		128		116	116	101	101					134									
YELLOW		129		117	117	102	102					135									
GREEN		130		118	118	103	103					136									
RED ARROW	125											131									
YELLOW ARROW	126											132	132								
GREEN ARROW	127			118	103							133	133								

NU = Not Used

DETECTOR NOTES

1. For all loops, install a video detection system for vehicle detection. Perform installation according to manufacturer's directions and NCDOT engineer-approved mounting locations to accomplish the detection schemes shown on the Signal Design Plans.
2. Remove "Wired Inputs" from rear of input file to prevent unwanted calls to Phases 2 and 6.

INPUT FILE POSITION LAYOUT

(front view)

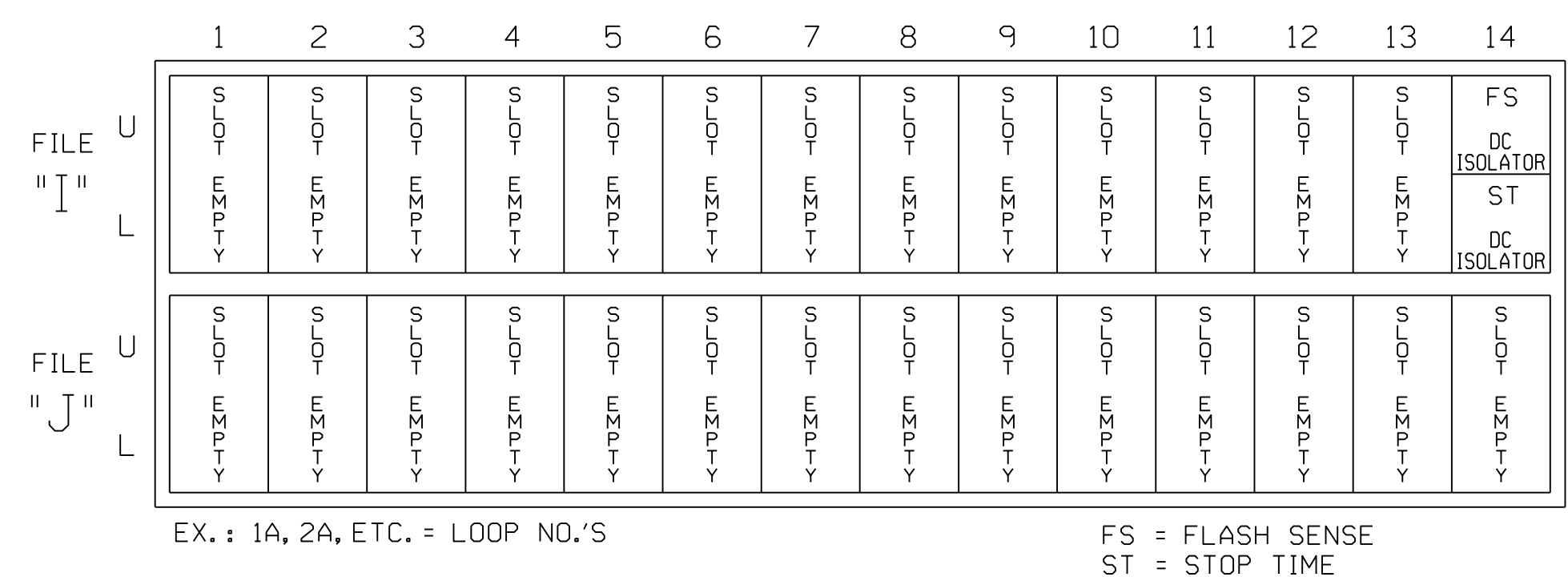

SIGNAL WIRING DETAIL

(wire signal heads as shown)

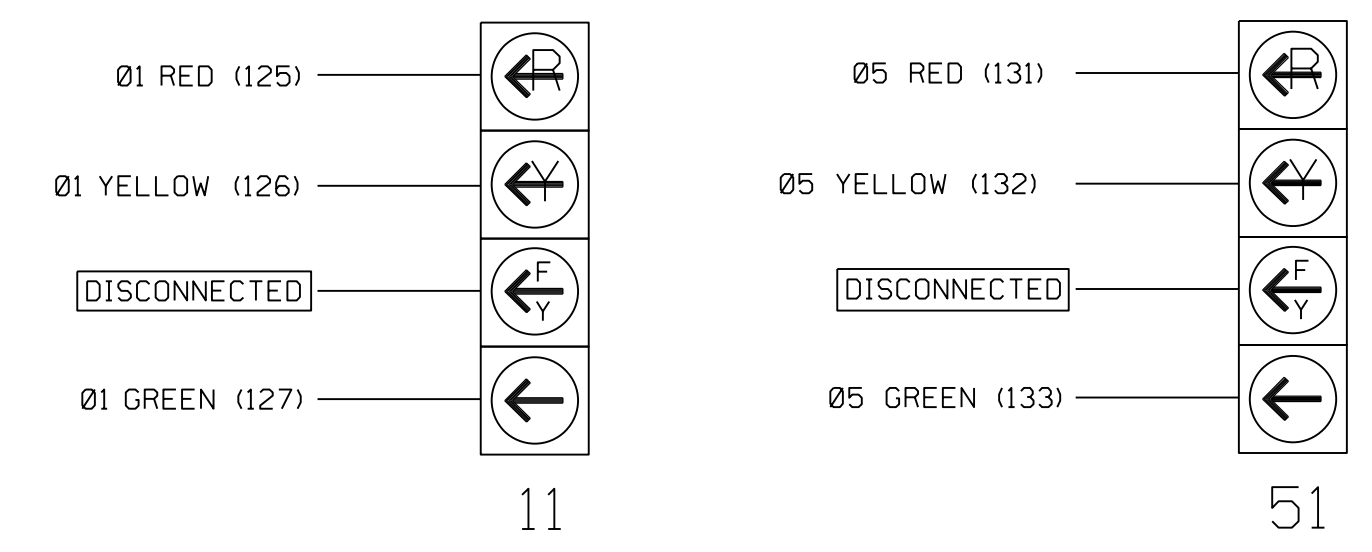

LOAD RESISTOR INSTALLATION DETAIL

(install resistor as shown)

ACCEPTABLE VALUES	
VALUE (ohms)	WATTAGE
1.5K - 1.9K	25W (min)
2.0K - 3.0K	10W (min)

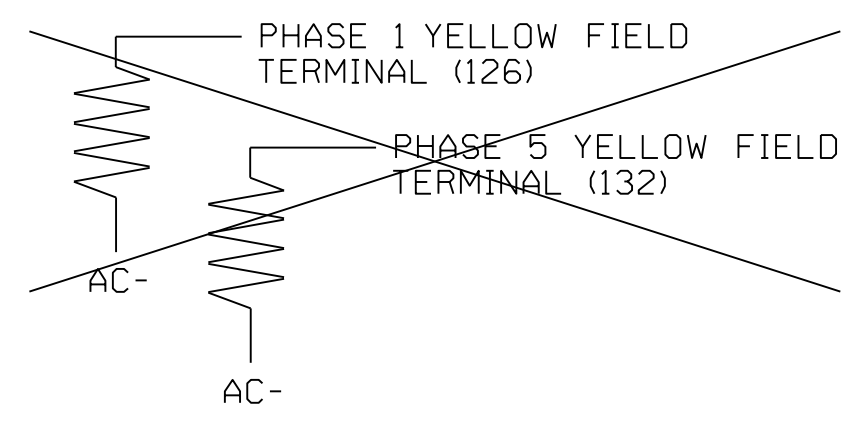

IMPORTANT! Remove resistors from field terminals as shown above, if present.

THIS ELECTRICAL DETAIL IS FOR THE SIGNAL DESIGN: 06-0001T3
 DESIGNED: March 2018
 SEALED: 03-29-2018
 REVISED: N/A

Temporary Design 3 - TMP Phase III
 Electrical Detail

<p>Stantec Consulting Services Inc. 801 Jones Franklin Road-Suite 300 Raleigh, NC 27606 Tel. (919) 851-6866 Fax. (919) 851-7024 www.stantec.com License No. F-0672</p>	ELECTRICAL AND PROGRAMMING DETAILS FOR: Prepared in the Offices of: 	US 401 Business (Raeford Road) at Fairfield Road/ United Methodist Church Division 6 Cumberland County Fayetteville	SEAL NORTH CAROLINA PROFESSIONAL ENGINEER LAWRENCE E. OVERN License No. 045933 3/29/2018
	PREPARED BY: G B Spell REVIEWED BY: L Overn	PLAN DATE: March 2018 REVIEWED DATE: L Overn	REVISIONS: _____ INIT. DATE _____ _____ INIT. DATE _____ _____ INIT. DATE _____

DEFAULT PHASING DIAGRAM

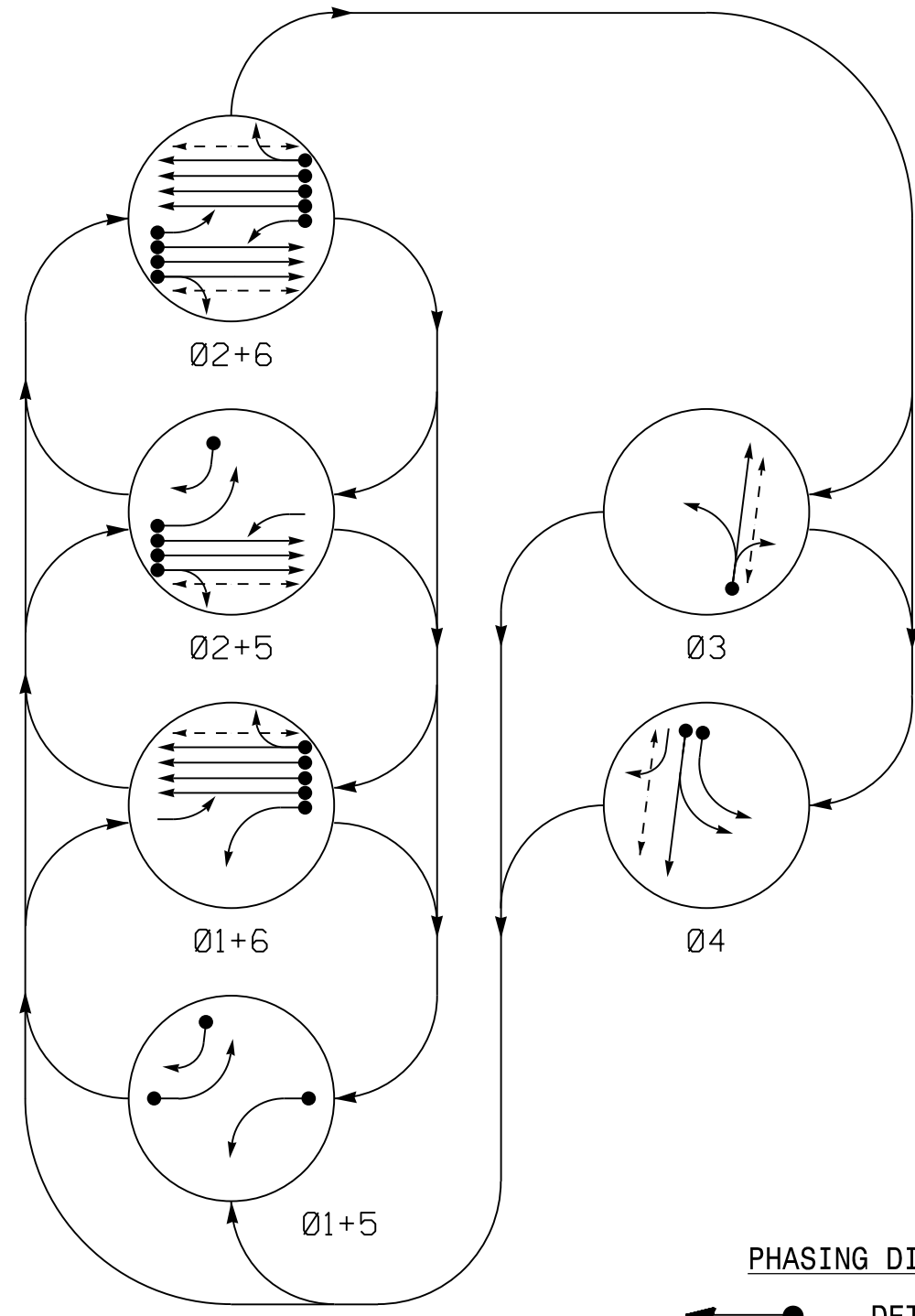

DEFAULT PHASING TABLE OF OPERATION

SIGNAL FACE	PHASE					
	01+5	01+6	02+5	02+6	03	04
11	←	←	←	←	←	←
21,22	R	R	G	G	R	R
31	R	R	R	R	G	R
32	R	R	R	R	G	R
41	R	R	R	R	G	R
42	R	R	R	R	G	R
51	←	←	←	←	←	←
61,62,63	R	G	R	G	R	R
P21,P22	DW	DW	W	W	DW	DRK
P31,P32	DW	DW	DW	DW	W	DRK
P41,P42	DW	DW	DW	DW	W	DRK
P61,P62	DW	W	DW	W	DW	DRK

ALTERNATE PHASING DIAGRAM

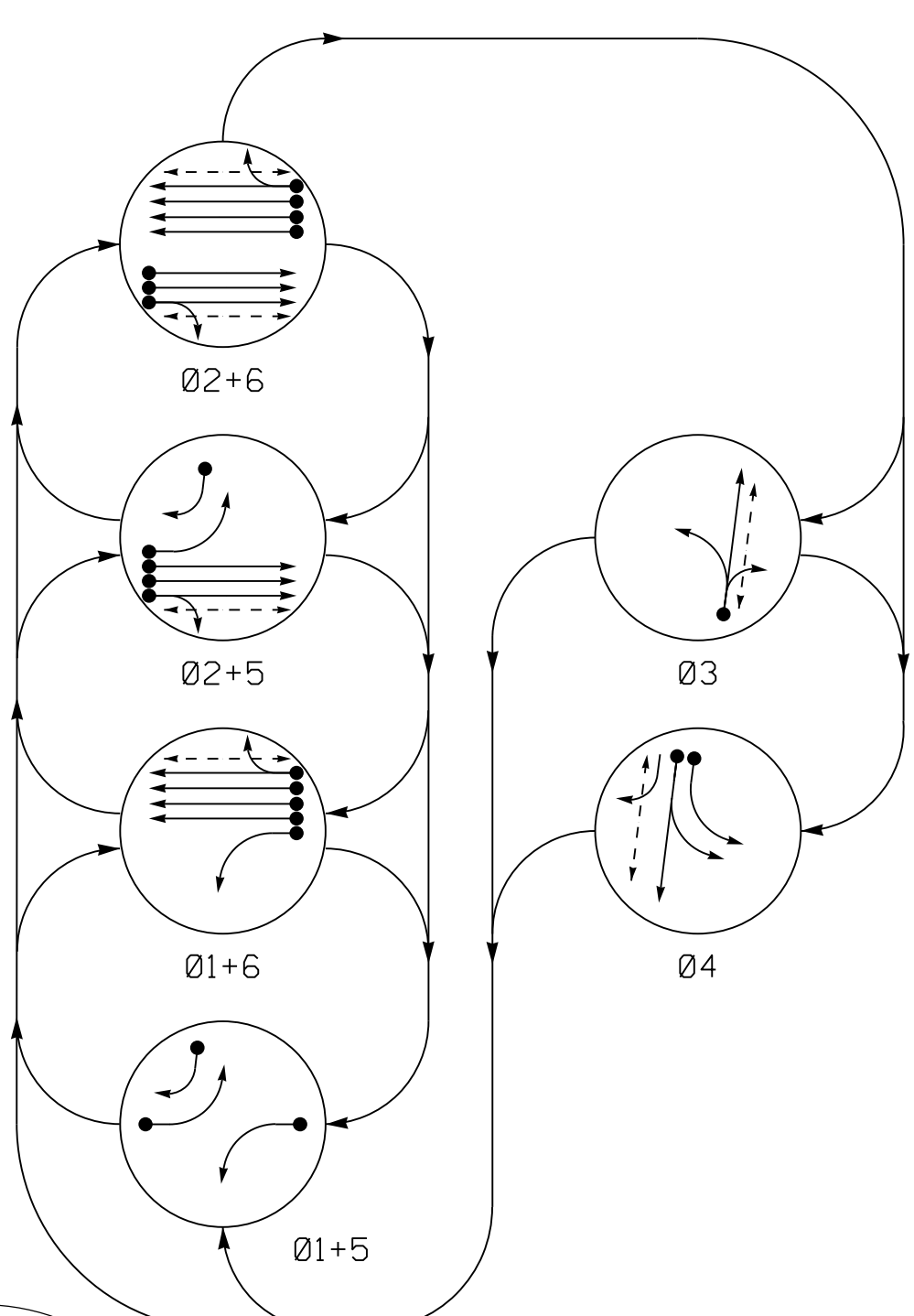

ALTERNATE PHASING TABLE OF OPERATION

SIGNAL FACE	PHASE					
	01+5	01+6	02+5	02+6	03	04
11	←	←	←	←	←	←
21,22	R	R	G	G	R	R
31	R	R	R	R	G	R
32	R	R	R	R	G	R
41	R	R	R	R	G	R
42	R	R	R	R	G	R
51	←	←	←	←	←	←
61,62,63	R	G	R	G	R	R
P21,P22	DW	DW	W	W	DW	DRK
P31,P32	DW	DW	DW	DW	W	DRK
P41,P42	DW	DW	DW	DW	W	DRK
P61,P62	DW	W	DW	W	DW	DRK

ASC/3 DETECTOR INSTALLATION CHART

LOOP	SIZE (FT)	DISTANCE FROM STOPBAR (FT)	TURNS	NEW LOOP	PROGRAMMING							
					PHASE	CALLING	EXTEND TIME	DELAY TIME	LIUSE ADDED INITIAL	TYPE	SYSTEM LOOP	NEW CARD
1A	6X40	0	2-4-2	X	1	Yes	-	15★	-	S	-	X
2A	6X6	70	3	X	2	Yes	-	-	-	S	-	X
2B	6X6	70	3	X	2	Yes	-	-	-	S	-	X
2C	6X6	70	3	X	2	Yes	-	-	-	S	-	X
3A	6X40	0	2-4-2	X	3	Yes	-	5	-	S	-	X
4A	6X40	0	2-4-2	X	4	Yes	-	3	-	S	-	X
4B	6X40	0	2-4-2	X	4	Yes	-	-	-	S	-	X
5A	6X40	0	2-4-2	X	5	Yes	-	15★	-	S	-	X
5B	6X40	0	2-4-2	-	5	Yes	-	15	-	S	-	X
6A	6X6	70	4	X	6	Yes	-	-	-	S	-	X
6B	6X6	70	4	X	6	Yes	-	-	-	S	-	X
6C	6X6	70	4	X	6	Yes	-	-	-	S	-	X
6D	6X6	70	4	X	6	Yes	-	-	-	S	-	X

★Disable Phase(s) call during Alternate Phasing Operation.
 ★Disable delay during Alternate Phasing Operation.

6 Phase Fully Actuated Fayetteville Signal System

NOTES

- Refer to "Roadway Standard Drawings NCDOT" dated January 2018 and "Standard Specifications for Roads and Structures" dated January 2018.
- Do not program signal for late night flashing operation unless otherwise directed by the Engineer.
- Phase 1 and/or Phase 5 may be lagged.
- The order of Phase 3 and Phase 4 may be reversed.
- Set all detector units to presence mode.
- Omit "WALK" and flashing "DON'T WALK" with no pedestrian calls.
- Program pedestrian heads to countdown the flashing "DON'T WALK" time only.
- The Division (City) Traffic Engineer will determine the hours of use for each phasing plan.
- Maximum times shown in timing chart are for free-run operation only. Coordinated signal system timing values supersede these values.
- Pedestrian pedestals are conceptual and shown for reference only. See 2018 NCDOT Roadway Standard Drawings 1705.04 Sheets 1-3 for push button location details.

PHASING DIAGRAM DETECTION LEGEND

- ← ● DETECTED MOVEMENT
- ← ○ UNDETECTED MOVEMENT (OVERLAP)
- ← ○ UNSIGNALIZED MOVEMENT
- ← ○ PEDESTRIAN MOVEMENT

SIGNAL FACE I.D.

All Heads L.E.D.

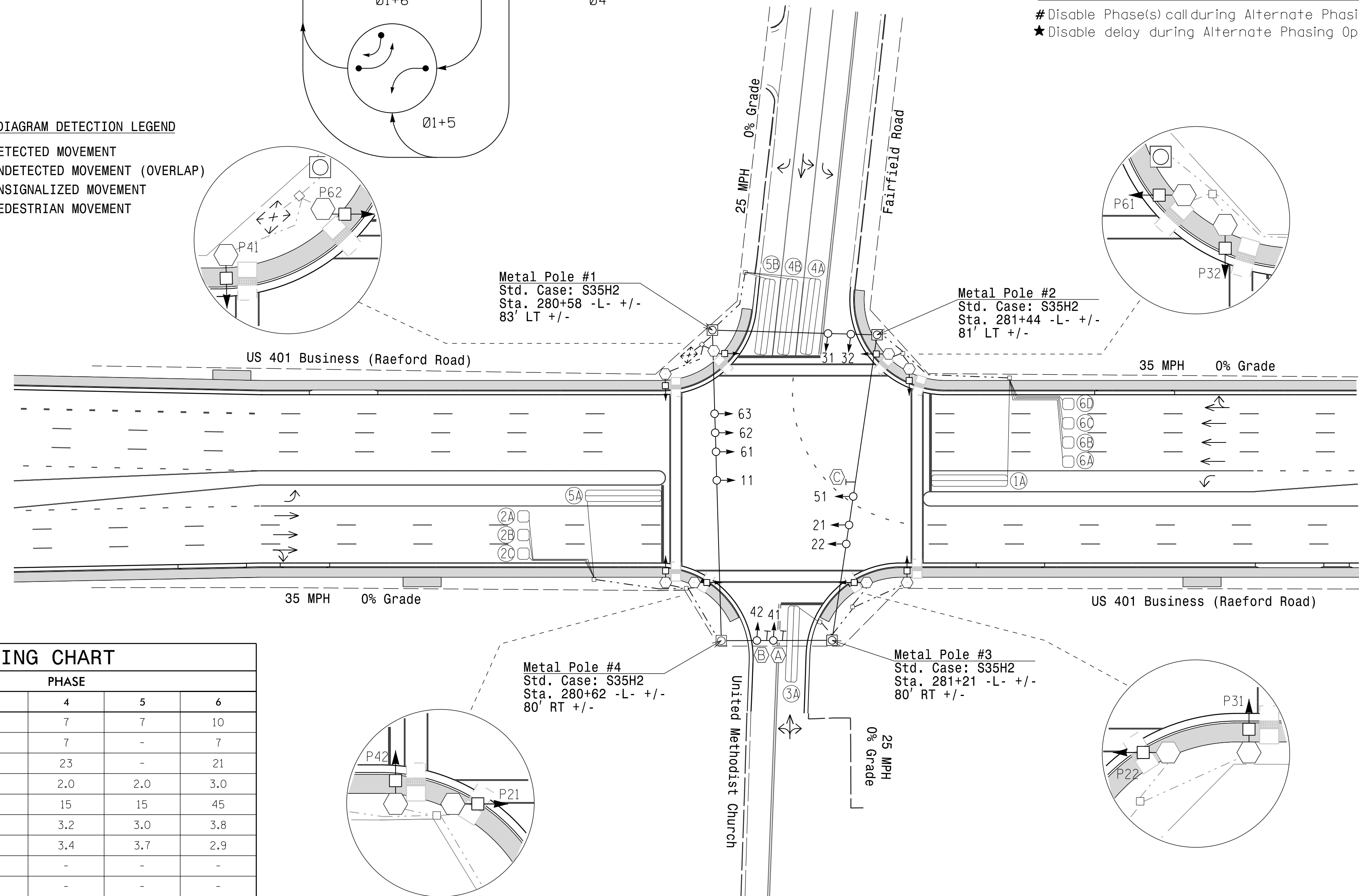
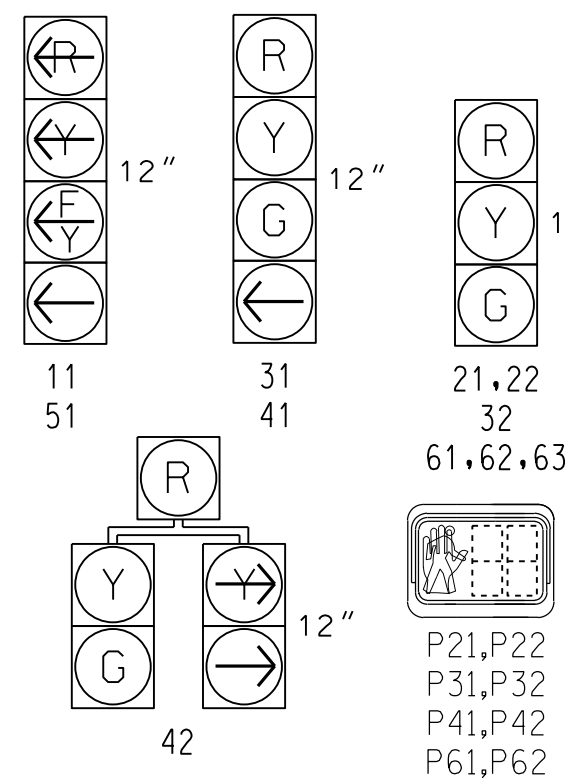

ASC/3 TIMING CHART

FEATURE	PHASE					
	1	2	3	4	5	6
Min Green *	7	10	7	7	7	10
Walk *	-	7	7	7	-	7
Ped Clear	-	18	24	23	-	21
Veh. Extension *	2.0	3.0	2.0	2.0	2.0	3.0
Max I *	15	45	20	15	15	45
Yellow	3.0	3.8	3.2	3.2	3.0	3.8
Red Clear	3.5	2.9	3.3	3.4	3.7	2.9
Red Revert	-	-	-	-	-	-
Actuations B4 Add *	-	-	-	-	-	-
Seconds /Actuation *	-	-	-	-	-	-
Max Initial *	-	-	-	-	-	-
Time Before Reduction *	-	-	-	-	-	-
Time To Reduce *	-	-	-	-	-	-
Minimum Gap	-	-	-	-	-	-
Locking Detector	-	X	-	-	-	X
Recall Position	-	VEH. RECALL	-	-	-	VEH. RECALL
Dual Entry	-	-	-	-	-	-
Simultaneous Gap	X	X	X	X	X	X

* These values may be field adjusted. Do not adjust Min Green and Extension times for phases 2 and 6 lower than what is shown. Min Green for all other phases should not be lower than 4 seconds.

LEGEND

- | PROPOSED | EXISTING |
|--------------------------------------------------|------------------------------------------------|
| ○ Traffic Signal Head | ● N/A |
| ○ Modified Signal Head | - N/A |
| ○ Sign | - N/A |
| ○ Pedestrian Signal Head With Push Button & Sign | - N/A |
| ○ Signal Pole with Guy | ○ Signal Pole with Guy |
| ○ Signal Pole with Sidewalk Guy | ○ Signal Pole with Sidewalk Guy |
| ○ Inductive Loop Detector | ○ Inductive Loop Detector |
| ○ Controller & Cabinet | ○ Controller & Cabinet |
| ○ Junction Box | ○ Junction Box |
| ○ 2-in Underground Conduit | ○ 2-in Underground Conduit |
| -/- Right of Way | -/- Right of Way |
| → Directional Arrow | → Directional Arrow |
| ○ Metal Strain Pole | ○ Metal Strain Pole |
| ○ Type II Signal Pedestal | ○ Type II Signal Pedestal |
| ○ Left Arrow "ONLY" Sign (R3-5L) | ○ Left Arrow "ONLY" Sign (R3-5L) |
| ○ Combined Through and Left Arrow Sign (R3-6L) | ○ Combined Through and Left Arrow Sign (R3-6L) |
| ○ "U-TURN YIELD TO RIGHT TURN" Sign (R10-16) | ○ "U-TURN YIELD TO RIGHT TURN" Sign (R10-16) |

Signal Upgrade - Final Design

Stantec
 Stantec Consulting Services Inc.
 801 Jones Franklin Road-Suite 300
 Raleigh, NC 27606
 Tel. (919) 851-6866
 Fax. (919) 851-7024
 www.stantec.com
 License No. F-0672

Prepared For the Offices of:
 Transportation Mobility and Safety Division
 NORTH CAROLINA DEPARTMENT OF TRANSPORTATION
 STATE OF NORTH CAROLINA
 Signal Design Section
 750 N. Greenfield Pkwy, Garner, NC 27526
 SCALE: 0 40
 1" = 40'

US 401 Business (Raeford Road) at Fairfield Road/ United Methodist Church
 Division 6 Cumberland County Fayetteville
 PLAN DATE: March 2018 REVIEWED BY: E D Harris
 PREPARED BY: G B Spell REVIEWED BY: B L Watson

REVISIONS	INIT.	DATE

DOCUMENT NOT CONSIDERED FINAL UNLESS ALL SIGNATURES COMPLETED

Professional Engineer Seal: 29449
 JEFFREY L. WATSON
 DATE: 3/29/2018
 SIG. INVENTORY NO. 06-0001

3/29/2018 10:41:11 AM
 User: rfmurphy
 C:\Users\rfmurphy\Documents\Signal Design\4405\Sig-73.0.dgn
 Signal Design Section
 User: rfmurphy

EDI MODEL 2018ECLip-NC CONFLICT MONITOR PROGRAMMING DETAIL

(remove jumpers and set switches as shown)

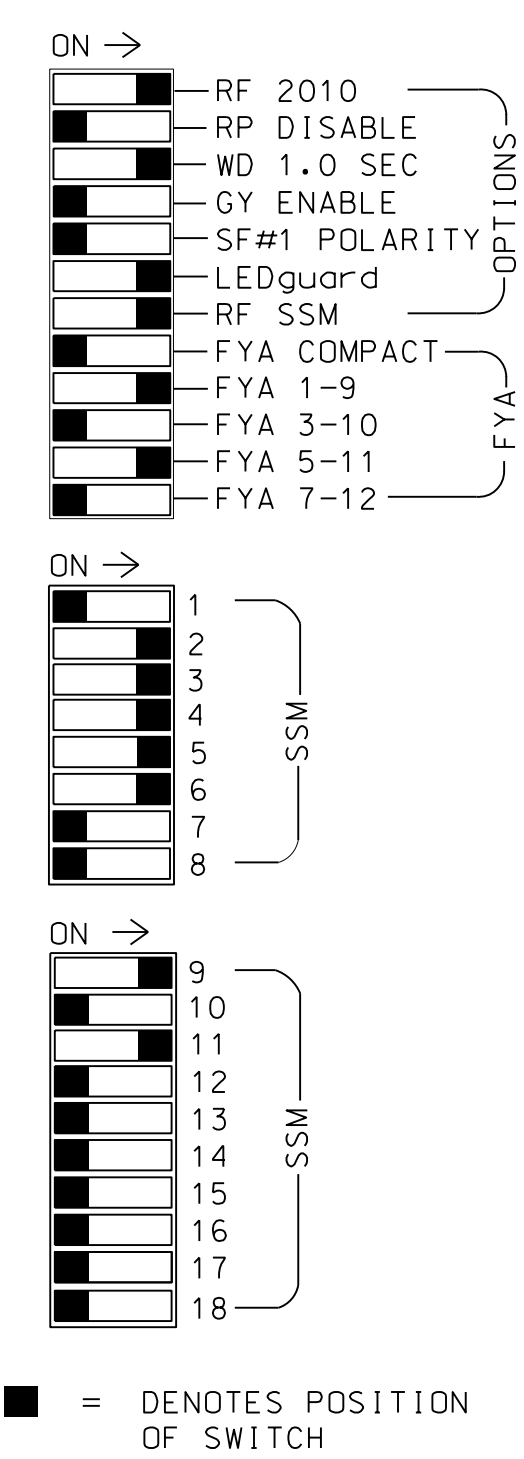
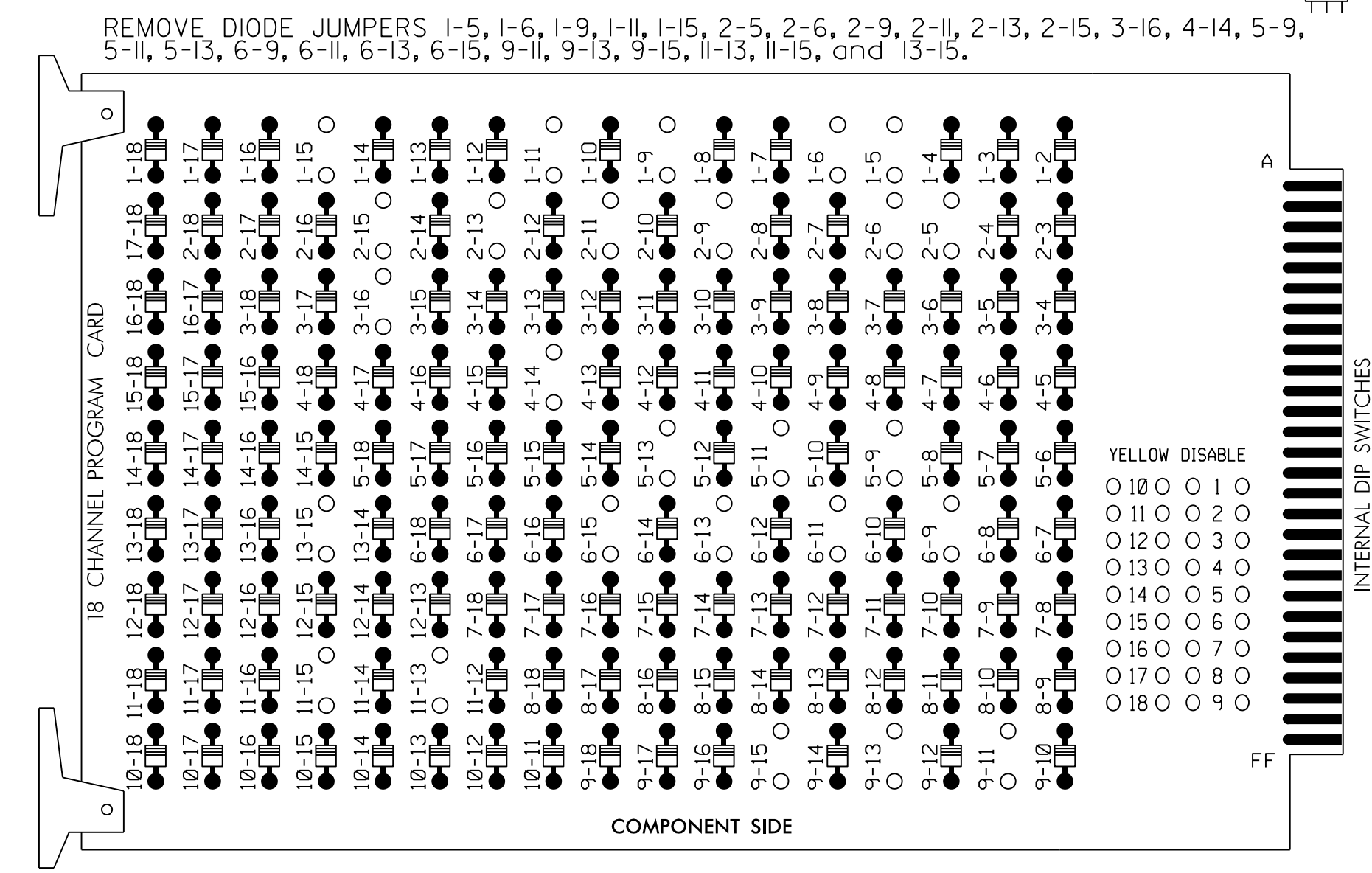

- NOTES:
- Card is provided with all diode jumpers in place. Removal of any jumper allows its channels to run concurrently.
 - Ensure jumpers SEL2-SEL5 and SEL9 are present on the monitor board.
 - Ensure that Red Enable is active at all times during normal operation.
 - Integrate monitor with Ethernet network in cabinet.

NOTES

- To prevent "flash-conflict" problems, insert red flash program blocks for all unused vehicle load switches in the output file. The installer shall verify that signal heads flash in accordance with the Signal Plans.
- Program controller to start up in Phase 2 WALK and Phase 6 WALK.
- The cabinet and controller are part of the Fayetteville Signal System.

EQUIPMENT INFORMATION

CONTROLLER.....2070
 CABINET.....332 W/AUX
 SOFTWARE.....ECONOLITE ASC/3-2070
 CABINET MOUNT.....BASE
 OUTPUT FILE POSITIONS...18 WITH AUX. OUTPUT FILE
 LOAD SWITCHES USED.....S1,S2,S3,S4,S5,S6,S7,S8,
 S9,S12,AUX S1,AUX S4
 PHASES USED.....1,2,2PED,3,4,4PED,5,6,
 6PED,3PED
 OVERLAP A.....*
 OVERLAP B.....NOT USED
 OVERLAP C.....*
 OVERLAP D.....NOT USED
 * See Overlap Programming Detail on Sheet 2

SIGNAL HEAD HOOK-UP CHART

LOAD SWITCH NO.	S1	S2	S3	S4	S5	S6	S7	S8	S9	S10	S11	S12	AUX S1	AUX S2	AUX S3	AUX S4	AUX S5	AUX S6			
CMU CHANNEL NO.	1	2	13	3	4	14	5	6	15	7	8	16	9	10	17	11	12	18			
PHASE	1	2	2 PED	3	3	4	4	4 PED	5	4	6	6 PED	7	8	3 PED	OLA	OLB	SPARE	OLC	OLD	SPARE
SIGNAL HEAD NO.	11	21,22	P21, P22	31	32	41	42	P41, P42	51	42	61,62, 63	P61, P62	11	NU	NU	51	NU	NU	51	NU	NU
RED		128		116	116	101	101		*		134										
YELLOW	*	129		117	117	102	102				135										
GREEN		130		118	118	103	103				136										
RED ARROW													A121						A114		
YELLOW ARROW													A122						A115		
FLASHING YELLOW ARROW													A123						A116		
GREEN ARROW	127			118		103			133	133											
Hand			113					104			119				110						
Walking			115					106			121				112						

NU = Not Used
 * Denotes install load resistor. See load resistor installation detail this sheet.
 ★ See pictorial of head wiring in detail below.

COUNTDOWN PEDESTRIAN SIGNAL OPERATION

Countdown Ped Signals are required to display timing only during Ped Clearance Interval. Consult Ped Signal Module user's manual for instructions on selecting this feature.

INPUT FILE POSITION LAYOUT

(front view)

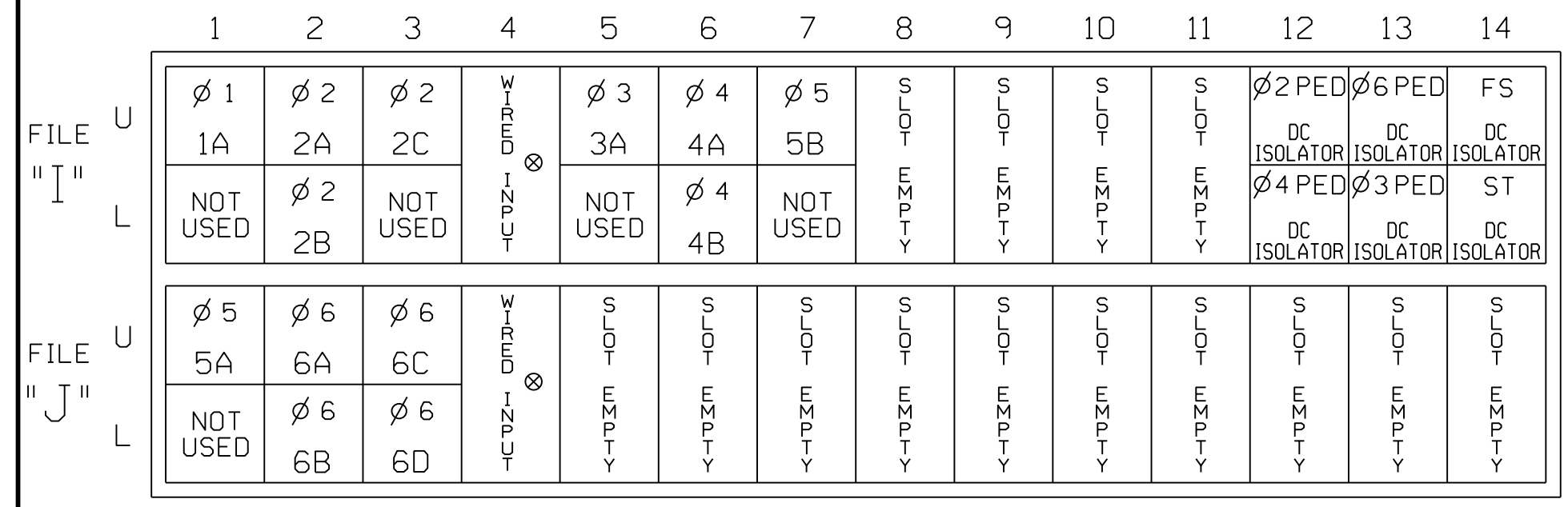

EX.: 1A, 2A, ETC. = LOOP NO.'S
 FS = FLASH SENSE
 ST = STOP TIME
 ⊗ Wired Input - Do not populate slot with detector card

INPUT FILE CONNECTION & PROGRAMMING CHART

LOOP NO.	LOOP TERMINAL	INPUT FILE POS.	PIN NO.	DETECTOR NO.	NEMA PHASE	CALL	EXTEND TIME	DELAY TIME	ADDED INITIAL	DETECTOR TYPE
1A ¹	TB2-1,2	I1U	56	1 ★	1	YES		15		S
	-	J4U	48	26 ★	6	YES				G
2A	TB2-5,6	I2U	39	2	2	YES				S
2B	TB2-7,8	I2L	43	12	2	YES				S
2C	TB2-9,10	I3U	63	32	2	YES				S
3A	TB4-5,6	I5U	58	3	3	YES		5		S
4A	TB4-9,10	I6U	41	4	4	YES		3		S
4B	TB4-11,12	I6L	45	14	4	YES				S
5A ²	TB3-1,2	J1U	55	5 ★	5	YES		15		S
	-	I4U	47	22 ★	2	YES				G
5B	TB6-1,2	I7U	65	34	5	YES		15		S
6A	TB3-5,6	J2U	40	6	6	YES				S
6B	TB3-7,8	J2L	44	16	6	YES				S
6C	TB3-9,10	J3U	64	36	6	YES				S
6D	TB3-11,12	J3L	77	46	6	YES				S

NOTE:
 INSTALL DC ISOLATORS IN INPUT FILE SLOTS 112 AND 113.
¹Add jumper from I1-W to J4-W, on rear of input file.
²Add jumper from J1-W to I4-W, on rear of input file.
 ★ See Vehicle Detector Setup Programming Detail for alternate phasing on Sheet 3.

INPUT FILE POSITION LEGEND: J2L

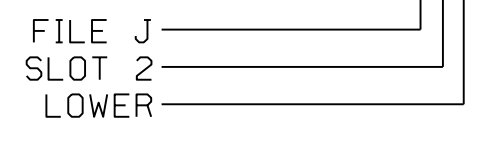

FYA SIGNAL WIRING DETAIL

(wire signal heads as shown)

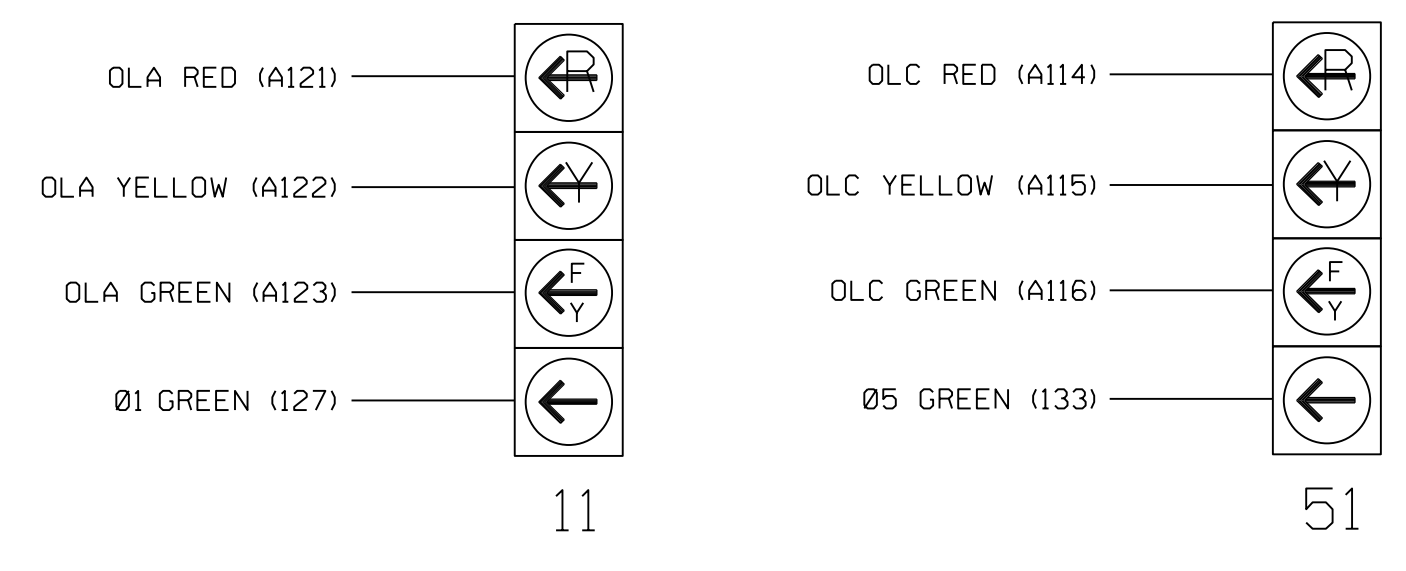

LOAD RESISTOR INSTALLATION DETAIL

(install resistors as shown)

VALUE (ohms)	WATTAGE
1.5K - 1.9K	25W (min)
2.0K - 3.0K	10W (min)

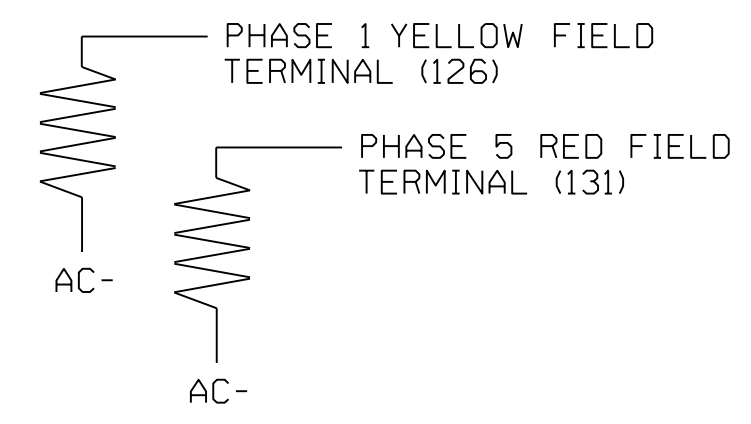

Final Design
 Electrical Detail - Sheet 1 of 3

US 401 Business (Raeford Road)
 at
 Fairfield Road/
 United Methodist Church
 Division 6 Cumberland County Fayetteville

PLAN DATE: March 2018 REVIEWED BY: L Overn
 PREPARED BY: G B Spell REVIEWED BY:

REVISIONS	INIT.	DATE

SEAL
 NORTH CAROLINA
 PROFESSIONAL ENGINEER
 LAWRENCE E. OVERN
 045933
 3/29/2018
 DATE
 SIG. INVENTORY NO. 06-0001

ECONOLITE ASC/3-2070 OVERLAP PROGRAMMING DETAIL *(program controller as shown)*

- From Main Menu select **2. CONTROLLER**
- From CONTROLLER Submenu select **2. VEHICLE OVERLAPS**

OVERLAP A

Select TMG VEH OVLP [A] and 'PPLT FYA'

```

TMG VEH OVLP...[A] TYPE: ....PPLT FYA
PROTECTED LEFT TURN.... PHASE 1
OPPOSING THROUGH..... PHASE 2

FLASHING ARROW OUTPUT....CH9 ISOLATE
DELAY START OF: FYA..0.0 CLEARANCE..0.0
ACTION PLAN SF BIT DISABLE..... 1
    
```

← NOTICE SF BIT DISABLE 1

Toggle Twice

OVERLAP C

Select TMG VEH OVLP [C] and 'PPLT FYA'

```

TMG VEH OVLP...[C] TYPE: ....PPLT FYA
PROTECTED LEFT TURN.... PHASE 5
OPPOSING THROUGH..... PHASE 6

FLASHING ARROW OUTPUT....CH11 ISOLATE
DELAY START OF: FYA..0.0 CLEARANCE..0.0
ACTION PLAN SF BIT DISABLE..... 5
    
```

← NOTICE SF BIT DISABLE 5

END PROGRAMMING

ALTERNATE PHASING ACTIVATION DETAIL

TO RUN ALT. PHASING DURING FREE RUN - PROGRAM CHANGES (SHOWN BELOW) IN A TIME BASED ACTION PLAN. SCHEDULE A DAY PLAN THAT INCLUDES THE ACTION PLAN PROGRAMMED TO SELECT VEH DET PLAN 2 AND ENABLE SF BITS 1 and 5.

TO RUN ALT. PHASING DURING COORDINATION - SELECT THE TIME BASED ACTION PLAN THAT IS PROGRAMMED TO SELECT VEH DET PLAN 2 AND ENABLE SF BITS 1 and 5.

PHASING	VEH DET PLAN	SF BITS ENABLED
ACTIONS REQUIRED TO RUN <u>DEFAULT PHASING</u>	1	NONE
ACTIONS REQUIRED TO RUN <u>ALTERNATE PHASING</u>	2	1, 5

IMPORTANT: IF ALT. PHASING IS USED DURING FREE RUN AND COORDINATION, DO NOT OPERATE TIME OF DAY EVENTS CONCURRENTLY WITH COORDINATION PLAN EVENTS IN THE EVENT SCHEDULER. (EX. FREE RUN EVENT SHOULD END BEFORE COORDINATION PLAN EVENT STARTS AND VICE-VERSA).

ALTERNATE PHASING CHANGE SUMMARY

THE FOLLOWING IS A SUMMARY OF WHAT TAKES PLACE WHEN SF BITS 1 AND 5 AND VEH DET PLAN 2 ACTIVATE TO CALL THE "ALTERNATE PHASING":

SF BITS 1,5: Modifies overlap parent phases for heads 11 and 51 to run protected turns only.

VEH DET PLAN 2: Disables phase 6 call on loop 1A and reduces delay time for phase 1 call on loop 1A to 0 seconds.

Disables phase 2 call on loop 5A and reduces delay time for phase 5 call on loop 5A to 0 seconds.

ECONOLITE ASC/3-2070 ACTION PLAN PROGRAMMING DETAIL

- From Main Menu select **5. TIME BASE**
- From TIME BASE Submenu select **2. ACTION PLAN**

```

ACTION PLAN...[ 1]
PATTERN.....AUTO  SYS OVERRIDE.... NO
TIMING PLAN..... 0  SEQUENCE..... 0
VEH DETECTOR PLAN.. 2  DET LOG.....NONE
FLASH..... --  RED REST..... NO
VEH DET DIAG PLN.. 0  PED DET DIAG PLN..0
DIMMING ENABLE.. NO  PRIORITY RETURN. NO
PED PR RETURN.. NO  QUEUE DELAY..... NO
PMT COND DELAY  NO

PHASE 1 2 3 4 5 6 7 8 9 0 1 2 3 4 5 6
PED RCL . . . . .
WALK 2 . . . . .
VEX 2 . . . . .
VEH RCL . . . . .
MAX RCL . . . . .
MAX 2 . . . . .
PHASE 1 2 3 4 5 6 7 8 9 0 1 2 3 4 5 6
MAX 3 . . . . .
CS INH . . . . .
OMIT . . . . .
SPC FCT X . . . X . . . (1-8)
AUX FCT . . . (1-3)

LP 1-15 . . . . .
LP 16-30 . . . . .
LP 31-45 . . . . .
LP 46-60 . . . . .
LP 61-75 . . . . .
LP 76-90 . . . . .
LP 91-100 . . . . .
    
```

ECONOLITE ASC/3-2070 PED 3 PROGRAMMING ASSIGNMENT DETAIL *(program controller as shown)*

- From Main Menu select **6. DETECTORS**
- From DETECTOR Submenu select **3. PED DETECTOR INPUT ASSIGNMENT**

PED DET PHASE ASSIGNMENT MODE: NTCIP

```

PHASE 1 2 3 4 5 6 7 8
DETECTOR 0 2 8 4 0 6 0 0

PHASE 9 10 11 12 13 14 15 16
DETECTOR 0 0 0 0 0 0 0 0
    
```

← NOTICE PED DETECTOR 8 ASSIGNED TO PHASE 3

- From Main Menu select **1. CONFIGURATION**
- From CONFIGURATION Submenu select **3. LOAD SW ASSIGN**

LD SWITCH ASSIGN

PHASE	DIMMING	---FLASH---
/OVLP TYPE R Y G D	PWR	AUT TGR
1 1 V . . . + A R X		
2 2 V . . . + A Y .		
3 3 V . . . + A R X		
4 4 V . . . + A R .		
5 5 V . . . - A R .		
6 6 V . . . - A Y X		
7 7 V . . . - A R .		
8 8 V . . . - A R X		
9 1 0 . . . + A Y X		
10 2 0 . . . + A R X		
11 3 0 . . . - A Y .		
12 4 0 . . . - A R .		
13 2 P . . . + A . .		
14 4 P . . . - A . .		
15 6 P . . . + A . .		
16 3 P . . . - A . .		

← NOTICE PHASE 3 PED ASSIGNED TO LD SWITCH 16

Final Design
Electrical Detail - Sheet 2 of 3



Stantec Consulting Services Inc.
801 Jones Franklin Road-Suite 300
Raleigh, NC 27606
Tel. (919) 851-6866
Fax. (919) 851-7024
www.stantec.com
License No. F-0672

ELECTRICAL AND PROGRAMMING
DETAILS FOR:

Prepared in the Offices of:

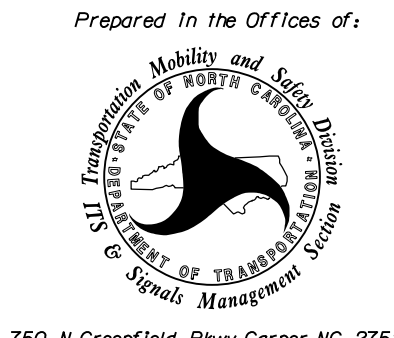

750 N. Greenfield Pkwy, Garner, NC 27529

US 401 Business (Raeford Road)
at
Fairfield Road/
United Methodist Church
Division 6 Cumberland County Fayetteville

PLAN DATE: March 2018 REVIEWED BY: L Overn

PREPARED BY: G B Spell REVIEWED BY:

REVISIONS	INIT.	DATE

SEAL

NORTH CAROLINA
PROFESSIONAL
ENGINEER
LAWRENCE E. OVERN

3/29/2018

DATE

SIG. INVENTORY NO. 06-0001

DATE: U:\Projects\Signal\Signal\electrical\Detail\sig_elec\06-0001.dgn User: rmanney

ECONOLITE ASC/3-2070 VEHICLE DETECTOR SETUP PROGRAMMING DETAIL FOR ALTERNATE PHASING LOOPS 1A, 5A (program controller as shown)

IMPORTANT!

Program detectors per the input file connection and programming chart shown on sheet 1 before proceeding.

- From Main Menu select **8. UTILITIES**
- From UTILITIES Submenu select **1. COPY/CLEAR**
- Copy from DETECTOR PLAN "1" to DETECTOR PLAN "2".

```

COPY / CLEAR UTILITY
FROM          TO
PHASE TIMING... > PHASE TIMING...
TIMING PLAN... > TIMING PLAN...
PH DET OPT PLAN. > PH DET OPT PLAN.
DETECTOR PLAN... 1 > DETECTOR PLAN... 2
TOGGLE TO SELECT A "FROM" AND A "TO"
THEN PRESS ENTER
  
```

- From Main Menu select **6. DETECTORS**
- From DETECTOR Submenu select **2. VEHICLE DETECTOR SETUP**
- Place cursor in VEH DET PLAN [] position and enter "2".

- Place cursor in VEH DETECTOR [] position and enter "1".
 - Set delay time to "0".

```

VEH DETECTOR [ 1 ]  VEH DET PLAN [ 2 ]
TYPE: S-STANDARD
TS2 DETECTOR..... ECPI LOG..... NO
DET PH - 1 2 3 4 5 6 7 8 9 0 1 2 3 4 5 6
1 1
EXTEND TIME... 0.0 DELAY TIME... 0.0
USE ADDED INITIAL . CROSS SWITCH PH.. 0
LOCK IN..... NONE NTCIP VOL . OR OCC .
PMT QUEUE DELAY. NO
  
```

- Place cursor in VEH DETECTOR [] position and enter "26".
 - Set assigned phase to "0".

```

VEH DETECTOR [26]  VEH DET PLAN [ 2 ]
TYPE: G-GREEN EXTENSION/DELAY
TS2 DETECTOR..... ECPI LOG..... NO
DET PH - 1 2 3 4 5 6 7 8 9 0 1 2 3 4 5 6
26 0
EXTEND TIME... 0.0 DELAY TIME... 0.0
USE ADDED INITIAL . CROSS SWITCH PH.. 0
LOCK IN..... NONE NTCIP VOL . OR OCC .
PMT QUEUE DELAY. NO
  
```

- Place cursor in VEH DETECTOR [] position and enter "5".
 - Set delay time to "0".

```

VEH DETECTOR [ 5 ]  VEH DET PLAN [ 2 ]
TYPE: S-STANDARD
TS2 DETECTOR..... ECPI LOG..... NO
DET PH - 1 2 3 4 5 6 7 8 9 0 1 2 3 4 5 6
5 5
EXTEND TIME... 0.0 DELAY TIME... 0.0
USE ADDED INITIAL . CROSS SWITCH PH.. 0
LOCK IN..... NONE NTCIP VOL . OR OCC .
PMT QUEUE DELAY. NO
  
```

- Place cursor in VEH DETECTOR [] position and enter "22".
 - Set assigned phase to "0".

```

VEH DETECTOR [22]  VEH DET PLAN [ 2 ]
TYPE: G-GREEN EXTENSION/DELAY
TS2 DETECTOR..... ECPI LOG..... NO
DET PH - 1 2 3 4 5 6 7 8 9 0 1 2 3 4 5 6
22 0
EXTEND TIME... 0.0 DELAY TIME... 0.0
USE ADDED INITIAL . CROSS SWITCH PH.. 0
LOCK IN..... NONE NTCIP VOL . OR OCC .
PMT QUEUE DELAY. NO
  
```

END PROGRAMMING

THIS ELECTRICAL DETAIL IS FOR
 THE SIGNAL DESIGN: 06-0001
 DESIGNED: March 2018
 SEALED: 03-29-2018
 REVISED: N/A

Final Design
Electrical Detail - Sheet 3 of 3

DOCUMENT NOT CONSIDERED FINAL
UNLESS ALL SIGNATURES COMPLETED



Stantec Consulting Services Inc.
 801 Jones Franklin Road-Suite 300
 Raleigh, NC 27606
 Tel. (919) 851-6866
 Fax. (919) 851-7024
 www.stantec.com
 License No. F-0672

ELECTRICAL AND PROGRAMMING
 DETAILS FOR:

Prepared in the Offices of:

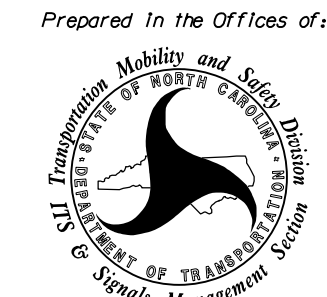

750 N. Greenfield Pkwy, Garner, NC 27529

US 401 Business (Raeford Road)
 at
 Fairfield Road/
 United Methodist Church
 Division 6 Cumberland County Fayetteville

PLAN DATE: March 2018 REVIEWED BY: L Overn
 PREPARED BY: G B Spell REVIEWED BY:

REVISIONS	INIT.	DATE

SEAL

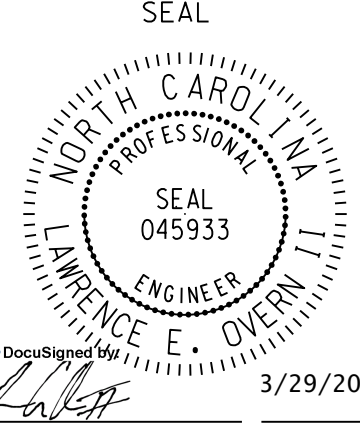

3/29/2018
 DATE

SIG. INVENTORY NO. 06-0001

DATE: 03/29/2018 11:00:00 AM
 User: rfmancey

DEFAULT PHASING DIAGRAM

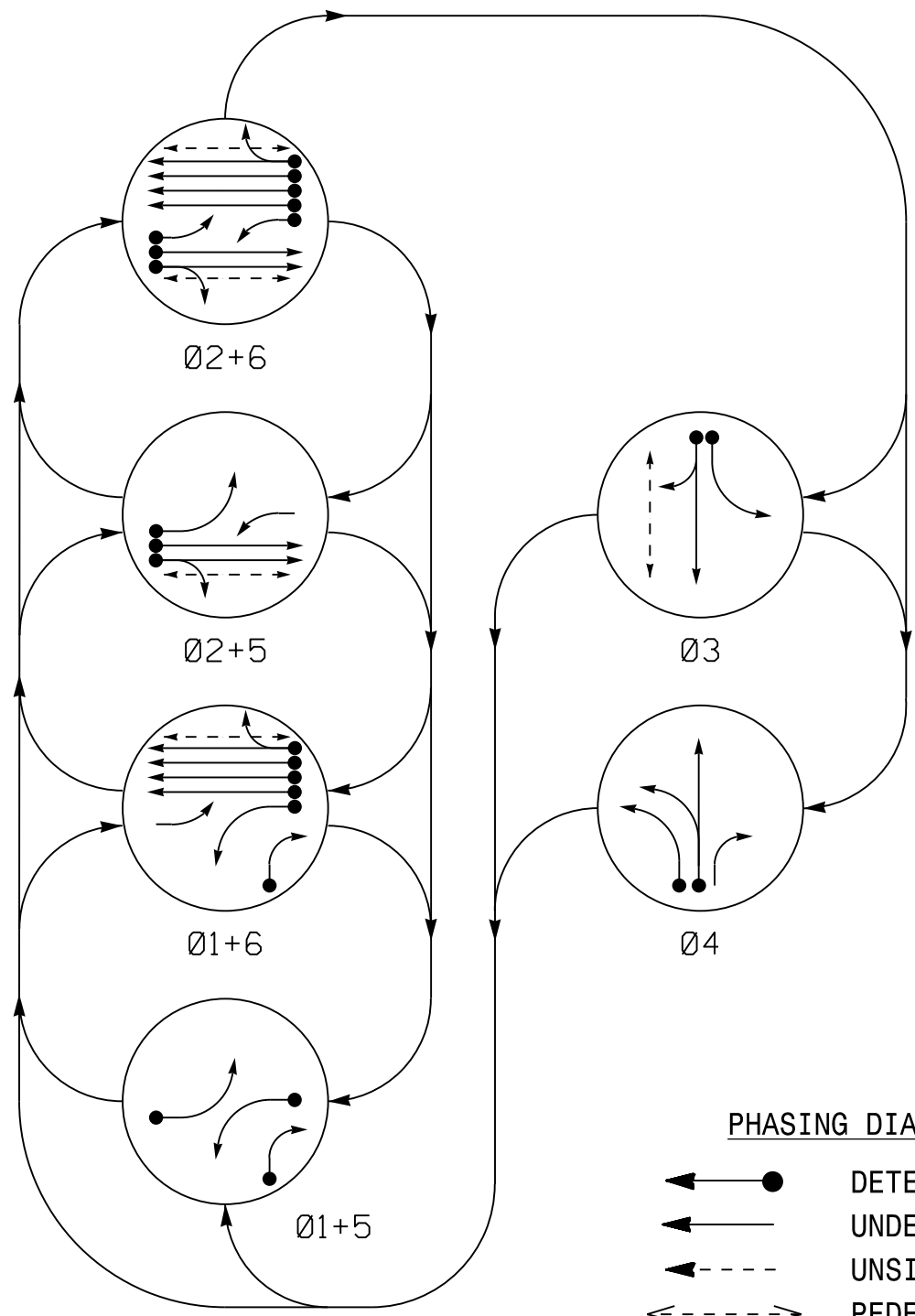

DEFAULT PHASING TABLE OF OPERATION

SIGNAL FACE	PHASE					
	01+5	01+6	02+5	02+6	03	04
11	←	←	←	←	←	←
21,22	R	R	G	G	R	R
31	R	R	R	R	G	R
32	R	R	R	R	G	R
41	R	R	R	R	G	R
42	R	R	R	R	G	R
51	←	←	←	←	←	←
61,62,63	R	G	R	G	R	R
P21,P22	DW	DW	W	W	DW	DRK
P31,P32	DW	DW	DW	DW	W	DRK
P61,P62	DW	W	DW	W	DW	DRK

ALTERNATE PHASING DIAGRAM

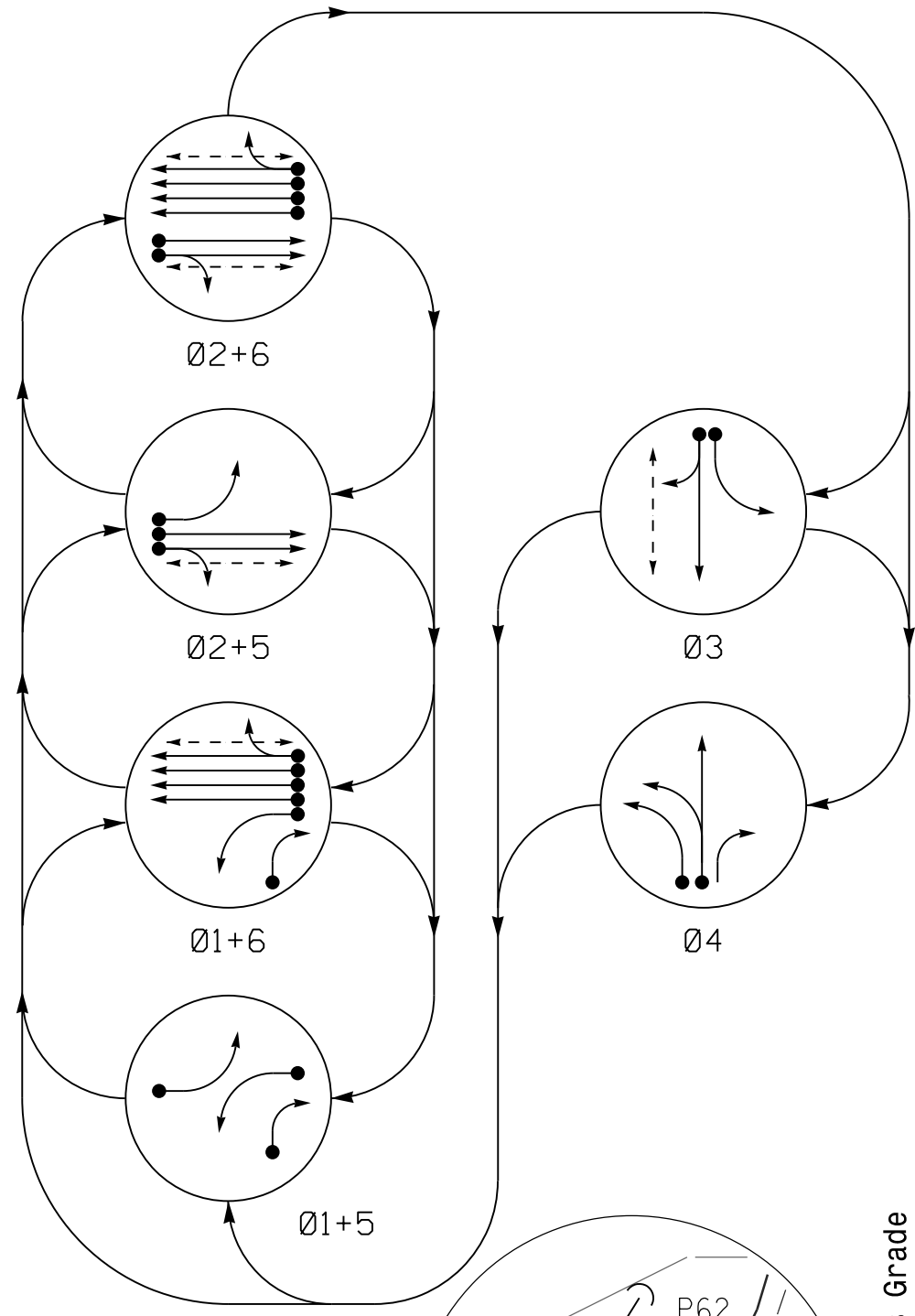

ALTERNATE PHASING TABLE OF OPERATION

SIGNAL FACE	PHASE					
	01+5	01+6	02+5	02+6	03	04
11	←	←	←	←	←	←
21,22	R	R	G	G	R	R
31	R	R	R	R	G	R
32	R	R	R	R	G	R
41	R	R	R	R	G	R
42	R	R	R	R	G	R
51	←	←	←	←	←	←
61,62,63	R	G	R	G	R	R
P21,P22	DW	DW	W	W	DW	DRK
P31,P32	DW	DW	DW	DW	W	DRK
P61,P62	DW	W	DW	W	DW	DRK

ASC/3 DETECTOR INSTALLATION CHART

LOOP	SIZE (FT)	DISTANCE FROM STOPBAR (FT)	TURNS	NEW LOOP	PROGRAMMING							
					PHASE	CALLING	EXTEND TIME	DELAY TIME	USE ADDED INITIAL	TYPE	SYSTEM LOOP	NEW CARD
1A	6X40	0	*	-	1	Yes	-	15★	-	S	-	X
1B	6X40	0	*	-	1	Yes	-	15	-	S	-	X
2A	6X6	70	*	-	2	Yes	-	-	-	S	-	X
2B	6X6	70	*	-	2	Yes	-	-	-	S	-	X
3A	6X40	0	*	-	3	Yes	-	3	-	S	-	X
3B	6X40	0	*	-	3	Yes	-	10	-	S	-	X
4A	6X40	0	*	-	4	Yes	-	3	-	S	-	X
4B	6X40	0	*	-	4	Yes	-	-	-	S	-	X
5A	6X40	0	*	-	5	Yes	-	15★	-	S	-	X
6A	6X6	70	*	-	6	Yes	-	-	-	S	-	X
6B	6X6	70	*	-	6	Yes	-	-	-	S	-	X
6C	6X6	70	*	-	6	Yes	-	-	-	S	-	X
6D	6X6	70	*	-	6	Yes	-	-	-	S	-	X

*Video Detection Area. Camera locations should be confirmed in the field by the contractor in order to provide detection of the areas indicated.
 #Disable Phase(s) calling during Alternate Phasing Operation.
 ★Reduce delay from 15 to 3 seconds during Alternate Phasing Operation.

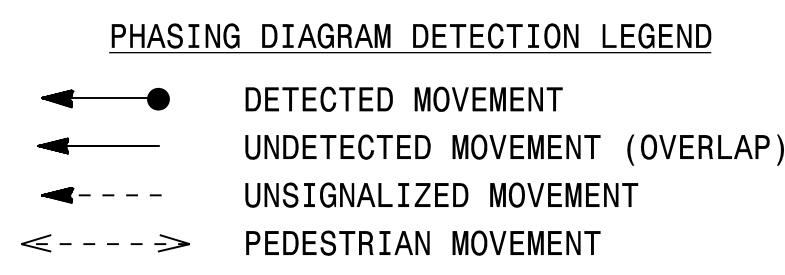

SIGNAL FACE I.D.

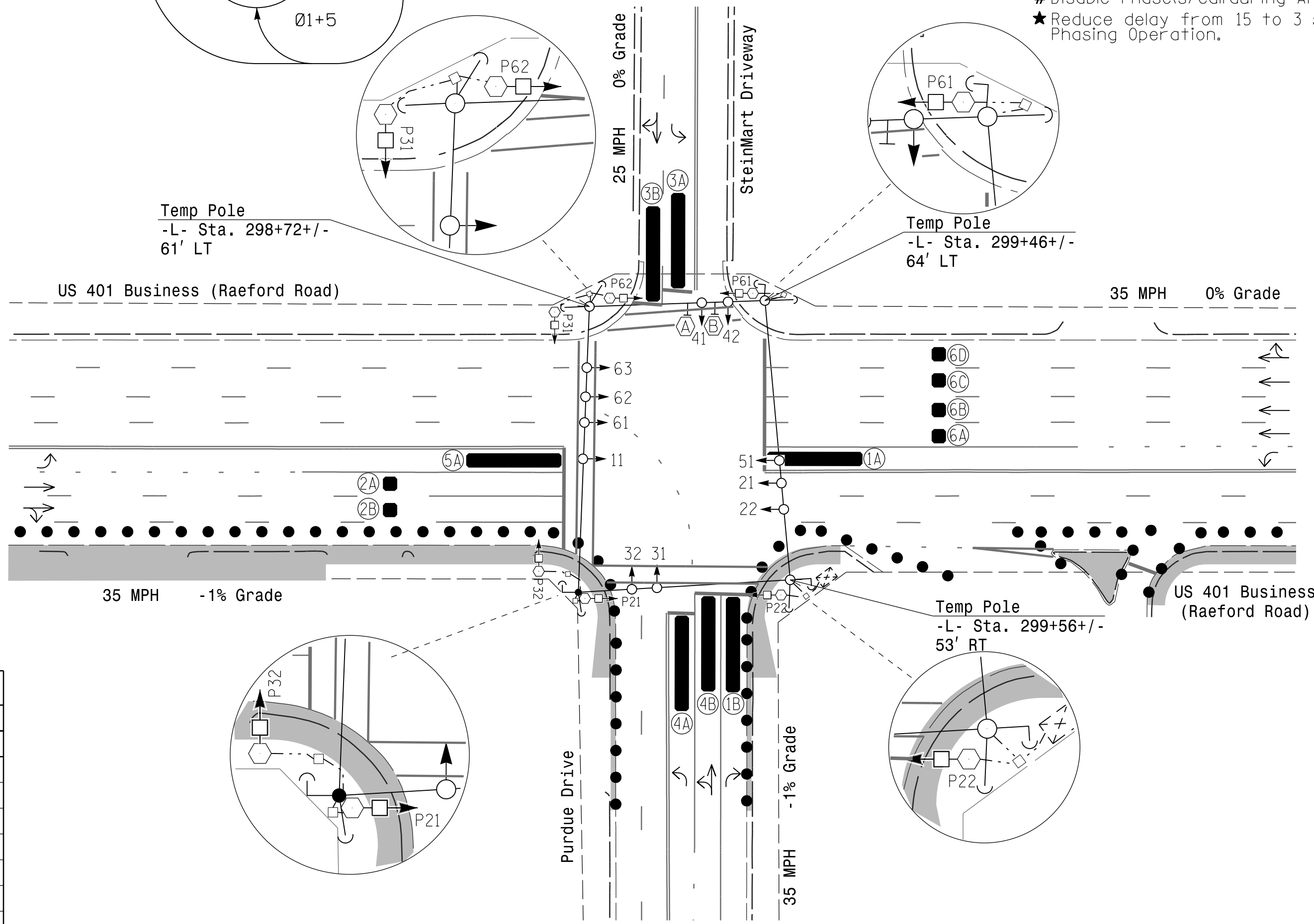
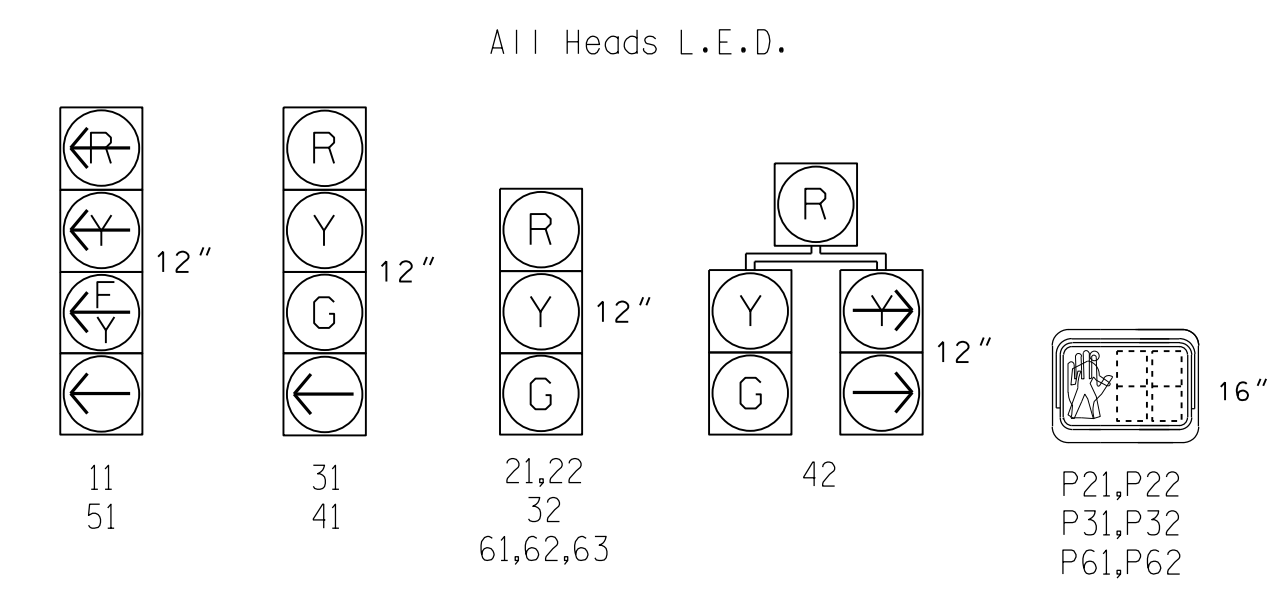

6 Phase Fully Actuated Fayetteville Signal System

- NOTES**
- Refer to "Roadway Standard Drawings NCDOT" dated January 2018 and "Standard Specifications for Roads and Structures" dated January 2018.
 - Do not program signal for late night flashing operation unless otherwise directed by the Engineer.
 - Phase 1 and/or Phase 5 may be lagged.
 - The order of Phase 3 and Phase 4 may be reversed.
 - Set all detector units to presence mode.
 - Locate new cabinet foundation so as not to obstruct sight distance of vehicles turning right on red. Relocate existing cabinet and controller onto new foundation.
 - Omit "WALK" and flashing "DON'T WALK" with no pedestrian calls.
 - Program pedestrian heads to countdown the flashing "DON'T WALK" time only.
 - The Division (City) Traffic Engineer will determine hours of use for each phasing plan. Maximum times shown in timing chart are for free-run operation only. Coordinated signal system timing values supersede these values.
 - Pedestrian pedestals are conceptual and shown for reference only. See NCDOT Roadway Standard Drawings 1705.04 Sheets 1-3 for pushbutton location details.
 - Field adjust temporary poles as needed.

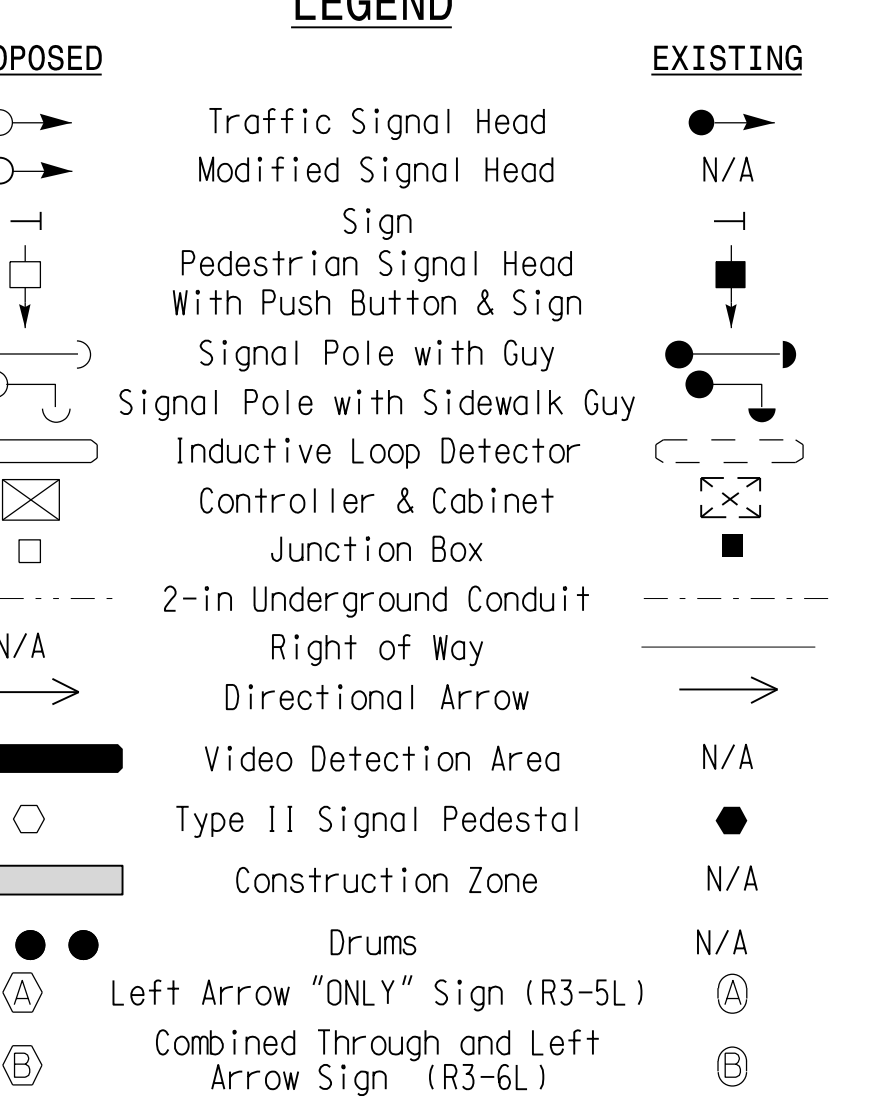

ASC/3 TIMING CHART

FEATURE	PHASE					
	1	2	3	5	6	
Min Green *	7	10	7	7	10	
Walk *	-	7	7	-	7	
Ped Clear	-	17	24	-	12	
Veh. Extension *	2.0	3.0	2.0	2.0	3.0	
Max 1 *	20	90	25	25	90	
Yellow	3.0	3.9	3.2	3.9	3.9	
Red Clear	2.3	2.0	3.1	2.3	2.0	
Red Revert	-	-	-	-	-	
Actuations B4 Add *	-	-	-	-	-	
Seconds / Actuation *	-	-	-	-	-	
Max Initial *	-	-	-	-	-	
Time Before Reduction *	-	-	-	-	-	
Time To Reduce *	-	-	-	-	-	
Minimum Gap	-	-	-	-	-	
Locking Detector	-	X	-	-	X	
Recall Position	-	VEH. RECALL	-	-	VEH. RECALL	
Dual Entry	-	-	-	-	-	
Simultaneous Gap	X	X	X	X	X	

* These values may be field adjusted. Do not adjust Min Green and Extension times for phases 2 and 6 lower than what is shown. Min Green for all other phases should not be lower than 4 seconds.

Signal Upgrade Temporary Design 1 - TMP Phase I

<p>Stantec Consulting Services Inc. 801 Jones Franklin Road-Suite 300 Raleigh, NC 27606 Tel. (919) 851-6866 Fax. (919) 851-7024 www.stantec.com License No. F-0672</p>	<p>750 N. Greenfield Pkwy, Garner, NC 27526</p>	<p>US 401 Business (Raeford Road) at Purdue Drive/SteinMart Driveway</p>		<p>3/29/2018</p>			
		<p>Division 6 Cumberland County Fayetteville</p> <p>PLAN DATE: March 2018 REVIEWED BY: E D Harris</p> <p>PREPARED BY: G B Spell REVIEWED BY: B L Watson</p>	<p>REVISIONS</p> <table border="1"> <thead> <tr> <th>NO.</th> <th>INIT.</th> <th>DATE</th> </tr> </thead> <tbody> <tr> <td> </td> <td> </td> <td> </td> </tr> </tbody> </table>		NO.	INIT.	DATE
NO.	INIT.	DATE					

DOCUMENT NOT CONSIDERED FINAL UNLESS ALL SIGNATURES COMPLETED

3/29/2018 10:44:05 AM User: rfmccoy
 C:\Users\rfmccoy\Documents\Signal Design\Temporary 1\U-4405_Sig.dwg-022411.dgn

EDI MODEL 2018ECLip-NC CONFLICT MONITOR PROGRAMMING DETAIL

(remove jumpers and set switches as shown)

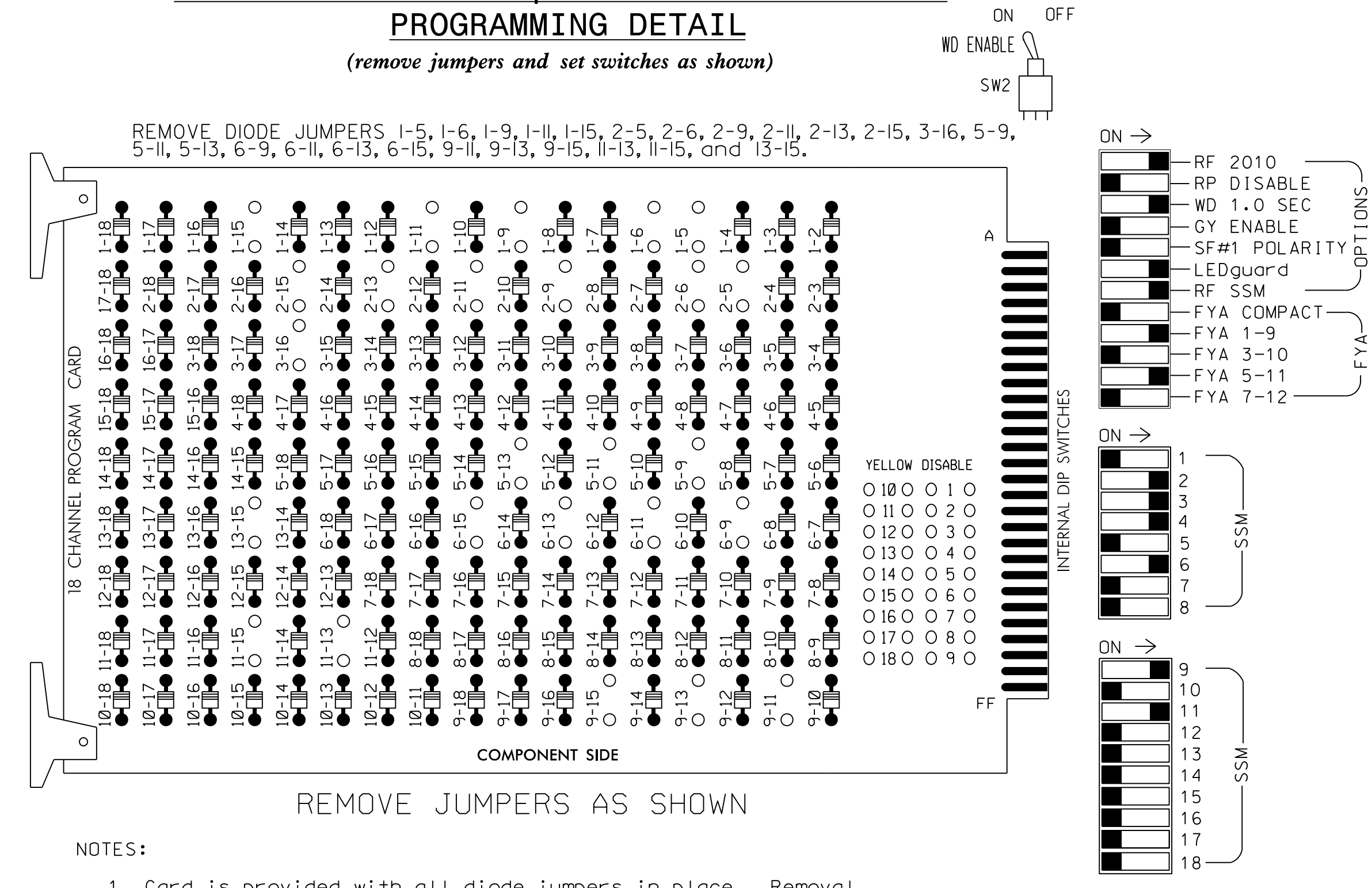

NOTES

- To prevent "flash-conflict" problems, insert red flash program blocks for all unused vehicle load switches in the output file. The installer shall verify that signal heads flash in accordance with the Signal Plans.
- Program controller for start up in Phase 2 WALK and Phase 6 WALK.
- The cabinet and controller are part of the Fayetteville Signal System.

EQUIPMENT INFORMATION

CONTROLLER.....2070
 CABINET.....332 W/AUX
 SOFTWARE.....ECONOLITE ASC/3-2070
 CABINET MOUNT.....BASE
 OUTPUT FILE POSITIONS...18 WITH AUX. OUTPUT FILE
 LOAD SWITCHES USED.....S1,S2,S3,S4,S5,S7,S8,
 S9,S12,AUX S1,AUX S4
 PHASES USED.....1,2,2PED,3,4,5,6,
 6PED,3PED

OVERLAP A.....*
 OVERLAP B.....NOT USED
 OVERLAP C.....*
 OVERLAP D.....NOT USED

* See Overlap Programming Detail on Sheet 2

SIGNAL HEAD HOOK-UP CHART

LOAD SWITCH NO.	S1	S2	S3	S4	S5	S6	S7	S8	S9	S10	S11	S12	AUX S1	AUX S2	AUX S3	AUX S4	AUX S5	AUX S6	
CMU CHANNEL NO.	1	2	13	3	4	14	5	6	15	7	8	16	9	10	17	11	12	18	
PHASE	1	2	2 PED	3	4	4 PED	5	6	6 PED	7	8	3 PED	OLA	OLB	OLE	OLC	OLD	OLF	
SIGNAL HEAD NO.	11★	42	21,22	P21, P22	31	32	41	42	NU	51★	61,62,63	P61, P62	NU	NU	P31, P32	11★	NU	51★	NU
RED	*	128		116	116	101	101					134							
YELLOW		129		117	117	102	102		*			135							
GREEN		130		118	118	103	103					136							
RED ARROW													A121					A114	
YELLOW ARROW		126											A122					A115	
FLASHING YELLOW ARROW													A123					A116	
GREEN ARROW	127	127			118		103					133							
Hand													113						119
Walking																			110
																			115
																			121
																			112

NU = Not Used
 * Denotes install load resistor. See load resistor installation detail this sheet.
 ★ See pictorial of head wiring in detail below.

COUNTDOWN PEDESTRIAN SIGNAL OPERATION

Countdown Ped Signals are required to display timing only during Ped Clearance Interval. Consult Ped Signal Module user's manual for instructions on selecting this feature.

INPUT FILE POSITION LAYOUT

(front view)

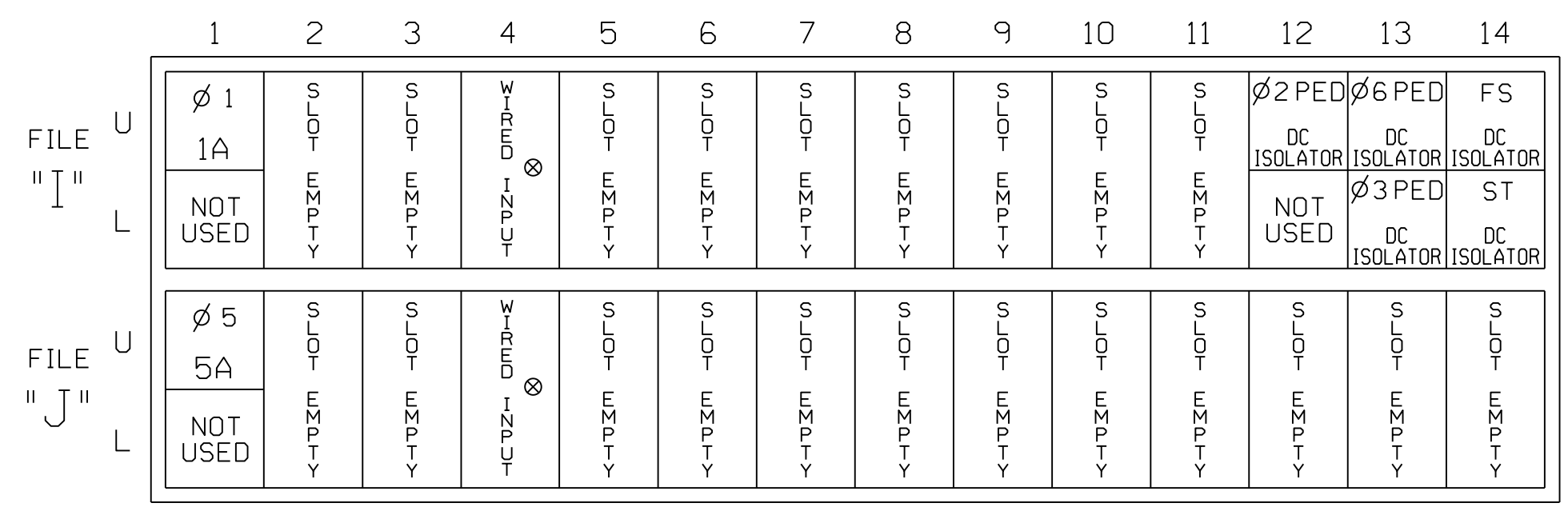

INPUT FILE CONNECTION & PROGRAMMING CHART

LOOP NO.	LOOP TERMINAL	INPUT FILE POS.	PIN NO.	DETECTOR NO.	NEMA PHASE	CALL	EXTEND TIME	DELAY TIME	ADDED INITIAL	DETECTOR TYPE
1A ¹	-	I1U	56	1 ★	1	YES		15		S
5A ²	-	J4U	48	26 ★	6	YES				S
	-	J1U	55	5 ★	5	YES		15		S
	-	I4U	47	22 ★	2	YES				S

NOTE:
 INSTALL DC ISOLATORS IN INPUT FILE SLOTS 112 AND 113.

- Add jumper from I1-W to J4-W, on rear of input file.
 - Add jumper from J1-W to I4-W, on rear of input file.
- ★ See Vehicle Detector Setup Programming Detail for alternate phasing on Sheet 3.

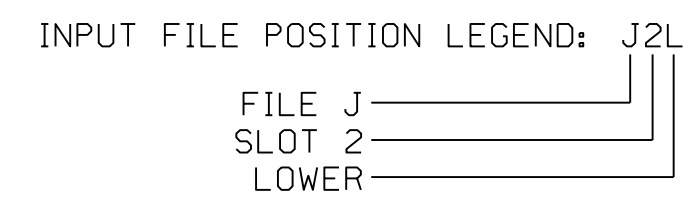

DETECTOR NOTES

- For all loops install a video detection system for vehicle detection. Perform installation according to manufacturer's directions and NCDOT engineer-approved mounting locations to accomplish the detection schemes shown on the Signal Design Plans.
- For loops 1A and 5A detector card placements and slots reserved for wired inputs are typical for a NCDOT installation. Inputs associated with these slots are compatible with time of day instructions located on sheets 2 and 3 of this electrical detail.

LOAD RESISTOR INSTALLATION DETAIL

(install resistors as shown)

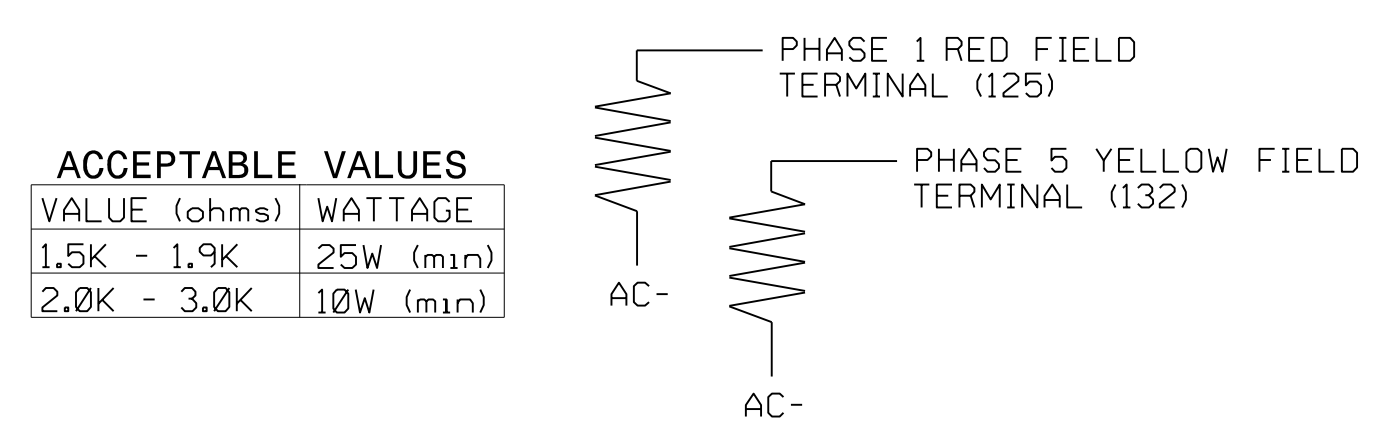

Temporary Design 1 - TMP Phase I Electrical Detail - Sheet 1 of 3

Stantec Consulting Services Inc.
 801 Jones Franklin Road-Suite 300
 Raleigh, NC 27606
 Tel. (919) 851-6866
 Fax. (919) 851-7024
 www.stantec.com
 License No. F-0672

ELECTRICAL AND PROGRAMMING DETAILS FOR:

Prepared in the Offices of:

750 N. Greenfield Pkwy, Garner, NC 27529

US 401 Business (Raeford Road) at Purdue Drive/SteinMart Driveway

Division 6 Cumberland County Fayetteville

PLAN DATE: March 2018 REVIEWED BY: L Overn

PREPARED BY: G B Spell REVIEWED BY:

REVISIONS	INIT.	DATE

SEAL

3/29/2018

SIG. INVENTORY NO. 06-0224T1

THIS ELECTRICAL DETAIL IS FOR THE SIGNAL DESIGN: 06-0224T1
 DESIGNED: March 2018
 SEALED: 03-29-2018
 REVISED: N/A

ECONOLITE ASC/3-2070 OVERLAP PROGRAMMING DETAIL

(program controller as shown)

- From Main Menu select 2. CONTROLLER
- From CONTROLLER Submenu select 2. VEHICLE OVERLAPS

```

OVERLAP A
Select TMG VEH OVLP [A] and 'PPLT FYA'
TMG VEH OVLP...[A] TYPE: ....PPLT FYA
PROTECTED LEFT TURN.... PHASE 1
OPPOSING THROUGH..... PHASE 2

FLASHING ARROW OUTPUT....CH9 ISOLATE
DELAY START OF: FYA..0.0 CLEARANCE..0.0
ACTION PLAN SF BIT DISABLE..... 1
    
```

← NOTICE SF BIT DISABLE 1

Toggle Twice

```

OVERLAP C
Select TMG VEH OVLP [C] and 'PPLT FYA'
TMG VEH OVLP...[C] TYPE: ....PPLT FYA
PROTECTED LEFT TURN.... PHASE 5
OPPOSING THROUGH..... PHASE 6

FLASHING ARROW OUTPUT....CH11 ISOLATE
DELAY START OF: FYA..0.0 CLEARANCE..0.0
ACTION PLAN SF BIT DISABLE..... 5
    
```

← NOTICE SF BIT DISABLE 5

END PROGRAMMING

ALTERNATE PHASING ACTIVATION DETAIL

TO RUN ALT. PHASING DURING FREE RUN - PROGRAM CHANGES (SHOWN BELOW) IN A TIME BASED ACTION PLAN. SCHEDULE A DAY PLAN THAT INCLUDES THE ACTION PLAN PROGRAMMED TO SELECT VEH DET PLAN 2 AND ENABLE SF BITS 1 and 5.

TO RUN ALT. PHASING DURING COORDINATION - SELECT THE TIME BASED ACTION PLAN THAT IS PROGRAMMED TO SELECT VEH DET PLAN 2 AND ENABLE SF BITS 1 and 5.

PHASING	VEH DET PLAN	SF BITS ENABLED
ACTIONS REQUIRED TO RUN <u>DEFAULT PHASING</u>	1	NONE
ACTIONS REQUIRED TO RUN <u>ALTERNATE PHASING</u>	2	1, 5

IMPORTANT: IF ALT. PHASING IS USED DURING FREE RUN AND COORDINATION, DO NOT OPERATE TIME OF DAY EVENTS CONCURRENTLY WITH COORDINATION PLAN EVENTS IN THE EVENT SCHEDULER. (EX. FREE RUN EVENT SHOULD END BEFORE COORDINATION PLAN EVENT STARTS AND VICE-VERSA).

ALTERNATE PHASING CHANGE SUMMARY

THE FOLLOWING IS A SUMMARY OF WHAT TAKES PLACE WHEN SF BITS 1 AND 5 AND VEH DET PLAN 2 ACTIVATE TO CALL THE "ALTERNATE PHASING":

SF BITS 1,5: Modifies overlap parent phases for heads 11 and 51 to run protected turns only.

VEH DET PLAN 2: Disables phase 6 call on loop 1A and reduces delay time for phase 1 call on loop 1A to 3 seconds.

Disables phase 2 call on loop 5A and reduces delay time for phase 5 call on loop 5A to 3 seconds.

ECONOLITE ASC/3-2070 ACTION PLAN PROGRAMMING DETAIL

- From Main Menu select 5. TIME BASE
- From TIME BASE Submenu select 2. ACTION PLAN

```

ACTION PLAN...[ 1]
PATTERN.....AUTO  SYS OVERRIDE.... NO
TIMING PLAN..... 0  SEQUENCE..... 0
VEH DETECTOR PLAN.. 2  DET LOG.....NONE
FLASH..... --  RED REST..... NO
VEH DET DIAG PLN... 0  PED DET DIAG PLN..0
DIMMING ENABLE.. NO  PRIORITY RETURN. NO
PED PR RETURN.. NO  QUEUE DELAY..... NO
PMT COND DELAY  NO

PHASE 1 2 3 4 5 6 7 8 9 0 1 2 3 4 5 6
PED RCL . . . . .
WALK 2 . . . . .
VEX 2 . . . . .
VEH RCL . . . . .
MAX RCL . . . . .
MAX 2 . . . . .
PHASE 1 2 3 4 5 6 7 8 9 0 1 2 3 4 5 6
MAX 3 . . . . .
CS 1NH . . . . .
DMIT . . . . .
SPC FCT X . . . X . . . (1-8)
AUX FCT . . . (1-3)

LP 1-15 . . . . .
LP 16-30 . . . . .
LP 31-45 . . . . .
LP 46-60 . . . . .
LP 61-75 . . . . .
LP 76-90 . . . . .
LP 91-100 . . . . .
    
```

ECONOLITE ASC/3-2070 PED 3 PROGRAMMING ASSIGNMENT DETAIL

(program controller as shown)

- From Main Menu select 6. DETECTORS
- From DETECTOR Submenu select 3. PED DETECTOR INPUT ASSIGNMENT

PED DET PHASE ASSIGNMENT MODE: NTCIP																	
PHASE	1	2	3	4	5	6	7	8	PHASE	9	10	11	12	13	14	15	16
DETECTOR	0	2	8	0	0	6	0	0	DETECTOR	0	0	0	0	0	0	0	0

← NOTICE PED DETECTOR 8 ASSIGNED TO PHASE 3

- From Main Menu select 1. CONFIGURATION
- From CONFIGURATION Submenu select 3. LOAD SW ASSIGN

LD SWITCH ASSIGN									
PHASE	DIMMING	---	FLASH---						
/OVLP	TYPE	R	Y	G	D	PWR	AUT	TGR	
1	1	V	A	R	X
2	2	V	A	Y	.
3	3	V	A	R	X
4	4	V	A	R	.
5	5	V	A	R	.
6	6	V	A	Y	X
7	7	V	A	R	.
8	8	V	A	R	X
9	1	O	A	R	X
10	2	O	A	R	X
11	3	O	A	R	.
12	4	O	A	R	.
13	2	P	A	.	.
14	4	P	A	.	.
15	6	P	A	.	.
16	3	P	A	.	.

← NOTICE PHASE 3 PED ASSIGNED TO LD SWITCH 16

Temporary Design 1 - TMP Phase I
Electrical Detail - Sheet 2 of 3

THIS ELECTRICAL DETAIL IS FOR THE SIGNAL DESIGN: 06-0224T1
DESIGNED: March 2018
SEALED: 03-29-2018
REVISED: N/A

 Stantec Consulting Services Inc. 801 Jones Franklin Road-Suite 300 Raleigh, NC 27606 Tel. (919) 851-6866 Fax. (919) 851-7024 www.stantec.com License No. F-0672	Prepared in the Offices of: STATE OF NORTH CAROLINA PROFESSIONAL ENGINEER LAWRENCE E. OVERN	US 401 Business (Raeford Road) at Purdue Drive/ SteinMart Driveway Division 6 Cumberland County Fayetteville	SEAL STATE OF NORTH CAROLINA PROFESSIONAL ENGINEER LAWRENCE E. OVERN
	ELECTRICAL AND PROGRAMMING DETAILS FOR:	PLAN DATE: March 2018 REVIEWED BY: L Overn PREPARED BY: G B Spell REVIEWED BY:	REVISIONS INIT. DATE

DATE: 03/29/2018 10:45:11 AM
 User: rfmuncy
 File: \\server\projects\signal\signal\temp\phase 1\U-4405-sig.ele_06-0224T1.dgn

ECONOLITE ASC/3-2070 VEHICLE DETECTOR SETUP PROGRAMMING DETAIL FOR ALTERNATE PHASING LOOPS 1A, 5A (program controller as shown)

IMPORTANT!

Program detectors per the input file connection and programming chart shown on sheet 1 before proceeding.

- From Main Menu select **8. UTILITIES**
- From UTILITIES Submenu select **1. COPY/CLEAR**
- Copy from DETECTOR PLAN "1" to DETECTOR PLAN "2".

```

COPY / CLEAR UTILITY
FROM          TO
PHASE TIMING... > PHASE TIMING...
TIMING PLAN... > TIMING PLAN...
PH DET OPT PLAN. > PH DET OPT PLAN.
DETECTOR PLAN... 1 > DETECTOR PLAN... 2
TOGGLE TO SELECT A "FROM" AND A "TO"
THEN PRESS ENTER
  
```

- From Main Menu select **6. DETECTORS**
- From DETECTOR Submenu select **2. VEHICLE DETECTOR SETUP**
- Place cursor in VEH DET PLAN [] position and enter "2".

- Place cursor in VEH DETECTOR [] position and enter "1".
 - Set delay time to "3.0".

```

VEH DETECTOR [ 1 ]  VEH DET PLAN [ 2 ]
TYPE: S-STANDARD
TS2 DETECTOR..... ECPI LOG..... NO
DET PH - 1 2 3 4 5 6 7 8 9 0 1 2 3 4 5 6
1 1
EXTEND TIME... 0.0 DELAY TIME... 3.0
USE ADDED INITIAL . CROSS SWITCH PH.. 0
LOCK IN..... NONE NTCIP VOL . OR OCC .
PMT QUEUE DELAY. NO
  
```

- Place cursor in VEH DETECTOR [] position and enter "26".
 - Set assigned phase to "0".

```

VEH DETECTOR [26]  VEH DET PLAN [ 2 ]
TYPE: S-STANDARD
TS2 DETECTOR..... ECPI LOG..... NO
DET PH - 1 2 3 4 5 6 7 8 9 0 1 2 3 4 5 6
26 0
EXTEND TIME... 0.0 DELAY TIME... 0.0
USE ADDED INITIAL . CROSS SWITCH PH.. 0
LOCK IN..... NONE NTCIP VOL . OR OCC .
PMT QUEUE DELAY. NO
  
```

- Place cursor in VEH DETECTOR [] position and enter "5".
 - Set delay time to "3.0".

```

VEH DETECTOR [ 5 ]  VEH DET PLAN [ 2 ]
TYPE: S-STANDARD
TS2 DETECTOR..... ECPI LOG..... NO
DET PH - 1 2 3 4 5 6 7 8 9 0 1 2 3 4 5 6
5 5
EXTEND TIME... 0.0 DELAY TIME... 3.0
USE ADDED INITIAL . CROSS SWITCH PH.. 0
LOCK IN..... NONE NTCIP VOL . OR OCC .
PMT QUEUE DELAY. NO
  
```

- Place cursor in VEH DETECTOR [] position and enter "22".
 - Set assigned phase to "0".

```

VEH DETECTOR [22]  VEH DET PLAN [ 2 ]
TYPE: S-STANDARD
TS2 DETECTOR..... ECPI LOG..... NO
DET PH - 1 2 3 4 5 6 7 8 9 0 1 2 3 4 5 6
22 0
EXTEND TIME... 0.0 DELAY TIME... 0.0
USE ADDED INITIAL . CROSS SWITCH PH.. 0
LOCK IN..... NONE NTCIP VOL . OR OCC .
PMT QUEUE DELAY. NO
  
```

END PROGRAMMING

THIS ELECTRICAL DETAIL IS FOR
 THE SIGNAL DESIGN: 06-0224T1
 DESIGNED: March 2018
 SEALED: 03-29-2018
 REVISED: N/A

Temporary Design 1 - TMP Phase I
 Electrical Detail - Sheet 3 of 3

DOCUMENT NOT CONSIDERED FINAL
 UNLESS ALL SIGNATURES COMPLETED



Stantec Consulting Services Inc.
 801 Jones Franklin Road-Suite 300
 Raleigh, NC 27606
 Tel. (919) 851-6866
 Fax. (919) 851-7024
 www.stantec.com
 License No. F-0672

ELECTRICAL AND PROGRAMMING
 DETAILS FOR:

Prepared in the Offices of:

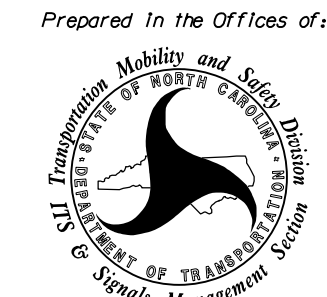

750 N. Greenfield Pkwy, Garner, NC 27529

US 401 Business (Raeford Road)
 at
 Purdue Drive/
 SteinMart Driveway

Division 6 Cumberland County Fayetteville

PLAN DATE: March 2018 REVIEWED BY: L Overn

PREPARED BY: G B Spell REVIEWED BY:

REVISIONS	INIT.	DATE

SEAL

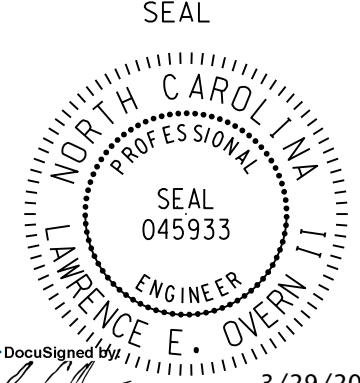

3/29/2018

DATE

SIG. INVENTORY NO. 06-0224T1

DATE: U:\Traffic\Signal\06\Signal\Phase 1\U-4405\sig\ele_06-0224T1.dgn
 User: rfmuncey

DEFAULT PHASING DIAGRAM

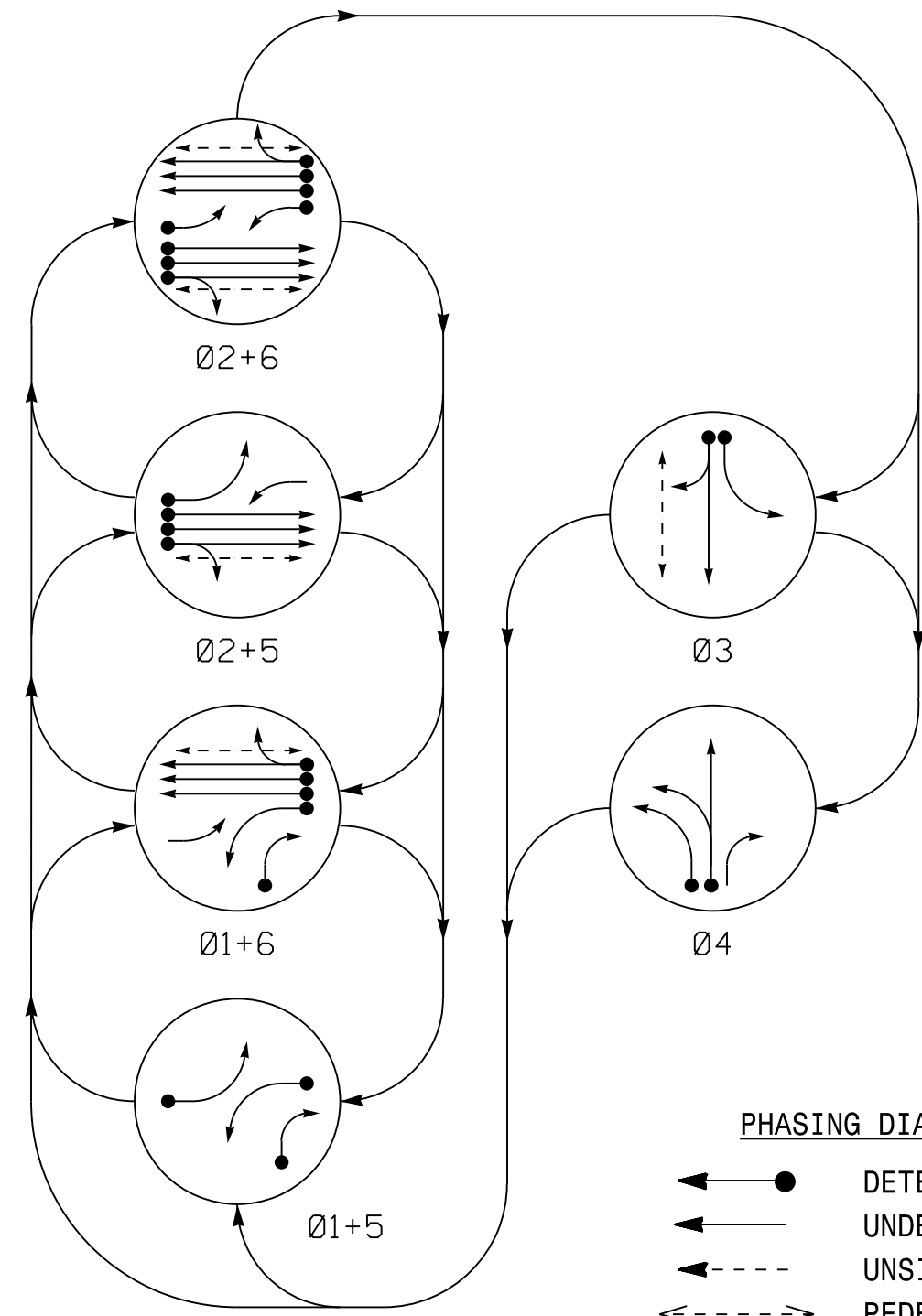

DEFAULT PHASING TABLE OF OPERATION

SIGNAL FACE	PHASE					
	01+5	01+6	02+5	02+6	03	04
11	←	←	←	←	←	←
21,22	R	R	G	G	R	R
31	R	R	R	R	G	R
32	R	R	R	R	G	R
41	R	R	R	R	G	R
42	R	R	R	R	G	R
51	←	←	←	←	←	←
61,62	R	G	R	G	R	R
P21,P22	DW	DW	W	W	DW	DRK
P31,P32	DW	DW	DW	DW	W	DRK
P61,P62	DW	W	DW	W	DW	DRK

ALTERNATE PHASING DIAGRAM

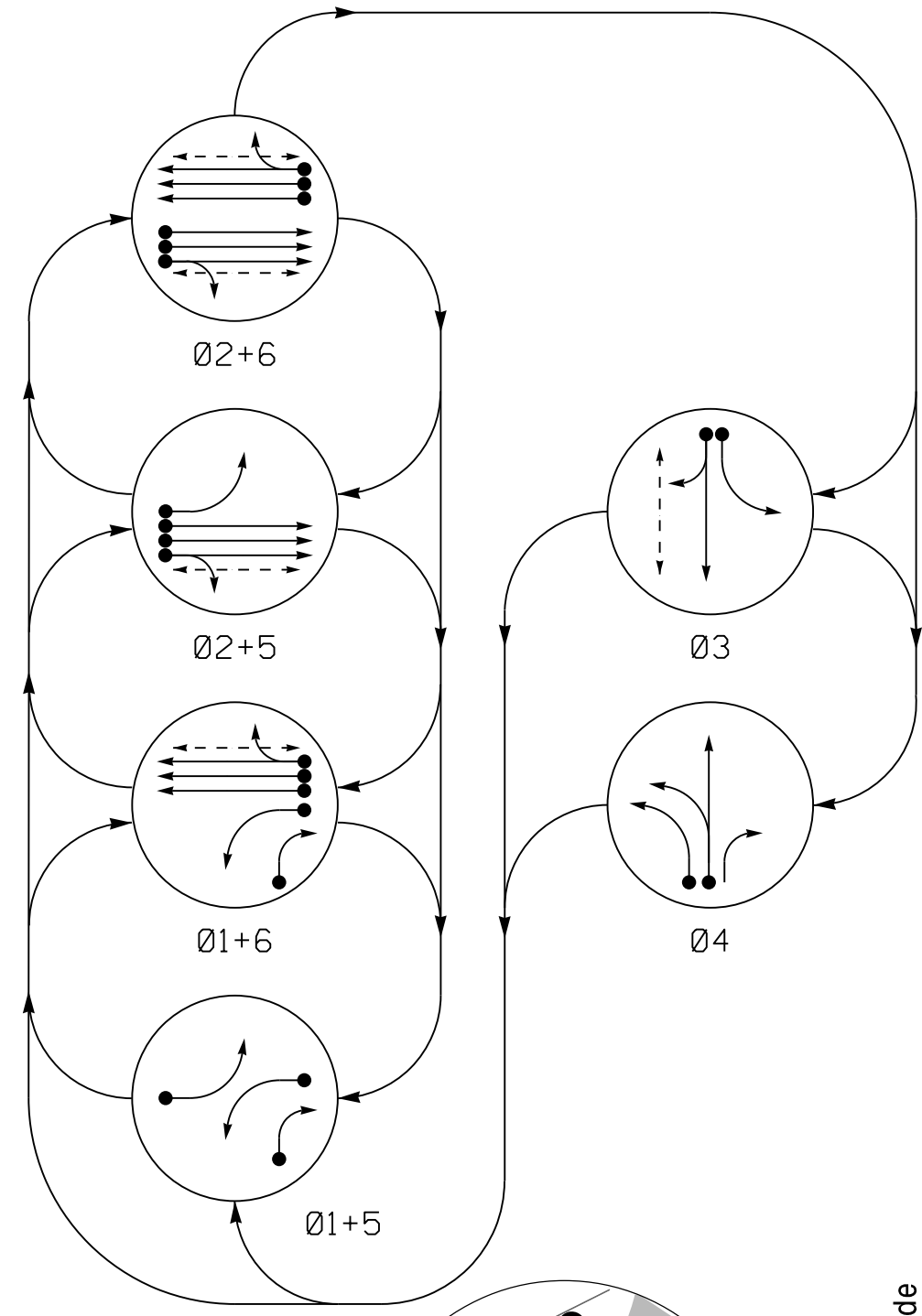

ALTERNATE PHASING TABLE OF OPERATION

SIGNAL FACE	PHASE					
	01+5	01+6	02+5	02+6	03	04
11	←	←	←	←	←	←
21,22	R	R	G	G	R	R
31	R	R	R	R	G	R
32	R	R	R	R	G	R
41	R	R	R	R	G	R
42	R	R	R	R	G	R
51	←	←	←	←	←	←
61,62	R	G	R	G	R	R
P21,P22	DW	DW	W	W	DW	DRK
P31,P32	DW	DW	DW	DW	W	DRK
P61,P62	DW	W	DW	W	DW	DRK

ASC/3 DETECTOR INSTALLATION CHART

LOOP	SIZE (FT)	DISTANCE FROM STOPBAR (FT)	TURNS	NEW LOOP	PROGRAMMING						
					PHASE	CALLING	EXTEND TIME	DELAY TIME	USE ADDED INITIAL	TYPE	SYSTEM LOOP
1A	6X40	0	*	-	1	Yes	-	15★	-	S	-
1B	6X40	0	*	-	1	Yes	-	15	-	S	-
2A	6X6	70	*	-	2	Yes	-	-	-	S	-
2B	6X6	70	*	-	2	Yes	-	-	-	S	-
2C	6X6	70	*	-	2	Yes	-	-	-	S	X
3A	6X40	0	*	-	3	Yes	-	3	-	S	-
3B	6X40	0	*	-	3	Yes	-	10	-	S	-
4A	6X40	0	*	-	4	Yes	-	3	-	S	-
4B	6X40	0	*	-	4	Yes	-	-	-	S	-
5A	6X40	0	*	-	5	Yes	-	15★	-	S	-
6A	6X6	70	*	-	6	Yes	-	-	-	S	-
6B	6X6	70	*	-	6	Yes	-	-	-	S	-
6C	6X6	70	*	-	6	Yes	-	-	-	S	-

*Video Detection Area. Camera locations should be confirmed in the field by the contractor in order to provide detection of the areas indicated.
 #Disable Phases(s) calling during Alternate Phasing Operation.
 ★Reduce delay from 15 to 3 seconds during Alternate Phasing Operation.

6 Phase Fully Actuated Fayetteville Signal System

NOTES

- Refer to "Roadway Standard Drawings NCDOT" dated January 2018 and "Standard Specifications for Roads and Structures" dated January 2018.
- Do not program signal for late night flashing operation unless otherwise directed by the Engineer.
- Phase 1 and/or Phase 5 may be lagged.
- The order of Phase 3 and Phase 4 may be reversed.
- Set all detector units to presence mode.
- Reposition existing signal heads numbered 21 and 22.
- Omit "WALK" and flashing "DON'T WALK" with no pedestrian calls.
- Program pedestrian heads to countdown the flashing "DON'T WALK" time only.
- The Division (City) Traffic Engineer will determine hours of use for each phasing plan.
- Maximum times shown in timing chart are for free-run operation only. Coordinated signal system timing values supersede these values.

PHASING DIAGRAM DETECTION LEGEND

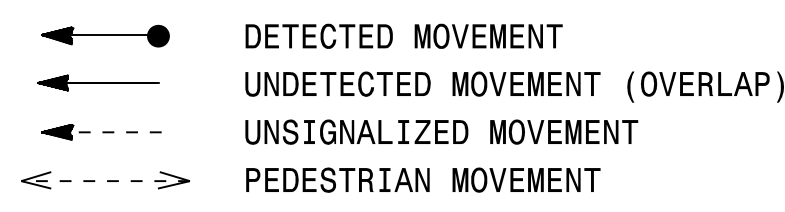

SIGNAL FACE I.D.

All Heads L.E.D.

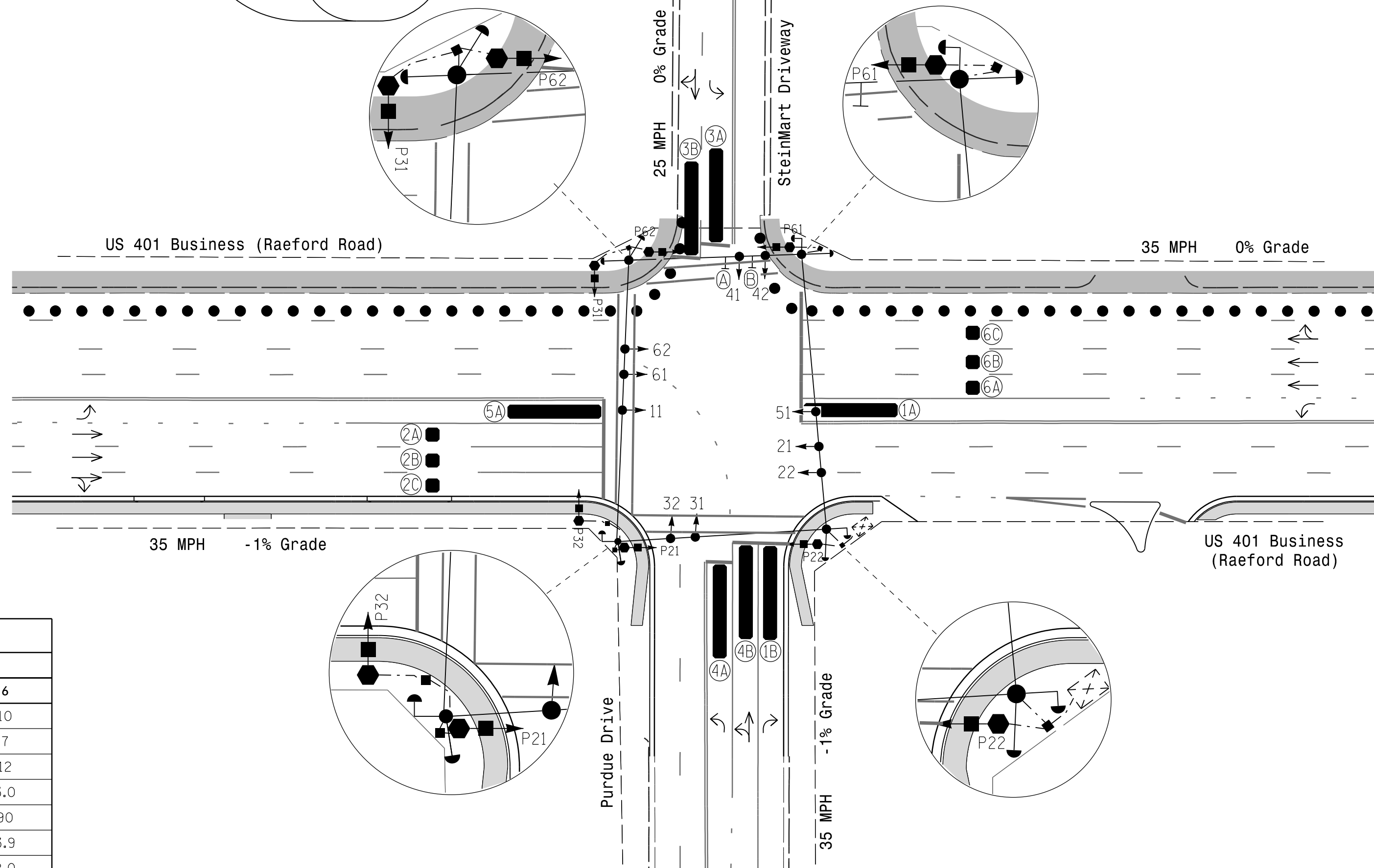
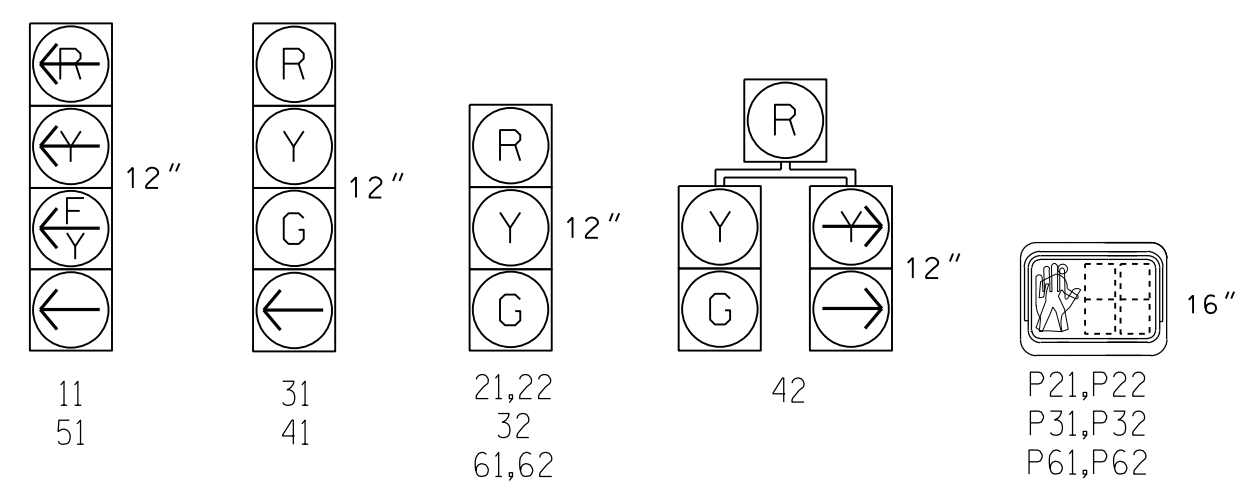

ASC/3 TIMING CHART

FEATURE	PHASE					
	1	2	3	5	6	6
Min Green *	7	10	7	7	7	10
Walk *	-	7	7	-	-	7
Ped Clear	-	17	24	-	-	12
Veh. Extension *	2.0	3.0	2.0	2.0	2.0	3.0
Max 1 *	20	90	25	25	20	90
Yellow	3.0	3.9	3.2	3.9	3.0	3.9
Red Clear	2.3	2.0	3.1	2.3	2.9	2.0
Red Revert	-	-	-	-	-	-
Actuations B4 Add *	-	-	-	-	-	-
Seconds / Actuation *	-	-	-	-	-	-
Max Initial *	-	-	-	-	-	-
Time Before Reduction *	-	-	-	-	-	-
Time To Reduce *	-	-	-	-	-	-
Minimum Gap	-	-	-	-	-	-
Locking Detector	-	X	-	-	-	X
Recall Position	-	VEH. RECALL	-	-	-	VEH. RECALL
Dual Entry	-	-	-	-	-	-
Simultaneous Gap	X	X	X	X	X	X

* These values may be field adjusted. Do not adjust Min Green and Extension times for phases 2 and 6 lower than what is shown. Min Green for all other phases should not be lower than 4 seconds.

LEGEND

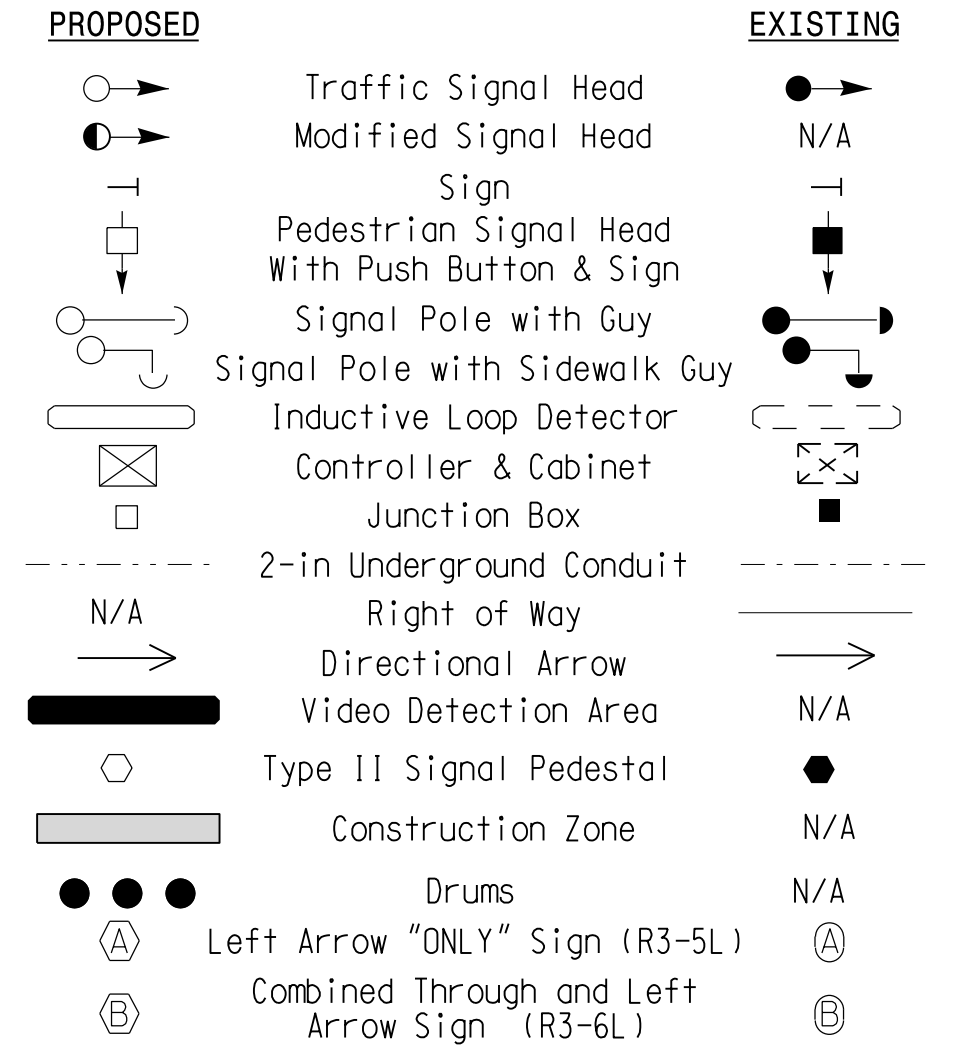

Signal Upgrade Temporary Design 2 - TMP Phase II

<p>Stantec Consulting Services Inc. 801 Jones Franklin Road-Suite 300 Raleigh, NC 27606 Tel. (919) 851-6866 Fax. (919) 851-7024 www.stantec.com License No. F-0672</p>		<p>US 401 Business (Raeford Road) at Purdue Drive/SteinMart Driveway</p>	
		<p>Division 6 Cumberland County Fayetteville</p> <p>PLAN DATE: March 2018 REVIEWED BY: E D Harris</p> <p>PREPARED BY: G B Spell REVIEWED BY: B L Watson</p>	<p>3/29/2018</p>

DOCUMENT NOT CONSIDERED FINAL UNLESS ALL SIGNATURES COMPLETED

3/29/2018 10:44:11 AM C:\Users\gnm\Documents\Signal Design\Temporary 2\U-4405_Sig-75.0-0224-T2.dgn User: rmcancey

EDI MODEL 2018ECLIP-NC CONFLICT MONITOR PROGRAMMING DETAIL

(remove jumpers and set switches as shown)

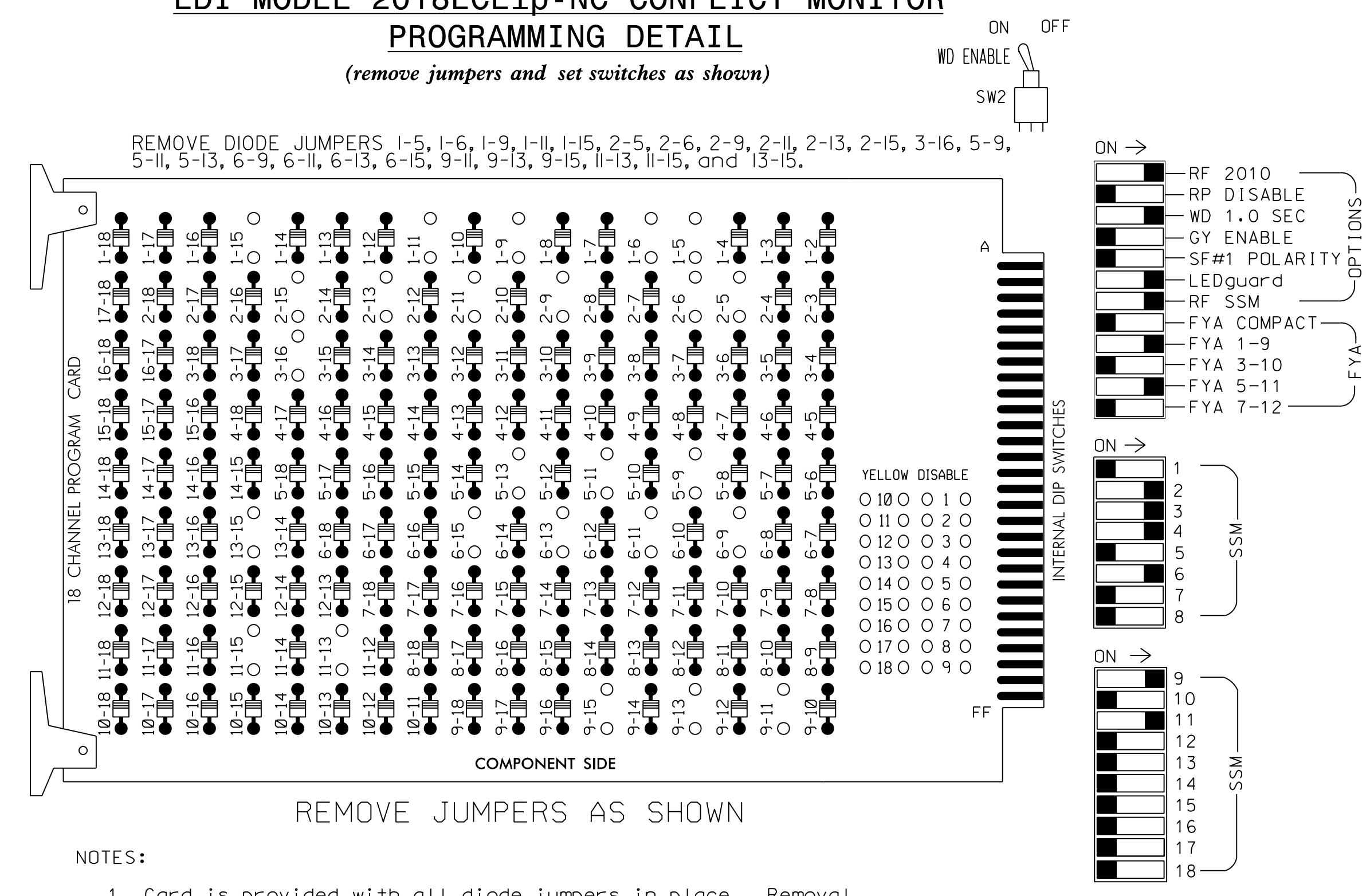

- NOTES:**
- Card is provided with all diode jumpers in place. Removal of any jumper allows its channels to run concurrently.
 - Ensure jumpers SEL2-SEL5 and SEL9 are present on the monitor board.
 - Ensure that Red Enable is active at all times during normal operation.
 - Integrate monitor with Ethernet network in cabinet.

NOTES

- To prevent "flash-conflict" problems, insert red flash program blocks for all unused vehicle load switches in the output file. The installer shall verify that signal heads flash in accordance with the Signal Plans.
- Program controller for start up in Phase 2 WALK and Phase 6 WALK.
- The cabinet and controller are part of the Fayetteville Signal System.

EQUIPMENT INFORMATION

CONTROLLER.....2070
 CABINET.....332 W/AUX
 SOFTWARE.....ECONOLITE ASC/3-2070
 CABINET MOUNT.....BASE
 OUTPUT FILE POSITIONS...18 WITH AUX. OUTPUT FILE
 LOAD SWITCHES USED.....S1,S2,S3,S4,S5,S7,S8,
 S9,S12,AUX S1,AUX S4
 PHASES USED.....1,2,2PED,3,4,5,6,
 6PED,3PED

OVERLAP A.....*
 OVERLAP B.....NOT USED
 OVERLAP C.....*
 OVERLAP D.....NOT USED

* See Overlap Programming Detail on Sheet 2

SIGNAL HEAD HOOK-UP CHART

LOAD SWITCH NO.	S1	S2	S3	S4	S5	S6	S7	S8	S9	S10	S11	S12	AUX S1	AUX S2	AUX S3	AUX S4	AUX S5	AUX S6	
CMU CHANNEL NO.	1	2	13	3	4	14	5	6	15	7	8	16	9	10	17	11	12	18	
PHASE	1	2	2 PED	3	4	4 PED	5	6	6 PED	7	8	3 PED	OLA	OLB	OLE	OLC	OLD	OLF	
SIGNAL HEAD NO.	11★	42	21,22	P21, P22	31	32	41	42	NU	51★	61,62	P61, P62	NU	NU	P31, P32	11★	NU	51★	NU
RED	*	128		116	116	101	101					134							
YELLOW		129		117	117	102	102		*	135									
GREEN		130		118	118	103	103					136							
RED ARROW													A121					A114	
YELLOW ARROW	126												A122					A115	
FLASHING YELLOW ARROW													A123					A116	
GREEN ARROW	127	127		118		103			133										
Hand													113						119
Walking																			110
																			115
																			121
																			112

NU = Not Used
 * Denotes install load resistor. See load resistor installation detail this sheet.
 ★ See pictorial of head wiring in detail below.

COUNTDOWN PEDESTRIAN SIGNAL OPERATION

Countdown Ped Signals are required to display timing only during Ped Clearance Interval. Consult Ped Signal Module user's manual for instructions on selecting this feature.

INPUT FILE POSITION LAYOUT (front view)

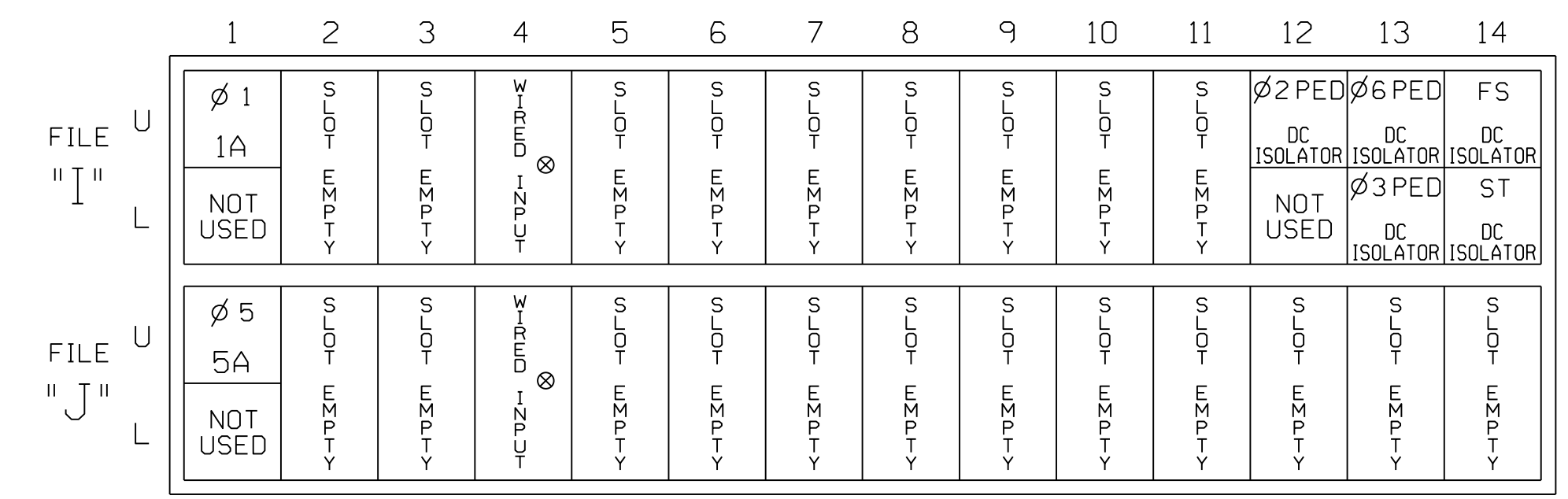

INPUT FILE CONNECTION & PROGRAMMING CHART

LOOP NO.	LOOP TERMINAL	INPUT FILE POS.	PIN NO.	DETECTOR NO.	NEMA PHASE	CALL	EXTEND TIME	DELAY TIME	ADDED INITIAL	DETECTOR TYPE
1A ¹	-	I1U	56	1 ★	1	YES		15		S
	-	J4U	48	26 ★	6	YES				S
5A ²	-	J1U	55	5 ★	5	YES		15		S
	-	I4U	47	22 ★	2	YES				S

NOTE: INSTALL DC ISOLATORS IN INPUT FILE SLOTS 112 AND 113.

PED PUSH BUTTONS:
 P21,P22 T88-4,6 I12U 67 PED 2 2 PED
 P31,P32 T88-8,9 I13L 70 PED 8 3 PED
 P61,P62 T88-7,9 I13U 68 PED 6 6 PED

- Add jumper from I1-W to J4-W, on rear of input file.
 - Add jumper from J1-W to I4-W, on rear of input file.
- ★ See Vehicle Detector Setup Programming Detail for alternate phasing on Sheet 3.

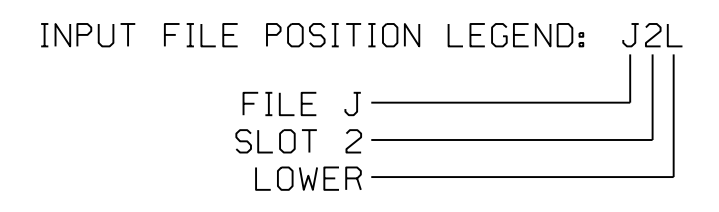

DETECTOR NOTES

- For all loops install a video detection system for vehicle detection. Perform installation according to manufacturer's directions and NCDOT engineer-approved mounting locations to accomplish the detection schemes shown on the Signal Design Plans.
- For loops 1A and 5A detector card placements and slots reserved for wired inputs are typical for a NCDOT installation. Inputs associated with these slots are compatible with time of day instructions located on sheets 2 and 3 of this electrical detail.

LOAD RESISTOR INSTALLATION DETAIL

(install resistors as shown)

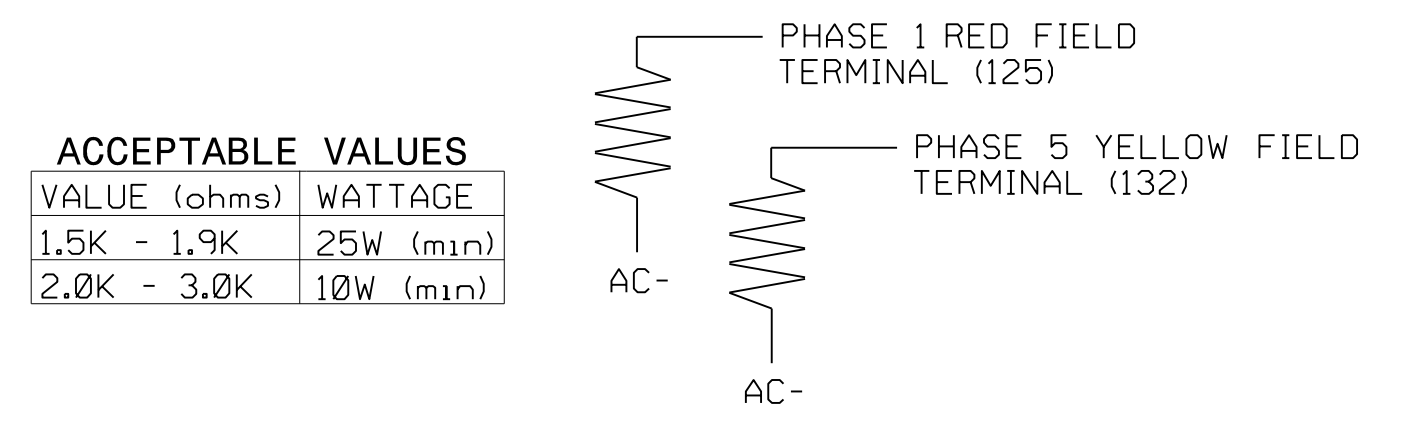

Temporary Design 2 - TMP Phase II Electrical Detail - Sheet 1 of 3

Stantec Consulting Services Inc.
 801 Jones Franklin Road-Suite 300
 Raleigh, NC 27606
 Tel. (919) 851-6866
 Fax. (919) 851-7024
 www.stantec.com
 License No. F-0672

Prepared in the Offices of:

750 N. Greenfield Pkwy, Garner, NC 27529

US 401 Business (Raeford Road) at Purdue Drive/SteinMart Driveway

Division 6 Cumberland County Fayetteville

PLAN DATE: March 2018 REVIEWED BY: L Overn

PREPARED BY: G B Spell REVIEWED BY:

REVISIONS	INIT.	DATE

SEAL
 NORTH CAROLINA PROFESSIONAL ENGINEER
 SEAL 045933
 LAWRENCE E. OVERN
 3/29/2018

ECONOLITE ASC/3-2070 OVERLAP PROGRAMMING DETAIL

(program controller as shown)

1. From Main Menu select 2. CONTROLLER
2. From CONTROLLER Submenu select 2. VEHICLE OVERLAPS

```

OVERLAP A
Select TMG VEH OVLP [A] and 'PPLT FYA'
TMG VEH OVLP...[A] TYPE: ....PPLT FYA
PROTECTED LEFT TURN.... PHASE 1
OPPOSING THROUGH..... PHASE 2

FLASHING ARROW OUTPUT....CH9 ISOLATE
DELAY START OF: FYA..0.0 CLEARANCE..0.0
ACTION PLAN SF BIT DISABLE..... 1
    
```

← NOTICE SF BIT DISABLE 1

↓ Toggle Twice

```

OVERLAP C
Select TMG VEH OVLP [C] and 'PPLT FYA'
TMG VEH OVLP...[C] TYPE: ....PPLT FYA
PROTECTED LEFT TURN.... PHASE 5
OPPOSING THROUGH..... PHASE 6

FLASHING ARROW OUTPUT....CH11 ISOLATE
DELAY START OF: FYA..0.0 CLEARANCE..0.0
ACTION PLAN SF BIT DISABLE..... 5
    
```

← NOTICE SF BIT DISABLE 5

END PROGRAMMING

ALTERNATE PHASING ACTIVATION DETAIL

TO RUN ALT. PHASING DURING FREE RUN - PROGRAM CHANGES (SHOWN BELOW) IN A TIME BASED ACTION PLAN. SCHEDULE A DAY PLAN THAT INCLUDES THE ACTION PLAN PROGRAMMED TO SELECT VEH DET PLAN 2 AND ENABLE SF BITS 1 and 5.

TO RUN ALT. PHASING DURING COORDINATION - SELECT THE TIME BASED ACTION PLAN THAT IS PROGRAMMED TO SELECT VEH DET PLAN 2 AND ENABLE SF BITS 1 and 5.

PHASING	VEH DET PLAN	SF BITS ENABLED
ACTIONS REQUIRED TO RUN <u>DEFAULT PHASING</u>	1	NONE
ACTIONS REQUIRED TO RUN <u>ALTERNATE PHASING</u>	2	1, 5

IMPORTANT: IF ALT. PHASING IS USED DURING FREE RUN AND COORDINATION, DO NOT OPERATE TIME OF DAY EVENTS CONCURRENTLY WITH COORDINATION PLAN EVENTS IN THE EVENT SCHEDULER. (EX. FREE RUN EVENT SHOULD END BEFORE COORDINATION PLAN EVENT STARTS AND VICE-VERSA).

ALTERNATE PHASING CHANGE SUMMARY

THE FOLLOWING IS A SUMMARY OF WHAT TAKES PLACE WHEN SF BITS 1 AND 5 AND VEH DET PLAN 2 ACTIVATE TO CALL THE "ALTERNATE PHASING":

SF BITS 1,5: Modifies overlap parent phases for heads 11 and 51 to run protected turns only.

VEH DET PLAN 2: Disables phase 6 call on loop 1A and reduces delay time for phase 1 call on loop 1A to 3 seconds.

Disables phase 2 call on loop 5A and reduces delay time for phase 5 call on loop 5A to 3 seconds.

ECONOLITE ASC/3-2070 ACTION PLAN PROGRAMMING DETAIL

1. From Main Menu select 5. TIME BASE
2. From TIME BASE Submenu select 2. ACTION PLAN

```

ACTION PLAN...[ 1]
PATTERN.....AUTO  SYS OVERRIDE.... NO
TIMING PLAN..... 0  SEQUENCE..... 0
VEH DETECTOR PLAN.. 2  DET LOG.....NONE
FLASH..... --  RED REST..... NO
VEH DET DIAG PLN... 0  PED DET DIAG PLN..0
DIMMING ENABLE.. NO  PRIORITY RETURN. NO
PED PR RETURN.. NO  QUEUE DELAY..... NO
PMT COND DELAY  NO

PHASE 1 2 3 4 5 6 7 8 9 0 1 2 3 4 5 6
PED RCL . . . . .
WALK 2 . . . . .
VEX 2 . . . . .
VEH RCL . . . . .
MAX RCL . . . . .
MAX 2 . . . . .
PHASE 1 2 3 4 5 6 7 8 9 0 1 2 3 4 5 6
MAX 3 . . . . .
CS 1NH . . . . .
OMIT . . . . .
SPC FCT X . . . X . . . (1-8)
AUX FCT . . . (1-3)

1 2 3 4 5 6 7 8 9 0 1 2 3 4 5
LP 1-15 . . . . .
LP 16-30 . . . . .
LP 31-45 . . . . .
LP 46-60 . . . . .
LP 61-75 . . . . .
LP 76-90 . . . . .
LP 91-100 . . . . .
    
```

ECONOLITE ASC/3-2070 PED 3 PROGRAMMING ASSIGNMENT DETAIL

(program controller as shown)

1. From Main Menu select 6. DETECTORS
2. From DETECTOR Submenu select 3. PED DETECTOR INPUT ASSIGNMENT

PED DET PHASE ASSIGNMENT MODE: NTCIP																	
PHASE	1	2	3	4	5	6	7	8	PHASE	9	10	11	12	13	14	15	16
DETECTOR	0	2	8	0	0	6	0	0	DETECTOR	0	0	0	0	0	0	0	0

← NOTICE PED DETECTOR 8 ASSIGNED TO PHASE 3

1. From Main Menu select 1. CONFIGURATION
2. From CONFIGURATION Submenu select 3. LOAD SW ASSIGN

LD SWITCH ASSIGN											
PHASE	DIMMING	---FLASH---	/OVLP	TYPE	R	Y	G	D	PWR	AUT	TGR
1	1	V	A	R	X	
2	2	V	A	Y	.	
3	3	V	A	R	X	
4	4	V	A	R	.	
5	5	V	A	R	.	
6	6	V	A	Y	X	
7	7	V	A	R	.	
8	8	V	A	R	X	
9	1	O	A	R	X	
10	2	O	A	R	X	
11	3	O	A	R	.	
12	4	O	A	R	.	
13	2	P	A	.	.	
14	4	P	A	.	.	
15	6	P	A	.	.	
16	3	P	A	.	.	

← NOTICE PHASE 3 PED ASSIGNED TO LD SWITCH 16

Temporary Design 2 - TMP Phase II
Electrical Detail - Sheet 2 of 3

THIS ELECTRICAL DETAIL IS FOR THE SIGNAL DESIGN: 06-0224T2
DESIGNED: March 2018
SEALED: 03-29-2018
REVISED: N/A

 Stantec Consulting Services Inc. 801 Jones Franklin Road-Suite 300 Raleigh, NC 27606 Tel. (919) 851-6866 Fax. (919) 851-7024 www.stantec.com License No. F-0672	ELECTRICAL AND PROGRAMMING DETAILS FOR:	US 401 Business (Raeford Road) at Purdue Drive/ SteinMart Driveway Division 6 Cumberland County Fayetteville	SEAL L. OVERN ENGINEER STATE OF NORTH CAROLINA 045933								
	Prepared in the Offices of: L. OVERN ENGINEER STATE OF NORTH CAROLINA 045933 750 N. Greenfield Pkwy, Garner, NC 27529	PLAN DATE: March 2018 PREPARED BY: G B Spell REVIEWED BY: L Overn	REVISIONS <table border="1" style="width: 100%; border-collapse: collapse;"> <tr> <th>NO.</th> <th>DESCRIPTION</th> <th>INIT.</th> <th>DATE</th> </tr> <tr> <td> </td> <td> </td> <td> </td> <td> </td> </tr> </table>	NO.	DESCRIPTION	INIT.	DATE				
NO.	DESCRIPTION	INIT.	DATE								

DATE: 03/29/2018 10:45:11 AM
 User: rfmuncy
 Location: \\server\projects\signal\signal\temp\phase 2\U-4405-sig\ele_06-0224T2.dgn

ECONOLITE ASC/3-2070 VEHICLE DETECTOR SETUP PROGRAMMING DETAIL FOR ALTERNATE PHASING LOOPS 1A, 5A (program controller as shown)

IMPORTANT!

Program detectors per the input file connection and programming chart shown on sheet 1 before proceeding.

- From Main Menu select **8. UTILITIES**
- From UTILITIES Submenu select **1. COPY/CLEAR**
- Copy from DETECTOR PLAN "1" to DETECTOR PLAN "2".

```

COPY / CLEAR UTILITY
FROM          TO
PHASE TIMING... > PHASE TIMING...
TIMING PLAN... > TIMING PLAN...
PH DET OPT PLAN. > PH DET OPT PLAN.
DETECTOR PLAN... 1 > DETECTOR PLAN... 2
TOGGLE TO SELECT A "FROM" AND A "TO"
THEN PRESS ENTER
  
```

- From Main Menu select **6. DETECTORS**
- From DETECTOR Submenu select **2. VEHICLE DETECTOR SETUP**
- Place cursor in VEH DET PLAN [] position and enter "2".

- Place cursor in VEH DETECTOR [] position and enter "1".
 - Set delay time to "3.0".

```

VEH DETECTOR [ 1 ]  VEH DET PLAN [ 2 ]
TYPE: S-STANDARD
TS2 DETECTOR..... ECPI LOG..... NO
DET PH - 1 2 3 4 5 6 7 8 9 0 1 2 3 4 5 6
1 1
EXTEND TIME... 0.0 DELAY TIME... 3.0
USE ADDED INITIAL . CROSS SWITCH PH.. 0
LOCK IN..... NONE NTCIP VOL . OR OCC .
PMT QUEUE DELAY. NO
  
```

- Place cursor in VEH DETECTOR [] position and enter "26".
 - Set assigned phase to "0".

```

VEH DETECTOR [26]  VEH DET PLAN [ 2 ]
TYPE: S-STANDARD
TS2 DETECTOR..... ECPI LOG..... NO
DET PH - 1 2 3 4 5 6 7 8 9 0 1 2 3 4 5 6
26 0
EXTEND TIME... 0.0 DELAY TIME... 0.0
USE ADDED INITIAL . CROSS SWITCH PH.. 0
LOCK IN..... NONE NTCIP VOL . OR OCC .
PMT QUEUE DELAY. NO
  
```

- Place cursor in VEH DETECTOR [] position and enter "5".
 - Set delay time to "3.0".

```

VEH DETECTOR [ 5 ]  VEH DET PLAN [ 2 ]
TYPE: S-STANDARD
TS2 DETECTOR..... ECPI LOG..... NO
DET PH - 1 2 3 4 5 6 7 8 9 0 1 2 3 4 5 6
5 5
EXTEND TIME... 0.0 DELAY TIME... 3.0
USE ADDED INITIAL . CROSS SWITCH PH.. 0
LOCK IN..... NONE NTCIP VOL . OR OCC .
PMT QUEUE DELAY. NO
  
```

- Place cursor in VEH DETECTOR [] position and enter "22".
 - Set assigned phase to "0".

```

VEH DETECTOR [22]  VEH DET PLAN [ 2 ]
TYPE: S-STANDARD
TS2 DETECTOR..... ECPI LOG..... NO
DET PH - 1 2 3 4 5 6 7 8 9 0 1 2 3 4 5 6
22 0
EXTEND TIME... 0.0 DELAY TIME... 0.0
USE ADDED INITIAL . CROSS SWITCH PH.. 0
LOCK IN..... NONE NTCIP VOL . OR OCC .
PMT QUEUE DELAY. NO
  
```

END PROGRAMMING

THIS ELECTRICAL DETAIL IS FOR
 THE SIGNAL DESIGN: 06-0224T2
 DESIGNED: March 2018
 SEALED: 03-29-2018
 REVISED: N/A

Temporary Design 2 - TMP Phase II
 Electrical Detail - Sheet 3 of 3

DOCUMENT NOT CONSIDERED FINAL
 UNLESS ALL SIGNATURES COMPLETED



Stantec Consulting Services Inc.
 801 Jones Franklin Road-Suite 300
 Raleigh, NC 27606
 Tel. (919) 851-6866
 Fax. (919) 851-7024
 www.stantec.com
 License No. F-0672

ELECTRICAL AND PROGRAMMING
 DETAILS FOR:

Prepared in the Offices of:

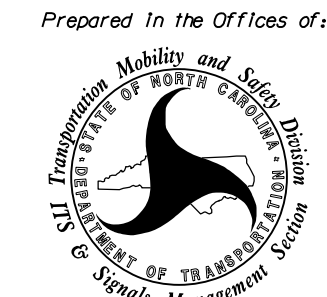

750 N. Greenfield Pkwy, Garner, NC 27529

US 401 Business (Raeford Road)
 at
 Purdue Drive/
 SteinMart Driveway

Division 6 Cumberland County Fayetteville

PLAN DATE: March 2018 REVIEWED BY: L Overn

PREPARED BY: G B Spell REVIEWED BY:

REVISIONS	INIT.	DATE

SEAL

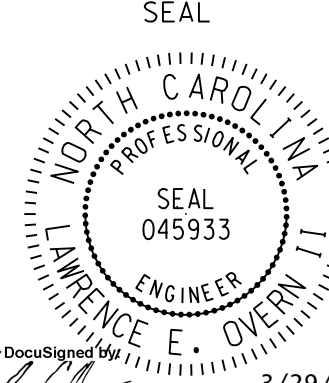

3/29/2018

DATE

SIG. INVENTORY NO. 06-0224T2

DATE: U:\Traffic\Signal\06as\Signal\Electrical\Detail\SignalPhase 2\U-4405\Signal\06-0224T2.dgn
 User: rfmuncey

EDI MODEL 2018ECLIP-NC CONFLICT MONITOR PROGRAMMING DETAIL

(remove jumpers and set switches as shown)

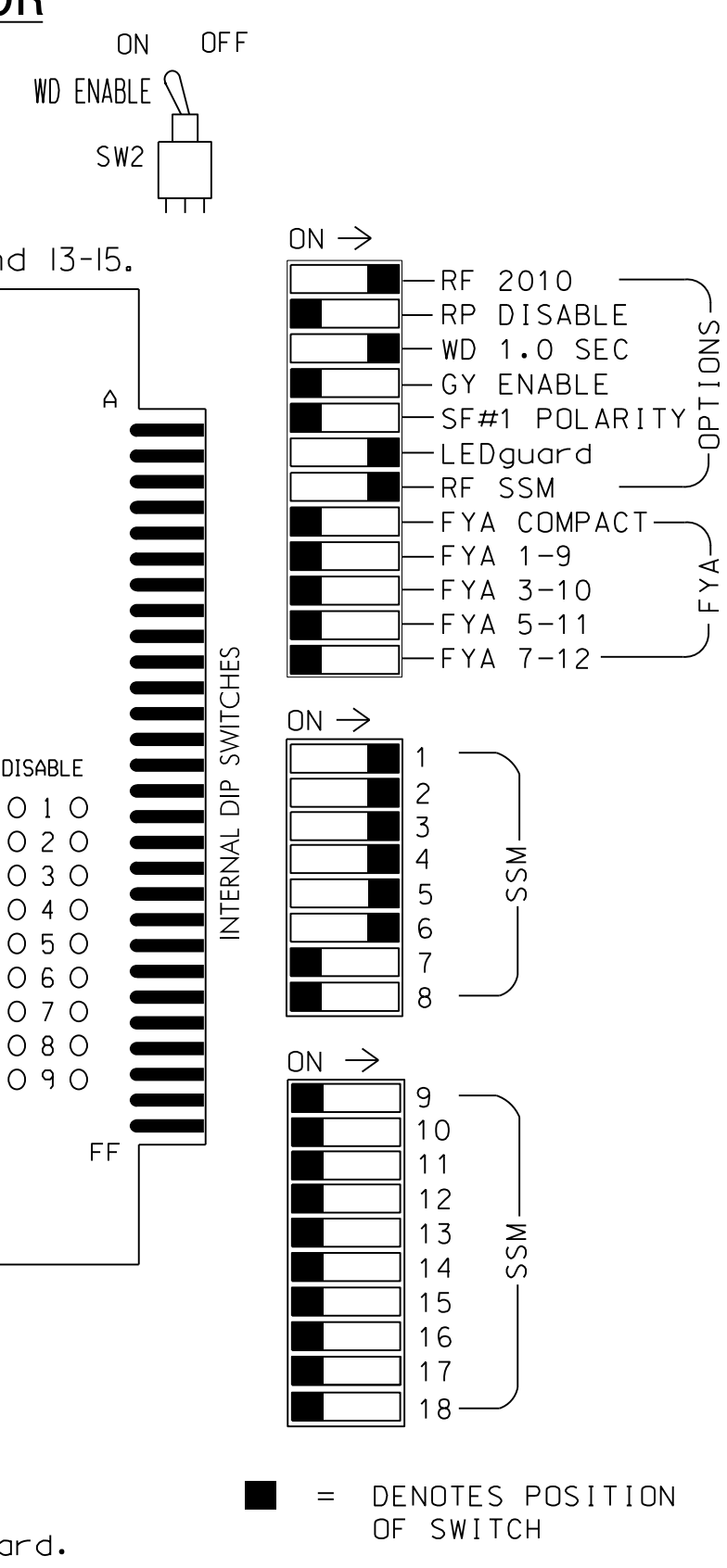
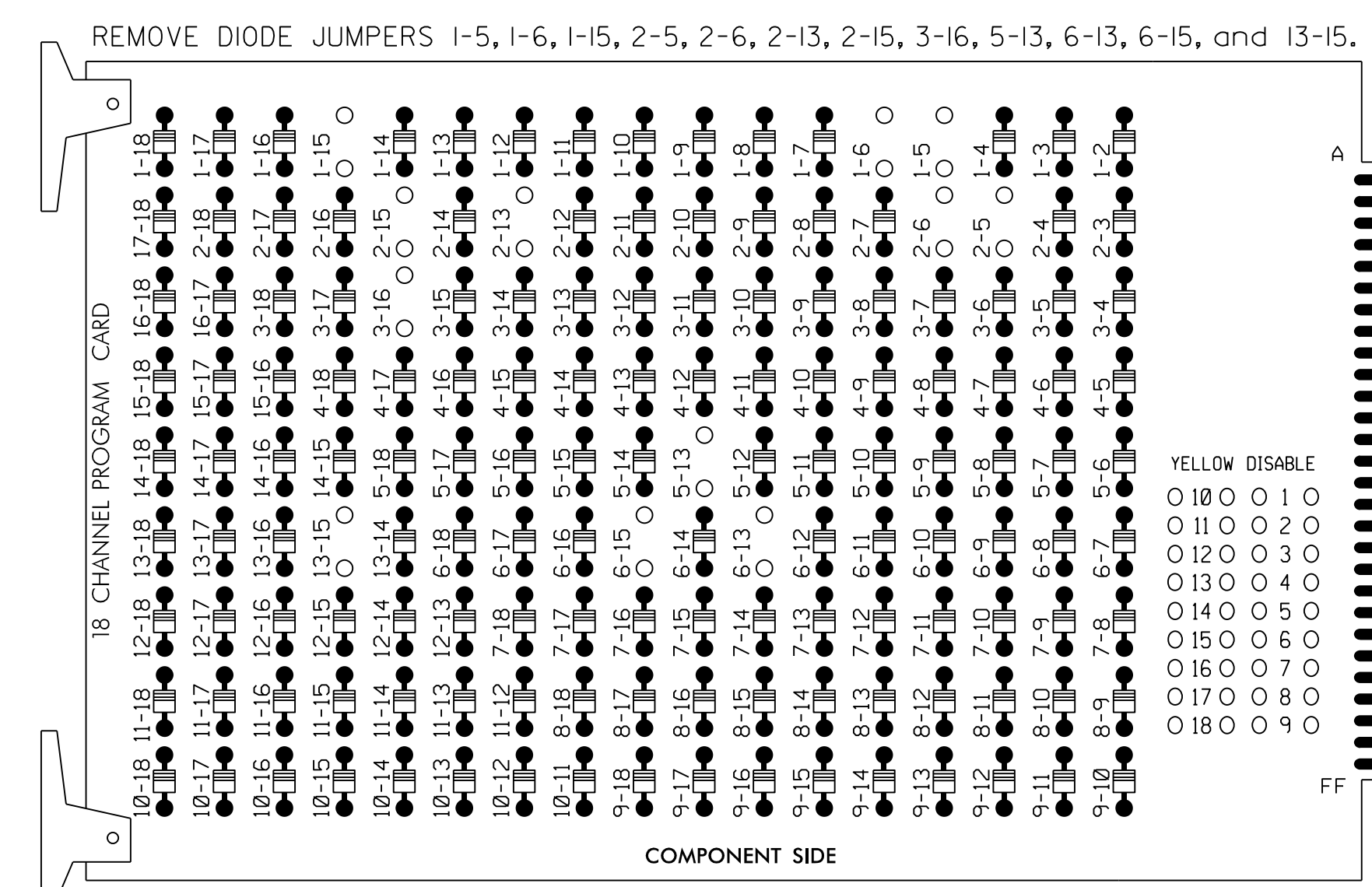

- NOTES:
- Card is provided with all diode jumpers in place. Removal of any jumper allows its channels to run concurrently.
 - Ensure jumpers SEL2-SEL5 and SEL9 are present on the monitor board.
 - Ensure that Red Enable is active at all times during normal operation.
 - Integrate monitor with Ethernet network in cabinet.

NOTES

- To prevent "flash-conflict" problems, insert red flash program blocks for all unused vehicle load switches in the output file. The installer shall verify that signal heads flash in accordance with the Signal Plans.
- Return controller to Factory Defaults before programming per this electrical detail.
- Program controller for start up in Phase 2 WALK and Phase 6 WALK.
- The cabinet and controller are part of the Fayetteville Signal System.

EQUIPMENT INFORMATION

CONTROLLER.....2070
 CABINET.....332 W/AUX
 SOFTWARE.....ECONOLITE ASC/3-2070
 CABINET MOUNT.....BASE
 OUTPUT FILE POSITIONS...18 WITH AUX. OUTPUT FILE LOAD SWITCHES USED.....S1,S2,S3,S4,S5,S7,S8,S9,S12
 PHASES USED.....1,2,2PED,3,4,5,6,6PED,3PED
 OVERLAP A.....NOT USED
 OVERLAP B.....NOT USED
 OVERLAP C.....NOT USED
 OVERLAP D.....NOT USED

SIGNAL HEAD HOOK-UP CHART

LOAD SWITCH NO.	S1	S2	S3	S4	S5	S6	S7	S8	S9	S10	S11	S12	AUX S1	AUX S2	AUX S3	AUX S4	AUX S5	AUX S6		
CMU CHANNEL NO.	1	2	13	3	4	14	5	6	15	7	8	16	9	10	17	11	12	18		
PHASE	1	4	2	3	3	4	4	4	5	6	6	7	8	3	OLA	OLB	OLE	OLC	OLD	OLF
SIGNAL HEAD NO.	11★	42	21,22	P21,P22	31	32	41	42	NU	51★	61,62	P61,P62	NU	NU	P31,P32	NU	NU	NU	NU	NU
RED		128		116	116	101	101				134									
YELLOW		129		117	117	102	102				135									
GREEN		130		118	118	103	103				136									
RED ARROW	125										131									
YELLOW ARROW	126	126									132									
FLASHING YELLOW ARROW																				
GREEN ARROW	127	127		118		103		133												
Hand						113							119					110		
Walking Person						115							121					112		

NU = Not Used
 ★ See pictorial of head wiring in detail below.

COUNTDOWN PEDESTRIAN SIGNAL OPERATION

Countdown Ped Signals are required to display timing only during Ped Clearance Interval. Consult Ped Signal Module user's manual for instructions on selecting this feature.

INPUT FILE POSITION LAYOUT

(front view)

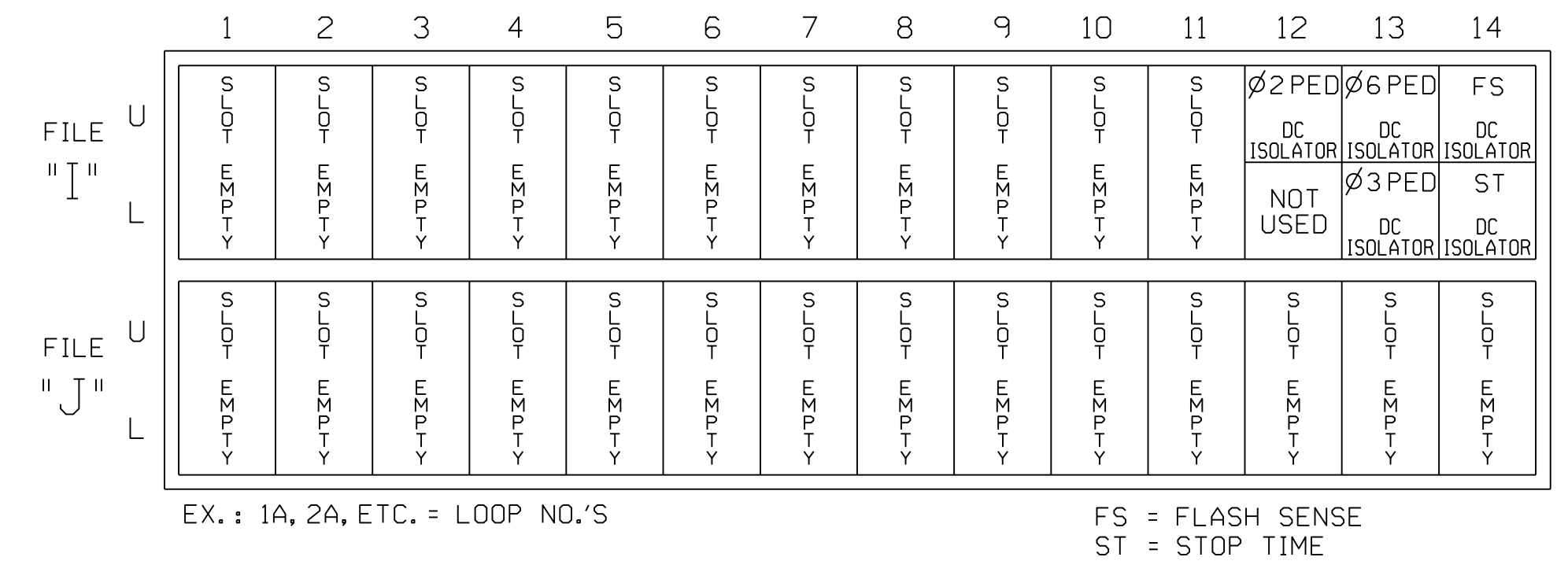

INPUT FILE CONNECTION & PROGRAMMING CHART

LOOP NO.	LOOP TERMINAL	INPUT FILE POS.	PIN NO.	DETECTOR NO.	NEMA PHASE
P21,P22	TB8-4,6	I12U	67	PED 2	2 PED
P31,P32	TB8-8,9	I13L	70	PED 8	3 PED
P61,P62	TB8-7,9	I13U	68	PED 6	6 PED

NOTE:
 INSTALL DC ISOLATORS IN INPUT FILE SLOTS 112 AND 113.

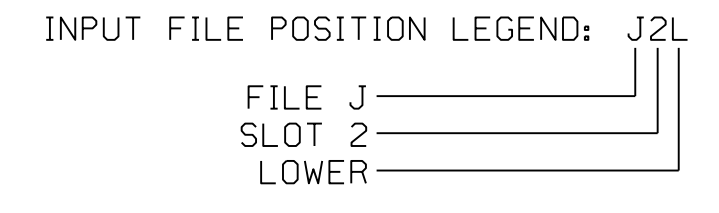

SIGNAL WIRING DETAIL

(wire signal heads as shown)

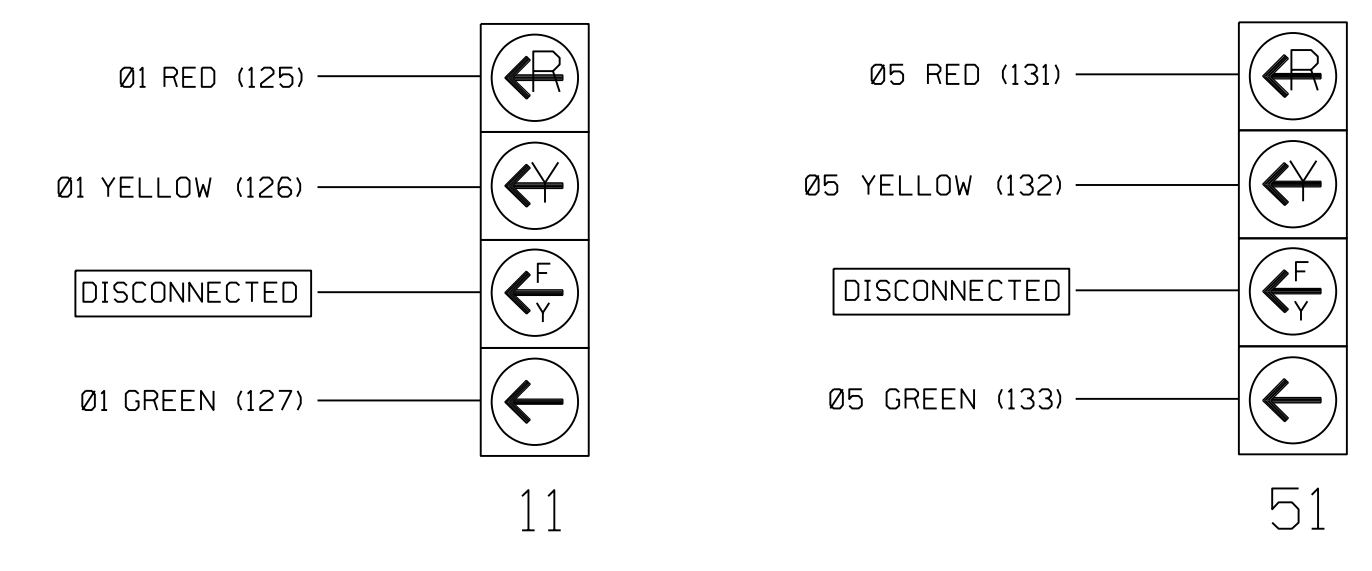

DETECTOR NOTES

- For all loops, install a video detection system for vehicle detection. Perform installation according to manufacturer's directions and NCDOT engineer-approved mounting locations to accomplish the detection schemes shown on the Signal Design Plans.
- Remove "Wired Inputs" from rear of input file to prevent unwanted calls to Phases 2 and 6.

LOAD RESISTOR INSTALLATION DETAIL

(install resistor as shown)

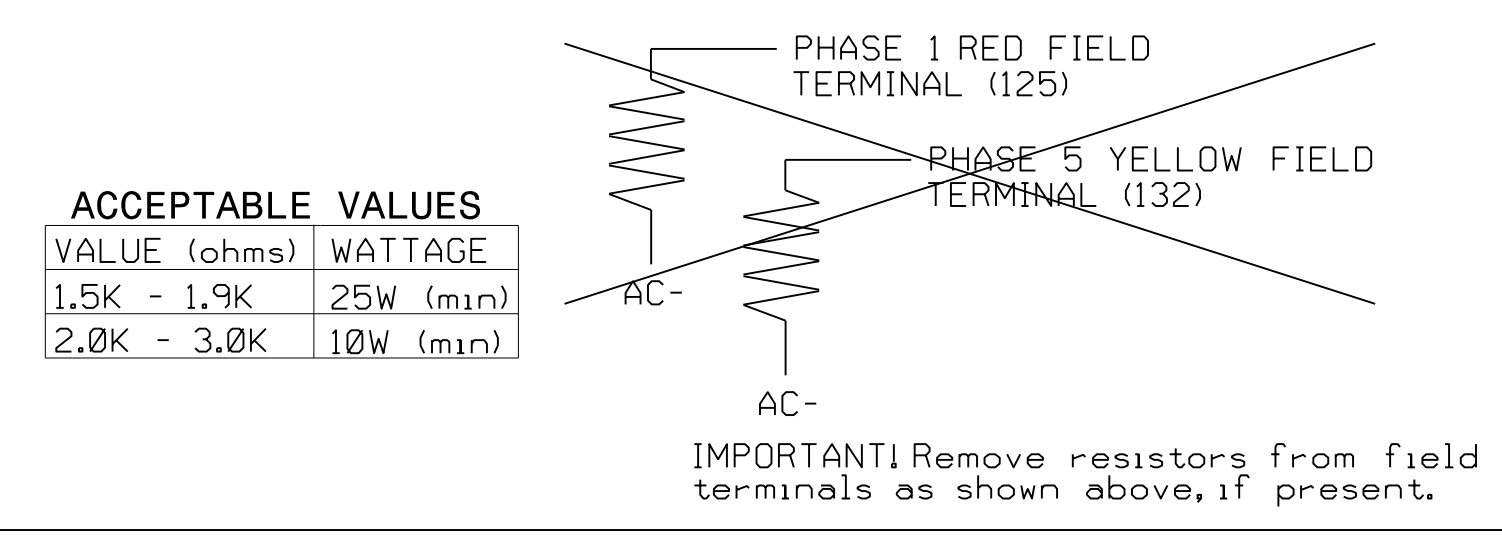

THIS ELECTRICAL DETAIL IS FOR THE SIGNAL DESIGN: 06-0224T3
 DESIGNED: March 2018
 SEALED: 03-29-2018
 REVISED: N/A

Temporary Design 3 - TMP Phase III
 Electrical Detail - Sheet 1 of 2

<p>Stantec Consulting Services Inc. 801 Jones Franklin Road-Suite 300 Raleigh, NC 27606 Tel. (919) 851-6866 Fax. (919) 851-7024 www.stantec.com License No. F-0672</p>	ELECTRICAL AND PROGRAMMING DETAILS FOR: Prepared in the Offices of: 	US 401 Business (Raeford Road) at Purdue Drive/ SteinMart Driveway Division 6 Cumberland County Fayetteville PLAN DATE: March 2018 REVIEWED BY: L Overn PREPARED BY: G B Spell REVIEWED BY:	SEAL <p>3/29/2018</p>
	REVISIONS INIT. DATE	DATE SIG. INVENTORY NO. 06-0224T3	DOCUMENT NOT CONSIDERED FINAL UNLESS ALL SIGNATURES COMPLETED

ECONOLITE ASC/3-2070 PED 3 PROGRAMMING ASSIGNMENT DETAIL

(program controller as shown)

1. From Main Menu select 6. DETECTORS
2. From DETECTOR Submenu select 3. PED DETECTOR INPUT ASSIGNMENT

PED DET PHASE ASSIGNMENT MODE: NTCIP								
PHASE	1	2	3	4	5	6	7	8
DETECTOR	0	2	8	0	0	6	0	0
PHASE	9	10	11	12	13	14	15	16
DETECTOR	0	0	0	0	0	0	0	0

← NOTICE PED DETECTOR 8
ASSIGNED TO PHASE 3

1. From Main Menu select 1. CONFIGURATION
2. From CONFIGURATION Submenu select 3. LOAD SW ASSIGN

LD SWITCH	ASSIGN	PHASE	/OVLP	TYPE	DIMMING			---FLASH---		
					R	Y	G D	PWR	AUT	TGR
1	1	V	+	A	R	X
2	2	V	+	A	Y	.
3	3	V	+	A	R	X
4	4	V	+	A	R	.
5	5	V	-	A	R	.
6	6	V	-	A	Y	X
7	7	V	-	A	R	.
8	8	V	-	A	R	X
9	1	O	+	A	R	X
10	2	O	+	A	R	X
11	3	O	-	A	R	.
12	4	O	-	A	R	.
13	2	P	+	A	.	.
14	4	P	-	A	.	.
15	6	P	+	A	.	.
16	3	P	-	A	.	.

NOTICE PHASE 3 PED
ASSIGNED TO LD SWITCH 16 →

THIS ELECTRICAL DETAIL IS FOR
THE SIGNAL DESIGN: 06-0224T3
DESIGNED: March 2018
SEALED: 03-29-2018
REVISED: N/A

Temporary Design 3 - TMP Phase III
Electrical Detail - Sheet 2 of 2

DOCUMENT NOT CONSIDERED FINAL
UNLESS ALL SIGNATURES COMPLETED



Stantec Consulting Services Inc.
801 Jones Franklin Road-Suite 300
Raleigh, NC 27606
Tel. (919) 851-6866
Fax. (919) 851-7024
www.stantec.com
License No. F-0672

ELECTRICAL AND PROGRAMMING
DETAILS FOR:

Prepared in the Offices of:



750 N. Greenfield Pkwy, Garner, NC 27529

US 401 Business (Raeford Road)
at
Purdue Drive/
SteinMart Driveway

Division 6 Cumberland County Fayetteville

PLAN DATE: March 2018	REVIEWED BY: L Overn
PREPARED BY: G B Spell	REVIEWED BY:

REVISIONS	INIT.	DATE

SEAL

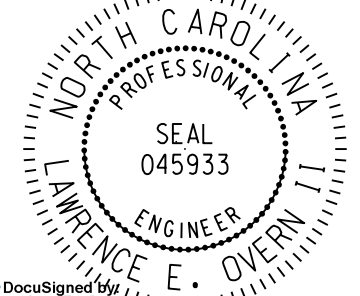

3/29/2018

DATE

SIG. INVENTORY NO. 06-0224T3

DATE: 03/29/2018 10:45:12 AM
User: rfmancey
C:\Users\rfmancey\Documents\Signal\Signal\Phase 3\U-4405\Signal\Phase 3\U-4405.sig.ele_06-0224T3.dgn

EDI MODEL 2018ECLIP-NC CONFLICT MONITOR PROGRAMMING DETAIL

(remove jumpers and set switches as shown)

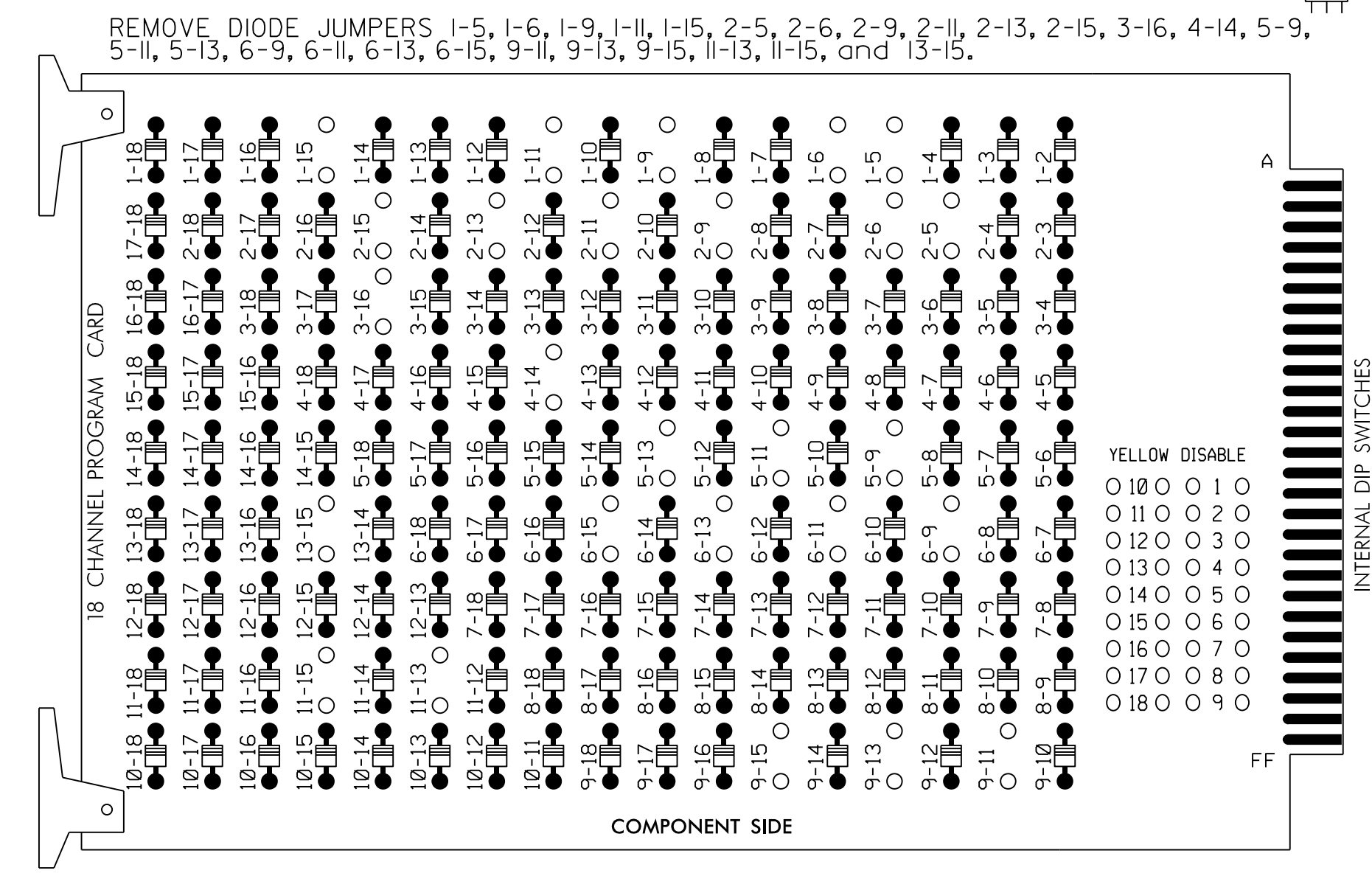

REMOVE JUMPERS AS SHOWN

- NOTES:
- Card is provided with all diode jumpers in place. Removal of any jumper allows its channels to run concurrently.
 - Ensure jumpers SEL2-SEL5 and SEL9 are present on the monitor board.
 - Ensure that Red Enable is active at all times during normal operation.
 - Integrate monitor with Ethernet network in cabinet.

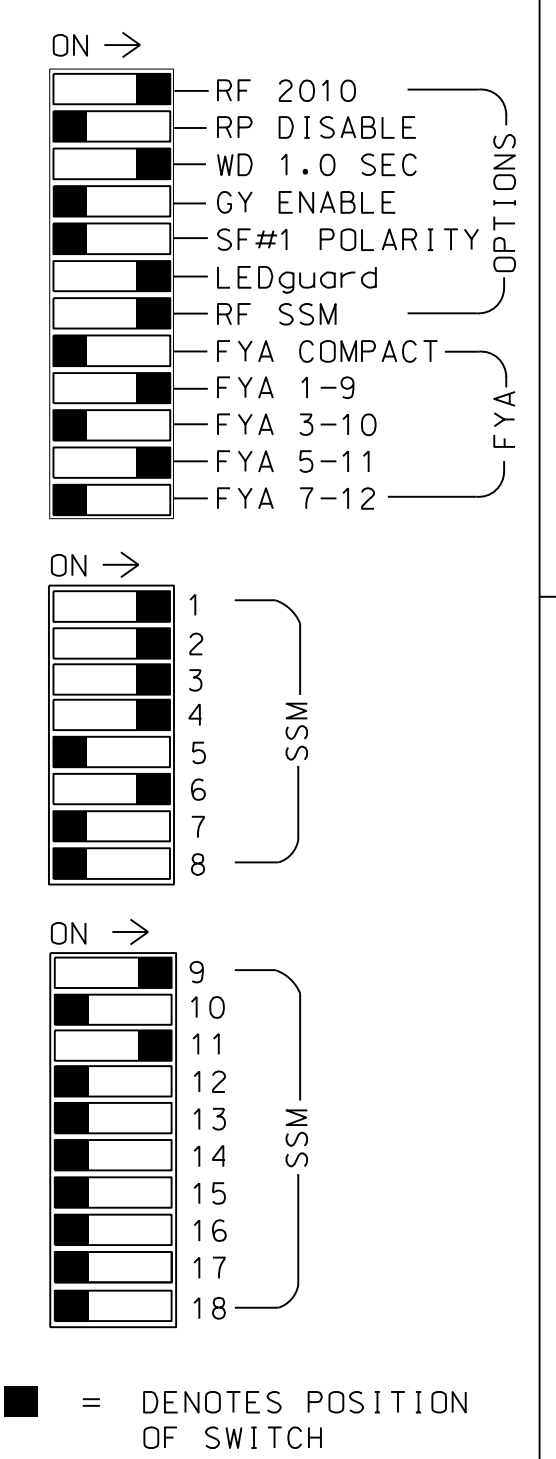

NOTES

- To prevent "flash-conflict" problems, insert red flash program blocks for all unused vehicle load switches in the output file. The installer shall verify that signal heads flash in accordance with the Signal Plans.
- Program controller for start up in Phase 2 WALK and Phase 6 WALK.
- The cabinet and controller are part of the Fayetteville Signal System.

EQUIPMENT INFORMATION

CONTROLLER.....2070
 CABINET.....332 W/AUX
 SOFTWARE.....ECONOLITE ASC/3-2070
 CABINET MOUNT.....BASE
 OUTPUT FILE POSITIONS...18 WITH AUX. OUTPUT FILE
 LOAD SWITCHES USED.....S1,S2,S3,S4,S5,S6,S7,S8,
 S9,S12,AUX S1,AUX S4
 PHASES USED.....1,2,2PED,3,4,4PED,5,6,
 6PED,3PED
 OVERLAP A.....*
 OVERLAP B.....NOT USED
 OVERLAP C.....NOT USED
 OVERLAP D.....NOT USED

* See Overlap Programming Detail on Sheet 2

SIGNAL HEAD HOOK-UP CHART

LOAD SWITCH NO.	S1	S2	S3	S4	S5	S6	S7	S8	S9	S10	S11	S12	AUX S1	AUX S2	AUX S3	AUX S4	AUX S5	AUX S6			
CMU CHANNEL NO.	1	2	13	3	4	14	5	6	15	7	8	16	9	10	17	11	12	18			
PHASE	1	4	2	3	3	4	4	4	5	6	6	7	8	3	OLA	OLB	OLE	OLC	OLD	OLF	
SIGNAL HEAD NO.	11★	42	21,22	P21, P22	31	32	41	42	P41, P42	51★	61,62, 63	P61, P62	NU	NU	P31, P32	11★	NU	NU	51★	NU	NU
RED	*	128		116	116	101	101					134									
YELLOW		129		117	117	102	102		*	135											
GREEN		130		118	118	103	103			136											
RED ARROW															A121					A114	
YELLOW ARROW	126														A122					A115	
FLASHING YELLOW ARROW															A123					A116	
GREEN ARROW	127	127		118		103				133											
Hand							113			104			119							110	
Walking							115			106			121							112	

NU = Not Used
 * Denotes install load resistor. See load resistor installation detail this sheet.
 ★ See pictorial of head wiring in detail below.

COUNTDOWN PEDESTRIAN SIGNAL OPERATION

Countdown Ped Signals are required to display timing only during Ped Clearance Interval. Consult Ped Signal Module user's manual for instructions on selecting this feature.

INPUT FILE POSITION LAYOUT

(front view)

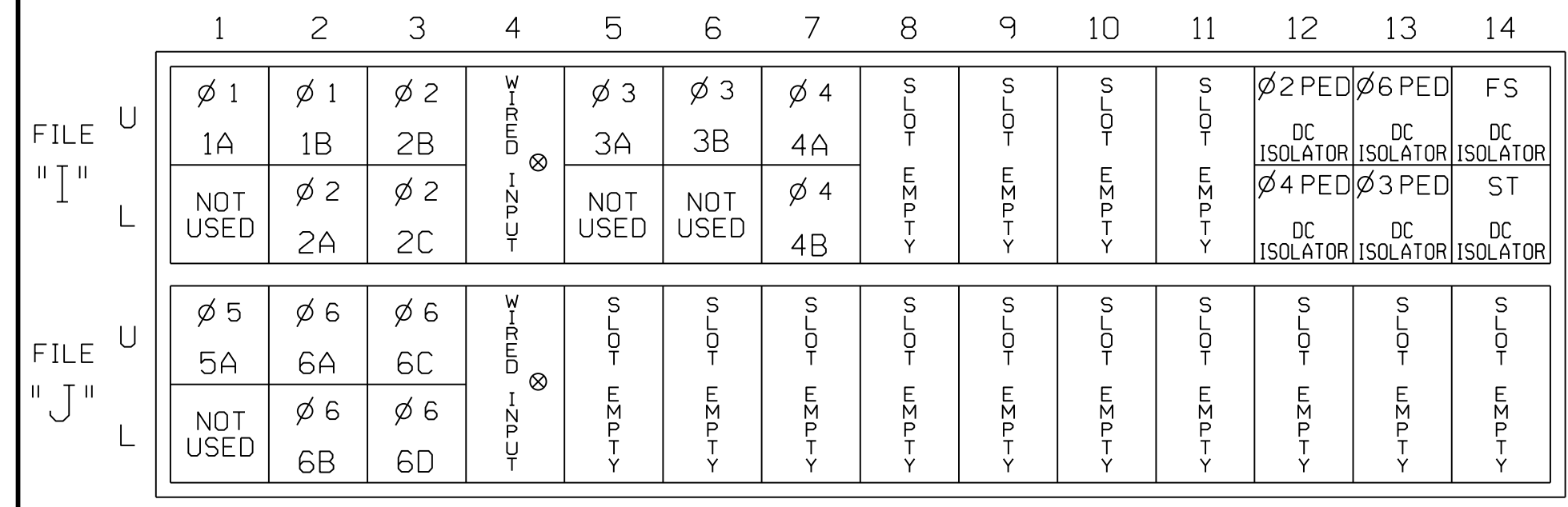

EX.: 1A, 2A, ETC. = LOOP NO.'S
 FS = FLASH SENSE
 * Wired Input - Do not populate slot with detector card
 ST = STOP TIME

INPUT FILE CONNECTION & PROGRAMMING CHART

LOOP NO.	LOOP TERMINAL	INPUT FILE POS.	PIN NO.	DETECTOR NO.	NEMA PHASE	CALL	EXTEND TIME	DELAY TIME	ADDED INITIAL	DETECTOR TYPE
1A ¹	TB2-1,2	I1U	56	1★	1	YES		15		S
	-	J4U	48	26★	6	YES				S
1B	TB2-5,6	I2U	39	2	1	YES		15		S
2A	TB2-7,8	I2L	43	12	2	YES				S
2B	TB2-9,10	I3U	63	32	2	YES				S
2C	TB2-11,12	I3L	76	42	2	YES				S
3A	TB4-5,6	I5U	58	3	3	YES		3		S
3B	TB4-9,10	I6U	41	4	3	YES		10		S
4A	TB6-1,2	I7U	65	34	4	YES		3		S
4B	TB6-3,4	I7L	78	44	4	YES				S
5A ²	TB3-1,2	J1U	55	5★	5	YES		15		S
	-	I4U	47	22★	2	YES				S
6A	TB3-5,6	J2U	40	6	6	YES				S
6B	TB3-7,8	J2L	44	16	6	YES				S
6C	TB3-9,10	J3U	64	36	6	YES				S
6D	TB3-11,12	J3L	77	46	6	YES				S
PED PUSH BUTTONS										
P21,P22	TB8-4,6	I12U	67	PED 2	2	PED				
P31,P32	TB8-8,9	I13L	70	PED 8	3	PED				
P41,P42	TB8-5,6	I12L	69	PED 4	4	PED				
P61,P62	TB8-7,9	I13U	68	PED 6	6	PED				

NOTE:
 INSTALL DC ISOLATORS IN INPUT FILE SLOTS 112 AND 113.

- Add jumper from I1-W to J4-W, on rear of input file.
 - Add jumper from J1-W to I4-W, on rear of input file.
- * See Vehicle Detector Setup Programming Detail for alternate phasing on Sheet 3.

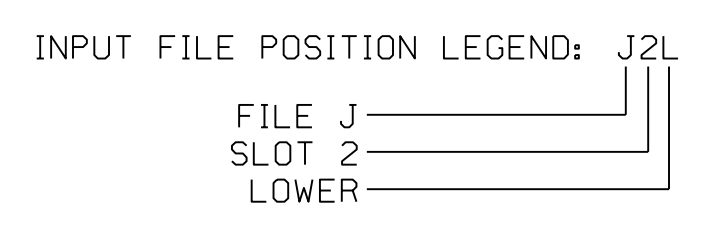

FYA SIGNAL WIRING DETAIL

(wire signal heads as shown)

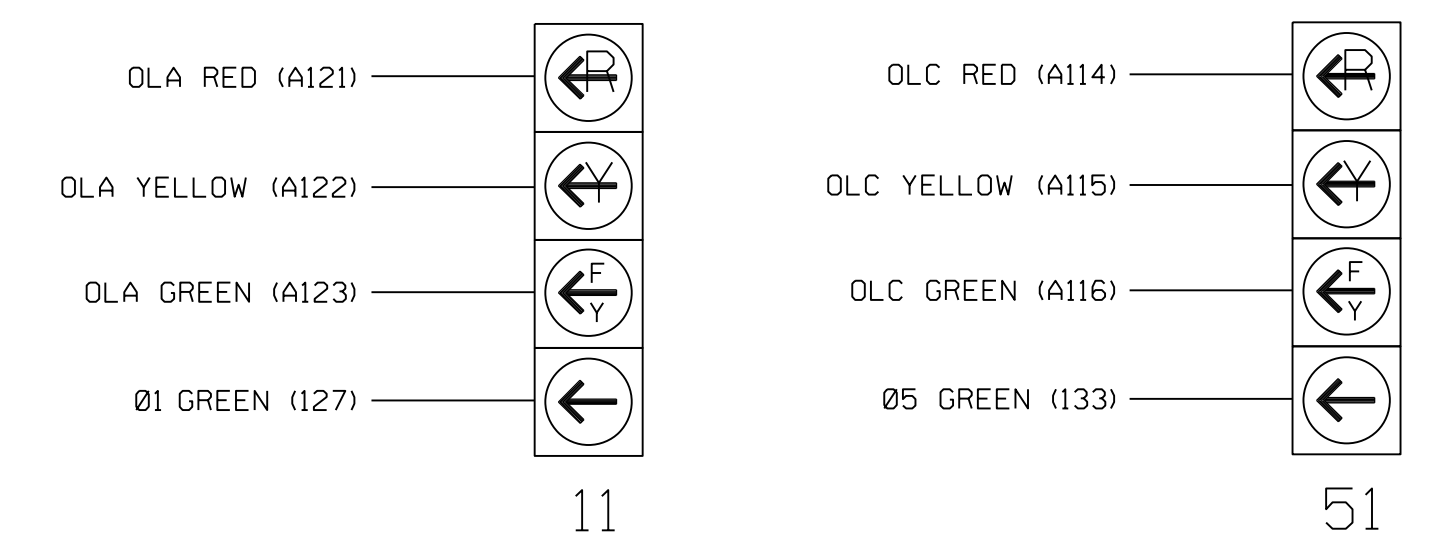

THIS ELECTRICAL DETAIL IS FOR THE SIGNAL DESIGN: 06-0224
 DESIGNED: March 2018
 SEALED: 03-29-2018
 REVISED: N/A

LOAD RESISTOR INSTALLATION DETAIL

(install resistors as shown)

VALUE (ohms)	WATTAGE
1.5K - 1.9K	25W (min)
2.0K - 3.0K	10W (min)

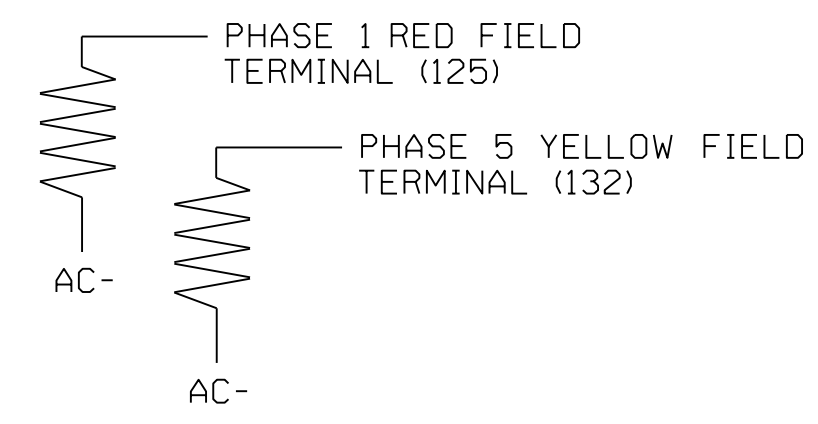

Final Design
 Electrical Detail - Sheet 1 of 3

Stantec Consulting Services Inc.
 801 Jones Franklin Road-Suite 300
 Raleigh, NC 27606
 Tel. (919) 851-6866
 Fax. (919) 851-7024
 www.stantec.com
 License No. F-0672

ELECTRICAL AND PROGRAMMING DETAILS FOR:

US 401 Business (Raeford Road) at Purdue Drive/SteinMart Driveway

Division 6 Cumberland County Fayetteville

PLAN DATE: March 2018 REVIEWED BY: L Overn

PREPARED BY: G B Spell REVIEWED BY:

REVISIONS	INIT.	DATE

SEAL

3/29/2018

DATE

SIG. INVENTORY NO. 06-0224

ECONOLITE ASC/3-2070 OVERLAP PROGRAMMING DETAIL

(program controller as shown)

1. From Main Menu select 2. CONTROLLER
2. From CONTROLLER Submenu select 2. VEHICLE OVERLAPS

OVERLAP A

Select TMG VEH OVLP [A] and 'PPLT FYA'

TMG VEH OVLP...[A] TYPE:PPLT FYA

PROTECTED LEFT TURN.... PHASE 1

OPPOSING THROUGH..... PHASE 2

FLASHING ARROW OUTPUT.....CH9 ISOLATE

DELAY START OF: FYA..0.0 CLEARANCE..0.0

ACTION PLAN SF BIT DISABLE..... 1

← NOTICE ACTION PLAN SF BIT "1"

↓ Toggle Twice

OVERLAP C

Select TMG VEH OVLP [C] and 'PPLT FYA'

TMG VEH OVLP...[C] TYPE:PPLT FYA

PROTECTED LEFT TURN.... PHASE 5

OPPOSING THROUGH..... PHASE 6

FLASHING ARROW OUTPUT.....CH11 ISOLATE

DELAY START OF: FYA..0.0 CLEARANCE..0.0

ACTION PLAN SF BIT DISABLE..... 5

← NOTICE ACTION PLAN SF BIT "5"

END PROGRAMMING

ALTERNATE PHASING ACTIVATION DETAIL

TO RUN ALT. PHASING DURING FREE RUN - PROGRAM CHANGES (SHOWN BELOW) IN A TIME BASED ACTION PLAN. SCHEDULE A DAY PLAN THAT INCLUDES THE ACTION PLAN PROGRAMMED TO SELECT VEH DET PLAN 2 AND ENABLE SF BITS 1 and 5.

TO RUN ALT. PHASING DURING COORDINATION - SELECT THE TIME BASED ACTION PLAN THAT IS PROGRAMMED TO SELECT VEH DET PLAN 2 AND ENABLE SF BITS 1 and 5.

PHASING	VEH DET PLAN	SF BITS ENABLED
ACTIONS REQUIRED TO RUN <u>DEFAULT PHASING</u>	1	NONE
ACTIONS REQUIRED TO RUN <u>ALTERNATE PHASING</u>	2	1, 5

IMPORTANT: IF ALT. PHASING IS USED DURING FREE RUN AND COORDINATION, DO NOT OPERATE TIME OF DAY EVENTS CONCURRENTLY WITH COORDINATION PLAN EVENTS IN THE EVENT SCHEDULER. (EX. FREE RUN EVENT SHOULD END BEFORE COORDINATION PLAN EVENT STARTS AND VICE-VERSA).

ALTERNATE PHASING CHANGE SUMMARY

THE FOLLOWING IS A SUMMARY OF WHAT TAKES PLACE WHEN SF BITS 1 AND 5 AND VEH DET PLAN 2 ACTIVATE TO CALL THE "ALTERNATE PHASING":

SF BITS 1,5: Modifies overlap parent phases for heads 11 and 51 to run protected turns only.

VEH DET PLAN 2: Disables phase 6 call on loop 1A and reduces delay time for phase 1 call on loop 1A to 0 seconds.

Disables phase 2 call on loop 5A and reduces delay time for phase 5 call on loop 5A to 0 seconds.

ECONOLITE ASC/3-2070 ACTION PLAN PROGRAMMING DETAIL

1. From Main Menu select 5. TIME BASE
2. From TIME BASE Submenu select 2. ACTION PLAN

ACTION PLAN...[1]

PATTERN.....AUTO SYS OVERRIDE.... NO

TIMING PLAN..... 0 SEQUENCE..... 0

VEH DETECTOR PLAN.. 2 DET LOG.....NONE

FLASH..... -- RED REST..... NO

VEH DET DIAG PLN.. 0 PED DET DIAG PLN.. 0

DIMMING ENABLE.. NO PRIORITY RETURN. NO

PED PR RETURN.. NO QUEUE DELAY..... NO

PMT COND DELAY NO

PHASE	1	2	3	4	5	6	7	8	9	0	1	2	3	4	5	6
PED RCL
WALK 2
VEX 2
VEH RCL
MAX RCL
MAX 2
PHASE	1	2	3	4	5	6	7	8	9	0	1	2	3	4	5	6
MAX 3
CS 1NH
DMIT
SPC FCT	X	.	.	X	(1-8)
AUX FCT	(1-3)
LP 1-15
LP 16-30
LP 31-45
LP 46-60
LP 61-75
LP 76-90
LP 91-100

ECONOLITE ASC/3-2070 PED 3 PROGRAMMING ASSIGNMENT DETAIL

(program controller as shown)

1. From Main Menu select 6. DETECTORS
2. From DETECTOR Submenu select 3. PED DETECTOR INPUT ASSIGNMENT

PED DET PHASE ASSIGNMENT MODE: NTCIP

PHASE	1	2	3	4	5	6	7	8
DETECTOR	0	2	8	4	0	6	0	0
PHASE	9	10	11	12	13	14	15	16
DETECTOR	0	0	0	0	0	0	0	0

← NOTICE PED DETECTOR 8 ASSIGNED TO PHASE 3

1. From Main Menu select 1. CONFIGURATION
2. From CONFIGURATION Submenu select 3. LOAD SW ASSIGN

LD SWITCH ASSIGN

PHASE	DIMMING	---FLASH---
/OVLP TYPE R Y G D	PWR	AUT TGR
1 1 V . . . + A R X		
2 2 V . . . + A Y .		
3 3 V . . . + A R X		
4 4 V . . . + A R .		
5 5 V . . . - A R .		
6 6 V . . . - A Y X		
7 7 V . . . - A R .		
8 8 V . . . - A R X		
9 1 O . . . + A R X		
10 2 O . . . + A R X		
11 3 O . . . - A R .		
12 4 O . . . - A R .		
13 2 P . . . + A . .		
14 4 P . . . - A . .		
15 6 P . . . + A . .		
16 3 P . . . - A . .		

← NOTICE PHASE 3 PED ASSIGNED TO LD SWITCH 16

Final Design
Electrical Detail - Sheet 2 of 3

THIS ELECTRICAL DETAIL IS FOR THE SIGNAL DESIGN: 06-0224

DESIGNED: March 2018

SEALED: 03-29-2018

REVISED: N/A

DOCUMENT NOT CONSIDERED FINAL UNLESS ALL SIGNATURES COMPLETED

<p style="font-size: x-small;">Stantec Consulting Services Inc. 801 Jones Franklin Road-Suite 300 Raleigh, NC 27606 Tel. (919) 851-6866 Fax. (919) 851-7024 www.stantec.com License No. F-0672</p>	<p style="font-size: x-small;">ELECTRICAL AND PROGRAMMING DETAILS FOR:</p> <p style="font-size: x-small;">Prepared in the Offices of:</p> <p style="font-size: x-small;">750 N. Greenfield Pkwy, Garner, NC 27529</p>	<p style="font-weight: bold;">US 401 Business (Raeford Road)</p> <p style="font-weight: bold;">at</p> <p style="font-weight: bold;">Purdue Drive/ SteinMart Driveway</p> <p style="font-size: x-small;">Division 6 Cumberland County Fayetteville</p> <table style="width: 100%; border-collapse: collapse; font-size: x-small;"> <tr> <td>PLAN DATE: March 2018</td> <td>REVIEWED BY: L Overn</td> </tr> <tr> <td>PREPARED BY: G B Spell</td> <td>REVIEWED BY:</td> </tr> </table>	PLAN DATE: March 2018	REVIEWED BY: L Overn	PREPARED BY: G B Spell	REVIEWED BY:	<p style="font-size: x-small;">SEAL</p> <p style="font-size: x-small;">3/29/2018</p> <p style="font-size: x-small;">DATE</p>		
PLAN DATE: March 2018	REVIEWED BY: L Overn								
PREPARED BY: G B Spell	REVIEWED BY:								
		<table border="1" style="width: 100%; border-collapse: collapse;"> <tr> <th style="width: 50%;">REVISIONS</th> <th style="width: 25%;">INIT.</th> <th style="width: 25%;">DATE</th> </tr> <tr> <td> </td> <td> </td> <td> </td> </tr> </table>	REVISIONS	INIT.	DATE				<p>DocuSign Envelope ID: 86D54535-9650-4DA6-8C64-07D62DB39918</p> <p style="font-size: x-small;">SIG. INVENTORY NO. 06-0224</p>
REVISIONS	INIT.	DATE							

DATE: 03/29/2018 10:45:11 AM User: rfmancey

ECONOLITE ASC/3-2070 VEHICLE DETECTOR SETUP PROGRAMMING DETAIL FOR ALTERNATE PHASING LOOPS 1A, 5A (program controller as shown)

IMPORTANT!

Program detectors per the input file connection and programming chart shown on sheet 1 before proceeding.

- From Main Menu select **8. UTILITIES**
- From UTILITIES Submenu select **1. COPY/CLEAR**
- Copy from DETECTOR PLAN "1" to DETECTOR PLAN "2".

```

COPY / CLEAR UTILITY
FROM          TO
PHASE TIMING... > PHASE TIMING...
TIMING PLAN... > TIMING PLAN...
PH DET OPT PLAN... > PH DET OPT PLAN...
DETECTOR PLAN... 1 > DETECTOR PLAN... 2
TOGGLE TO SELECT A "FROM" AND A "TO"
THEN PRESS ENTER
  
```

- From Main Menu select **6. DETECTORS**
- From DETECTOR Submenu select **2. VEHICLE DETECTOR SETUP**
- Place cursor in VEH DET PLAN [] position and enter "2".

- Place cursor in VEH DETECTOR [] position and enter "1".
- Set delay time to "0".

```

VEH DETECTOR [ 1 ]  VEH DET PLAN [ 2 ]
TYPE: S-STANDARD
TS2 DETECTOR..... ECPI LOG..... NO
DET PH - 1 2 3 4 5 6 7 8 9 0 1 2 3 4 5 6
1 1
EXTEND TIME... 0.0 DELAY TIME... 0.0
USE ADDED INITIAL . CROSS SWITCH PH.. 0
LOCK IN..... NONE NTCIP VOL . OR OCC .
PMT QUEUE DELAY. NO
  
```

- Place cursor in VEH DETECTOR [] position and enter "26".
- Set assigned phase to "0".

```

VEH DETECTOR [26]  VEH DET PLAN [ 2 ]
TYPE: S-STANDARD
TS2 DETECTOR..... ECPI LOG..... NO
DET PH - 1 2 3 4 5 6 7 8 9 0 1 2 3 4 5 6
26 0
EXTEND TIME... 0.0 DELAY TIME... 0.0
USE ADDED INITIAL . CROSS SWITCH PH.. 0
LOCK IN..... NONE NTCIP VOL . OR OCC .
PMT QUEUE DELAY. NO
  
```

- Place cursor in VEH DETECTOR [] position and enter "5".
- Set delay time to "0".

```

VEH DETECTOR [ 5 ]  VEH DET PLAN [ 2 ]
TYPE: S-STANDARD
TS2 DETECTOR..... ECPI LOG..... NO
DET PH - 1 2 3 4 5 6 7 8 9 0 1 2 3 4 5 6
5 5
EXTEND TIME... 0.0 DELAY TIME... 0.0
USE ADDED INITIAL . CROSS SWITCH PH.. 0
LOCK IN..... NONE NTCIP VOL . OR OCC .
PMT QUEUE DELAY. NO
  
```

- Place cursor in VEH DETECTOR [] position and enter "22".
- Set assigned phase to "0".

```

VEH DETECTOR [22]  VEH DET PLAN [ 2 ]
TYPE: S-STANDARD
TS2 DETECTOR..... ECPI LOG..... NO
DET PH - 1 2 3 4 5 6 7 8 9 0 1 2 3 4 5 6
22 0
EXTEND TIME... 0.0 DELAY TIME... 0.0
USE ADDED INITIAL . CROSS SWITCH PH.. 0
LOCK IN..... NONE NTCIP VOL . OR OCC .
PMT QUEUE DELAY. NO
  
```

END PROGRAMMING

THIS ELECTRICAL DETAIL IS FOR
THE SIGNAL DESIGN: 06-0224
DESIGNED: March 2018
SEALED: 03-29-2018
REVISED: N/A

Final Design
Electrical Detail - Sheet 3 of 3

DOCUMENT NOT CONSIDERED FINAL
UNLESS ALL SIGNATURES COMPLETED



Stantec Consulting Services Inc.
801 Jones Franklin Road-Suite 300
Raleigh, NC 27606
Tel. (919) 851-6866
Fax. (919) 851-7024
www.stantec.com
License No. F-0672

ELECTRICAL AND PROGRAMMING
DETAILS FOR:

Prepared in the Offices of:

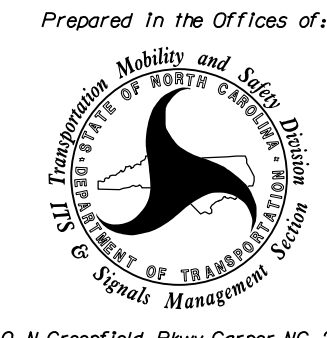

750 N. Greenfield Pkwy, Garner, NC 27529

US 401 Business (Raeford Road)
at
Purdue Drive/
SteinMart Driveway

Division 6 Cumberland County Fayetteville

PLAN DATE: March 2018 REVIEWED BY: L Overn
PREPARED BY: G B Spell REVIEWED BY:

REVISIONS	INIT.	DATE

SEAL

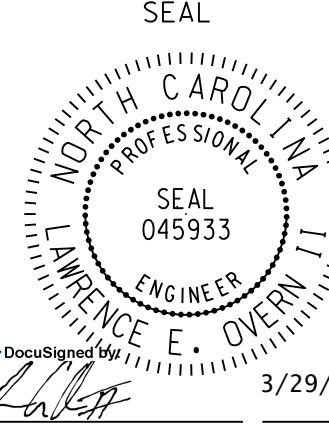

3/29/2018
DATE
SIG. INVENTORY NO. 06-0224

DATE: 03/29/2018 11:04:11 AM
USER: rfmancey

DEFAULT PHASING DIAGRAM

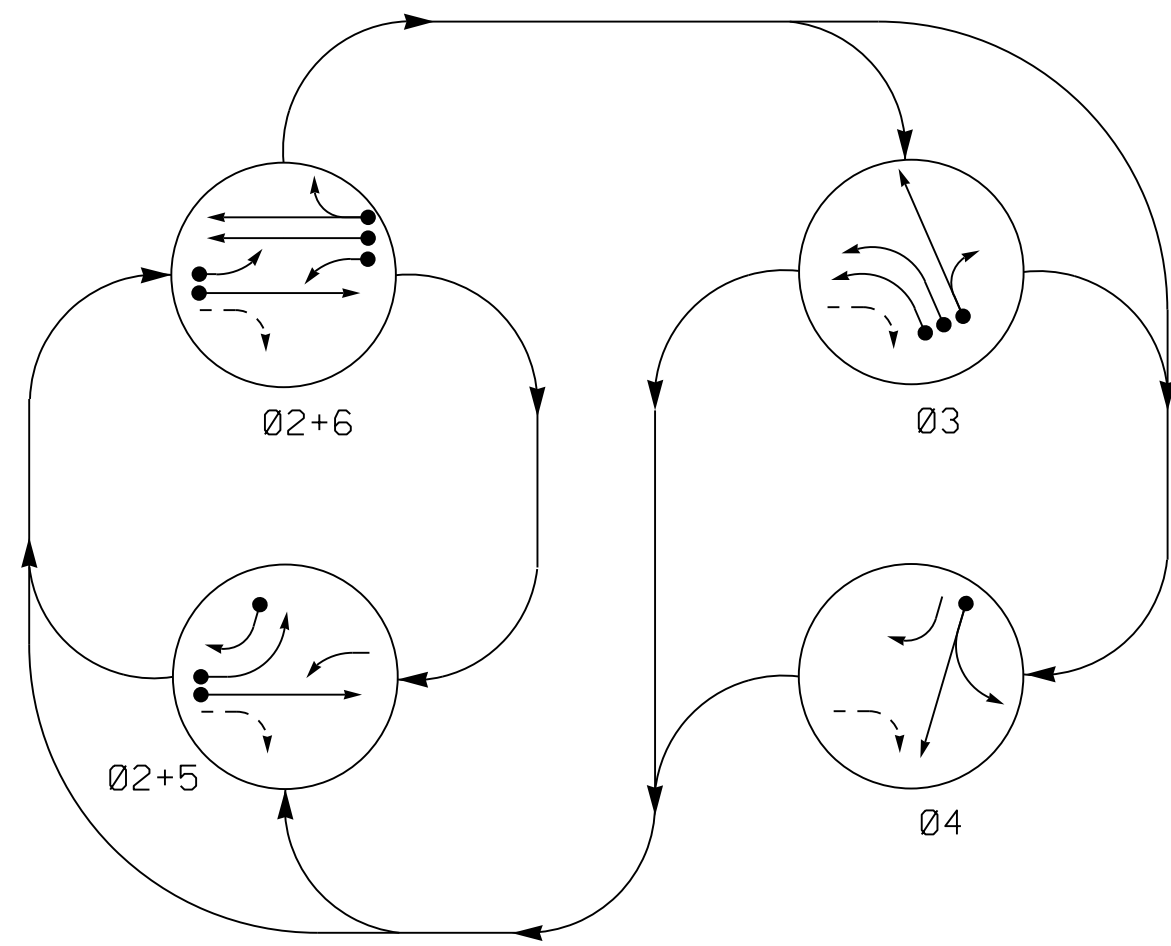

ALTERNATE PHASING DIAGRAM

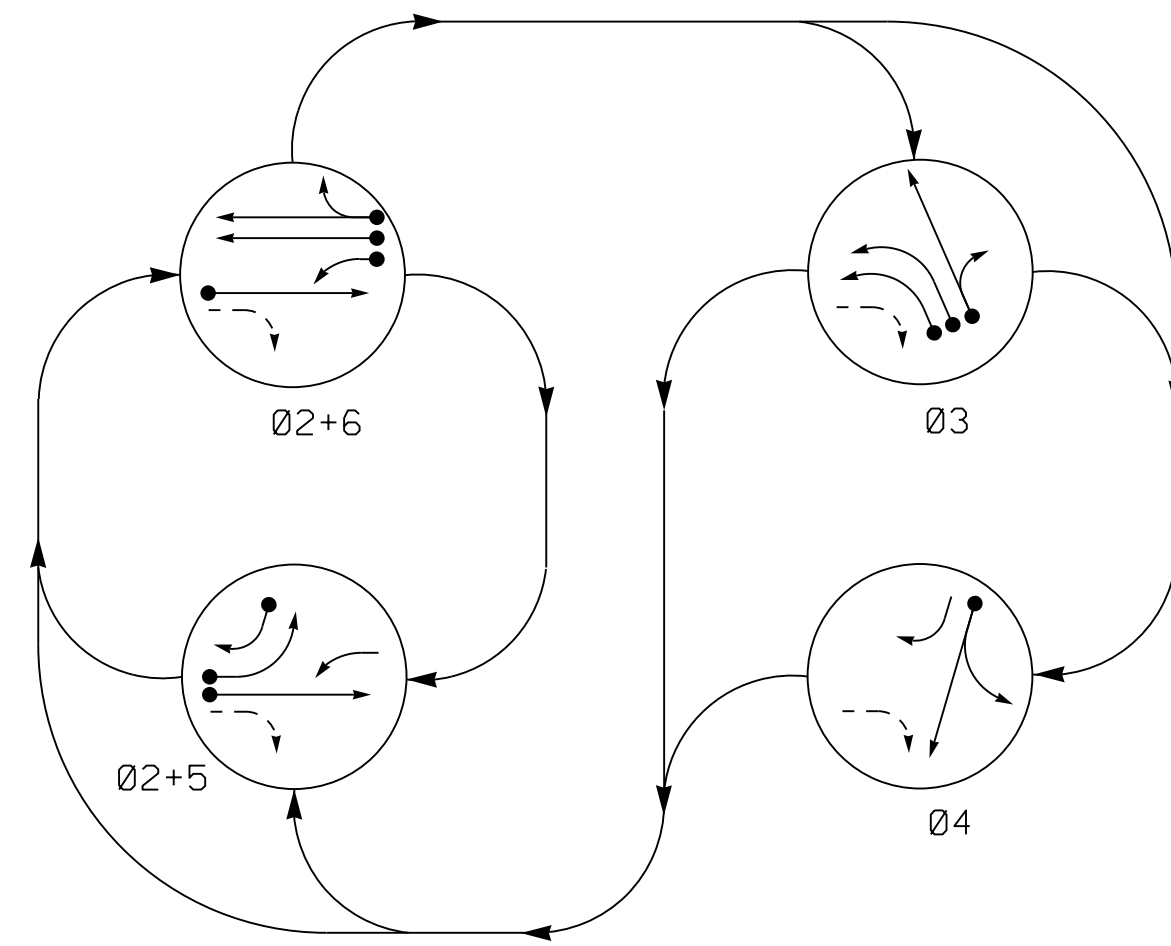

SIGNAL FACE I.D.

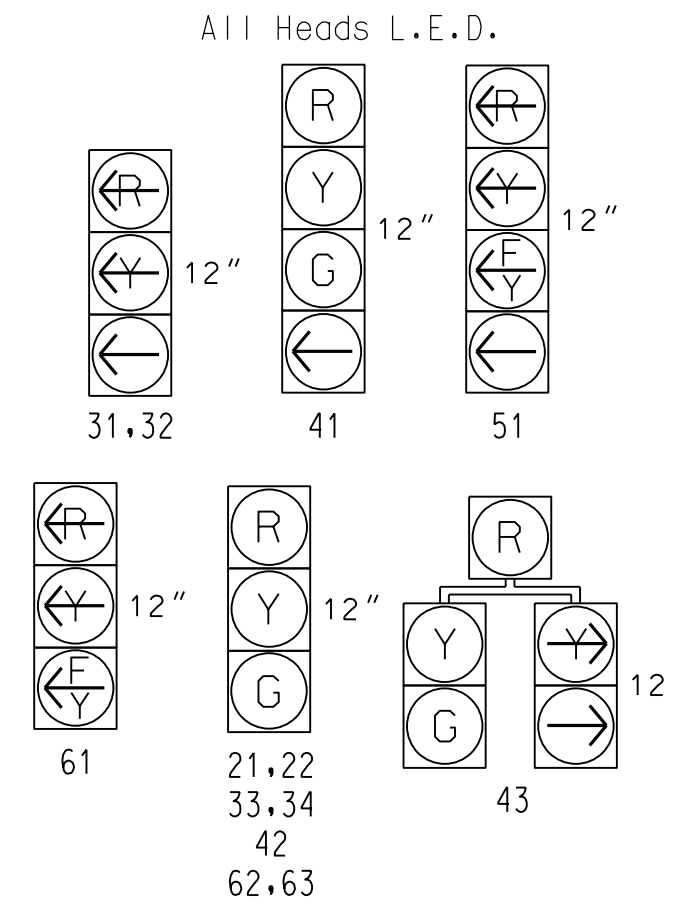

ASC/3 DETECTOR INSTALLATION CHART											
DETECTOR					PROGRAMMING						
LOOP	SIZE (FT)	DISTANCE FROM STOPBAR (FT)	TURNS	NEW LOOP	PHASE	CALLING	EXTEND TIME	DELAY TIME	USE ADDED INITIAL	TYPE	SYSTEM LOOP NEW CARD
2A	6X6	70	*	-	2	Yes	-	-	-	S	- X
3A	6X40	0	*	-	3	Yes	-	3	-	S	- X
3B	6X40	0	*	-	3	Yes	-	-	-	S	- X
3C	6X40	0	*	-	3	Yes	-	10	-	S	- X
4A	6X40	0	*	-	4	Yes	-	3	-	S	- X
5A	6X40	0	*	-	5	Yes	-	15★	-	S	- X
5B	6X40	0	*	-	2#	Yes	-	-	-	S	- X
6A	6X40	0	*	-	6	Yes	-	-	-	S	- X
6B	6X6	70	*	-	6	Yes	-	-	-	S	- X
6C	6X6	70	*	-	6	Yes	-	-	-	S	- X

*Video Detection Area. Camera locations should be confirmed in the field by the contractor in order to provide detection of the areas indicated.
 #Disable Phase(s) calling during Alternate Phasing Operation.
 ★Reduce delay from 15 to 3 seconds during Alternate Phasing Operation.

SIGNAL FACE	PHASE					TOTAL
	02+5	02+6	03	04	F	
21,22	G	G	R	R	Y	
31,32	-R	-R	-R	-R	-R	
33,34	R	R	G	R	R	
41	R	R	R	G	R	
42	R	R	R	G	R	
43	R	R	R	G	R	
51	-L	-L	-L	-L	-L	
61	-L	-L	-L	-L	-L	
62,63	R	G	R	R	Y	

SIGNAL FACE	PHASE					TOTAL
	02+5	02+6	03	04	F	
21,22	G	G	R	R	Y	
31,32	-R	-R	-R	-R	-R	
33,34	R	R	G	R	R	
41	R	R	R	G	R	
42	R	R	R	G	R	
43	R	R	R	G	R	
51	-L	-L	-L	-L	-L	
61	-L	-L	-L	-L	-L	
62,63	R	G	R	R	Y	

PHASING DIAGRAM DETECTION LEGEND

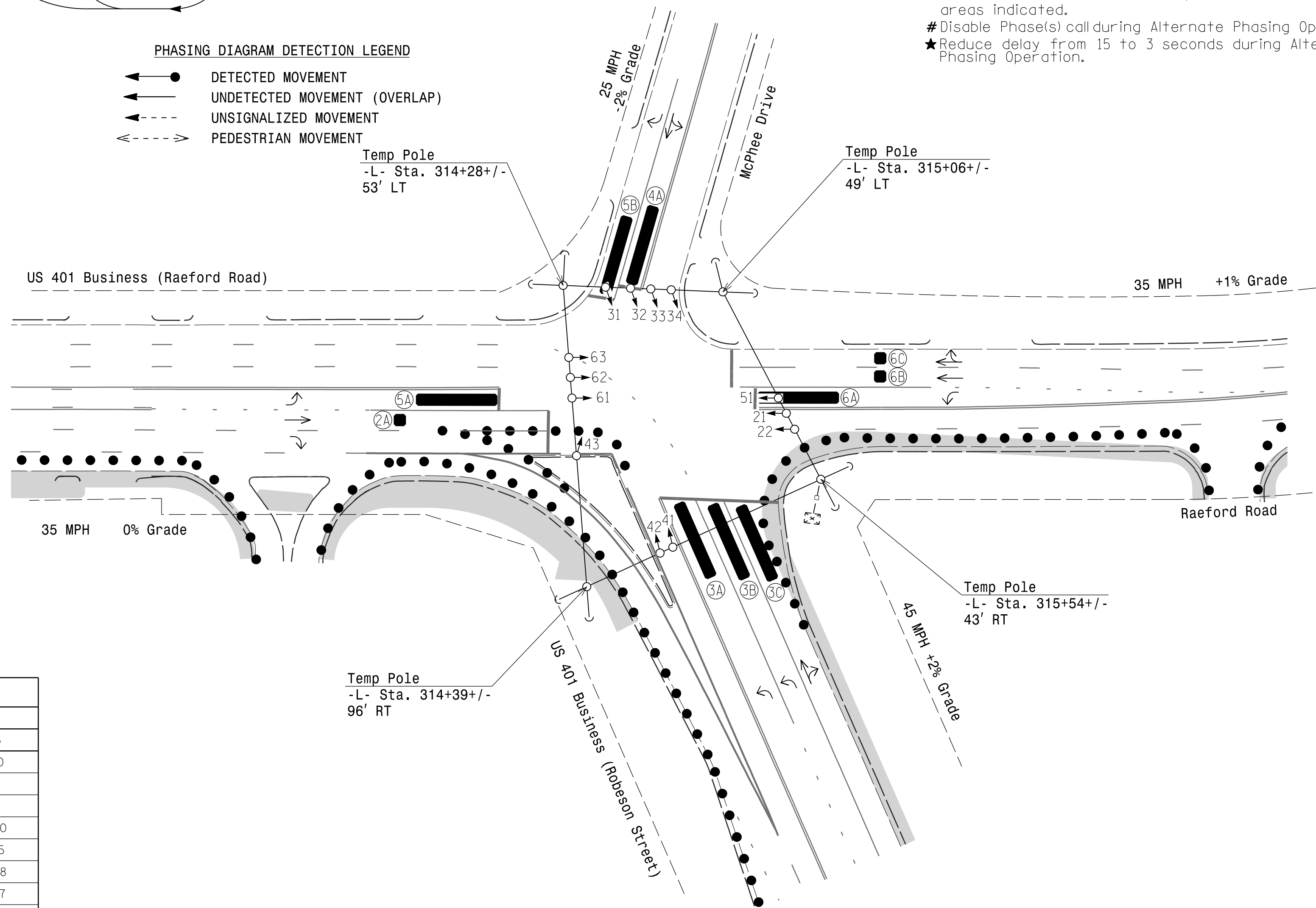
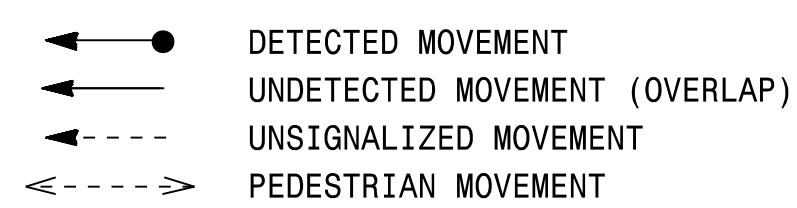

4 Phase Fully Actuated Fayetteville Signal System

NOTES

- Refer to "Roadway Standard Drawings NCDOT" dated January 2018 and "Standard Specifications for Roads and Structures" dated January 2018.
- Do not program signal for late night flashing operation unless otherwise directed by the Engineer.
- Phase 5 may be lagged.
- The order of phase 3 and phase 4 may be reversed.
- Set all detector units to presence mode.
- Locate new cabinet foundation so as not to obstruct sight distance of vehicles turning right on red. Relocate existing cabinet and controller onto new foundation.
- The Division (City) Traffic Engineer will determine the hours of use for each phasing plan.
- Maximum times shown in timing chart are for free-run operation only. Coordinated signal system timing values supersede these values.
- Field adjust temporary poles as needed.

LEGEND

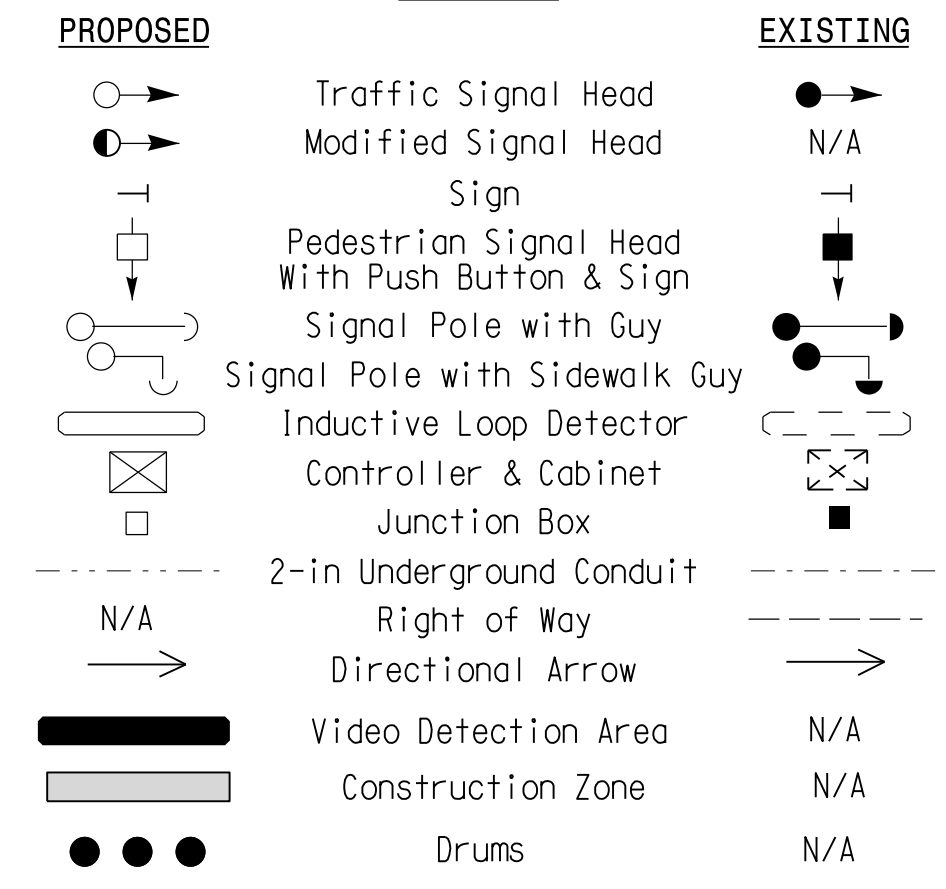

FEATURE	PHASE				
	2	3	4	5	6
Min Green *	10	7	7	7	10
Walk *	-	-	-	-	-
Ped Clear	-	-	-	-	-
Veh. Extension *	3.0	2.0	2.0	2.0	3.0
Max I *	45	25	20	15	45
Yellow	3.8	4.3	3.3	3.0	3.8
Red Clear	1.7	2.0	2.3	2.4	1.7
Red Revert	-	-	-	-	-
Actuations B4 Add *	-	-	-	-	-
Seconds /Actuation *	-	-	-	-	-
Max Initial *	-	-	-	-	-
Time Before Reduction *	-	-	-	-	-
Time To Reduce *	-	-	-	-	-
Minimum Gap	-	-	-	-	-
Locking Detector	-	X	-	-	X
Recall Position	-	VEH. RECALL	-	-	VEH. RECALL
Dual Entry	-	-	-	-	-
Simultaneous Gap	X	X	X	X	X

* These values may be field adjusted. Do not adjust Min Green and Extension times for phases 2 and 6 lower than what is shown. Min Green for all other phases should not be lower than 4 seconds.

Signal Upgrade Temporary Design 1 - TMP Phase I

Stantec Consulting Services Inc.
801 Jones Franklin Road-Suite 300
Raleigh, NC 27606
Tel. (919) 851-6866
Fax. (919) 851-7024
www.stantec.com
License No. F-0672

Prepared for the Offices of:

750 N. Greenfield Pkwy, Garner, NC 27526

US 401 Bus./SR 1414 (Raeford Road) at US 401 Bus. (Robeson Street) /McPhee Drive

Division 6 Cumberland County Fayetteville

PLAN DATE: March 2018 REVIEWED BY: E D Harris

PREPARED BY: G B Spell REVIEWED BY: B L Watson

REVISIONS	INIT.	DATE

3/29/2018

DATE

SIG. INVENTORY NO. 06-000211

DOCUMENT NOT CONSIDERED FINAL UNLESS ALL SIGNATURES COMPLETED

3/29/2018 10:58 AM
 User: rfmuncy
 Path: \\frf\c:\gs\signal\Design\Temporary_Signal_Design\Phase_1\U-4405.sig.dgn,06-000211.dgn