

SPLICE NO.

S12-6

WEBB AVE & LAKEVIEW AVE
SEE: CRP-6.132

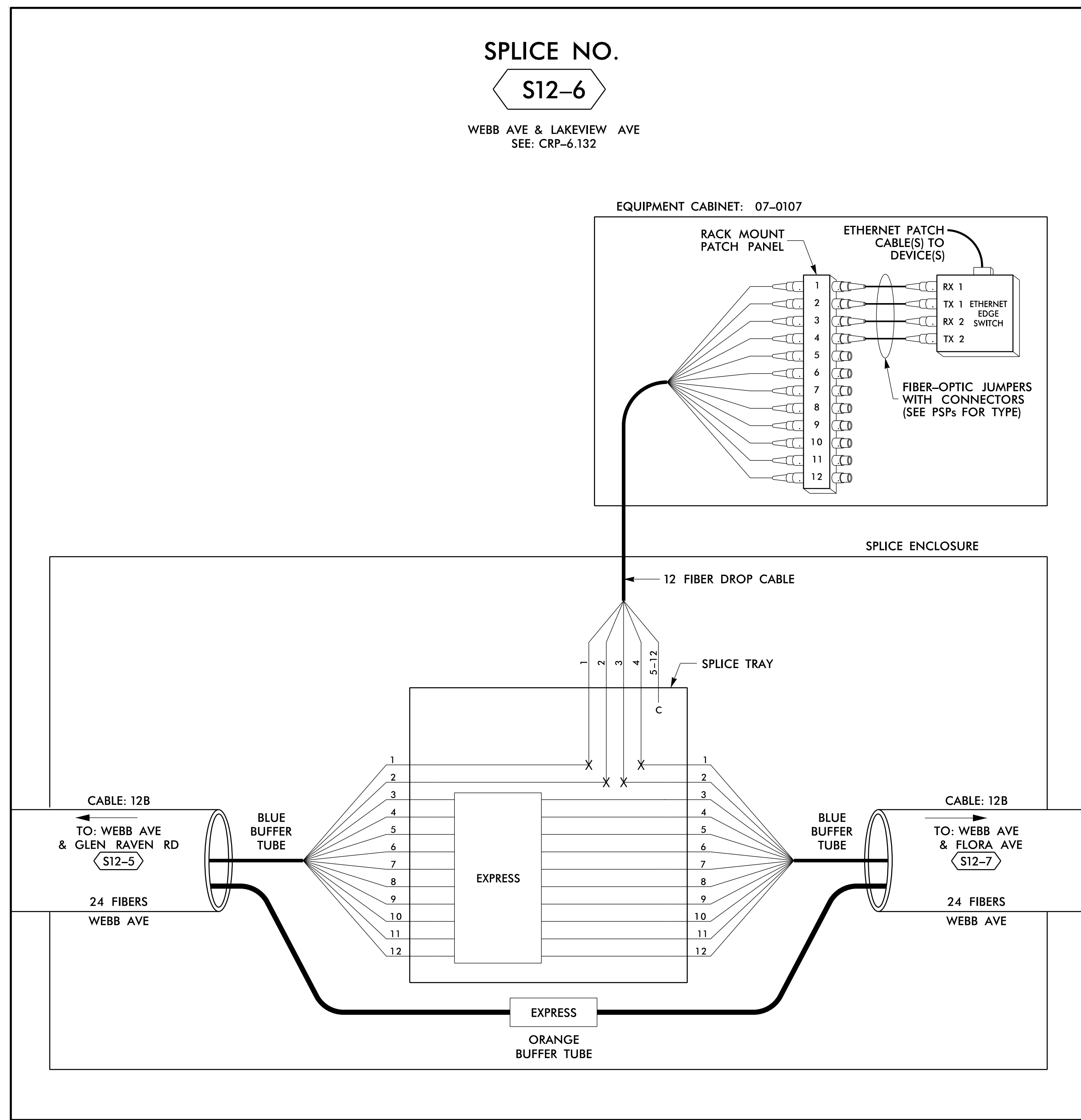

14 JUN 2018 12:29
 D:\Technical\Projects\U-6015 B-C Sig_Sys\Task 11_Comms\F5 4_076.dgn
 S:\DCS\653 AT_LUS355433

LEGEND

COLOR CODE TIA/EIA 598-B		X = FUSION SPlice INDIVIDUAL FIBER C = CAP AND SEAL
(1) BLUE	(7) RED	EXPRESS
(2) ORANGE	(8) BLACK	EXPRESS ENTIRE BUFFER TUBE / FIBERS THROUGH WITHOUT CUTTING
(3) GREEN	(9) YELLOW	BUFFER SPlice
(4) BROWN	(10) VIOLET	SPlice ALL FIBERS IN BUFFER TUBE COLOR TO COLOR
(5) SLATE	(11) ROSE	EXISTING
(6) WHITE	(12) AQUA	EXISTING BUFFER TUBE / FIBERS. DO NOT MODIFY EXISTING SPlices OR EXPRESSED FIBERS.

NOTES

- UNUSED FIBERS LEFT COILED AND STORED IN SPLICE TRAY
- UNUSED BUFFER TUBES LEFT COILED AND STORED IN SPLICE ENCLOSURE
- EDGE SWITCH CONFIGURATIONS ARE GENERIC. CONTRACTOR IS RESPONSIBLE FOR DETERMINING/ENSURING THE PROPER TERMINATIONS.

ATKINS 1616 EAST MILLBROOK ROAD, SUITE 160
 RALEIGH, NORTH CAROLINA 27609
 (919) 876-6888 NCBEEES #F-0326

DOCUMENT NOT CONSIDERED FINAL UNLESS ALL SIGNATURES COMPLETED

Prepared for the Offices of: 750 Greenfield Parkway, Garner, NC 27529	Burlington-Graham Signal System Fiber-Optic Splicing Details		SEAL NORTH CAROLINA PROFESSIONAL ENGINEER SEAL 040877 BRADFORD J. SLOCUM 15/2018 DATE
	Division 7 Alamance County PLAN DATE: June 2018 PREPARED BY: BJ SLOCUM	Burlington & Graham REVIEWED BY: HA BADGETT REVIEWED BY: DL JONES	
SCALE N/A	CADD File name: FS_4.076.dgn		

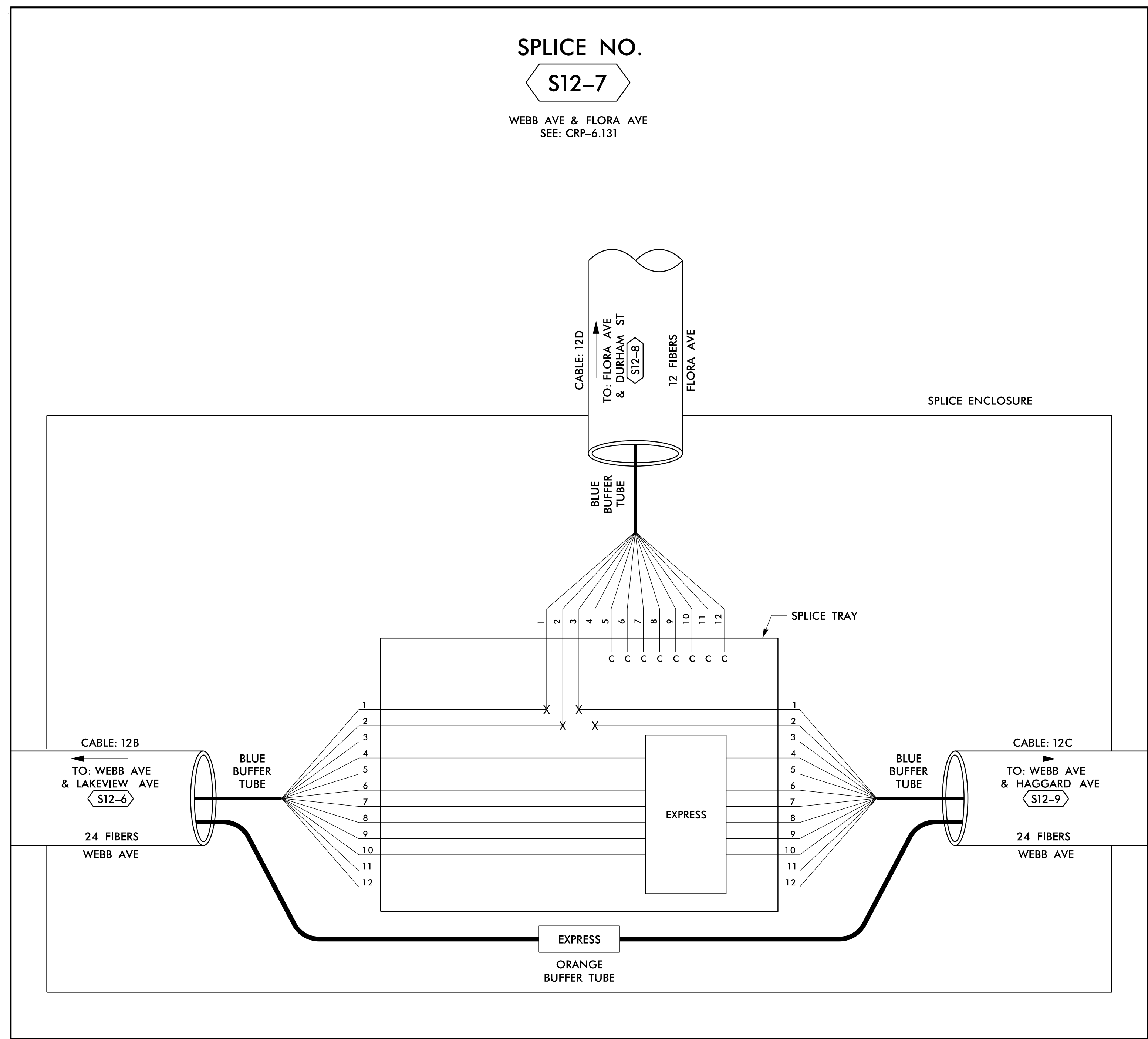

14 JUN 2018 12:29
 D:\Technical\Information\Traffic\Cur*100056469 U=6015 B=C Sig_Sys*Task 11_Corrs*FS 4.077.dgn
 S:\DCS\653 AT LUS355433

COLOR CODE		LEGEND	
(1) BLUE	(7) RED	X = FUSION SPlice INDIVIDUAL FIBER	EXPRESS ENTIRE BUFFER TUBE /FIBERS THROUGH WITHOUT CUTTING
(2) ORANGE	(8) BLACK	C = CAP AND SEAL	EXPRESS ENTIRE BUFFER TUBE /FIBERS THROUGH WITHOUT CUTTING
(3) GREEN	(9) YELLOW		EXPRESS ENTIRE BUFFER TUBE /FIBERS THROUGH WITHOUT CUTTING
(4) BROWN	(10) VIOLET		EXPRESS ENTIRE BUFFER TUBE /FIBERS THROUGH WITHOUT CUTTING
(5) SLATE	(11) ROSE		EXPRESS ENTIRE BUFFER TUBE /FIBERS THROUGH WITHOUT CUTTING
(6) WHITE	(12) AQUA		EXPRESS ENTIRE BUFFER TUBE /FIBERS THROUGH WITHOUT CUTTING
			EXPRESS ENTIRE BUFFER TUBE /FIBERS THROUGH WITHOUT CUTTING

- NOTES**
- UNUSED FIBERS LEFT COILED AND STORED IN SPlice TRAY
 - UNUSED BUFFER TUBES LEFT COILED AND STORED IN SPlice ENCLOSURE
 - EDGE SWITCH CONFIGURATIONS ARE GENERIC. CONTRACTOR IS RESPONSIBLE FOR DETERMINING/ENSURING THE PROPER TERMINATIONS.

ATKINS 1616 EAST MILLBROOK ROAD, SUITE 160
 RALEIGH, NORTH CAROLINA 27609
 (919) 876-6888 NCBEE# F-0326

**DOCUMENT NOT CONSIDERED FINAL
 UNLESS ALL SIGNATURES COMPLETED**

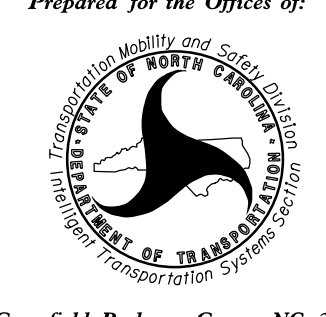
Prepared for the Offices of:  DEPARTMENT OF TRANSPORTATION STATE OF NORTH CAROLINA		SEAL NORTH CAROLINA PROFESSIONAL SEAL 040877 ENGINEER BRADFORD J. SLOCUM 15/2018 DATE	
Burlington-Graham Signal System Fiber-Optic Splicing Details		Division 7 Alamance County Burlington & Graham	
PLAN DATE: June 2018	REVIEWED BY: HA BADGETT	PREPARED BY: BJ SLOCUM	REVIEWED BY: DL JONES
SCALE: N/A		REVISIONS INIT. DATE	

CAD00 File name: FS 4.077.dgn

SPLICE NO.

S12-8

FLORA AVE & DURHAM ST
SEE: CRP-6.156

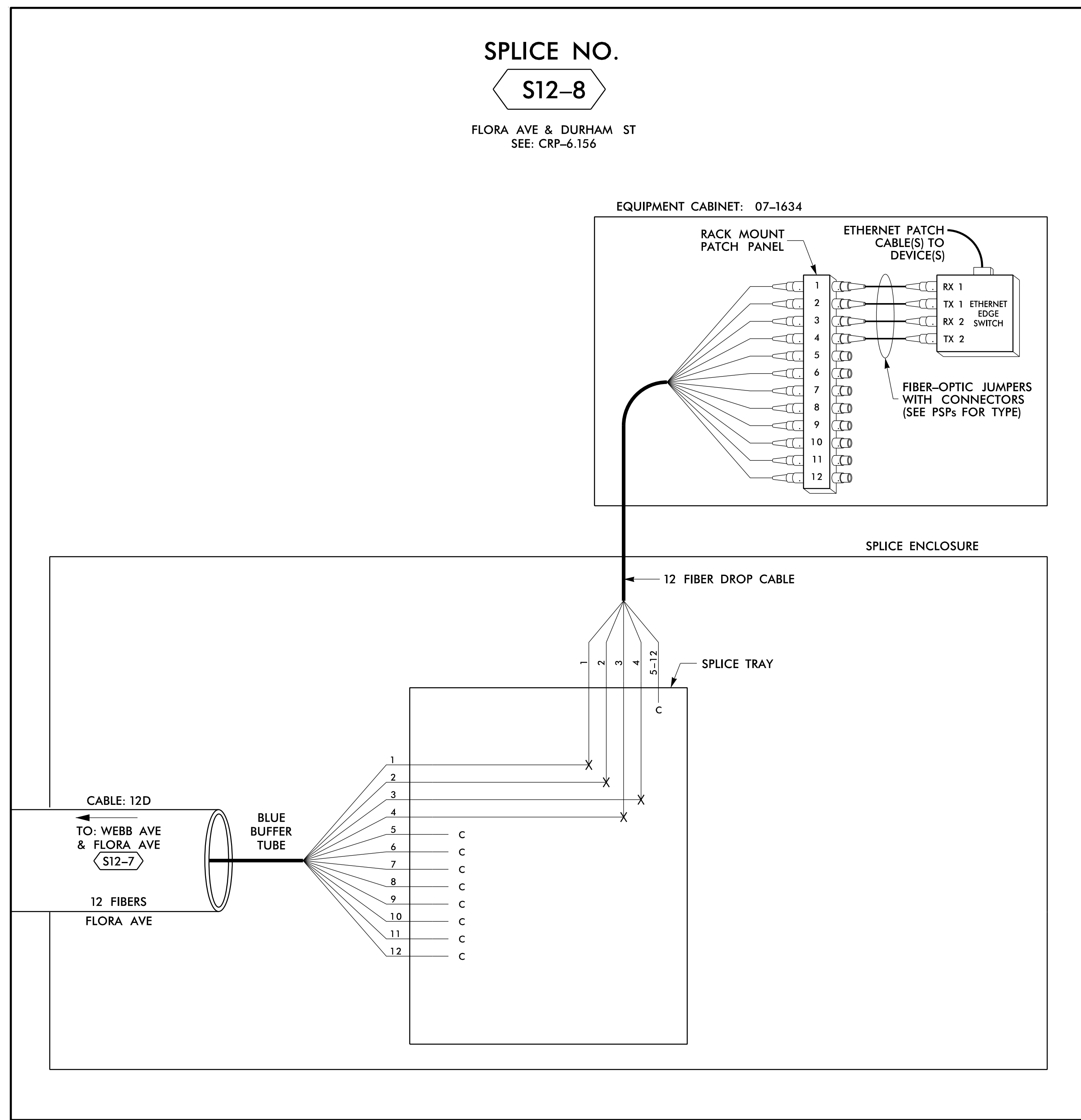

SPLICE NO.

S12-9

WEBB AVE & HAGGARD AVE
SEE: CRP-6.130

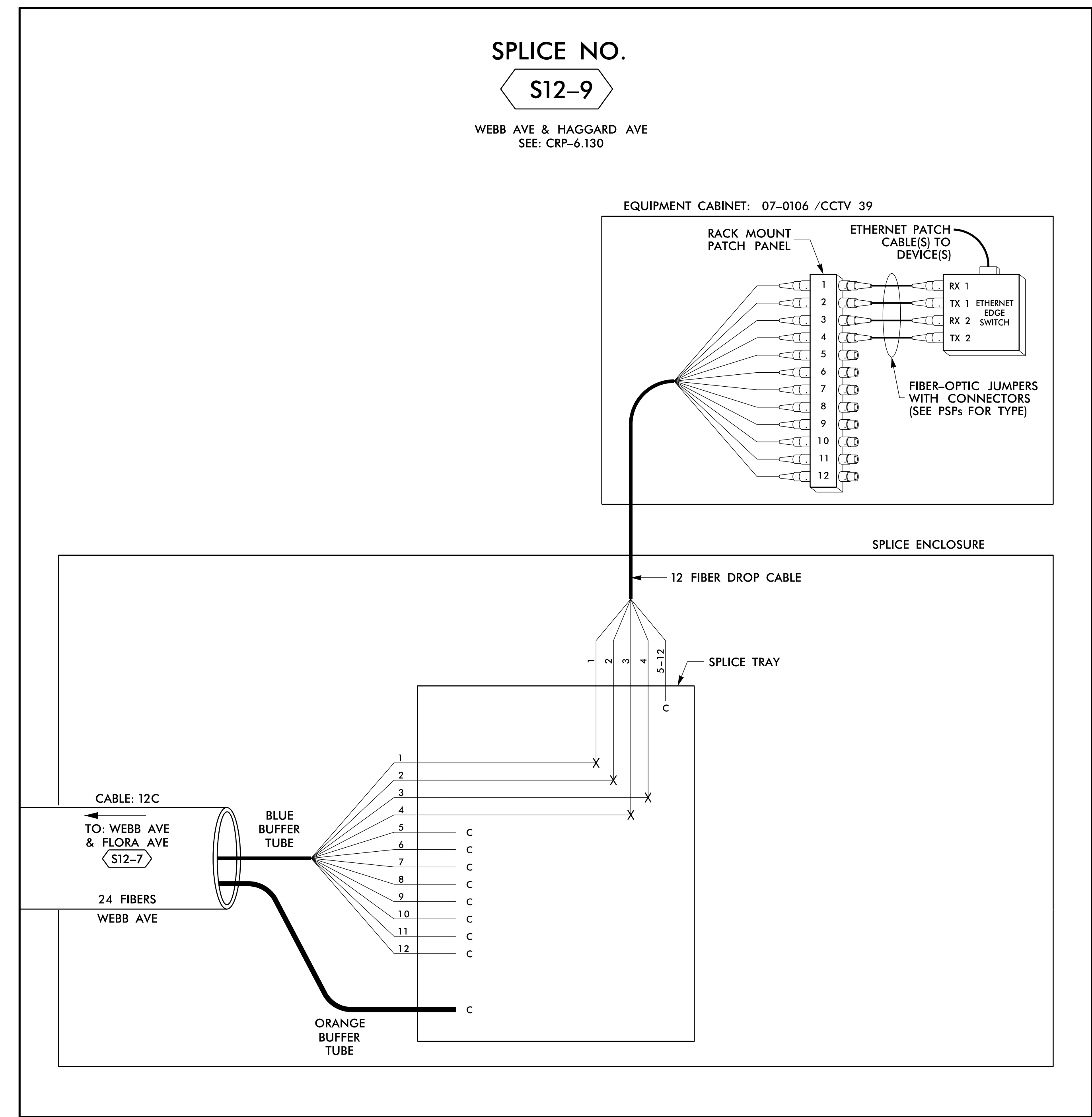

14 JUN 2018 12:29
 D:\projects\proj\11\11_00056469 U-6015 B-C Sig_Sys\Task 11_Coms\Fs 4.078.dgn
 S:\033633 AT_LLUS355433

LEGEND

COLOR CODE TIA/EIA 598-B		X = FUSION SPlice INDIVIDUAL FIBER	C = CAP AND SEAL
(1) BLUE	(7) RED	EXPRESS	EXPRESS ENTIRE BUFFER TUBE /FIBERS THROUGH WITHOUT CUTTING
(2) ORANGE	(8) BLACK	BUFFER SPlice	SPlice ALL FIBERS IN BUFFER TUBE COLOR TO COLOR
(3) GREEN	(9) YELLOW	EXISTING	EXISTING BUFFER TUBE /FIBERS DO NOT MODIFY EXISTING SPlices OR EXPRESSED FIBERS.
(4) BROWN	(10) VIOLET		
(5) SLATE	(11) ROSE		
(6) WHITE	(12) AQUA		

NOTES

1. UNUSED FIBERS LEFT COILED AND STORED IN SPLICE TRAY
2. UNUSED BUFFER TUBES LEFT COILED AND STORED IN SPLICE ENCLOSURE
3. EDGE SWITCH CONFIGURATIONS ARE GENERIC. CONTRACTOR IS RESPONSIBLE FOR DETERMINING/ENSURING THE PROPER TERMINATIONS.

ATKINS 1616 EAST MILLBROOK ROAD, SUITE 160
RALEIGH, NORTH CAROLINA 27609
(919) 876-6888 NCBEEES #F-0326

**DOCUMENT NOT CONSIDERED FINAL
UNLESS ALL SIGNATURES COMPLETED**

<p>750 Greenfield Parkway, Garner, NC 27529</p>	<p>Burlington-Graham Signal System Fiber-Optic Splicing Details</p>		
	<p>Division 7 Alamance County Burlington & Graham</p>		
SCALE N/A	PLAN DATE: June 2018 PREPARED BY: BJ SLOCUM	REVIEWED BY: HA BADGETT REVIEWED BY: DL JONES	SEAL NORTH CAROLINA PROFESSIONAL ENGINEER BRADFORD J. SLOCUM 040877 15/2018

SPLICE NO.

S13-1

FRONT ST & TARLETON AVE
SEE: CRP-6.137

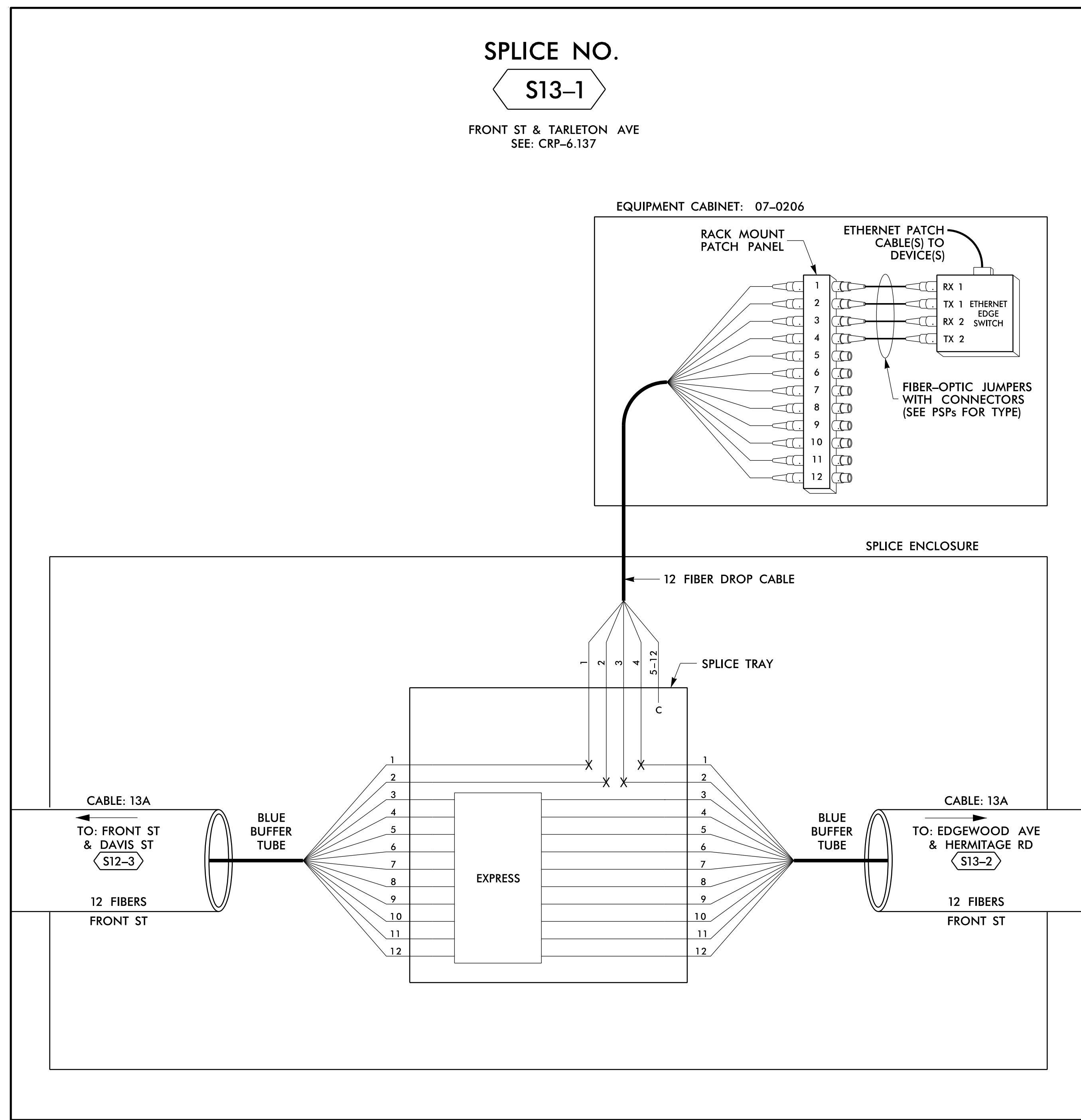

LEGEND

COLOR CODE TIA/EIA 598-B		X = FUSION SPlice INDIVIDUAL FIBER	
(1) BLUE	(7) RED	EXPRESS	EXPRESS ENTIRE BUFFER TUBE / FIBERS THROUGH WITHOUT CUTTING
(2) ORANGE	(8) BLACK	BUFFER SPlice	SPlice ALL FIBERS IN BUFFER TUBE COLOR TO COLOR
(3) GREEN	(9) YELLOW	EXISTING	EXISTING BUFFER TUBE / FIBERS DO NOT MODIFY EXISTING SPlices OR EXPRESSED FIBERS.
(4) BROWN	(10) VIOLET		
(5) SLATE	(11) ROSE		
(6) WHITE	(12) AQUA		

NOTES

1. UNUSED FIBERS LEFT COILED AND STORED IN SPLICE TRAY
2. UNUSED BUFFER TUBES LEFT COILED AND STORED IN SPLICE ENCLOSURE
3. EDGE SWITCH CONFIGURATIONS ARE GENERIC. CONTRACTOR IS RESPONSIBLE FOR DETERMINING/ENSURING THE PROPER TERMINATIONS.

ATKINS 1616 EAST MILLBROOK ROAD, SUITE 160
RALEIGH, NORTH CAROLINA 27609
(919) 876-6888 NCBEE# F-0326

DOCUMENT NOT CONSIDERED FINAL
UNLESS ALL SIGNATURES COMPLETED

<p>Prepared for the Offices of: DEPARTMENT OF TRANSPORTATION Division 7</p>	<p>Burlington-Graham Signal System Fiber-Optic Splicing Details</p>											
	<p>Division 7 Alamance County Burlington & Graham</p>	<p>PLAN DATE: June 2018 REVIEWED BY: HA BADGETT</p>										
<p>750 Greenfield Parkway, Garner, NC 27529</p>	<p>PREPARED BY: BJ SLOCUM</p>	<p>REVIEWED BY: DL JONES</p>	<p>SCALE: N/A</p>									
<table border="1"> <thead> <tr> <th>REVISIONS</th> <th>INIT.</th> <th>DATE</th> </tr> </thead> <tbody> <tr> <td> </td> <td> </td> <td> </td> </tr> <tr> <td> </td> <td> </td> <td> </td> </tr> </tbody> </table>		REVISIONS	INIT.	DATE							<p>DATE: 11/15/2018</p>	
REVISIONS	INIT.	DATE										

14 JUN 2018 12:29
 D:\Technical\Projects\U-6015 B-C Sig. Sys\Task 11_Comms\F5 4.079.dgn
 S:\DCS\653 AT_LUS355433

SPLICE NO.
S13-2

EDGEWOOD AVE & HERMITAGE RD
 SEE: CRP-6.151

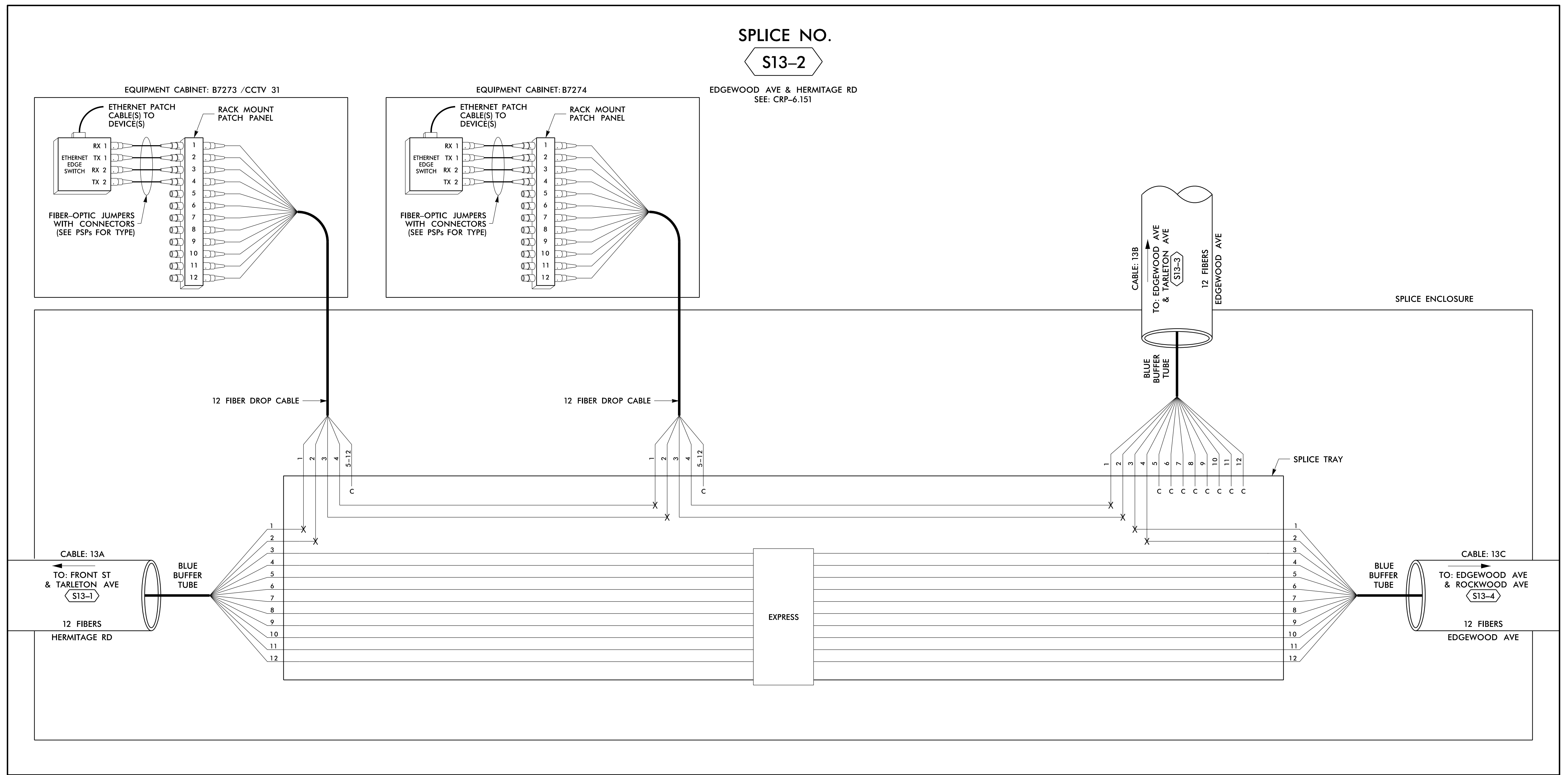

LEGEND

COLOR CODE TIA/EIA 598-B		X = FUSION SPLICE INDIVIDUAL FIBER C = CAP AND SEAL
(1) BLUE	(7) RED	EXPRESS
(2) ORANGE	(8) BLACK	BUFFER SPLICE
(3) GREEN	(9) YELLOW	EXISTING
(4) BROWN	(10) VIOLET	
(5) SLATE	(11) ROSE	
(6) WHITE	(12) AQUA	

NOTES

- UNUSED FIBERS LEFT COILED AND STORED IN SPLICE TRAY
- UNUSED BUFFER TUBES LEFT COILED AND STORED IN SPLICE ENCLOSURE
- EDGE SWITCH CONFIGURATIONS ARE GENERIC. CONTRACTOR IS RESPONSIBLE FOR DETERMINING/ENSURING THE PROPER TERMINATIONS.

ATKINS 1616 EAST MILLBROOK ROAD, SUITE 160
 RALEIGH, NORTH CAROLINA 27609
 (919) 876-6888 NCBES #F-0326

**DOCUMENT NOT CONSIDERED FINAL
 UNLESS ALL SIGNATURES COMPLETED**

Prepared for the Offices of: 750 Greenfield Parkway, Garner, NC 27529	Burlington-Graham Signal System Fiber-Optic Splicing Details		SEAL NORTH CAROLINA PROFESSIONAL SEAL 040877 ENGINEER Bradford J. Slocum 15/2018
	Division 7 Alamance County PLAN DATE: June 2018 PREPARED BY: BJ SLOCUM	Burlington & Graham REVIEWED BY: HA BADGETT REVIEWED BY: DL JONES	

14 JUN 2018 12:29
 D:\Technical\Projects\U-6015 B-C Sig Sys\Task 11_Comms\F5 4.080.dgn
 S:\DCS\653 AT_LUS355433

SPLICE NO.

S13-3

EDGEWOOD AVE & TARLETON AVE
SEE: CRP-6.153

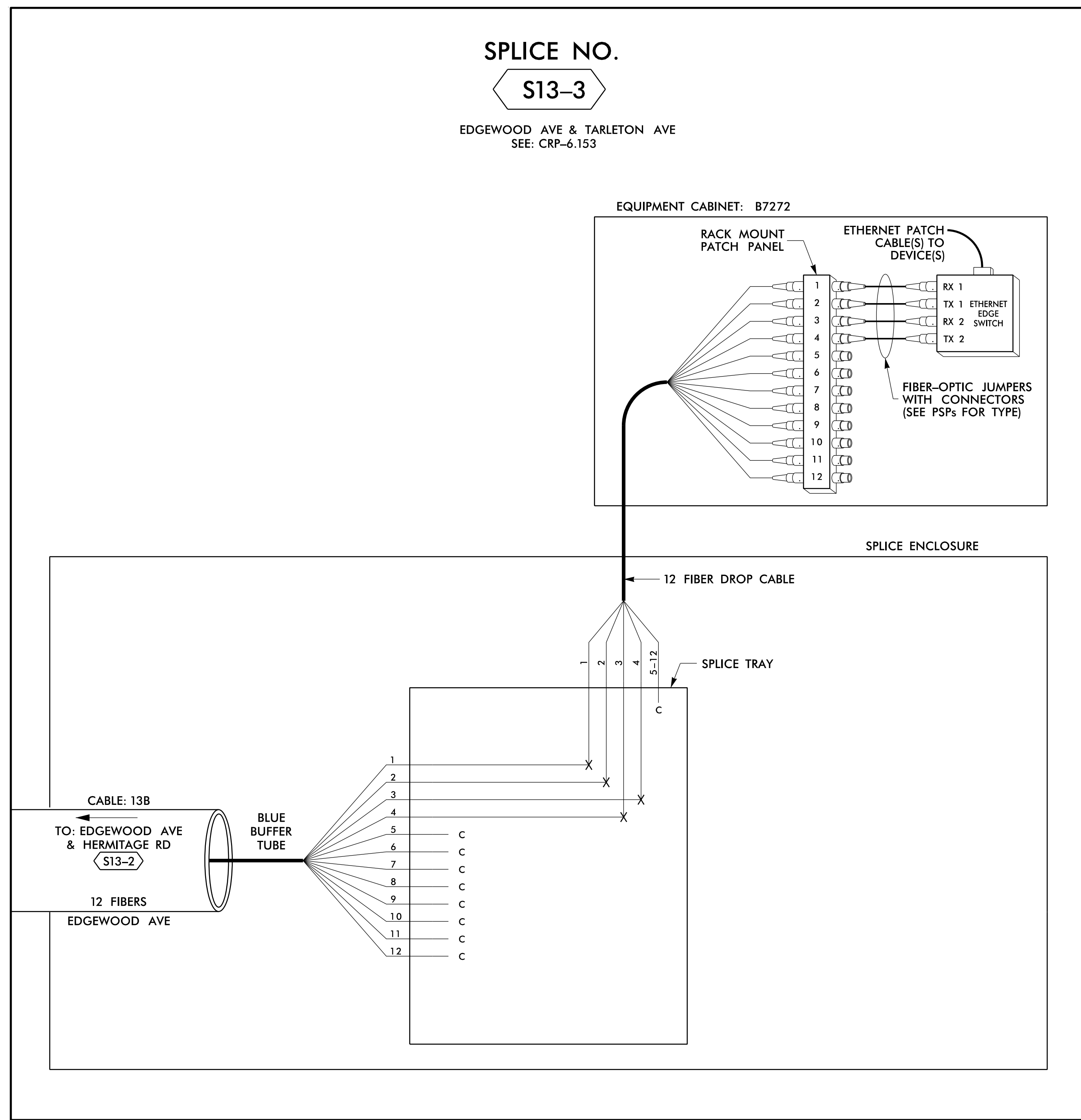

14 JUN 2018 12:29
 D:\Technical\Projects\U-6015 B-C Sig. Sys\Task 11_Comms\F5 4.081.dgn
 S:\DCS\653 AT_LUS355433

LEGEND

COLOR CODE TIA/EIA 598-B		X = FUSION SPlice INDIVIDUAL FIBER C = CAP AND SEAL
(1) BLUE	(7) RED	EXPRESS
(2) ORANGE	(8) BLACK	EXPRESS ENTIRE BUFFER TUBE / FIBERS THROUGH WITHOUT CUTTING
(3) GREEN	(9) YELLOW	BUFFER SPlice
(4) BROWN	(10) VIOLET	SPlice ALL FIBERS IN BUFFER TUBE COLOR TO COLOR
(5) SLATE	(11) ROSE	EXISTING
(6) WHITE	(12) AQUA	EXISTING BUFFER TUBE / FIBERS DO NOT MODIFY EXISTING SPlices OR EXPRESSED FIBERS.

NOTES

- UNUSED FIBERS LEFT COILED AND STORED IN SPLICE TRAY
- UNUSED BUFFER TUBES LEFT COILED AND STORED IN SPLICE ENCLOSURE
- EDGE SWITCH CONFIGURATIONS ARE GENERIC. CONTRACTOR IS RESPONSIBLE FOR DETERMINING/ENSURING THE PROPER TERMINATIONS.

ATKINS 1616 EAST MILLBROOK ROAD, SUITE 160
RALEIGH, NORTH CAROLINA 27609
(919) 876-6888 NCBEEES #F-0326

DOCUMENT NOT CONSIDERED FINAL UNLESS ALL SIGNATURES COMPLETED

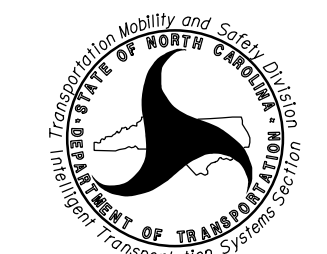
Prepared for the Offices of:  750 Greenfield Parkway, Garner, NC 27529	Burlington-Graham Signal System Fiber-Optic Splicing Details		SEAL NORTH CAROLINA PROFESSIONAL ENGINEER SEAL 040877 BRADFORD J. SLOCUM 15/2018 DATE
	Division 7 Alamance County Burlington & Graham	PLAN DATE: June 2018 PREPARED BY: BJ SLOCUM	
SCALE N/A	REVISIONS INIT. DATE		CAD0 File name: FS 4.081.dgn

SPLICE NO.

S13-4

EDGEWOOD AVE & ROCKWOOD AVE
SEE: CRP-6.150

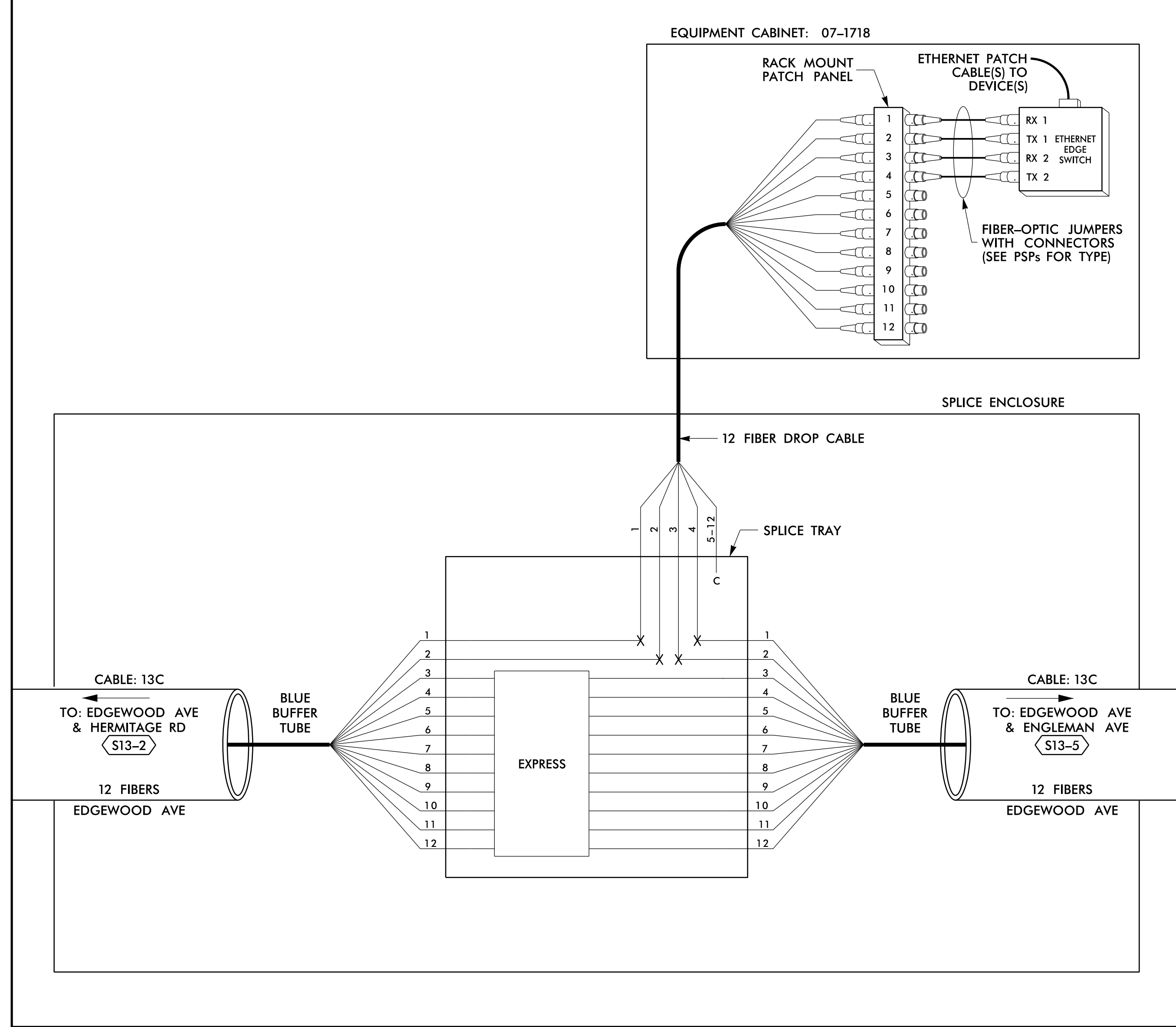

SPLICE NO.

S13-5

EDGEWOOD AVE & ENGLEMAN AVE
SEE: CRP-6.149

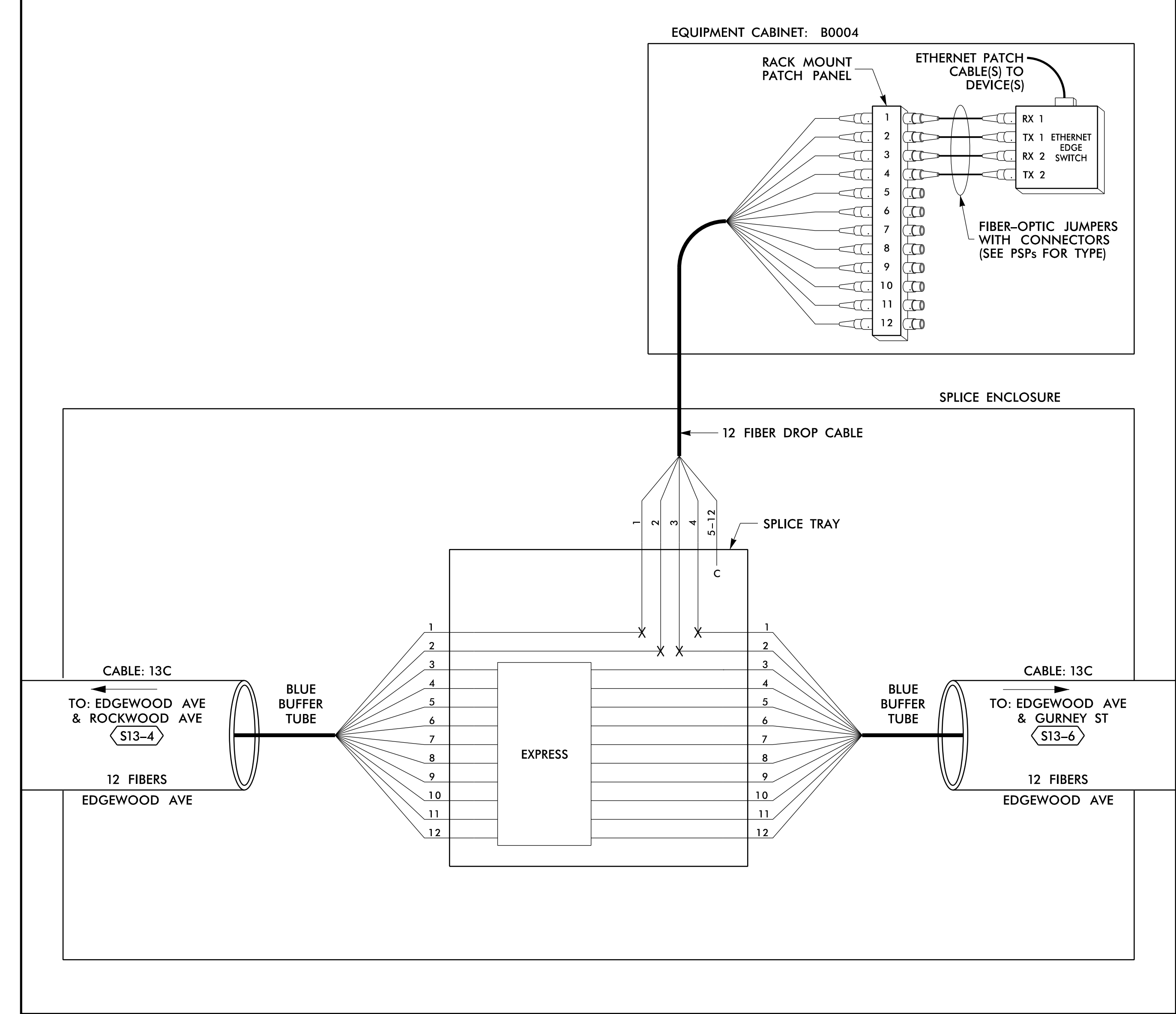

14 JUN 2018 12:29
 D:\projects\proj\11\11_00056469_U-6015_B-C_Sig_Sys\Task_11_Corrs\F_S 4.082.dgn
 S:\033633 AT_LUS355433

LEGEND

COLOR CODE		TIA/EIA 598-B	
(1) BLUE	(7) RED	EXPRESS	EXPRESS ENTIRE BUFFER TUBE / FIBERS THROUGH WITHOUT CUTTING
(2) ORANGE	(8) BLACK	BUFFER SPLICE	SPLICE ALL FIBERS IN BUFFER TUBE COLOR TO COLOR
(3) GREEN	(9) YELLOW	EXISTING	EXISTING BUFFER TUBE / FIBERS DO NOT MODIFY EXISTING SPLICES OR EXPRESSED FIBERS.
(4) BROWN	(10) VIOLET		
(5) SLATE	(11) ROSE		
(6) WHITE	(12) AQUA		

NOTES

1. UNUSED FIBERS LEFT COILED AND STORED IN SPLICE TRAY
2. UNUSED BUFFER TUBES LEFT COILED AND STORED IN SPLICE ENCLOSURE
3. EDGE SWITCH CONFIGURATIONS ARE GENERIC. CONTRACTOR IS RESPONSIBLE FOR DETERMINING/ENSURING THE PROPER TERMINATIONS.

ATKINS 1616 EAST MILLBROOK ROAD, SUITE 160
RALEIGH, NORTH CAROLINA 27609
(919) 876-6888 NCBES #F-0326

DOCUMENT NOT CONSIDERED FINAL UNLESS ALL SIGNATURES COMPLETED

<p>750 Greenfield Parkway, Garner, NC 27529</p>	<p>Burlington-Graham Signal System Fiber-Optic Splicing Details</p>		
	<p>Division 7 Alamance County</p>	<p>Burlington & Graham</p>	
<p>SCALE: N/A</p>	<p>PLAN DATE: June 2018</p>	<p>REVIEWED BY: HA BADGETT</p>	<p>DATE: 6/15/2018</p>
<p>PREPARED BY: BJ SLOCUM</p>	<p>REVISIONS</p>	<p>REVIEWED BY: DL JONES</p>	<p>DATE</p>

SPLICE NO.

S13-6

EDGEWOOD AVE & GURNEY ST
SEE: CRP-6.148

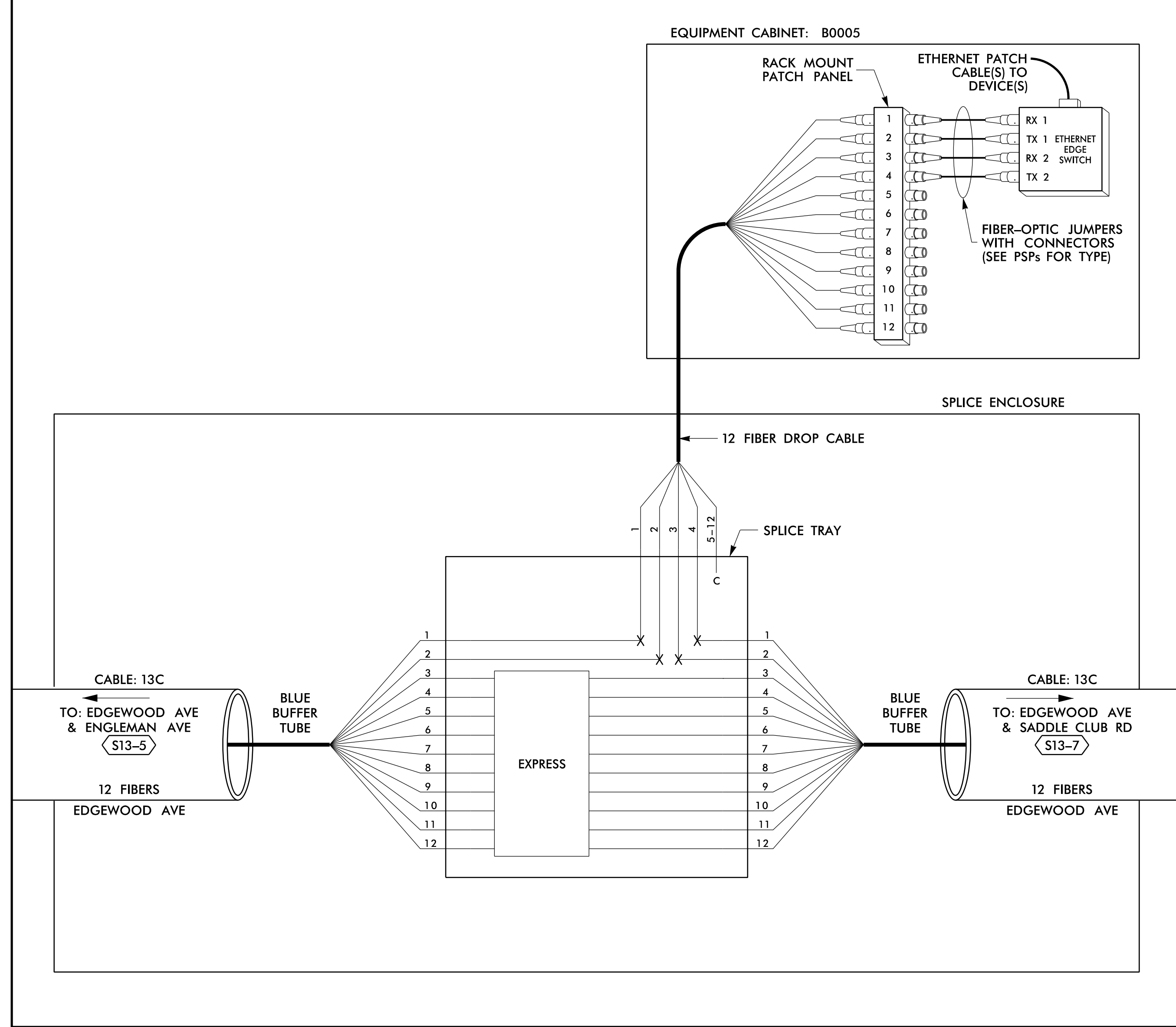

SPLICE NO.

S13-7

EDGEWOOD AVE & SADDLE CLUB RD
SEE: CRP-6.147

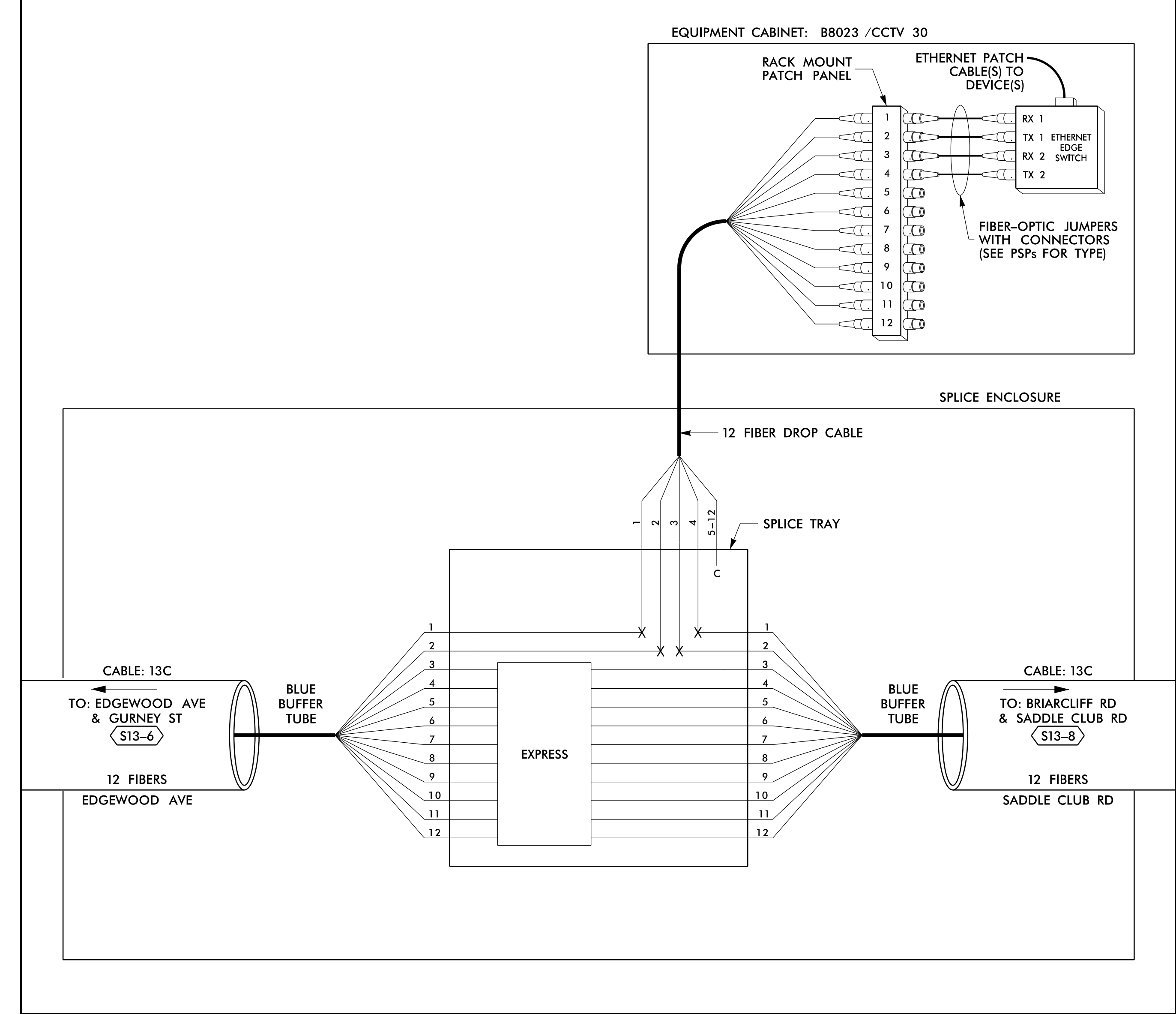

14 JUN 2018 12:30
 D:\projects\proj\11\comms\11\comms\F S 4.083.dgn
 S:\033633 AT LUS355433

LEGEND

COLOR CODE TIA/EIA 598-B		X = FUSION SPlice INDIVIDUAL FIBER	EXPRESS	EXPRESS ENTIRE BUFFER TUBE /FIBERS THROUGH WITHOUT CUTTING
(1) BLUE	(7) RED	C = CAP AND SEAL	BUFFER SPlice	SPlice ALL FIBERS IN BUFFER TUBE COLOR TO COLOR
(2) ORANGE	(8) BLACK		EXISTING	EXISTING BUFFER TUBE /FIBERS DO NOT MODIFY EXISTING SPlices OR EXPRESSED FIBERS.
(3) GREEN	(9) YELLOW			
(4) BROWN	(10) VIOLET			
(5) SLATE	(11) ROSE			
(6) WHITE	(12) AQUA			

NOTES

- UNUSED FIBERS LEFT COILED AND STORED IN SPLICE TRAY
- UNUSED BUFFER TUBES LEFT COILED AND STORED IN SPLICE ENCLOSURE
- EDGE SWITCH CONFIGURATIONS ARE GENERIC. CONTRACTOR IS RESPONSIBLE FOR DETERMINING/ENSURING THE PROPER TERMINATIONS.

ATKINS 1616 EAST MILLBROOK ROAD, SUITE 160
RALEIGH, NORTH CAROLINA 27609
(919) 876-6888 NCBES #F-0326

DOCUMENT NOT CONSIDERED FINAL UNLESS ALL SIGNATURES COMPLETED

<p>750 Greenfield Parkway, Garner, NC 27529</p>	<p>Burlington-Graham Signal System Fiber-Optic Splicing Details</p>		
	<p>Division 7 Alamance County</p>	<p>Burlington & Graham</p>	
<p>SCALE: N/A</p>	<p>PLAN DATE: June 2018</p>	<p>REVIEWED BY: HA BADGETT</p>	<p>DATE: 6/15/2018</p>
<p>PREPARED BY: BJ SLOCUM</p>	<p>REVIEWED BY: DL JONES</p>	<p>DATE: 6/15/2018</p>	<p>DATE: 6/15/2018</p>
<p>REVISIONS</p>	<p>INIT.</p>	<p>DATE</p>	<p>DATE</p>

SPLICE NO.

S13-8

BRIARCLIFF RD & SADDLE CLUB RD
SEE: CRP-6.146

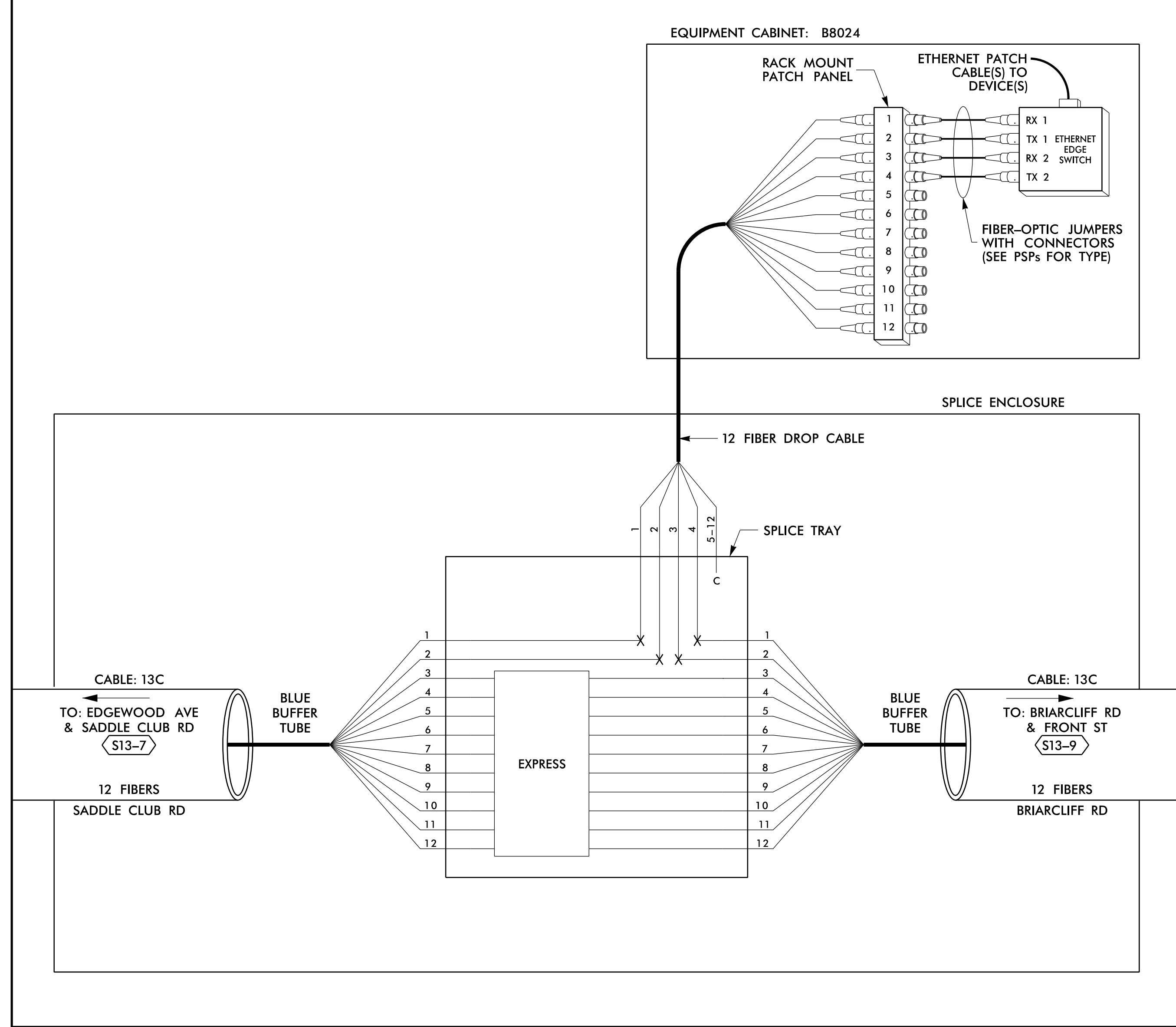

SPLICE NO.

S13-9

BRIARCLIFF RD & FRONT ST
SEE: CRP-6.145

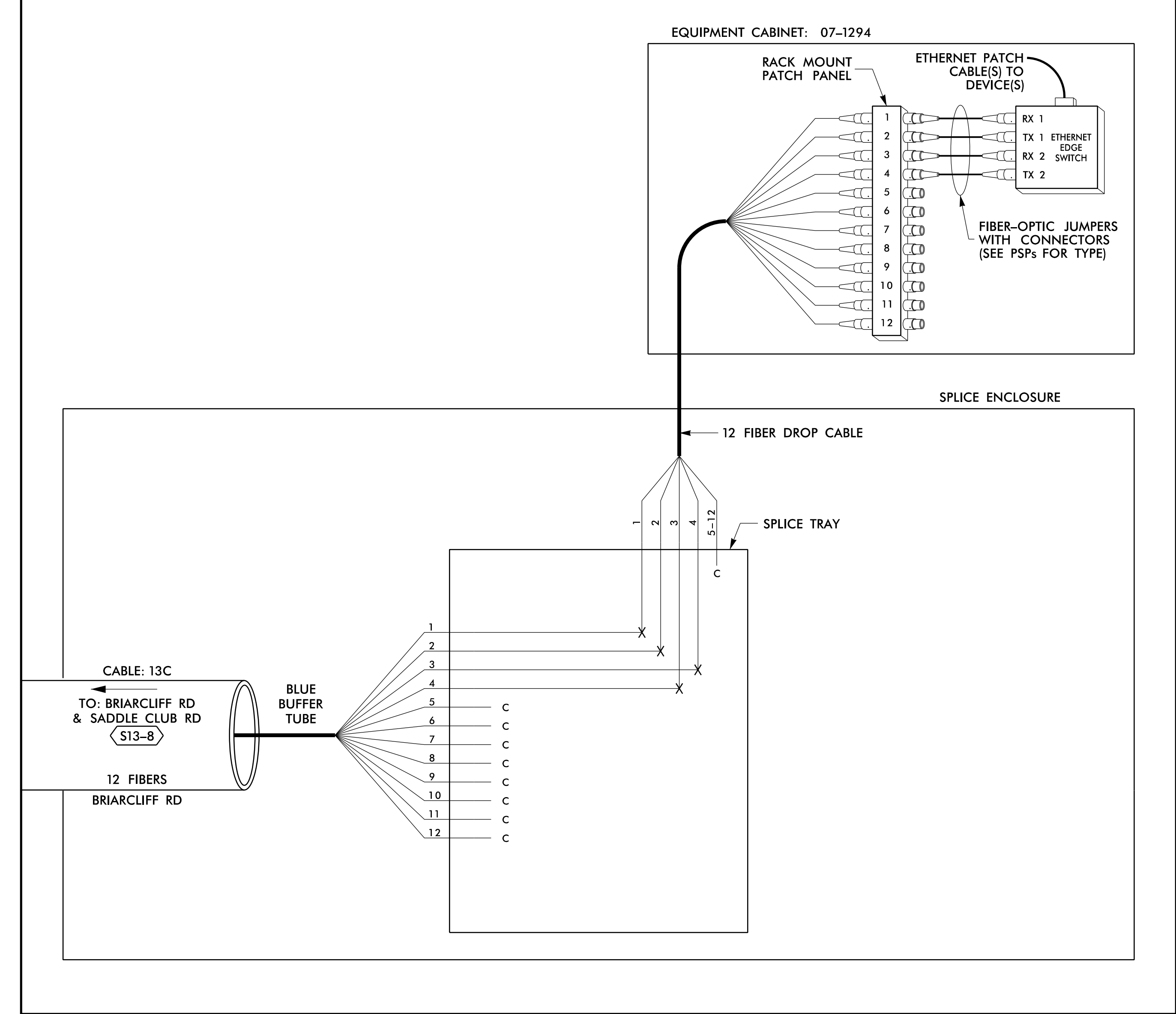

LEGEND

COLOR CODE TIA/EIA 598-B		X = FUSION SPLICE INDIVIDUAL FIBER	
(1) BLUE	(7) RED	EXPRESS	EXPRESS ENTIRE BUFFER TUBE / FIBERS THROUGH WITHOUT CUTTING
(2) ORANGE	(8) BLACK	BUFFER SPLICE	SPLICE ALL FIBERS IN BUFFER TUBE COLOR TO COLOR
(3) GREEN	(9) YELLOW	EXISTING	EXISTING BUFFER TUBE / FIBERS DO NOT MODIFY EXISTING SPLICES OR EXPRESSED FIBERS.
(4) BROWN	(10) VIOLET		
(5) SLATE	(11) ROSE		
(6) WHITE	(12) AQUA		

NOTES

1. UNUSED FIBERS LEFT COILED AND STORED IN SPLICE TRAY
2. UNUSED BUFFER TUBES LEFT COILED AND STORED IN SPLICE ENCLOSURE
3. EDGE SWITCH CONFIGURATIONS ARE GENERIC. CONTRACTOR IS RESPONSIBLE FOR DETERMINING/ENSURING THE PROPER TERMINATIONS.

ATKINS 1616 EAST MILLBROOK ROAD, SUITE 160
RALEIGH, NORTH CAROLINA 27609
(919) 876-6888 NCBES #F-0326

**DOCUMENT NOT CONSIDERED FINAL
UNLESS ALL SIGNATURES COMPLETED**

<p>750 Greenfield Parkway, Garner, NC 27529</p>	<p>Burlington-Graham Signal System Fiber-Optic Splicing Details</p>		
	<p>Division 7 Alamance County</p>	<p>Burlington & Graham</p>	
<p>SCALE: N/A</p>	<p>PLAN DATE: June 2018</p>	<p>REVIEWED BY: HA BADGETT</p>	<p>DATE: 15/2018</p>
<p>PREPARED BY: BJ SLOCUM</p>	<p>REVIEWED BY: DL JONES</p>	<p>DATE: 15/2018</p>	<p>DATE: 15/2018</p>

14-JUN-2018 12:30
 D:\projects\proj\100056469 U-6015 B-C Sig_Sys\Task 11_Comms\F S 4.084.dgn
 S:\DCS\653 AT_LUS355433

SPLICE NO.

S14-1

CHURCH ST & GLENWOOD AVE
SEE: CRP-6.022

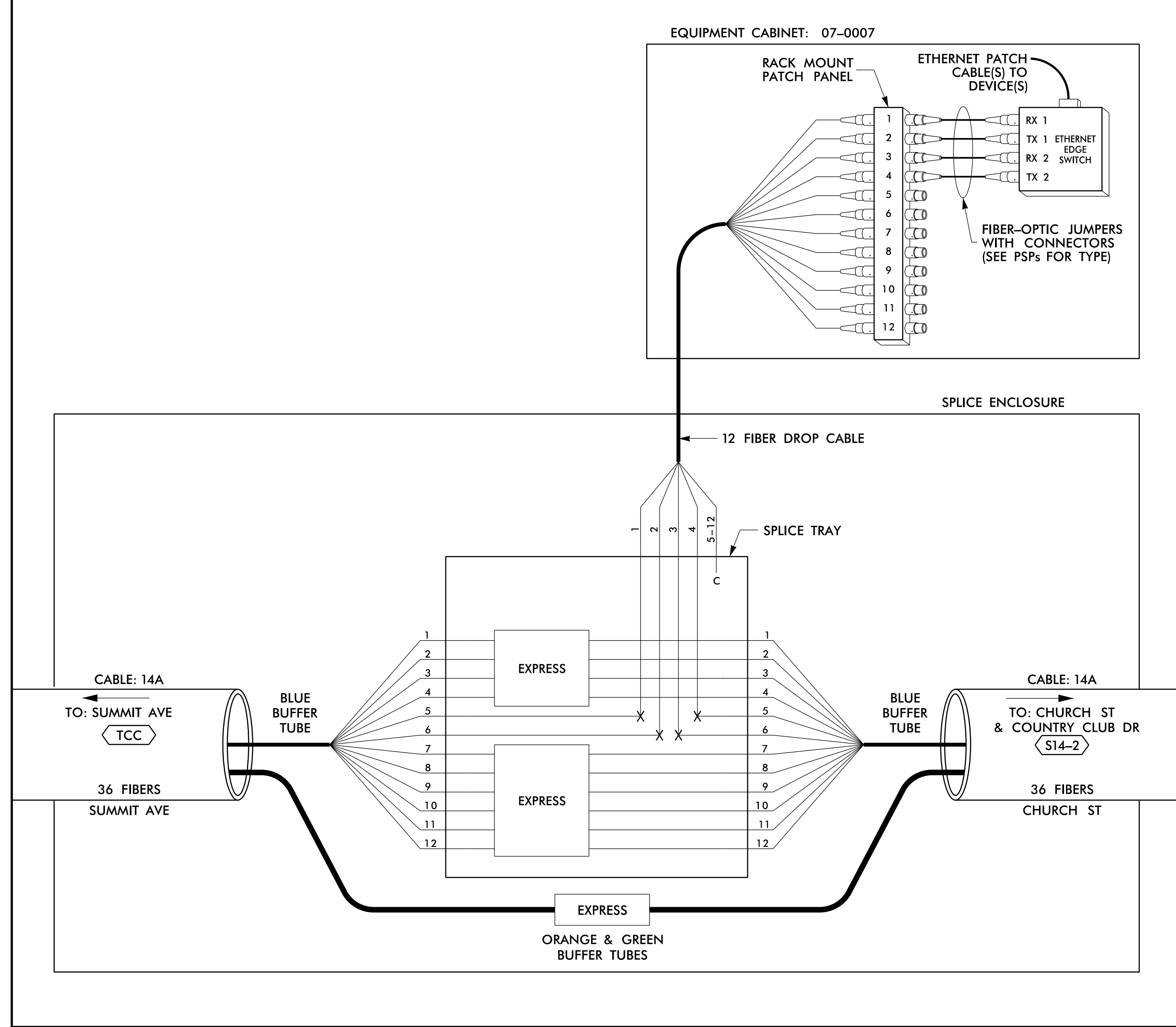

SPLICE NO.

S14-2

CHURCH ST & COUNTRY CLUB DR
SEE: CRP-6.021

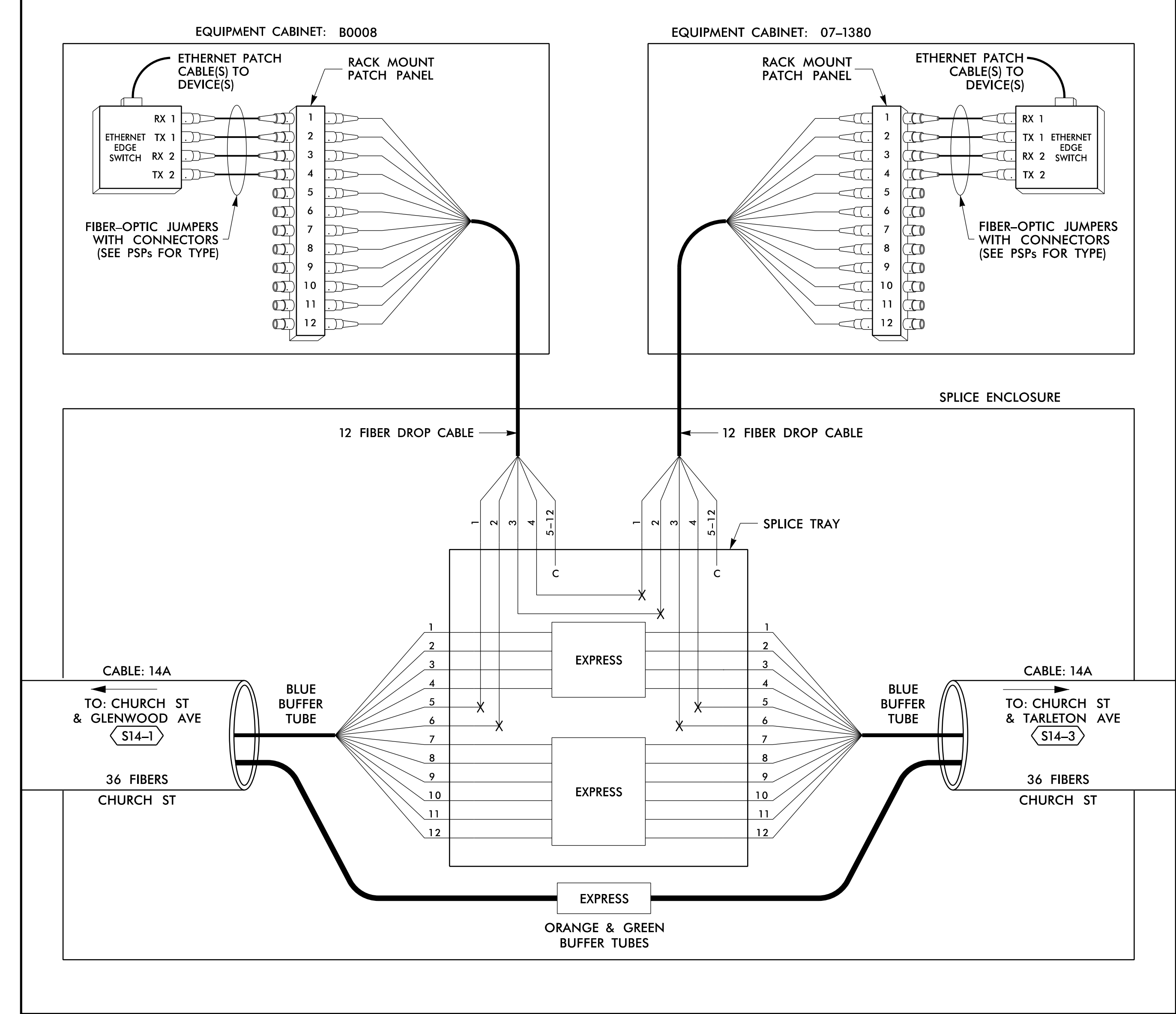

14 JUN 2018 12:30
 D:\Technical\proj\100056469 U-6015 B-C Sig Sys\Task 11_Comm\Fs 4.085.dgn
 S:\DCS\653 AT_LUS355433

LEGEND

COLOR CODE TIA/EIA 598-B		X = FUSION SPLICE INDIVIDUAL FIBER	
(1) BLUE	(7) RED	EXPRESS	EXPRESS ENTIRE BUFFER TUBE / FIBERS THROUGH WITHOUT CUTTING
(2) ORANGE	(8) BLACK	BUFFER SPLICE	SPLICE ALL FIBERS IN BUFFER TUBE COLOR TO COLOR
(3) GREEN	(9) YELLOW	EXISTING	EXISTING BUFFER TUBE / FIBERS DO NOT MODIFY EXISTING SPLICES OR EXPRESSED FIBERS.
(4) BROWN	(10) VIOLET		
(5) SLATE	(11) ROSE		
(6) WHITE	(12) AQUA		

NOTES

- UNUSED FIBERS LEFT COILED AND STORED IN SPLICE TRAY
- UNUSED BUFFER TUBES LEFT COILED AND STORED IN SPLICE ENCLOSURE
- EDGE SWITCH CONFIGURATIONS ARE GENERIC. CONTRACTOR IS RESPONSIBLE FOR DETERMINING/ENSURING THE PROPER TERMINATIONS.

ATKINS 1616 EAST MILLBROOK ROAD, SUITE 160
RALEIGH, NORTH CAROLINA 27609
(919) 876-6888 NCBEES #F-0326

DOCUMENT NOT CONSIDERED FINAL UNLESS ALL SIGNATURES COMPLETED

<p>750 Greenfield Parkway, Garner, NC 27529</p>	<p>Burlington-Graham Signal System Fiber-Optic Splicing Details</p>							
	<p>Division 7 Alamance County</p>	<p>Burlington & Graham</p>						
	<p>PLAN DATE: June 2018</p>	<p>REVIEWED BY: HA BADGETT</p>						
	<p>PREPARED BY: BJ SLOCUM</p>	<p>REVIEWED BY: DL JONES</p>						
<p>SCALE: N/A</p>	<table border="1"> <thead> <tr> <th>REVISIONS</th> <th>INIT.</th> <th>DATE</th> </tr> </thead> <tbody> <tr> <td> </td> <td> </td> <td> </td> </tr> </tbody> </table>	REVISIONS	INIT.	DATE				<p>DATE: 6/15/2018</p>
REVISIONS	INIT.	DATE						

SPLICE NO.

S14-3

CHURCH ST & TARLETON AVE
SEE: CRP-6.020

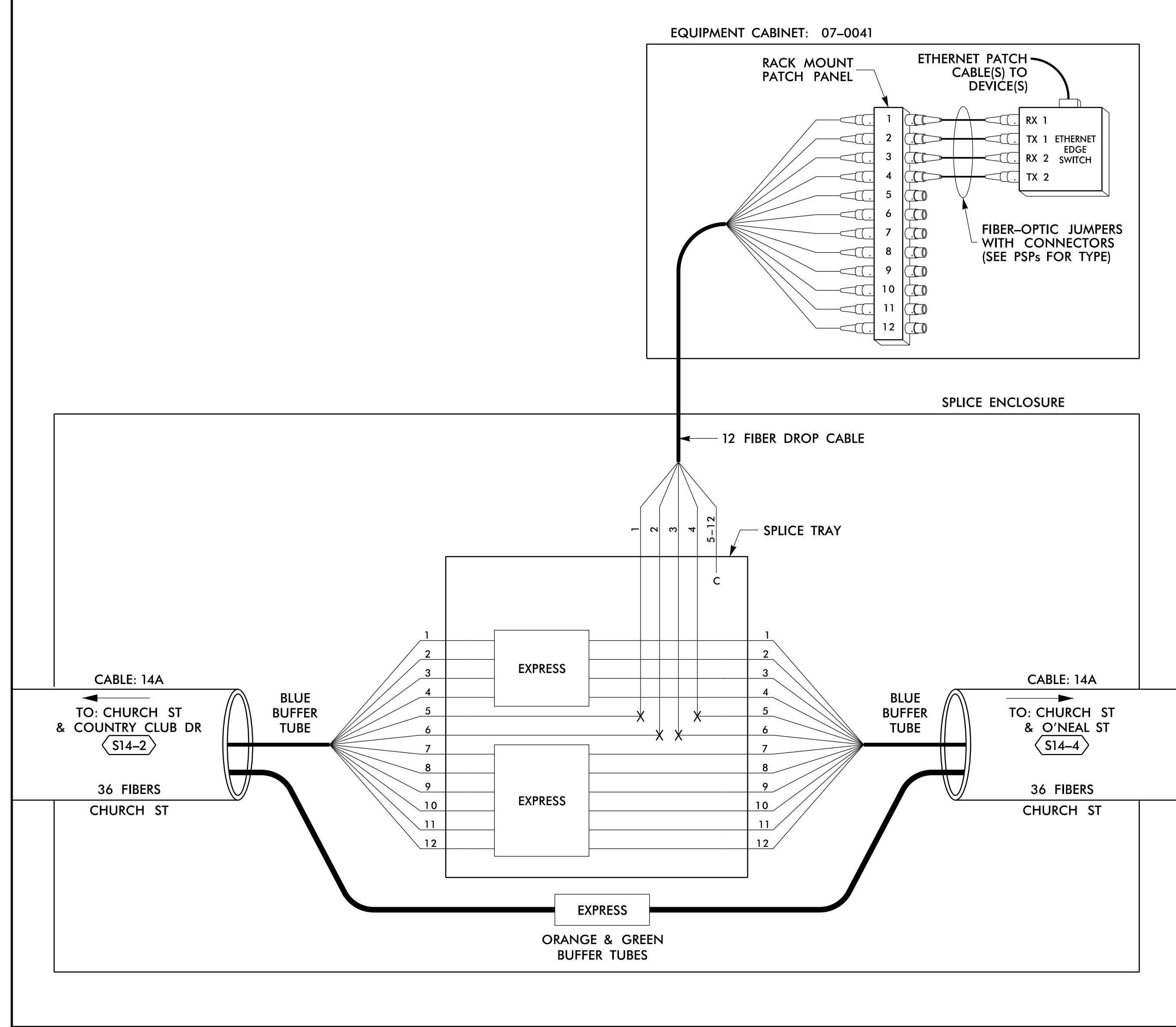

SPLICE NO.

S14-4

CHURCH ST & O'NEAL ST
SEE: CRP-6.019

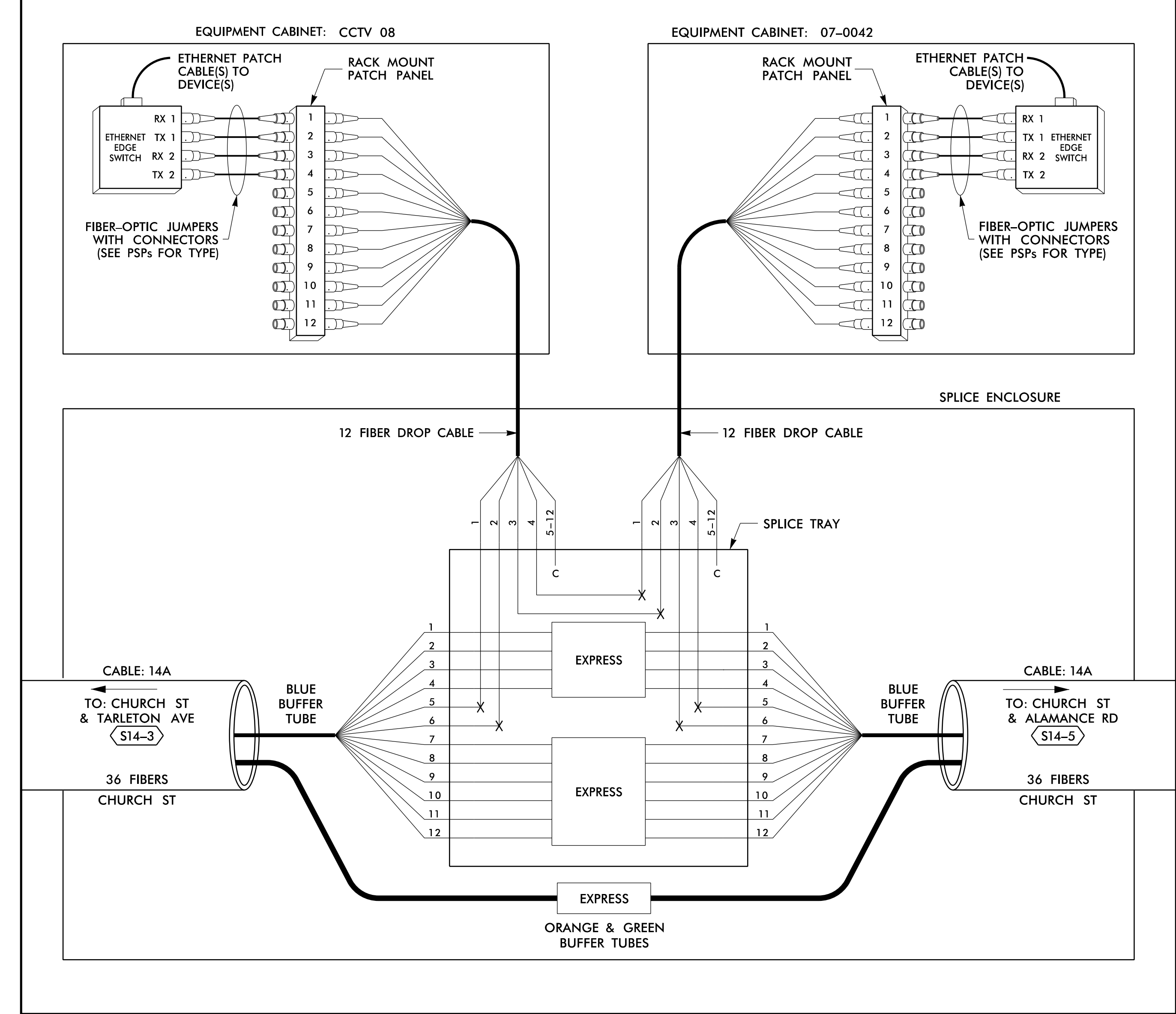

14 JUN 2018 12:30
 D:\projects\proj\100056463 U-6015 B-C Sig Sys\Task 11_Coms\Fs 4.086.dgn
 S:\DCS\653 AT_LUS355433

LEGEND

COLOR CODE TIA/EIA 598-B		X = FUSION SPLICE INDIVIDUAL FIBER	
(1) BLUE	(7) RED	EXPRESS	EXPRESS ENTIRE BUFFER TUBE / FIBERS THROUGH WITHOUT CUTTING
(2) ORANGE	(8) BLACK	BUFFER SPLICE	SPLICE ALL FIBERS IN BUFFER TUBE COLOR TO COLOR
(3) GREEN	(9) YELLOW	EXISTING	EXISTING BUFFER TUBE / FIBERS DO NOT MODIFY EXISTING SPLICES OR EXPRESSED FIBERS.
(4) BROWN	(10) VIOLET		
(5) SLATE	(11) ROSE		
(6) WHITE	(12) AQUA		

NOTES

- UNUSED FIBERS LEFT COILED AND STORED IN SPLICE TRAY
- UNUSED BUFFER TUBES LEFT COILED AND STORED IN SPLICE ENCLOSURE
- EDGE SWITCH CONFIGURATIONS ARE GENERIC. CONTRACTOR IS RESPONSIBLE FOR DETERMINING/ENSURING THE PROPER TERMINATIONS.

ATKINS 1616 EAST MILLBROOK ROAD, SUITE 160
RALEIGH, NORTH CAROLINA 27609
(919) 876-6888 NCBES #F-0326

DOCUMENT NOT CONSIDERED FINAL UNLESS ALL SIGNATURES COMPLETED

	Burlington-Graham Signal System Fiber-Optic Splicing Details		
	Division 7 Alamance County	Burlington & Graham	
PLAN DATE: June 2018	REVIEWED BY: HA BADGETT	PREPARED BY: BJ SLOCUM	REVIEWED BY: DL JONES
SCALE: N/A	REVISIONS	INIT.	DATE

SPLICE NO.

S14-5

CHURCH ST & ALAMANCE RD
SEE: CRP-6.019

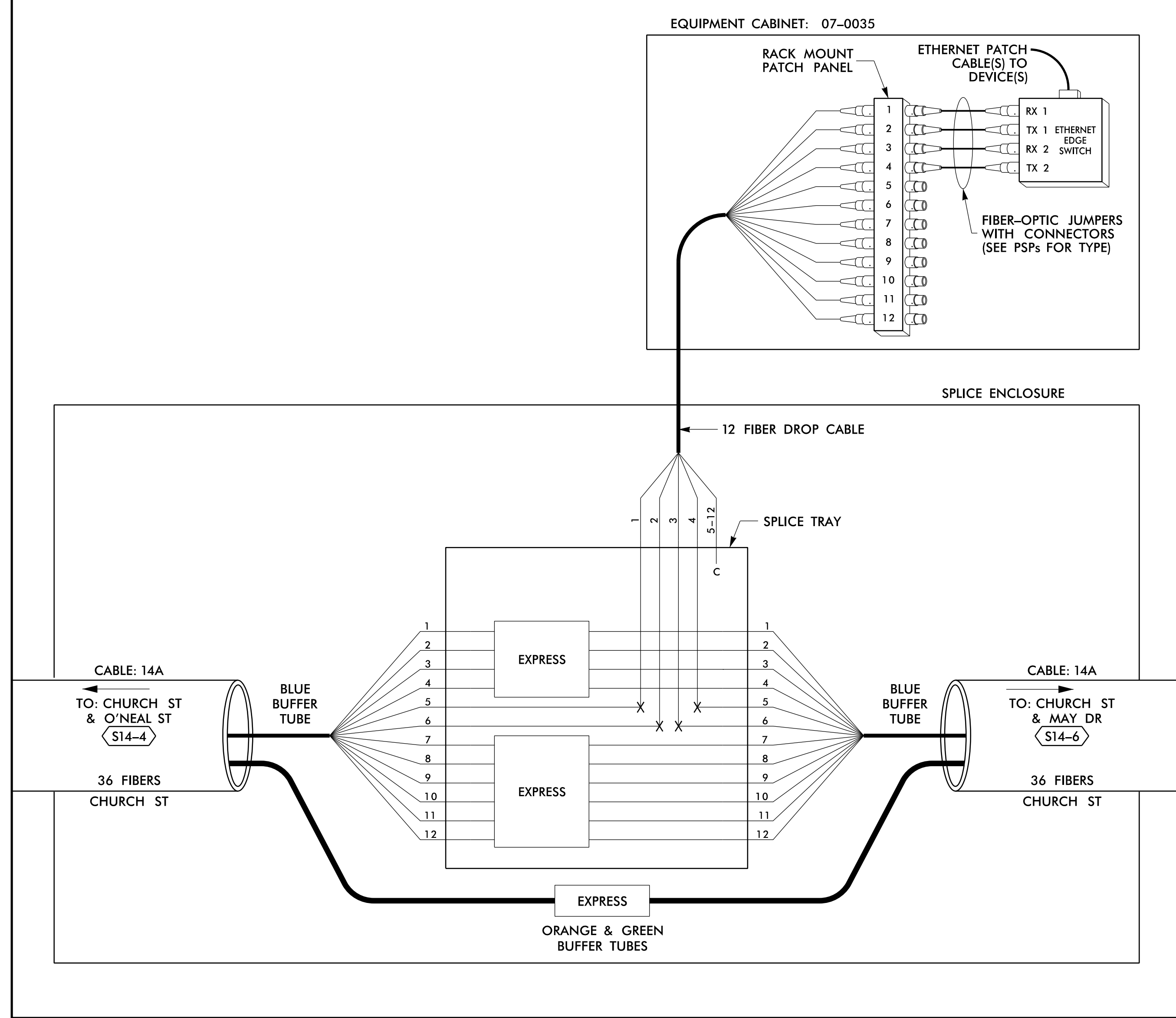

SPLICE NO.

S14-6

CHURCH ST & MAY DR
SEE: CRP-6.017

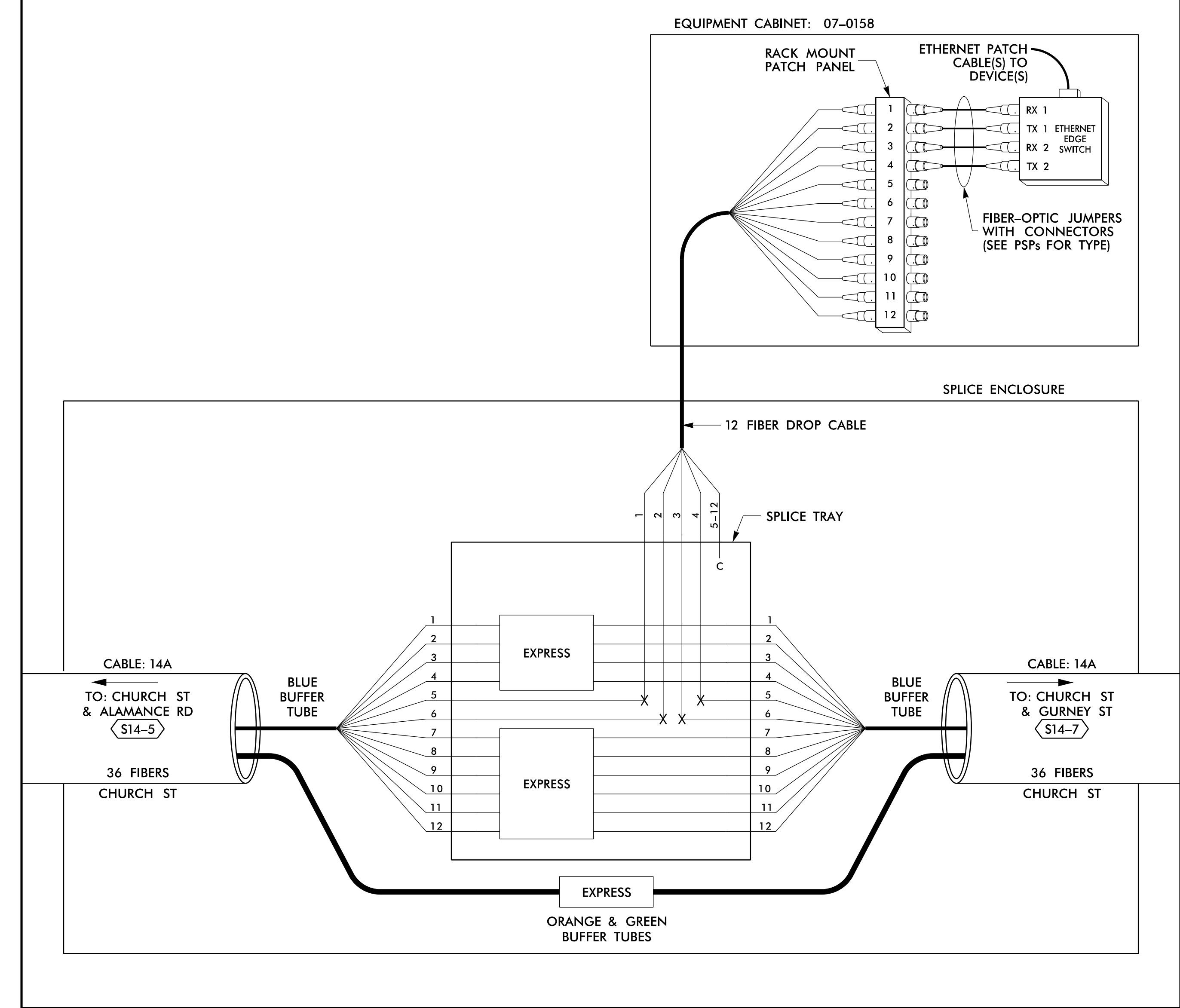

14 JUN 2018 12:30
 D:\projects\proj\100056469 U-6015 B-C Sig Sys\Task 11_Corrs\F S 4.087.dgn
 S:\033653 AT LUS355433

LEGEND

COLOR CODE TIA/EIA 598-B		X = FUSION SPLICE INDIVIDUAL FIBER C = CAP AND SEAL
(1) BLUE	(7) RED	EXPRESS
(2) ORANGE	(8) BLACK	BUFFER SPLICE
(3) GREEN	(9) YELLOW	EXISTING
(4) BROWN	(10) VIOLET	
(5) SLATE	(11) ROSE	
(6) WHITE	(12) AQUA	

EXPRESS ENTIRE BUFFER TUBE / FIBERS THROUGH WITHOUT CUTTING
 SPLICE ALL FIBERS IN BUFFER TUBE COLOR TO COLOR
 EXISTING BUFFER TUBE / FIBERS DO NOT MODIFY EXISTING SPLICES OR EXPRESSED FIBERS.

NOTES

- UNUSED FIBERS LEFT COILED AND STORED IN SPLICE TRAY
- UNUSED BUFFER TUBES LEFT COILED AND STORED IN SPLICE ENCLOSURE
- EDGE SWITCH CONFIGURATIONS ARE GENERIC. CONTRACTOR IS RESPONSIBLE FOR DETERMINING/ENSURING THE PROPER TERMINATIONS.

ATKINS 1616 EAST MILLBROOK ROAD, SUITE 160
 RALEIGH, NORTH CAROLINA 27609
 (919) 876-6888 NCBES #F-0326

DOCUMENT NOT CONSIDERED FINAL UNLESS ALL SIGNATURES COMPLETED

Prepared for the Offices of: 750 Greenfield Parkway, Garner, NC 27529 SCALE: N/A	Burlington-Graham Signal System Fiber-Optic Splicing Details		SEAL NORTH CAROLINA PROFESSIONAL ENGINEER SEAL 040877 BRADFORD J. SLOCUM 15/2018 DATE
	Division 7 Alamance County PLAN DATE: June 2018 PREPARED BY: BJ SLOCUM	Burlington & Graham REVIEWED BY: HA BADGETT REVIEWED BY: DL JONES	
REVISIONS			DATE

SPLICE NO.

S14-7

CHURCH ST & GURNEY ST
SEE: CRP-6.016

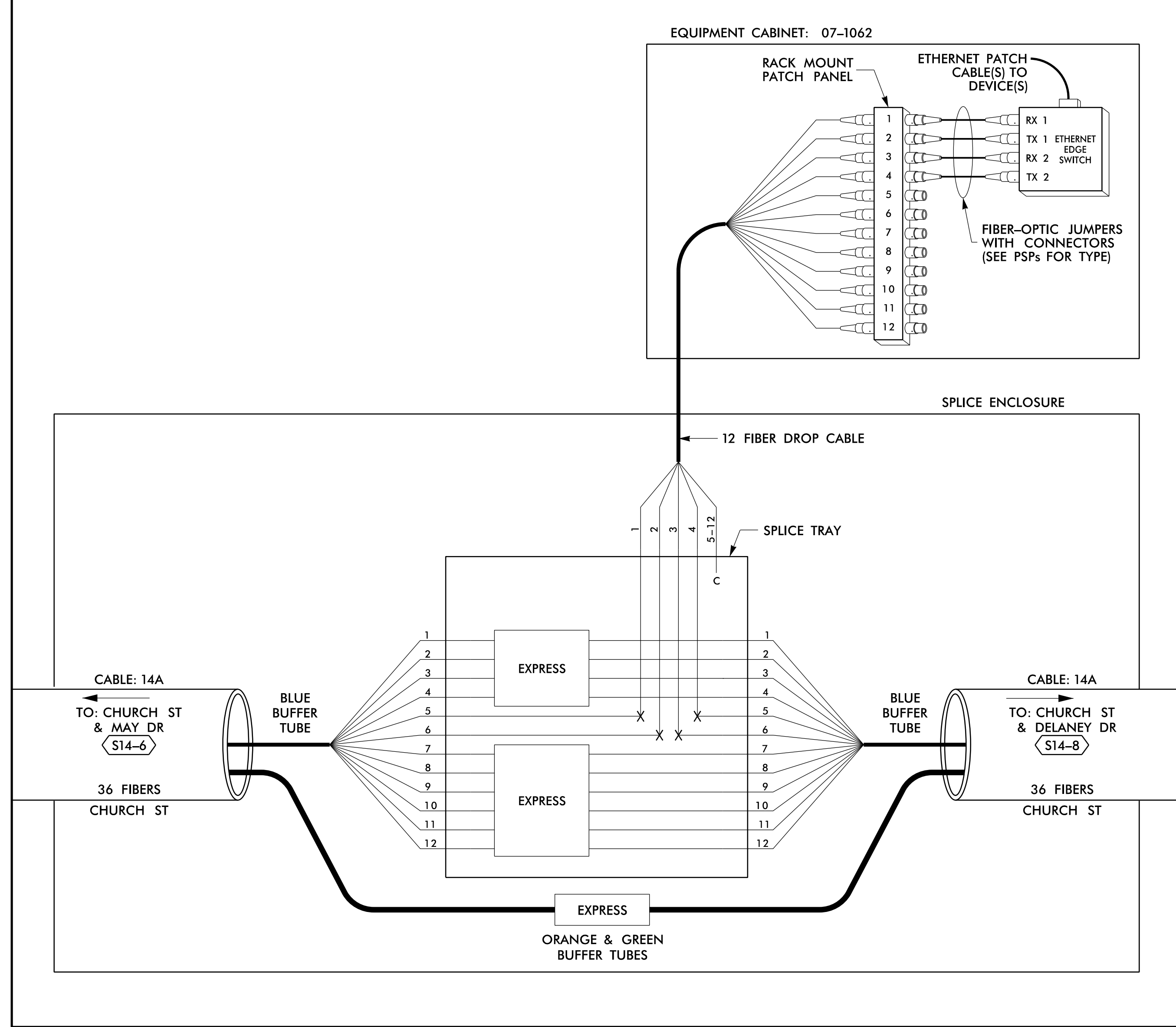

SPLICE NO.

S14-8

CHURCH ST & DELANEY DR
SEE: CRP-6.015

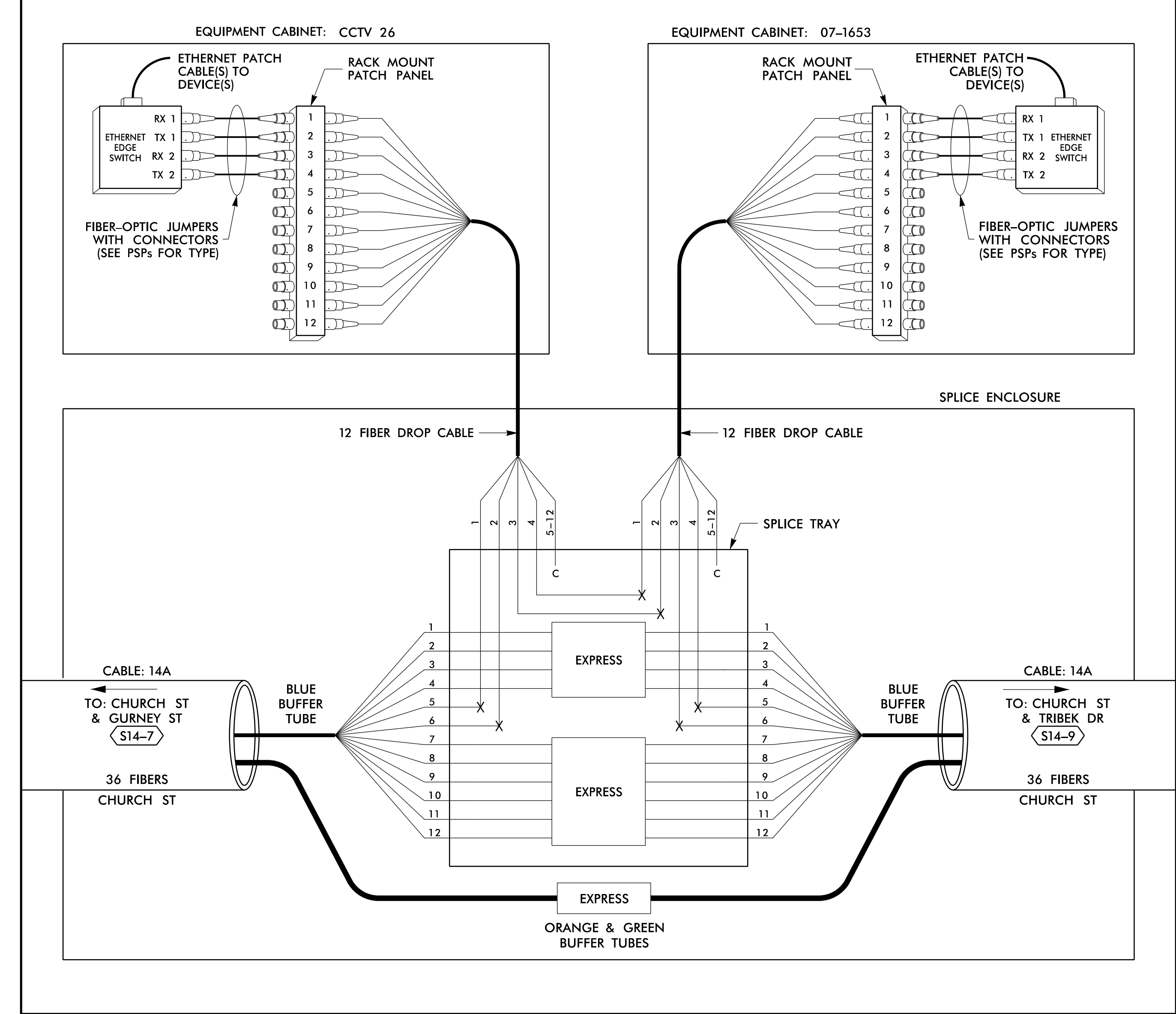

14 JUN 2018 12:30
 D:\projects\atkins\proj\11\1100056469 U-6015 B-C Sig Sys\Task 11_Comm\Fs 4.088.dgn
 S:\033633 AT_LUS355433

LEGEND

COLOR CODE TIA/EIA 598-B		X = FUSION SPLICE INDIVIDUAL FIBER	
(1) BLUE	(7) RED	EXPRESS	EXPRESS ENTIRE BUFFER TUBE / FIBERS THROUGH WITHOUT CUTTING
(2) ORANGE	(8) BLACK	BUFFER SPLICE	SPLICE ALL FIBERS IN BUFFER TUBE COLOR TO COLOR
(3) GREEN	(9) YELLOW	EXISTING	EXISTING BUFFER TUBE / FIBERS DO NOT MODIFY EXISTING SPLICES OR EXPRESSED FIBERS.
(4) BROWN	(10) VIOLET		
(5) SLATE	(11) ROSE		
(6) WHITE	(12) AQUA		

NOTES

- UNUSED FIBERS LEFT COILED AND STORED IN SPLICE TRAY
- UNUSED BUFFER TUBES LEFT COILED AND STORED IN SPLICE ENCLOSURE
- EDGE SWITCH CONFIGURATIONS ARE GENERIC. CONTRACTOR IS RESPONSIBLE FOR DETERMINING/ENSURING THE PROPER TERMINATIONS.

ATKINS 1616 EAST MILLBROOK ROAD, SUITE 160
RALEIGH, NORTH CAROLINA 27609
(919) 876-6888 NCBEEES #F-0326

DOCUMENT NOT CONSIDERED FINAL UNLESS ALL SIGNATURES COMPLETED

	Burlington-Graham Signal System Fiber-Optic Splicing Details		
	Division 7 Alamance County	Burlington & Graham	
	PLAN DATE: June 2018	REVIEWED BY: HA BADGETT	
	PREPARED BY: BJ SLOCUM	REVIEWED BY: DL JONES	
SCALE: N/A	REVISIONS	INIT. DATE	DATE

SPLICE NO.

S14-9

CHURCH ST & TRIBEK DR
SEE: CRP-6.015

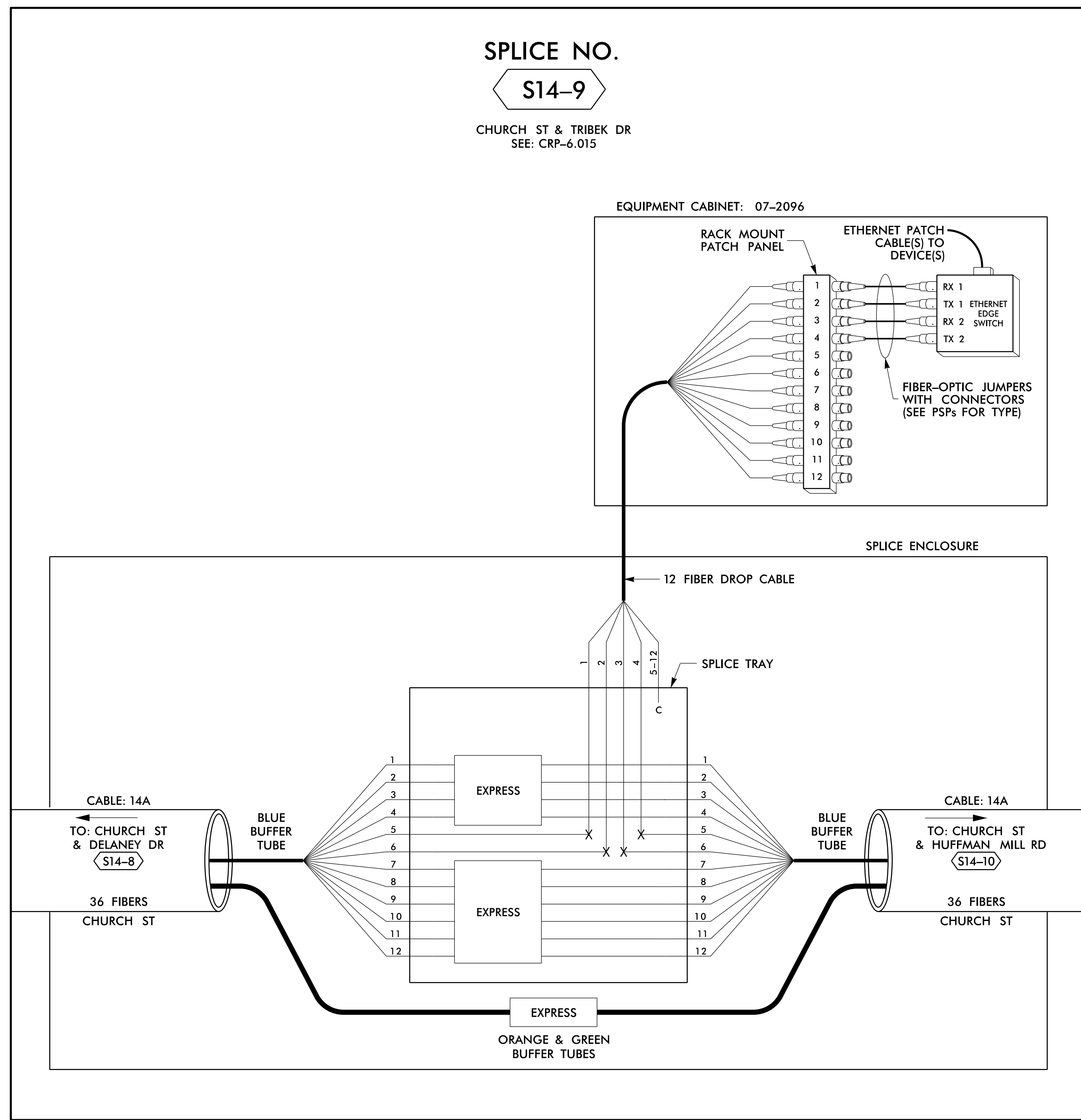

14 JUN 2018 12:30
 D:\Technical\proj\100056469 U-6015 B-C Sig Sys\Task 11_Coms\F5 4.089.dgn
 S:\DCS\653 AT LUS355433

LEGEND

COLOR CODE TIA/EIA 598-B		X = FUSION SPlice INDIVIDUAL FIBER
(1) BLUE	(7) RED	EXPRESS ENTIRE BUFFER TUBE / FIBERS THROUGH WITHOUT CUTTING
(2) ORANGE	(8) BLACK	C = CAP AND SEAL
(3) GREEN	(9) YELLOW	EXPRESS ALL FIBERS IN BUFFER TUBE COLOR TO COLOR
(4) BROWN	(10) VIOLET	EXISTING BUFFER TUBE / FIBERS DO NOT MODIFY EXISTING SPLICES OR EXPRESSED FIBERS.
(5) SLATE	(11) ROSE	
(6) WHITE	(12) AQUA	

NOTES

- UNUSED FIBERS LEFT COILED AND STORED IN SPLICE TRAY
- UNUSED BUFFER TUBES LEFT COILED AND STORED IN SPLICE ENCLOSURE
- EDGE SWITCH CONFIGURATIONS ARE GENERIC. CONTRACTOR IS RESPONSIBLE FOR DETERMINING/ENSURING THE PROPER TERMINATIONS.

ATKINS 1616 EAST MILLBROOK ROAD, SUITE 160
RALEIGH, NORTH CAROLINA 27609
(919) 876-6888 NCBES #F-0326

DOCUMENT NOT CONSIDERED FINAL UNLESS ALL SIGNATURES COMPLETED

<p>Prepared for the Offices of: NORTH CAROLINA DEPARTMENT OF TRANSPORTATION Transportation Systems</p>	Burlington-Graham Signal System Fiber-Optic Splicing Details		
	Division 7 Alamance County Burlington & Graham		
PLAN DATE: June 2018 PREPARED BY: BJ SLOCUM	REVIEWED BY: HA BADGETT REVIEWED BY: DL JONES		
SCALE: N/A	REVISIONS	INIT.	DATE
CAD0 File name: FS_4.089.dgn			

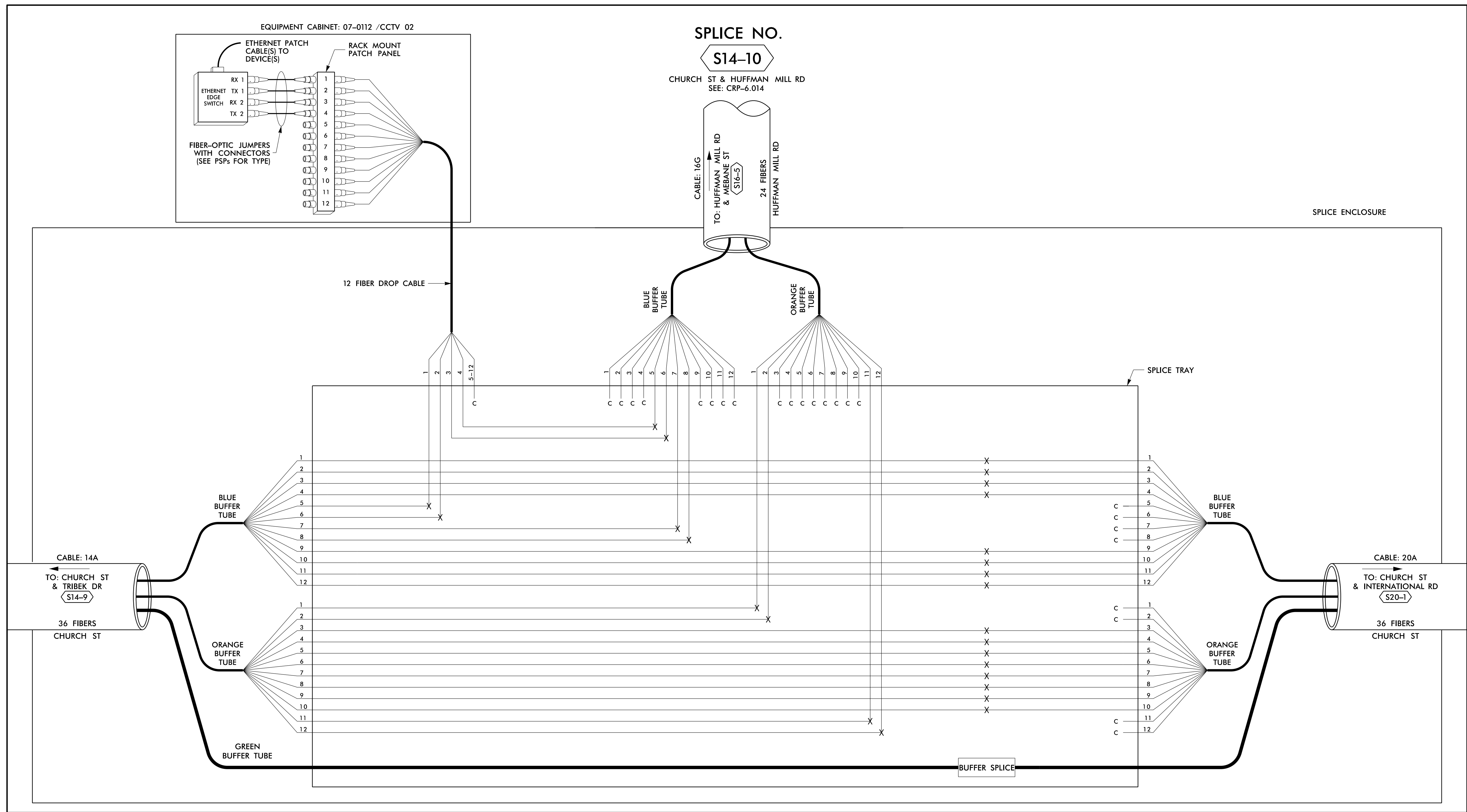

14 JUN 2018 12:30
 D:\Technical\Projects\U-6015 B-C Sig Sys\Task 11_Coms#FS 4.090.dgn
 S:\DCS\653 AT_LUS355433

LEGEND

COLOR CODE TIA/EIA 598-B	X = FUSION SPLICE INDIVIDUAL FIBER
(1) BLUE	C = CAP AND SEAL
(2) ORANGE	EXPRESS
(3) GREEN	BUFFER SPLICE
(4) BROWN	EXISTING
(5) SLATE	EXPRESS ENTIRE BUFFER TUBE /FIBERS THROUGH WITHOUT CUTTING
(6) WHITE	SPLICE ALL FIBERS IN BUFFER TUBE COLOR TO COLOR
(7) RED	EXISTING BUFFER TUBE /FIBERS DO NOT MODIFY EXISTING SPLICES OR EXPRESSED FIBERS.
(8) BLACK	
(9) YELLOW	
(10) VIOLET	
(11) ROSE	
(12) AQUA	

- ### NOTES
- UNUSED FIBERS LEFT COILED AND STORED IN SPICE TRAY
 - UNUSED BUFFER TUBES LEFT COILED AND STORED IN SPICE ENCLOSURE
 - EDGE SWITCH CONFIGURATIONS ARE GENERIC. CONTRACTOR IS RESPONSIBLE FOR DETERMINING/ENSURING THE PROPER TERMINATIONS.

ATKINS 1616 EAST MILLBROOK ROAD, SUITE 160
 RALEIGH, NORTH CAROLINA 27609
 (919) 876-6888 NCBEE# F-0326

DOCUMENT NOT CONSIDERED FINAL UNLESS ALL SIGNATURES COMPLETED

<p>750 Greenfield Parkway, Garner, NC 27529</p>	Prepared for the Offices of: North Carolina Department of Transportation		SEAL NORTH CAROLINA PROFESSIONAL ENGINEER SEAL 040877 BRADFORD J. SLOCUM ENGINEER 15/2018 DATE
	Burlington-Graham Signal System Fiber-Optic Splicing Details		
Division 7 Alamance County Burlington & Graham		PLAN DATE: June 2018 REVIEWED BY: HA BADGETT	
PREPARED BY: BJ SLOCUM		REVIEWED BY: DL JONES	
SCALE: N/A		REVISIONS: INIT. DATE	
CAD FILE NAME: FS 4.090.dgn		DATE	

SPLICE NO. S15-1

I-40 WB /I-85 SB & ALAMANCE RD
SEE: CRP-6.089

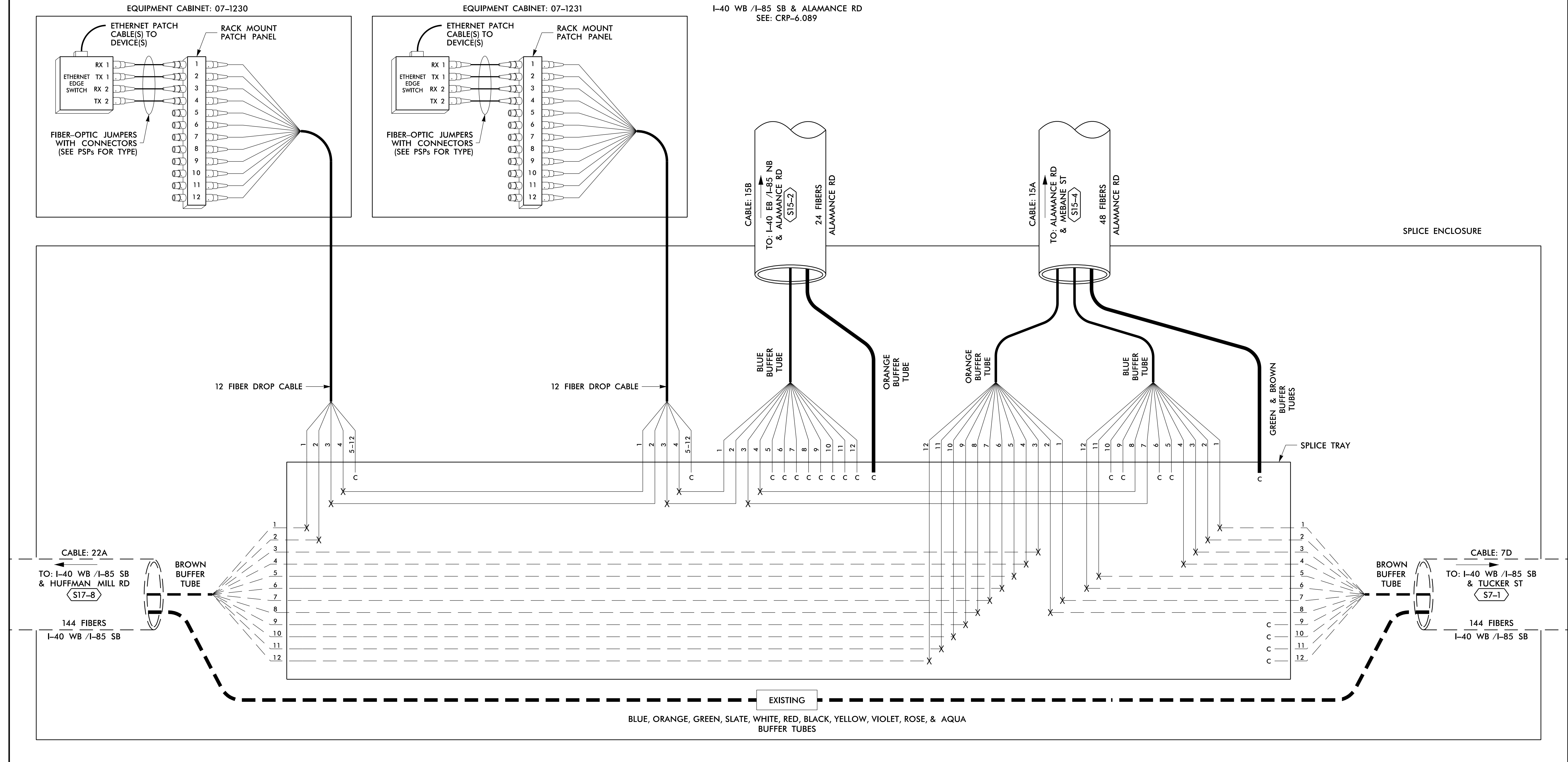

LEGEND

COLOR CODE TIA/EIA 598-B		X = FUSION SPLICE INDIVIDUAL FIBER
(1) BLUE	(7) RED	EXPRESS ENTIRE BUFFER TUBE /FIBERS THROUGH WITHOUT CUTTING
(2) ORANGE	(8) BLACK	SPLICE ALL FIBERS IN BUFFER TUBE COLOR TO COLOR
(3) GREEN	(9) YELLOW	EXISTING BUFFER TUBE /FIBERS DO NOT MODIFY EXISTING SPLICES OR EXPRESSED FIBERS.
(4) BROWN	(10) VIOLET	
(5) SLATE	(11) ROSE	
(6) WHITE	(12) AQUA	

NOTES

- UNUSED FIBERS LEFT COILED AND STORED IN SPLICE TRAY
- UNUSED BUFFER TUBES LEFT COILED AND STORED IN SPLICE ENCLOSURE
- EDGE SWITCH CONFIGURATIONS ARE GENERIC. CONTRACTOR IS RESPONSIBLE FOR DETERMINING/ENSURING THE PROPER TERMINATIONS.

ATKINS

1616 EAST MILLBROOK ROAD, SUITE 160
RALEIGH, NORTH CAROLINA 27609
(919) 876-6888 NCBEEES #F-0326

DOCUMENT NOT CONSIDERED FINAL UNLESS ALL SIGNATURES COMPLETED

Prepared for the Offices of:

 State of North Carolina
 Department of Transportation

**Burlington-Graham Signal System
Fiber-Optic Splicing Details**

Division 7 Alamance County Burlington & Graham

PLAN DATE: June 2018 REVIEWED BY: HA BADGETT
 PREPARED BY: BJ SLOCUM REVIEWED BY: DL JONES

REVISIONS	INIT.	DATE

SCALE: N/A

750 Greenfield Parkway, Garner, NC 27529

SEAL
 NORTH CAROLINA PROFESSIONAL ENGINEER
 SEAL 040877
 BRADFORD J. SLOCUM
 15/2018
 DATE

CADD File name: FS_4.091.dgn

14 JUN 2018 12:30
D:\projects\proj\100056469 U-6015 B-C Sig Sys\Task 11_Comms\F S 4.091.dgn
S:\035633 AT_LUS355433

SPLICE NO.
S15-2

I-40 EB /I-85 NB & ALAMANCE RD
SEE: CRP-6.089

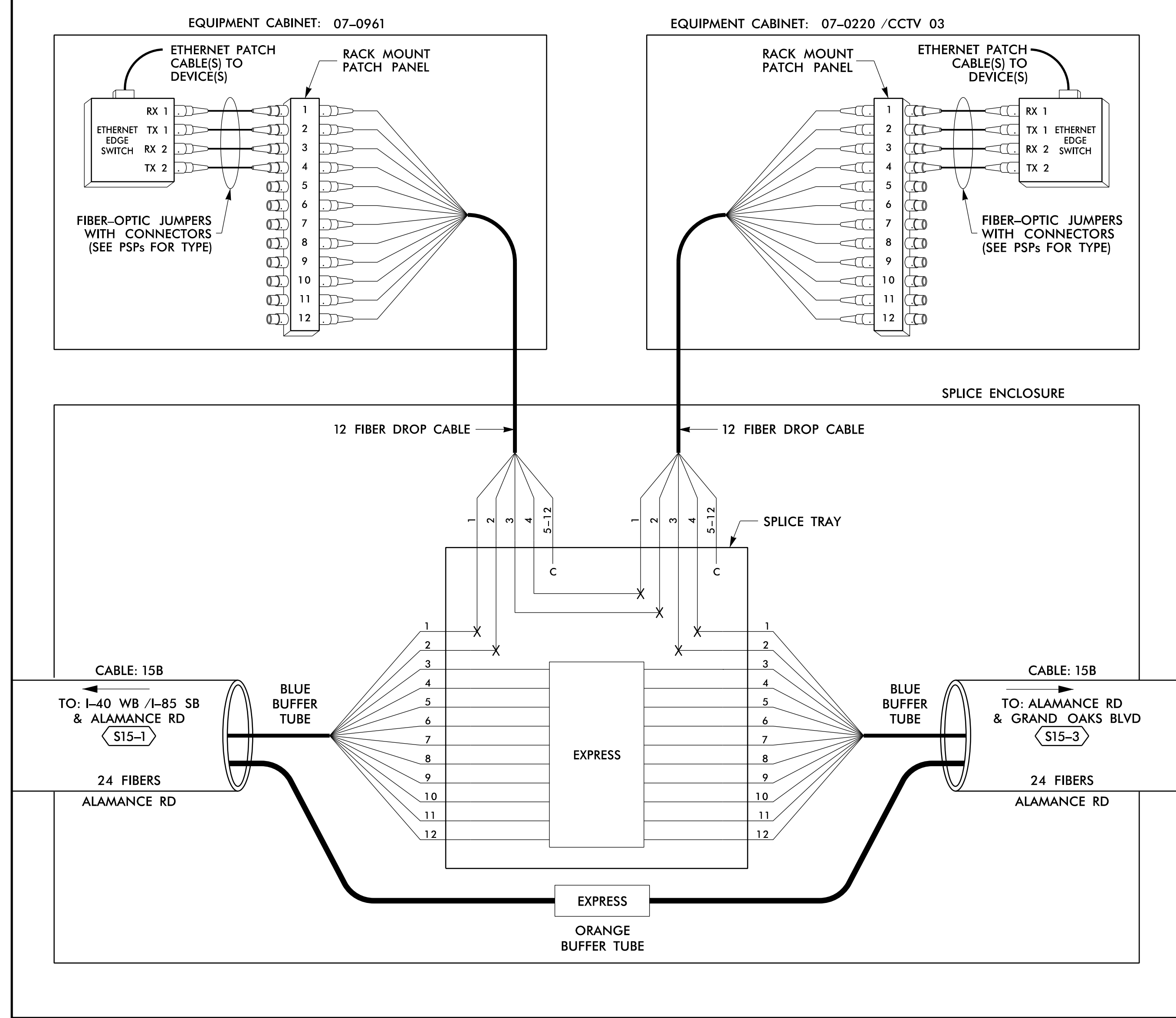

SPLICE NO.
S15-3

ALAMANCE RD & GRAND OAKS BLVD
SEE: CRP-6.087

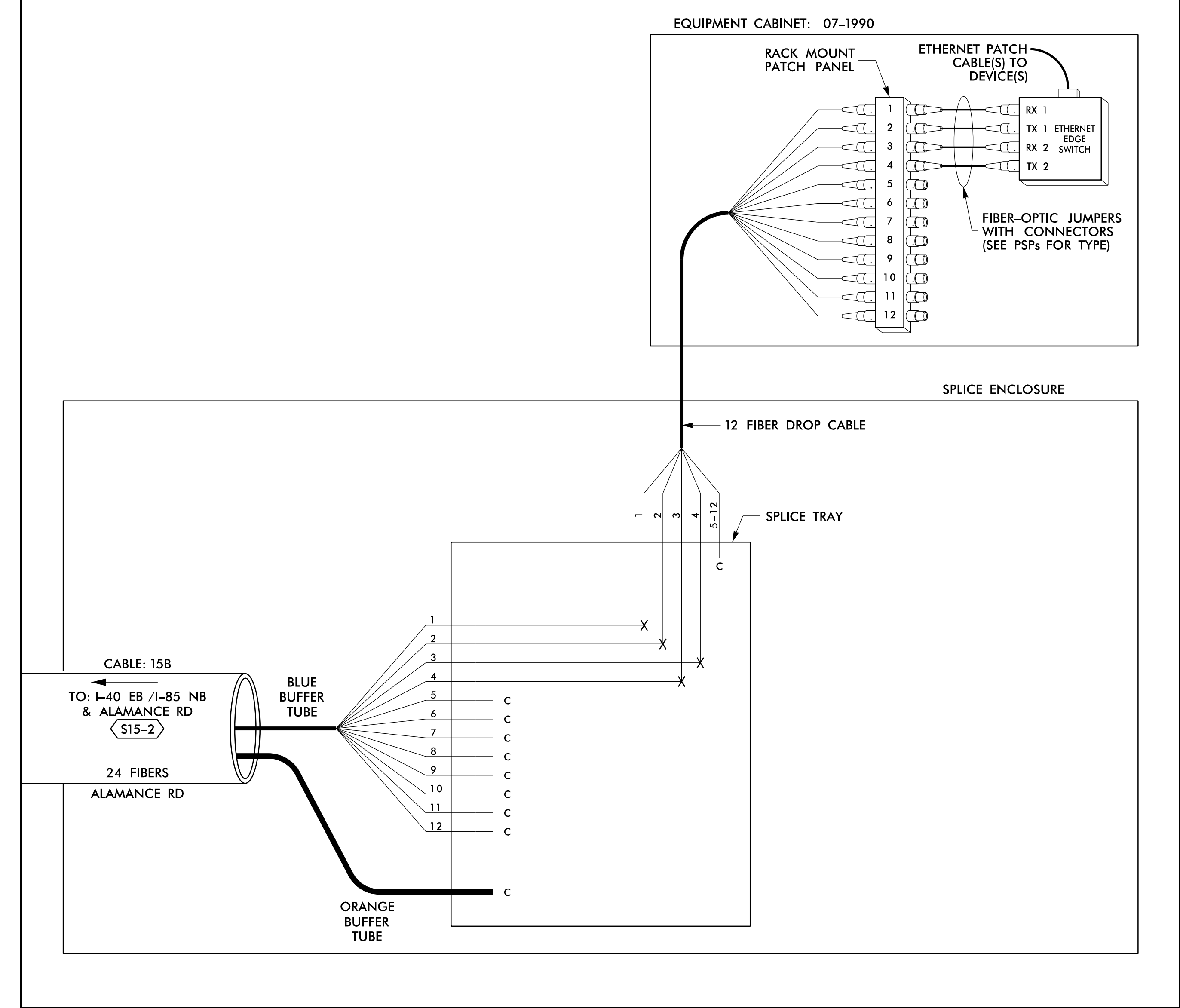

LEGEND

COLOR CODE TIA/EIA 598-B		X = FUSION SPLICE INDIVIDUAL FIBER	
(1) BLUE	(7) RED	EXPRESS	EXPRESS ENTIRE BUFFER TUBE /FIBERS THROUGH WITHOUT CUTTING
(2) ORANGE	(8) BLACK	BUFFER SPLICE	SPLICE ALL FIBERS IN BUFFER TUBE COLOR TO COLOR
(3) GREEN	(9) YELLOW	EXISTING	EXISTING BUFFER TUBE /FIBERS DO NOT MODIFY EXISTING SPLICES OR EXPRESSED FIBERS.
(4) BROWN	(10) VIOLET		
(5) SLATE	(11) ROSE		
(6) WHITE	(12) AQUA		

NOTES

- UNUSED FIBERS LEFT COILED AND STORED IN SPLICE TRAY
- UNUSED BUFFER TUBES LEFT COILED AND STORED IN SPLICE ENCLOSURE
- EDGE SWITCH CONFIGURATIONS ARE GENERIC. CONTRACTOR IS RESPONSIBLE FOR DETERMINING/ENSURING THE PROPER TERMINATIONS.

ATKINS 1616 EAST MILLBROOK ROAD, SUITE 160
RALEIGH, NORTH CAROLINA 27609
(919) 876-6888 NCBEEES #F-0326

DOCUMENT NOT CONSIDERED FINAL
UNLESS ALL SIGNATURES COMPLETED

<p>750 Greenfield Parkway, Garner, NC 27529</p>	<p>Burlington-Graham Signal System Fiber-Optic Splicing Details</p>		
	<p>Division 7 Alamance County</p>	<p>Burlington & Graham</p>	
<p>SCALE: N/A</p>	<p>PLAN DATE: June 2018</p>	<p>REVIEWED BY: HA BADGETT</p>	<p>DATE: 15/2018</p>
<p>PREPARED BY: BJ SLOCUM</p>	<p>REVISIONS</p>	<p>REVIEWED BY: DL JONES</p>	<p>DATE</p>

I:\JUN-2018_12:30
 D:\Technical\proj\con\Truff\c\Cur*100056469 U=6015 B=C Sig_Sys\Task 11_Corrs\F S 4.092.dgn
 S:\DCS\653 AT_LUS355433

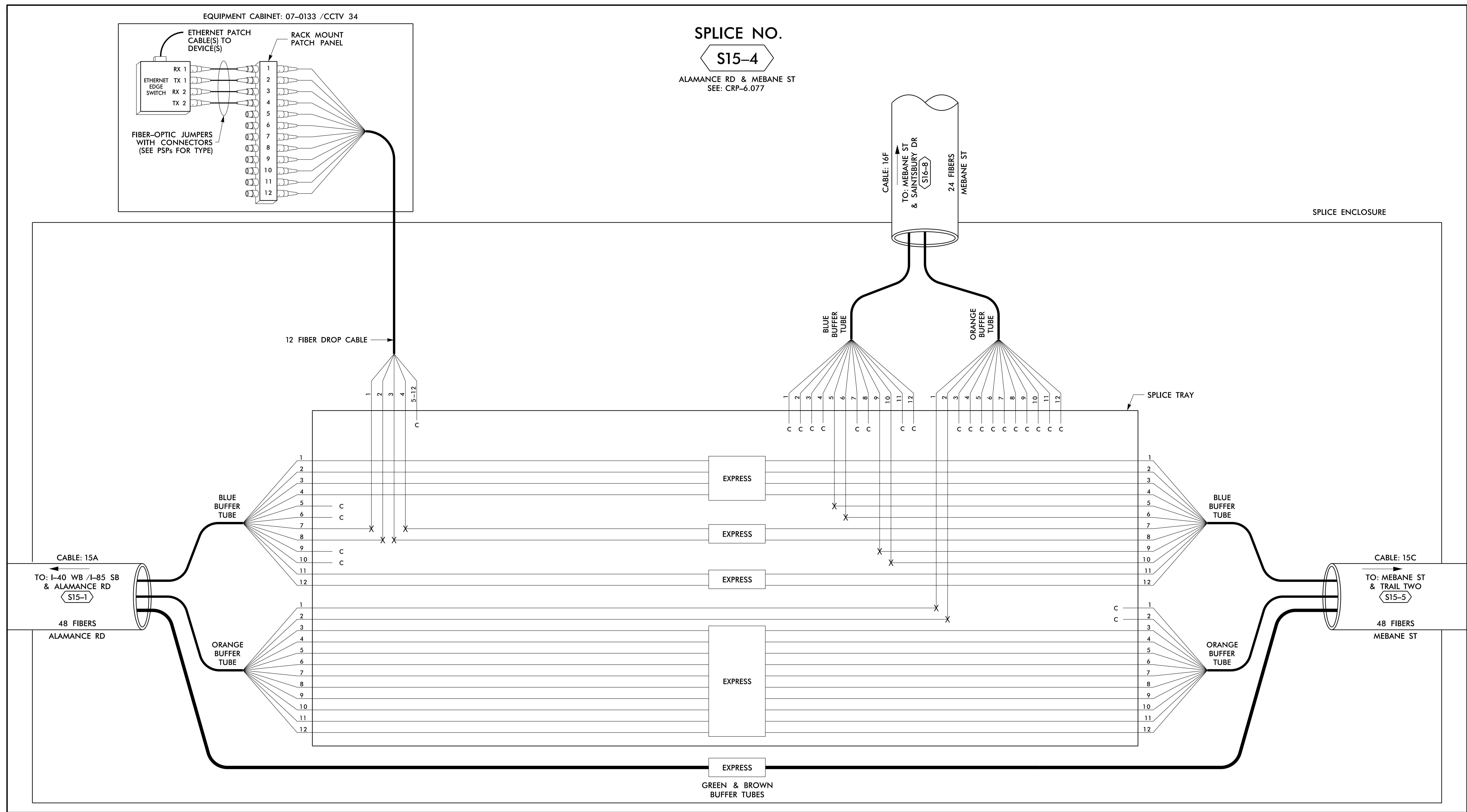

SPICE NO. S15-4

ALAMANCE RD & MEBANE ST
SEE: CRP-6.077

SPICE ENCLOSURE

14-JUN-2018 12:30
D:\projects\proj\11\comms\11_00056469 U-6015 B-C Sig_Sys\Task 11_Comms\F 4.093.dgn
S:\DCS\653 AT_LUS355433

LEGEND

COLOR CODE TIA/EIA 598-B		X = FUSION SPICE INDIVIDUAL FIBER	
(1) BLUE	(7) RED	EXPRESS	EXPRESS ENTIRE BUFFER TUBE /FIBERS THROUGH WITHOUT CUTTING
(2) ORANGE	(8) BLACK	BUFFER SPICE	SPICE ALL FIBERS IN BUFFER TUBE COLOR TO COLOR
(3) GREEN	(9) YELLOW	EXISTING	EXISTING BUFFER TUBE /FIBERS DO NOT MODIFY EXISTING SPICES OR EXPRESSED FIBERS.
(4) BROWN	(10) VIOLET		
(5) SLATE	(11) ROSE		
(6) WHITE	(12) AQUA		
		C =	CAP AND SEAL

NOTES

1. UNUSED FIBERS LEFT COILED AND STORED IN SPICE TRAY
2. UNUSED BUFFER TUBES LEFT COILED AND STORED IN SPICE ENCLOSURE
3. EDGE SWITCH CONFIGURATIONS ARE GENERIC. CONTRACTOR IS RESPONSIBLE FOR DETERMINING/ENSURING THE PROPER TERMINATIONS.

ATKINS 1616 EAST MILLBROOK ROAD, SUITE 160
RALEIGH, NORTH CAROLINA 27609
(919) 876-6888 NCBEE# F-0326

DOCUMENT NOT CONSIDERED FINAL
UNLESS ALL SIGNATURES COMPLETED

Prepared for the Offices of:

 Burlington-Graham Signal System
 Fiber-Optic Splicing Details
 Division 7 Alamance County Burlington & Graham
 PLAN DATE: June 2018 REVIEWED BY: HA BADGETT
 PREPARED BY: BJ SLOCUM REVIEWED BY: DL JONES
 SCALE: N/A
 REVISIONS: _____ INIT. DATE _____
 SEAL NORTH CAROLINA PROFESSIONAL ENGINEER SEAL 040877
 BRADFORD J. SLOCUM
 15/2018
 CADD File name: FS_4.093.dgn

SPLICE NO.
S15-5

MEBANE ST & TRAIL TWO
SEE: CRP-6.078

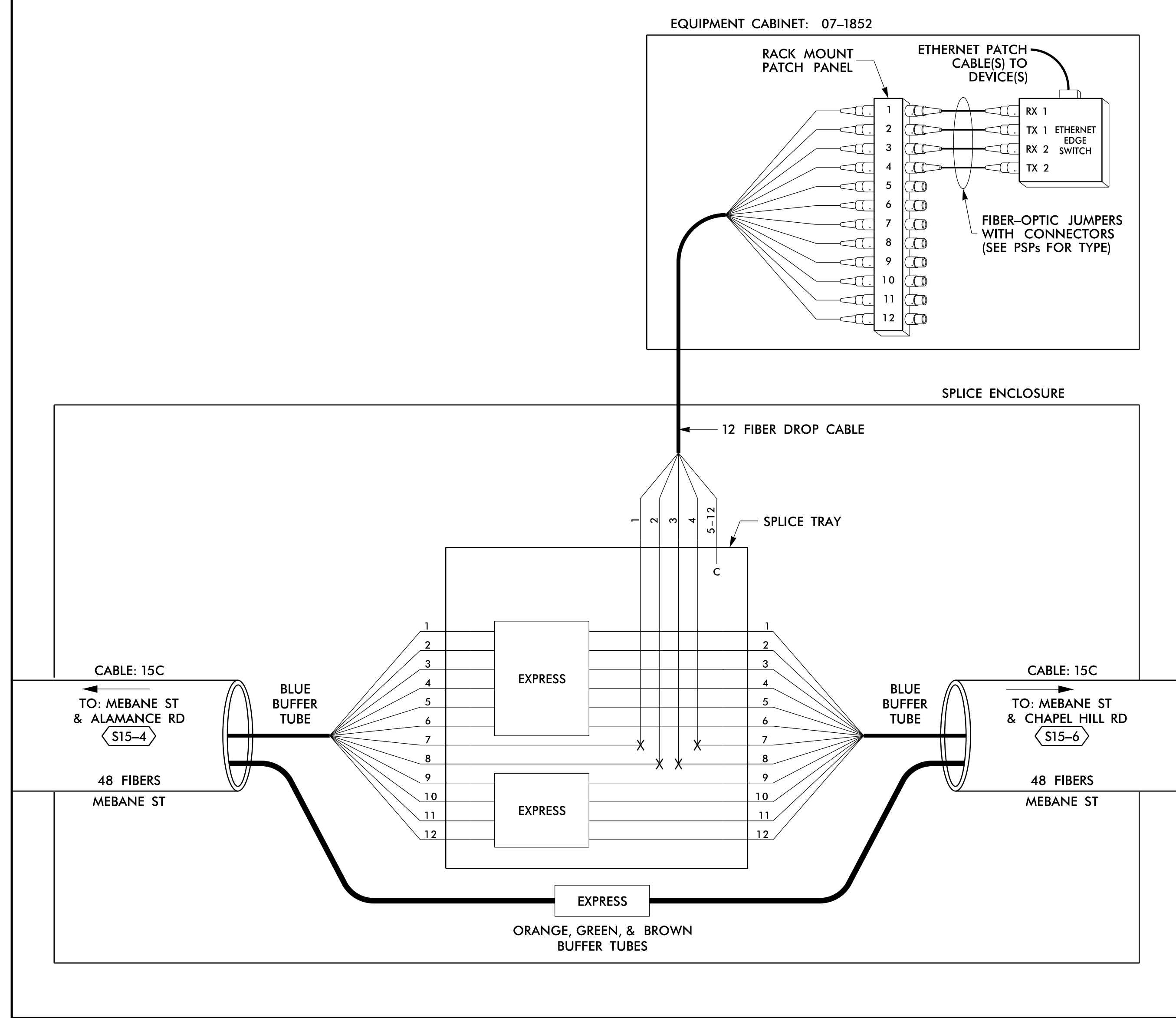

SPLICE NO.
S15-6

MEBANE ST & CHAPEL HILL RD
SEE: CRP-6.081

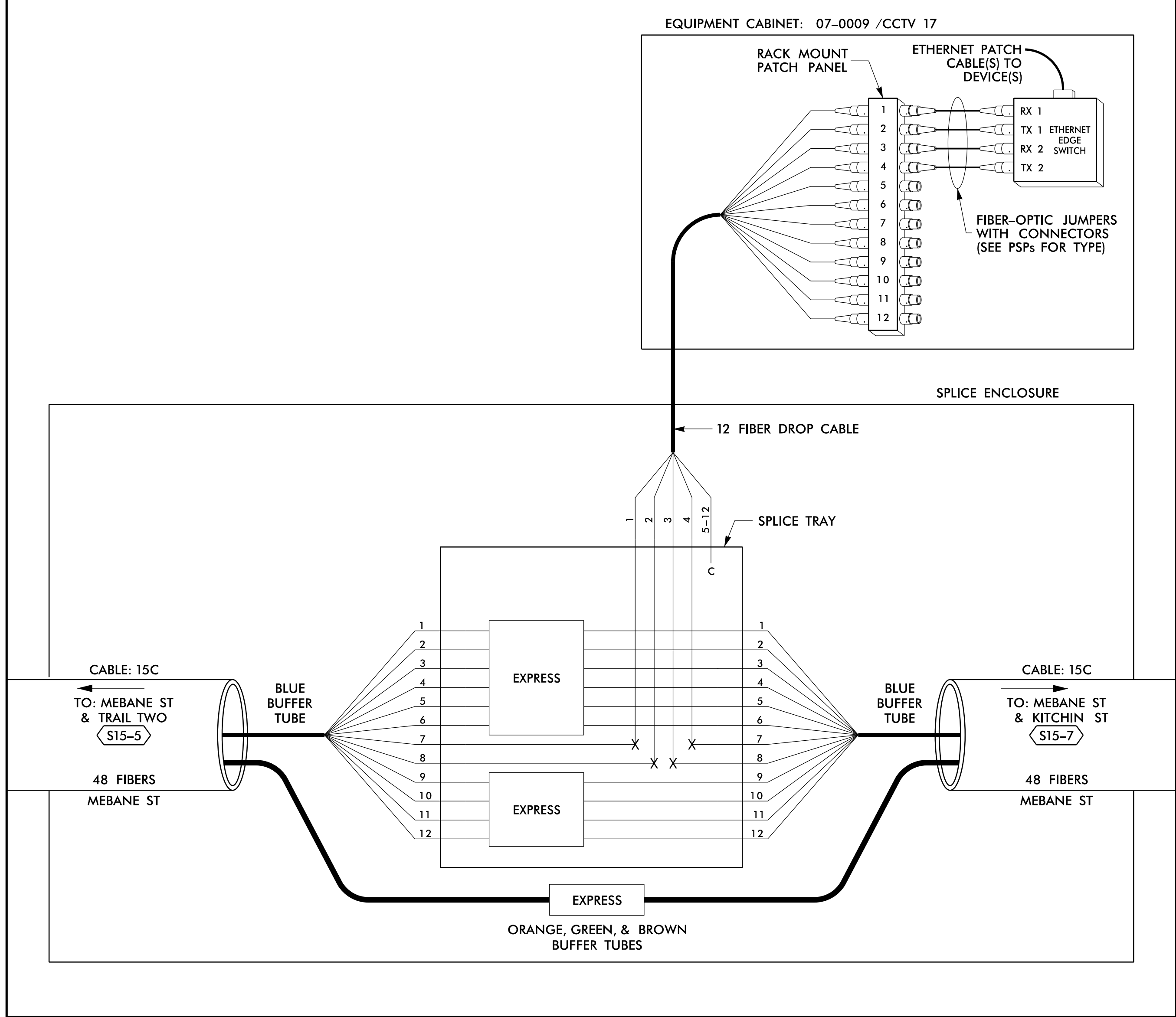

14-JUN-2018 12:30
 D:\projects\proj\11\comms\11_Coms\Fs 4.094.dgn
 0:\projects\proj\11\comms\11_Coms\Fs 4.094.dgn
 S:\033633 AT LUS355433

LEGEND

COLOR CODE TIA/EIA 598-B		X = FUSION SPlice INDIVIDUAL FIBER	
(1) BLUE	(7) RED	EXPRESS	EXPRESS ENTIRE BUFFER TUBE / FIBERS THROUGH WITHOUT CUTTING
(2) ORANGE	(8) BLACK	BUFFER SPlice	SPlice ALL FIBERS IN BUFFER TUBE COLOR TO COLOR
(3) GREEN	(9) YELLOW	EXISTING	EXISTING BUFFER TUBE / FIBERS DO NOT MODIFY EXISTING SPlices OR EXPRESSED FIBERS.
(4) BROWN	(10) VIOLET		
(5) SLATE	(11) ROSE		
(6) WHITE	(12) AQUA		

NOTES

- UNUSED FIBERS LEFT COILED AND STORED IN SPLICE TRAY
- UNUSED BUFFER TUBES LEFT COILED AND STORED IN SPLICE ENCLOSURE
- EDGE SWITCH CONFIGURATIONS ARE GENERIC. CONTRACTOR IS RESPONSIBLE FOR DETERMINING/ENSURING THE PROPER TERMINATIONS.

ATKINS 1616 EAST MILLBROOK ROAD, SUITE 160
RALEIGH, NORTH CAROLINA 27609
(919) 876-6888 NCBEEES #F-0326

DOCUMENT NOT CONSIDERED FINAL UNLESS ALL SIGNATURES COMPLETED

<p>750 Greenfield Parkway, Garner, NC 27529</p>	Prepared for the Offices of: NORTH CAROLINA DEPARTMENT OF TRANSPORTATION			
	Burlington-Graham Signal System Fiber-Optic Splicing Details			
	Division 7 Alamance County	Burlington & Graham		
	PLAN DATE: June 2018	REVIEWED BY: HA BADGETT		
PREPARED BY: BJ SLOCUM	REVIEWED BY: DL JONES	DATE: 6/15/2018		
SCALE: N/A	REVISIONS	INIT.	DATE	

SPLICE NO.
S15-7

MEBANE ST & KITCHIN ST
SEE: CRP-6.083

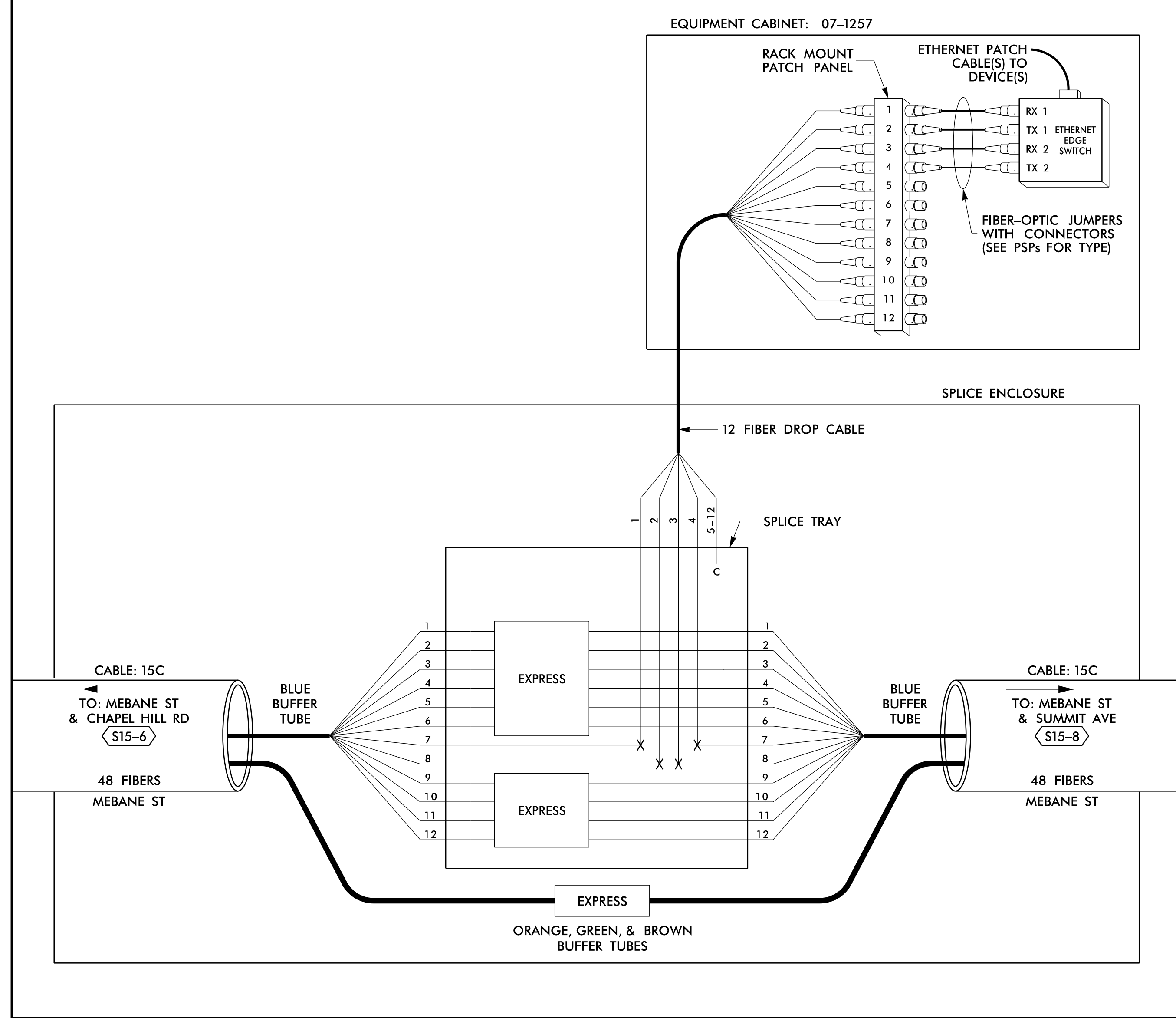

SPLICE NO.
S15-8

MEBANE ST & SUMMIT AVE
SEE: CRP-6.084

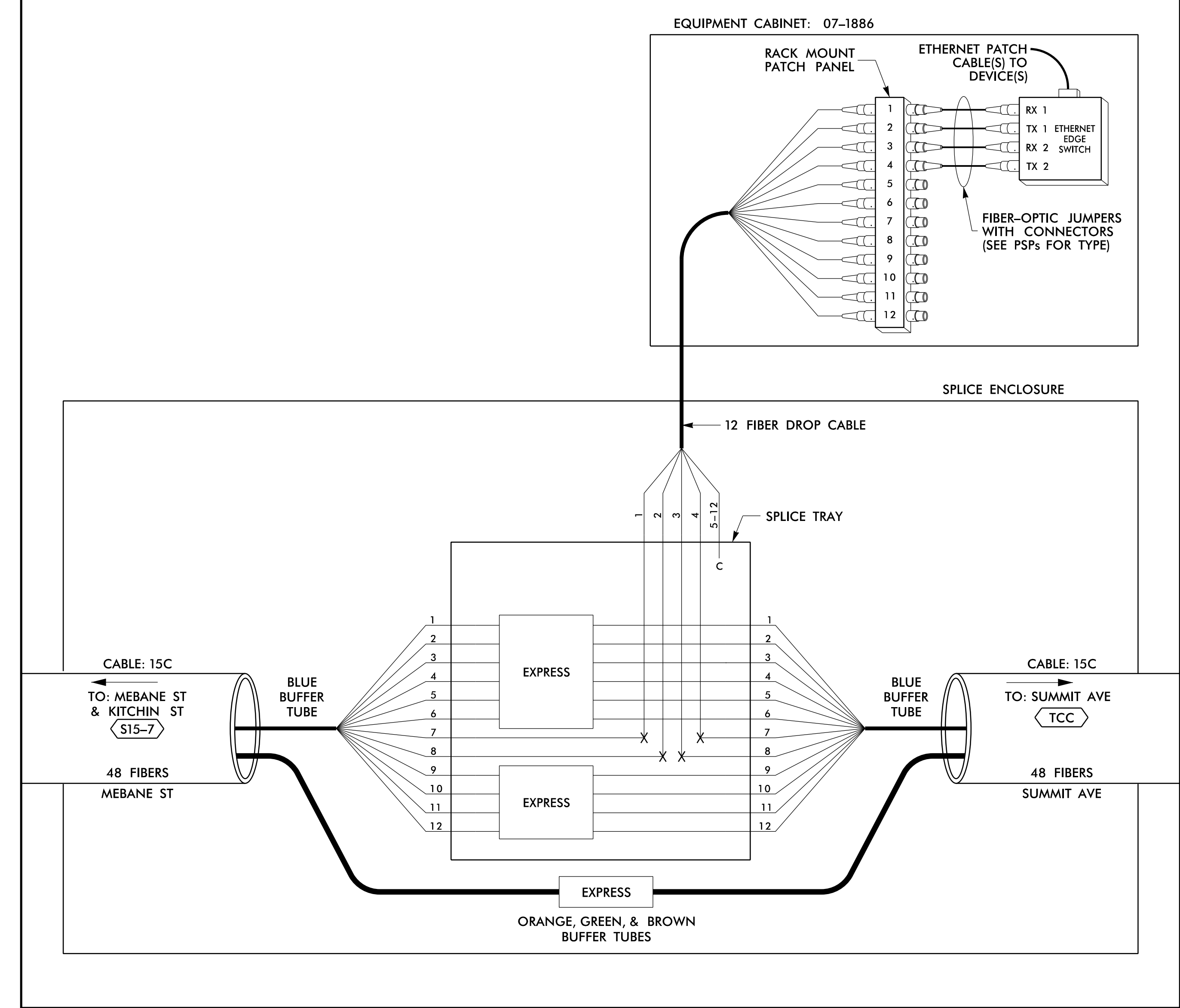

14 JUN 2018 12:30
 D:\projects\proj\100056469 U-6015 B-C Sig Sys\Task 11_Corrs\F 4.095.dgn
 S:\033633 AT_LUS355433

LEGEND

COLOR CODE TIA/EIA 598-B		X = FUSION SPlice INDIVIDUAL FIBER	
(1) BLUE	(7) RED	EXPRESS	EXPRESS ENTIRE BUFFER TUBE / FIBERS THROUGH WITHOUT CUTTING
(2) ORANGE	(8) BLACK	BUFFER SPlice	SPlice ALL FIBERS IN BUFFER TUBE COLOR TO COLOR
(3) GREEN	(9) YELLOW	EXISTING	EXISTING BUFFER TUBE / FIBERS DO NOT MODIFY EXISTING SPlices OR EXPRESSED FIBERS.
(4) BROWN	(10) VIOLET		
(5) SLATE	(11) ROSE		
(6) WHITE	(12) AQUA		

NOTES

- UNUSED FIBERS LEFT COILED AND STORED IN SPLICE TRAY
- UNUSED BUFFER TUBES LEFT COILED AND STORED IN SPLICE ENCLOSURE
- EDGE SWITCH CONFIGURATIONS ARE GENERIC. CONTRACTOR IS RESPONSIBLE FOR DETERMINING/ENSURING THE PROPER TERMINATIONS.

ATKINS 1616 EAST MILLBROOK ROAD, SUITE 160
RALEIGH, NORTH CAROLINA 27609
(919) 876-6888 NCBEEES #F-0326

DOCUMENT NOT CONSIDERED FINAL UNLESS ALL SIGNATURES COMPLETED

	Burlington-Graham Signal System Fiber-Optic Splicing Details			
	Division 7	Alamance County		Burlington & Graham
	PLAN DATE: June 2018	REVIEWED BY: HA BADGETT		
	PREPARED BY: BJ SLOCUM	REVIEWED BY: DL JONES		
750 Greenfield Parkway, Garner, NC 27529		SCALE: N/A		
REVISIONS _____ INIT. DATE _____ _____		DATE: 15/2018 DATE: _____ DATE: _____		

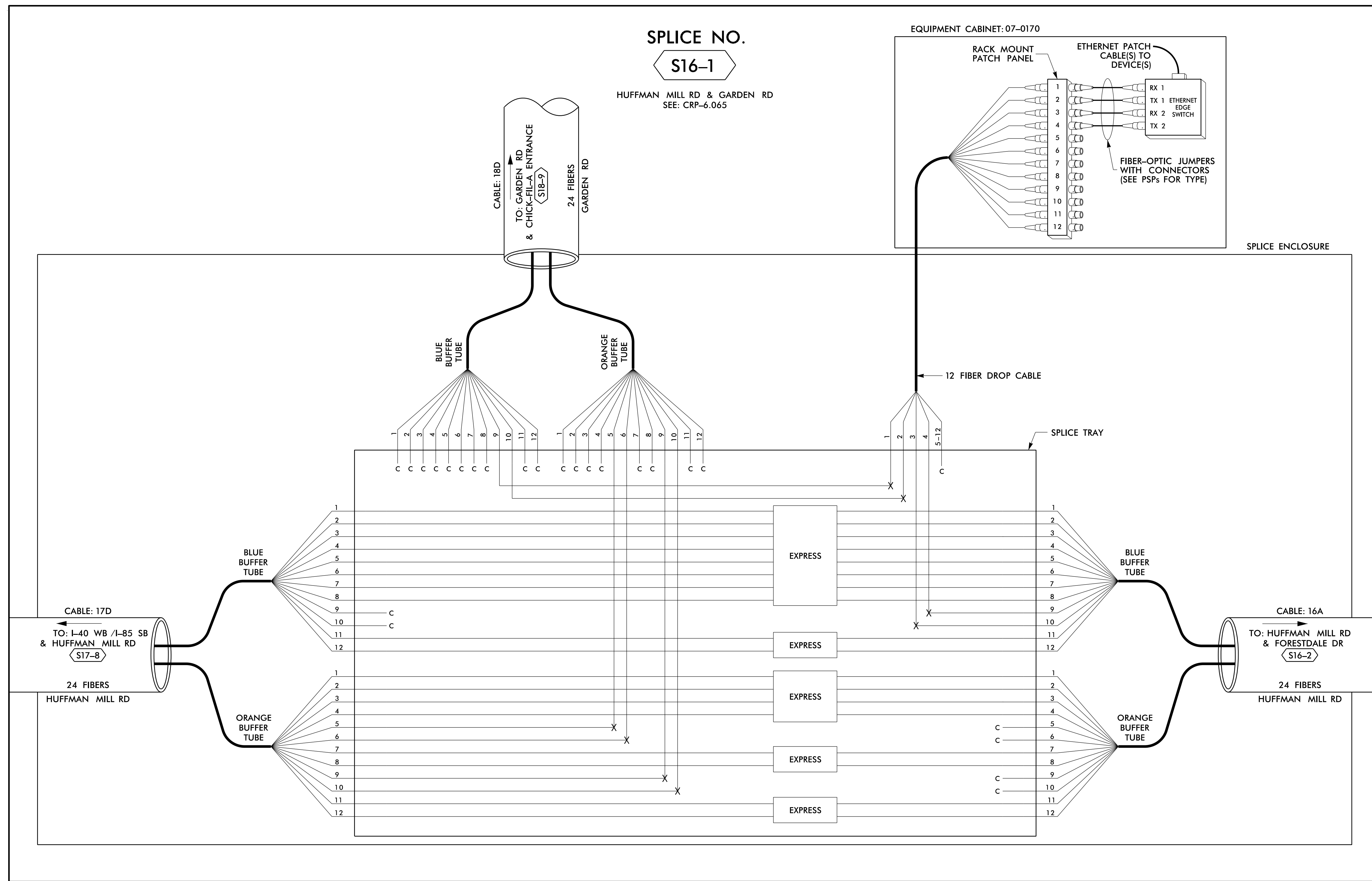

SPLICE NO.
S16-1

HUFFMAN MILL RD & GARDEN RD
SEE: CRP-6.065

EQUIPMENT CABINET: 07-0170

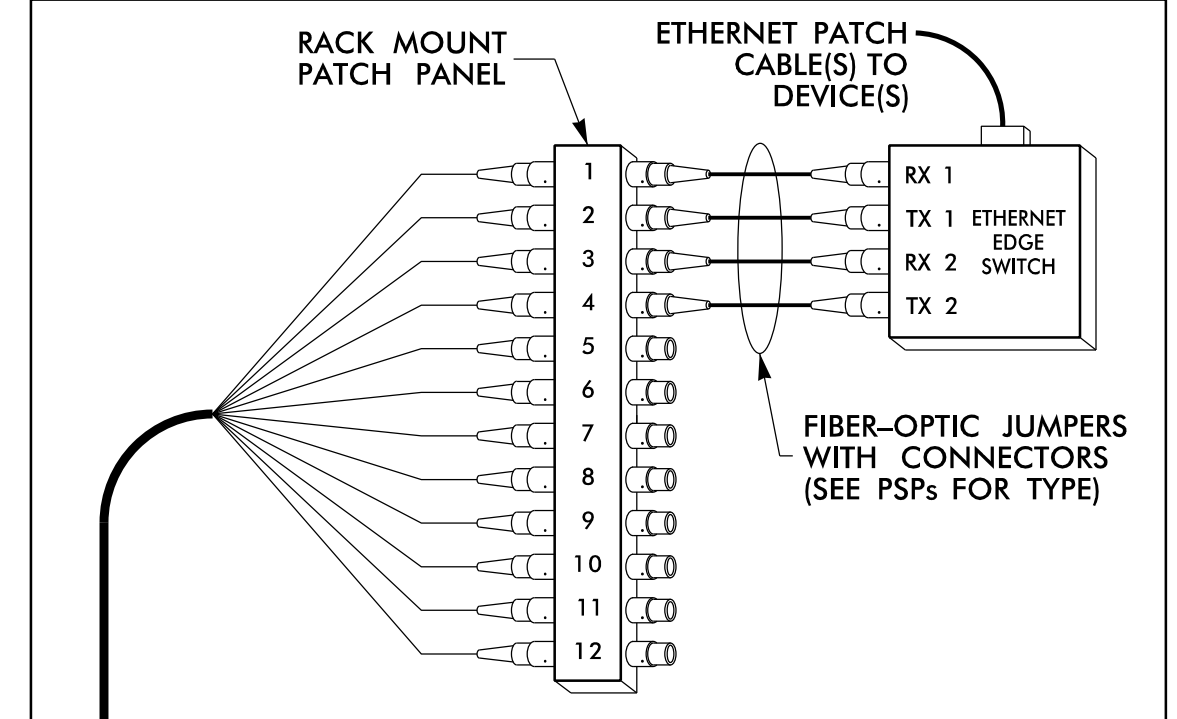

SPLICE ENCLOSURE

12 FIBER DROP CABLE

SPLICE TRAY

CABLE: 17D

TO: I-40 WB / I-85 SB & HUFFMAN MILL RD
S17-8

24 FIBERS
HUFFMAN MILL RD

BLUE BUFFER TUBE

ORANGE BUFFER TUBE

EXPRESS

EXPRESS

EXPRESS

EXPRESS

EXPRESS

BLUE BUFFER TUBE

ORANGE BUFFER TUBE

CABLE: 16A

TO: HUFFMAN MILL RD & FORESTDALE DR
S16-2

24 FIBERS
HUFFMAN MILL RD

LEGEND

COLOR CODE TIA/EIA 598-B		X = FUSION SPLICE INDIVIDUAL FIBER	EXPRESS	EXPRESS ENTIRE BUFFER TUBE / FIBERS THROUGH WITHOUT CUTTING
(1) BLUE	(7) RED	C = CAP AND SEAL	BUFFER SPLICE	SPLICE ALL FIBERS IN BUFFER TUBE COLOR TO COLOR
(2) ORANGE	(8) BLACK		EXISTING	EXISTING BUFFER TUBE / FIBERS DO NOT MODIFY EXISTING SPLICES OR EXPRESSED FIBERS.
(3) GREEN	(9) YELLOW			
(4) BROWN	(10) VIOLET			
(5) SLATE	(11) ROSE			
(6) WHITE	(12) AQUA			

NOTES

- UNUSED FIBERS LEFT COILED AND STORED IN SPLICE TRAY
- UNUSED BUFFER TUBES LEFT COILED AND STORED IN SPLICE ENCLOSURE
- EDGE SWITCH CONFIGURATIONS ARE GENERIC. CONTRACTOR IS RESPONSIBLE FOR DETERMINING/ENSURING THE PROPER TERMINATIONS.

ATKINS 1616 EAST MILLBROOK ROAD, SUITE 160
RALEIGH, NORTH CAROLINA 27609
(919) 876-6888 NCBEEES #F-0326

DOCUMENT NOT CONSIDERED FINAL
UNLESS ALL SIGNATURES COMPLETED

Prepared for the Offices of:

 750 Greenfield Parkway, Garner, NC 27529
 SCALE: N/A

Burlington-Graham Signal System Fiber-Optic Splicing Details		Burlington & Graham	
Division 7	Alamance County		
PLAN DATE: June 2018	REVIEWED BY: HA BADGETT		
PREPARED BY: BJ SLOCUM	REVIEWED BY: DL JONES		
REVISIONS	INIT.	DATE	

SEAL
 NORTH CAROLINA PROFESSIONAL ENGINEER
 SEAL 040877
 BRADFORD J. SLOCUM
 15/2018
 DATE
 CADD File name: FS 4.096.dgn

14 JUN 2018 12:30
 D:\projects\proj\100056469 U-6015 B-C Sig Sys\Task 11_Coms#FS 4.096.dgn
 S:\033653 AT LUS355433

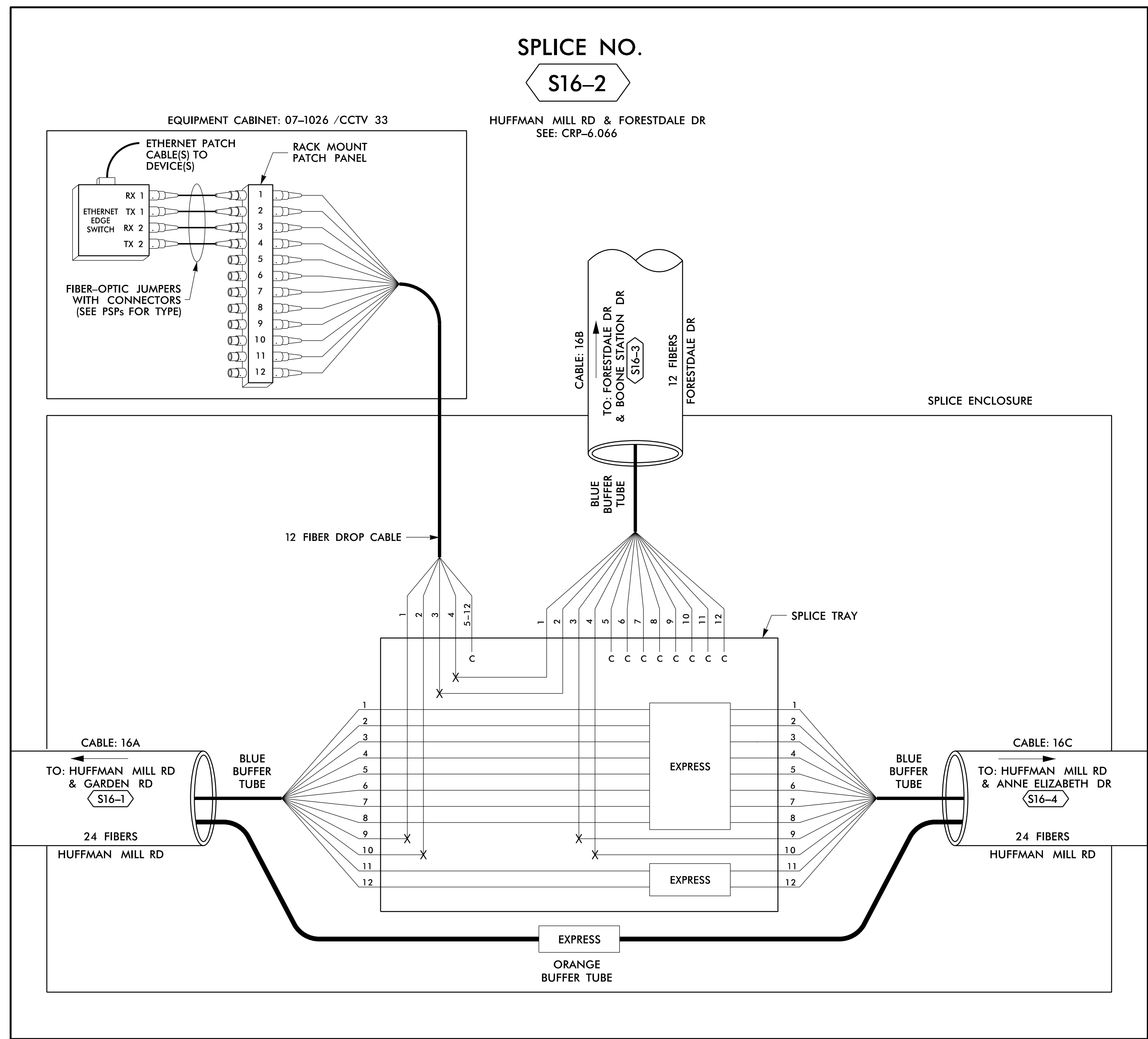

SPLICE NO.
S16-2

HUFFMAN MILL RD & FORESTDALE DR
SEE: CRP-6.066

EQUIPMENT CABINET: 07-1026 / CCTV 33

LEGEND

COLOR CODE TIA/EIA 598-B		X = FUSION SPlice INDIVIDUAL FIBER THROUGH WITHOUT CUTTING
(1) BLUE	(7) RED	EXPRESS
(2) ORANGE	(8) BLACK	EXPRESS ENTIRE BUFFER TUBE / FIBERS THROUGH WITHOUT CUTTING
(3) GREEN	(9) YELLOW	BUFFER SPlice
(4) BROWN	(10) VIOLET	SPlice ALL FIBERS IN BUFFER TUBE COLOR TO COLOR
(5) SLATE	(11) ROSE	EXISTING
(6) WHITE	(12) AQUA	EXISTING BUFFER TUBE / FIBERS DO NOT MODIFY EXISTING SPlices OR EXPRESSED FIBERS.

NOTES

- UNUSED FIBERS LEFT COILED AND STORED IN SPlice TRAY
- UNUSED BUFFER TUBES LEFT COILED AND STORED IN SPlice ENCLOSURE
- EDGE SWITCH CONFIGURATIONS ARE GENERIC. CONTRACTOR IS RESPONSIBLE FOR DETERMINING/ENSURING THE PROPER TERMINATIONS.

ATKINS 1616 EAST MILLBROOK ROAD, SUITE 160
RALEIGH, NORTH CAROLINA 27609
(919) 876-6888 NCBEEES #F-0326

DOCUMENT NOT CONSIDERED FINAL
UNLESS ALL SIGNATURES COMPLETED

Prepared for the Offices of:

 750 Greenfield Parkway, Garner, NC 27529
 SCALE: N/A

Burlington-Graham Signal System Fiber-Optic Splicing Details		Burlington & Graham	
Division 7	Alamance County		
PLAN DATE: June 2018	REVIEWED BY: HA BADGETT		
PREPARED BY: BJ SLOCUM	REVIEWED BY: DL JONES		
REVISIONS	INIT.	DATE	

SEAL

 BRADFORD J. SLOCUM
 ENGINEER
 15/2018
 DATE

14 JUN 2018 12:30
 D:\projects\proj\100056469 U-6015 B-C Sig_Sys\Task 11_Coms\F5 4_097.dgn
 S:\DCS\653 AT_LUS355433

SPLICE NO.

S16-3

FORESDALE DR & BOONE STATION DR
SEE: CRP-6.071

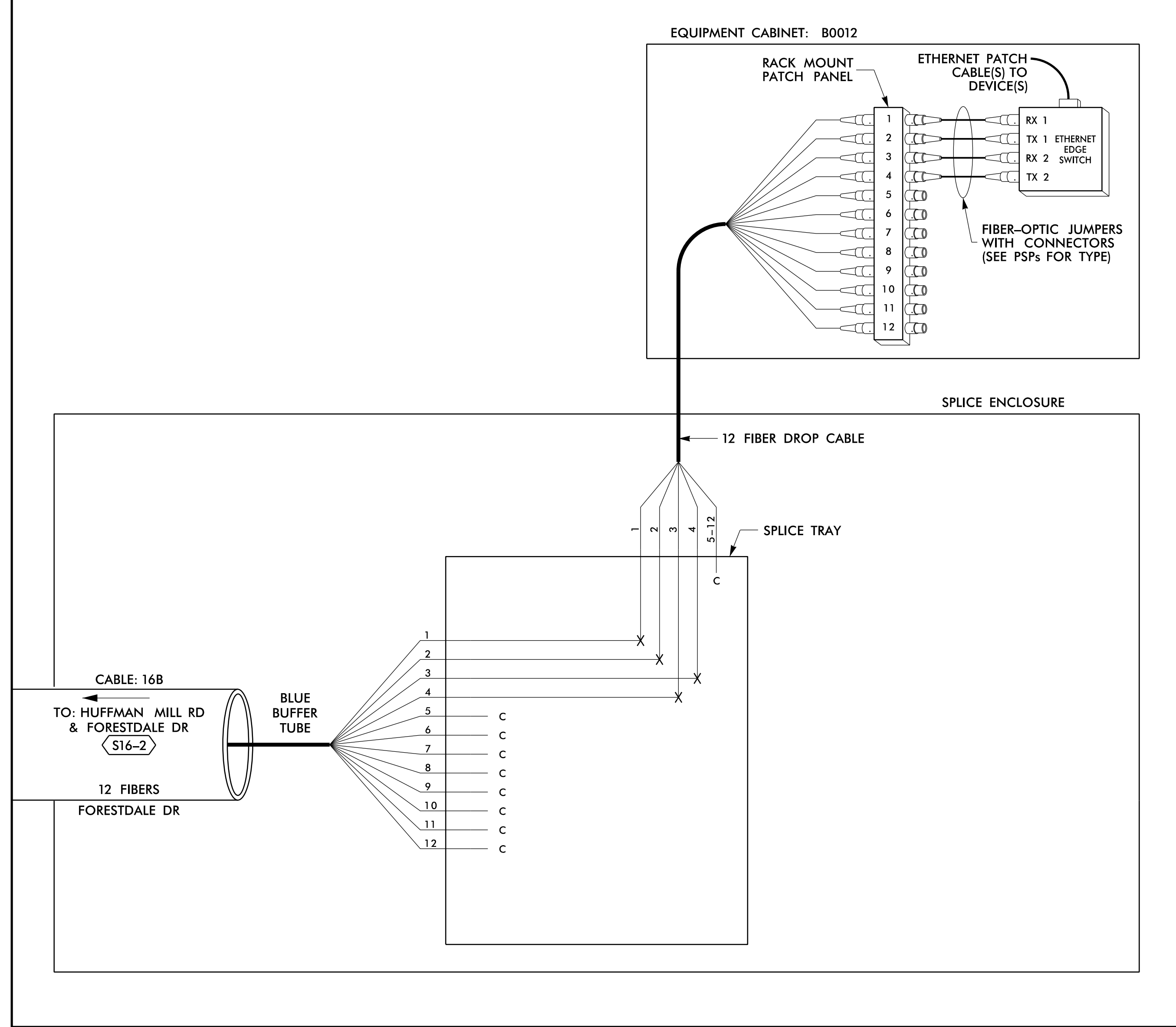

SPLICE NO.

S16-4

HUFFMAN MILL RD & ANNE ELIZABETH DR
SEE: CRP-6.067

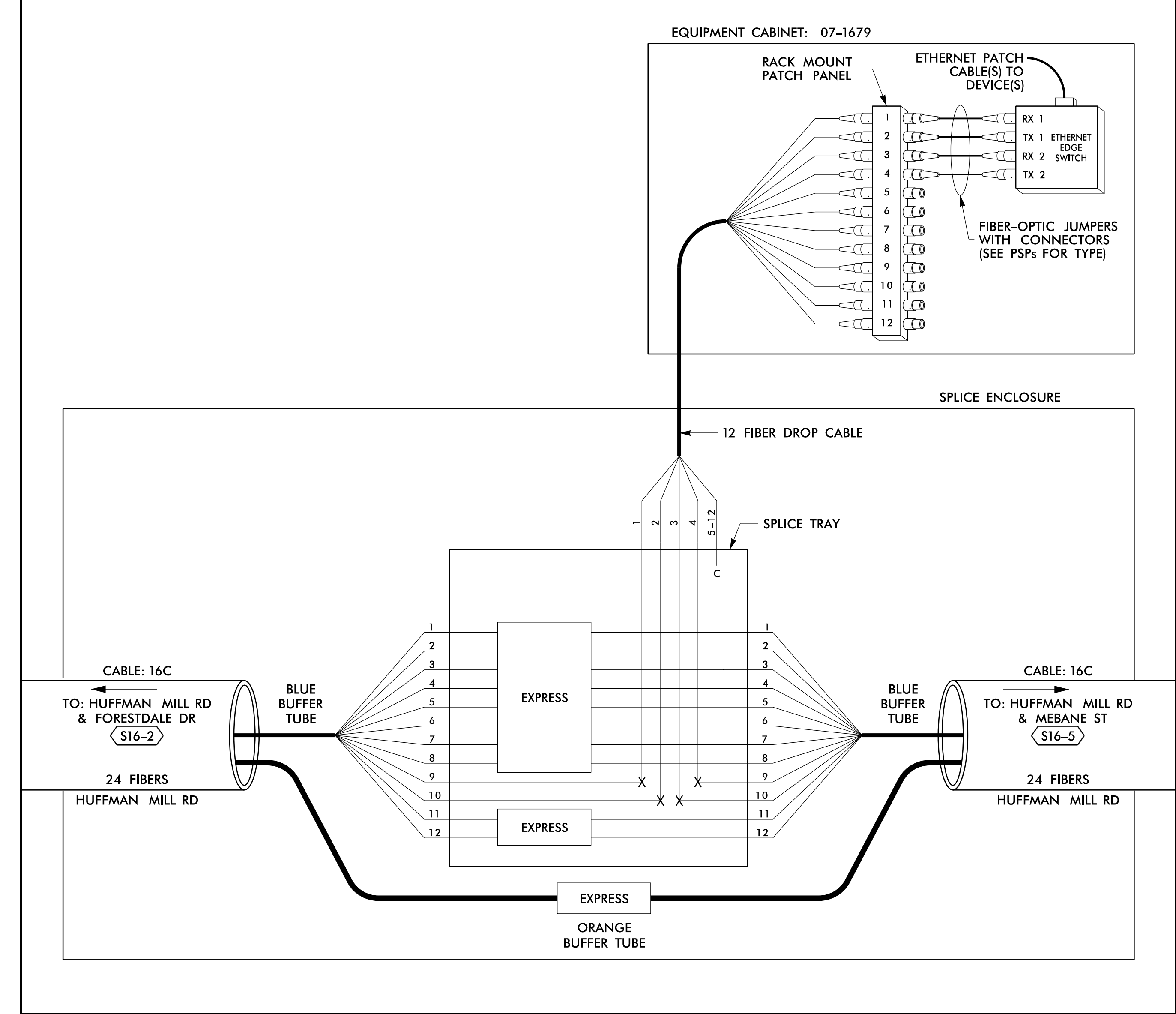

14 JUN 2018 12:30
 D:\Technical\proj\11\comms\11_Coms\Fs 4.098.dgn
 S:\033633 AT LUS355433

LEGEND

COLOR CODE TIA/EIA 598-B		X = FUSION SPlice INDIVIDUAL FIBER	EXPRESS	EXPRESS ENTIRE BUFFER TUBE / FIBERS THROUGH WITHOUT CUTTING
(1) BLUE	(7) RED	C = CAP AND SEAL	BUFFER SPlice	SPlice ALL FIBERS IN BUFFER TUBE COLOR TO COLOR
(2) ORANGE	(8) BLACK		EXISTING	EXISTING BUFFER TUBE / FIBERS DO NOT MODIFY EXISTING SPlices OR EXPRESSED FIBERS.
(3) GREEN	(9) YELLOW			
(4) BROWN	(10) VIOLET			
(5) SLATE	(11) ROSE			
(6) WHITE	(12) AQUA			

NOTES

1. UNUSED FIBERS LEFT COILED AND STORED IN SPLICE TRAY
2. UNUSED BUFFER TUBES LEFT COILED AND STORED IN SPLICE ENCLOSURE
3. EDGE SWITCH CONFIGURATIONS ARE GENERIC. CONTRACTOR IS RESPONSIBLE FOR DETERMINING/ENSURING THE PROPER TERMINATIONS.

ATKINS 1616 EAST MILLBROOK ROAD, SUITE 160
RALEIGH, NORTH CAROLINA 27609
(919) 876-6888 NCBEE# F-0326

DOCUMENT NOT CONSIDERED FINAL UNLESS ALL SIGNATURES COMPLETED

<p>750 Greenfield Parkway, Garner, NC 27529</p>	Prepared for the Offices of: NORTH CAROLINA DEPARTMENT OF TRANSPORTATION Division 7 Alameda County Burlington & Graham		
	Burlington-Graham Signal System Fiber-Optic Splicing Details		
	PLAN DATE: June 2018 PREPARED BY: BJ SLOCUM	REVIEWED BY: HA BADGETT REVIEWED BY: DL JONES	
	SCALE: N/A	REVISIONS: _____ INIT.: _____ DATE: _____	

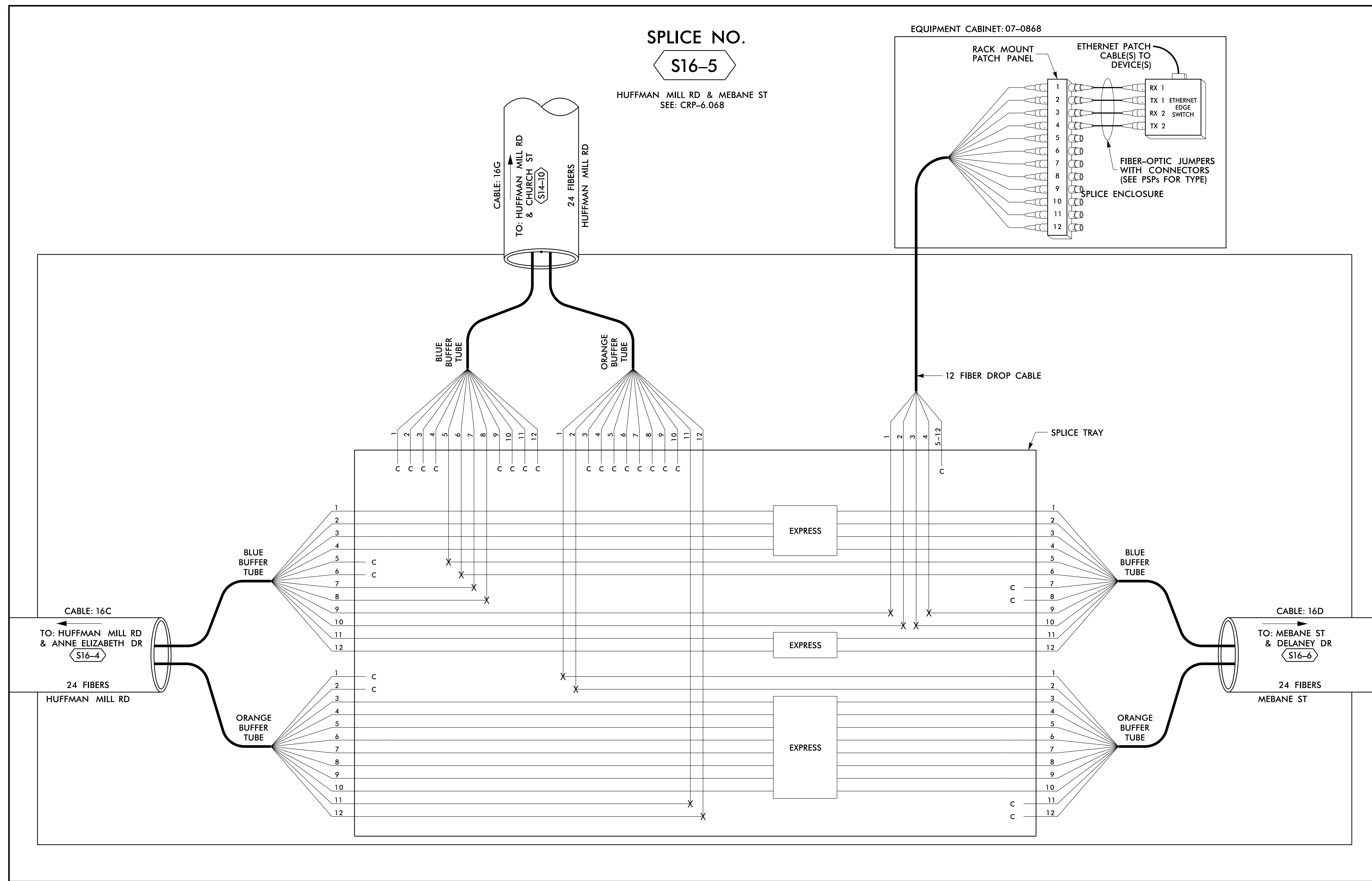

SPLICE NO.
S16-5

HUFFMAN MILL RD & MEBANE ST
SEE: CRP-6.068

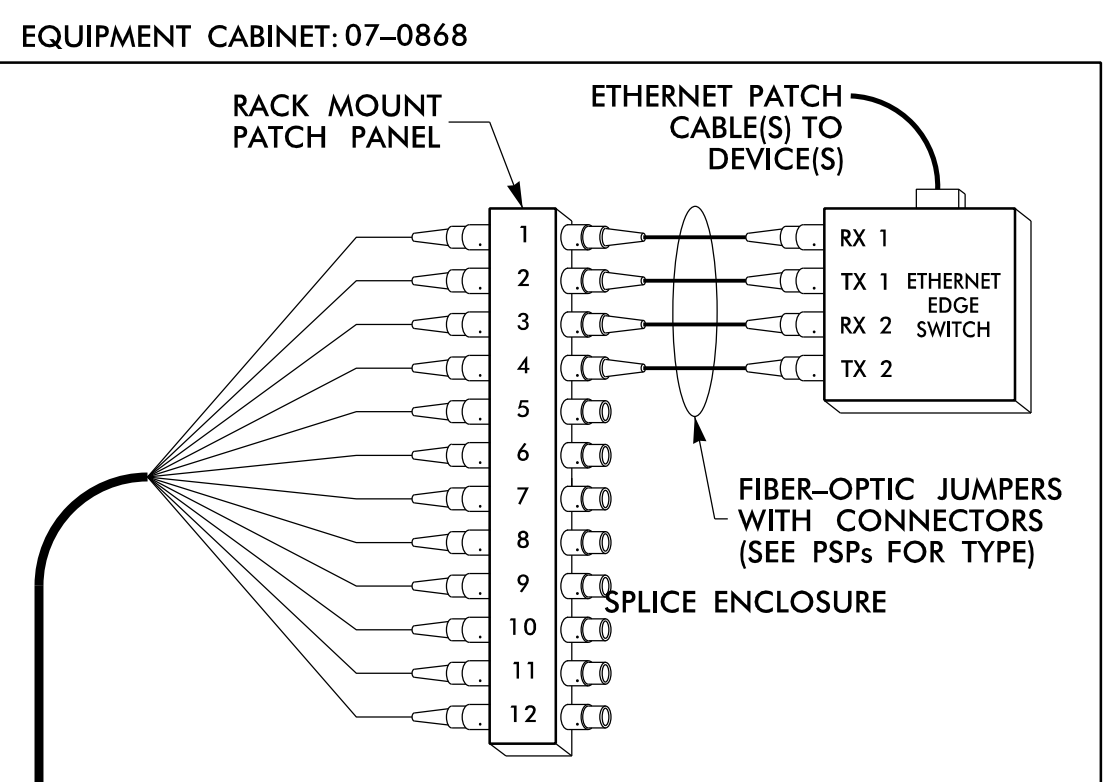

LEGEND

COLOR CODE TIA/EIA 598-B	X = FUSION SPlice INDIVIDUAL FIBER THROUGH WITHOUT CUTTING	EXPRESS	EXPRESS ENTIRE BUFFER TUBE /FIBERS
(1) BLUE (7) RED	C = CAP AND SEAL	BUFFER SPlice	SPlice ALL FIBERS IN BUFFER TUBE COLOR TO COLOR
(2) ORANGE (8) BLACK		EXISTING	EXISTING BUFFER TUBE /FIBERS DO NOT MODIFY EXISTING SPlices OR EXPRESSED FIBERS.
(3) GREEN (9) YELLOW			
(4) BROWN (10) VIOLET			
(5) SLATE (11) ROSE			
(6) WHITE (12) AQUA			

- NOTES**
- UNUSED FIBERS LEFT COILED AND STORED IN SPICE TRAY
 - UNUSED BUFFER TUBES LEFT COILED AND STORED IN SPICE ENCLOSURE
 - EDGE SWITCH CONFIGURATIONS ARE GENERIC. CONTRACTOR IS RESPONSIBLE FOR DETERMINING/ENSURING THE PROPER TERMINATIONS.

ATKINS 1616 EAST MILLBROOK ROAD, SUITE 160
RALEIGH, NORTH CAROLINA 27609
(919) 876-6888 NCBEEES #F-0326

DOCUMENT NOT CONSIDERED FINAL UNLESS ALL SIGNATURES COMPLETED

Prepared for the Offices of:

 State of North Carolina
 Department of Transportation

**Burlington-Graham Signal System
Fiber-Optic Splicing Details**

Division 7 Alamance County Burlington & Graham

PLAN DATE: June 2018	REVIEWED BY: HA BADGETT
PREPARED BY: BJ SLOCUM	REVIEWED BY: DL JONES

750 Greenfield Parkway, Garner, NC 27529
SCALE: N/A

REVISIONS	INIT.	DATE

SEAL

 BRADFORD J. SLOCUM
 ENGINEER
 15/2018
 DATE

CADD File name: FS_4.099.dgn

14 JUN 2018 12:30
 D:\projects\proj\100056469 U-6015 B-C Sig_Sys\Task 11_Coms#FS 4.099.dgn
 S:\033653 AT_LUS355433

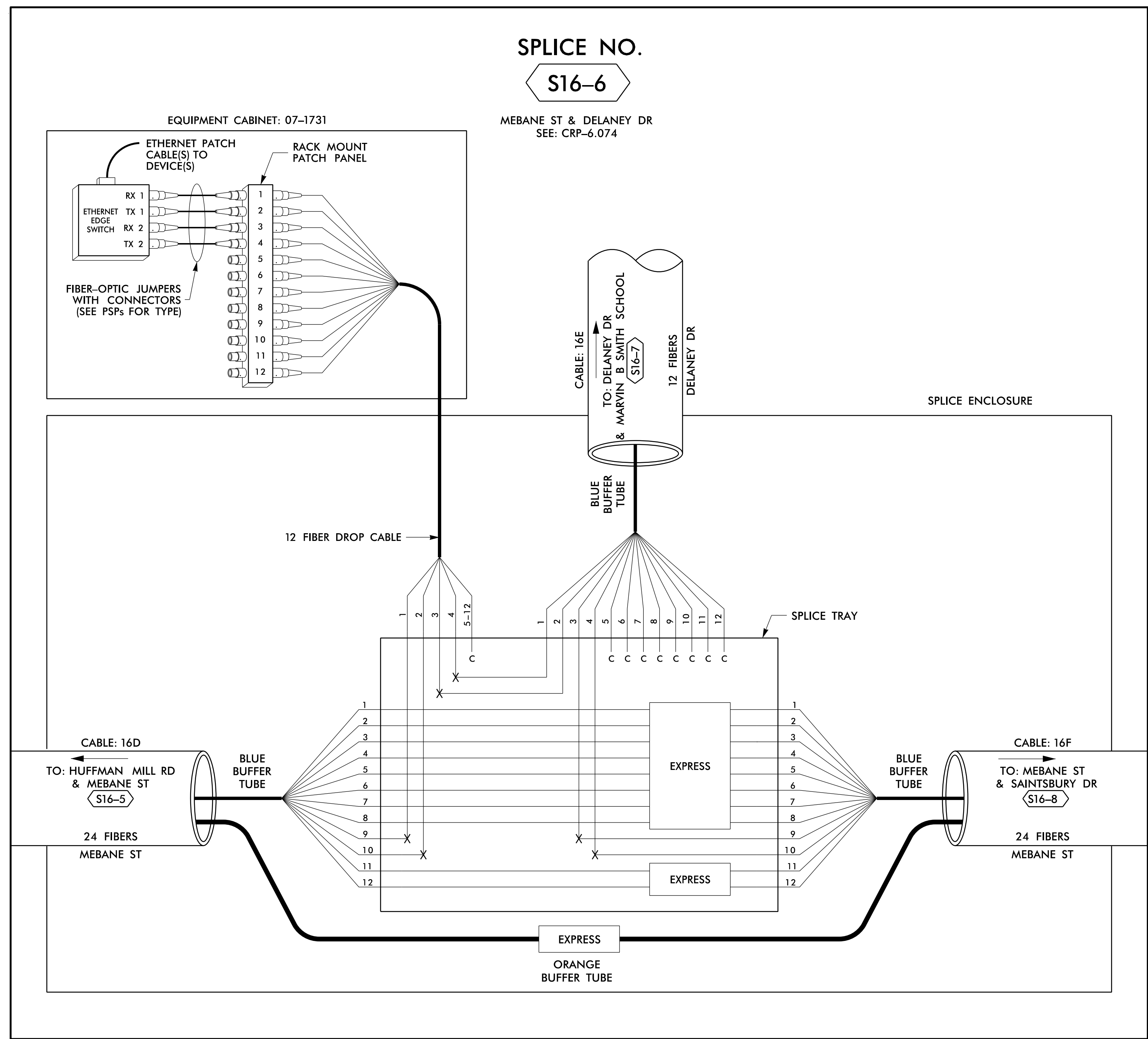

14 JUN 2018 12:30 D:\projects\proj\11\comms\11_00056469 U-6015 B-C Sig_Sys\Task 11_Comms\F_S 4_100.dgn S:\DCS\653 AT LUS355433

LEGEND

COLOR CODE TIA/EIA 598-B	X = FUSION SPlice INDIVIDUAL FIBER C = CAP AND SEAL	EXPRESS EXPRESS ENTIRE BUFFER TUBE / FIBERS THROUGH WITHOUT CUTTING
(1) BLUE (7) RED (2) ORANGE (8) BLACK (3) GREEN (9) YELLOW (4) BROWN (10) VIOLET (5) SLATE (11) ROSE (6) WHITE (12) AQUA	BUFFER SPlice SPlice ALL FIBERS IN BUFFER TUBE COLOR TO COLOR	EXISTING EXISTING BUFFER TUBE / FIBERS DO NOT MODIFY EXISTING SPlices OR EXPRESSED FIBERS.

- NOTES**
- UNUSED FIBERS LEFT COILED AND STORED IN SPlice TRAY
 - UNUSED BUFFER TUBES LEFT COILED AND STORED IN SPlice ENCLASURE
 - EDGE SWITCH CONFIGURATIONS ARE GENERIC. CONTRACTOR IS RESPONSIBLE FOR DETERMINING/ENSURING THE PROPER TERMINATIONS.

ATKINS 1616 EAST MILLBROOK ROAD, SUITE 160
RALEIGH, NORTH CAROLINA 27609
(919) 876-6888 NCBEE# F-0326

DOCUMENT NOT CONSIDERED FINAL UNLESS ALL SIGNATURES COMPLETED

<p>750 Greenfield Parkway, Garner, NC 27529</p>	<p>Burlington-Graham Signal System Fiber-Optic Splicing Details</p>		
	<p>Division 7 Alamance County Burlington & Graham</p>	<p>PLAN DATE: June 2018 REVIEWED BY: HA BADGETT</p>	
<p>SCALE: N/A</p>	<p>PREPARED BY: BJ SLOCUM</p>	<p>REVIEWED BY: DL JONES</p>	<p>DATE: 15/2018</p>
<p>REVISIONS</p>		<p>INIT.</p>	<p>DATE</p>
<p>CADD File name: FS 4.100.dgn</p>			

SPLICE NO.

S17-1

I-40 WB /I-85 SB &
UNIVERSITY DR
SEE: CRP-6.051

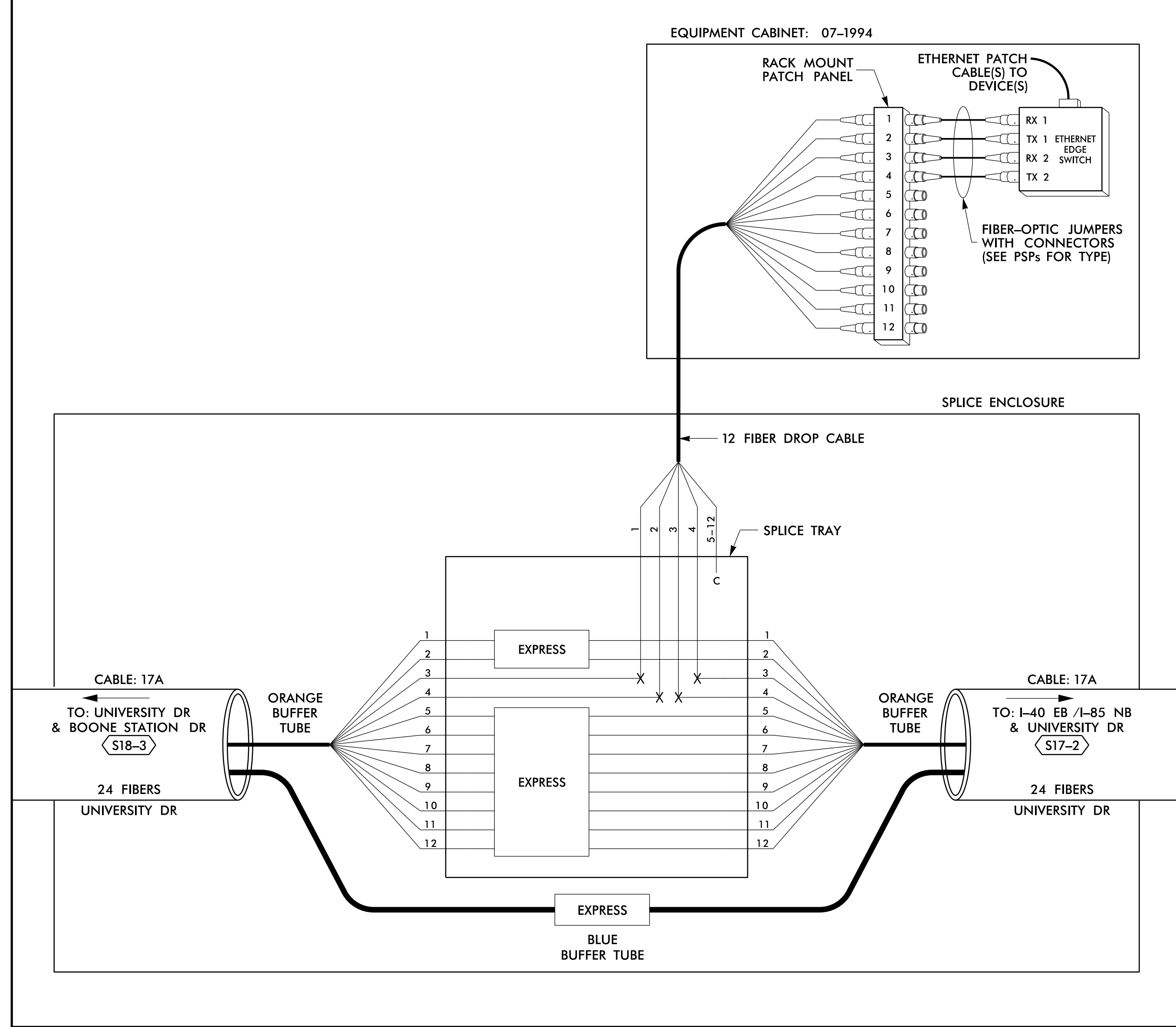

SPLICE NO.

S17-2

I-40 EB /I-85 NB &
UNIVERSITY DR
SEE: CRP-6.051

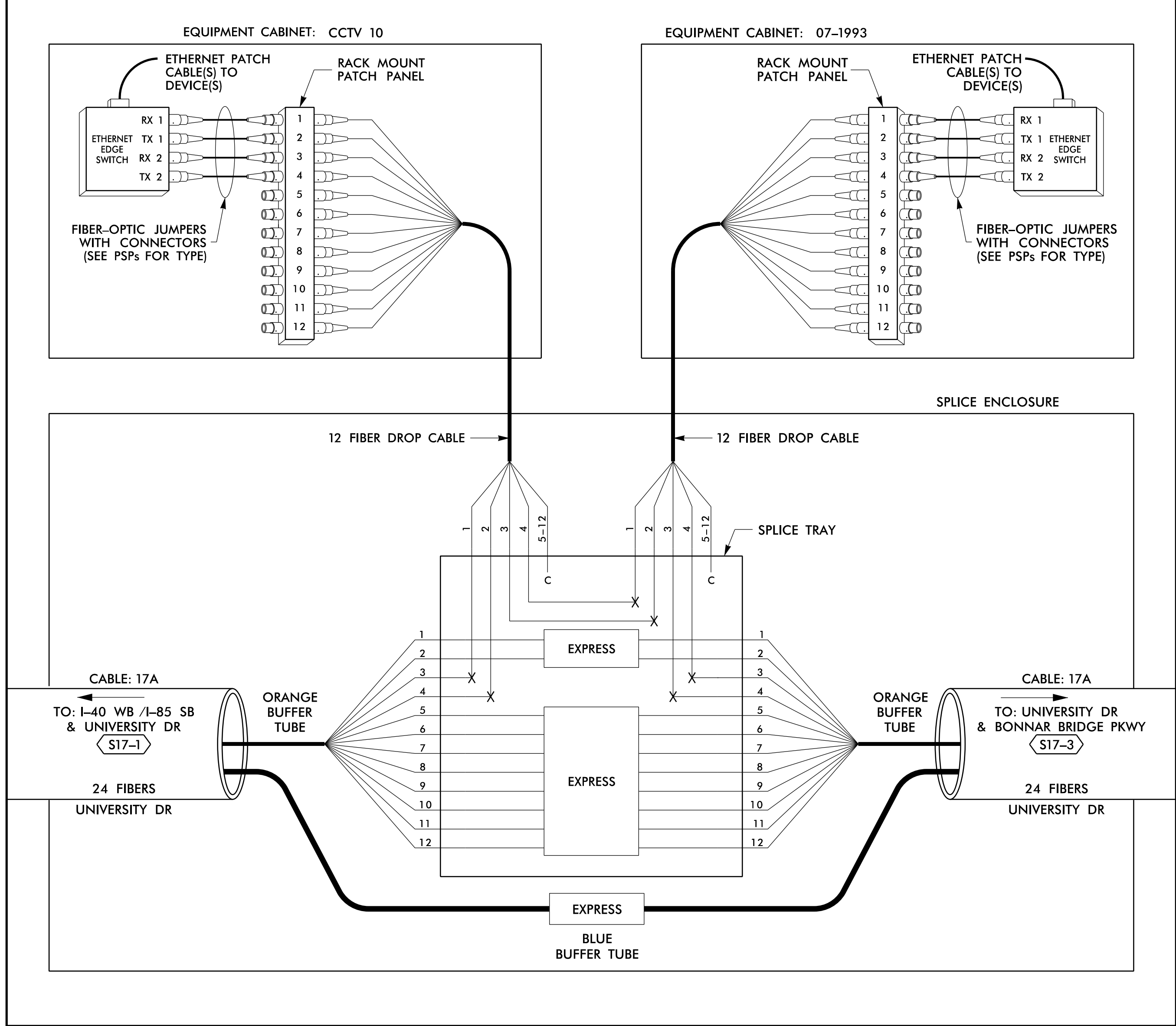

14 JUN 2018 12:30
 D:\projects\proj\100056469 U-6015 B-C Sig Sys\Task 11_Comm\F4_102.dgn
 S:\03563 AT_LUS355433

LEGEND

COLOR CODE TIA/EIA 598-B		X = FUSION SPLICE INDIVIDUAL FIBER C = CAP AND SEAL
(1) BLUE	(7) RED	EXPRESS
(2) ORANGE	(8) BLACK	EXPRESS ENTIRE BUFFER TUBE / FIBERS THROUGH WITHOUT CUTTING
(3) GREEN	(9) YELLOW	BUFFER SPLICE
(4) BROWN	(10) VIOLET	BUFFER SPLICE
(5) SLATE	(11) ROSE	EXISTING
(6) WHITE	(12) AQUA	EXISTING
SPLICE ALL FIBERS IN BUFFER TUBE COLOR TO COLOR EXISTING BUFFER TUBE / FIBERS DO NOT MODIFY EXISTING SPLICES OR EXPRESSED FIBERS.		

NOTES

- UNUSED FIBERS LEFT COILED AND STORED IN SPLICE TRAY
- UNUSED BUFFER TUBES LEFT COILED AND STORED IN SPLICE ENCLOSURE
- EDGE SWITCH CONFIGURATIONS ARE GENERIC. CONTRACTOR IS RESPONSIBLE FOR DETERMINING/ENSURING THE PROPER TERMINATIONS.

ATKINS 1616 EAST MILLBROOK ROAD, SUITE 160
RALEIGH, NORTH CAROLINA 27609
(919) 876-6888 NCBEE# 0326

DOCUMENT NOT CONSIDERED FINAL UNLESS ALL SIGNATURES COMPLETED

Prepared for the Offices of: 750 Greenfield Parkway, Garner, NC 27529 SCALE: N/A	Burlington-Graham Signal System Fiber-Optic Splicing Details		SEAL NORTH CAROLINA PROFESSIONAL ENGINEER SEAL 040877 BRADFORD J. SLOCUM 15/2018 DATE
	Division 7 Alamance County PLAN DATE: June 2018	Burlington & Graham REVIEWED BY: HA BADGETT	
	PREPARED BY: BJ SLOCUM	REVIEWED BY: DL JONES	
	REVISIONS	INIT. DATE	

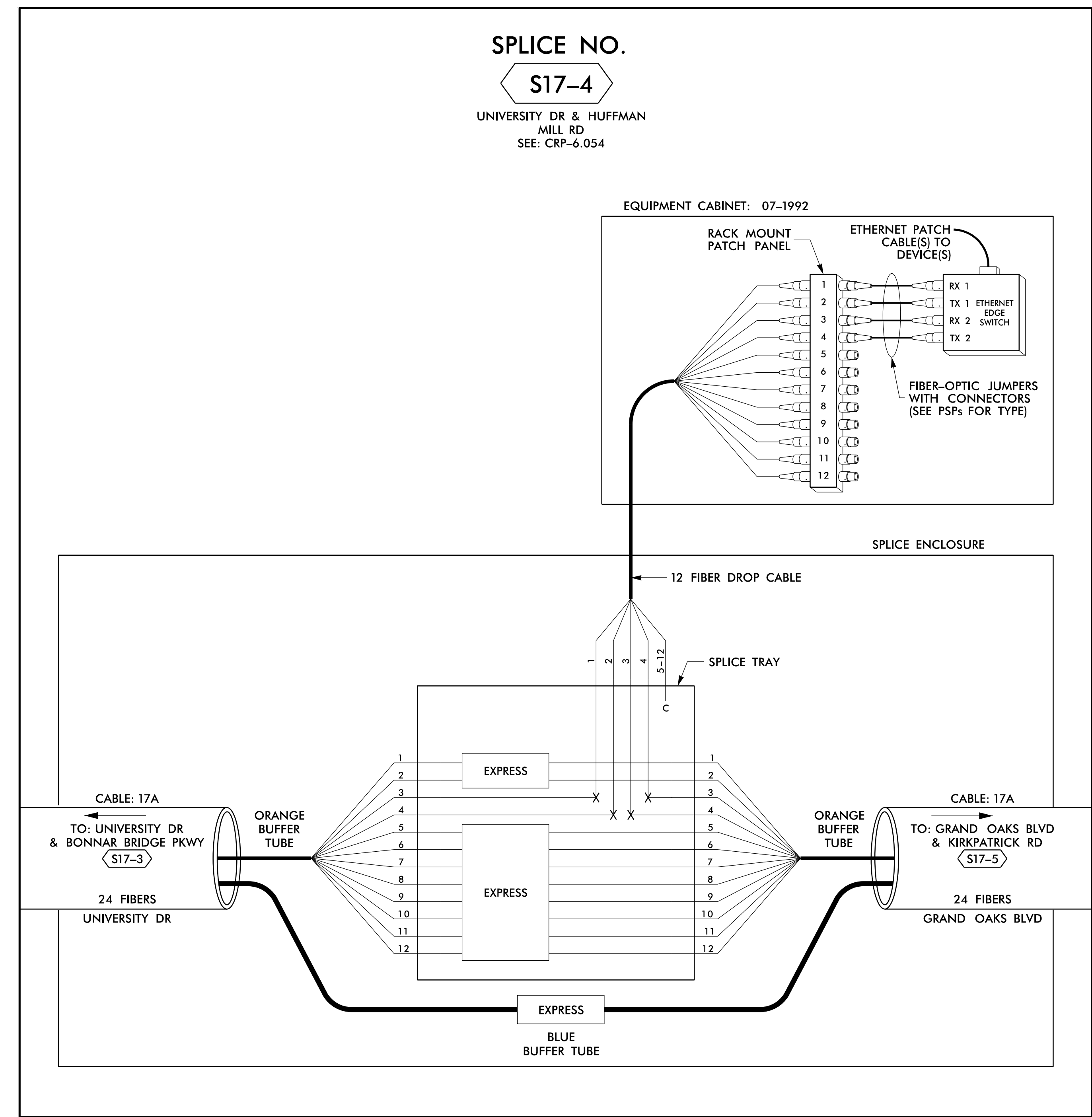
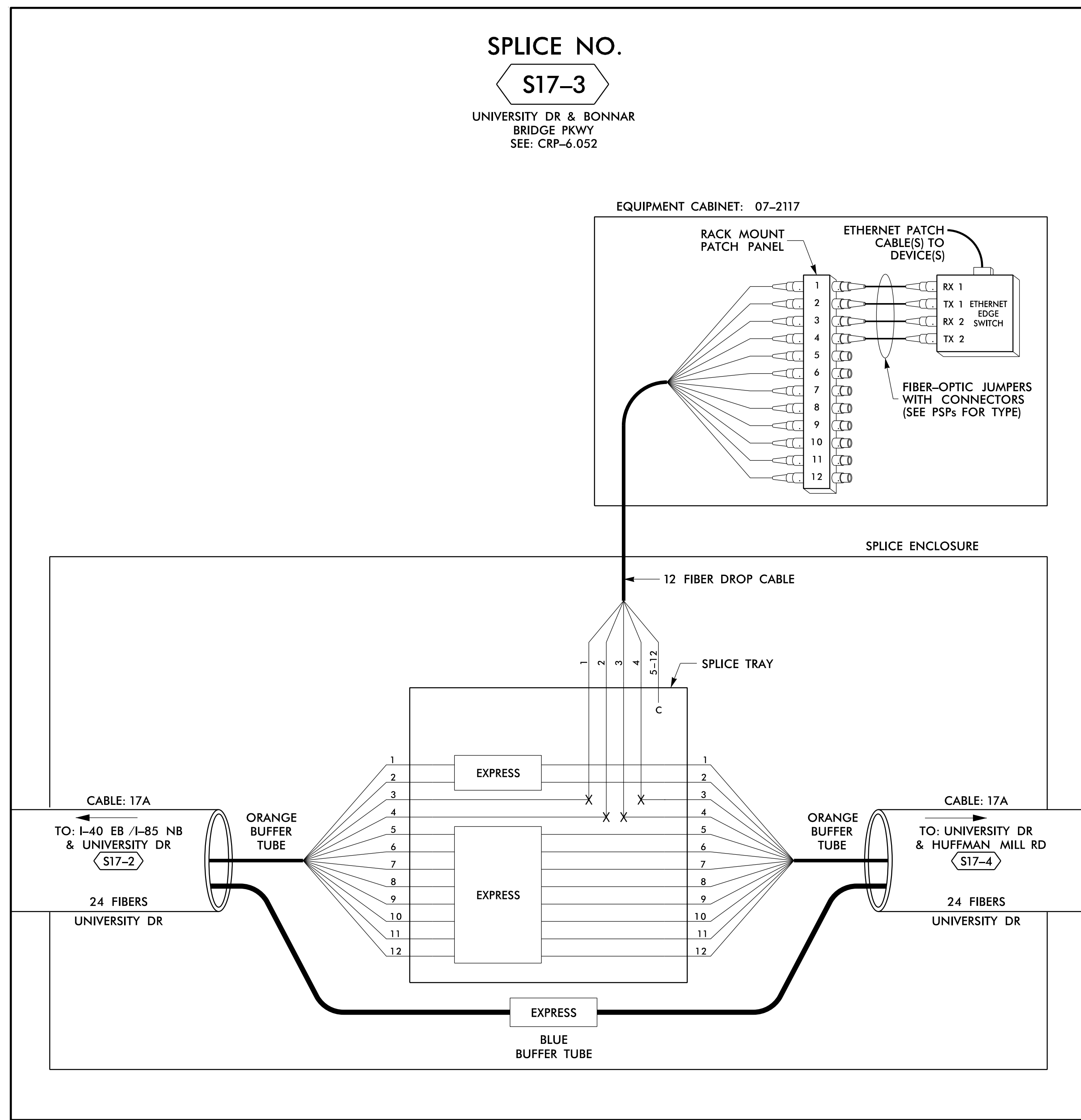

14 JUN 2018 12:30
 D:\projects\proj\11\comms\11\comms\F 4.103.dgn
 S:\033633 AT_LUS355433

LEGEND

COLOR CODE TIA/EIA 598-B	X = FUSION SPlice INDIVIDUAL FIBER	EXPRESS	EXPRESS ENTIRE BUFFER TUBE / FIBERS THROUGH WITHOUT CUTTING
(1) BLUE	(8) BLACK	BUFFER SPlice	SPlice ALL FIBERS IN BUFFER TUBE COLOR TO COLOR
(2) ORANGE	(9) YELLOW	EXISTING	EXISTING BUFFER TUBE / FIBERS DO NOT MODIFY EXISTING SPlices OR EXPRESSED FIBERS.
(3) GREEN	(10) VIOLET		
(4) BROWN	(11) ROSE		
(5) SLATE	(12) AQUA		
(6) WHITE			

- NOTES**
- UNUSED FIBERS LEFT COILED AND STORED IN SPLICE TRAY
 - UNUSED BUFFER TUBES LEFT COILED AND STORED IN SPLICE ENCLOSURE
 - EDGE SWITCH CONFIGURATIONS ARE GENERIC. CONTRACTOR IS RESPONSIBLE FOR DETERMINING/ENSURING THE PROPER TERMINATIONS.

ATKINS 1616 EAST MILLBROOK ROAD, SUITE 160
RALEIGH, NORTH CAROLINA 27609
(919) 876-6888 NCBEE# F-0326

DOCUMENT NOT CONSIDERED FINAL UNLESS ALL SIGNATURES COMPLETED

	Burlington-Graham Signal System Fiber-Optic Splicing Details		
	Division 7 Alamance County Burlington & Graham		
750 Greenfield Parkway, Garner, NC 27529	SCALE: N/A	PLAN DATE: June 2018 PREPARED BY: BJ SLOCUM REVISIONS: _____ INIT.: _____ DATE: _____	REVIEWED BY: HA BADGETT REVIEWED BY: DL JONES DATE: _____

CADD File name: FS 4.103.dgn

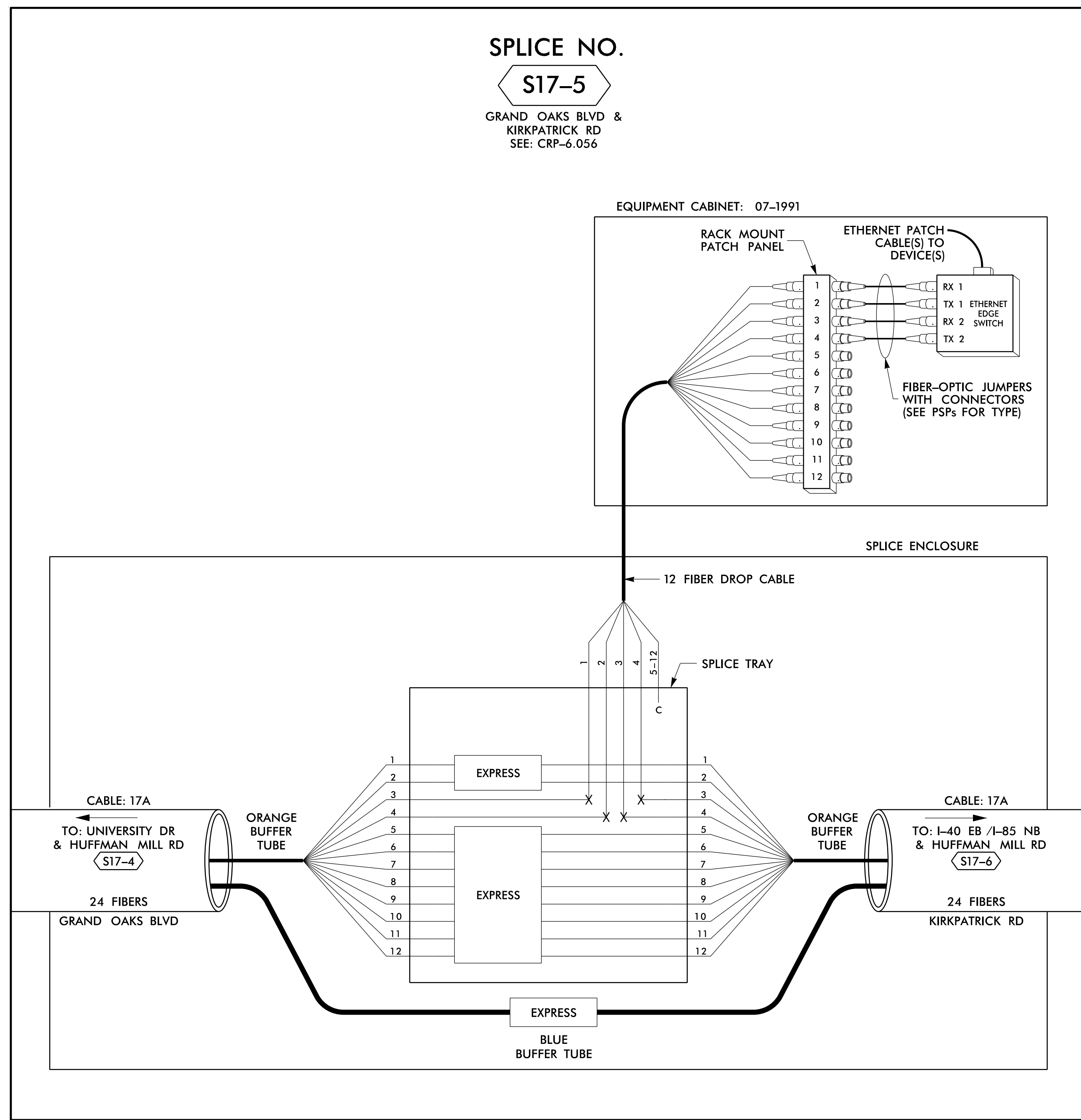

14-JUN-2018 12:30
 D:\Technical\proj\10056469 U-6015 B-C Sig Sys\Task 11_Coms\Fs 4.104.dgn
 S:\DCS\653 AT_LUS355433

LEGEND

COLOR CODE TIA/EIA 598-B		X = FUSION SPlice INDIVIDUAL FIBER C = CAP AND SEAL
(1) BLUE	(7) RED	EXPRESS
(2) ORANGE	(8) BLACK	EXPRESS ENTIRE BUFFER TUBE / FIBERS THROUGH WITHOUT CUTTING
(3) GREEN	(9) YELLOW	BUFFER SPlice
(4) BROWN	(10) VIOLET	SPlice ALL FIBERS IN BUFFER TUBE COLOR TO COLOR
(5) SLATE	(11) ROSE	EXISTING
(6) WHITE	(12) AQUA	EXISTING BUFFER TUBE / FIBERS DO NOT MODIFY EXISTING SPlices OR EXPRESSED FIBERS.

NOTES

- UNUSED FIBERS LEFT COILED AND STORED IN SPLICE TRAY
- UNUSED BUFFER TUBES LEFT COILED AND STORED IN SPLICE ENCLOSURE
- EDGE SWITCH CONFIGURATIONS ARE GENERIC. CONTRACTOR IS RESPONSIBLE FOR DETERMINING/ENSURING THE PROPER TERMINATIONS.

ATKINS 1616 EAST MILLBROOK ROAD, SUITE 160
 RALEIGH, NORTH CAROLINA 27609
 (919) 876-6888 NCBEEES #F-0326

DOCUMENT NOT CONSIDERED FINAL UNLESS ALL SIGNATURES COMPLETED

Prepared for the Offices of: 750 Greenfield Parkway, Garner, NC 27529	Burlington-Graham Signal System Fiber-Optic Splicing Details		SEAL NORTH CAROLINA PROFESSIONAL ENGINEER SEAL 040877 BRADFORD J. SLOCUM 15/2018 DATE
	Division 7 Alamance County PLAN DATE: June 2018 PREPARED BY: BJ SLOCUM	Burlington & Graham REVIEWED BY: HA BADGETT REVIEWED BY: DL JONES	
REVISIONS INIT. DATE			

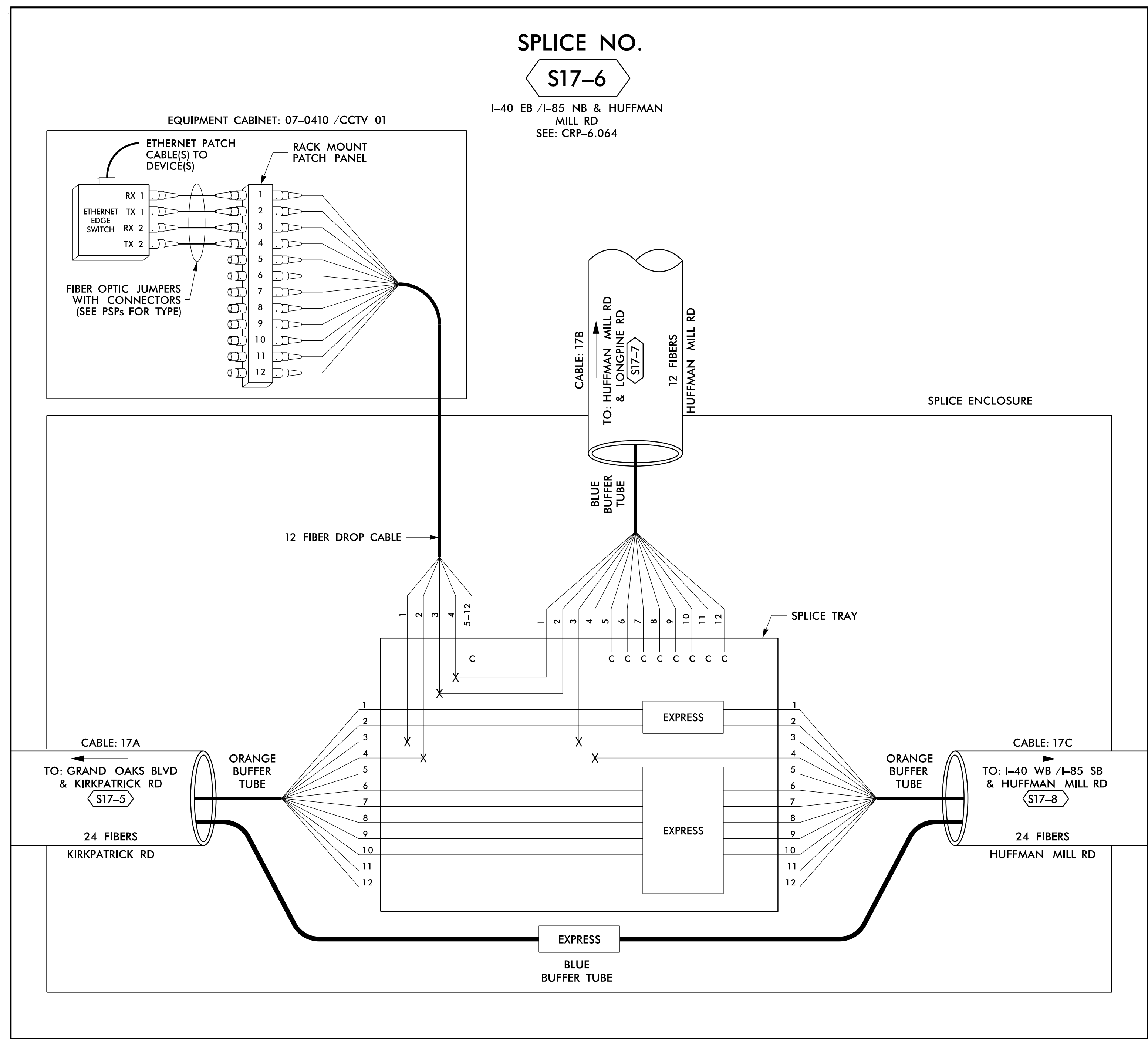

14 JUN 2018 12:31
 D:\projects\proj\100056469 U-6015 B-C Sig Sys\Task 11_Coms\F4_105.dgn
 S:\035633 AT_LUS355433

COLOR CODE		LEGEND	
(1) BLUE	(7) RED	EXPRESS	EXPRESS ENTIRE BUFFER TUBE / FIBERS THROUGH WITHOUT CUTTING
(2) ORANGE	(8) BLACK	BUFFER SPlice	SPLICE ALL FIBERS IN BUFFER TUBE COLOR TO COLOR
(3) GREEN	(9) YELLOW	EXISTING	EXISTING BUFFER TUBE / FIBERS DO NOT MODIFY EXISTING SPLICES OR EXPRESSED FIBERS.
(4) BROWN	(10) VIOLET		
(5) SLATE	(11) ROSE		
(6) WHITE	(12) AQUA		

- NOTES**
- UNUSED FIBERS LEFT COILED AND STORED IN SPLICE TRAY
 - UNUSED BUFFER TUBES LEFT COILED AND STORED IN SPLICE ENCLOSURE
 - EDGE SWITCH CONFIGURATIONS ARE GENERIC. CONTRACTOR IS RESPONSIBLE FOR DETERMINING/ENSURING THE PROPER TERMINATIONS.

750 Greenfield Parkway, Garner, NC 27529

1616 EAST MILLBROOK ROAD, SUITE 160
RALEIGH, NORTH CAROLINA 27609
(919) 876-6888 NCBES #F-0326

**DOCUMENT NOT CONSIDERED FINAL
UNLESS ALL SIGNATURES COMPLETED**

Prepared for the Offices of:

 DEPARTMENT OF TRANSPORTATION
 Division 7
 SCALE: N/A

**Burlington-Graham Signal System
Fiber-Optic Splicing Details**

Division 7 Alamance County Burlington & Graham

PLAN DATE: June 2018	REVIEWED BY: HA BADGETT
PREPARED BY: BJ SLOCUM	REVIEWED BY: DL JONES

REVISIONS	INIT.	DATE

SEAL

 BRADFORD J. SLOCUM
 ENGINEER
 15/2018
 DATE
 CADD File name: FS 4.105.dgn

SPLICE NO.

S17-7

HUFFMAN MILL RD &
LONGPINE RD
SEE: CRP-6.063

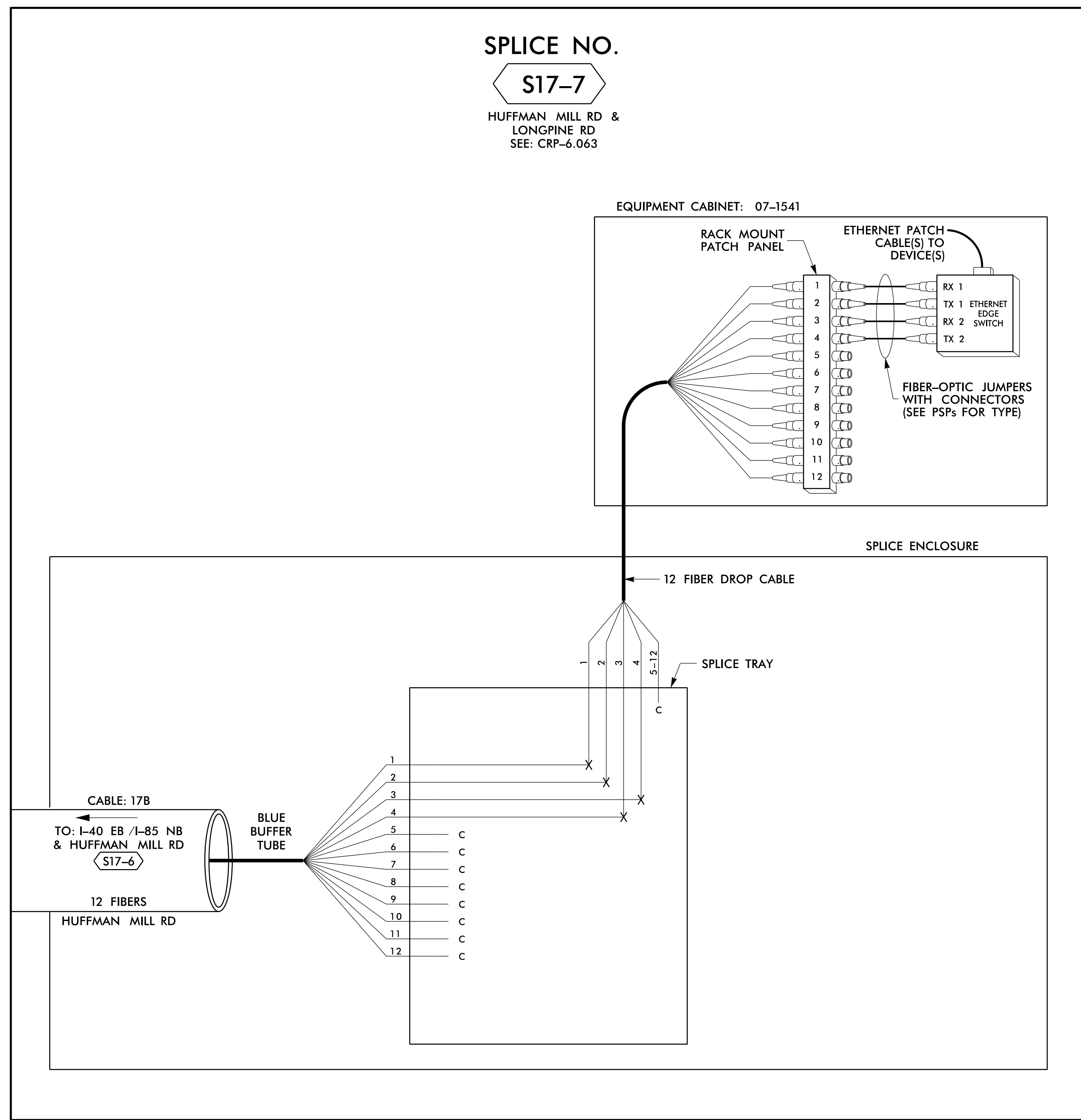

LEGEND

COLOR CODE TIA/EIA 598-B		X = FUSION SPlice INDIVIDUAL FIBER
(1) BLUE	(7) RED	EXPRESS ENTIRE BUFFER TUBE / FIBERS THROUGH WITHOUT CUTTING
(2) ORANGE	(8) BLACK	EXPRESS
(3) GREEN	(9) YELLOW	BUFFER SPlice
(4) BROWN	(10) VIOLET	SPlice ALL FIBERS IN BUFFER TUBE COLOR TO COLOR
(5) SLATE	(11) ROSE	EXISTING BUFFER TUBE / FIBERS. DO NOT MODIFY EXISTING SPlices OR EXPRESSED FIBERS.
(6) WHITE	(12) AQUA	EXISTING
		C = CAP AND SEAL

NOTES

- UNUSED FIBERS LEFT COILED AND STORED IN SPLICE TRAY
- UNUSED BUFFER TUBES LEFT COILED AND STORED IN SPLICE ENCLOSURE
- EDGE SWITCH CONFIGURATIONS ARE GENERIC. CONTRACTOR IS RESPONSIBLE FOR DETERMINING/ENSURING THE PROPER TERMINATIONS.

14 JUN 2018 12:31
 D:\Technical\Projects\U-6015 B-C Sig Sys\Task 11_Comms\F S 4.106.dgn
 S:\DCS\653 AT_LUS355433

ATKINS 1616 EAST MILLBROOK ROAD, SUITE 160
RALEIGH, NORTH CAROLINA 27609
(919) 876-6888 NCBEEES #F-0326

DOCUMENT NOT CONSIDERED FINAL UNLESS ALL SIGNATURES COMPLETED

<p>Prepared for the Offices of: NORTH CAROLINA DEPARTMENT OF TRANSPORTATION 750 Greenfield Parkway, Garner, NC 27529</p>	<p>Burlington-Graham Signal System Fiber-Optic Splicing Details</p> <p>Division 7 Alamance County Burlington & Graham</p>		<p>SEAL NORTH CAROLINA PROFESSIONAL ENGINEER SEAL 040877 BRADFORD J. SLOCUM 15/2018</p>				
	<p>PLAN DATE: June 2018</p> <p>PREPARED BY: BJ SLOCUM</p>	<p>REVIEWED BY: HA BADGETT</p> <p>REVIEWED BY: DL JONES</p>					
<p>SCALE N/A</p>	<p>REVISIONS</p> <table border="1"> <tr> <th>INIT.</th> <th>DATE</th> </tr> <tr> <td> </td> <td> </td> </tr> </table>	INIT.	DATE			<p>DATE</p>	<p>DATE</p>
INIT.	DATE						

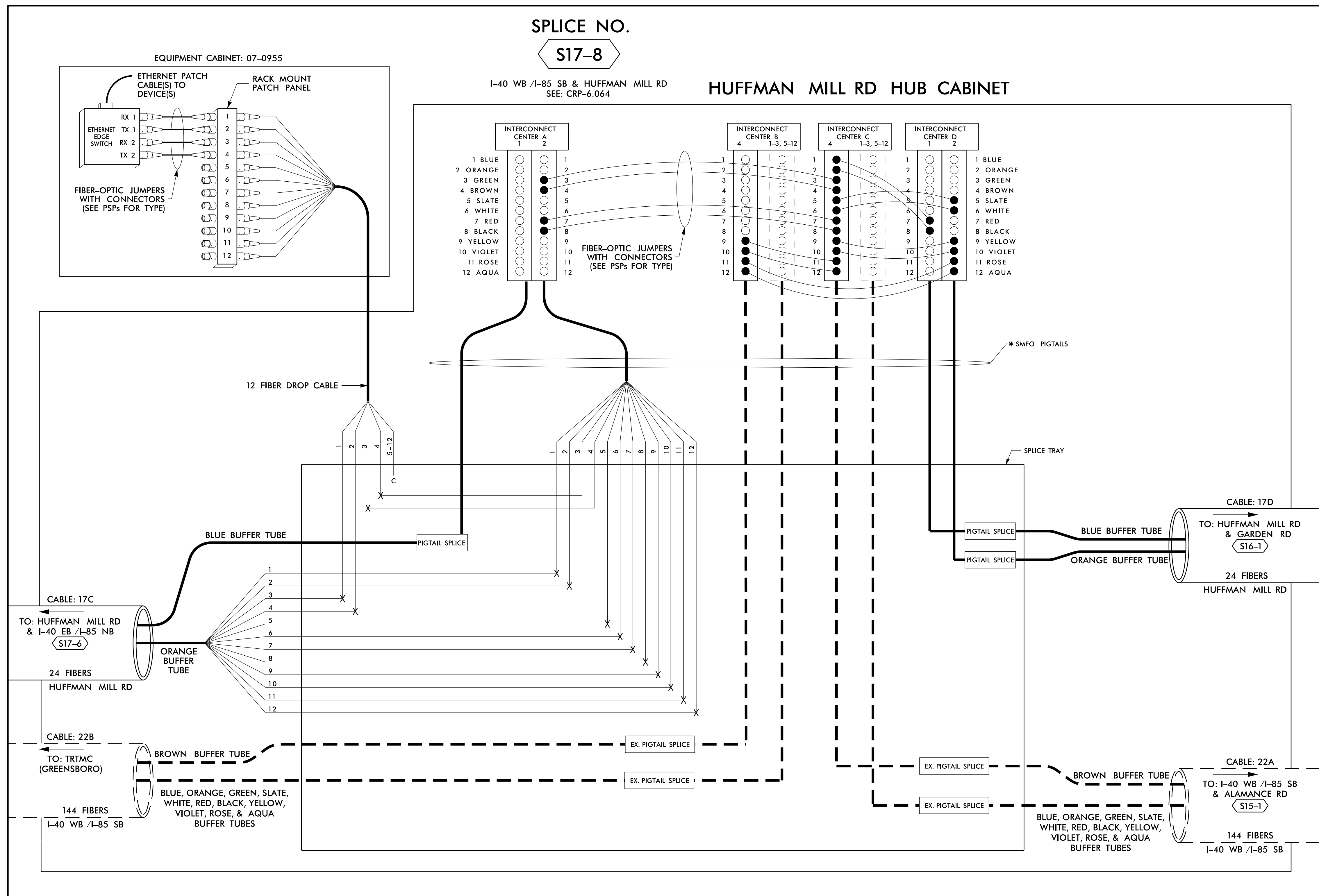

INTERCONNECT CENTER A (CABLE 17C)	INTERCONNECT CENTER B (CABLE 22B)
SLOT 1 (BLUE BUFFER TUBE)	SLOT 4 (BROWN BUFFER TUBE)
1 BLUE DARK	1 BLUE DARK
2 ORANGE DARK	2 ORANGE DARK
3 GREEN DARK	3 GREEN DARK
4 BROWN DARK	4 BROWN DARK
5 SLATE DARK	5 SLATE DARK
6 WHITE DARK	6 WHITE DARK
7 RED DARK	7 RED DARK
8 BLACK DARK	8 BLACK DARK
9 YELLOW DARK	9 YELLOW RING 22+ RX
10 VIOLET DARK	10 VIOLET RING 22+ TX
11 ROSE DARK	11 ROSE RING 22 TX
12 AQUA DARK	12 AQUA RING 22 RX
SLOT 2 (ORANGE BUFFER TUBE)	SLOTS 1-3, 5-12 (ALL OTHER BUFFER TUBES)
1 BLUE DARK	EXISTING TERMINATIONS AND CONNECTIONS TO REMAIN
2 ORANGE DARK	
3 GREEN RING 17 RX	
4 BROWN RING 17 TX	
5 SLATE DARK	
6 WHITE DARK	
7 RED RING 19 RX	
8 BLACK RING 19 TX	
9 YELLOW DARK	
10 VIOLET DARK	
11 ROSE DARK	
12 AQUA DARK	
INTERCONNECT CENTER C (CABLE 22A)	INTERCONNECT CENTER D (CABLE 17D)
SLOT 4 (BROWN BUFFER TUBE)	SLOT 1 (BLUE BUFFER TUBE)
1 BLUE RING 15 TX	1 BLUE DARK
2 ORANGE RING 15 RX	2 ORANGE DARK
3 GREEN RING 17 TX	3 GREEN DARK
4 BROWN RING 17 RX	4 BROWN DARK
5 SLATE RING 18 TX	5 SLATE RING 18 RX
6 WHITE RING 18 RX	6 WHITE RING 18 TX
7 RED RING 19 TX	7 RED RING 15 RX
8 BLACK RING 19 RX	8 BLACK RING 15 TX
9 YELLOW RING 20 TX	9 YELLOW DARK
10 VIOLET RING 20 RX	10 VIOLET DARK
11 ROSE RING 22 TX	11 ROSE RING 20 TX
12 AQUA RING 22 RX	12 AQUA RING 22 TX
SLOTS 1-3, 5-12 (ALL OTHER BUFFER TUBES)	SLOT 2 (ORANGE BUFFER TUBE)
EXISTING TERMINATIONS AND CONNECTIONS TO REMAIN	1 BLUE DARK
	2 ORANGE DARK
	3 GREEN DARK
	4 BROWN DARK
	5 SLATE RING 18 RX
	6 WHITE RING 18 TX
	7 RED DARK
	8 BLACK DARK
	9 YELLOW RING 20 RX
	10 VIOLET RING 20 TX
	11 ROSE RING 22 TX
	12 AQUA RING 22 TX

* SMFO PIGTAILS TO BE SPLICED TO BUFFER TUBES COLOR TO COLOR.

LEGEND

EXPRESS	EXPRESS ENTIRE BUFFER TUBE /FIBERS THROUGH WITHOUT CUTTING
BUFFER SPLICE	SPLICE ALL FIBERS IN BUFFER TUBE COLOR TO COLOR
EXISTING	EXISTING BUFFER TUBE /FIBERS DO NOT MODIFY EXISTING SPLICES OR EXPRESSED FIBERS.

X = FUSION SPLICE INDIVIDUAL FIBER
C = CAP AND SEAL

- NOTES**
- UNUSED FIBERS LEFT COILED AND STORED IN SPLICE TRAY
 - UNUSED BUFFER TUBES LEFT COILED AND STORED IN SPLICE ENCLOSURE
 - EDGE SWITCH CONFIGURATIONS ARE GENERIC. CONTRACTOR IS RESPONSIBLE FOR DETERMINING/ENSURING THE PROPER TERMINATIONS.

ATKINS 1616 EAST MILLBROOK ROAD, SUITE 160
RALEIGH, NORTH CAROLINA 27609
(919) 876-6888 NCBEEES #F-0326

DOCUMENT NOT CONSIDERED FINAL UNLESS ALL SIGNATURES COMPLETED

Prepared for the Offices of:
NORTH CAROLINA DEPARTMENT OF TRANSPORTATION
Division 7 Alameda County Burlington & Graham

**Burlington-Graham Signal System
Fiber-Optic Splicing Details**

PLAN DATE: June 2018 REVIEWED BY: HA BADGETT
PREPARED BY: BJ SLOCUM REVIEWED BY: DL JONES

750 Greenfield Parkway, Garner, NC 27529
SCALE: N/A

SEAL
NORTH CAROLINA PROFESSIONAL ENGINEER
SEAL 040877
BRAD F. SLOCUM
15/2018
DATE

DocuSign Envelope ID: 0FE85FC2-54CD-4048-94C3-548ADCEC8A06
CADD File name: FS_4.107.dgn

14 JUN 2018 12:31
D:\projects\atkins\tr\off\c\cur\100056469 U-6015 B-C Sig Sys\Task 11_Comm\FS 4.107.dgn
S:\03\653 AT_LUS355433

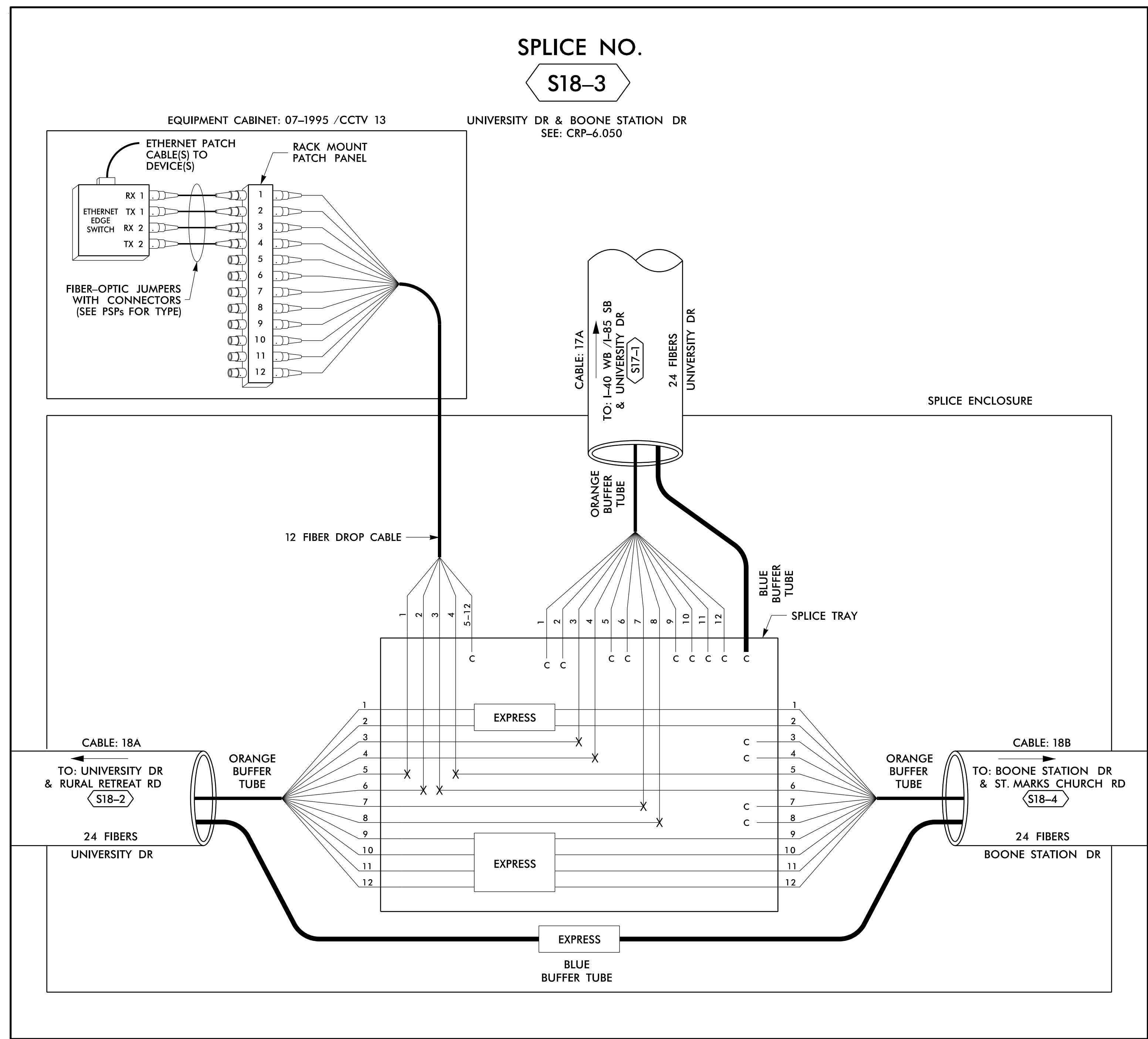

14-JUN-2018 12:31
 D:\projects\proj\11\comms\11\comms\Fs 4.109.dgn
 S:\033653 AT LUS355433

COLOR CODE		LEGEND	
(1) BLUE	(7) RED	EXPRESS	EXPRESS ENTIRE BUFFER TUBE /FIBERS THROUGH WITHOUT CUTTING
(2) ORANGE	(8) BLACK	BUFFER SPlice	SPLICE ALL FIBERS IN BUFFER TUBE COLOR TO COLOR
(3) GREEN	(9) YELLOW	EXISTING	EXISTING BUFFER TUBE /FIBERS DO NOT MODIFY EXISTING SPLICES OR EXPRESSED FIBERS.
(4) BROWN	(10) VIOLET		
(5) SLATE	(11) ROSE		
(6) WHITE	(12) AQUA		

X = FUSION SPlice INDIVIDUAL FIBER
 C = CAP AND SEAL

- NOTES**
- UNUSED FIBERS LEFT COILED AND STORED IN SPLICE TRAY
 - UNUSED BUFFER TUBES LEFT COILED AND STORED IN SPLICE ENCLOSURE
 - EDGE SWITCH CONFIGURATIONS ARE GENERIC. CONTRACTOR IS RESPONSIBLE FOR DETERMINING/ENSURING THE PROPER TERMINATIONS.

ATKINS

1616 EAST MILLBROOK ROAD, SUITE 160
RALEIGH, NORTH CAROLINA 27609
(919) 876-6888 NCBEEs #F-0326

750 Greenfield Parkway, Garner, NC 27529

SCALE: N/A

Burlington-Graham Signal System
Fiber-Optic Splicing Details

Division 7 Alamance County Burlington & Graham

PLAN DATE: June 2018 REVIEWED BY: HA BADGETT

PREPARED BY: BJ SLOCUM REVIEWED BY: DL JONES

REVISIONS	INIT.	DATE

DOCUMENT NOT CONSIDERED FINAL UNLESS ALL SIGNATURES COMPLETED

SEAL
NORTH CAROLINA PROFESSIONAL ENGINEER
SEAL 040877
BRADFORD J. SLOCUM
15/2018

CADD File name: FS 4.109.dgn

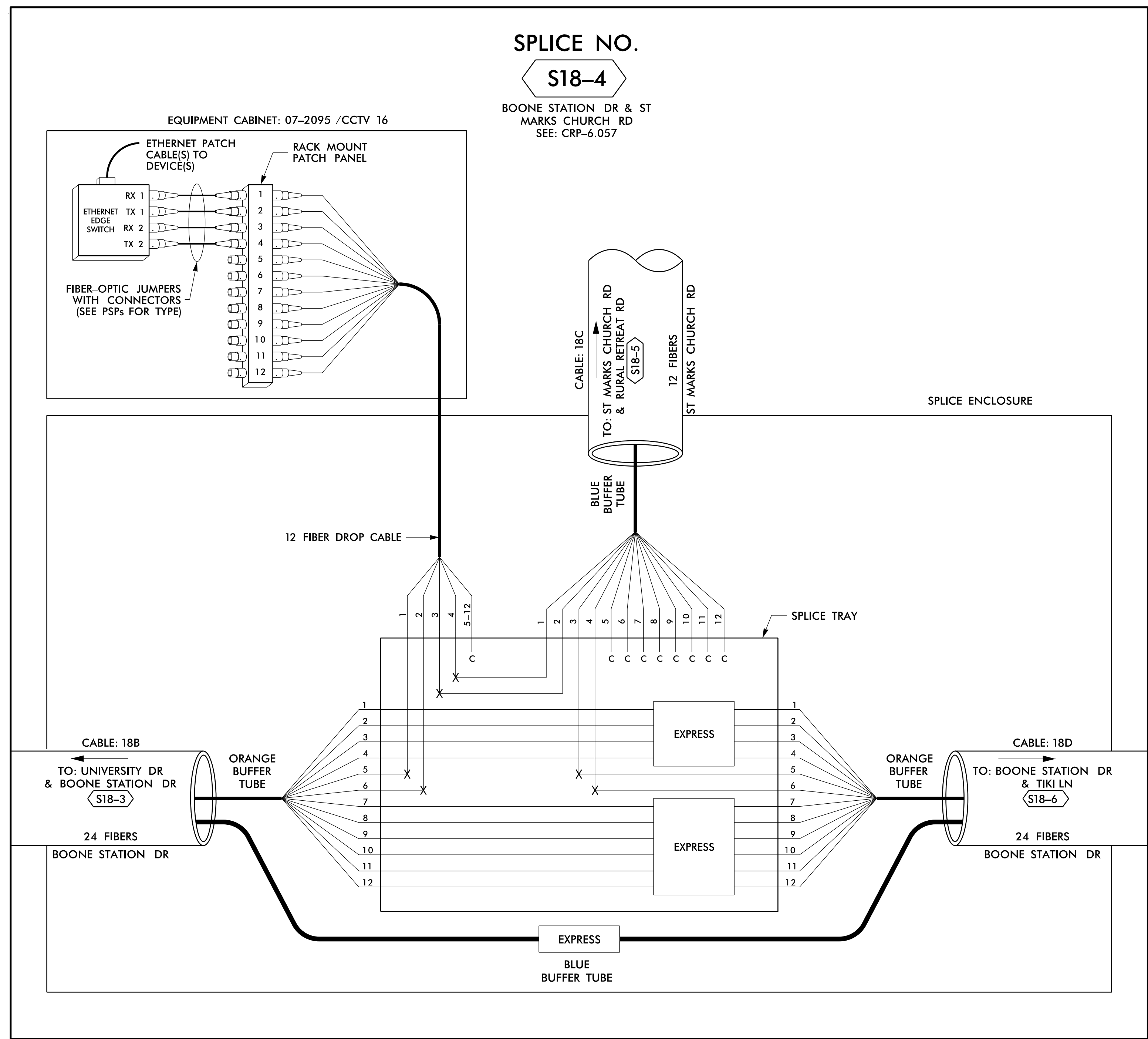

SPLICE NO.

S18-4

BOONE STATION DR & ST MARKS CHURCH RD
SEE: CRP-6.057

EQUIPMENT CABINET: 07-2095 / CCTV 16

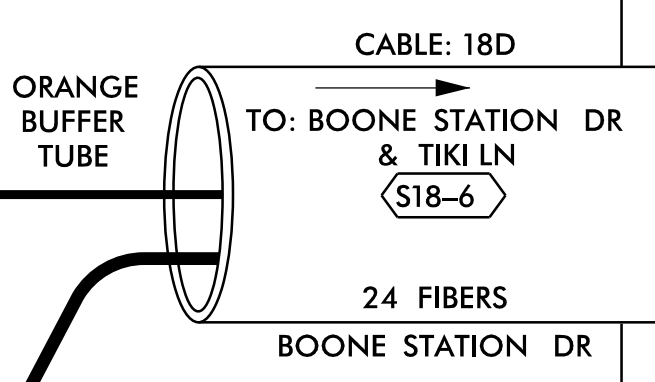
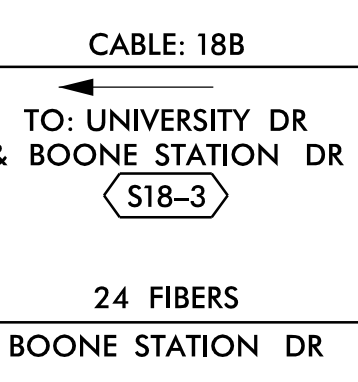
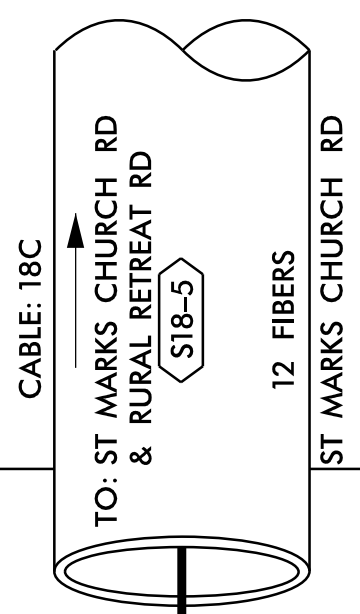
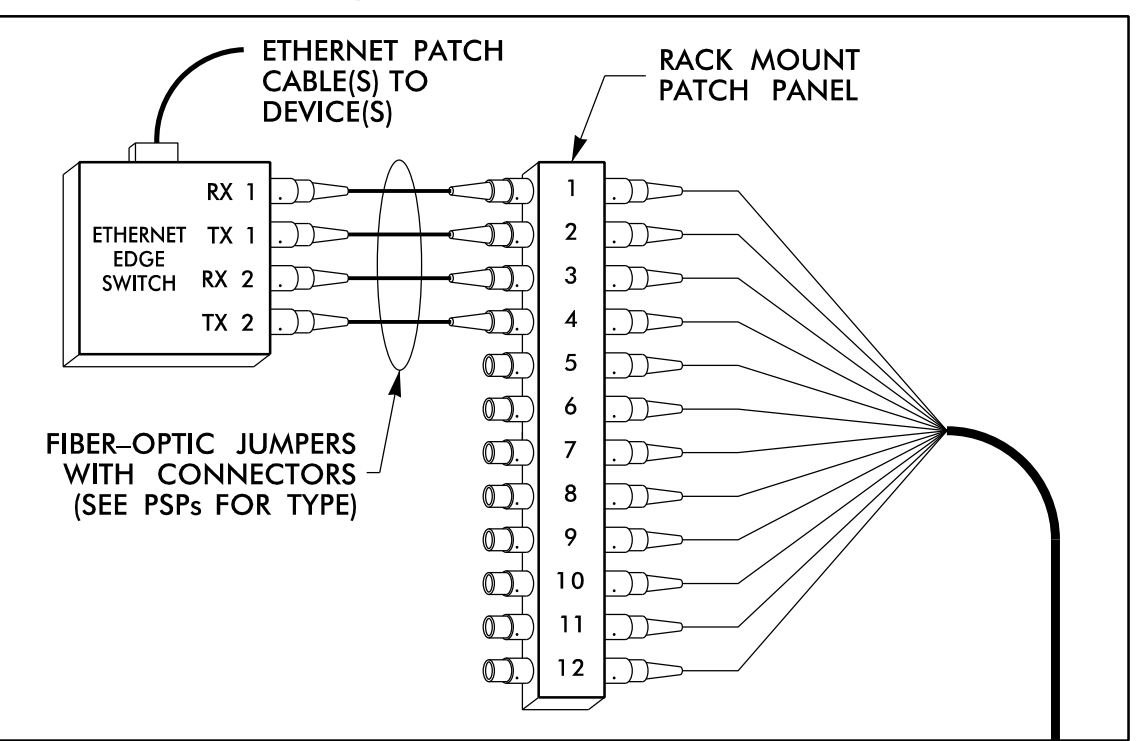

LEGEND

COLOR CODE TIA/EIA 598-B		X = FUSION SPlice INDIVIDUAL FIBER
(1) BLUE	(7) RED	EXPRESS ENTIRE BUFFER TUBE / FIBERS THROUGH WITHOUT CUTTING
(2) ORANGE	(8) BLACK	C = CAP AND SEAL
(3) GREEN	(9) YELLOW	EXPRESS ENTIRE BUFFER TUBE / FIBERS THROUGH WITHOUT CUTTING
(4) BROWN	(10) VIOLET	BUFFER SPlice
(5) SLATE	(11) ROSE	SPlice ALL FIBERS IN BUFFER TUBE COLOR TO COLOR
(6) WHITE	(12) AQUA	EXISTING BUFFER TUBE / FIBERS. DO NOT MODIFY EXISTING SPlices OR EXPRESSED FIBERS.
		EXISTING

NOTES

- UNUSED FIBERS LEFT COILED AND STORED IN SPlice TRAY
- UNUSED BUFFER TUBES LEFT COILED AND STORED IN SPlice ENCLOSURE
- EDGE SWITCH CONFIGURATIONS ARE GENERIC. CONTRACTOR IS RESPONSIBLE FOR DETERMINING/ENSURING THE PROPER TERMINATIONS.

ATKINS

1616 EAST MILLBROOK ROAD, SUITE 160
RALEIGH, NORTH CAROLINA 27609
(919) 876-6888 NCBES #F-0326

DOCUMENT NOT CONSIDERED FINAL
UNLESS ALL SIGNATURES COMPLETED

Prepared for the Offices of:

 750 Greenfield Parkway, Garner, NC 27529
 SCALE: N/A

Burlington-Graham Signal System Fiber-Optic Splicing Details		Burlington & Graham	
Division 7	Alamance County		
PLAN DATE: June 2018	REVIEWED BY: HA BADGETT		
PREPARED BY: BJ SLOCUM	REVIEWED BY: DL JONES		
REVISIONS	INIT.	DATE	

SEAL
 NORTH CAROLINA
 PROFESSIONAL
 SEAL
 040877
 ENGINEER
 BRADFORD J. SLOCUM
 15/2018
 DATE
 CADD File name: FS 4.110.dgn

14-JUN-2018 12:31
 D:\projects\proj\100056469 U-6015 B-C Sig_Sys\Task 11_Comms\F S 4.110.dgn
 S:\033653 AT_LUS355433

SPLICE NO.

S18-5

ST MARKS CHURCH RD &
RURAL RETREAT RD
SEE: CRP-6.070

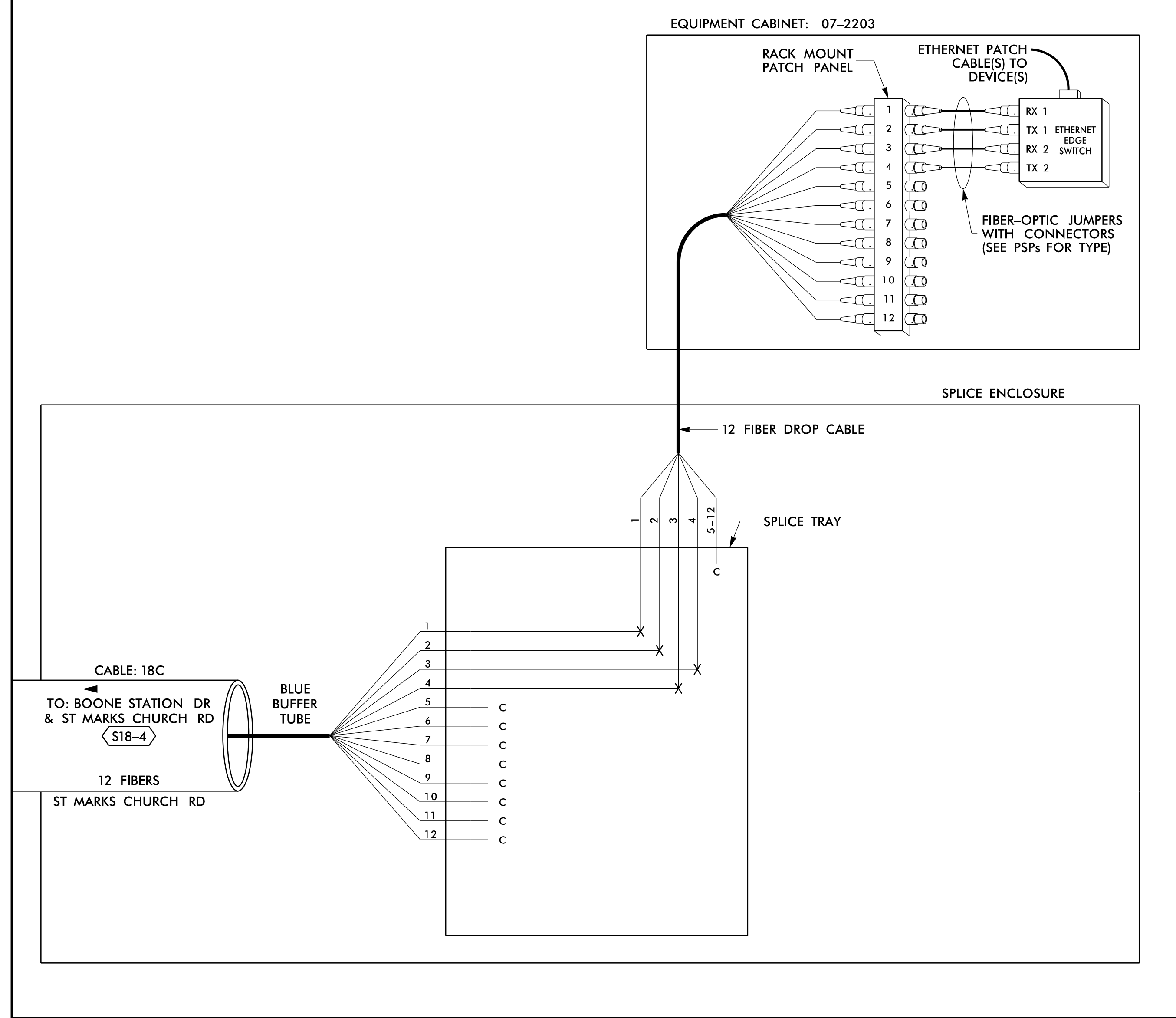

SPLICE NO.

S18-6

BOONE STATION DR & TIKI
SEE: CRP-6.058

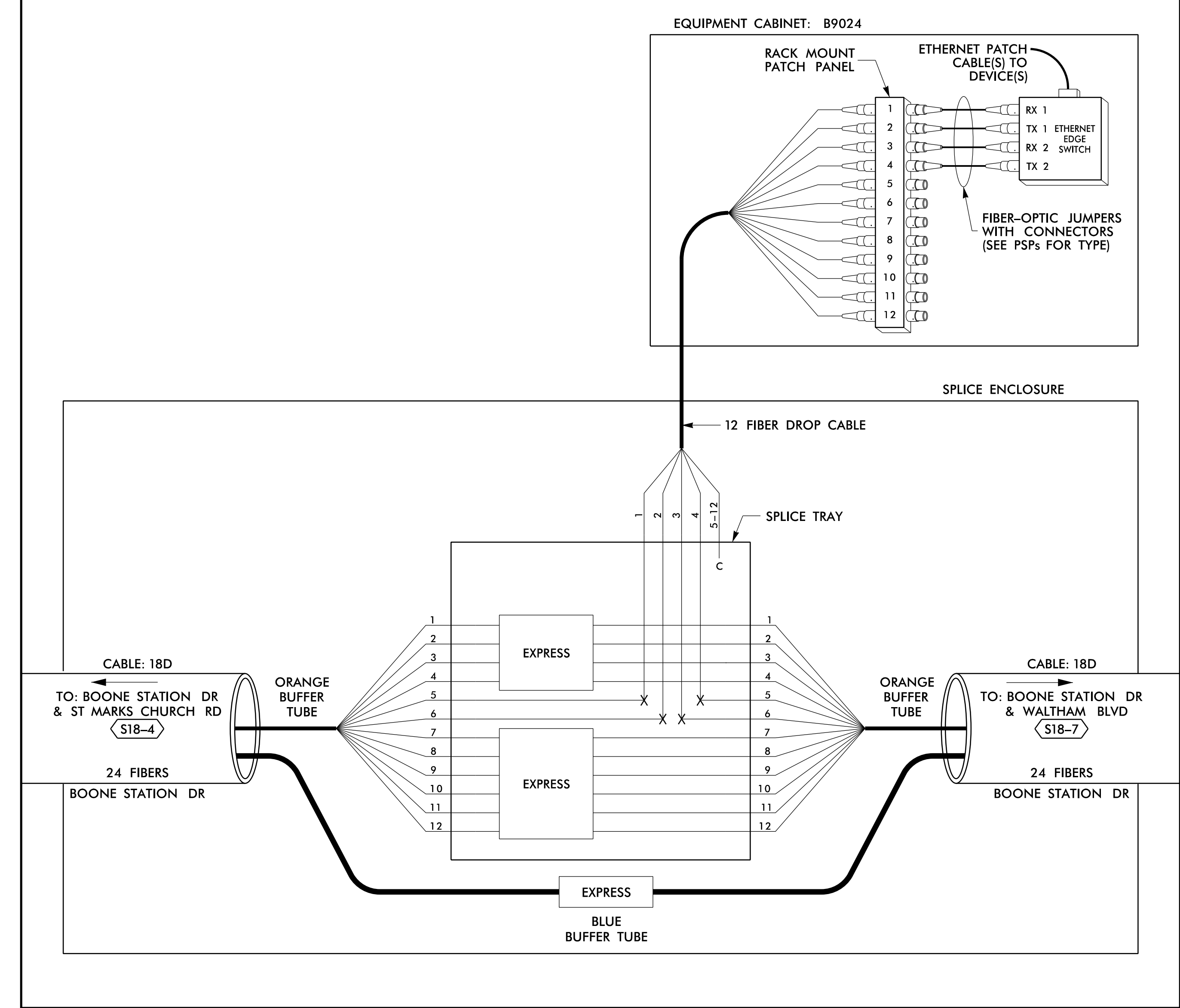

14 JUN 2018 12:31
 D:\projects\proj\100056469 U-6015 B-C Sig Sys\Task 11_Corrs\F S 4.111.dgn
 S:\033633 AT_LUS355433

LEGEND

COLOR CODE TIA/EIA 598-B		X = FUSION SPlice INDIVIDUAL FIBER C = CAP AND SEAL
(1) BLUE	(7) RED	EXPRESS
(2) ORANGE	(8) BLACK	EXPRESS ENTIRE BUFFER TUBE / FIBERS THROUGH WITHOUT CUTTING
(3) GREEN	(9) YELLOW	BUFFER SPlice
(4) BROWN	(10) VIOLET	BUFFER SPlice
(5) SLATE	(11) ROSE	EXISTING
(6) WHITE	(12) AQUA	EXISTING
SPlice ALL FIBERS IN BUFFER TUBE COLOR TO COLOR		EXISTING BUFFER TUBE / FIBERS DO NOT MODIFY EXISTING SPlices OR EXPRESSED FIBERS.

NOTES

- UNUSED FIBERS LEFT COILED AND STORED IN SPlice TRAY
- UNUSED BUFFER TUBES LEFT COILED AND STORED IN SPlice ENCLOSURE
- EDGE SWITCH CONFIGURATIONS ARE GENERIC. CONTRACTOR IS RESPONSIBLE FOR DETERMINING/ENSURING THE PROPER TERMINATIONS.

ATKINS 1616 EAST MILLBROOK ROAD, SUITE 160
RALEIGH, NORTH CAROLINA 27609
(919) 876-6888 NCBEEs #F-0326

DOCUMENT NOT CONSIDERED FINAL UNLESS ALL SIGNATURES COMPLETED

Prepared for the Offices of: 750 Greenfield Parkway, Garner, NC 27529	Burlington-Graham Signal System Fiber-Optic Splicing Details		SEAL NORTH CAROLINA PROFESSIONAL ENGINEER SEAL 040877 BRADFORD J. SLOCUM 15/2018 DATE
	Division 7 Alamance County PLAN DATE: June 2018 PREPARED BY: BJ SLOCUM	Burlington & Graham REVIEWED BY: HA BADGETT REVIEWED BY: DL JONES	
SCALE N/A			CAD File name: FS 4.111.dgn

SPLICE NO.

S18-7

BOONE STATION DR &
WALTHAM BLVD
SEE: CRP-6.059

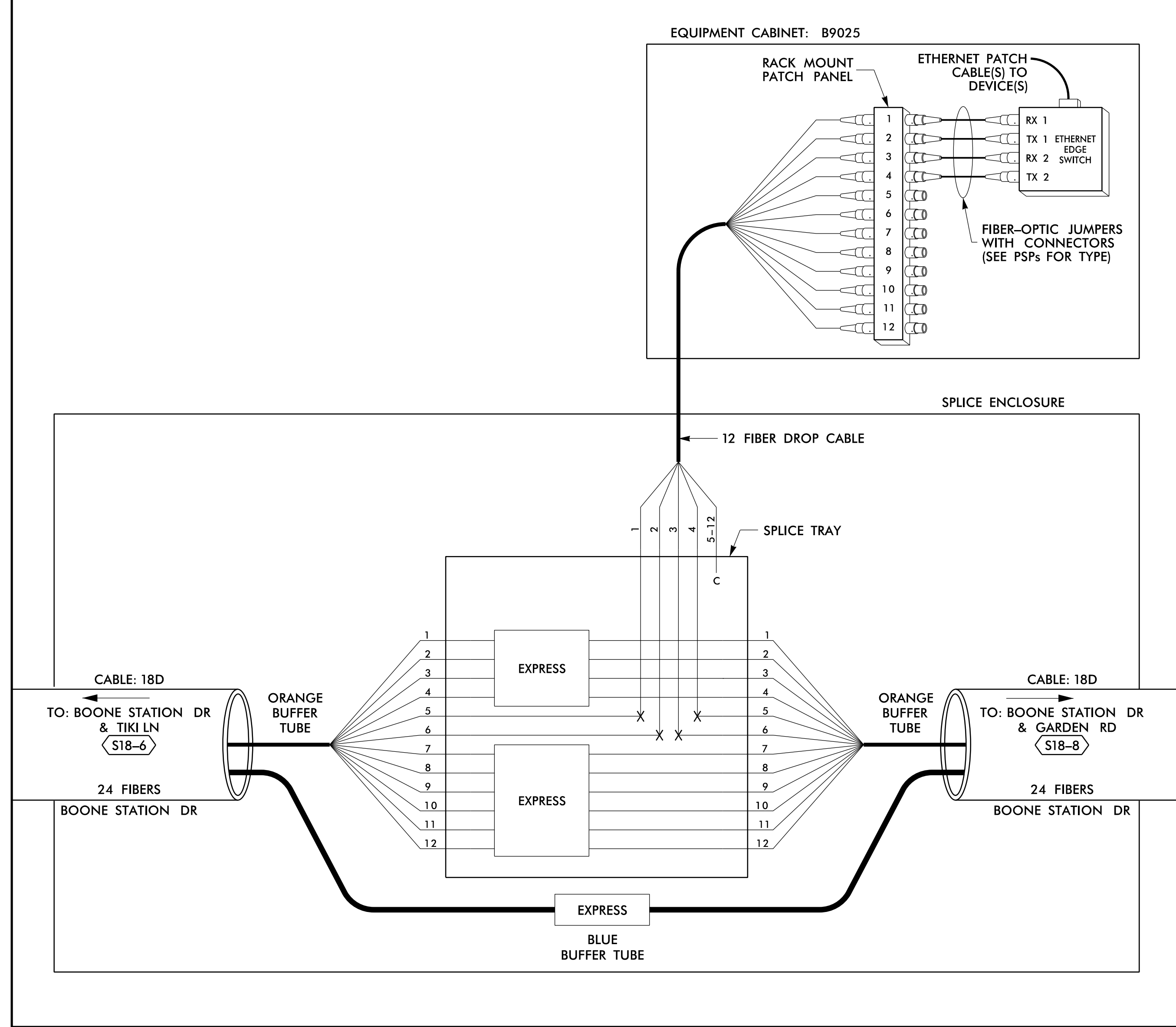

SPLICE NO.

S18-8

BOONE STATION DR &
GARDEN RD
SEE: CRP-6.060

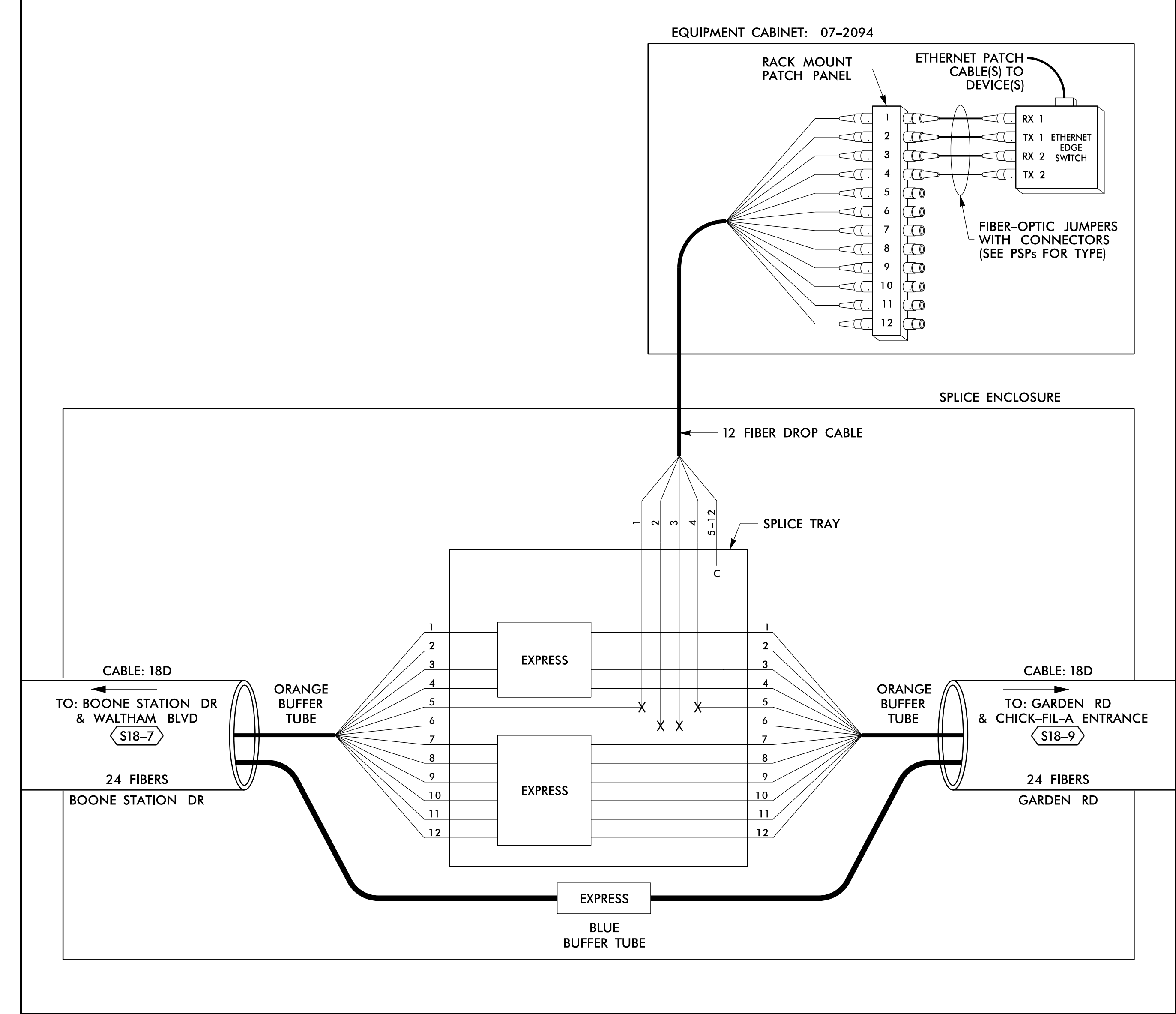

14 JUN 2018 12:31
 D:\projects\proj\11\comms\11_Coms\Fiber\11_Coms\Fiber_Sys\Task_11_Coms\Fiber_Sys_4.112.dgn
 S:\033633 AT LUS355433

LEGEND

COLOR CODE TIA/EIA 598-B		X = FUSION SPlice INDIVIDUAL FIBER C = CAP AND SEAL
(1) BLUE	(7) RED	EXPRESS
(2) ORANGE	(8) BLACK	EXPRESS ENTIRE BUFFER TUBE / FIBERS THROUGH WITHOUT CUTTING
(3) GREEN	(9) YELLOW	BUFFER SPlice
(4) BROWN	(10) VIOLET	BUFFER SPlice
(5) SLATE	(11) ROSE	EXISTING
(6) WHITE	(12) AQUA	EXISTING
SPlice ALL FIBERS IN BUFFER TUBE COLOR TO COLOR		EXISTING BUFFER TUBE / FIBERS DO NOT MODIFY EXISTING SPlices OR EXPRESSED FIBERS.

NOTES

- UNUSED FIBERS LEFT COILED AND STORED IN SPlice TRAY
- UNUSED BUFFER TUBES LEFT COILED AND STORED IN SPlice ENCLOSURE
- EDGE SWITCH CONFIGURATIONS ARE GENERIC. CONTRACTOR IS RESPONSIBLE FOR DETERMINING/ENSURING THE PROPER TERMINATIONS.

ATKINS 1616 EAST MILLBROOK ROAD, SUITE 160
RALEIGH, NORTH CAROLINA 27609
(919) 876-6888 NCBEEES #F-0326

Prepared for the Offices of: 750 Greenfield Parkway, Garner, NC 27529	Burlington-Graham Signal System Fiber-Optic Splicing Details		SEAL NORTH CAROLINA PROFESSIONAL ENGINEER SEAL 040877 BRADFORD J. SLOCUM 15/2018 DATE
	Division 7 Alamance County	Burlington & Graham	
	PLAN DATE: June 2018	REVIEWED BY: HA BADGETT	
	PREPARED BY: BJ SLOCUM	REVIEWED BY: DL JONES	
SCALE N/A	REVISIONS	INIT. DATE	DATE

DOCUMENT NOT CONSIDERED FINAL UNLESS ALL SIGNATURES COMPLETED

CADD File name: FS 4.112.dgn

SPLICE NO.

S18-9

GARDEN RD & CHICK-FIL-A
ENTRANCE
SEE: CRP-6.062

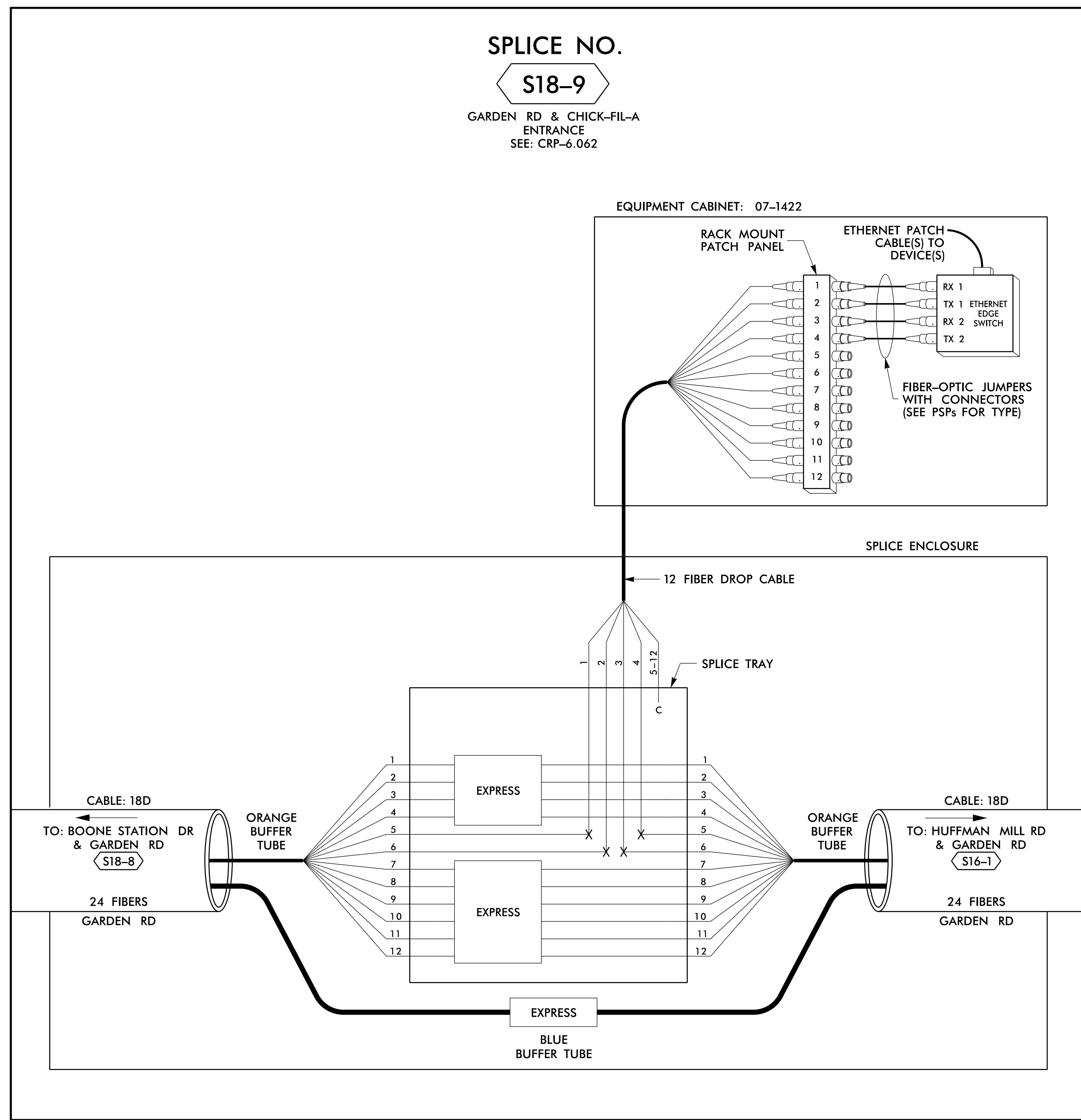

14 JUN 2018 12:31
 D:\Technical\proj\11\comms\11_Coms\Fs 4.113.dgn
 S:\035633 AT_LUS355433

LEGEND

COLOR CODE TIA/EIA 598-B		X = FUSION SPlice INDIVIDUAL FIBER C = CAP AND SEAL
(1) BLUE	(7) RED	EXPRESS
(2) ORANGE	(8) BLACK	EXPRESS ENTIRE BUFFER TUBE / FIBERS THROUGH WITHOUT CUTTING
(3) GREEN	(9) YELLOW	BUFFER SPlice
(4) BROWN	(10) VIOLET	SPlice ALL FIBERS IN BUFFER TUBE COLOR TO COLOR
(5) SLATE	(11) ROSE	EXISTING
(6) WHITE	(12) AQUA	EXISTING BUFFER TUBE / FIBERS. DO NOT MODIFY EXISTING SPlices OR EXPRESSED FIBERS.

NOTES

- UNUSED FIBERS LEFT COILED AND STORED IN SPLICE TRAY
- UNUSED BUFFER TUBES LEFT COILED AND STORED IN SPLICE ENCLOSURE
- EDGE SWITCH CONFIGURATIONS ARE GENERIC. CONTRACTOR IS RESPONSIBLE FOR DETERMINING/ENSURING THE PROPER TERMINATIONS.

ATKINS 1616 EAST MILLBROOK ROAD, SUITE 160
 RALEIGH, NORTH CAROLINA 27609
 (919) 876-6888 NCBEEs #F-0326

DOCUMENT NOT CONSIDERED FINAL UNLESS ALL SIGNATURES COMPLETED

Prepared for the Offices of: 750 Greenfield Parkway, Garner, NC 27529	Burlington-Graham Signal System Fiber-Optic Splicing Details		SEAL NORTH CAROLINA PROFESSIONAL ENGINEER SEAL 040877 BRADFORD J. SLOCUM 15/2018
	Division 7 Alamance County PLAN DATE: June 2018 PREPARED BY: BJ SLOCUM	Burlington & Graham REVIEWED BY: HA BADGETT REVIEWED BY: DL JONES	
REVISIONS: _____ INIT. DATE _____			

CADD File name: FS 4.113.dgn

SPLICE NO.

S19-1

CHURCH ST & WESTBROOK AVE
SEE: CRP-6.007

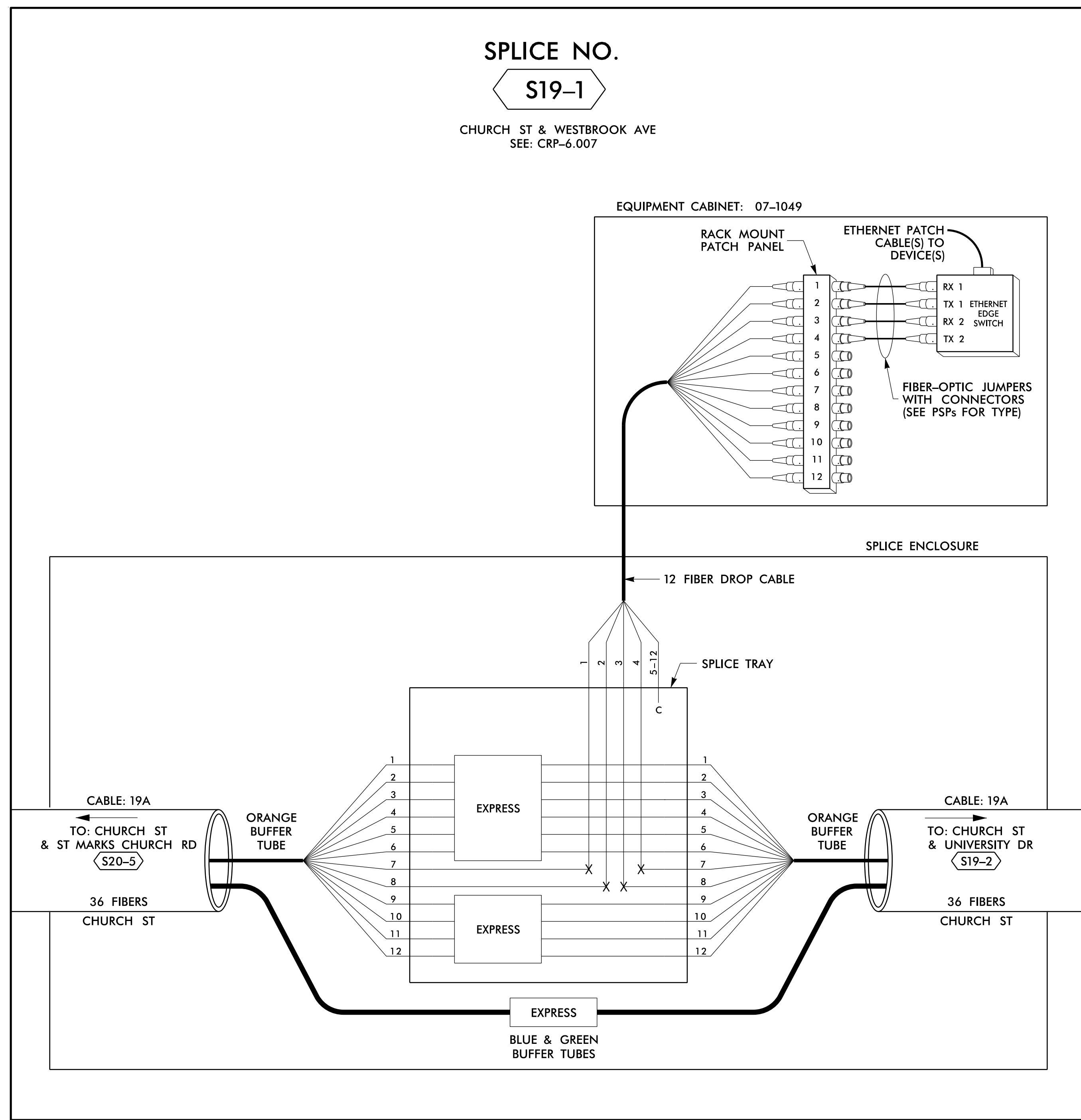

14 JUN 2018 12:31
 D:\Technical\Projects\U-6015 B-C Sig. Sys\Task 11_Comms\F S 4.114.dgn
 S:\DCS\653 AT_LUS355433

LEGEND

COLOR CODE TIA/EIA 598-B		X = FUSION SPlice INDIVIDUAL FIBER C = CAP AND SEAL
(1) BLUE	(7) RED	EXPRESS
(2) ORANGE	(8) BLACK	EXPRESS ENTIRE BUFFER TUBE / FIBERS THROUGH WITHOUT CUTTING
(3) GREEN	(9) YELLOW	BUFFER SPlice
(4) BROWN	(10) VIOLET	SPlice ALL FIBERS IN BUFFER TUBE COLOR TO COLOR
(5) SLATE	(11) ROSE	EXISTING
(6) WHITE	(12) AQUA	EXISTING BUFFER TUBE / FIBERS. DO NOT MODIFY EXISTING SPlices OR EXPRESSED FIBERS.

NOTES

- UNUSED FIBERS LEFT COILED AND STORED IN SPLICE TRAY
- UNUSED BUFFER TUBES LEFT COILED AND STORED IN SPLICE ENCLOSURE
- EDGE SWITCH CONFIGURATIONS ARE GENERIC. CONTRACTOR IS RESPONSIBLE FOR DETERMINING/ENSURING THE PROPER TERMINATIONS.

ATKINS 1616 EAST MILLBROOK ROAD, SUITE 160
RALEIGH, NORTH CAROLINA 27609
(919) 876-6888 NCBEE# F-0326

DOCUMENT NOT CONSIDERED FINAL UNLESS ALL SIGNATURES COMPLETED

Prepared for the Offices of:  750 Greenfield Parkway, Garner, NC 27529	Burlington-Graham Signal System Fiber-Optic Splicing Details		SEAL NORTH CAROLINA PROFESSIONAL ENGINEER SEAL 040877 BRADFORD J. SLOCUM 15/2018 DATE
	Division 7 Alamance County PLAN DATE: June 2018 PREPARED BY: BJ SLOCUM	Burlington & Graham REVIEWED BY: HA BADGETT REVIEWED BY: DL JONES	
REVISIONS			INIT. DATE
CAD File name: FS 4.114.dgn			DATE

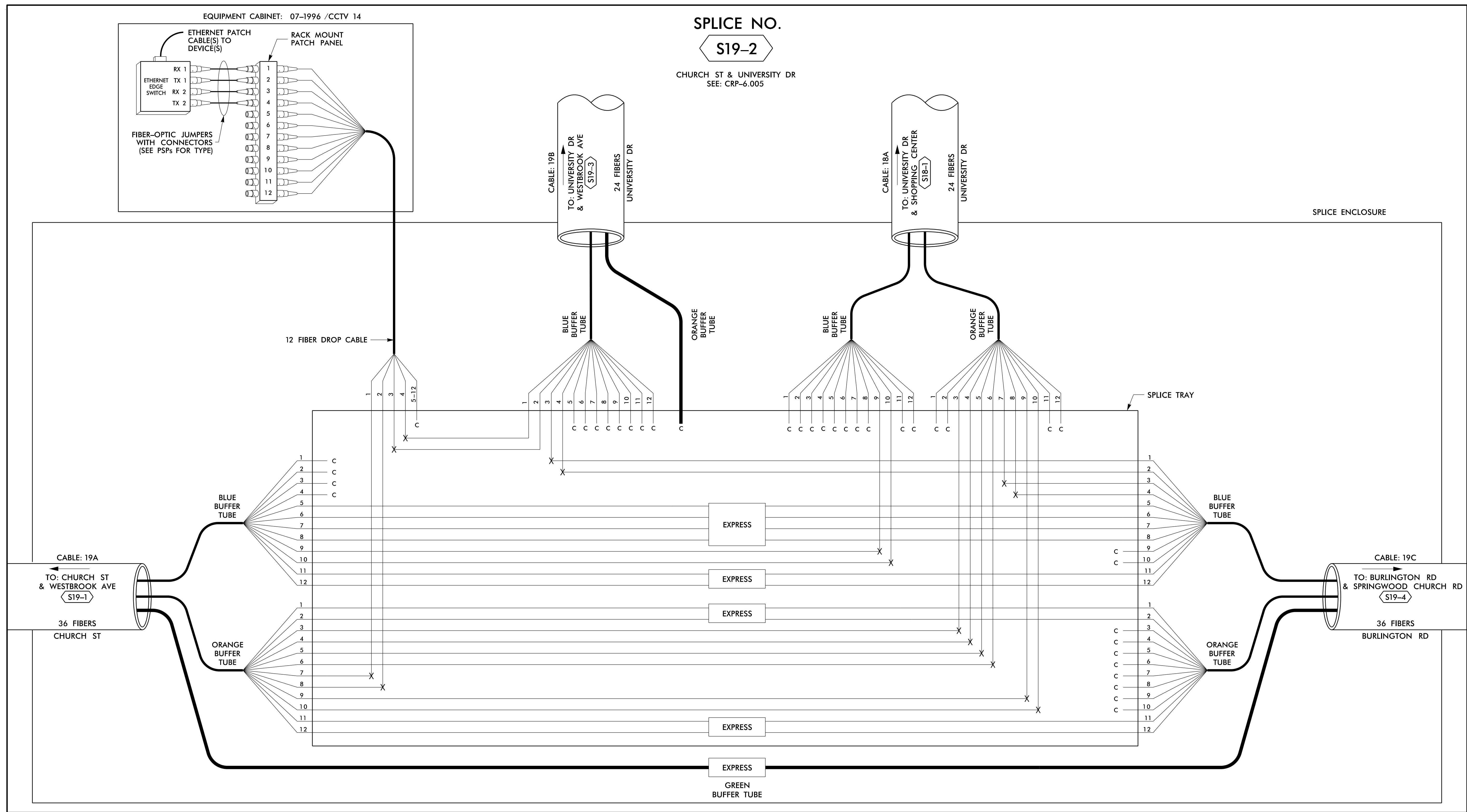

SPLICE NO.
S19-2

CHURCH ST & UNIVERSITY DR
 SEE: CRP-6.005

SPLICE ENCLOSURE

SPLICE TRAY

LEGEND

COLOR CODE TIA/EIA 598-B		X = FUSION SPLICE INDIVIDUAL FIBER C = CAP AND SEAL
(1) BLUE	(7) RED	EXPRESS
(2) ORANGE	(8) BLACK	EXPRESS ENTIRE BUFFER TUBE / FIBERS THROUGH WITHOUT CUTTING
(3) GREEN	(9) YELLOW	BUFFER SPLICE
(4) BROWN	(10) VIOLET	SPLICE ALL FIBERS IN BUFFER TUBE COLOR TO COLOR
(5) SLATE	(11) ROSE	EXISTING
(6) WHITE	(12) AQUA	EXISTING BUFFER TUBE / FIBERS DO NOT MODIFY EXISTING SPLICES OR EXPRESSED FIBERS.

NOTES

- UNUSED FIBERS LEFT COILED AND STORED IN SPLICE TRAY
- UNUSED BUFFER TUBES LEFT COILED AND STORED IN SPLICE ENCLOSURE
- EDGE SWITCH CONFIGURATIONS ARE GENERIC. CONTRACTOR IS RESPONSIBLE FOR DETERMINING/ENSURING THE PROPER TERMINATIONS.

ATKINS 1616 EAST MILLBROOK ROAD, SUITE 160
 RALEIGH, NORTH CAROLINA 27609
 (919) 876-6888 NCBEE# F-0326

DOCUMENT NOT CONSIDERED FINAL
 UNLESS ALL SIGNATURES COMPLETED

Prepared for the Offices of: 750 Greenfield Parkway, Garner, NC 27529	Burlington-Graham Signal System Fiber-Optic Splicing Details		SEAL NORTH CAROLINA PROFESSIONAL SEAL 040877 ENGINEER Bradford J. Slocum 15/2018 DATE
	Division 7 Alamance County	Burlington & Graham	
	PLAN DATE: June 2018	REVIEWED BY: HA BADGETT	
	PREPARED BY: BJ SLOCUM	REVIEWED BY: DL JONES	
SCALE N/A	REVISIONS	INIT. DATE	DATE

CAAD File name: FS 4.115.dgn

14-JUN-2018 12:31
 D:\projects\proj\100056469 U-6015 B-C Sig_Sys\Task 11_Comms\F 4.115.dgn
 S:\033633 AT_LUS355433

SPLICE NO.

S19-3

UNIVERSITY DR &
WESTBROOK AVE
SEE: CRP-6.046

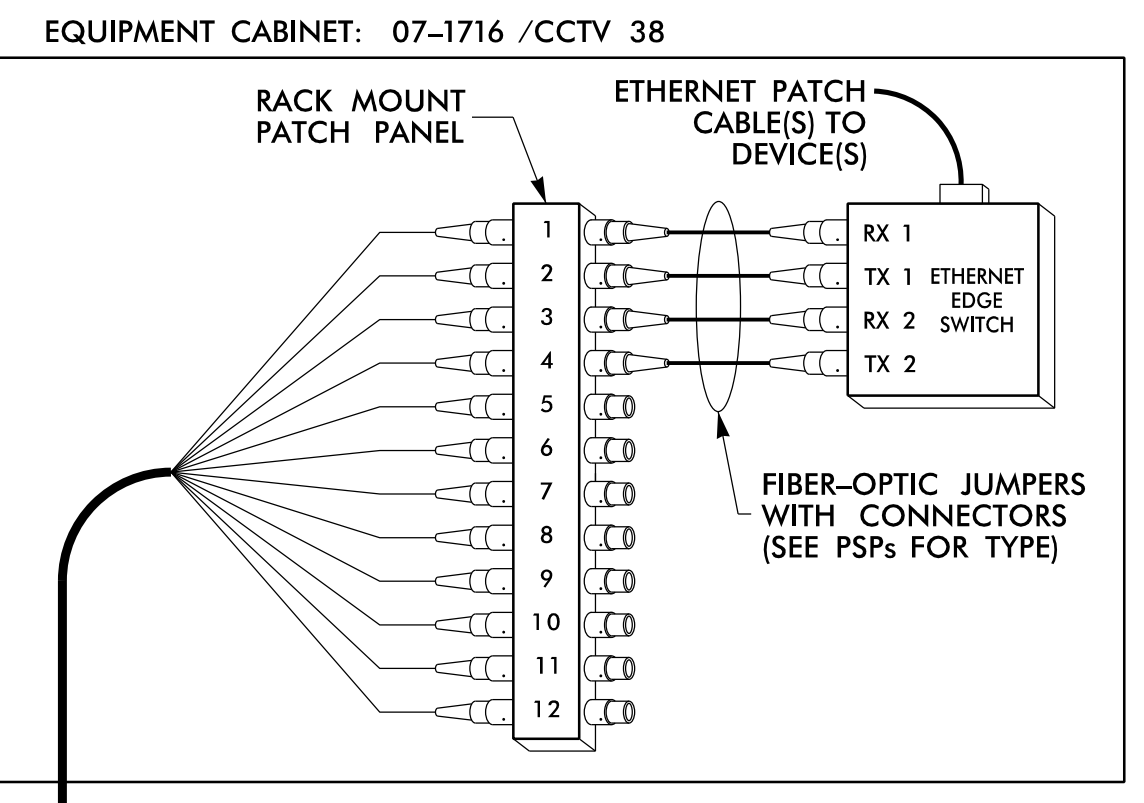

SPLICE ENCLOSURE

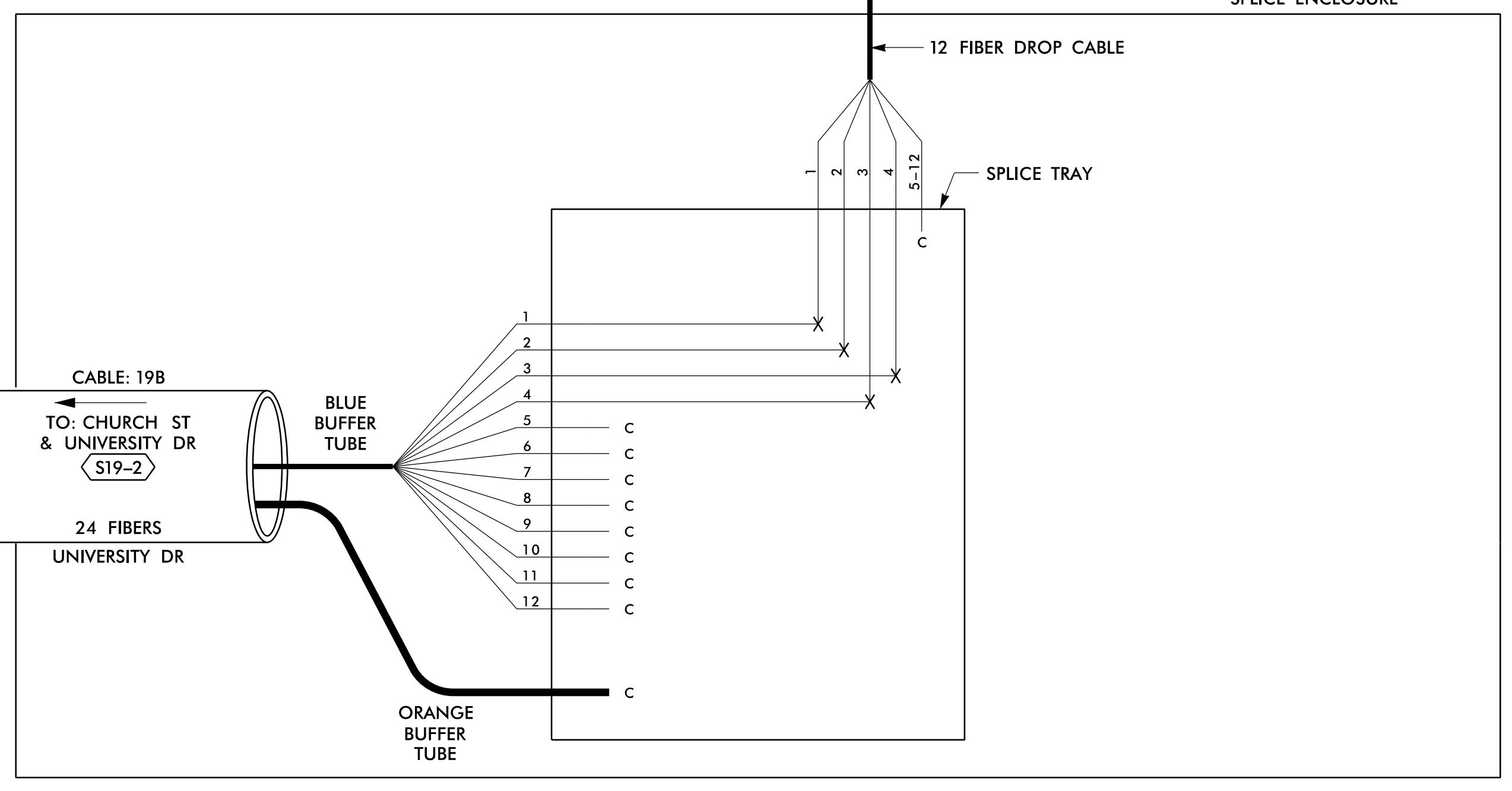

SPLICE NO.

S19-4

BURLINGTON RD & SPRINGWOOD CHURCH RD
SEE: CRP-6.001

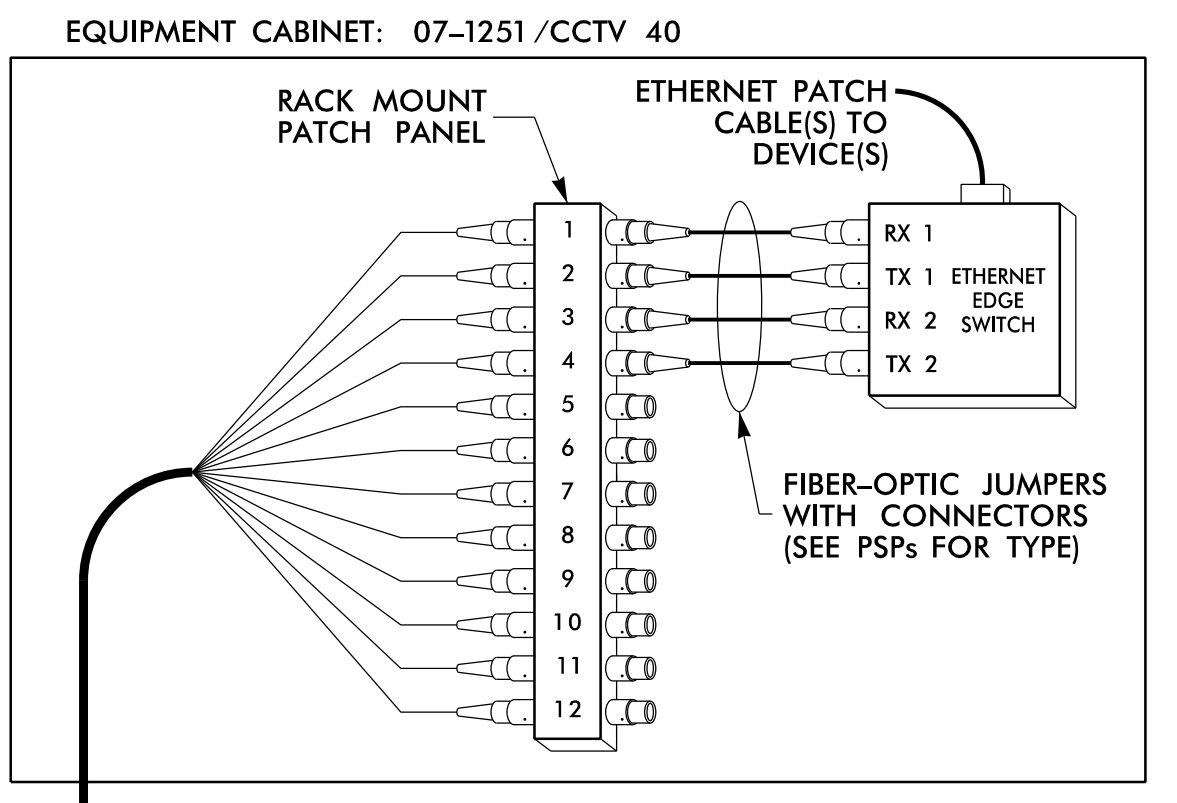

SPLICE ENCLOSURE

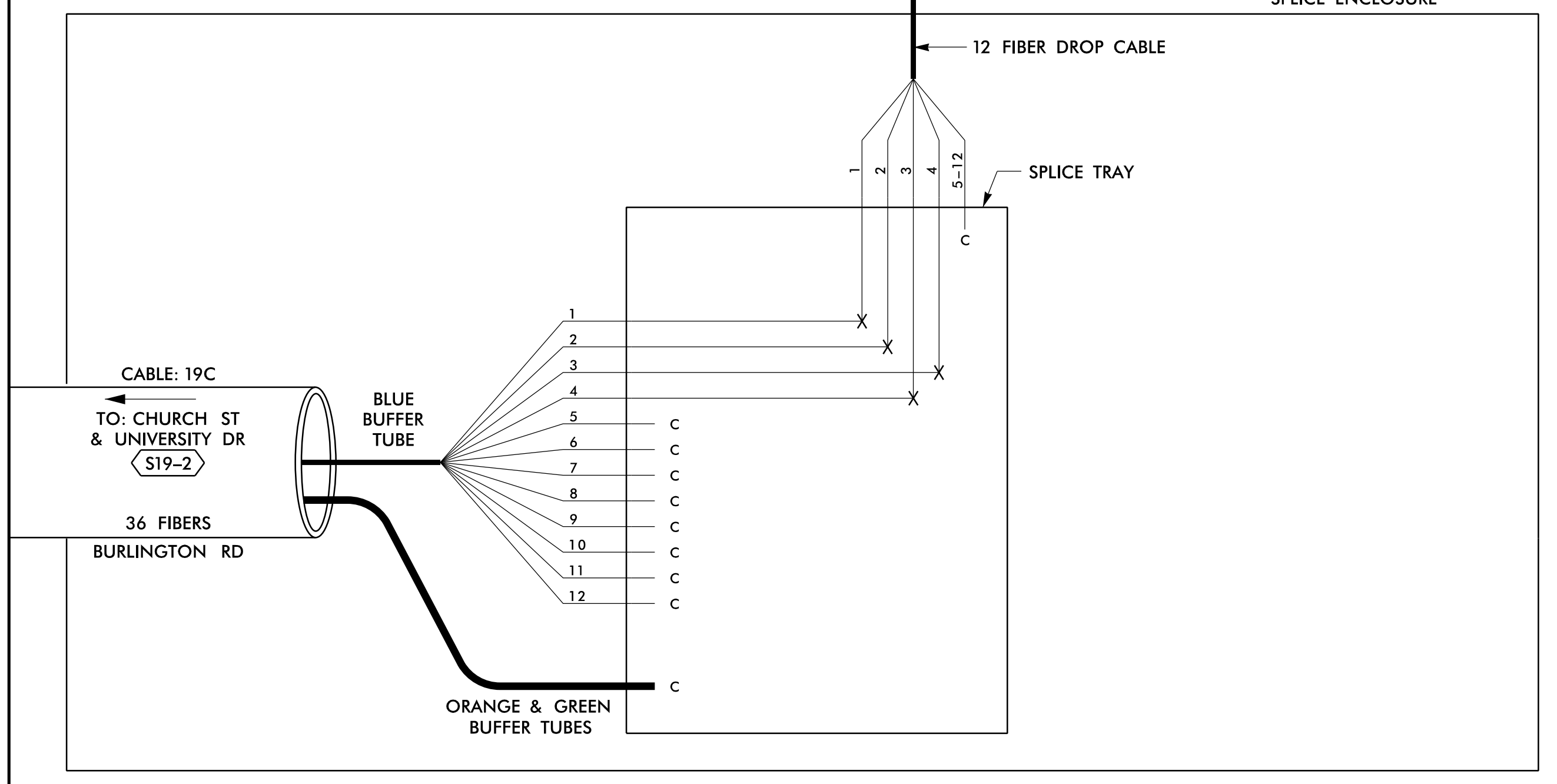

14 JUN 2018 12:31
 D:\projects\proj\11\comms\11_Coms\Fs 4.116.dgn
 S:\03553 AT_LUS3553

LEGEND

COLOR CODE TIA/EIA 598-B		X = FUSION SPlice INDIVIDUAL FIBER	
(1) BLUE	(7) RED	EXPRESS	EXPRESS ENTIRE BUFFER TUBE /FIBERS THROUGH WITHOUT CUTTING
(2) ORANGE	(8) BLACK	BUFFER SPlice	SPlice ALL FIBERS IN BUFFER TUBE COLOR TO COLOR
(3) GREEN	(9) YELLOW	EXISTING	EXISTING BUFFER TUBE /FIBERS DO NOT MODIFY EXISTING SPlices OR EXPRESSED FIBERS.
(4) BROWN	(10) VIOLET		
(5) SLATE	(11) ROSE		
(6) WHITE	(12) AQUA		
		C =	CAP AND SEAL

NOTES

1. UNUSED FIBERS LEFT COILED AND STORED IN SPLICE TRAY
2. UNUSED BUFFER TUBES LEFT COILED AND STORED IN SPLICE ENCLOSURE
3. EDGE SWITCH CONFIGURATIONS ARE GENERIC. CONTRACTOR IS RESPONSIBLE FOR DETERMINING/ENSURING THE PROPER TERMINATIONS.

ATKINS 1616 EAST MILLBROOK ROAD, SUITE 160
RALEIGH, NORTH CAROLINA 27609
(919) 876-6888 NCBES #F-0326

DOCUMENT NOT CONSIDERED FINAL UNLESS ALL SIGNATURES COMPLETED

<p>750 Greenfield Parkway, Garner, NC 27529</p>	<p>Burlington-Graham Signal System Fiber-Optic Splicing Details</p>							
	<p>Division 7 Alamance County Burlington & Graham</p>							
	<p>PLAN DATE: June 2018</p>	<p>REVIEWED BY: HA BADGETT</p>						
	<p>PREPARED BY: BJ SLOCUM</p>	<p>REVIEWED BY: DL JONES</p>						
<p>SCALE: N/A</p>	<table border="1"> <thead> <tr> <th>REVISIONS</th> <th>INIT.</th> <th>DATE</th> </tr> </thead> <tbody> <tr> <td> </td> <td> </td> <td> </td> </tr> </tbody> </table>	REVISIONS	INIT.	DATE				<p>DATE: 6/15/2018</p>
REVISIONS	INIT.	DATE						
<p>CADD File name: FS 4.116.dgn</p>			<p>DATE: </p>					

SPLICE NO.

S20-1

CHURCH ST & INTERNATIONAL RD
SEE: CRP-6.013

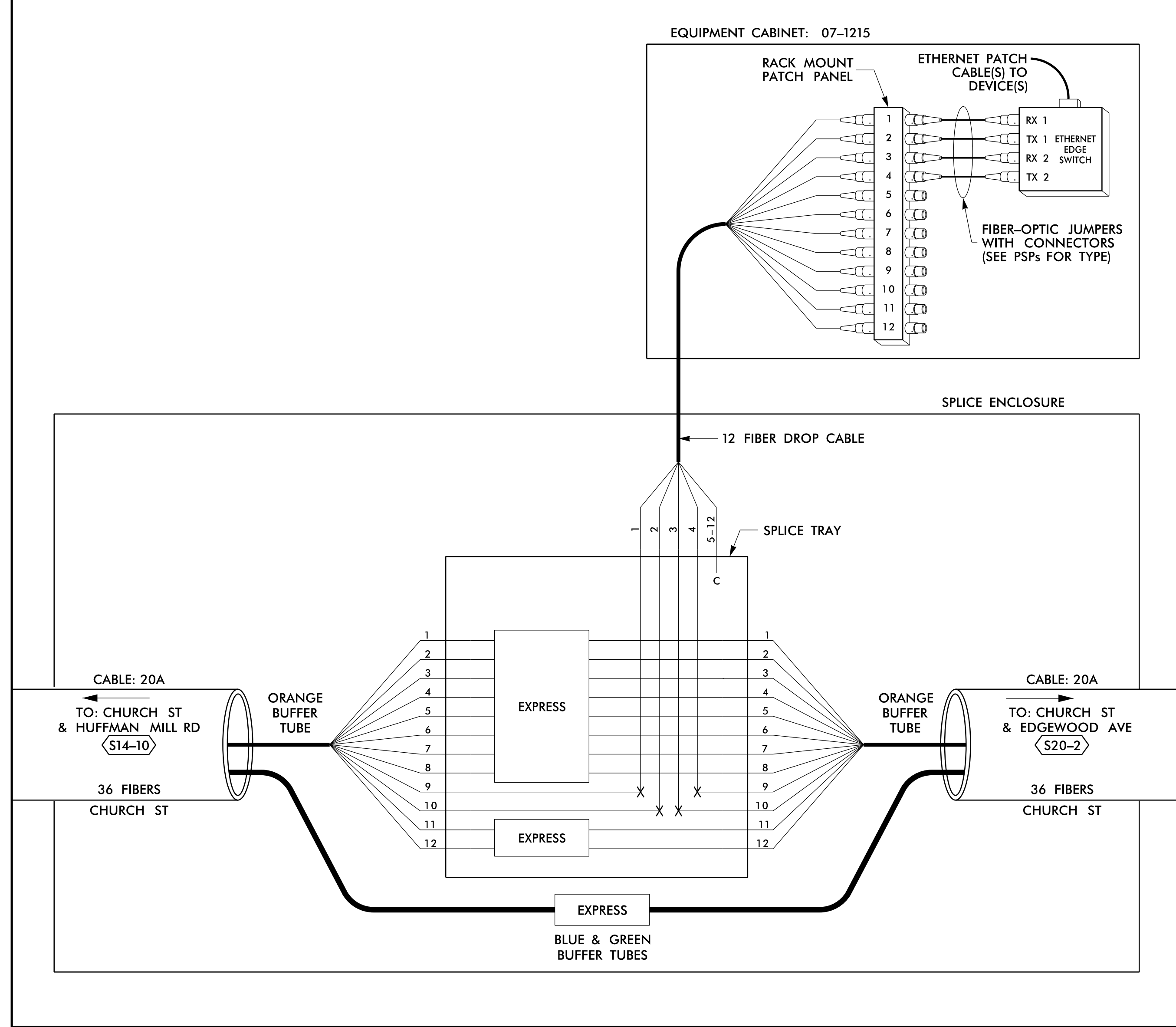

SPLICE NO.

S20-2

CHURCH ST & EDGEWOOD AVE
SEE: CRP-6.012

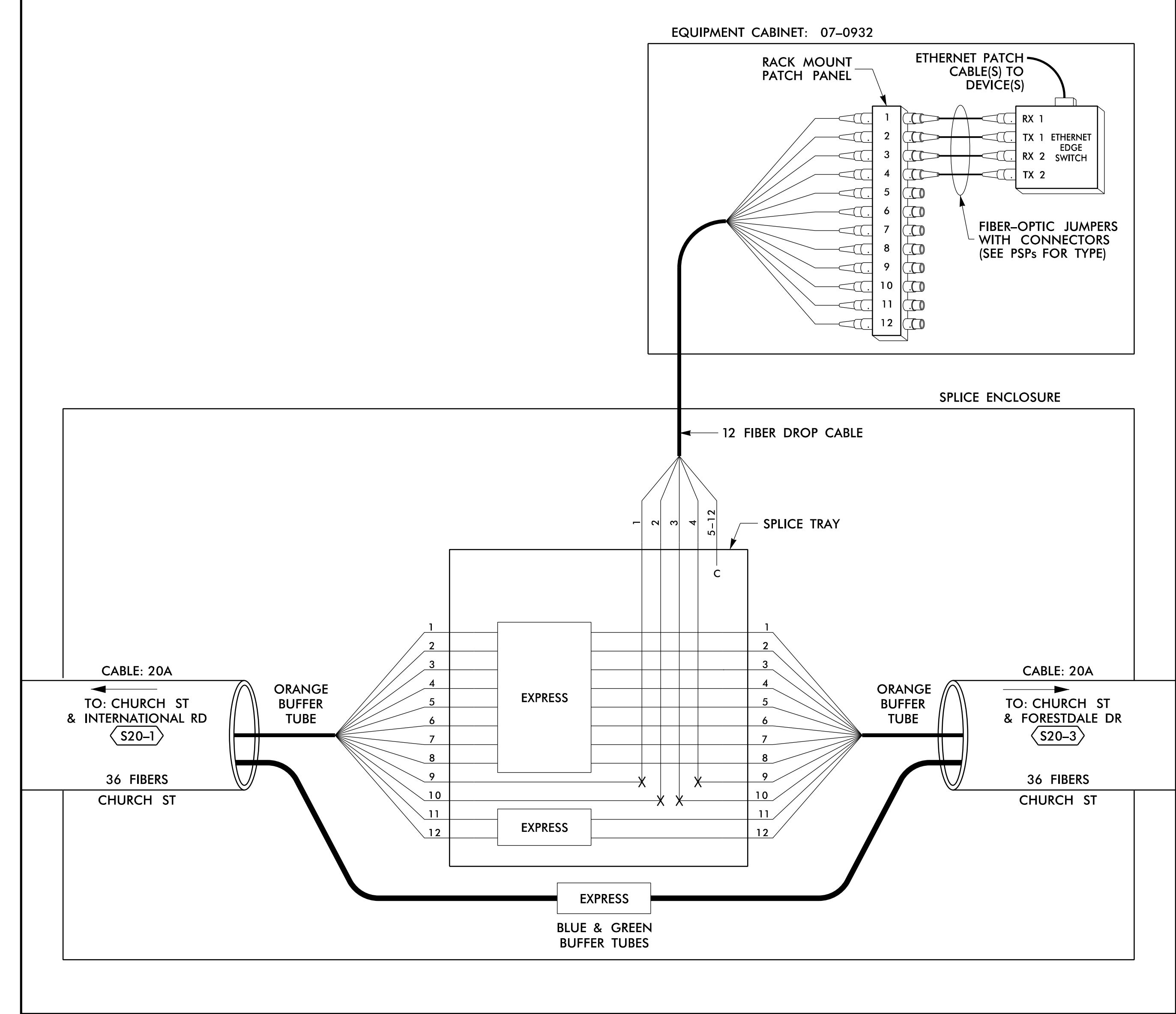

14 JUN 2018 12:31
 D:\projects\proj\11\comms\11_Coms\Fs 4.117.dgn
 0:\work\proj\11\comms\11_Coms\Fs 4.117.dgn
 S:\033633 AT LUS355433

LEGEND

COLOR CODE TIA/EIA 598-B		X = FUSION SPlice INDIVIDUAL FIBER C = CAP AND SEAL
(1) BLUE	(7) RED	EXPRESS
(2) ORANGE	(8) BLACK	EXPRESS ENTIRE BUFFER TUBE / FIBERS THROUGH WITHOUT CUTTING
(3) GREEN	(9) YELLOW	BUFFER SPlice
(4) BROWN	(10) VIOLET	SPlice ALL FIBERS IN BUFFER TUBE COLOR TO COLOR
(5) SLATE	(11) ROSE	EXISTING
(6) WHITE	(12) AQUA	EXISTING BUFFER TUBE / FIBERS DO NOT MODIFY EXISTING SPlices OR EXPRESSED FIBERS.

NOTES

- UNUSED FIBERS LEFT COILED AND STORED IN SPLICE TRAY
- UNUSED BUFFER TUBES LEFT COILED AND STORED IN SPLICE ENCLOSURE
- EDGE SWITCH CONFIGURATIONS ARE GENERIC. CONTRACTOR IS RESPONSIBLE FOR DETERMINING/ENSURING THE PROPER TERMINATIONS.

ATKINS 1616 EAST MILLBROOK ROAD, SUITE 160
RALEIGH, NORTH CAROLINA 27609
(919) 876-6888 NCBEEES #F-0326

DOCUMENT NOT CONSIDERED FINAL UNLESS ALL SIGNATURES COMPLETED

Prepared for the Offices of: 750 Greenfield Parkway, Garner, NC 27529 SCALE: N/A	Burlington-Graham Signal System Fiber-Optic Splicing Details		SEAL NORTH CAROLINA PROFESSIONAL ENGINEER SEAL 040877 BRADFORD J. SLOCUM 15/2018 DATE
	Division 7 Alamance County PLAN DATE: June 2018 PREPARED BY: BJ SLOCUM	Burlington & Graham REVIEWED BY: HA BADGETT REVIEWED BY: DL JONES	
REVISIONS			DATE

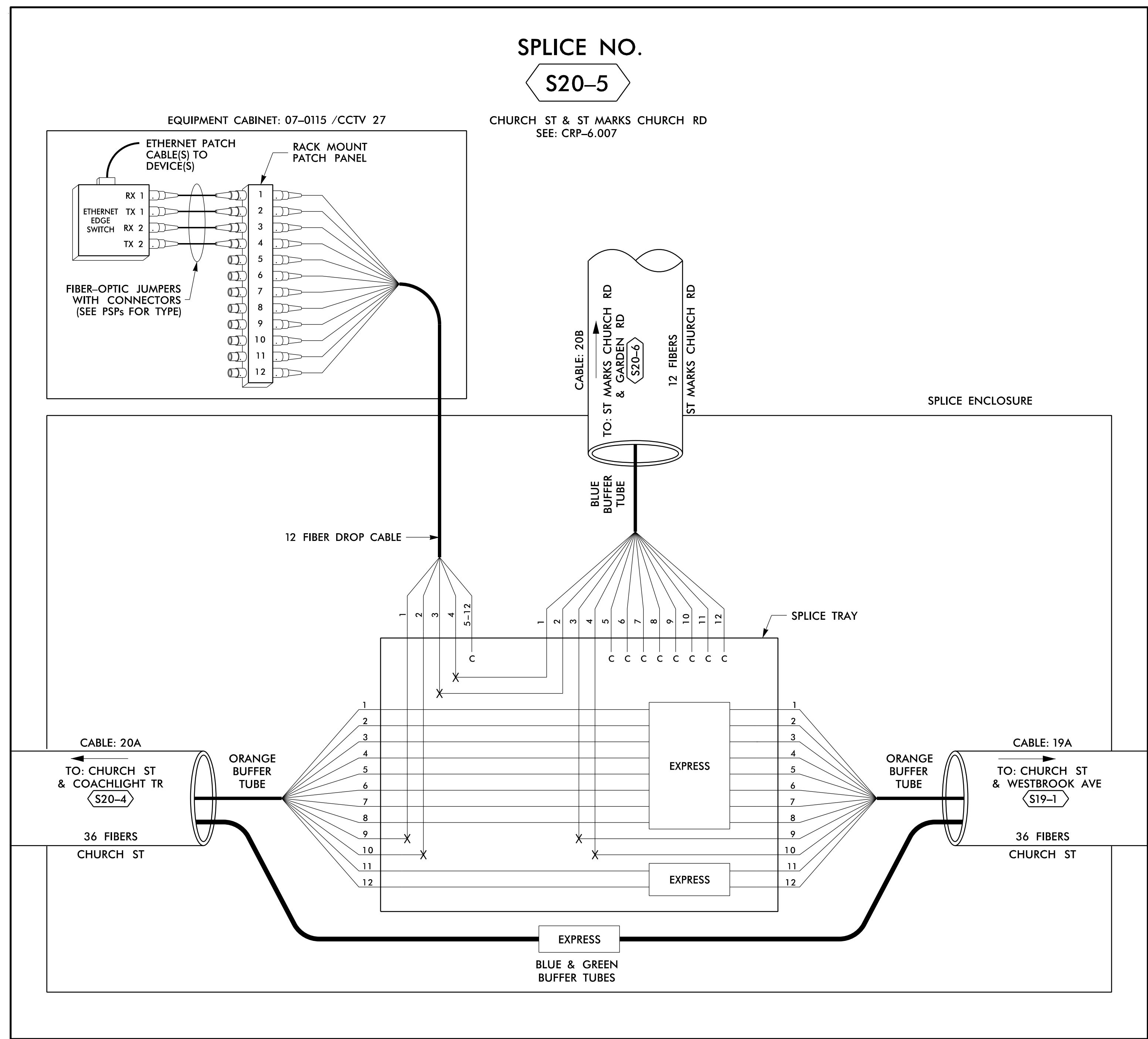

SPLICE NO.
S20-5

CHURCH ST & ST MARKS CHURCH RD
SEE: CRP-6.007

EQUIPMENT CABINET: 07-0115 / CCTV 27

SPLICE ENCLOSURE

12 FIBER DROP CABLE

CABLE: 20B
TO: ST MARKS CHURCH RD & GARDEN RD
S20-6
12 FIBERS
ST MARKS CHURCH RD

CABLE: 20A
TO: CHURCH ST & COACHLIGHT TR
S20-4
36 FIBERS
CHURCH ST

CABLE: 19A
TO: CHURCH ST & WESTBROOK AVE
S19-1
36 FIBERS
CHURCH ST

EXPRESS
BLUE & GREEN
BUFFER TUBES

LEGEND

COLOR CODE TIA/EIA 598-B		X = FUSION SPlice INDIVIDUAL FIBER
(1) BLUE	(7) RED	C = CAP AND SEAL
(2) ORANGE	(8) BLACK	
(3) GREEN	(9) YELLOW	EXPRESS
(4) BROWN	(10) VIOLET	BUFFER SPlice
(5) SLATE	(11) ROSE	EXISTING
(6) WHITE	(12) AQUA	

EXPRESS ENTIRE BUFFER TUBE / FIBERS THROUGH WITHOUT CUTTING
SPlice ALL FIBERS IN BUFFER TUBE COLOR TO COLOR
EXISTING BUFFER TUBE / FIBERS DO NOT MODIFY EXISTING SPlices OR EXPRESSED FIBERS.

NOTES

- UNUSED FIBERS LEFT COILED AND STORED IN SPLICE TRAY
- UNUSED BUFFER TUBES LEFT COILED AND STORED IN SPLICE ENCLOSURE
- EDGE SWITCH CONFIGURATIONS ARE GENERIC. CONTRACTOR IS RESPONSIBLE FOR DETERMINING/ENSURING THE PROPER TERMINATIONS.

ATKINS 1616 EAST MILLBROOK ROAD, SUITE 160
RALEIGH, NORTH CAROLINA 27609
(919) 876-6888 NCBEE# F-0326

DOCUMENT NOT CONSIDERED FINAL
UNLESS ALL SIGNATURES COMPLETED

Prepared for the Offices of:
NORTH CAROLINA DEPARTMENT OF TRANSPORTATION
750 Greenfield Parkway, Garner, NC 27529

Burlington-Graham Signal System Fiber-Optic Splicing Details	
Division 7	Alamance County
PLAN DATE: June 2018	REVIEWED BY: HA BADGETT
PREPARED BY: BJ SLOCUM	REVIEWED BY: DL JONES
REVISIONS	INIT. DATE

SEAL
NORTH CAROLINA PROFESSIONAL ENGINEER
SEAL 040877
BRADFORD J. SLOCUM
15/2018
DATE
CADD File name: FS 4.119.dgn

14 JUN 2018 12:31
 D:\projects\proj\11\comms\11\comms\F 4.119.dgn
 S:\D033633 AT LUS355433

SPLICE NO.

S20-6

ST MARKS CHURCH RD &
GARDEN RD
SEE: CRP-6.069

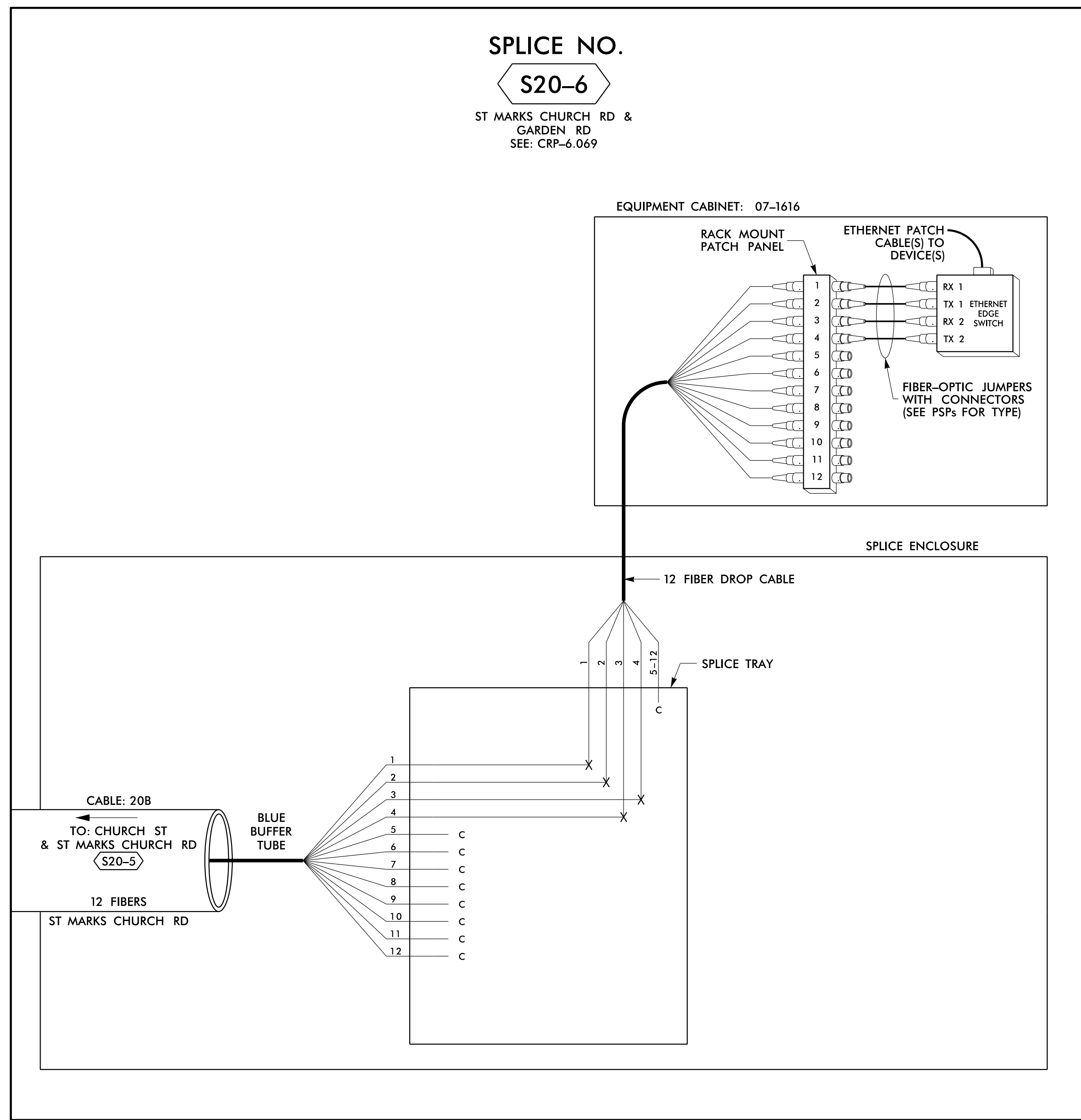

14 JUN 2018 12:31
 D:\Technical\Projects\U-6015 B-C Sig Sys\Task 11_Comms\FS 4.120.dgn
 S:\DCS\653 AT_LUS355433

LEGEND

COLOR CODE TIA/EIA 598-B		X = FUSION SPlice INDIVIDUAL FIBER
(1) BLUE	(7) RED	C = CAP AND SEAL
(2) ORANGE	(8) BLACK	
(3) GREEN	(9) YELLOW	
(4) BROWN	(10) VIOLET	EXPRESS EXPRESS ENTIRE BUFFER TUBE / FIBERS THROUGH WITHOUT CUTTING
(5) SLATE	(11) ROSE	BUFFER SPlice SPlice ALL FIBERS IN BUFFER TUBE COLOR TO COLOR
(6) WHITE	(12) AQUA	EXISTING EXISTING BUFFER TUBE / FIBERS DO NOT MODIFY EXISTING SPlices OR EXPRESSED FIBERS.

NOTES

- UNUSED FIBERS LEFT COILED AND STORED IN SPLICE TRAY
- UNUSED BUFFER TUBES LEFT COILED AND STORED IN SPLICE ENCLOSURE
- EDGE SWITCH CONFIGURATIONS ARE GENERIC. CONTRACTOR IS RESPONSIBLE FOR DETERMINING/ENSURING THE PROPER TERMINATIONS.

ATKINS 1616 EAST MILLBROOK ROAD, SUITE 160
RALEIGH, NORTH CAROLINA 27609
(919) 876-6888 NCBEEES #F-0326

DOCUMENT NOT CONSIDERED FINAL UNLESS ALL SIGNATURES COMPLETED

<p>Prepared for the Offices of: NORTH CAROLINA DEPARTMENT OF TRANSPORTATION Division of Transportation Systems</p>	Burlington-Graham Signal System Fiber-Optic Splicing Details		
	Division 7 Alamance County Burlington & Graham		
PLAN DATE: June 2018 PREPARED BY: BJ SLOCUM	REVIEWED BY: HA BADGETT REVIEWED BY: DL JONES		
SCALE: N/A	REVISIONS	INIT. DATE	DATE
			CAD00 File name: FS_4.120.dgn