

**This electronic collection of documents is provided
for the convenience of the user
and is Not a Certified Document –**

**The documents contained herein were originally issued
and sealed by the individuals whose names and license
numbers appear on each page, on the dates appearing
with their signature on that page.**

**This file or an individual page
shall not be considered a certified document.**

SPLICE NO.

S12-6

WEBB AVE & LAKEVIEW AVE
SEE: CRP-6.132

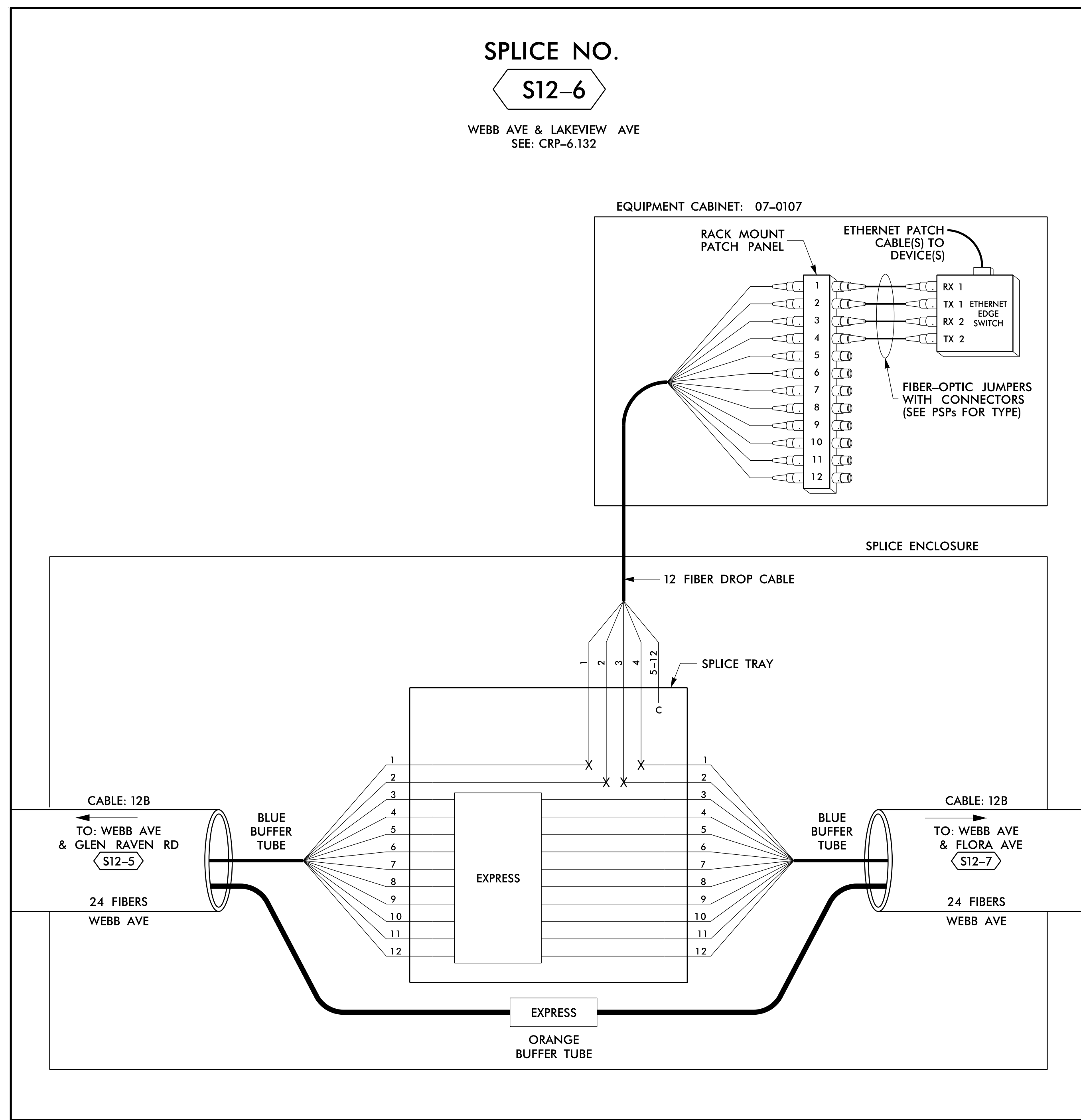

14-JUN-2018 12:29
 D:\Technical\Projects\U-6015 B-C Sig_Sys\Task 11_Comms\F5 4.076.dgn
 S:\DCS\653 AT_LLJ355433

LEGEND

COLOR CODE TIA/EIA 598-B		X = FUSION SPlice INDIVIDUAL FIBER C = CAP AND SEAL
(1) BLUE	(7) RED	EXPRESS
(2) ORANGE	(8) BLACK	EXPRESS ENTIRE BUFFER TUBE / FIBERS THROUGH WITHOUT CUTTING
(3) GREEN	(9) YELLOW	BUFFER SPlice
(4) BROWN	(10) VIOLET	SPlice ALL FIBERS IN BUFFER TUBE COLOR TO COLOR
(5) SLATE	(11) ROSE	EXISTING
(6) WHITE	(12) AQUA	EXISTING BUFFER TUBE / FIBERS DO NOT MODIFY EXISTING SPlices OR EXPRESSED FIBERS.

NOTES

- UNUSED FIBERS LEFT COILED AND STORED IN SPLICE TRAY
- UNUSED BUFFER TUBES LEFT COILED AND STORED IN SPLICE ENCLOSURE
- EDGE SWITCH CONFIGURATIONS ARE GENERIC. CONTRACTOR IS RESPONSIBLE FOR DETERMINING/ENSURING THE PROPER TERMINATIONS.

ATKINS 1616 EAST MILLBROOK ROAD, SUITE 160
 RALEIGH, NORTH CAROLINA 27609
 (919) 876-6888 NCBEEES #F-0326

DOCUMENT NOT CONSIDERED FINAL UNLESS ALL SIGNATURES COMPLETED

Prepared for the Offices of: 750 Greenfield Parkway, Garner, NC 27529	Burlington-Graham Signal System Fiber-Optic Splicing Details		SEAL NORTH CAROLINA PROFESSIONAL ENGINEER SEAL 040877 BRADFORD J. SLOCUM 15/2018 DATE
	Division 7 Alamance County PLAN DATE: June 2018 PREPARED BY: BJ SLOCUM	Burlington & Graham REVIEWED BY: HA BADGETT REVIEWED BY: DL JONES	
REVISIONS: _____ INIT. DATE _____			

CADD File name: FS 4.076.dgn

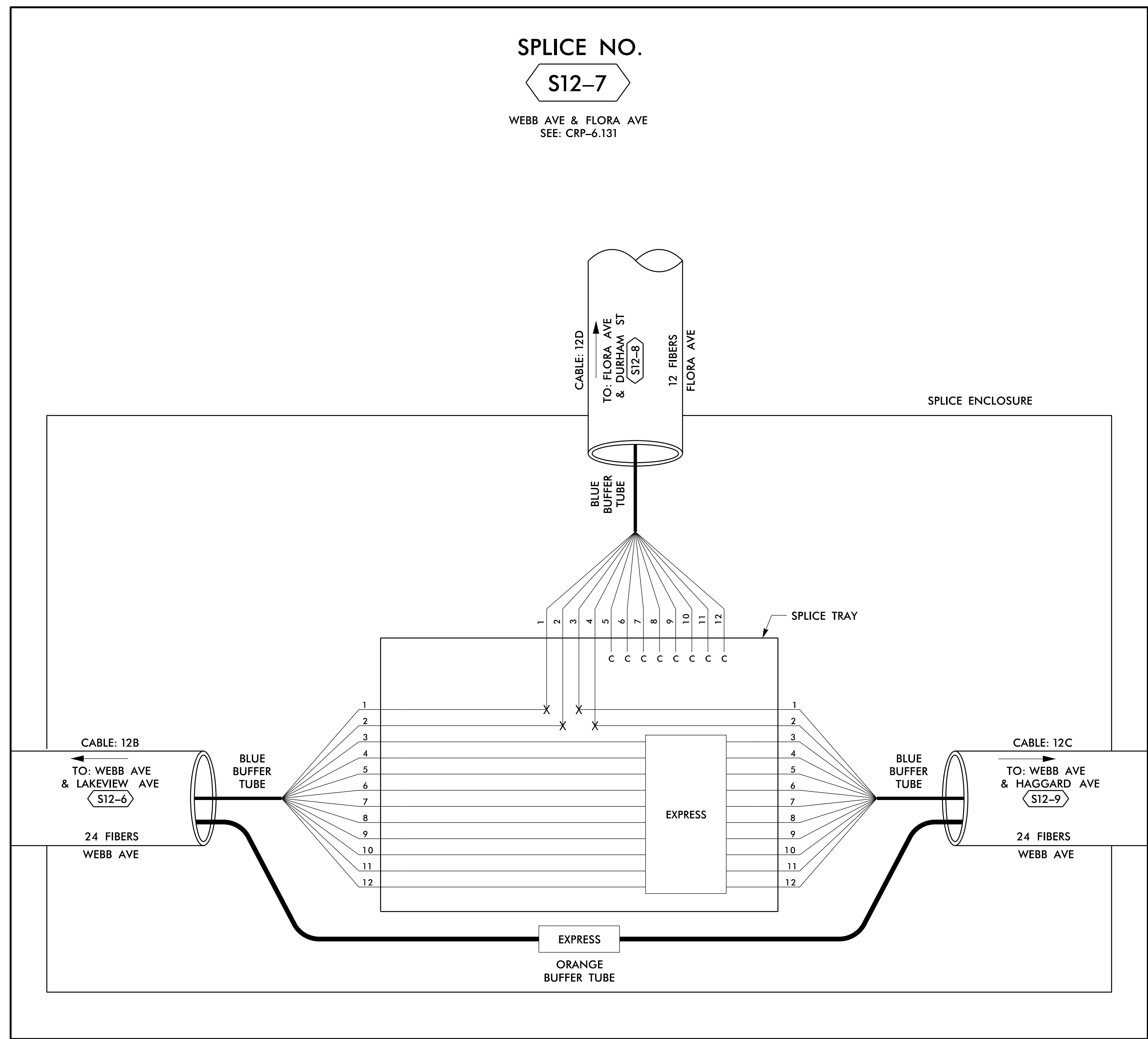

14 JUN 2018 12:29
 D:\Technical\Information\Traffic\Cur*100056469 U=6015 B=C Sig_Sys*Task 11_Corrs*FS 4.077.dgn
 S:\DCS\653 AT LUS355433

COLOR CODE		LEGEND	
(1) BLUE	(7) RED	X = FUSION SPlice INDIVIDUAL FIBER	EXPRESS ENTIRE BUFFER TUBE /FIBERS THROUGH WITHOUT CUTTING
(2) ORANGE	(8) BLACK	C = CAP AND SEAL	SPlice ALL FIBERS IN BUFFER TUBE COLOR TO COLOR
(3) GREEN	(9) YELLOW		EXISTING BUFFER TUBE /FIBERS DO NOT MODIFY EXISTING SPlices OR EXPRESSED FIBERS.
(4) BROWN	(10) VIOLET		
(5) SLATE	(11) ROSE		
(6) WHITE	(12) AQUA		

- NOTES**
- UNUSED FIBERS LEFT COILED AND STORED IN SPLICE TRAY
 - UNUSED BUFFER TUBES LEFT COILED AND STORED IN SPLICE ENCLOSURE
 - EDGE SWITCH CONFIGURATIONS ARE GENERIC. CONTRACTOR IS RESPONSIBLE FOR DETERMINING/ENSURING THE PROPER TERMINATIONS.

ATKINS

1616 EAST MILLBROOK ROAD, SUITE 160
 RALEIGH, NORTH CAROLINA 27609
 (919) 876-6888 NCBES #F-0326

**DOCUMENT NOT CONSIDERED FINAL
UNLESS ALL SIGNATURES COMPLETED**

Prepared for the Offices of: DEPARTMENT OF TRANSPORTATION STATE OF NORTH CAROLINA		SEAL NORTH CAROLINA PROFESSIONAL SEAL 040877 ENGINEER BRADFORD J. SLOCUM 15/2018 DATE	
Burlington-Graham Signal System Fiber-Optic Splicing Details			
Division 7 Alamance County Burlington & Graham		PLAN DATE: June 2018 REVIEWED BY: HA BADGETT	
PREPARED BY: BJ SLOCUM		REVIEWED BY: DL JONES	
SCALE: N/A		REVISIONS: INIT. DATE	
CADD File name: FS 4.077.dgn			

SPLICE NO.

S12-8

FLORA AVE & DURHAM ST
SEE: CRP-6.156

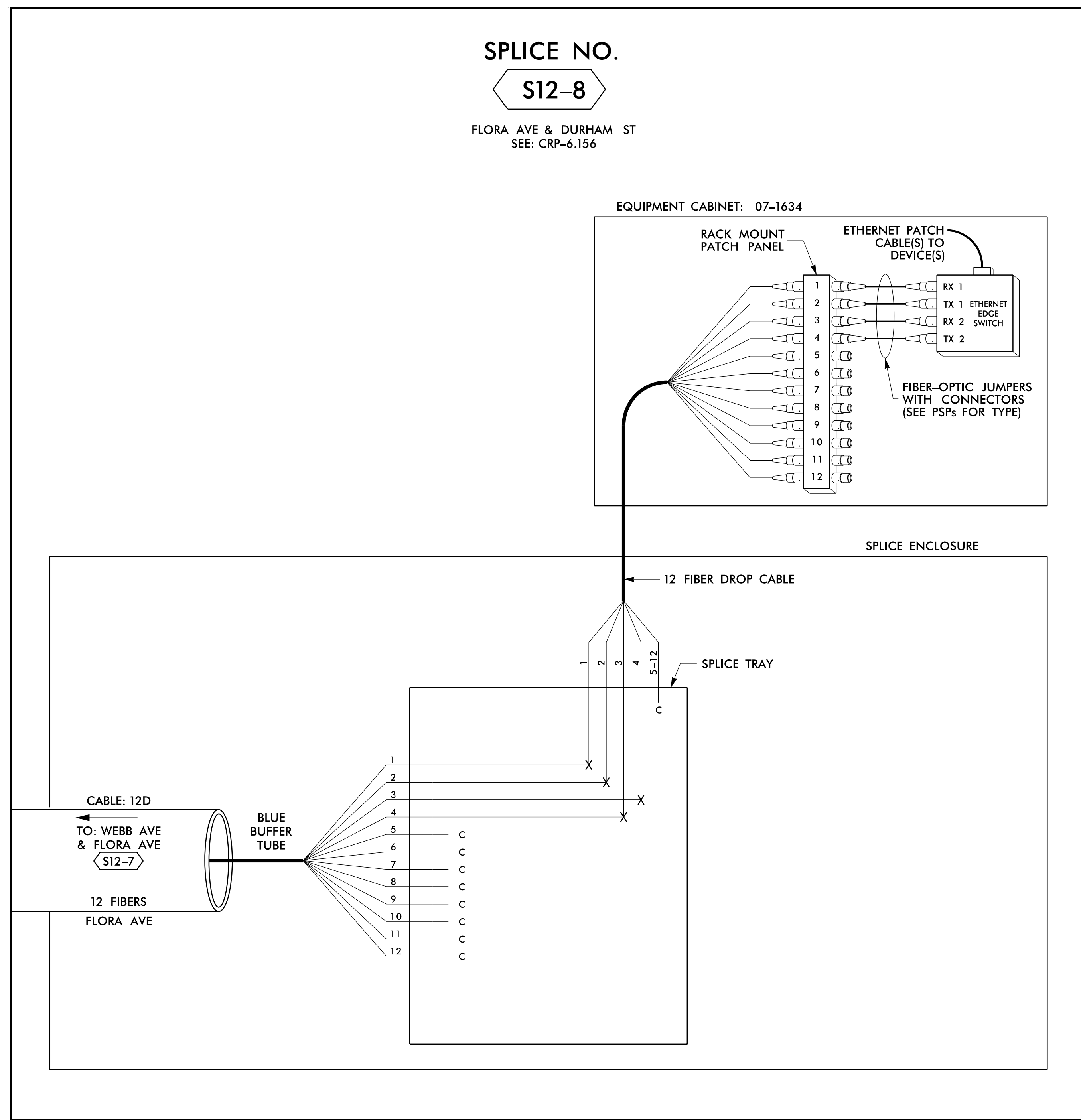

SPLICE NO.

S12-9

WEBB AVE & HAGGARD AVE
SEE: CRP-6.130

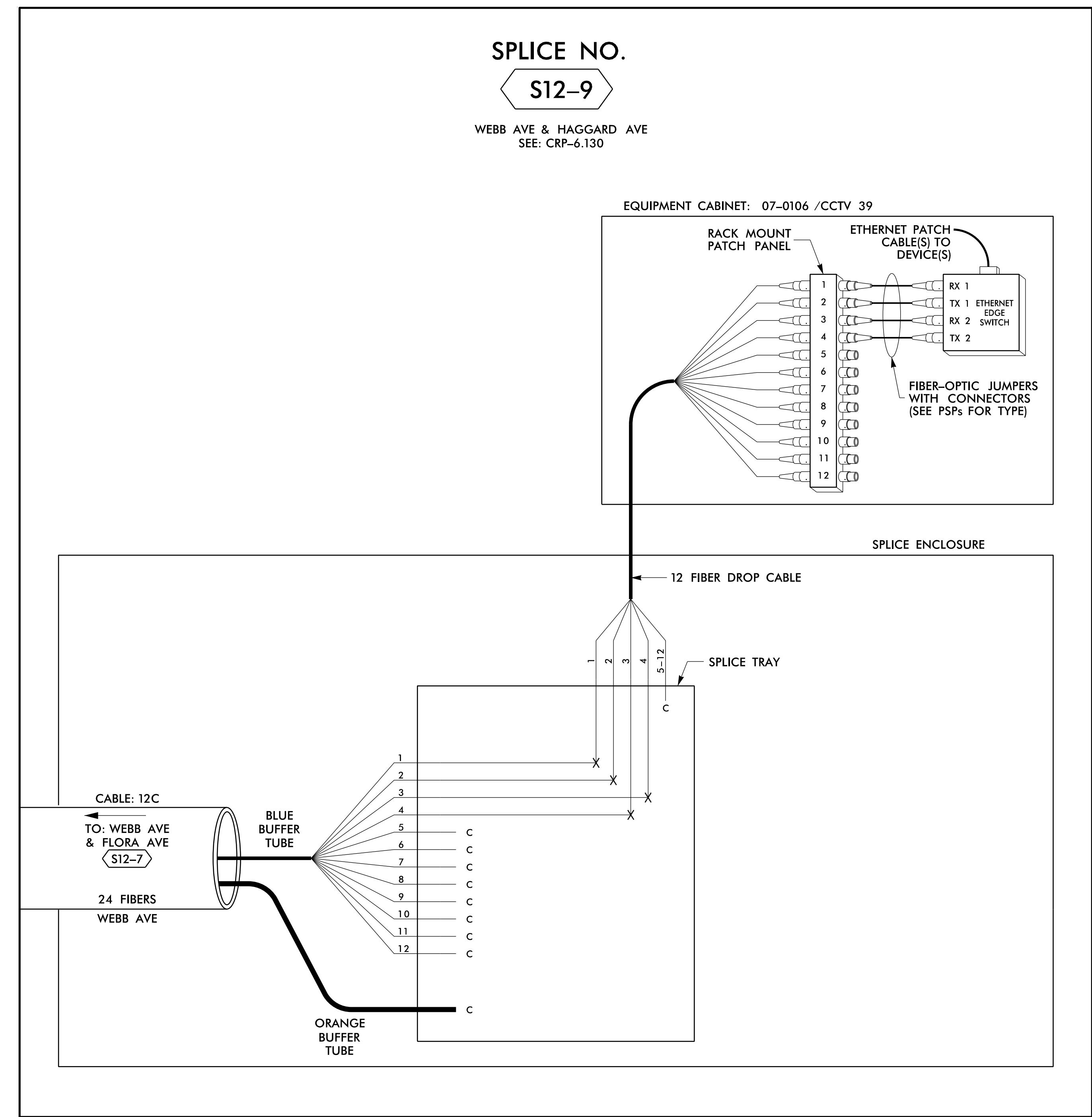

14 JUN 2018 12:29
 D:\projects\atkins\proj\11\11_00056469 U-6015 B-C Sig_Sys\Task 11_Corrs\F S 4.078.dgn
 S:\033633 AT_LLJ355433

LEGEND

COLOR CODE TIA/EIA 598-B		X = FUSION SPlice INDIVIDUAL FIBER	
(1) BLUE	(7) RED	EXPRESS	EXPRESS ENTIRE BUFFER TUBE /FIBERS THROUGH WITHOUT CUTTING
(2) ORANGE	(8) BLACK	BUFFER SPlice	SPlice ALL FIBERS IN BUFFER TUBE COLOR TO COLOR
(3) GREEN	(9) YELLOW	EXISTING	EXISTING BUFFER TUBE /FIBERS DO NOT MODIFY EXISTING SPlices OR EXPRESSED FIBERS.
(4) BROWN	(10) VIOLET		
(5) SLATE	(11) ROSE		
(6) WHITE	(12) AQUA		
		C =	CAP AND SEAL

NOTES

1. UNUSED FIBERS LEFT COILED AND STORED IN SPLICE TRAY
2. UNUSED BUFFER TUBES LEFT COILED AND STORED IN SPLICE ENCLOSURE
3. EDGE SWITCH CONFIGURATIONS ARE GENERIC. CONTRACTOR IS RESPONSIBLE FOR DETERMINING/ENSURING THE PROPER TERMINATIONS.

ATKINS 1616 EAST MILLBROOK ROAD, SUITE 160
RALEIGH, NORTH CAROLINA 27609
(919) 876-6888 NCBEEES #F-0326

DOCUMENT NOT CONSIDERED FINAL UNLESS ALL SIGNATURES COMPLETED

	Prepared for the Offices of: 		SEAL NORTH CAROLINA PROFESSIONAL ENGINEER BRADFORD J. SLOCOM License No. 040877 Date: 6/15/2018
	Burlington-Graham Signal System Fiber-Optic Splicing Details		
	Division 7 Alamance County PLAN DATE: June 2018 PREPARED BY: BJ SLOCUM	Burlington & Graham REVIEWED BY: HA BADGETT REVIEWED BY: DL JONES	
	SCALE: N/A	REVISIONS: _____ INIT. DATE _____	

SPLICE NO.

S13-1

FRONT ST & TARLETON AVE
SEE: CRP-6.137

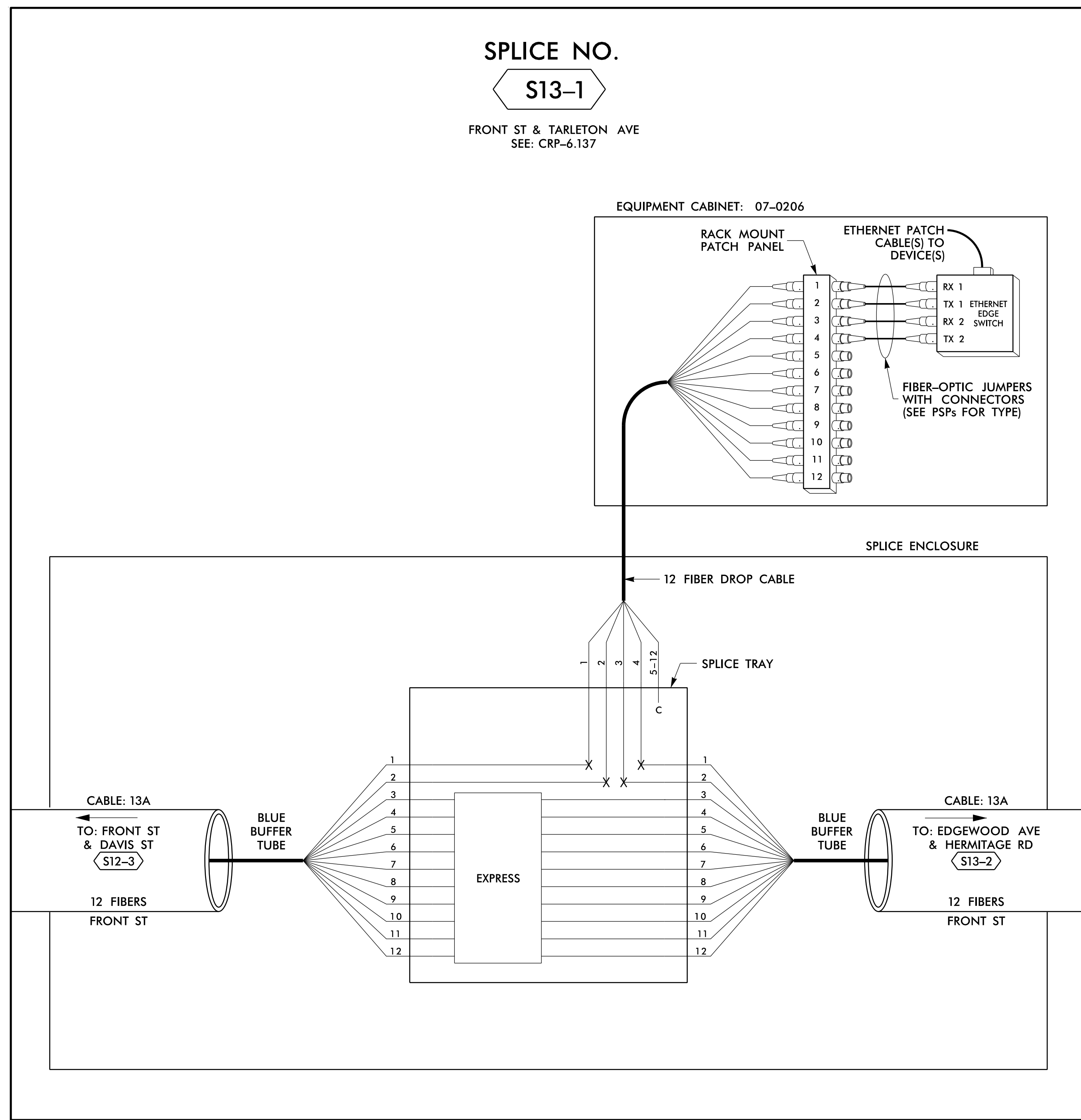

LEGEND

COLOR CODE TIA/EIA 598-B		X = FUSION SPlice INDIVIDUAL FIBER	
(1) BLUE	(7) RED	C = CAP AND SEAL	EXPRESS ENTIRE BUFFER TUBE / FIBERS THROUGH WITHOUT CUTTING
(2) ORANGE	(8) BLACK		BUFFER SPlice
(3) GREEN	(9) YELLOW		EXISTING
(4) BROWN	(10) VIOLET		EXPRESS ENTIRE BUFFER TUBE / FIBERS DO NOT MODIFY EXISTING SPlices OR EXPRESSED FIBERS.
(5) SLATE	(11) ROSE		
(6) WHITE	(12) AQUA		

NOTES

- UNUSED FIBERS LEFT COILED AND STORED IN SPLICE TRAY
- UNUSED BUFFER TUBES LEFT COILED AND STORED IN SPLICE ENCLOSURE
- EDGE SWITCH CONFIGURATIONS ARE GENERIC. CONTRACTOR IS RESPONSIBLE FOR DETERMINING/ENSURING THE PROPER TERMINATIONS.

ATKINS 1616 EAST MILLBROOK ROAD, SUITE 160
RALEIGH, NORTH CAROLINA 27609
(919) 876-6888 NCBEE# F-0326

DOCUMENT NOT CONSIDERED FINAL UNLESS ALL SIGNATURES COMPLETED

	Prepared for the Offices of: NORTH CAROLINA DEPARTMENT OF TRANSPORTATION Division 7		SEAL NORTH CAROLINA PROFESSIONAL ENGINEER SEAL 040877 BRADFORD J. SLOCUM ENGINEER 15/2018
	Burlington-Graham Signal System Fiber-Optic Splicing Details		
750 Greenfield Parkway, Garner, NC 27529 SCALE: N/A	PLAN DATE: June 2018 PREPARED BY: BJ SLOCUM	REVIEWED BY: HA BADGETT REVIEWED BY: DL JONES	REVISIONS INIT. DATE

14 JUN 2018 12:29
 D:\Technical\Projects\U-6015 B-C Sig. Sys\Task 11_Comm\F5 4.079.dgn
 S:\DCS\653 AT_LUS\55433

SPLICE NO.
S13-2

EDGEWOOD AVE & HERMITAGE RD
 SEE: CRP-6.151

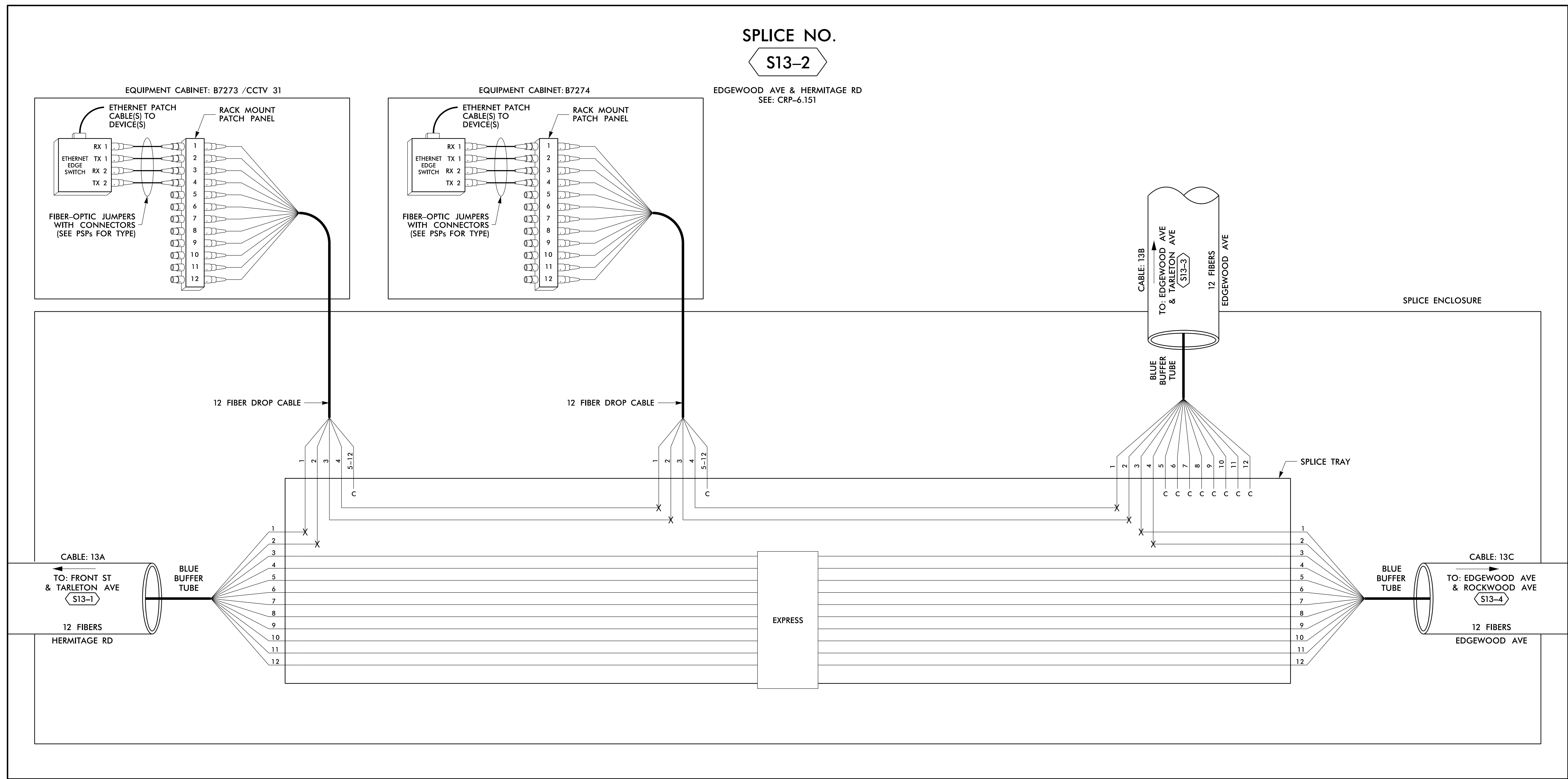

LEGEND

COLOR CODE TIA/EIA 598-B		X = FUSION SPLICE INDIVIDUAL FIBER C = CAP AND SEAL
(1) BLUE	(7) RED	EXPRESS
(2) ORANGE	(8) BLACK	EXPRESS ENTIRE BUFFER TUBE / FIBERS THROUGH WITHOUT CUTTING
(3) GREEN	(9) YELLOW	BUFFER SPLICE
(4) BROWN	(10) VIOLET	SPLICE ALL FIBERS IN BUFFER TUBE COLOR TO COLOR
(5) SLATE	(11) ROSE	EXISTING
(6) WHITE	(12) AQUA	EXISTING BUFFER TUBE / FIBERS DO NOT MODIFY EXISTING SPLICES OR EXPRESSED FIBERS.

NOTES

- UNUSED FIBERS LEFT COILED AND STORED IN SPLICE TRAY
- UNUSED BUFFER TUBES LEFT COILED AND STORED IN SPLICE ENCLOSURE
- EDGE SWITCH CONFIGURATIONS ARE GENERIC. CONTRACTOR IS RESPONSIBLE FOR DETERMINING/ENSURING THE PROPER TERMINATIONS.

ATKINS

1616 EAST MILLBROOK ROAD, SUITE 160
 RALEIGH, NORTH CAROLINA 27609
 (919) 876-6888 NCBES #F-0326

DOCUMENT NOT CONSIDERED FINAL UNLESS ALL SIGNATURES COMPLETED

Prepared for the Offices of: 750 Greenfield Parkway, Garner, NC 27529	Burlington-Graham Signal System Fiber-Optic Splicing Details		SEAL NORTH CAROLINA PROFESSIONAL ENGINEER SEAL 040877 BRADFORD J. SLOCUM 15/2018 DATE
	Division 7 Alamance County PLAN DATE: June 2018 PREPARED BY: BJ SLOCUM	Burlington & Graham REVIEWED BY: HA BADGETT REVIEWED BY: DL JONES	
REVISIONS: _____ INIT. _____ DATE _____			

14 JUN 2018 12:29
 D:\Technical\Projects\U-6015 B-C Sig Sys\Task 11_Comms\F5 4.080.dgn
 S:\DCS\653 AT_LUS355433

SPLICE NO.

S13-3

EDGEWOOD AVE & TARLETON AVE
SEE: CRP-6.153

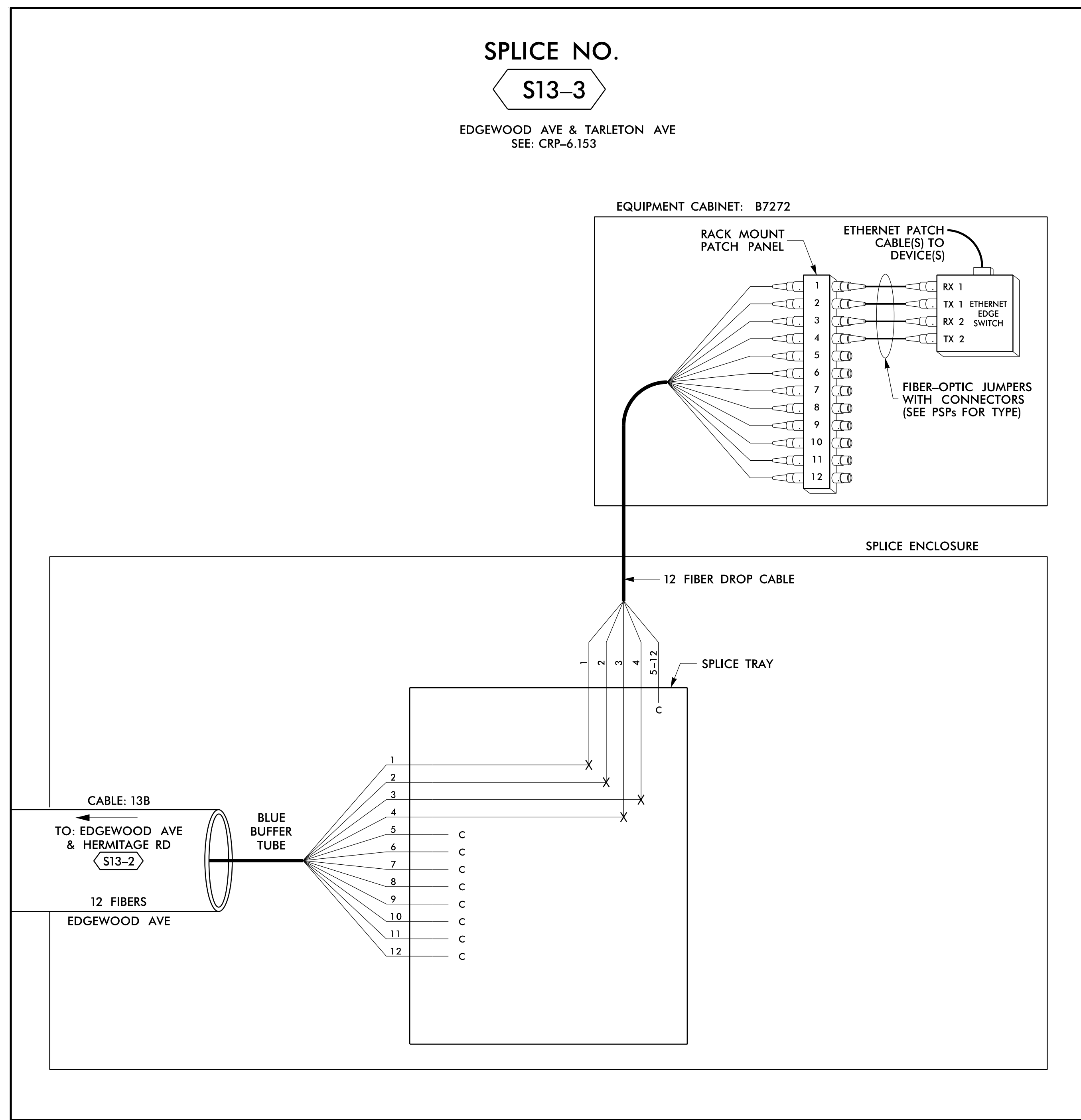

LEGEND

COLOR CODE TIA/EIA 598-B		X = FUSION SPLICE INDIVIDUAL FIBER	
(1) BLUE	(7) RED	EXPRESS	EXPRESS ENTIRE BUFFER TUBE / FIBERS THROUGH WITHOUT CUTTING
(2) ORANGE	(8) BLACK	BUFFER SPLICE	SPLICE ALL FIBERS IN BUFFER TUBE COLOR TO COLOR
(3) GREEN	(9) YELLOW	EXISTING	EXISTING BUFFER TUBE / FIBERS DO NOT MODIFY EXISTING SPLICES OR EXPRESSED FIBERS.
(4) BROWN	(10) VIOLET		
(5) SLATE	(11) ROSE		
(6) WHITE	(12) AQUA		
		C = CAP AND SEAL	

NOTES

1. UNUSED FIBERS LEFT COILED AND STORED IN SPLICE TRAY
2. UNUSED BUFFER TUBES LEFT COILED AND STORED IN SPLICE ENCLOSURE
3. EDGE SWITCH CONFIGURATIONS ARE GENERIC. CONTRACTOR IS RESPONSIBLE FOR DETERMINING/ENSURING THE PROPER TERMINATIONS.

ATKINS 1616 EAST MILLBROOK ROAD, SUITE 160
RALEIGH, NORTH CAROLINA 27609
(919) 876-6888 NCBEEES #F-0326

DOCUMENT NOT CONSIDERED FINAL
UNLESS ALL SIGNATURES COMPLETED

	Prepared for the Offices of: NORTH CAROLINA DEPARTMENT OF TRANSPORTATION Division 7		SEAL NORTH CAROLINA PROFESSIONAL ENGINEER SEAL 040877 BRADFORD J. SLOCUM ENGINEER 15/2018
	Burlington-Graham Signal System Fiber-Optic Splicing Details		
750 Greenfield Parkway, Garner, NC 27529 SCALE: N/A	PLAN DATE: June 2018 PREPARED BY: BJ SLOCUM	REVIEWED BY: HA BADGETT REVIEWED BY: DL JONES	BURLINGTON & GRAHAM ALAMANCE COUNTY
	REVISIONS INIT. DATE		DATE

14 JUN 2018 12:29
 D:\projects\2018\11-Comms\11-Comms\F4_081.dgn
 S:\DCS\653 AT LUIS355433

SPLICE NO.

S13-4

EDGEWOOD AVE & ROCKWOOD AVE
SEE: CRP-6.150

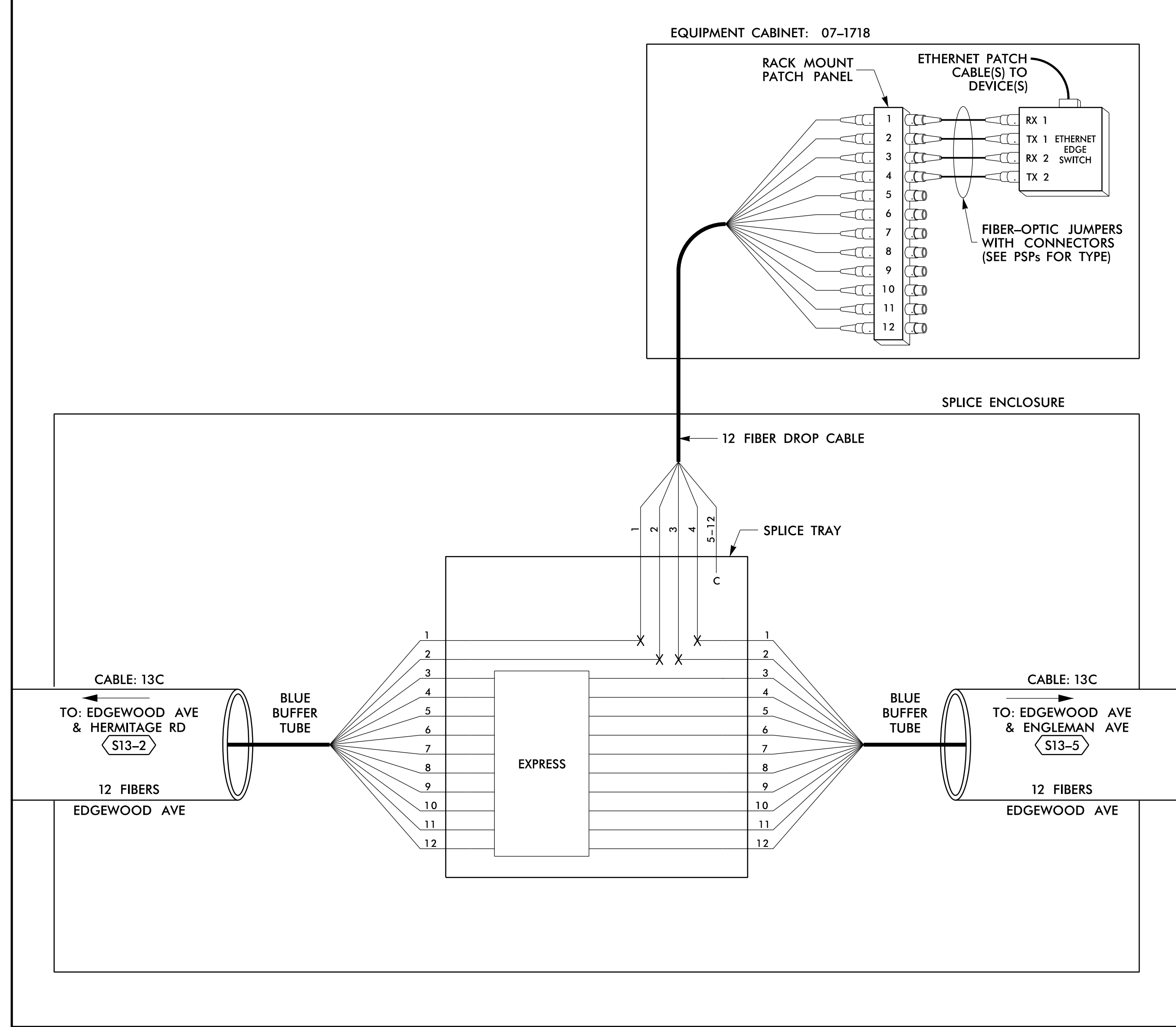

SPLICE NO.

S13-5

EDGEWOOD AVE & ENGLEMAN AVE
SEE: CRP-6.149

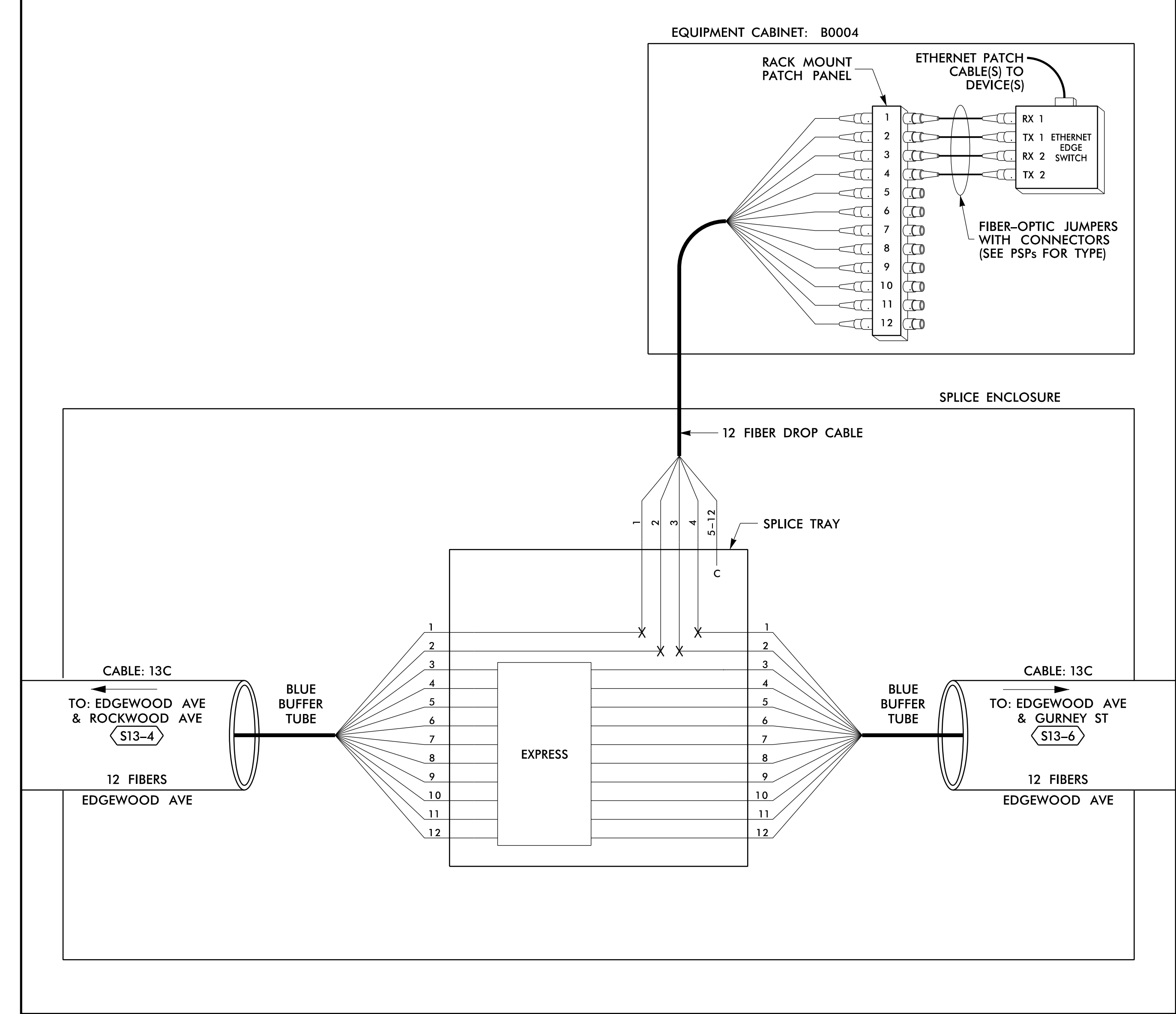

14 JUN 2018 12:29
 D:\projects\atkins\proj\11\1100056469 U-6015 B-C Sig Sys\Task 11_Comm\Fs 4_082.dgn
 S:\033633 AT_LUS355433

LEGEND

COLOR CODE TIA/EIA 598-B		X = FUSION SPlice INDIVIDUAL FIBER C = CAP AND SEAL
(1) BLUE	(7) RED	EXPRESS
(2) ORANGE	(8) BLACK	BUFFER SPlice
(3) GREEN	(9) YELLOW	EXISTING
(4) BROWN	(10) VIOLET	
(5) SLATE	(11) ROSE	
(6) WHITE	(12) AQUA	

NOTES

- UNUSED FIBERS LEFT COILED AND STORED IN SPLICE TRAY
- UNUSED BUFFER TUBES LEFT COILED AND STORED IN SPLICE ENCLOSURE
- EDGE SWITCH CONFIGURATIONS ARE GENERIC. CONTRACTOR IS RESPONSIBLE FOR DETERMINING/ENSURING THE PROPER TERMINATIONS.

ATKINS 1616 EAST MILLBROOK ROAD, SUITE 160
 RALEIGH, NORTH CAROLINA 27609
 (919) 876-6888 NCBEE# F-0326

DOCUMENT NOT CONSIDERED FINAL UNLESS ALL SIGNATURES COMPLETED

Prepared for the Offices of: 750 Greenfield Parkway, Garner, NC 27529	Burlington-Graham Signal System Fiber-Optic Splicing Details		SEAL NORTH CAROLINA PROFESSIONAL ENGINEER SEAL 040877 BRADFORD J. SLOCUM 15/2018 DATE
	Division 7 Alamance County PLAN DATE: June 2018 PREPARED BY: BJ SLOCUM	Burlington & Graham REVIEWED BY: HA BADGETT REVIEWED BY: DL JONES	

SPLICE NO.

S13-6

EDGEWOOD AVE & GURNEY ST
SEE: CRP-6.148

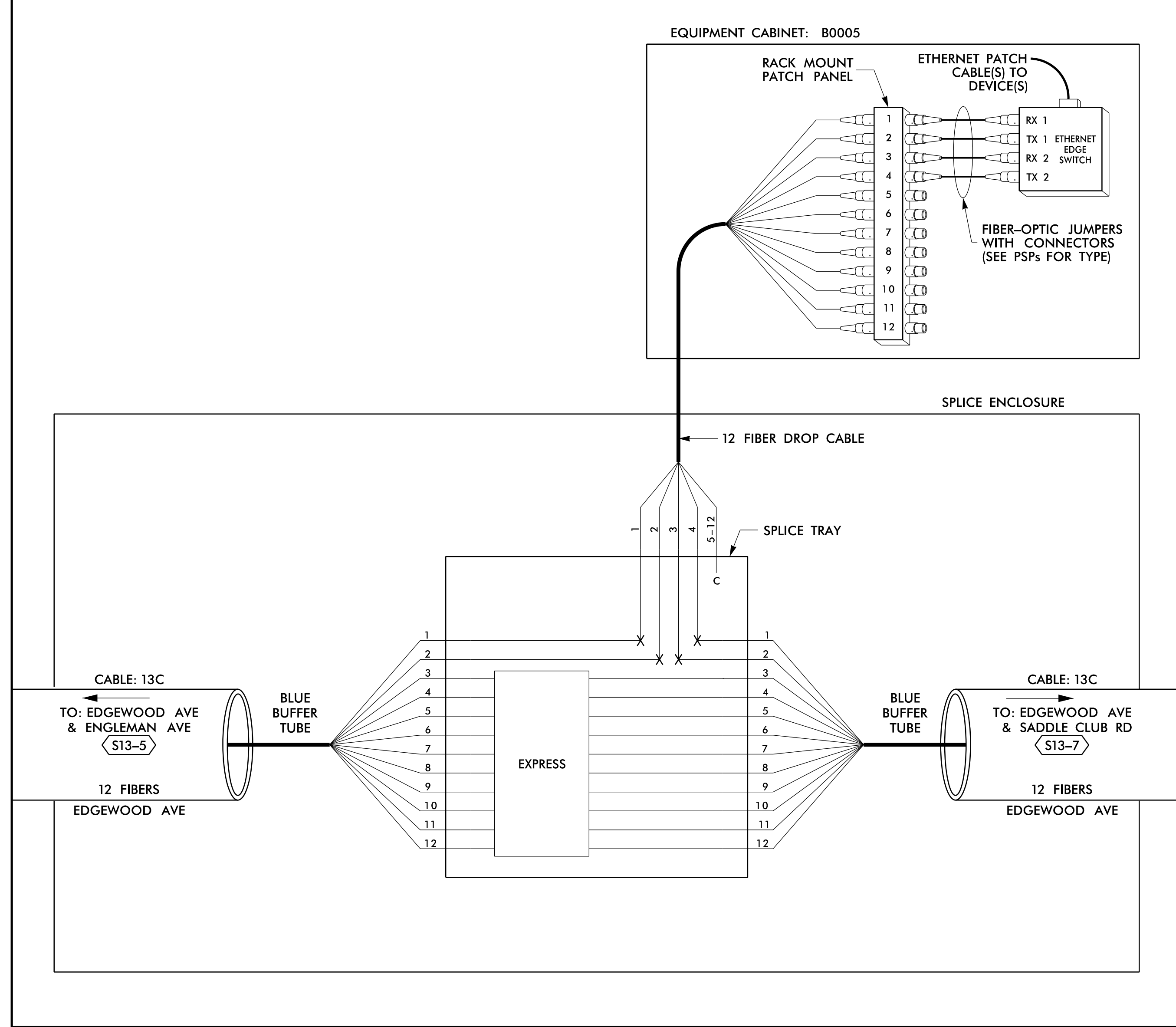

SPLICE NO.

S13-7

EDGEWOOD AVE & SADDLE CLUB RD
SEE: CRP-6.147

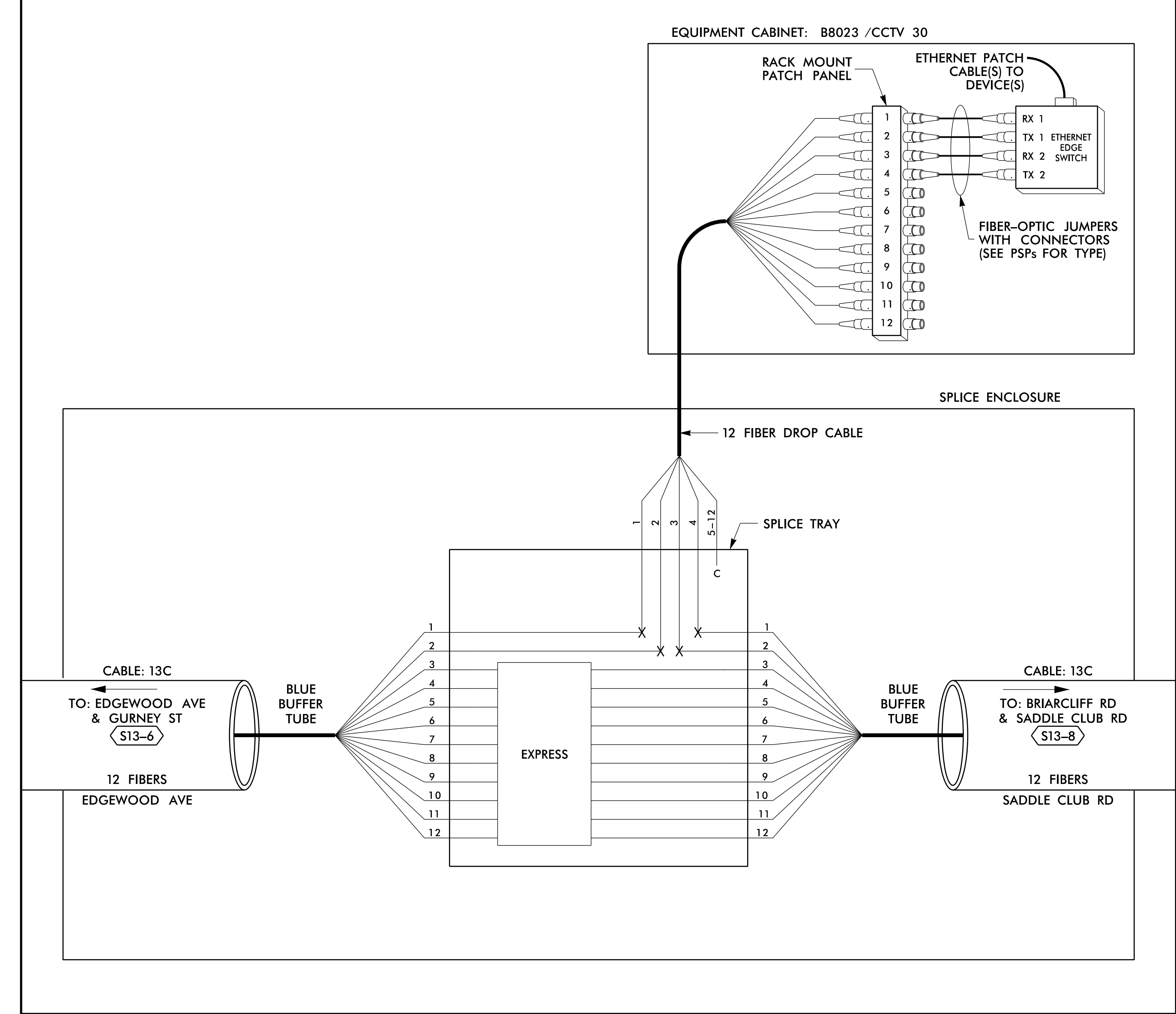

14-JUN-2018 12:30
 D:\projects\proj\11\comms\11_11\comms\11_11\comms\F S 4.083.dgn
 S:\projects\proj\11\comms\11_11\comms\11_11\comms\F S 4.083.dgn

LEGEND

COLOR CODE TIA/EIA 598-B		X = FUSION SPlice INDIVIDUAL FIBER C = CAP AND SEAL
(1) BLUE	(7) RED	EXPRESS
(2) ORANGE	(8) BLACK	BUFFER SPlice
(3) GREEN	(9) YELLOW	EXISTING
(4) BROWN	(10) VIOLET	
(5) SLATE	(11) ROSE	
(6) WHITE	(12) AQUA	

NOTES

1. UNUSED FIBERS LEFT COILED AND STORED IN SPLICE TRAY
2. UNUSED BUFFER TUBES LEFT COILED AND STORED IN SPLICE ENCLOSURE
3. EDGE SWITCH CONFIGURATIONS ARE GENERIC. CONTRACTOR IS RESPONSIBLE FOR DETERMINING/ENSURING THE PROPER TERMINATIONS.

ATKINS 1616 EAST MILLBROOK ROAD, SUITE 160
 RALEIGH, NORTH CAROLINA 27609
 (919) 876-6888 NCBEEES #F-0326

**DOCUMENT NOT CONSIDERED FINAL
 UNLESS ALL SIGNATURES COMPLETED**

Prepared for the Offices of: 750 Greenfield Parkway, Garner, NC 27529	Burlington-Graham Signal System Fiber-Optic Splicing Details		SEAL NORTH CAROLINA PROFESSIONAL SEAL 040877 ENGINEER BRADFORD J. SLOCUM 15/2018 DATE
	Division 7 Alamance County	Burlington & Graham	
	PLAN DATE: June 2018	REVIEWED BY: HA BADGETT	
	PREPARED BY: BJ SLOCUM	REVIEWED BY: DL JONES	
SCALE N/A	REVISIONS	INIT. DATE	DATE

SPLICE NO.

S13-8

BRIARCLIFF RD & SADDLE CLUB RD
SEE: CRP-6.146

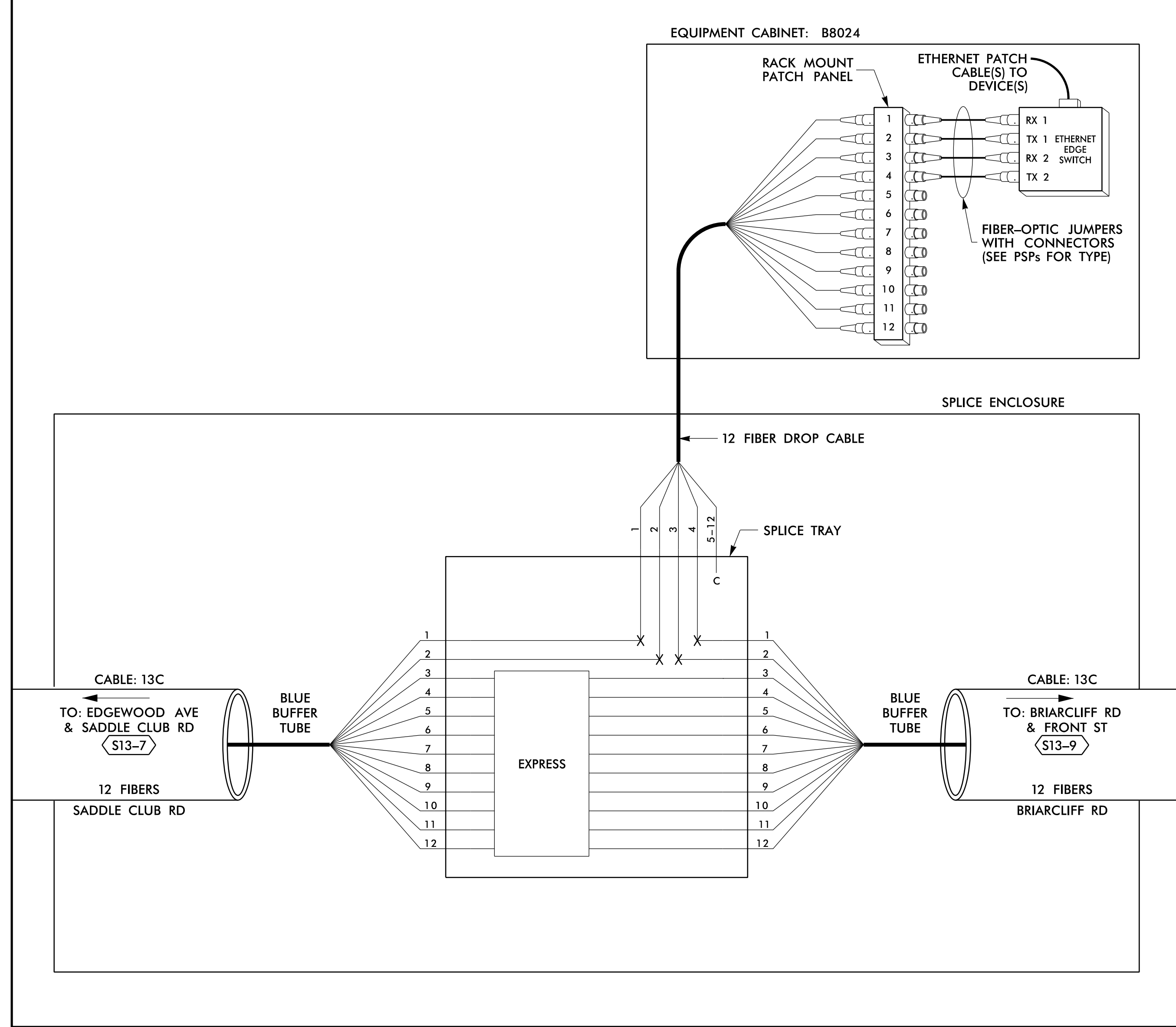

SPLICE NO.

S13-9

BRIARCLIFF RD & FRONT ST
SEE: CRP-6.145

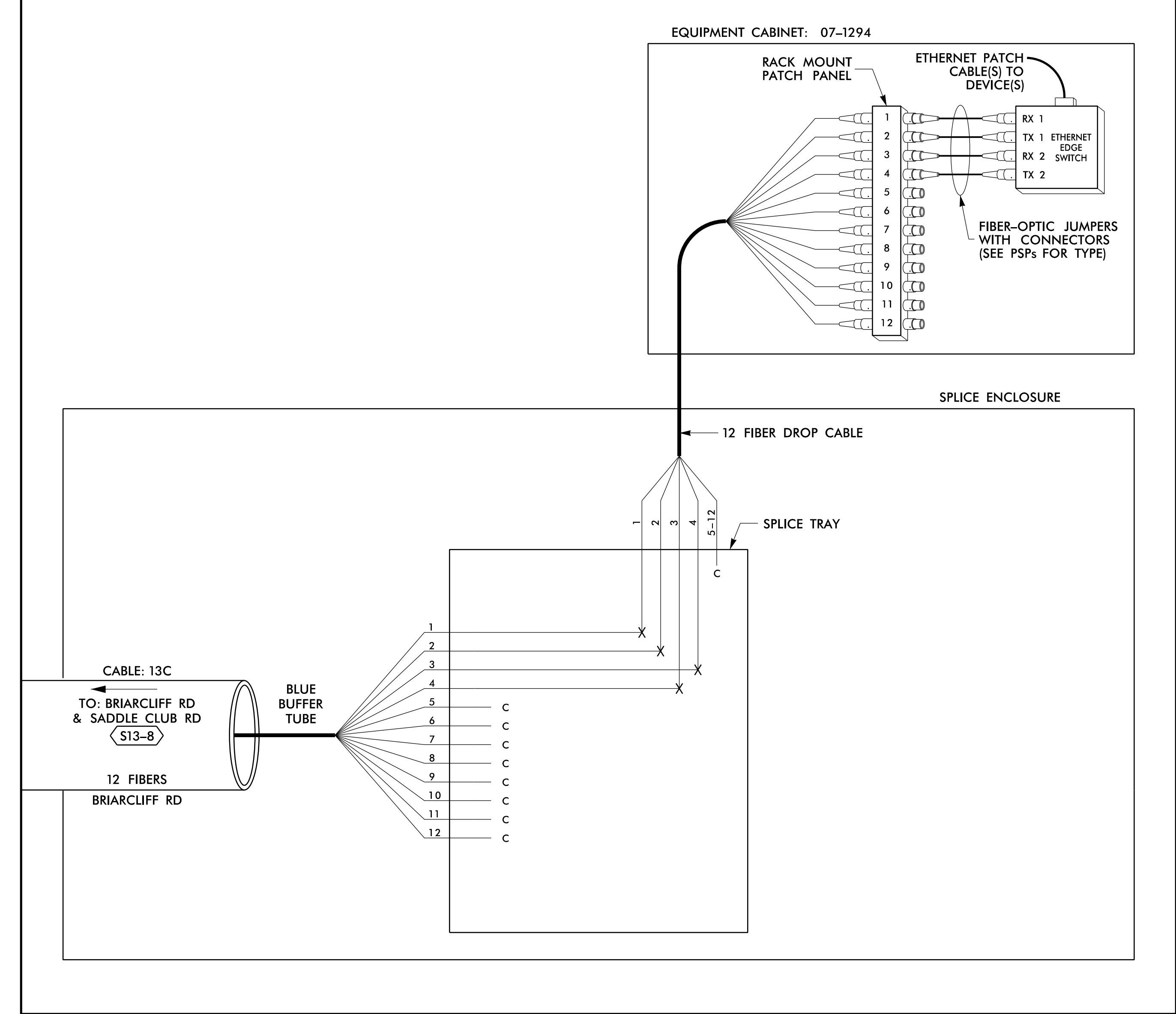

14 JUN 2018 12:30
 D:\projects\proj\11\comms\11_00056469 U-6015 B-C Sig_Sys\Task 11_Comms\F S 4_084.dgn
 SLOD3653 AT LUS355433

LEGEND

COLOR CODE TIA/EIA 598-B		X = FUSION SPLICE INDIVIDUAL FIBER C = CAP AND SEAL
(1) BLUE	(7) RED	EXPRESS
(2) ORANGE	(8) BLACK	BUFFER SPLICE
(3) GREEN	(9) YELLOW	EXISTING
(4) BROWN	(10) VIOLET	
(5) SLATE	(11) ROSE	
(6) WHITE	(12) AQUA	

NOTES

- UNUSED FIBERS LEFT COILED AND STORED IN SPLICE TRAY
- UNUSED BUFFER TUBES LEFT COILED AND STORED IN SPLICE ENCLOSURE
- EDGE SWITCH CONFIGURATIONS ARE GENERIC. CONTRACTOR IS RESPONSIBLE FOR DETERMINING/ENSURING THE PROPER TERMINATIONS.

ATKINS 1616 EAST MILLBROOK ROAD, SUITE 160
 RALEIGH, NORTH CAROLINA 27609
 (919) 876-6888 NCBES #F-0326

**DOCUMENT NOT CONSIDERED FINAL
 UNLESS ALL SIGNATURES COMPLETED**

Prepared for the Offices of: NORTH CAROLINA DEPARTMENT OF TRANSPORTATION 750 Greenfield Parkway, Garner, NC 27529	Burlington-Graham Signal System Fiber-Optic Splicing Details		SEAL NORTH CAROLINA PROFESSIONAL SEAL 040877 ENGINEER Bradford J. Slocum 15/2018
	Division 7 Alamance County PLAN DATE: June 2018 PREPARED BY: BJ SLOCUM	Burlington & Graham REVIEWED BY: HA BADGETT REVIEWED BY: DL JONES	

SPLICE NO.

S14-1

CHURCH ST & GLENWOOD AVE
SEE: CRP-6.022

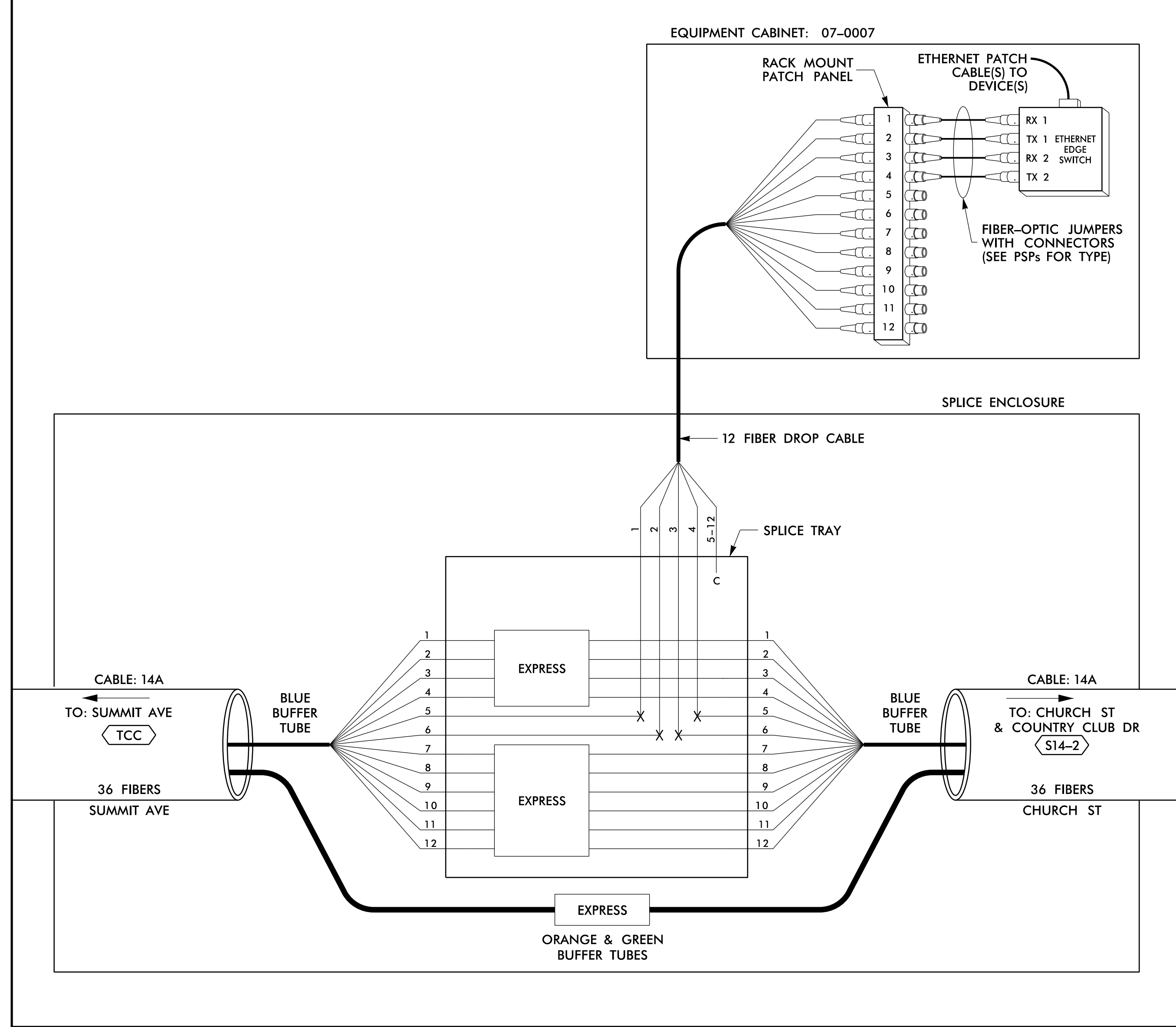

SPLICE NO.

S14-2

CHURCH ST & COUNTRY CLUB DR
SEE: CRP-6.021

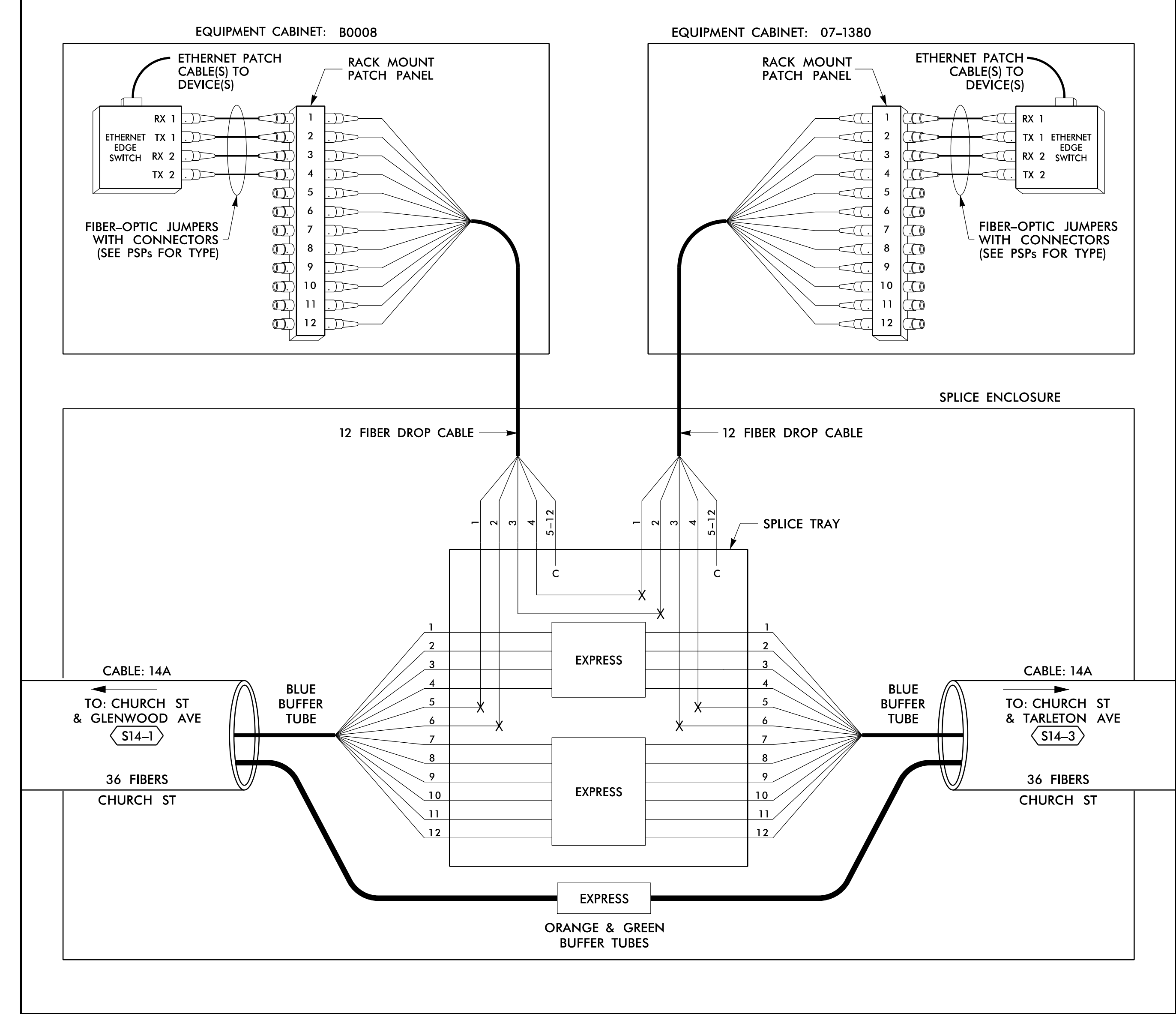

14 JUN 2018 12:30
 D:\projects\proj\100056469 U-6015 B-C Sig Sys\Task 11_Corrs\F S 4.085.dgn
 S:\DCS\653 AT_LUS355433

LEGEND

COLOR CODE TIA/EIA 598-B		X = FUSION SPLICE INDIVIDUAL FIBER	
(1) BLUE	(7) RED	EXPRESS	EXPRESS ENTIRE BUFFER TUBE / FIBERS THROUGH WITHOUT CUTTING
(2) ORANGE	(8) BLACK	BUFFER SPLICE	SPLICE ALL FIBERS IN BUFFER TUBE COLOR TO COLOR
(3) GREEN	(9) YELLOW	EXISTING	EXISTING BUFFER TUBE / FIBERS DO NOT MODIFY EXISTING SPLICES OR EXPRESSED FIBERS.
(4) BROWN	(10) VIOLET		
(5) SLATE	(11) ROSE		
(6) WHITE	(12) AQUA		

NOTES

- UNUSED FIBERS LEFT COILED AND STORED IN SPLICE TRAY
- UNUSED BUFFER TUBES LEFT COILED AND STORED IN SPLICE ENCLOSURE
- EDGE SWITCH CONFIGURATIONS ARE GENERIC. CONTRACTOR IS RESPONSIBLE FOR DETERMINING/ENSURING THE PROPER TERMINATIONS.

ATKINS 1616 EAST MILLBROOK ROAD, SUITE 160
RALEIGH, NORTH CAROLINA 27609
(919) 876-6888 NCBEEES #F-0326

DOCUMENT NOT CONSIDERED FINAL UNLESS ALL SIGNATURES COMPLETED

	Prepared for the Offices of: Burlington-Graham Signal System Fiber-Optic Splicing Details		
	Division 7 Alamance County PLAN DATE: June 2018 PREPARED BY: BJ SLOCUM	Burlington & Graham REVIEWED BY: HA BADGETT REVIEWED BY: DL JONES	

SPLICE NO.

S14-3

CHURCH ST & TARLETON AVE
SEE: CRP-6.020

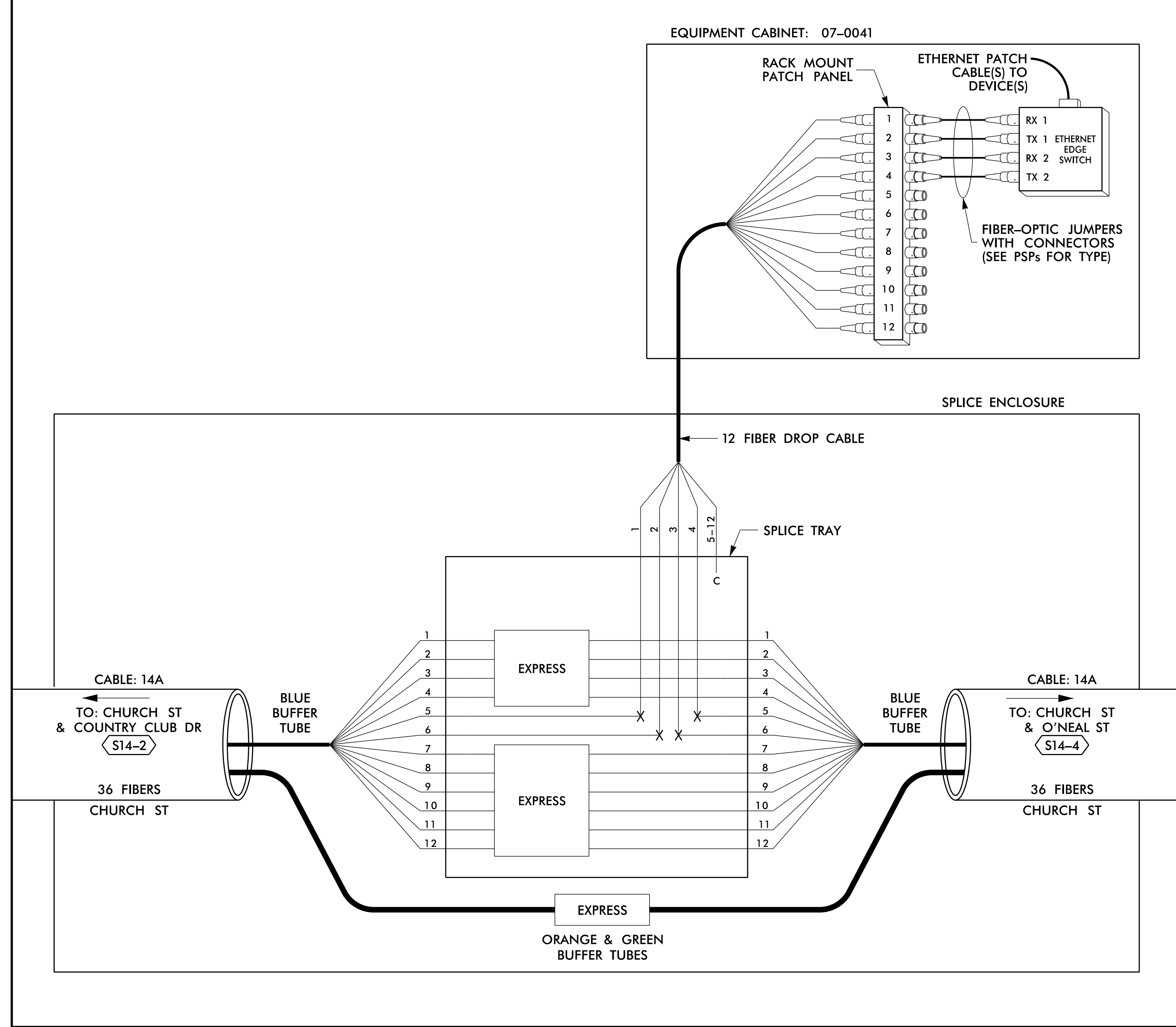

SPLICE NO.

S14-4

CHURCH ST & O'NEAL ST
SEE: CRP-6.019

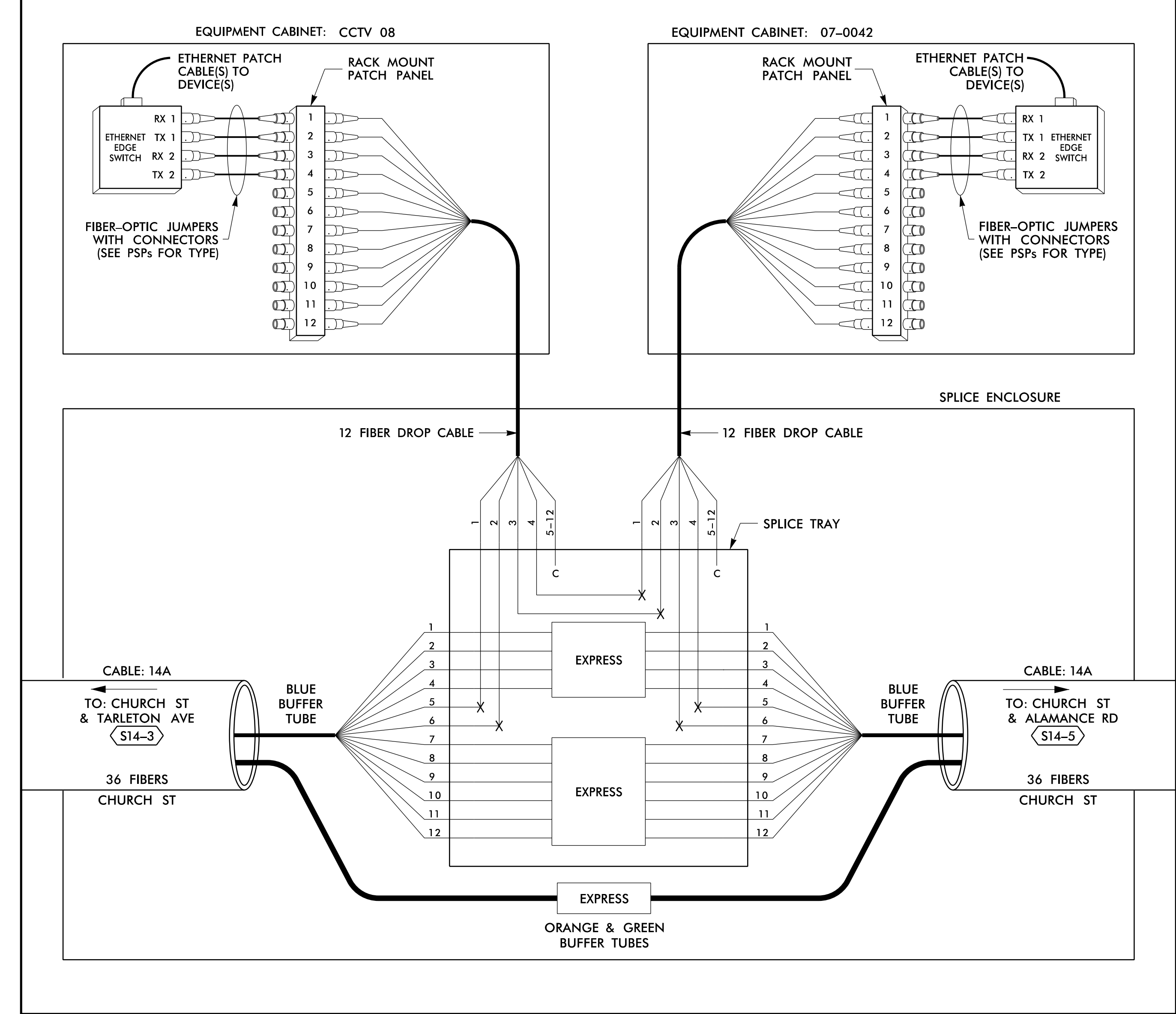

14 JUN 2018 12:30
 D:\projects\proj\100056463 U-6015 B-C Sig Sys\Task 11_Coms\Fs 4.086.dgn
 S:\DCS\653 AT_LUS355433

LEGEND

COLOR CODE TIA/EIA 598-B		X = FUSION SPLICE INDIVIDUAL FIBER C = CAP AND SEAL
(1) BLUE	(7) RED	EXPRESS
(2) ORANGE	(8) BLACK	EXPRESS ENTIRE BUFFER TUBE / FIBERS THROUGH WITHOUT CUTTING
(3) GREEN	(9) YELLOW	BUFFER SPLICE
(4) BROWN	(10) VIOLET	SPLICE ALL FIBERS IN BUFFER TUBE COLOR TO COLOR
(5) SLATE	(11) ROSE	EXISTING
(6) WHITE	(12) AQUA	EXISTING BUFFER TUBE / FIBERS DO NOT MODIFY EXISTING SPLICES OR EXPRESSED FIBERS.

NOTES

- UNUSED FIBERS LEFT COILED AND STORED IN SPLICE TRAY
- UNUSED BUFFER TUBES LEFT COILED AND STORED IN SPLICE ENCLOSURE
- EDGE SWITCH CONFIGURATIONS ARE GENERIC. CONTRACTOR IS RESPONSIBLE FOR DETERMINING/ENSURING THE PROPER TERMINATIONS.

ATKINS 1616 EAST MILLBROOK ROAD, SUITE 160
 RALEIGH, NORTH CAROLINA 27609
 (919) 876-6888 NCBEEES #F-0326

Prepared for the Offices of: NORTH CAROLINA DEPARTMENT OF TRANSPORTATION		DOCUMENT NOT CONSIDERED FINAL UNLESS ALL SIGNATURES COMPLETED	
Burlington-Graham Signal System Fiber-Optic Splicing Details			
Division 7 Alamance County		Burlington & Graham	
PLAN DATE: June 2018	REVIEWED BY: HA BADGETT	PREPARED BY: BJ SLOCUM	REVIEWED BY: DL JONES
SCALE: N/A		REVISIONS: _____ INIT. DATE _____	
750 Greenfield Parkway, Garner, NC 27529		SEAL NORTH CAROLINA PROFESSIONAL ENGINEER SEAL 040877 BRADFORD J. SLOCUM 15/2018 DATE	

SPLICE NO.

S14-5

CHURCH ST & ALAMANCE RD
SEE: CRP-6.019

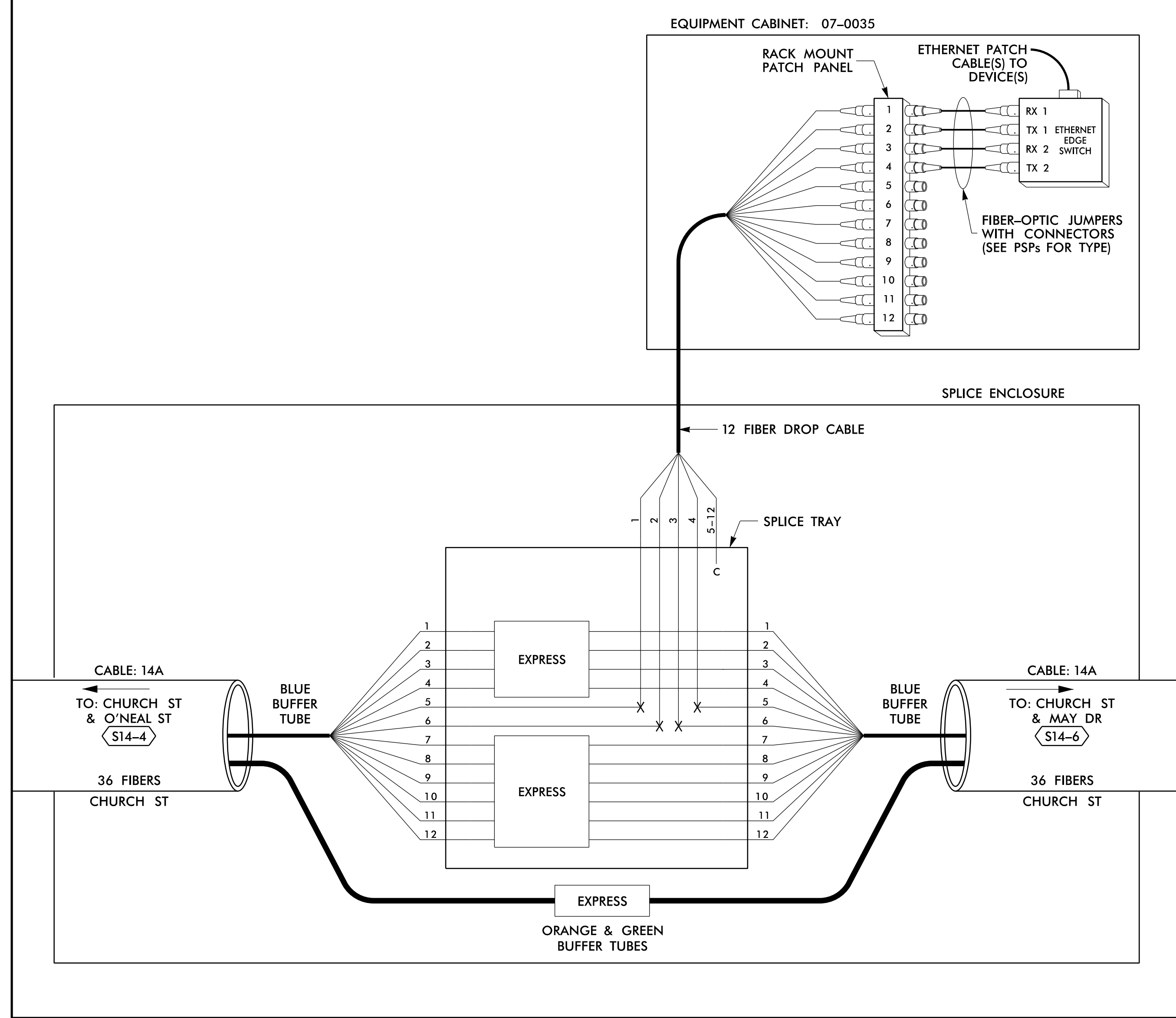

SPLICE NO.

S14-6

CHURCH ST & MAY DR
SEE: CRP-6.017

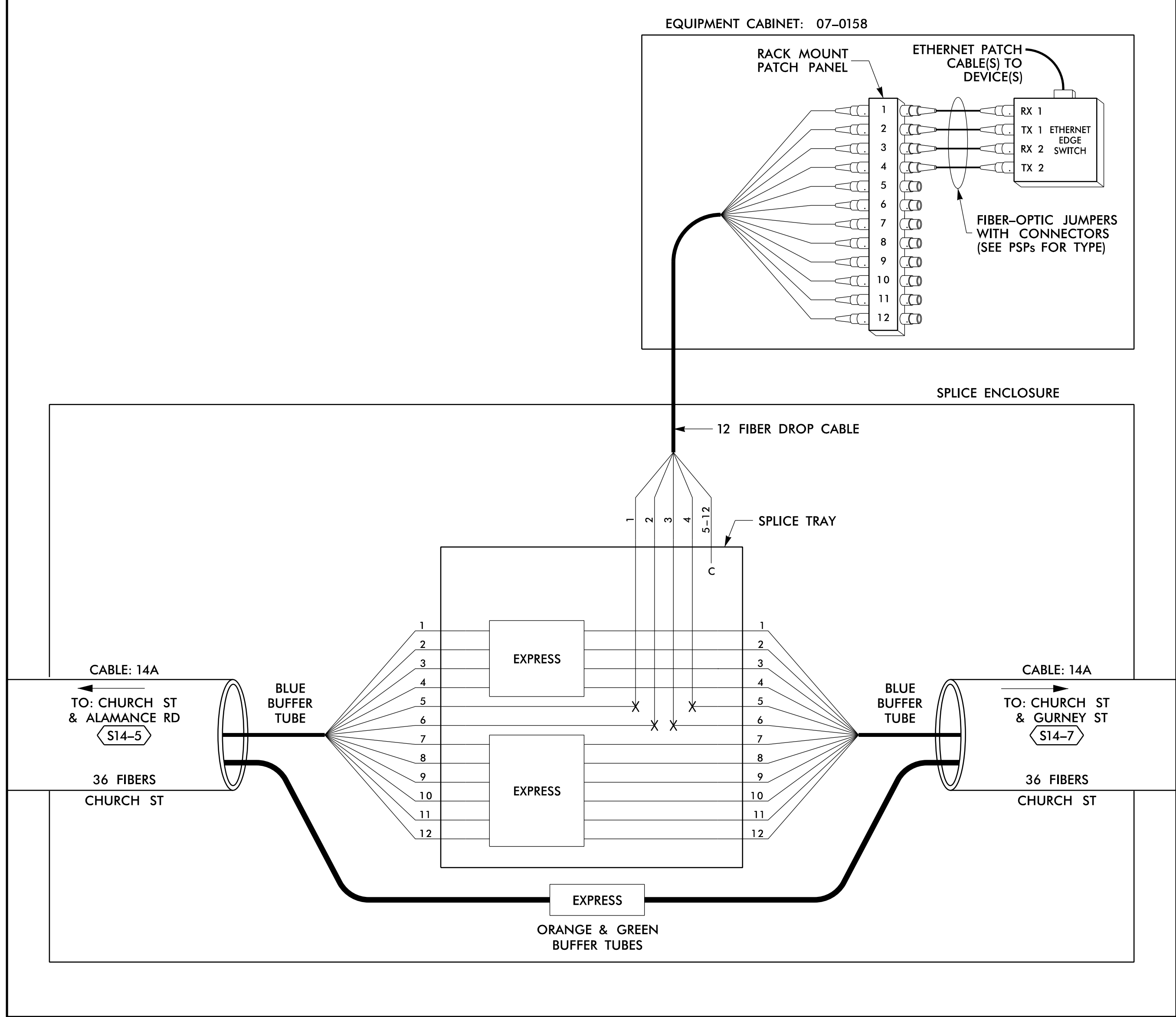

14 JUN 2018 12:30
 D:\projects\proj\100056469 U-6015 B-C Sig Sys\Task 11_Corrs\F_S 4_087.dgn
 S:\DCS\653 AT_LUS355433

LEGEND

COLOR CODE TIA/EIA 598-B		X = FUSION SPLICE INDIVIDUAL FIBER	EXPRESS	EXPRESS ENTIRE BUFFER TUBE / FIBERS THROUGH WITHOUT CUTTING
(1) BLUE	(7) RED	C = CAP AND SEAL	BUFFER SPLICE	SPLICE ALL FIBERS IN BUFFER TUBE COLOR TO COLOR
(2) ORANGE	(8) BLACK		EXISTING	EXISTING BUFFER TUBE / FIBERS DO NOT MODIFY EXISTING SPLICES OR EXPRESSED FIBERS.
(3) GREEN	(9) YELLOW			
(4) BROWN	(10) VIOLET			
(5) SLATE	(11) ROSE			
(6) WHITE	(12) AQUA			

NOTES

- UNUSED FIBERS LEFT COILED AND STORED IN SPLICE TRAY
- UNUSED BUFFER TUBES LEFT COILED AND STORED IN SPLICE ENCLOSURE
- EDGE SWITCH CONFIGURATIONS ARE GENERIC. CONTRACTOR IS RESPONSIBLE FOR DETERMINING/ENSURING THE PROPER TERMINATIONS.

ATKINS 1616 EAST MILLBROOK ROAD, SUITE 160
RALEIGH, NORTH CAROLINA 27609
(919) 876-6888 NCBEEES #F-0326

DOCUMENT NOT CONSIDERED FINAL UNLESS ALL SIGNATURES COMPLETED

	Prepared for the Offices of: Burlington-Graham Signal System Fiber-Optic Splicing Details		
	Division 7 Alamance County PLAN DATE: June 2018 PREPARED BY: BJ SLOCUM	Burlington & Graham REVIEWED BY: HA BADGETT REVIEWED BY: DL JONES	

SPLICE NO.

S14-7

CHURCH ST & GURNEY ST
SEE: CRP-6.016

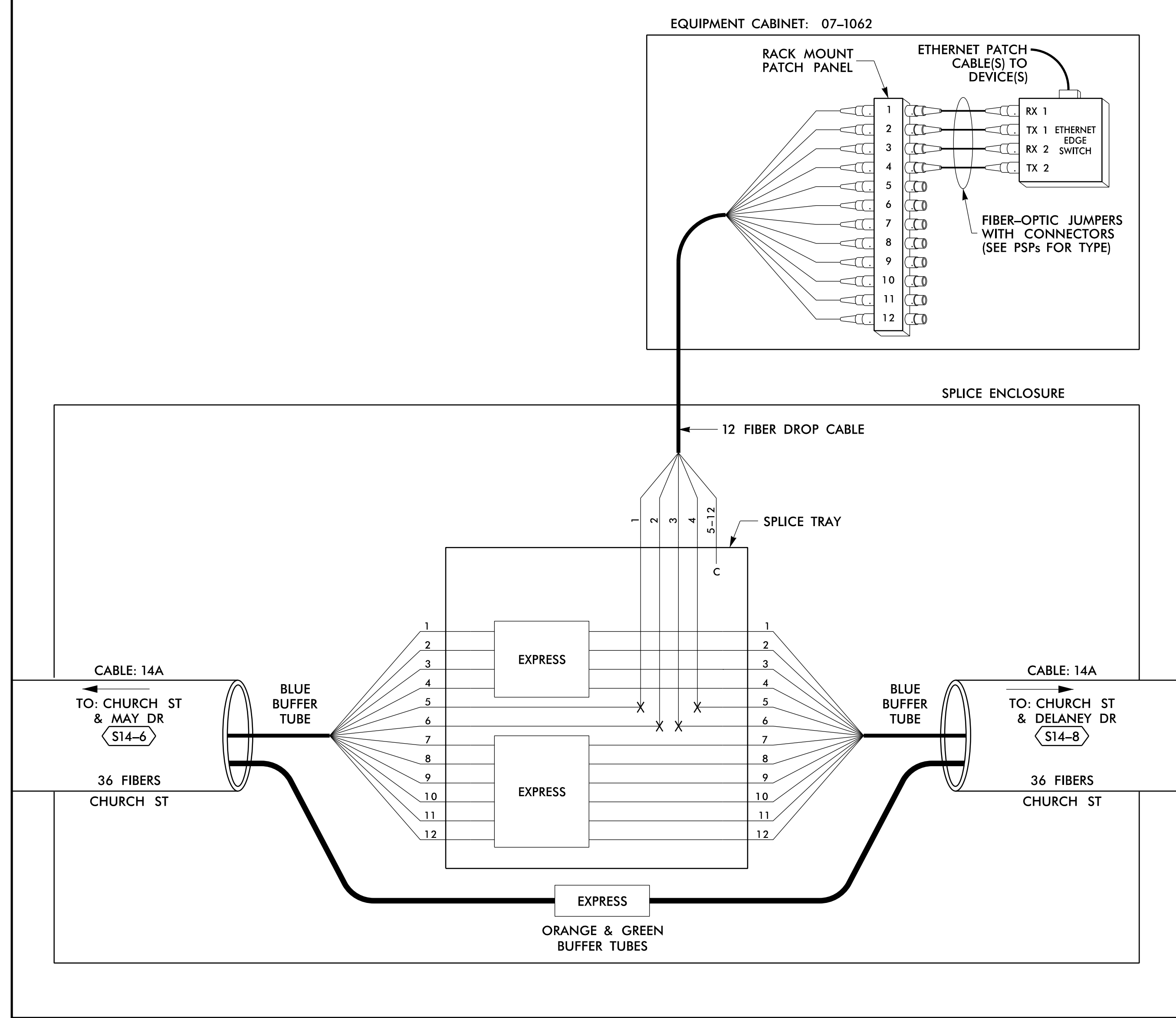

SPLICE NO.

S14-8

CHURCH ST & DELANEY DR
SEE: CRP-6.015

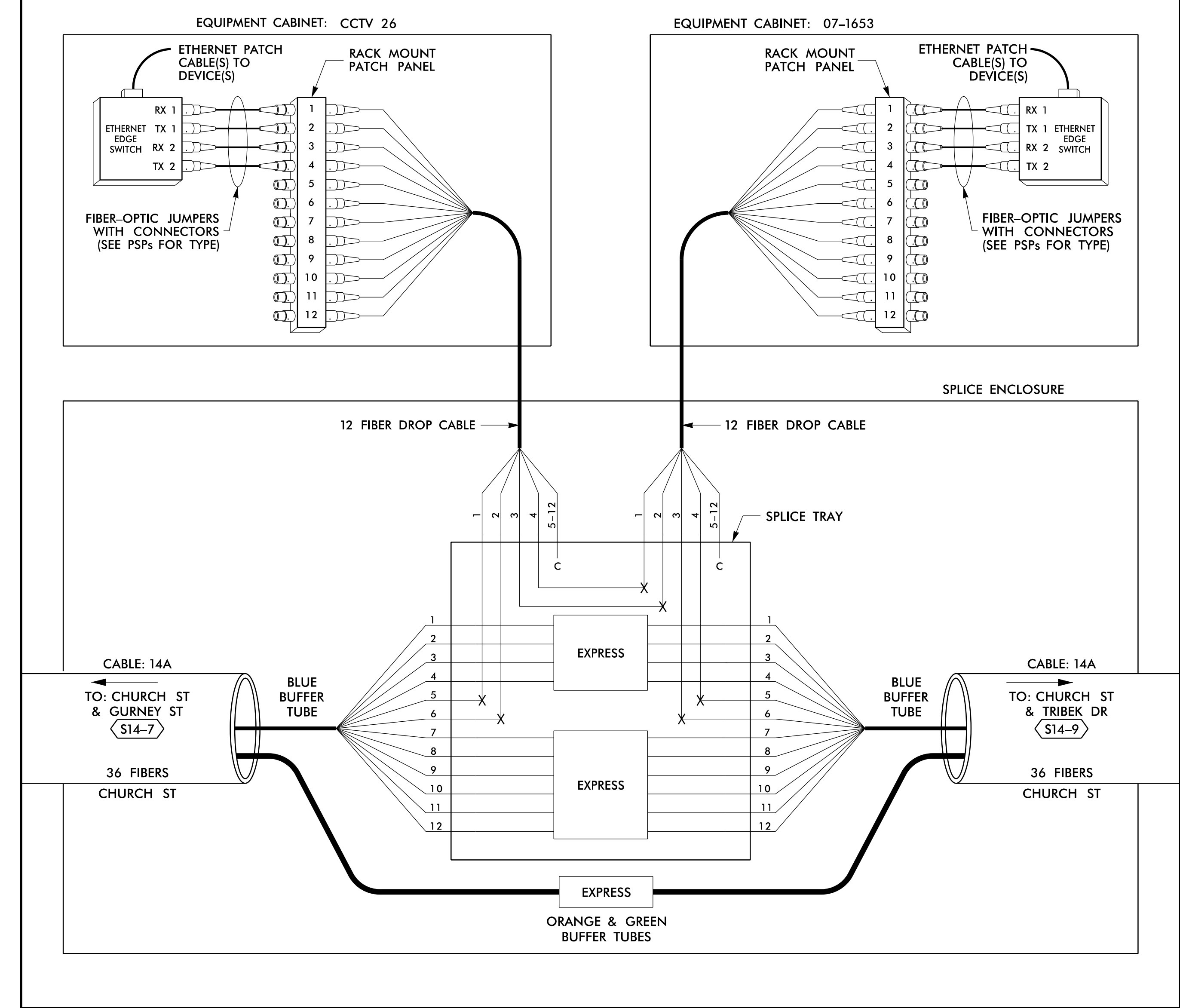

14 JUN 2018 12:30
 D:\Technical\proj\100056469 U-6015 B-C Sig Sys\Task 11_Corrs\F5 4.088.dgn
 S:\DCS\653 AT LUS355433

LEGEND

COLOR CODE TIA/EIA 598-B		X = FUSION SPLICE INDIVIDUAL FIBER C = CAP AND SEAL
(1) BLUE	(7) RED	EXPRESS
(2) ORANGE	(8) BLACK	BUFFER SPLICE
(3) GREEN	(9) YELLOW	EXISTING
(4) BROWN	(10) VIOLET	
(5) SLATE	(11) ROSE	
(6) WHITE	(12) AQUA	

EXPRESS ENTIRE BUFFER TUBE / FIBERS THROUGH WITHOUT CUTTING
 SPLICE ALL FIBERS IN BUFFER TUBE COLOR TO COLOR
 EXISTING BUFFER TUBE / FIBERS DO NOT MODIFY EXISTING SPLICES OR EXPRESSED FIBERS.

NOTES

- UNUSED FIBERS LEFT COILED AND STORED IN SPLICE TRAY
- UNUSED BUFFER TUBES LEFT COILED AND STORED IN SPLICE ENCLOSURE
- EDGE SWITCH CONFIGURATIONS ARE GENERIC. CONTRACTOR IS RESPONSIBLE FOR DETERMINING/ENSURING THE PROPER TERMINATIONS.

ATKINS 1616 EAST MILLBROOK ROAD, SUITE 160
 RALEIGH, NORTH CAROLINA 27609
 (919) 876-6888 NCBES #F-0326

DOCUMENT NOT CONSIDERED FINAL UNLESS ALL SIGNATURES COMPLETED

Prepared for the Offices of: NORTH CAROLINA DEPARTMENT OF TRANSPORTATION 750 Greenfield Parkway, Garner, NC 27529	Burlington-Graham Signal System Fiber-Optic Splicing Details		SEAL NORTH CAROLINA PROFESSIONAL ENGINEER SEAL 040877 BRADFORD J. SLOCUM 15/2018 DATE	
	Division 7	Alamance County		Burlington & Graham
	PLAN DATE: June 2018	REVIEWED BY: HA BADGETT		
	PREPARED BY: BJ SLOCUM	REVIEWED BY: DL JONES		
SCALE: N/A	REVISIONS	INIT.	DATE	

CADD File name: FS 4.088.dgn

SPLICE NO.

S14-9

CHURCH ST & TRIBEK DR
SEE: CRP-6.015

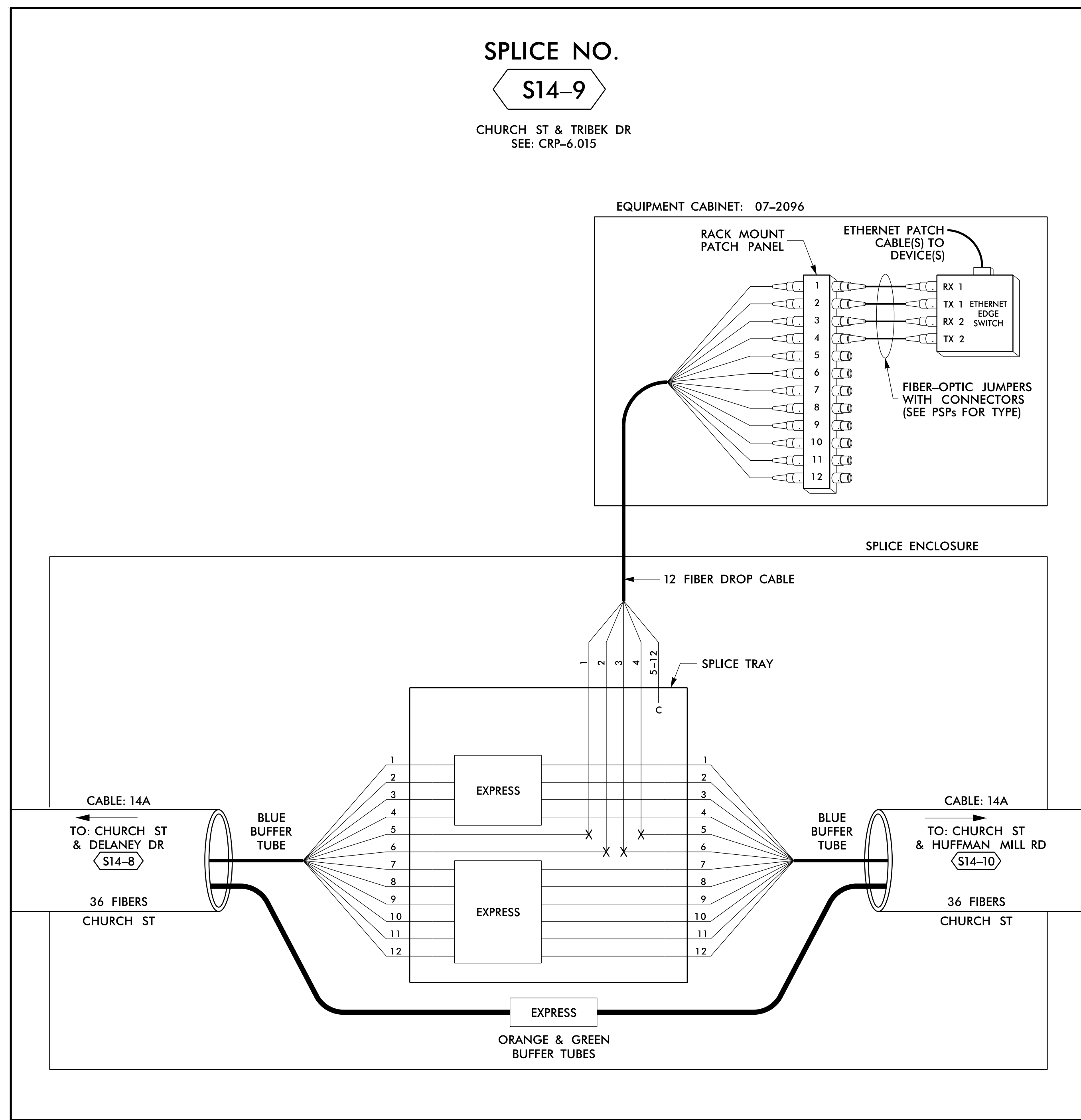

14 JUN 2018 12:30
 D:\Technical\proj\100056469 U-6015 B-C Sig Sys\Task 11_Coms\F5 4.089.dgn
 S:\DCS\653 AT_LUS\55433

LEGEND

COLOR CODE TIA/EIA 598-B		X = FUSION SPlice INDIVIDUAL FIBER C = CAP AND SEAL
(1) BLUE	(7) RED	EXPRESS
(2) ORANGE	(8) BLACK	EXPRESS ENTIRE BUFFER TUBE / FIBERS THROUGH WITHOUT CUTTING
(3) GREEN	(9) YELLOW	BUFFER SPlice
(4) BROWN	(10) VIOLET	BUFFER SPlice
(5) SLATE	(11) ROSE	EXISTING
(6) WHITE	(12) AQUA	EXISTING
		EXPRESS ALL FIBERS IN BUFFER TUBE COLOR TO COLOR
		EXISTING BUFFER TUBE / FIBERS DO NOT MODIFY EXISTING SPlices OR EXPRESSED FIBERS.

NOTES

- UNUSED FIBERS LEFT COILED AND STORED IN SPLICE TRAY
- UNUSED BUFFER TUBES LEFT COILED AND STORED IN SPLICE ENCLOSURE
- EDGE SWITCH CONFIGURATIONS ARE GENERIC. CONTRACTOR IS RESPONSIBLE FOR DETERMINING/ENSURING THE PROPER TERMINATIONS.

ATKINS 1616 EAST MILLBROOK ROAD, SUITE 160
 RALEIGH, NORTH CAROLINA 27609
 (919) 876-6888 NCBES #F-0326

DOCUMENT NOT CONSIDERED FINAL UNLESS ALL SIGNATURES COMPLETED

Prepared for the Offices of: 750 Greenfield Parkway, Garner, NC 27529	Burlington-Graham Signal System Fiber-Optic Splicing Details		SEAL NORTH CAROLINA PROFESSIONAL ENGINEER SEAL 040877 BRADFORD J. SLOCUM 15/2018 DATE
	Division 7 Alamance County PLAN DATE: June 2018 PREPARED BY: BJ SLOCUM	Burlington & Graham REVIEWED BY: HA BADGETT REVIEWED BY: DL JONES	
SCALE N/A			CAD File name: FS 4.089.dgn

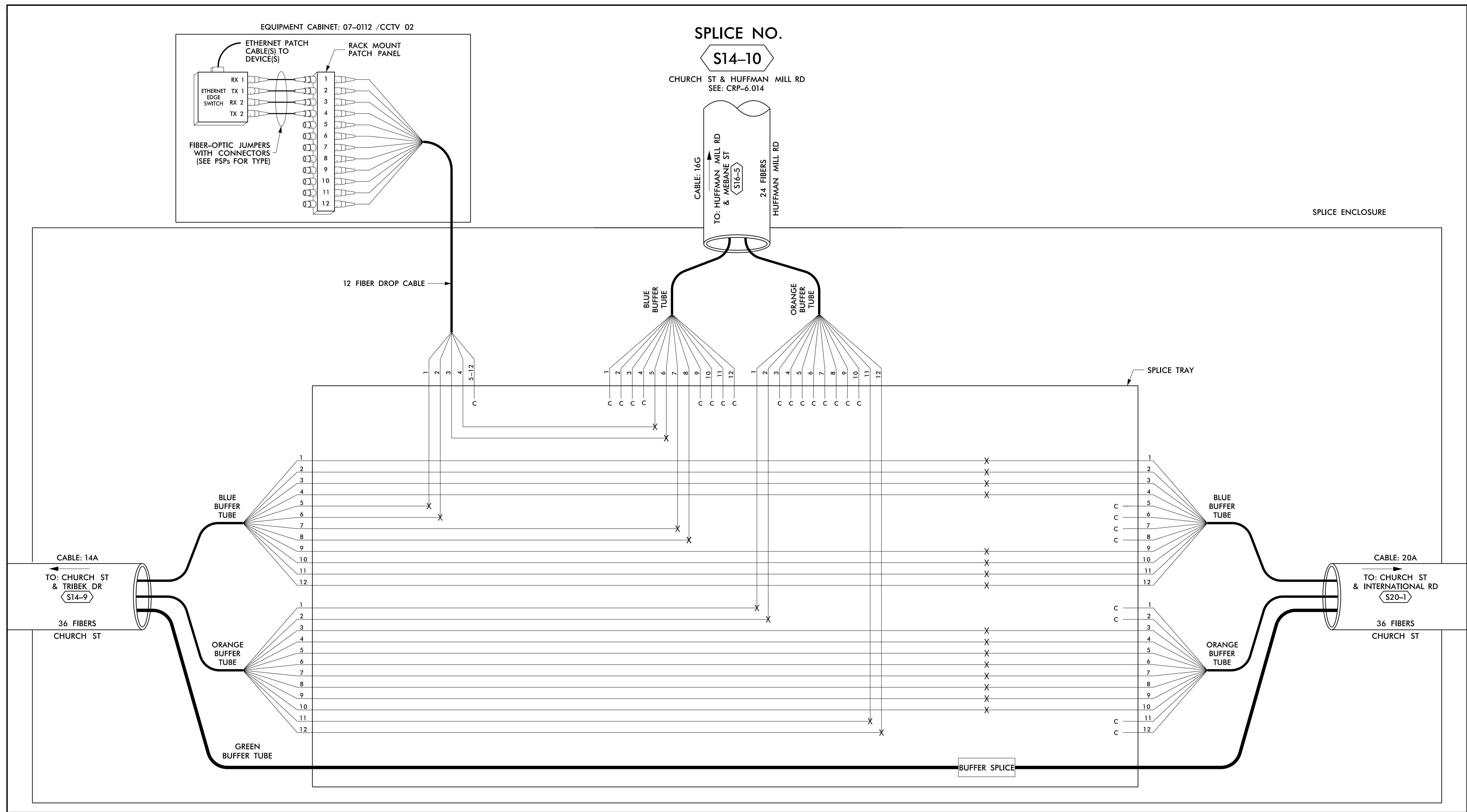

14 JUN 2018 12:30
D:\Technical\Drawings\Drawings\Task\11_Corridor_Sig_Sys\Task_11_Corridor_Sig_Sys.dgn

LEGEND

COLOR CODE	DESCRIPTION
(1) BLUE	EXPRESS
(2) ORANGE	BUFFER SPLICE
(3) GREEN	EXISTING
(4) BROWN	
(5) SLATE	
(6) WHITE	
(7) RED	EXPRESS ENTIRE BUFFER TUBE /FIBERS THROUGH WITHOUT CUTTING
(8) BLACK	SPLICE ALL FIBERS IN BUFFER TUBE COLOR TO COLOR
(9) YELLOW	EXISTING BUFFER TUBE /FIBERS DO NOT MODIFY EXISTING SPLICES OR EXPRESSED FIBERS.
(10) VIOLET	
(11) ROSE	
(12) AQUA	

X = FUSION SPLICE INDIVIDUAL FIBER
C = CAP AND SEAL

NOTES

- UNUSED FIBERS LEFT COILED AND STORED IN SPLICE TRAY
- UNUSED BUFFER TUBES LEFT COILED AND STORED IN SPLICE ENCLOSURE
- EDGE SWITCH CONFIGURATIONS ARE GENERIC. CONTRACTOR IS RESPONSIBLE FOR DETERMINING/ENSURING THE PROPER TERMINATIONS.

ATKINS 1616 EAST MILLBROOK ROAD, SUITE 160
RALEIGH, NORTH CAROLINA 27609
(919) 876-6888 NCBES #F-0326

DOCUMENT NOT CONSIDERED FINAL UNLESS ALL SIGNATURES COMPLETED

	Burlington-Graham Signal System Fiber-Optic Splicing Details	
	Division 7 PLAN DATE: June 2018 PREPARED BY: BJ SLOCUM	Alamance County REVIEWED BY: HA BADGETT REVIEWED BY: DL JONES
Burlington & Graham SCALE: N/A		SEAL NORTH CAROLINA PROFESSIONAL ENGINEER SEAL 040877 BRADFORD J. SLOCUM ENGINEER 06/15/2018 DATE

SPLICE NO.
S15-1

I-40 WB /I-85 SB & ALAMANCE RD
 SEE: CRP-6.089

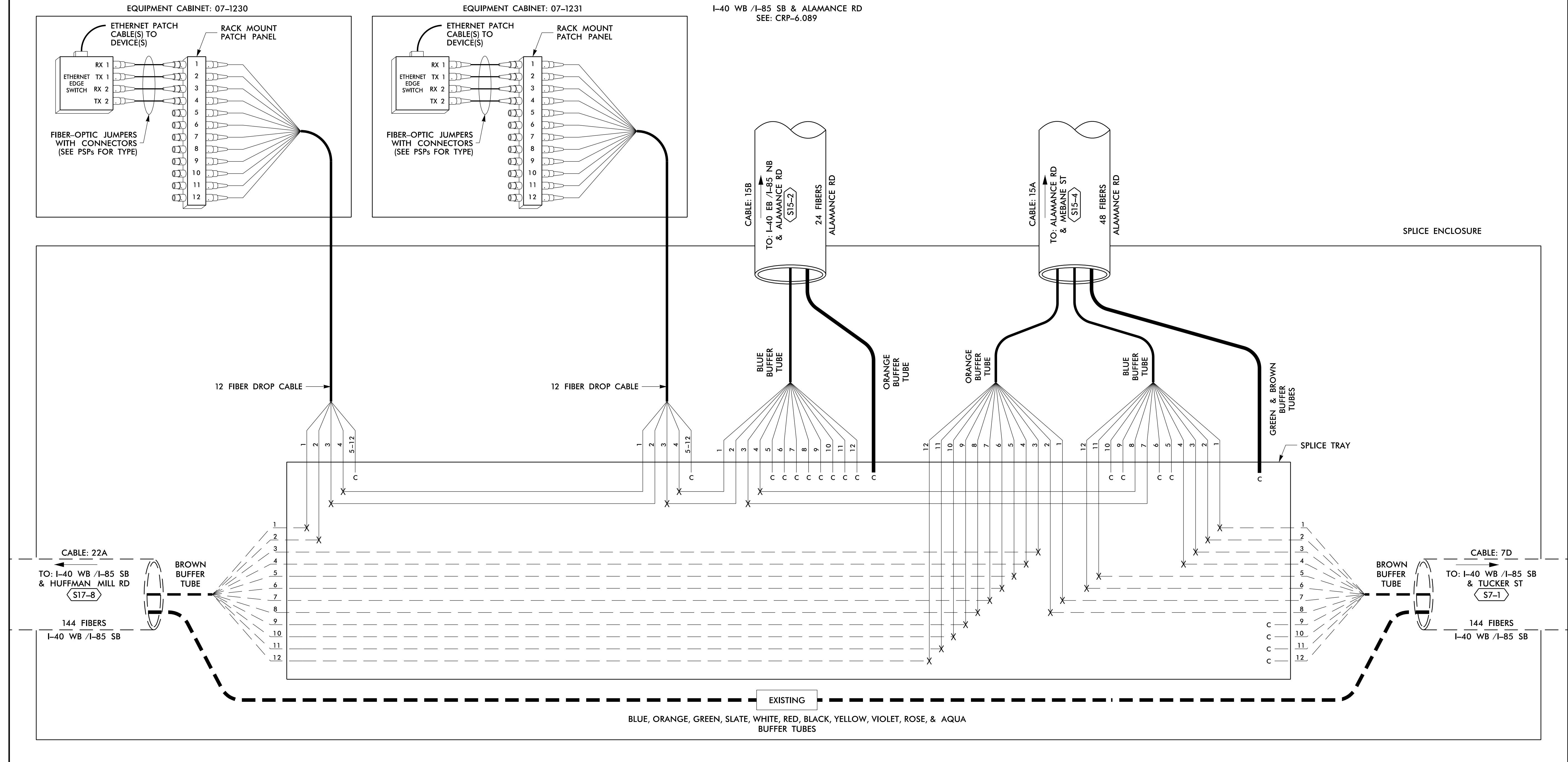

LEGEND

COLOR CODE TIA/EIA 598-B		X = FUSION SPLICE INDIVIDUAL FIBER
(1) BLUE	(7) RED	EXPRESS ENTIRE BUFFER TUBE / FIBERS THROUGH WITHOUT CUTTING
(2) ORANGE	(8) BLACK	C = CAP AND SEAL
(3) GREEN	(9) YELLOW	EXPRESS ENTIRE BUFFER TUBE / FIBERS THROUGH WITHOUT CUTTING
(4) BROWN	(10) VIOLET	BUFFER SPLICE
(5) SLATE	(11) ROSE	SPLICE ALL FIBERS IN BUFFER TUBE COLOR TO COLOR
(6) WHITE	(12) AQUA	EXISTING
		EXISTING BUFFER TUBE / FIBERS DO NOT MODIFY EXISTING SPLICES OR EXPRESSED FIBERS.

NOTES

- UNUSED FIBERS LEFT COILED AND STORED IN SPLICE TRAY
- UNUSED BUFFER TUBES LEFT COILED AND STORED IN SPLICE ENCLOSURE
- EDGE SWITCH CONFIGURATIONS ARE GENERIC. CONTRACTOR IS RESPONSIBLE FOR DETERMINING/ENSURING THE PROPER TERMINATIONS.

ATKINS 1616 EAST MILLBROOK ROAD, SUITE 160
 RALEIGH, NORTH CAROLINA 27609
 (919) 876-6888 NCBEEES #F-0326

DOCUMENT NOT CONSIDERED FINAL
 UNLESS ALL SIGNATURES COMPLETED

	Prepared for the Offices of: North Carolina Department of Transportation		SEAL NORTH CAROLINA PROFESSIONAL ENGINEER SEAL 040877 BRADFORD J. SLOCUM ENGINEER 15/2018
	Burlington-Graham Signal System Fiber-Optic Splicing Details		
Division 7 Alamance County Burlington & Graham	PLAN DATE: June 2018	REVIEWED BY: HA BADGETT	DATE
PREPARED BY: BJ SLOCUM	REVIEWED BY: DL JONES	DATE	
SCALE N/A	REVISIONS	INIT.	DATE
CADD File name: FS_4.091.dgn			DATE

14 JUN 2018 12:30
 D:\projects\11-Comms\11-Comms\Fs_4.091.dgn
 S:\035333 AT_LUS35333

SPLICE NO.
S15-2

I-40 EB /I-85 NB & ALAMANCE RD
SEE: CRP-6.089

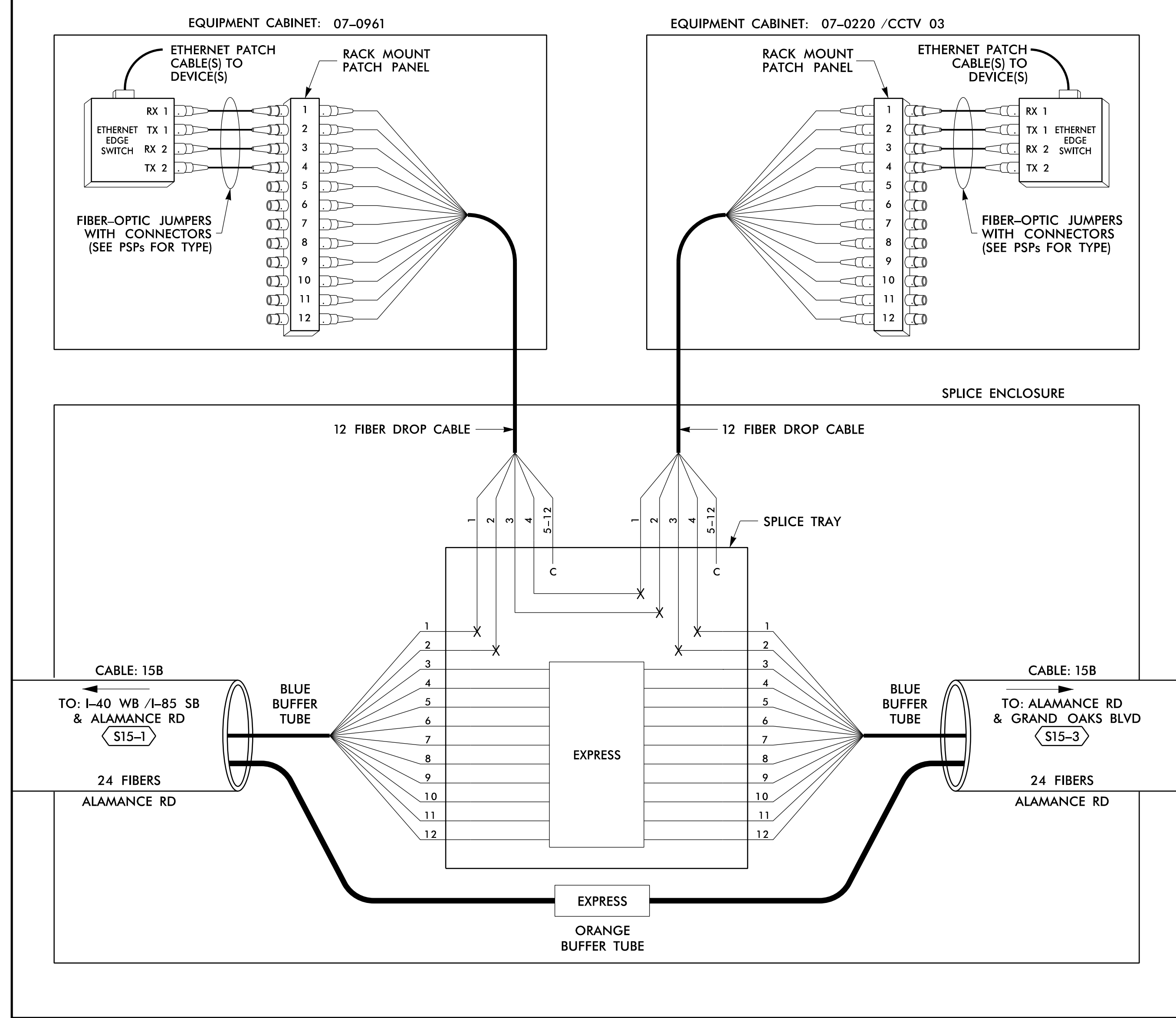

SPLICE NO.
S15-3

ALAMANCE RD & GRAND OAKS BLVD
SEE: CRP-6.087

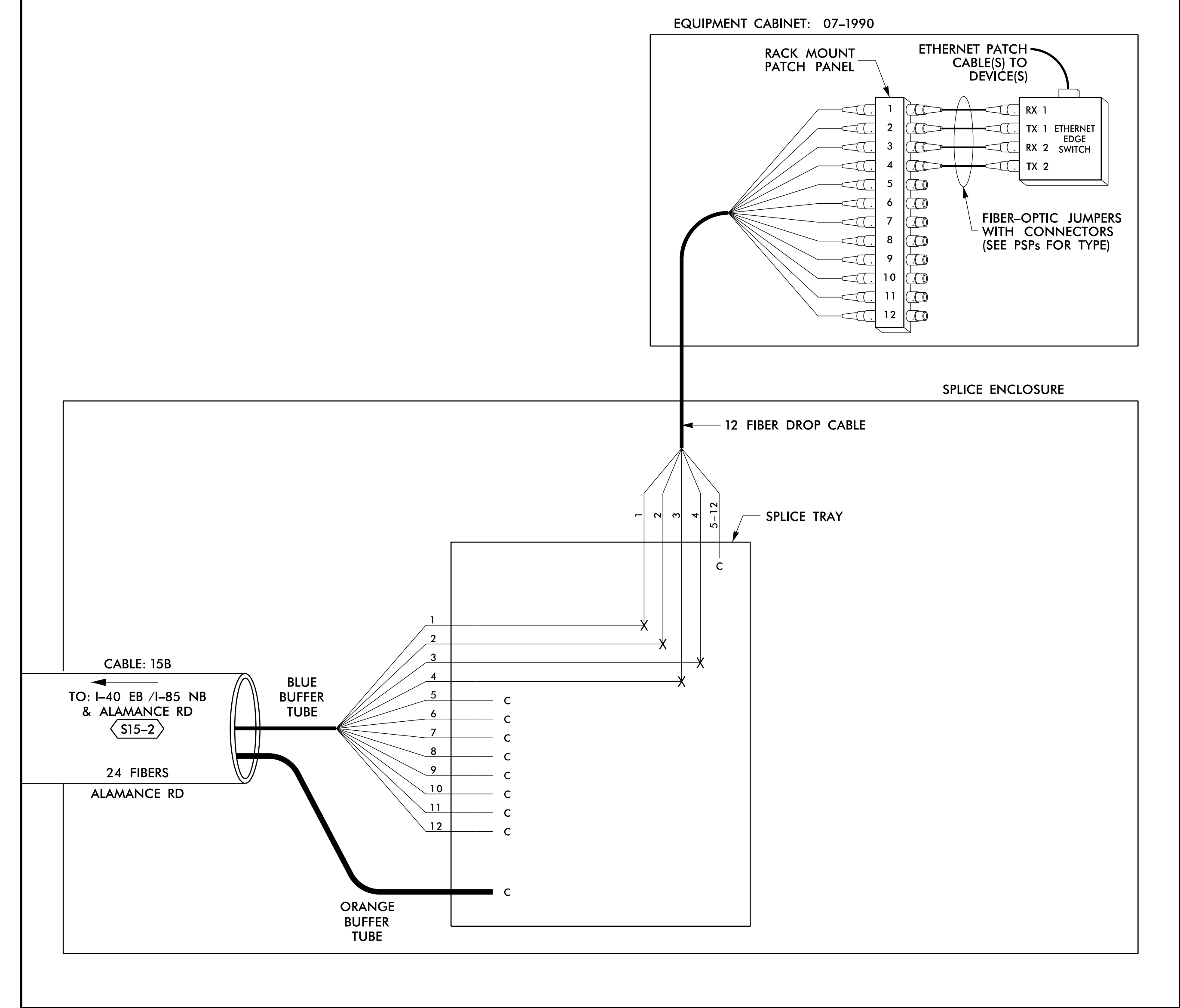

14-JUN-2018 12:30
 D:\projects\proj\11\comms\11_00056469 U-6015 B-C Sig_Sys\Task 11_Comms\F S 4.092.dgn
 SLOJ3653 AT LUS355433

LEGEND

COLOR CODE TIA/EIA 598-B		X = FUSION SPLICE INDIVIDUAL FIBER	
(1) BLUE	(7) RED	EXPRESS	EXPRESS ENTIRE BUFFER TUBE /FIBERS THROUGH WITHOUT CUTTING
(2) ORANGE	(8) BLACK	BUFFER SPLICE	SPLICE ALL FIBERS IN BUFFER TUBE COLOR TO COLOR
(3) GREEN	(9) YELLOW	EXISTING	EXISTING BUFFER TUBE /FIBERS DO NOT MODIFY EXISTING SPLICES OR EXPRESSED FIBERS.
(4) BROWN	(10) VIOLET		
(5) SLATE	(11) ROSE		
(6) WHITE	(12) AQUA		

NOTES

- UNUSED FIBERS LEFT COILED AND STORED IN SPLICE TRAY
- UNUSED BUFFER TUBES LEFT COILED AND STORED IN SPLICE ENCLOSURE
- EDGE SWITCH CONFIGURATIONS ARE GENERIC. CONTRACTOR IS RESPONSIBLE FOR DETERMINING/ENSURING THE PROPER TERMINATIONS.

ATKINS 1616 EAST MILLBROOK ROAD, SUITE 160
RALEIGH, NORTH CAROLINA 27609
(919) 876-6888 NCBEEES #F-0326

DOCUMENT NOT CONSIDERED FINAL
UNLESS ALL SIGNATURES COMPLETED

<p>750 Greenfield Parkway, Garner, NC 27529</p>	Prepared for the Offices of: North Carolina Department of Transportation		SEAL NORTH CAROLINA PROFESSIONAL ENGINEER SEAL 040877 BRADFORD J. SLOCUM ENGINEER BRADFORD J. SLOCUM 15/2018 DATE
	Burlington-Graham Signal System Fiber-Optic Splicing Details		
Division 7 Alamance County Burlington & Graham		PLAN DATE: June 2018 REVIEWED BY: HA BADGETT	
PREPARED BY: BJ SLOCUM		REVIEWED BY: DL JONES	
SCALE: N/A		REVISIONS: INIT. DATE	

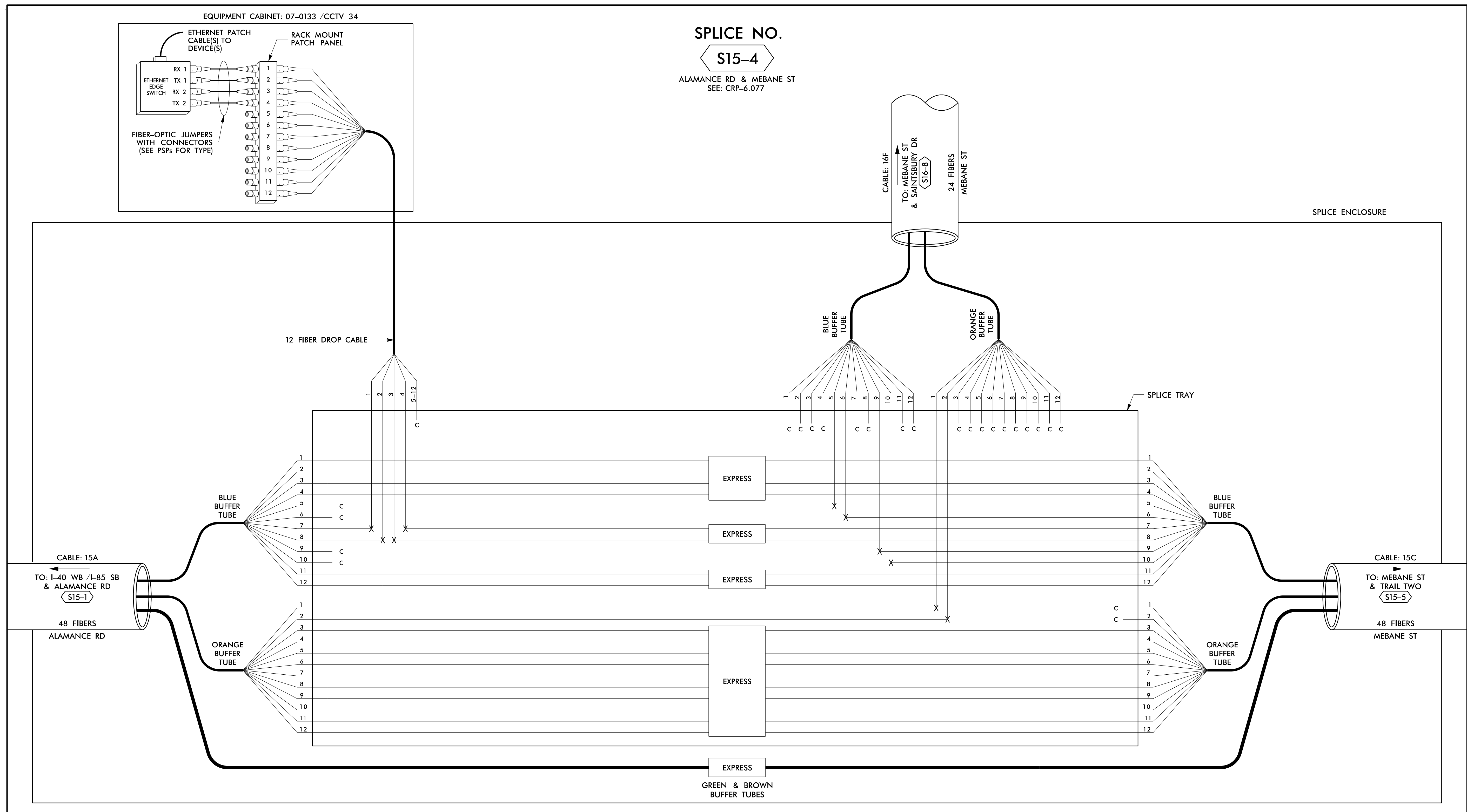

14-JUN-2018 12:30
D:\projects\proj\11\comms\11_00056469 U-6015 B-C Sig_Sys\Task 11_Comms\F5 4.093.dgn
S:\DCS\653 AT_LUS355433

LEGEND

(1) BLUE	(7) RED	EXPRESS	EXPRESS ENTIRE BUFFER TUBE /FIBERS THROUGH WITHOUT CUTTING
(2) ORANGE	(8) BLACK	BUFFER SPLICE	SPLICE ALL FIBERS IN BUFFER TUBE COLOR TO COLOR
(3) GREEN	(9) YELLOW	EXISTING	EXISTING BUFFER TUBE /FIBERS DO NOT MODIFY EXISTING SPLICES OR EXPRESSED FIBERS.
(4) BROWN	(10) VIOLET		
(5) SLATE	(11) ROSE		
(6) WHITE	(12) AQUA		

X = FUSION SPLICE INDIVIDUAL FIBER
 C = CAP AND SEAL

- NOTES**
- UNUSED FIBERS LEFT COILED AND STORED IN SPICE TRAY
 - UNUSED BUFFER TUBES LEFT COILED AND STORED IN SPICE ENCLOSURE
 - EDGE SWITCH CONFIGURATIONS ARE GENERIC. CONTRACTOR IS RESPONSIBLE FOR DETERMINING/ENSURING THE PROPER TERMINATIONS.

ATKINS 1616 EAST MILLBROOK ROAD, SUITE 160
 RALEIGH, NORTH CAROLINA 27609
 (919) 876-6888 NCBES #F-0326

DOCUMENT NOT CONSIDERED FINAL UNLESS ALL SIGNATURES COMPLETED

Prepared for the Offices of:

 Burlington-Graham Signal System
 Fiber-Optic Splicing Details

Division 7 Alamance County Burlington & Graham

PLAN DATE: June 2018 REVIEWED BY: HA BADGETT

PREPARED BY: BJ SLOCUM REVIEWED BY: DL JONES

750 Greenfield Parkway, Garner, NC 27529

SCALE: N/A

SEAL
 NORTH CAROLINA PROFESSIONAL ENGINEER
 SEAL 040877
 BRADFORD J. SLOCUM
 15/2018
 DATE

CADD File name: FS_4.093.dgn

SPLICE NO.

S15-5

MEBANE ST & TRAIL TWO
SEE: CRP-6.078

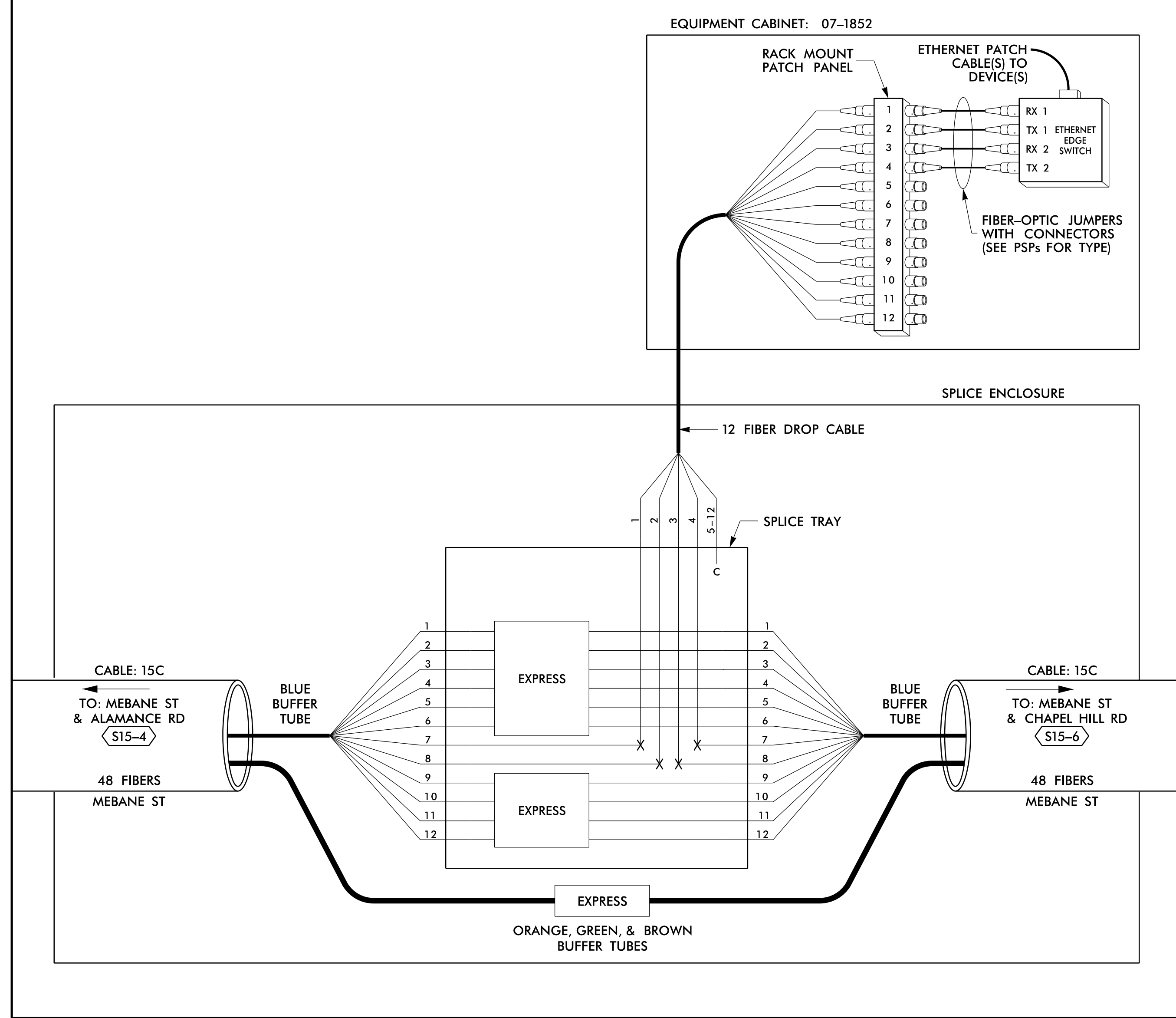

SPLICE NO.

S15-6

MEBANE ST & CHAPEL HILL RD
SEE: CRP-6.081

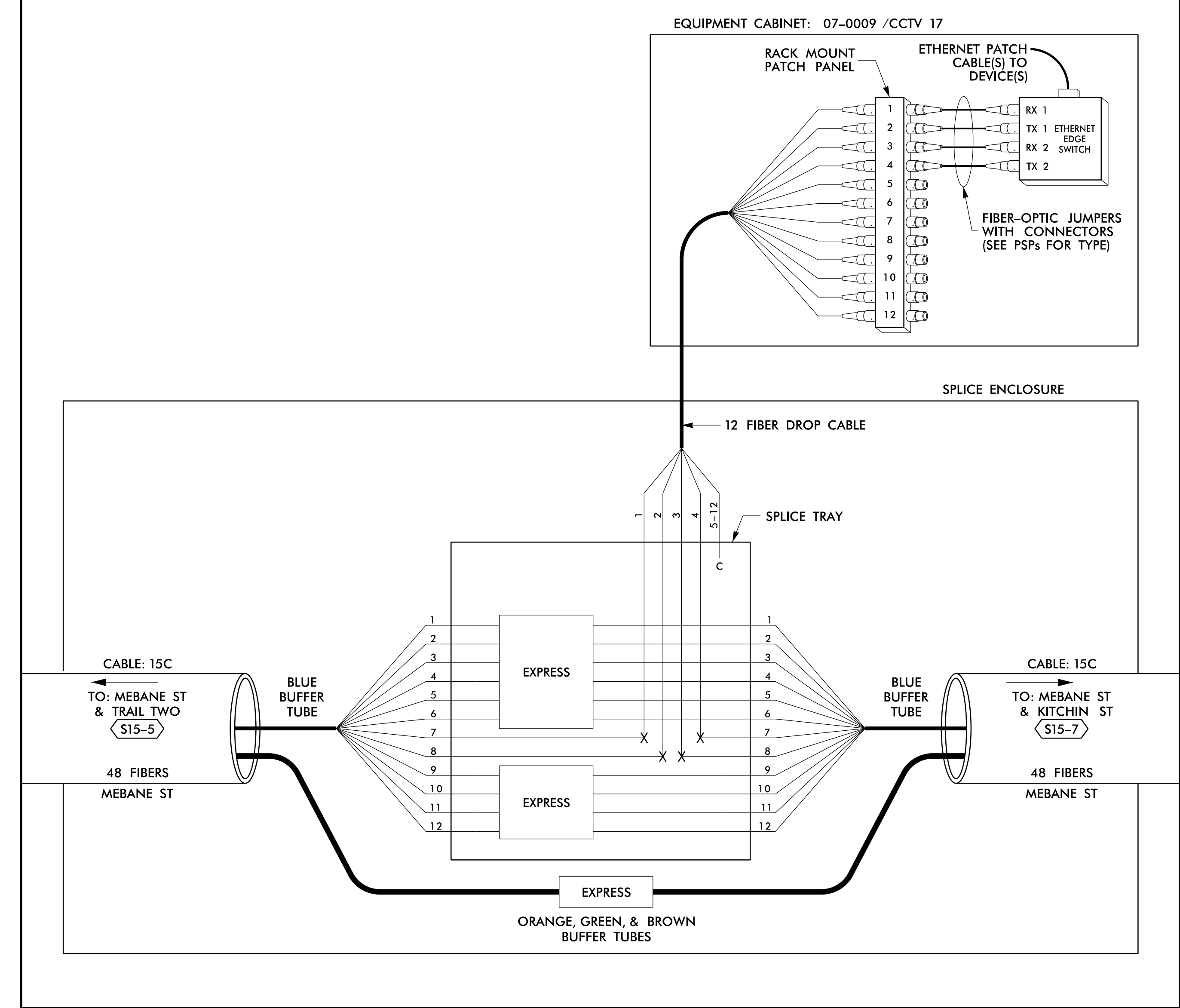

14 JUN 2018 12:30
 D:\Technical\proj\11\comms\11_Coms\Fs 4.094.dgn
 0:*\Technical\proj\11\comms\11_Coms\Fs 4.094.dgn
 S:\DCS\653 AT LUS355433

LEGEND

COLOR CODE TIA/EIA 598-B		X = FUSION SPlice INDIVIDUAL FIBER	
(1) BLUE	(7) RED	EXPRESS	EXPRESS ENTIRE BUFFER TUBE / FIBERS THROUGH WITHOUT CUTTING
(2) ORANGE	(8) BLACK	BUFFER SPlice	SPlice ALL FIBERS IN BUFFER TUBE COLOR TO COLOR
(3) GREEN	(9) YELLOW	EXISTING	EXISTING BUFFER TUBE / FIBERS DO NOT MODIFY EXISTING SPlices OR EXPRESSED FIBERS.
(4) BROWN	(10) VIOLET		
(5) SLATE	(11) ROSE		
(6) WHITE	(12) AQUA		

NOTES

1. UNUSED FIBERS LEFT COILED AND STORED IN SPLICE TRAY
2. UNUSED BUFFER TUBES LEFT COILED AND STORED IN SPLICE ENCLOSURE
3. EDGE SWITCH CONFIGURATIONS ARE GENERIC. CONTRACTOR IS RESPONSIBLE FOR DETERMINING/ENSURING THE PROPER TERMINATIONS.

ATKINS 1616 EAST MILLBROOK ROAD, SUITE 160
RALEIGH, NORTH CAROLINA 27609
(919) 876-6888 NCBEEES #F-0326

DOCUMENT NOT CONSIDERED FINAL UNLESS ALL SIGNATURES COMPLETED

<p>750 Greenfield Parkway, Garner, NC 27529</p>	<p>Burlington-Graham Signal System Fiber-Optic Splicing Details</p>							
	<p>Division 7 Alamance County Burlington & Graham</p>							
	<p>PLAN DATE: June 2018</p>	<p>REVIEWED BY: HA BADGETT</p>						
	<p>PREPARED BY: BJ SLOCUM</p>	<p>REVIEWED BY: DL JONES</p>						
<p>SCALE: N/A</p>	<table border="1"> <thead> <tr> <th>REVISIONS</th> <th>INIT.</th> <th>DATE</th> </tr> </thead> <tbody> <tr> <td> </td> <td> </td> <td> </td> </tr> </tbody> </table>	REVISIONS	INIT.	DATE				<p>DATE: 15/2018</p>
REVISIONS	INIT.	DATE						

SPLICE NO.
S15-7

MEBANE ST & KITCHIN ST
SEE: CRP-6.083

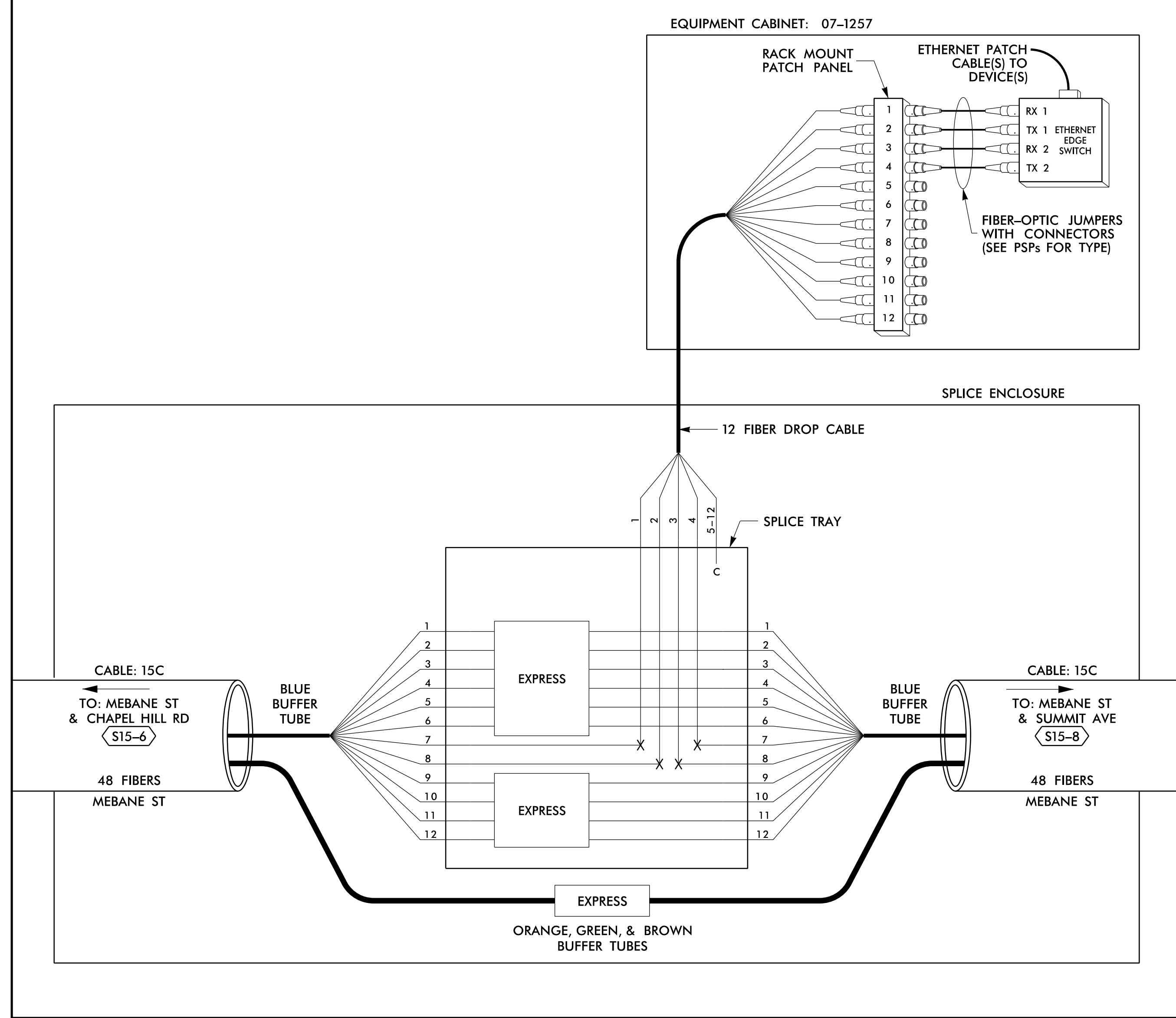

SPLICE NO.
S15-8

MEBANE ST & SUMMIT AVE
SEE: CRP-6.084

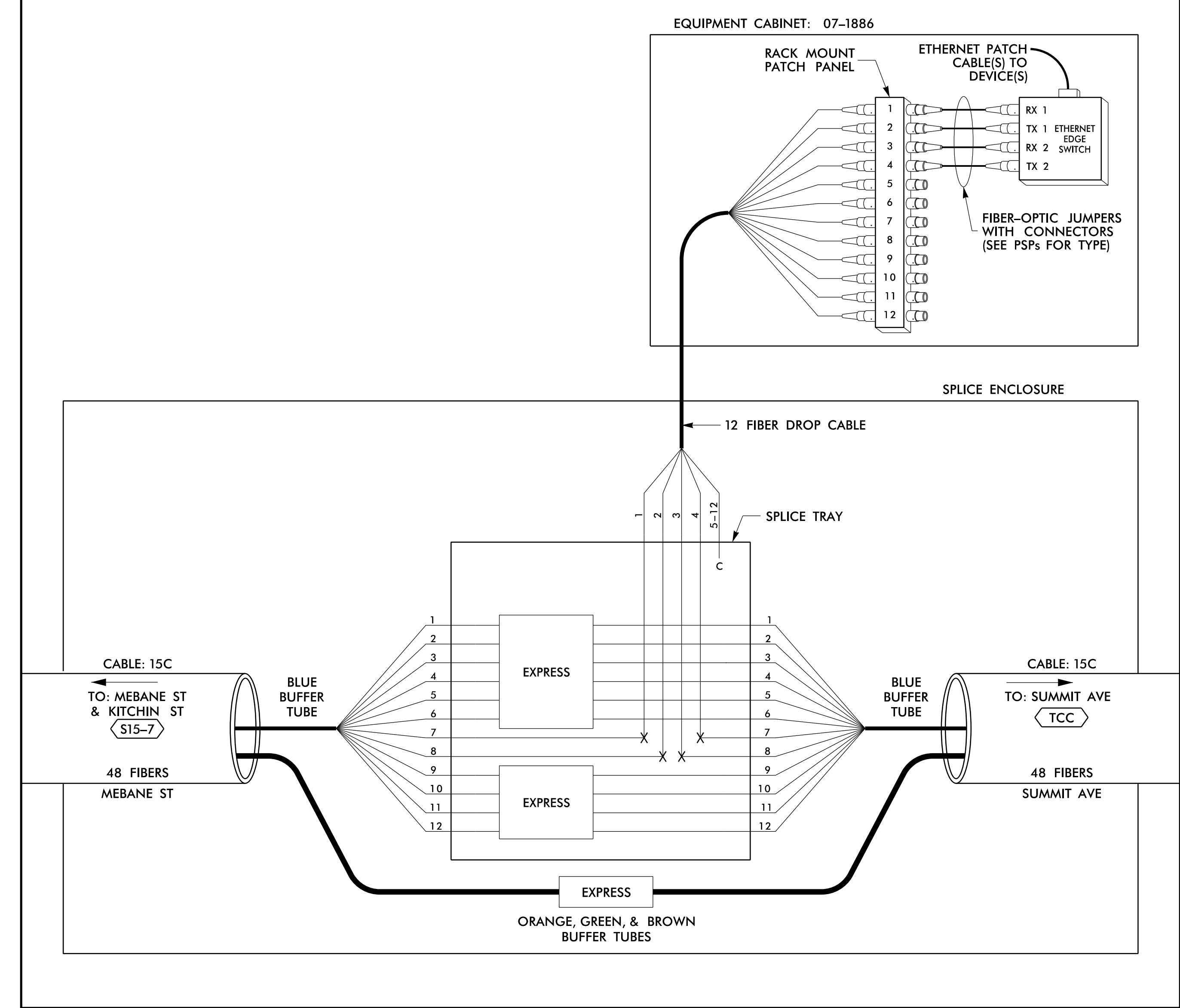

14 JUN 2018 12:30
 D:\Technical\proj\100056469 U-6015 B-C Sig Sys\Task 11_Corrs\F S 4.095.dgn
 S:\033653 AT LUS355433

LEGEND

COLOR CODE TIA/EIA 598-B		X = FUSION SPlice INDIVIDUAL FIBER	
(1) BLUE	(7) RED	EXPRESS	EXPRESS ENTIRE BUFFER TUBE / FIBERS THROUGH WITHOUT CUTTING
(2) ORANGE	(8) BLACK	BUFFER SPlice	SPlice ALL FIBERS IN BUFFER TUBE COLOR TO COLOR
(3) GREEN	(9) YELLOW	EXISTING	EXISTING BUFFER TUBE / FIBERS DO NOT MODIFY EXISTING SPlices OR EXPRESSED FIBERS.
(4) BROWN	(10) VIOLET		
(5) SLATE	(11) ROSE		
(6) WHITE	(12) AQUA		

NOTES

- UNUSED FIBERS LEFT COILED AND STORED IN SPLICE TRAY
- UNUSED BUFFER TUBES LEFT COILED AND STORED IN SPLICE ENCLOSURE
- EDGE SWITCH CONFIGURATIONS ARE GENERIC. CONTRACTOR IS RESPONSIBLE FOR DETERMINING/ENSURING THE PROPER TERMINATIONS.

ATKINS 1616 EAST MILLBROOK ROAD, SUITE 160
RALEIGH, NORTH CAROLINA 27609
(919) 876-6888 NCBEE# F-0326

DOCUMENT NOT CONSIDERED FINAL UNLESS ALL SIGNATURES COMPLETED

	Burlington-Graham Signal System Fiber-Optic Splicing Details		
	Division 7 Alamance County	Burlington & Graham	
PLAN DATE: June 2018	REVIEWED BY: HA BADGETT	PREPARED BY: BJ SLOCUM	
REVISIONS	INIT.	DATE	DATE
SCALE: N/A	CAD FILE NAME: FS 4.095.dgn		

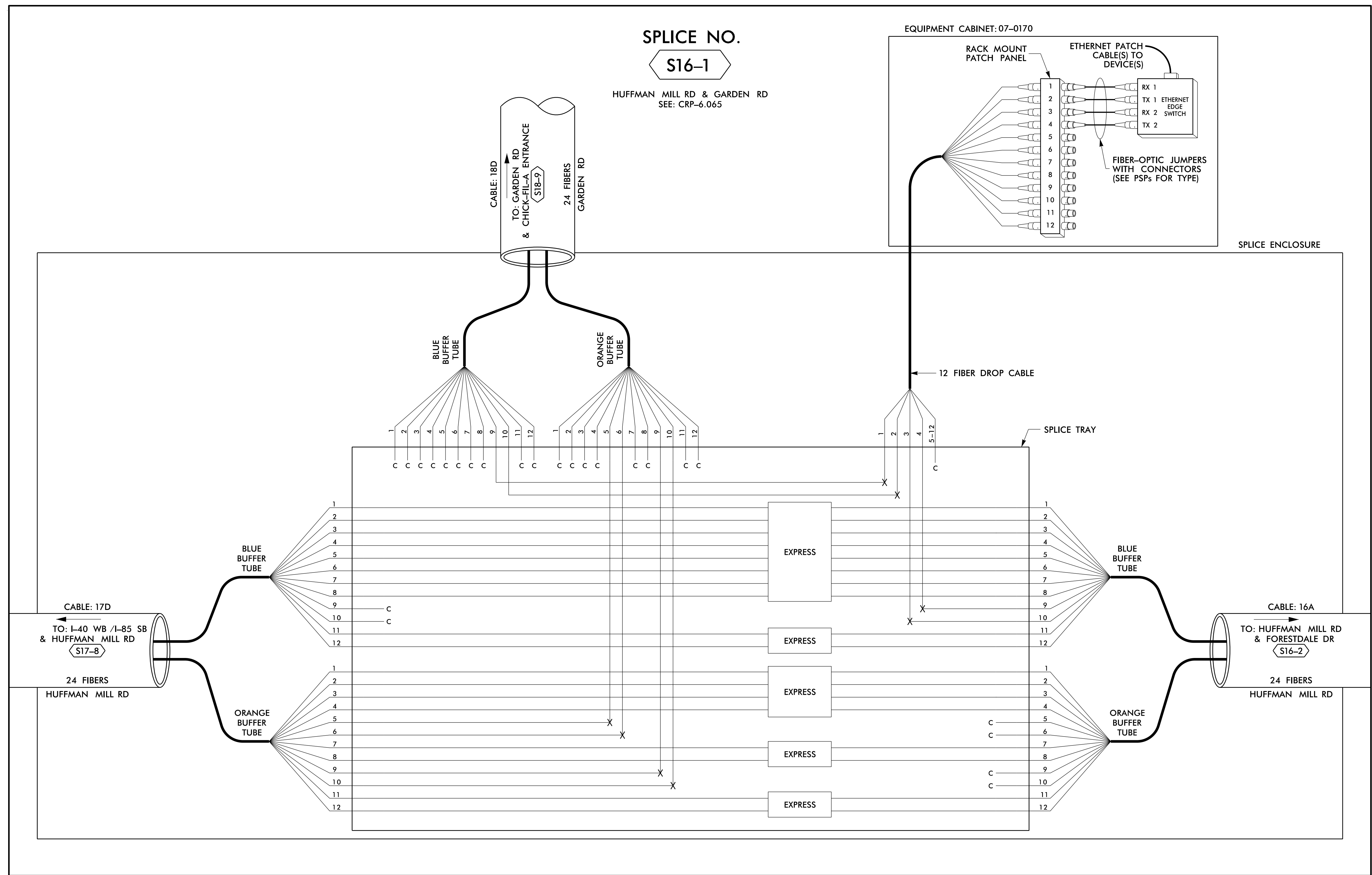

SPLICE NO.
S16-1

HUFFMAN MILL RD & GARDEN RD
SEE: CRP-6.065

EQUIPMENT CABINET: 07-0170

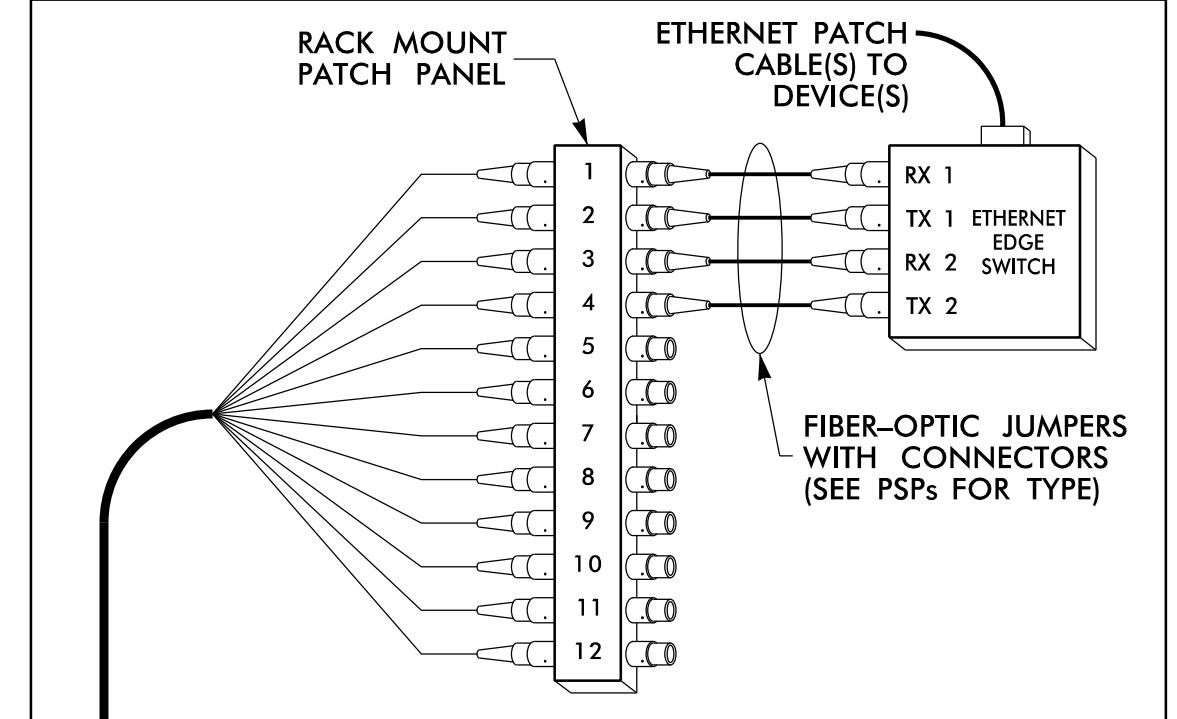

SPLICE ENCLOSURE

12 FIBER DROP CABLE

SPLICE TRAY

CABLE: 17D

TO: I-40 WB / I-85 SB & HUFFMAN MILL RD
S17-8

24 FIBERS
HUFFMAN MILL RD

CABLE: 16A

TO: HUFFMAN MILL RD & FORESTDALE DR
S16-2

24 FIBERS
HUFFMAN MILL RD

CABLE: 18D
TO: GARDEN RD & CHICK-FILA ENTRANCE
S18-9
24 FIBERS
GARDEN RD

BLUE BUFFER TUBE

ORANGE BUFFER TUBE

BLUE BUFFER TUBE

ORANGE BUFFER TUBE

BLUE BUFFER TUBE

ORANGE BUFFER TUBE

EXPRESS

EXPRESS

EXPRESS

EXPRESS

LEGEND

COLOR CODE TIA/EIA 598-B		EXPRESS		EXPRESS ENTIRE BUFFER TUBE / FIBERS THROUGH WITHOUT CUTTING
(1) BLUE	(7) RED	BUFFER SPLICE		SPLICE ALL FIBERS IN BUFFER TUBE COLOR TO COLOR
(2) ORANGE	(8) BLACK	EXISTING		EXISTING BUFFER TUBE / FIBERS DO NOT MODIFY EXISTING SPLICES OR EXPRESSED FIBERS.
(3) GREEN	(9) YELLOW			
(4) BROWN	(10) VIOLET			
(5) SLATE	(11) ROSE			
(6) WHITE	(12) AQUA			

NOTES

- UNUSED FIBERS LEFT COILED AND STORED IN SPLICE TRAY
- UNUSED BUFFER TUBES LEFT COILED AND STORED IN SPLICE ENCLOSURE
- EDGE SWITCH CONFIGURATIONS ARE GENERIC. CONTRACTOR IS RESPONSIBLE FOR DETERMINING/ENSURING THE PROPER TERMINATIONS.

ATKINS 1616 EAST MILLBROOK ROAD, SUITE 160
RALEIGH, NORTH CAROLINA 27609
(919) 876-6888 NCBEEES #F-0326

DOCUMENT NOT CONSIDERED FINAL
UNLESS ALL SIGNATURES COMPLETED

	Burlington-Graham Signal System Fiber-Optic Splicing Details			
	Division 7	Alamance County		Burlington & Graham
	PLAN DATE: June 2018	REVIEWED BY: HA BADGETT		
	PREPARED BY: BJ SLOCUM	REVIEWED BY: DL JONES		
SCALE: N/A		REVISIONS	INIT. DATE	

14 JUN 2018 12:30
 D:\projects\proj\100056469 U-6015 B-C Sig Sys\Task 11_Comms#FS 4.096.dgn
 S:\033653 AT LUS355433

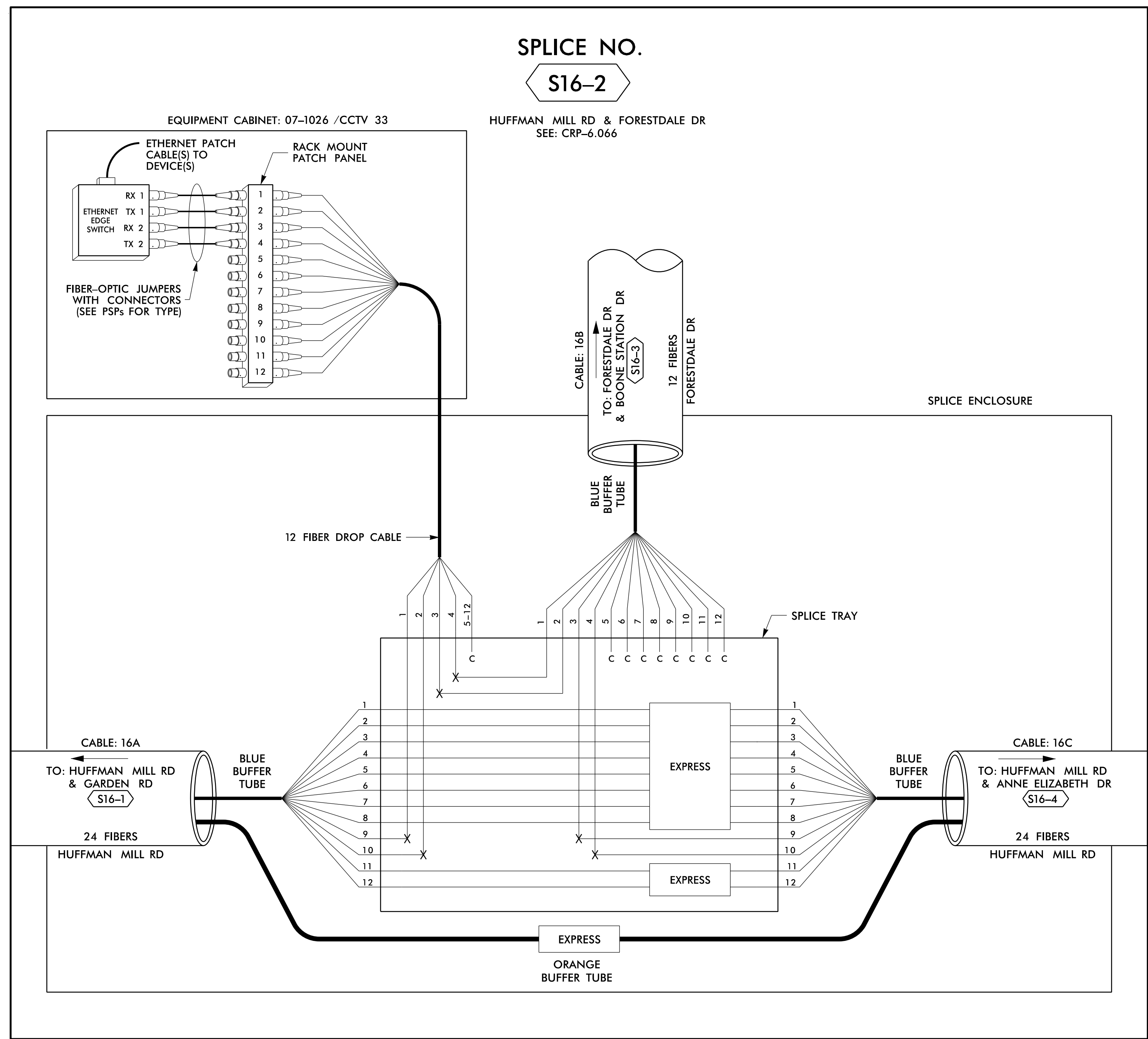

SPLICE NO.
S16-2

HUFFMAN MILL RD & FORESTDALE DR
 SEE: CRP-6.066

EQUIPMENT CABINET: 07-1026 /CCTV 33

LEGEND

COLOR CODE TIA/EIA 598-B		X = FUSION SPlice INDIVIDUAL FIBER THROUGH WITHOUT CUTTING
(1) BLUE	(7) RED	EXPRESS
(2) ORANGE	(8) BLACK	EXPRESS ENTIRE BUFFER TUBE /FIBERS THROUGH WITHOUT CUTTING
(3) GREEN	(9) YELLOW	BUFFER SPICE
(4) BROWN	(10) VIOLET	SPlice ALL FIBERS IN BUFFER TUBE COLOR TO COLOR
(5) SLATE	(11) ROSE	EXISTING
(6) WHITE	(12) AQUA	EXISTING BUFFER TUBE /FIBERS DO NOT MODIFY EXISTING SPlices OR EXPRESSED FIBERS.

NOTES

- UNUSED FIBERS LEFT COILED AND STORED IN SPLICE TRAY
- UNUSED BUFFER TUBES LEFT COILED AND STORED IN SPLICE ENCLOSURE
- EDGE SWITCH CONFIGURATIONS ARE GENERIC. CONTRACTOR IS RESPONSIBLE FOR DETERMINING/ENSURING THE PROPER TERMINATIONS.

ATKINS 1616 EAST MILLBROOK ROAD, SUITE 160
 RALEIGH, NORTH CAROLINA 27609
 (919) 876-6888 NCBEE# F-0326

DOCUMENT NOT CONSIDERED FINAL
 UNLESS ALL SIGNATURES COMPLETED

<p>750 Greenfield Parkway, Garner, NC 27529</p>	<p>Burlington-Graham Signal System Fiber-Optic Splicing Details</p>							
	<p>Division 7 Alamance County Burlington & Graham</p>							
	<p>PLAN DATE: June 2018</p>	<p>REVIEWED BY: HA BADGETT</p>						
	<p>PREPARED BY: BJ SLOCUM</p>	<p>REVIEWED BY: DL JONES</p>						
<p>SCALE N/A</p>	<table border="1"> <thead> <tr> <th>REVISIONS</th> <th>INIT.</th> <th>DATE</th> </tr> </thead> <tbody> <tr> <td> </td> <td> </td> <td> </td> </tr> </tbody> </table>	REVISIONS	INIT.	DATE				<p>DATE: 15/2018</p>
REVISIONS	INIT.	DATE						

14 JUN 2018 12:30
 D:\projects\proj\100566469 U-6015 B-C Sig_Sys\Task 11_Coms\F4_097.dgn
 S:\DCS\653 AT_LUS355433

SPLICE NO.

S16-3

FORESDALE DR & BOONE STATION DR
SEE: CRP-6.071

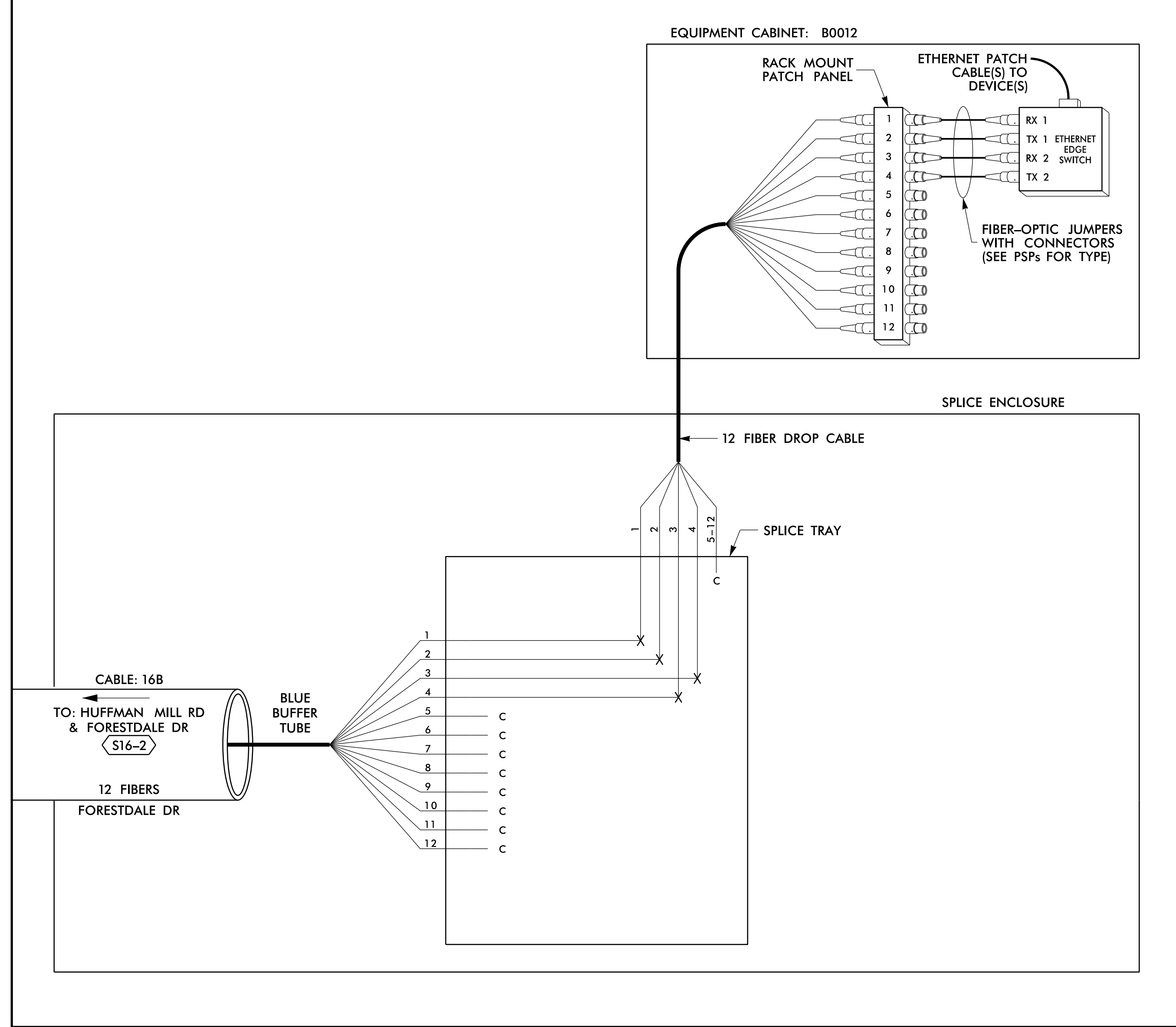

SPLICE NO.

S16-4

HUFFMAN MILL RD & ANNE ELIZABETH DR
SEE: CRP-6.067

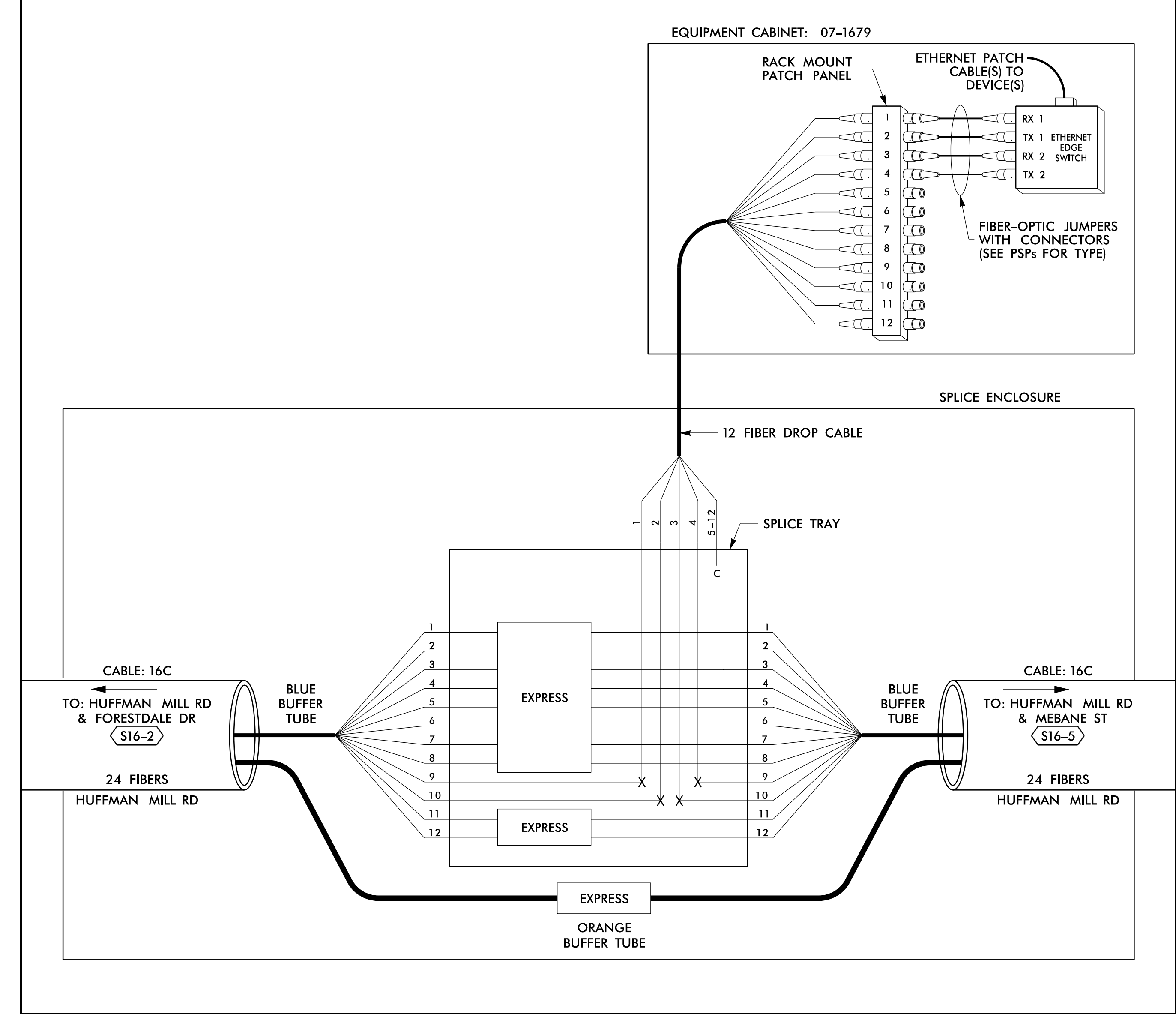

14 JUN 2018 12:30
 D:\Technical\proj\11\comms\11_Coms\Fs 4.098.dgn
 S:\033633 AT_LUS355433

LEGEND

COLOR CODE TIA/EIA 598-B		X = FUSION SPlice INDIVIDUAL FIBER C = CAP AND SEAL
(1) BLUE	(7) RED	EXPRESS
(2) ORANGE	(8) BLACK	EXPRESS ENTIRE BUFFER TUBE / FIBERS THROUGH WITHOUT CUTTING
(3) GREEN	(9) YELLOW	BUFFER SPlice
(4) BROWN	(10) VIOLET	BUFFER SPlice
(5) SLATE	(11) ROSE	EXISTING
(6) WHITE	(12) AQUA	EXISTING
SPlice ALL FIBERS IN BUFFER TUBE COLOR TO COLOR		EXISTING BUFFER TUBE / FIBERS DO NOT MODIFY EXISTING SPlices OR EXPRESSED FIBERS.

NOTES

- UNUSED FIBERS LEFT COILED AND STORED IN SPlice TRAY
- UNUSED BUFFER TUBES LEFT COILED AND STORED IN SPlice ENCLOSURE
- EDGE SWITCH CONFIGURATIONS ARE GENERIC. CONTRACTOR IS RESPONSIBLE FOR DETERMINING/ENSURING THE PROPER TERMINATIONS.

ATKINS 1616 EAST MILLBROOK ROAD, SUITE 160
RALEIGH, NORTH CAROLINA 27609
(919) 876-6888 NCBEEs #F-0326

DOCUMENT NOT CONSIDERED FINAL UNLESS ALL SIGNATURES COMPLETED

Prepared for the Offices of: 750 Greenfield Parkway, Garner, NC 27529	Burlington-Graham Signal System Fiber-Optic Splicing Details		SEAL NORTH CAROLINA PROFESSIONAL ENGINEER SEAL 040877 BRADFORD J. SLOCUM 15/2018 DATE
	Division 7 Alamance County PLAN DATE: June 2018 PREPARED BY: BJ SLOCUM	Burlington & Graham REVIEWED BY: HA BADGETT REVIEWED BY: DL JONES	
SCALE N/A	REVISIONS INIT. DATE		DATE CAD File Name: FS 4.098.dgn

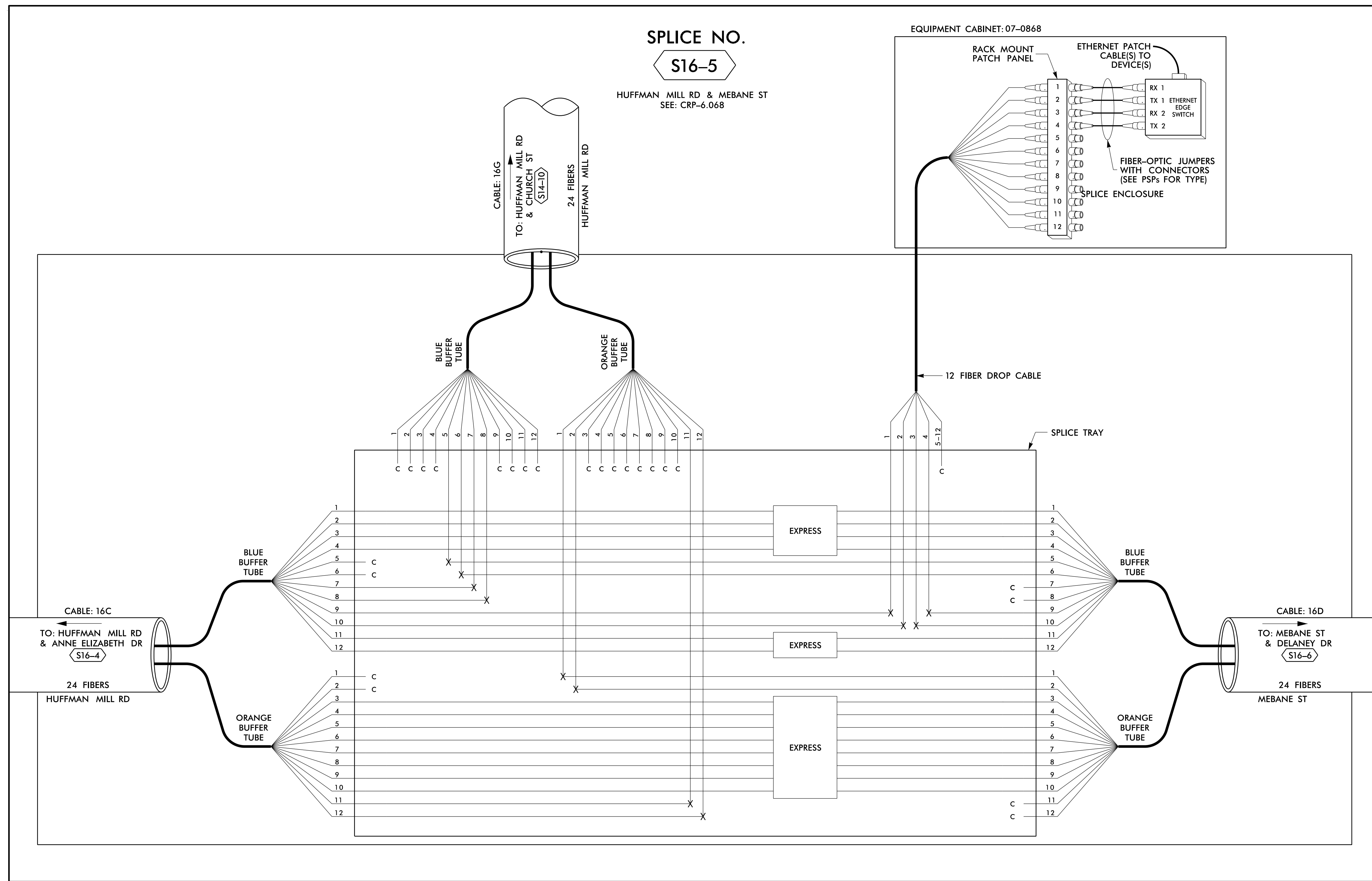

14 JUN 2018 12:30
 D:\projects\proj\100056469 U-6015 B-C Sig Sys\Task 11_Coms#FS 4.099.dgn
 S:\033653 AT_LUS355433

LEGEND

COLOR CODE TIA/EIA 598-B	X = FUSION SPLICE INDIVIDUAL FIBER	EXPRESS	EXPRESS ENTIRE BUFFER TUBE / FIBERS THROUGH WITHOUT CUTTING
(1) BLUE (7) RED	C = CAP AND SEAL	BUFFER SPLICE	SPLICE ALL FIBERS IN BUFFER TUBE COLOR TO COLOR
(2) ORANGE (8) BLACK		EXISTING	EXISTING BUFFER TUBE / FIBERS DO NOT MODIFY EXISTING SPLICES OR EXPRESSED FIBERS.
(3) GREEN (9) YELLOW			
(4) BROWN (10) VIOLET			
(5) SLATE (11) ROSE			
(6) WHITE (12) AQUA			

- NOTES**
- UNUSED FIBERS LEFT COILED AND STORED IN SPLICE TRAY
 - UNUSED BUFFER TUBES LEFT COILED AND STORED IN SPLICE ENCLOSURE
 - EDGE SWITCH CONFIGURATIONS ARE GENERIC. CONTRACTOR IS RESPONSIBLE FOR DETERMINING/ENSURING THE PROPER TERMINATIONS.

ATKINS 1616 EAST MILLBROOK ROAD, SUITE 160
 RALEIGH, NORTH CAROLINA 27609
 (919) 876-6888 NCBEEES #F-0326

DOCUMENT NOT CONSIDERED FINAL UNLESS ALL SIGNATURES COMPLETED

Prepared for the Offices of:

 State of North Carolina
 Department of Transportation

Burlington-Graham Signal System
Fiber-Optic Splicing Details

Division 7 Alamance County Burlington & Graham

PLAN DATE: June 2018 REVIEWED BY: HA BADGETT

PREPARED BY: BJ SLOCUM REVIEWED BY: DL JONES

REVISIONS	INIT.	DATE

SCALE: N/A

Seal: BRADFORD J. SLOCUM, ENGINEER, SEAL 040877

DATE: 6/15/2018

CADD File name: FS 4.099.dgn

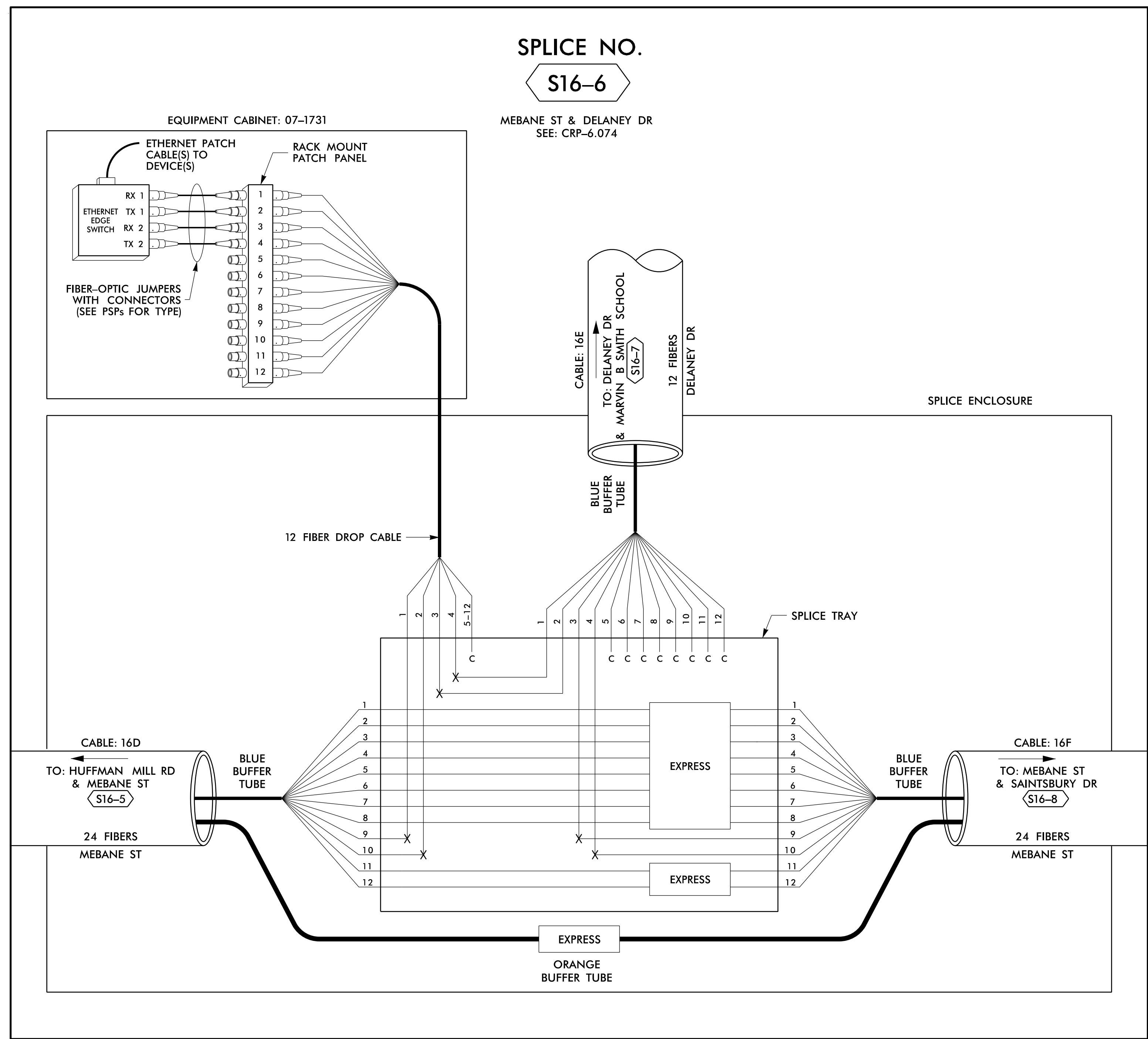

14 JUN 2018 12:30
 D:\projects\proj\100056469 U-6015 B-C Sig Sys\Task 11_Coms\Fs 4_100.dgn
 S:\DCS\653 AT_LUS355433

COLOR CODE		LEGEND	
(1) BLUE	(7) RED	EXPRESS	EXPRESS ENTIRE BUFFER TUBE / FIBERS THROUGH WITHOUT CUTTING
(2) ORANGE	(8) BLACK	BUFFER SPlice	SPLICE ALL FIBERS IN BUFFER TUBE COLOR TO COLOR
(3) GREEN	(9) YELLOW	EXISTING	EXISTING BUFFER TUBE / FIBERS DO NOT MODIFY EXISTING SPLICES OR EXPRESSED FIBERS.
(4) BROWN	(10) VIOLET		
(5) SLATE	(11) ROSE		
(6) WHITE	(12) AQUA		

- NOTES**
- UNUSED FIBERS LEFT COILED AND STORED IN SPLICE TRAY
 - UNUSED BUFFER TUBES LEFT COILED AND STORED IN SPLICE ENCLOSURE
 - EDGE SWITCH CONFIGURATIONS ARE GENERIC. CONTRACTOR IS RESPONSIBLE FOR DETERMINING/ENSURING THE PROPER TERMINATIONS.

ATKINS

1616 EAST MILLBROOK ROAD, SUITE 160
 RALEIGH, NORTH CAROLINA 27609
 (919) 876-6888 NCBEE# F-0326

**DOCUMENT NOT CONSIDERED FINAL
UNLESS ALL SIGNATURES COMPLETED**

Prepared for the Offices of: NORTH CAROLINA DEPARTMENT OF TRANSPORTATION										
Burlington-Graham Signal System Fiber-Optic Splicing Details										
Division 7 Alamance County Burlington & Graham										
PLAN DATE: June 2018	REVIEWED BY: HA BADGETT									
PREPARED BY: BJ SLOCUM	REVIEWED BY: DL JONES									
SCALE: N/A	<table border="1" style="width: 100%;"> <thead> <tr> <th>REVISIONS</th> <th>INIT.</th> <th>DATE</th> </tr> </thead> <tbody> <tr> <td> </td> <td> </td> <td> </td> </tr> <tr> <td> </td> <td> </td> <td> </td> </tr> </tbody> </table>	REVISIONS	INIT.	DATE						
REVISIONS	INIT.	DATE								

SEAL

BRADFORD J. SLOCUM
 ENGINEER
 15/2018
 DATE

CAAD File name: FS 4.100.dgn

SPLICE NO.

S16-7

DELANEY DR & MARVIN B
SMITH SCHOOL
SEE: CRP-6.144

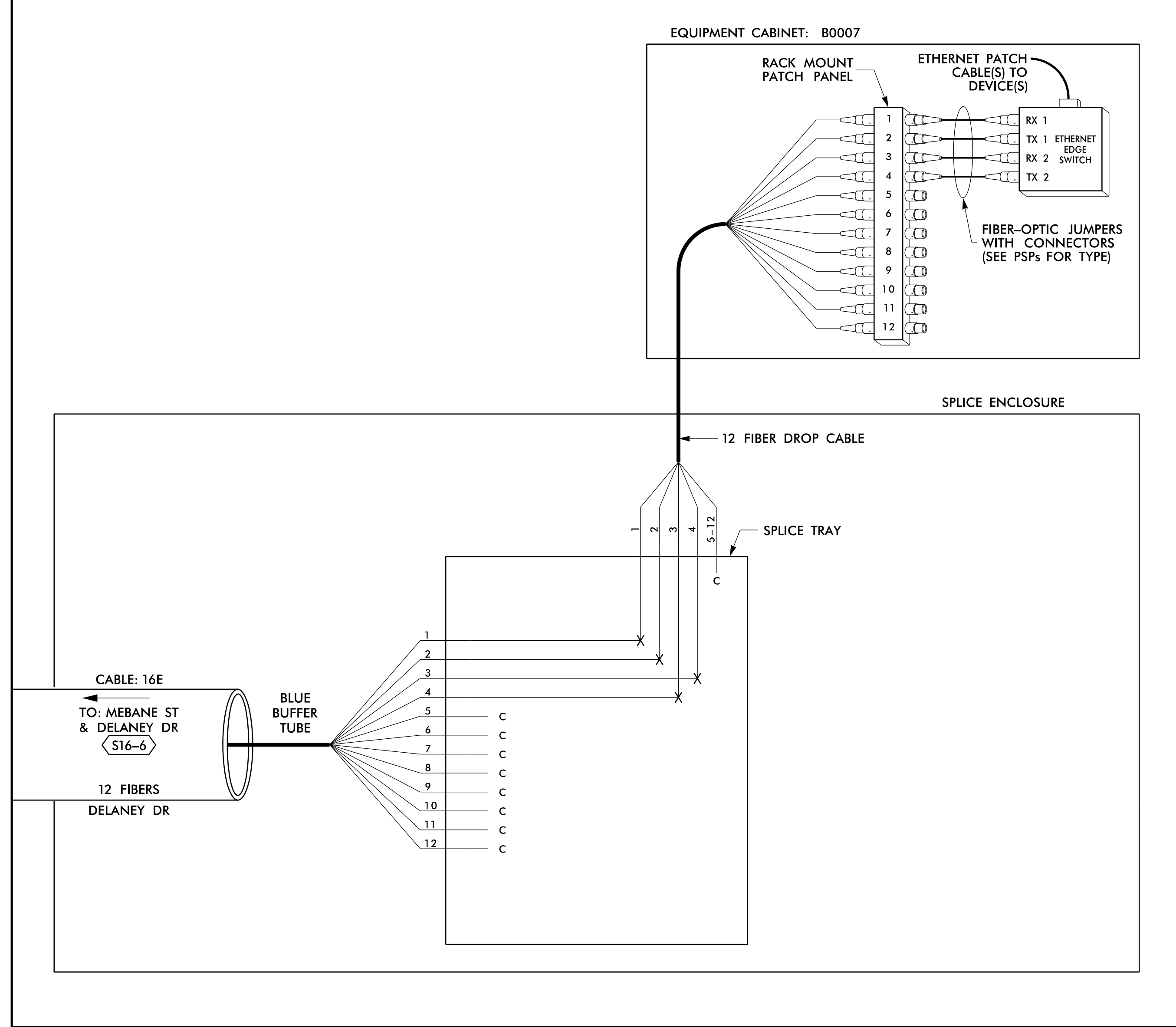

SPLICE NO.

S16-8

MEBANE ST & SAINTSBURY DR
SEE: CRP-6.077

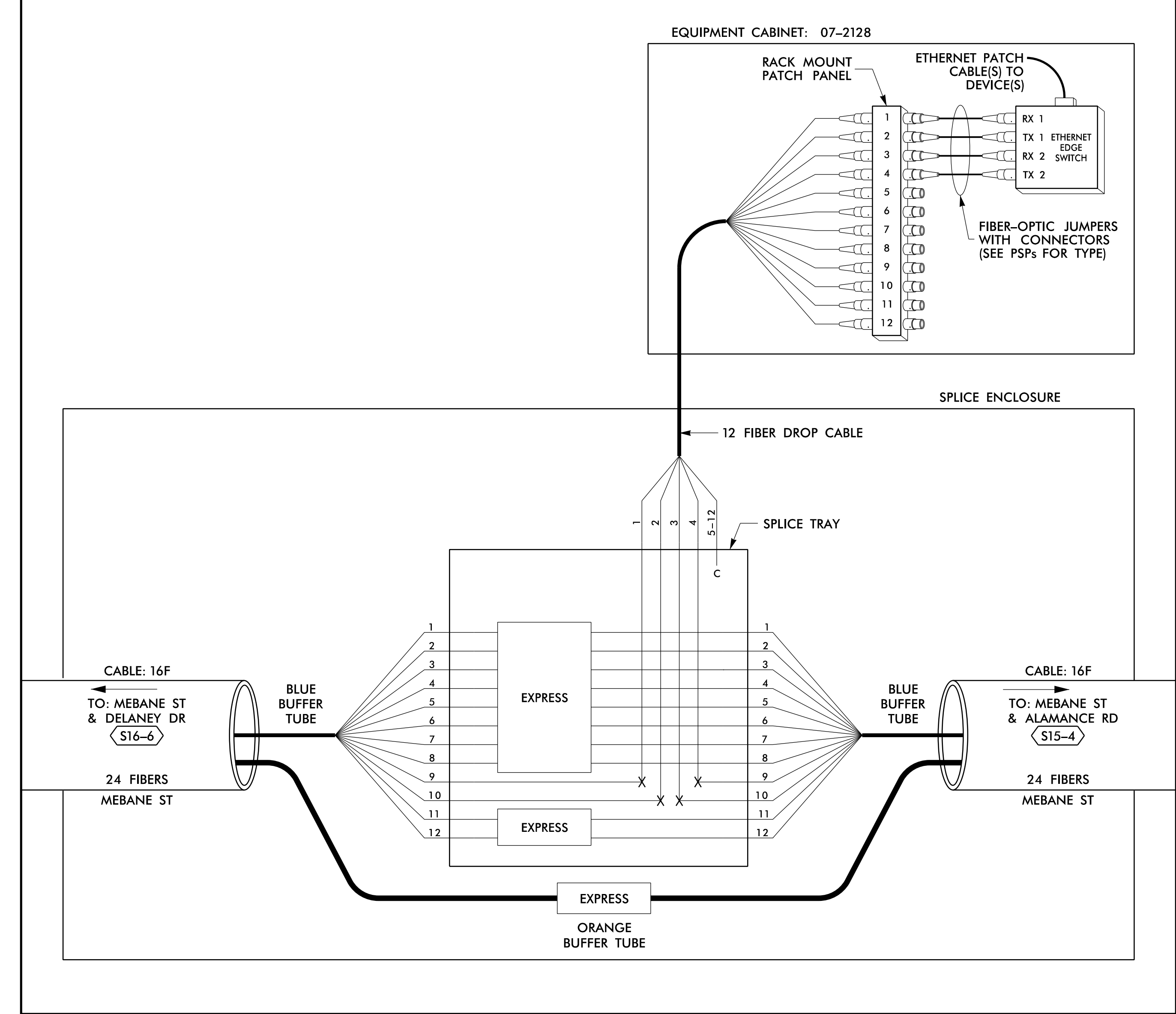

14 JUN 2018 12:30
 D:\projects\proj\100056469 U-6015 B-C Sig Sys\Task 11_Coms\Fs 4.101.dgn
 SLOJ3633 AT LUS355433

LEGEND

COLOR CODE		TIA/EIA 598-B	
(1) BLUE	(7) RED	EXPRESS	EXPRESS ENTIRE BUFFER TUBE / FIBERS THROUGH WITHOUT CUTTING
(2) ORANGE	(8) BLACK	BUFFER SPLICE	SPLICE ALL FIBERS IN BUFFER TUBE COLOR TO COLOR
(3) GREEN	(9) YELLOW	EXISTING	EXISTING BUFFER TUBE / FIBERS DO NOT MODIFY EXISTING SPLICES OR EXPRESSED FIBERS.
(4) BROWN	(10) VIOLET		
(5) SLATE	(11) ROSE		
(6) WHITE	(12) AQUA		

NOTES

- UNUSED FIBERS LEFT COILED AND STORED IN SPLICE TRAY
- UNUSED BUFFER TUBES LEFT COILED AND STORED IN SPLICE ENCLOSURE
- EDGE SWITCH CONFIGURATIONS ARE GENERIC. CONTRACTOR IS RESPONSIBLE FOR DETERMINING/ENSURING THE PROPER TERMINATIONS.

ATKINS 1616 EAST MILLBROOK ROAD, SUITE 160
RALEIGH, NORTH CAROLINA 27609
(919) 876-6888 NCBES #F-0326

DOCUMENT NOT CONSIDERED FINAL
UNLESS ALL SIGNATURES COMPLETED

<p>750 Greenfield Parkway, Garner, NC 27529</p>	Prepared for the Offices of: NORTH CAROLINA DEPARTMENT OF TRANSPORTATION		SEAL NORTH CAROLINA PROFESSIONAL ENGINEER SEAL 040877 BRADFORD J. SLOCUM ENGINEER 15/2018 DATE
	Burlington-Graham Signal System Fiber-Optic Splicing Details		
	Division 7 Alamance County PLAN DATE: June 2018 PREPARED BY: BJ SLOCUM	Burlington & Graham REVIEWED BY: HA BADGETT REVIEWED BY: DL JONES	
	SCALE: N/A	REVISIONS:	

SPLICE NO.

S17-1

I-40 WB /I-85 SB &
UNIVERSITY DR
SEE: CRP-6.051

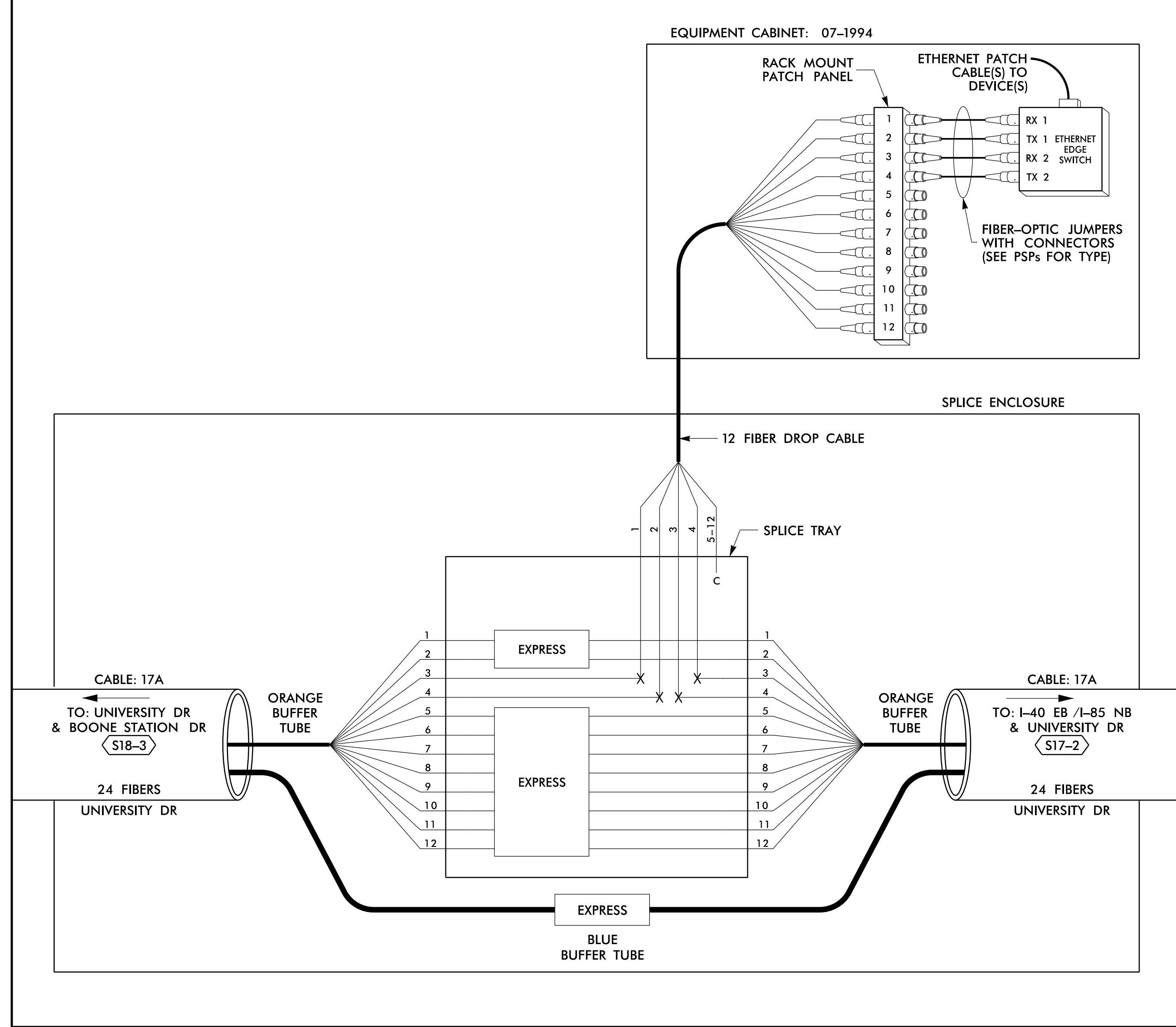

SPLICE NO.

S17-2

I-40 EB /I-85 NB &
UNIVERSITY DR
SEE: CRP-6.051

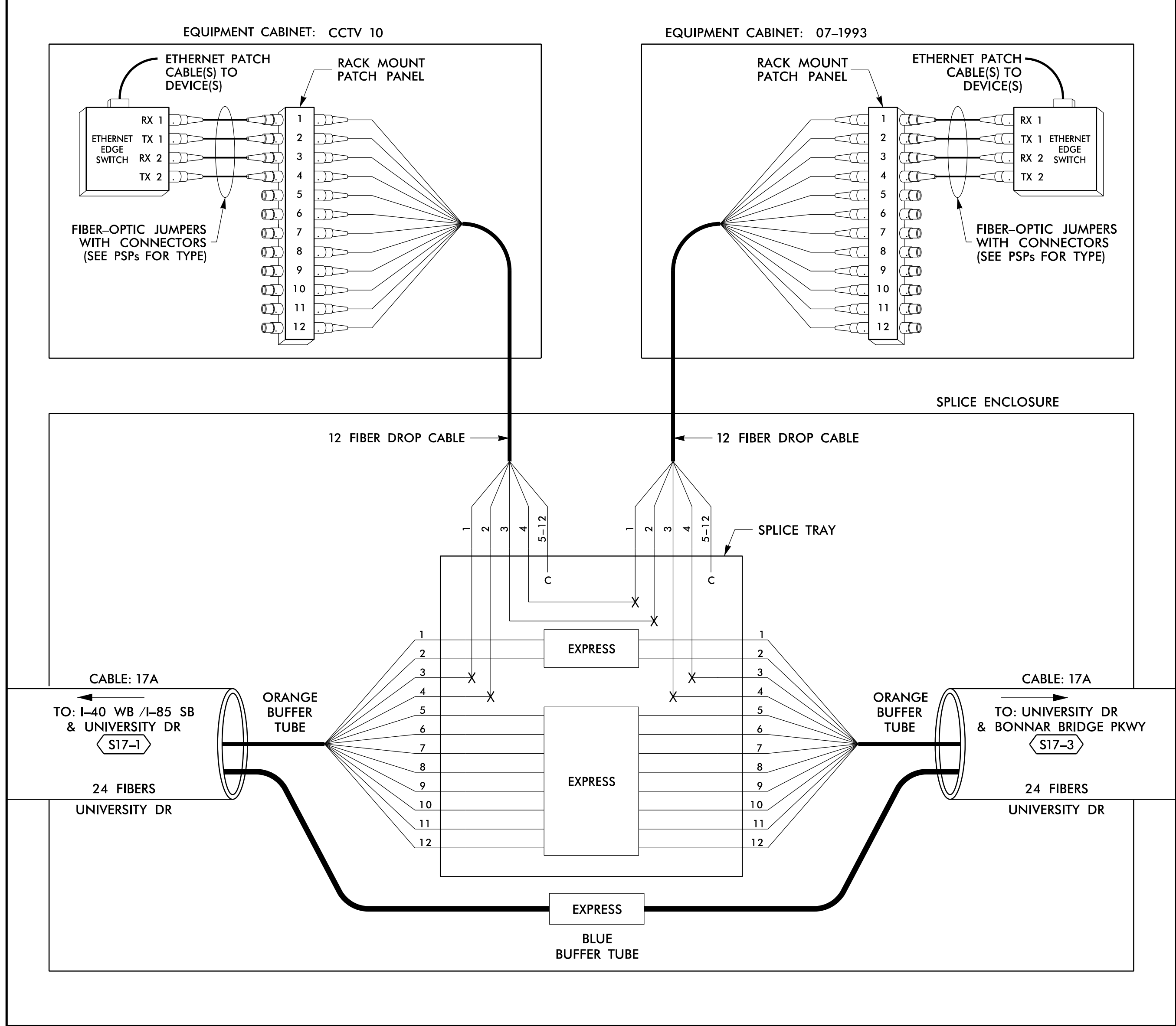

14 JUN 2018 12:30
 D:\projects\proj\100056469 U-6015 B-C Sig Sys\Task 11_Comm#FS 4_102.dgn
 S:\03563 AT_LUS355433

LEGEND

COLOR CODE TIA/EIA 598-B		X = FUSION SPlice INDIVIDUAL FIBER C = CAP AND SEAL
(1) BLUE	(7) RED	EXPRESS
(2) ORANGE	(8) BLACK	EXPRESS ENTIRE BUFFER TUBE / FIBERS THROUGH WITHOUT CUTTING
(3) GREEN	(9) YELLOW	BUFFER SPlice
(4) BROWN	(10) VIOLET	BUFFER SPlice
(5) SLATE	(11) ROSE	EXISTING
(6) WHITE	(12) AQUA	EXISTING
SPlice ALL FIBERS IN BUFFER TUBE COLOR TO COLOR		EXISTING BUFFER TUBE / FIBERS DO NOT MODIFY EXISTING SPlices OR EXPRESSED FIBERS.

NOTES

- UNUSED FIBERS LEFT COILED AND STORED IN SPlice TRAY
- UNUSED BUFFER TUBES LEFT COILED AND STORED IN SPlice ENCLOSURE
- EDGE SWITCH CONFIGURATIONS ARE GENERIC. CONTRACTOR IS RESPONSIBLE FOR DETERMINING/ENSURING THE PROPER TERMINATIONS.

ATKINS 1616 EAST MILLBROOK ROAD, SUITE 160
RALEIGH, NORTH CAROLINA 27609
(919) 876-6888 NCBEE# 0326

DOCUMENT NOT CONSIDERED FINAL UNLESS ALL SIGNATURES COMPLETED

Prepared for the Offices of: 750 Greenfield Parkway, Garner, NC 27529	Burlington-Graham Signal System Fiber-Optic Splicing Details		SEAL NORTH CAROLINA PROFESSIONAL ENGINEER SEAL 040877 BRADFORD J. SLOCUM 15/2018 DATE
	Division 7 Alamance County	Burlington & Graham	
	PLAN DATE: June 2018	REVIEWED BY: HA BADGETT	
	PREPARED BY: BJ SLOCUM	REVIEWED BY: DL JONES	
SCALE N/A	REVISIONS	INIT. DATE	DATE

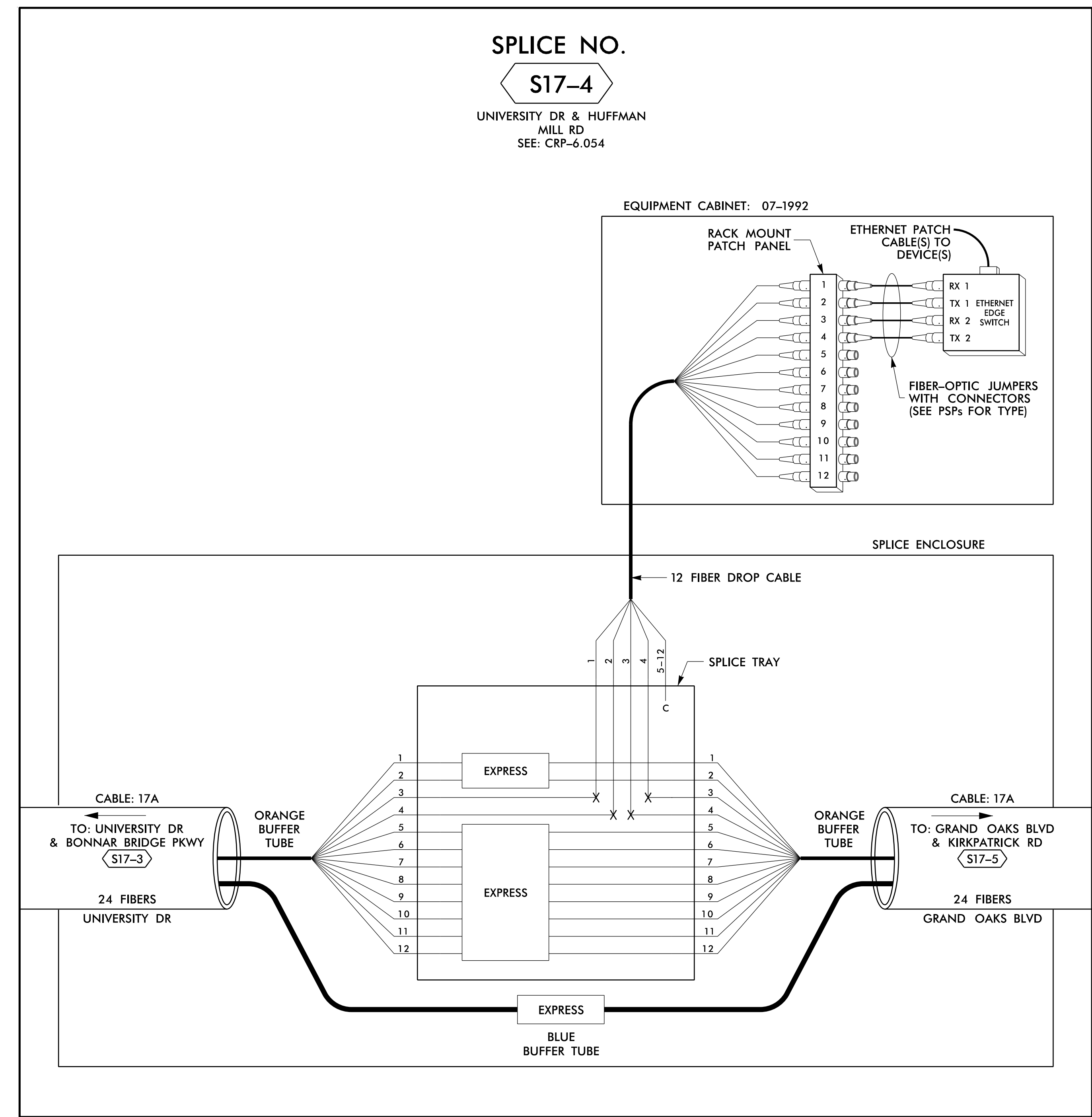
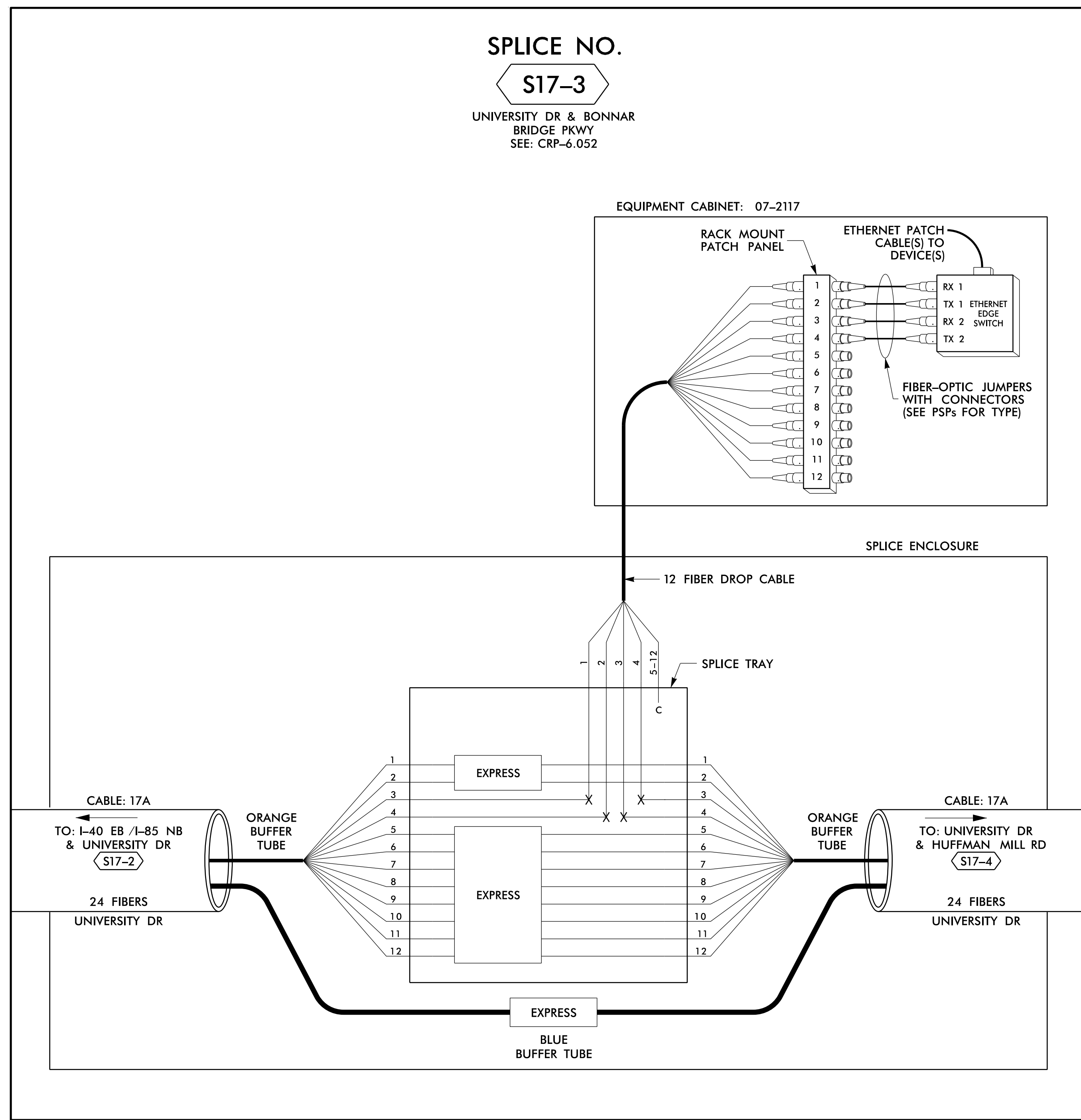

14 JUN 2018 12:30
 D:\projects\atkins\proj\11\1100056469 U-6015 B-C Sig Sys\Task 11_Comm\FS 4_103.dgn
 S:\033633 AT_LUS355433

LEGEND

COLOR CODE TIA/EIA 598-B	X = FUSION SPlice INDIVIDUAL FIBER	EXPRESS	EXPRESS ENTIRE BUFFER TUBE / FIBERS THROUGH WITHOUT CUTTING
(1) BLUE	(8) BLACK	BUFFER SPlice	SPlice ALL FIBERS IN BUFFER TUBE COLOR TO COLOR
(2) ORANGE	(9) YELLOW	EXISTING	EXISTING BUFFER TUBE / FIBERS DO NOT MODIFY EXISTING SPlices OR EXPRESSED FIBERS.
(3) GREEN	(10) VIOLET		
(4) BROWN	(11) ROSE		
(5) SLATE	(12) AQUA		
(6) WHITE			

- NOTES**
- UNUSED FIBERS LEFT COILED AND STORED IN SPLICE TRAY
 - UNUSED BUFFER TUBES LEFT COILED AND STORED IN SPLICE ENCLOSURE
 - EDGE SWITCH CONFIGURATIONS ARE GENERIC. CONTRACTOR IS RESPONSIBLE FOR DETERMINING/ENSURING THE PROPER TERMINATIONS.

ATKINS 1616 EAST MILLBROOK ROAD, SUITE 160
RALEIGH, NORTH CAROLINA 27609
(919) 876-6888 NCBEEs #F-0326

DOCUMENT NOT CONSIDERED FINAL UNLESS ALL SIGNATURES COMPLETED

	Burlington-Graham Signal System Fiber-Optic Splicing Details		
	Division 7 Alamance County Burlington & Graham		
750 Greenfield Parkway, Garner, NC 27529	SCALE: N/A	PLAN DATE: June 2018 PREPARED BY: BJ SLOCUM REVISIONS: _____ INIT.: _____ DATE: _____	REVIEWED BY: HA BADGETT REVIEWED BY: DL JONES DATE: _____

CADD File name: FS 4.103.dgn

SPLICE NO.

S17-5

GRAND OAKS BLVD &
KIRKPATRICK RD
SEE: CRP-6.056

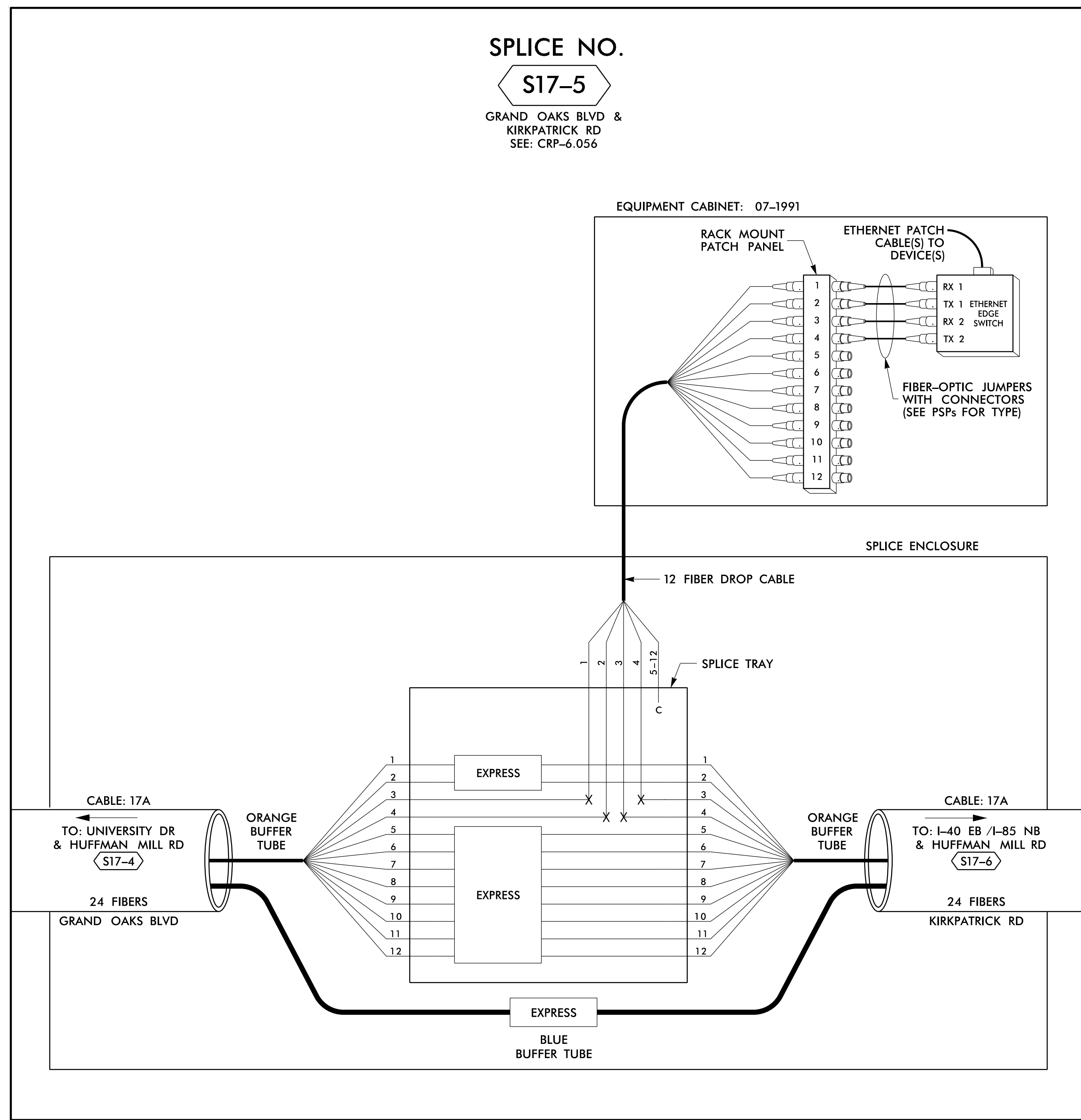

14-JUN-2018 12:30
 D:\Technical\proj\10056469 U-6015 B-C Sig Sys\Task 11_Comms\F S 4_104.dgn
 S:\DCS\653 AT_LUS355433

LEGEND

COLOR CODE TIA/EIA 598-B		X = FUSION SPlice INDIVIDUAL FIBER C = CAP AND SEAL
(1) BLUE	(7) RED	EXPRESS
(2) ORANGE	(8) BLACK	EXPRESS ENTIRE BUFFER TUBE / FIBERS THROUGH WITHOUT CUTTING
(3) GREEN	(9) YELLOW	BUFFER SPlice
(4) BROWN	(10) VIOLET	SPlice ALL FIBERS IN BUFFER TUBE COLOR TO COLOR
(5) SLATE	(11) ROSE	EXISTING
(6) WHITE	(12) AQUA	EXISTING BUFFER TUBE / FIBERS. DO NOT MODIFY EXISTING SPlices OR EXPRESSED FIBERS.

NOTES

- UNUSED FIBERS LEFT COILED AND STORED IN SPLICE TRAY
- UNUSED BUFFER TUBES LEFT COILED AND STORED IN SPLICE ENCLOSURE
- EDGE SWITCH CONFIGURATIONS ARE GENERIC. CONTRACTOR IS RESPONSIBLE FOR DETERMINING/ENSURING THE PROPER TERMINATIONS.

ATKINS 1616 EAST MILLBROOK ROAD, SUITE 160
 RALEIGH, NORTH CAROLINA 27609
 (919) 876-6888 NCBEEES #F-0326

DOCUMENT NOT CONSIDERED FINAL UNLESS ALL SIGNATURES COMPLETED

Prepared for the Offices of: 750 Greenfield Parkway, Garner, NC 27529	Burlington-Graham Signal System Fiber-Optic Splicing Details		SEAL NORTH CAROLINA PROFESSIONAL ENGINEER SEAL 040877 BRADFORD J. SLOCUM 15/2018
	Division 7 Alamance County PLAN DATE: June 2018 PREPARED BY: BJ SLOCUM	Burlington & Graham REVIEWED BY: HA BADGETT REVIEWED BY: DL JONES	
REVISIONS: _____ INIT. DATE _____			

DATE: _____
 CADD File name: FS 4.104.dgn

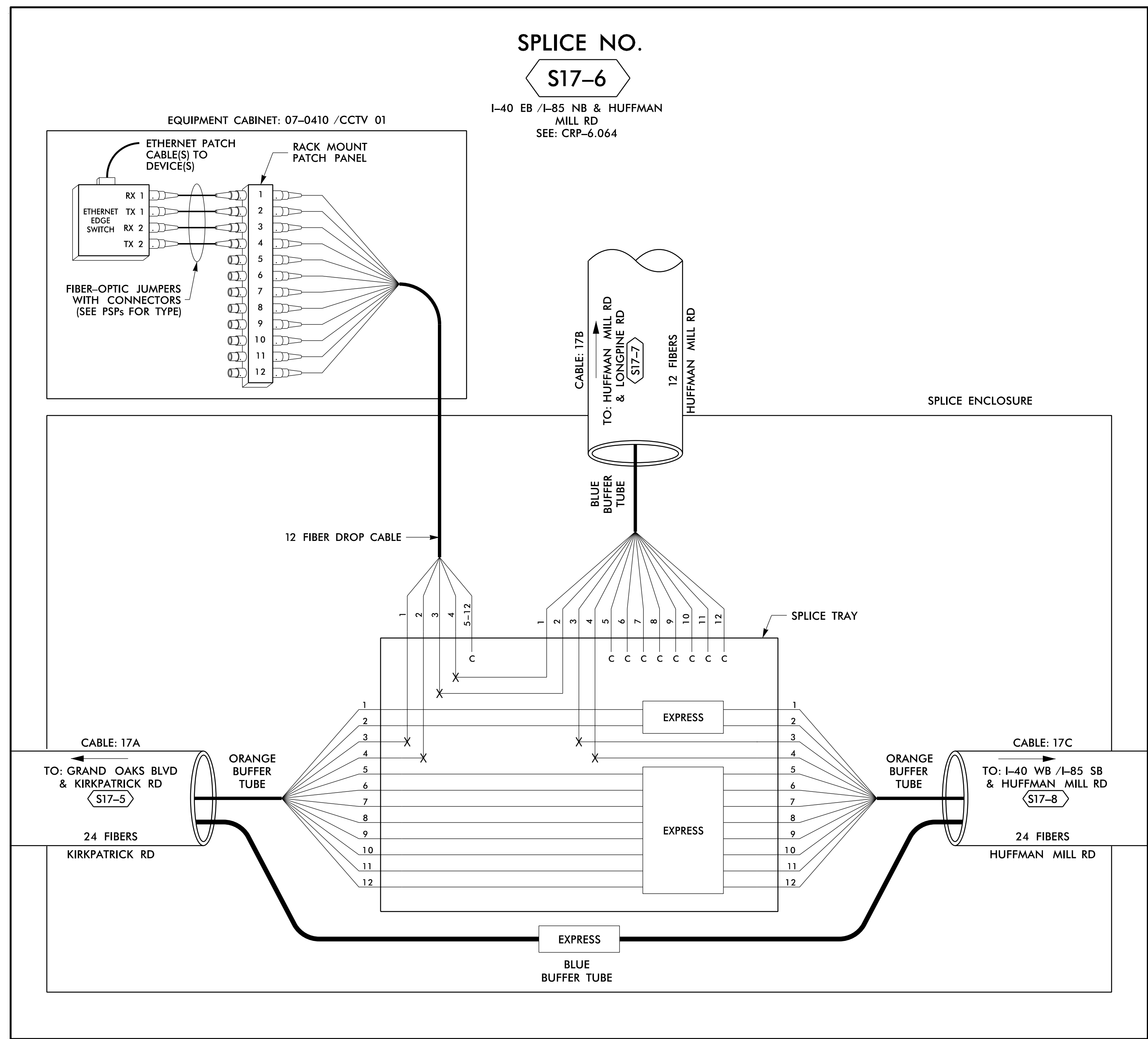

SPLICE NO.
S17-6

I-40 EB / I-85 NB & HUFFMAN
MILL RD
SEE: CRP-6.064

EQUIPMENT CABINET: 07-0410 / CCTV 01

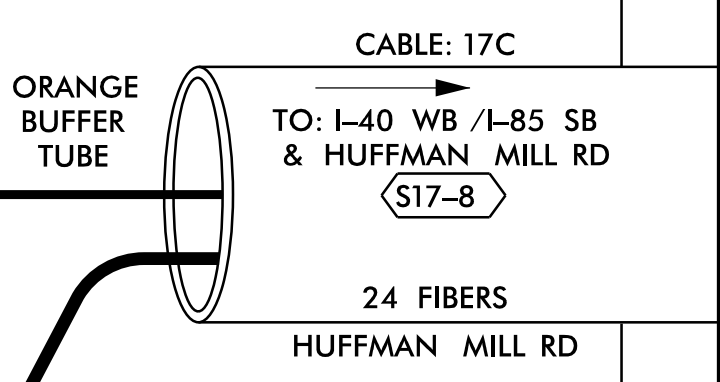
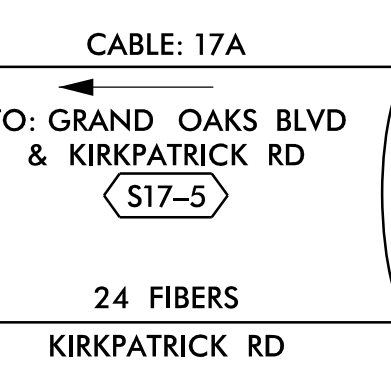
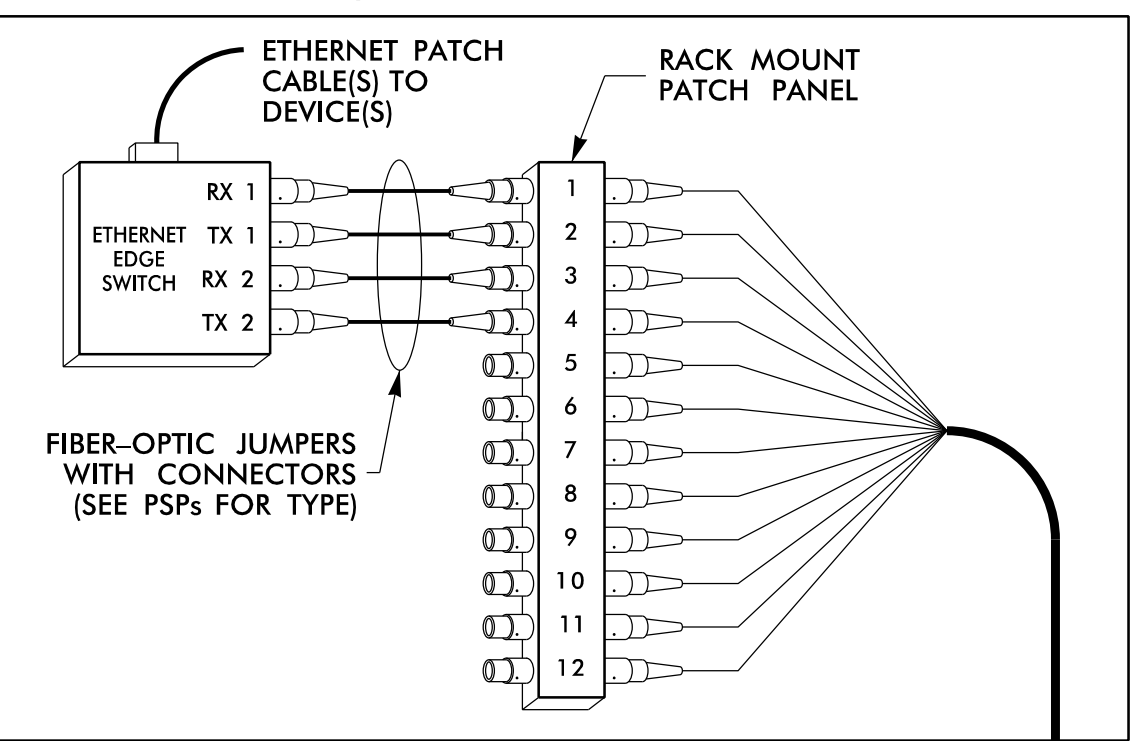

LEGEND

COLOR CODE TIA/EIA 598-B		X = FUSION SPlice INDIVIDUAL FIBER
(1) BLUE	(7) RED	C = CAP AND SEAL
(2) ORANGE	(8) BLACK	
(3) GREEN	(9) YELLOW	EXPRESS
(4) BROWN	(10) VIOLET	EXPRESS ENTIRE BUFFER TUBE / FIBERS THROUGH WITHOUT CUTTING
(5) SLATE	(11) ROSE	BUFFER SPlice
(6) WHITE	(12) AQUA	BUFFER SPlice SPLICE ALL FIBERS IN BUFFER TUBE COLOR TO COLOR
		EXISTING
		EXISTING EXISTING BUFFER TUBE / FIBERS DO NOT MODIFY EXISTING SPlices OR EXPRESSED FIBERS.

NOTES

- UNUSED FIBERS LEFT COILED AND STORED IN SPLICE TRAY
- UNUSED BUFFER TUBES LEFT COILED AND STORED IN SPLICE ENCLOSURE
- EDGE SWITCH CONFIGURATIONS ARE GENERIC. CONTRACTOR IS RESPONSIBLE FOR DETERMINING/ENSURING THE PROPER TERMINATIONS.



1616 EAST MILLBROOK ROAD, SUITE 160
RALEIGH, NORTH CAROLINA 27609
(919) 876-6888 NCBEEES #F-0326

DOCUMENT NOT CONSIDERED FINAL UNLESS ALL SIGNATURES COMPLETED

Prepared for the Offices of:

 750 Greenfield Parkway, Garner, NC 27529
 SCALE: N/A

Burlington-Graham Signal System Fiber-Optic Splicing Details		Burlington & Graham	
Division 7	Alamance County		
PLAN DATE: June 2018	REVIEWED BY: HA BADGETT		
PREPARED BY: BJ SLOCUM	REVIEWED BY: DL JONES		
REVISIONS	INIT.	DATE	

SEAL
 NORTH CAROLINA PROFESSIONAL ENGINEER
 SEAL 040877
 BRADFORD J. SLOCUM
 15/2018
 DATE
 CADD File name: FS 4.105.dgn

14-JUN-2018 12:31
 D:\projects\proj\100056469 U-6015 B-C Sig_Sys\Task 11_Comms\F 4_105.dgn
 S:\DCS\653 AT_LUS355433

SPLICE NO.

S17-7

HUFFMAN MILL RD &
LONGPINE RD
SEE: CRP-6.063

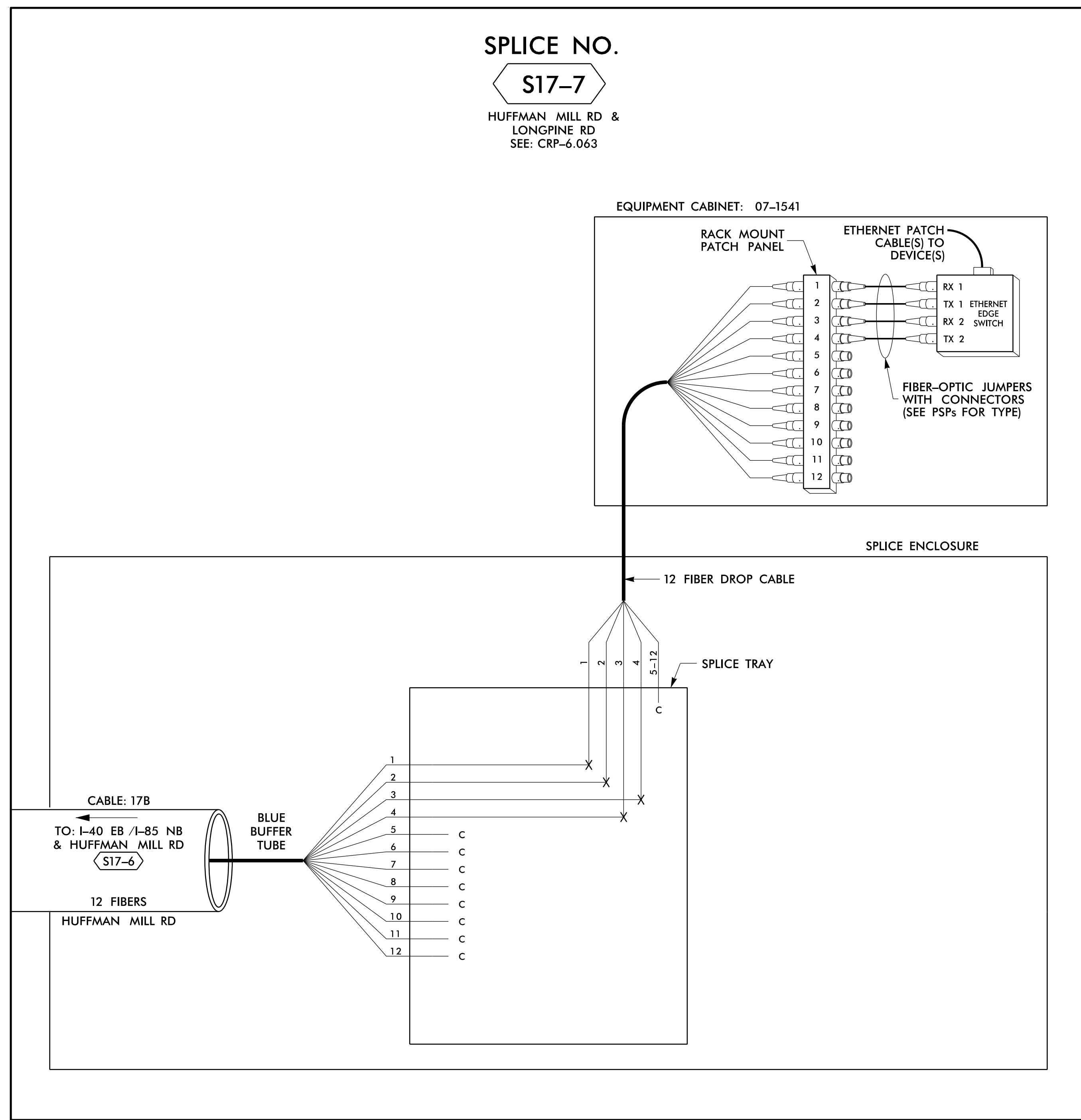

LEGEND

COLOR CODE TIA/EIA 598-B		X = FUSION SPLICE INDIVIDUAL FIBER
(1) BLUE	(7) RED	EXPRESS ENTIRE BUFFER TUBE / FIBERS THROUGH WITHOUT CUTTING
(2) ORANGE	(8) BLACK	EXPRESS
(3) GREEN	(9) YELLOW	BUFFER SPLICE
(4) BROWN	(10) VIOLET	SPLICE ALL FIBERS IN BUFFER TUBE COLOR TO COLOR
(5) SLATE	(11) ROSE	EXISTING
(6) WHITE	(12) AQUA	EXISTING BUFFER TUBE / FIBERS. DO NOT MODIFY EXISTING SPLICES OR EXPRESSED FIBERS.
		C = CAP AND SEAL

NOTES

- UNUSED FIBERS LEFT COILED AND STORED IN SPLICE TRAY
- UNUSED BUFFER TUBES LEFT COILED AND STORED IN SPLICE ENCLOSURE
- EDGE SWITCH CONFIGURATIONS ARE GENERIC. CONTRACTOR IS RESPONSIBLE FOR DETERMINING/ENSURING THE PROPER TERMINATIONS.

ATKINS 1616 EAST MILLBROOK ROAD, SUITE 160
RALEIGH, NORTH CAROLINA 27609
(919) 876-6888 NCBEEES #F-0326

DOCUMENT NOT CONSIDERED FINAL UNLESS ALL SIGNATURES COMPLETED

	Prepared for the Offices of: NORTH CAROLINA DEPARTMENT OF TRANSPORTATION Division 7		SEAL NORTH CAROLINA PROFESSIONAL ENGINEER SEAL 040877 BRADFORD J. SLOCUM ENGINEER 15/2018
	Burlington-Graham Signal System Fiber-Optic Splicing Details		
750 Greenfield Parkway, Garner, NC 27529 SCALE: N/A	Division 7 Alamance County Burlington & Graham PLAN DATE: June 2018 PREPARED BY: BJ SLOCUM REVISIONS: _____ INIT. DATE _____	REVIEWED BY: HA BADGETT REVIEWED BY: DL JONES	DATE: _____ DATE: _____ DATE: _____

14-JUN-2018 12:31
 D:\Technical\Projects\U-6015 B-C Sig. Sys\Task 11_Comms\F S 4.106.dgn
 S:\DCS\653 AT_LUS355433

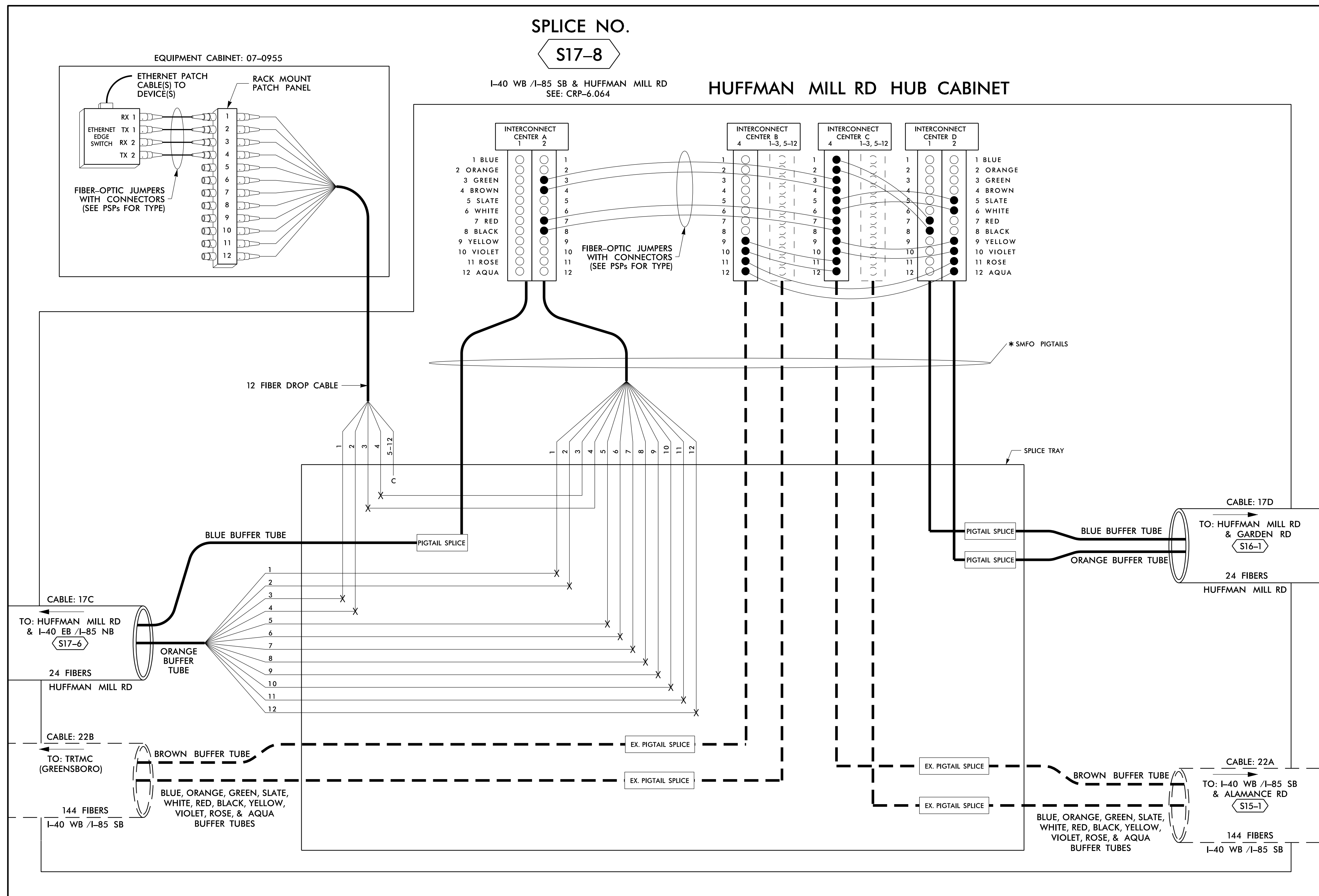

SPLICE NO.
S17-8

HUFFMAN MILL RD HUB CABINET

INTERCONNECT CENTER A (CABLE 17C) INTERCONNECT CENTER B (CABLE 22B)

- | | |
|---|--|
| <p>SLOT 1 (BLUE BUFFER TUBE)</p> <ul style="list-style-type: none"> 1 BLUE DARK 2 ORANGE DARK 3 GREEN DARK 4 BROWN DARK 5 SLATE DARK 6 WHITE DARK 7 RED DARK 8 BLACK DARK 9 YELLOW DARK 10 VIOLET DARK 11 ROSE DARK 12 AQUA DARK <p>SLOT 2 (ORANGE BUFFER TUBE)</p> <ul style="list-style-type: none"> 1 BLUE DARK 2 ORANGE DARK 3 GREEN RING 17 RX 4 BROWN RING 17 TX 5 SLATE DARK 6 WHITE DARK 7 RED RING 19 RX 8 BLACK RING 19 TX 9 YELLOW DARK 10 VIOLET DARK 11 ROSE DARK 12 AQUA DARK | <p>SLOT 4 (BROWN BUFFER TUBE)</p> <ul style="list-style-type: none"> 1 BLUE DARK 2 ORANGE DARK 3 GREEN DARK 4 BROWN DARK 5 SLATE DARK 6 WHITE DARK 7 RED DARK 8 BLACK DARK 9 YELLOW RING 22+ RX 10 VIOLET RING 22+ TX 11 ROSE RING 22 TX 12 AQUA RING 22 RX <p>SLOTS 1-3, 5-12 (ALL OTHER BUFFER TUBES)</p> <p>EXISTING TERMINATIONS AND CONNECTIONS TO REMAIN</p> |
|---|--|

INTERCONNECT CENTER C (CABLE 22A) INTERCONNECT CENTER D (CABLE 17D)

- | | |
|--|---|
| <p>SLOT 4 (BROWN BUFFER TUBE)</p> <ul style="list-style-type: none"> 1 BLUE RING 15 TX 2 ORANGE RING 15 RX 3 GREEN RING 17 TX 4 BROWN RING 17 RX 5 SLATE RING 18 TX 6 WHITE RING 18 RX 7 RED RING 19 TX 8 BLACK RING 19 RX 9 YELLOW RING 20 TX 10 VIOLET RING 20 RX 11 ROSE RING 22 TX 12 AQUA RING 22 RX <p>SLOTS 1-3, 5-12 (ALL OTHER BUFFER TUBES)</p> <p>EXISTING TERMINATIONS AND CONNECTIONS TO REMAIN</p> | <p>SLOT 1 (BLUE BUFFER TUBE)</p> <ul style="list-style-type: none"> 1 BLUE DARK 2 ORANGE DARK 3 GREEN DARK 4 BROWN DARK 5 SLATE RING 18 RX 6 WHITE RING 18 TX 7 RED RING 15 RX 8 BLACK RING 15 TX 9 YELLOW DARK 10 VIOLET DARK 11 ROSE DARK 12 AQUA DARK <p>SLOT 2 (ORANGE BUFFER TUBE)</p> <ul style="list-style-type: none"> 1 BLUE DARK 2 ORANGE DARK 3 GREEN DARK 4 BROWN DARK 5 SLATE RING 18 RX 6 WHITE RING 18 TX 7 RED RING 15 RX 8 BLACK RING 15 TX 9 YELLOW RING 20 RX 10 VIOLET RING 20 TX 11 ROSE RING 22 RX 12 AQUA RING 22 TX |
|--|---|

* SMFO PIGTAILS TO BE SPLICED TO BUFFER TUBES COLOR TO COLOR.

14 JUN 2018 12:31 D:\projects\proj\con\tr\off\c\cur*100056469 U=6015 B=C Sig Sys\Task 11_Corrs\F5 4.107.dgn S:\DCS\653 AT LUS355433

LEGEND

<table border="1"> <tr> <th colspan="2">COLOR CODE</th> </tr> <tr> <td>TIA/EIA</td> <td>598-B</td> </tr> </table>	COLOR CODE		TIA/EIA	598-B	<table border="0"> <tr> <td>(1) BLUE</td> <td>(7) RED</td> <td>EXPRESS</td> <td>EXPRESS ENTIRE BUFFER TUBE / FIBERS THROUGH WITHOUT CUTTING</td> </tr> <tr> <td>(2) ORANGE</td> <td>(8) BLACK</td> <td>BUFFER SPLICE</td> <td>SPLICE ALL FIBERS IN BUFFER TUBE COLOR TO COLOR</td> </tr> <tr> <td>(3) GREEN</td> <td>(9) YELLOW</td> <td>EXISTING</td> <td>EXISTING BUFFER TUBE / FIBERS DO NOT MODIFY EXISTING SPLICES OR EXPRESSED FIBERS.</td> </tr> <tr> <td>(4) BROWN</td> <td>(10) VIOLET</td> <td></td> <td></td> </tr> <tr> <td>(5) SLATE</td> <td>(11) ROSE</td> <td></td> <td></td> </tr> <tr> <td>(6) WHITE</td> <td>(12) AQUA</td> <td></td> <td></td> </tr> </table>	(1) BLUE	(7) RED	EXPRESS	EXPRESS ENTIRE BUFFER TUBE / FIBERS THROUGH WITHOUT CUTTING	(2) ORANGE	(8) BLACK	BUFFER SPLICE	SPLICE ALL FIBERS IN BUFFER TUBE COLOR TO COLOR	(3) GREEN	(9) YELLOW	EXISTING	EXISTING BUFFER TUBE / FIBERS DO NOT MODIFY EXISTING SPLICES OR EXPRESSED FIBERS.	(4) BROWN	(10) VIOLET			(5) SLATE	(11) ROSE			(6) WHITE	(12) AQUA		
COLOR CODE																													
TIA/EIA	598-B																												
(1) BLUE	(7) RED	EXPRESS	EXPRESS ENTIRE BUFFER TUBE / FIBERS THROUGH WITHOUT CUTTING																										
(2) ORANGE	(8) BLACK	BUFFER SPLICE	SPLICE ALL FIBERS IN BUFFER TUBE COLOR TO COLOR																										
(3) GREEN	(9) YELLOW	EXISTING	EXISTING BUFFER TUBE / FIBERS DO NOT MODIFY EXISTING SPLICES OR EXPRESSED FIBERS.																										
(4) BROWN	(10) VIOLET																												
(5) SLATE	(11) ROSE																												
(6) WHITE	(12) AQUA																												

X = FUSION SPLICE INDIVIDUAL FIBER
C = CAP AND SEAL

- NOTES**
- UNUSED FIBERS LEFT COILED AND STORED IN SPLICE TRAY
 - UNUSED BUFFER TUBES LEFT COILED AND STORED IN SPLICE ENCLOSURE
 - EDGE SWITCH CONFIGURATIONS ARE GENERIC. CONTRACTOR IS RESPONSIBLE FOR DETERMINING/ENSURING THE PROPER TERMINATIONS.

ATKINS 1616 EAST MILLBROOK ROAD, SUITE 160
RALEIGH, NORTH CAROLINA 27609
(919) 876-6888 NCBEEES #F-0326

Prepared for the Offices of:

 Burlington-Graham Signal System
 Fiber-Optic Splicing Details
 Division 7 Alamance County Burlington & Graham
 PLAN DATE: June 2018 REVIEWED BY: HA BADGETT
 PREPARED BY: BJ SLOCUM REVIEWED BY: DL JONES
 SCALE: N/A
 REVISIONS: _____ INIT. DATE
 SEAL NORTH CAROLINA PROFESSIONAL ENGINEER SEAL 040877
 BRAD F. SLOCUM
 DATE: 6/15/2018
 CADD File name: FS_4.107.dgn

DOCUMENT NOT CONSIDERED FINAL
UNLESS ALL SIGNATURES COMPLETED

SPLICE NO. S18-1

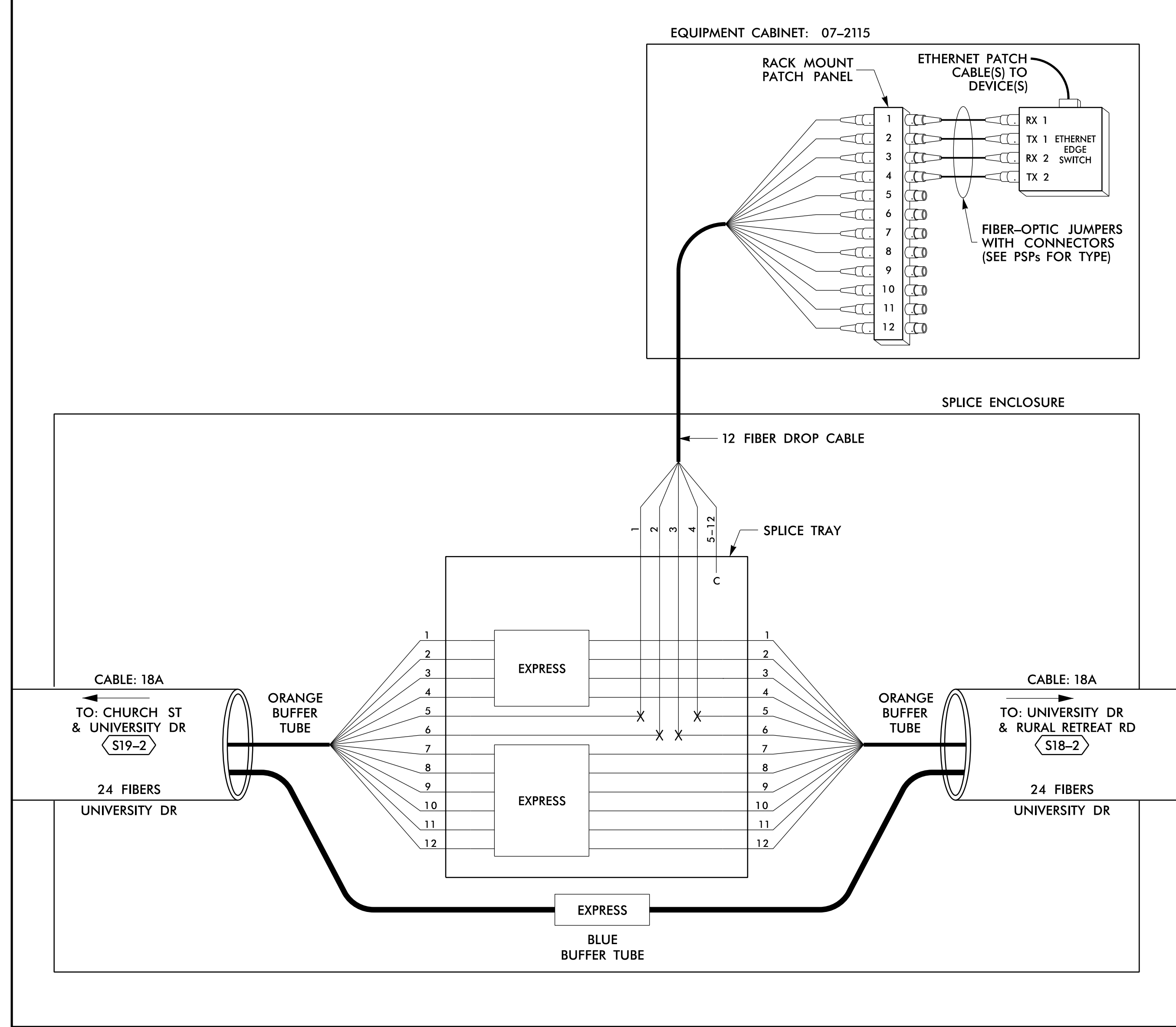
UNIVERSITY DR & SHOPPING CENTER SEE: CRP-6.047



SPLICE NO. S18-2

UNIVERSITY DR & RURAL RETREAT RD SEE: CRP-6.049

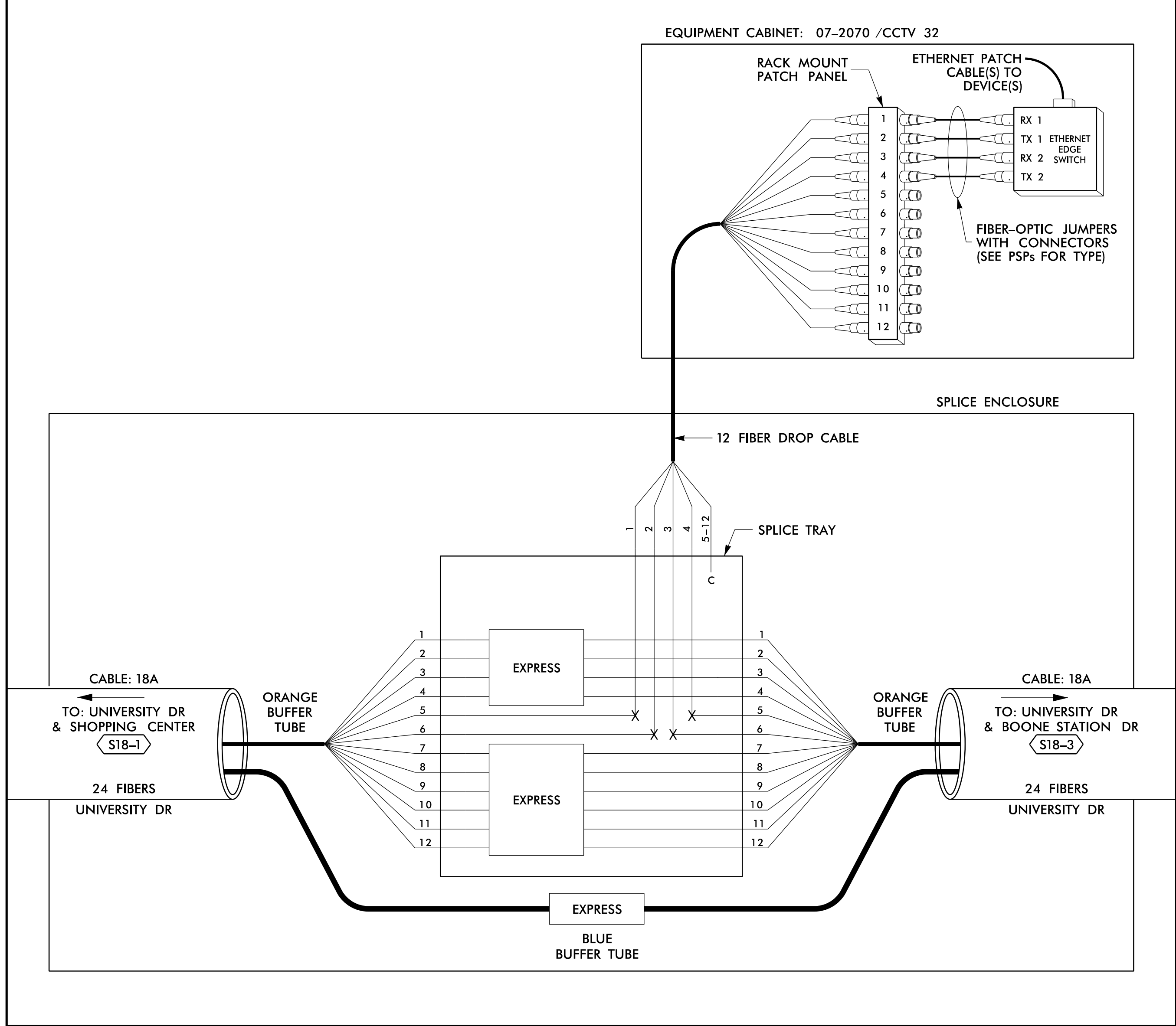

14 JUN 2018 12:31 D:\projects\proj\com\tr\off\c\curr\100056469 U-6015 B-C Sig Sys\Task 11_Comm\FS 4_108.dgn SLO353 AT LUS353

LEGEND

COLOR CODE TIA/EIA 598-B		X = FUSION SPlice INDIVIDUAL FIBER	
(1) BLUE	(7) RED	EXPRESS	EXPRESS ENTIRE BUFFER TUBE /FIBERS THROUGH WITHOUT CUTTING
(2) ORANGE	(8) BLACK	BUFFER SPlice	SPlice ALL FIBERS IN BUFFER TUBE COLOR TO COLOR
(3) GREEN	(9) YELLOW	EXISTING	EXISTING BUFFER TUBE /FIBERS DO NOT MODIFY EXISTING SPlices OR EXPRESSED FIBERS.
(4) BROWN	(10) VIOLET		
(5) SLATE	(11) ROSE		
(6) WHITE	(12) AQUA		

NOTES

1. UNUSED FIBERS LEFT COILED AND STORED IN SPLICE TRAY
2. UNUSED BUFFER TUBES LEFT COILED AND STORED IN SPLICE ENCLOSURE
3. EDGE SWITCH CONFIGURATIONS ARE GENERIC. CONTRACTOR IS RESPONSIBLE FOR DETERMINING/ENSURING THE PROPER TERMINATIONS.

ATKINS 1616 EAST MILLBROOK ROAD, SUITE 160 RALEIGH, NORTH CAROLINA 27609 (919) 876-6888 NCBEEES #F-0326

DOCUMENT NOT CONSIDERED FINAL UNLESS ALL SIGNATURES COMPLETED

Prepared for the Offices of:

Burlington-Graham Signal System Fiber-Optic Splicing Details

Division 7 Alamance County Burlington & Graham

PLAN DATE: June 2018 REVIEWED BY: HA BADGETT

PREPARED BY: BJ SLOCUM REVIEWED BY: DL JONES

750 Greenfield Parkway, Garner, NC 27529

SCALE: N/A

REVISIONS	INIT.	DATE

SEAL NORTH CAROLINA PROFESSIONAL ENGINEER SEAL 040877 BRADford J. SLOCUM

DATE: 6/15/2018

CADD File Name: FS 4.108.dgn

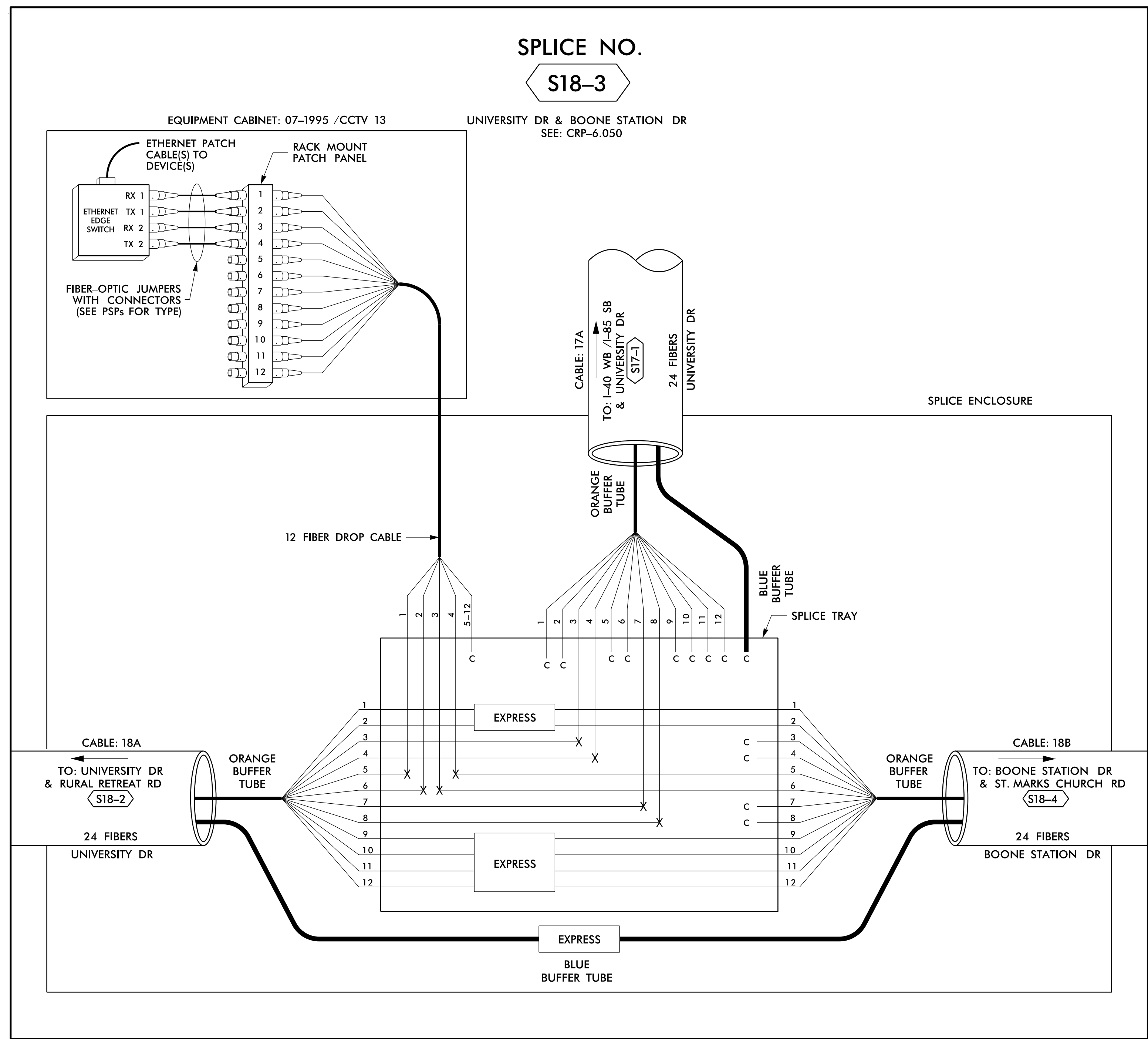

14-JUN-2018 12:31
 D:\projects\proj\11\comms\11\comms\Fs 4.109.dgn
 S:\035633 AT_LUS355433

COLOR CODE		LEGEND	
(1) BLUE	(7) RED	EXPRESS	EXPRESS ENTIRE BUFFER TUBE /FIBERS THROUGH WITHOUT CUTTING
(2) ORANGE	(8) BLACK	BUFFER SPlice	SPLICE ALL FIBERS IN BUFFER TUBE COLOR TO COLOR
(3) GREEN	(9) YELLOW	EXISTING	EXISTING BUFFER TUBE /FIBERS DO NOT MODIFY EXISTING SPLICES OR EXPRESSED FIBERS.
(4) BROWN	(10) VIOLET		
(5) SLATE	(11) ROSE		
(6) WHITE	(12) AQUA		

- NOTES**
- UNUSED FIBERS LEFT COILED AND STORED IN SPLICE TRAY
 - UNUSED BUFFER TUBES LEFT COILED AND STORED IN SPLICE ENCLOSURE
 - EDGE SWITCH CONFIGURATIONS ARE GENERIC. CONTRACTOR IS RESPONSIBLE FOR DETERMINING/ENSURING THE PROPER TERMINATIONS.

ATKINS 1616 EAST MILLBROOK ROAD, SUITE 160
RALEIGH, NORTH CAROLINA 27609
(919) 876-6888 NCBEEs #F-0326

DOCUMENT NOT CONSIDERED FINAL UNLESS ALL SIGNATURES COMPLETED

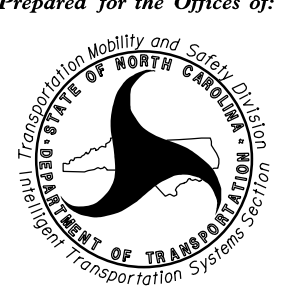
Prepared for the Offices of:  DEPARTMENT OF TRANSPORTATION STATE OF NORTH CAROLINA		SEAL NORTH CAROLINA PROFESSIONAL ENGINEER SEAL 040877 BRADFORD J. SLOCUM 15/2018 DATE	
Burlington-Graham Signal System Fiber-Optic Splicing Details			
Division 7 Alamance County Burlington & Graham		PLAN DATE: June 2018 REVIEWED BY: HA BADGETT	
PREPARED BY: BJ SLOCUM		REVIEWED BY: DL JONES	
SCALE N/A		REVISIONS INIT. DATE	
CAD00 File name: FS 4.109.dgn			

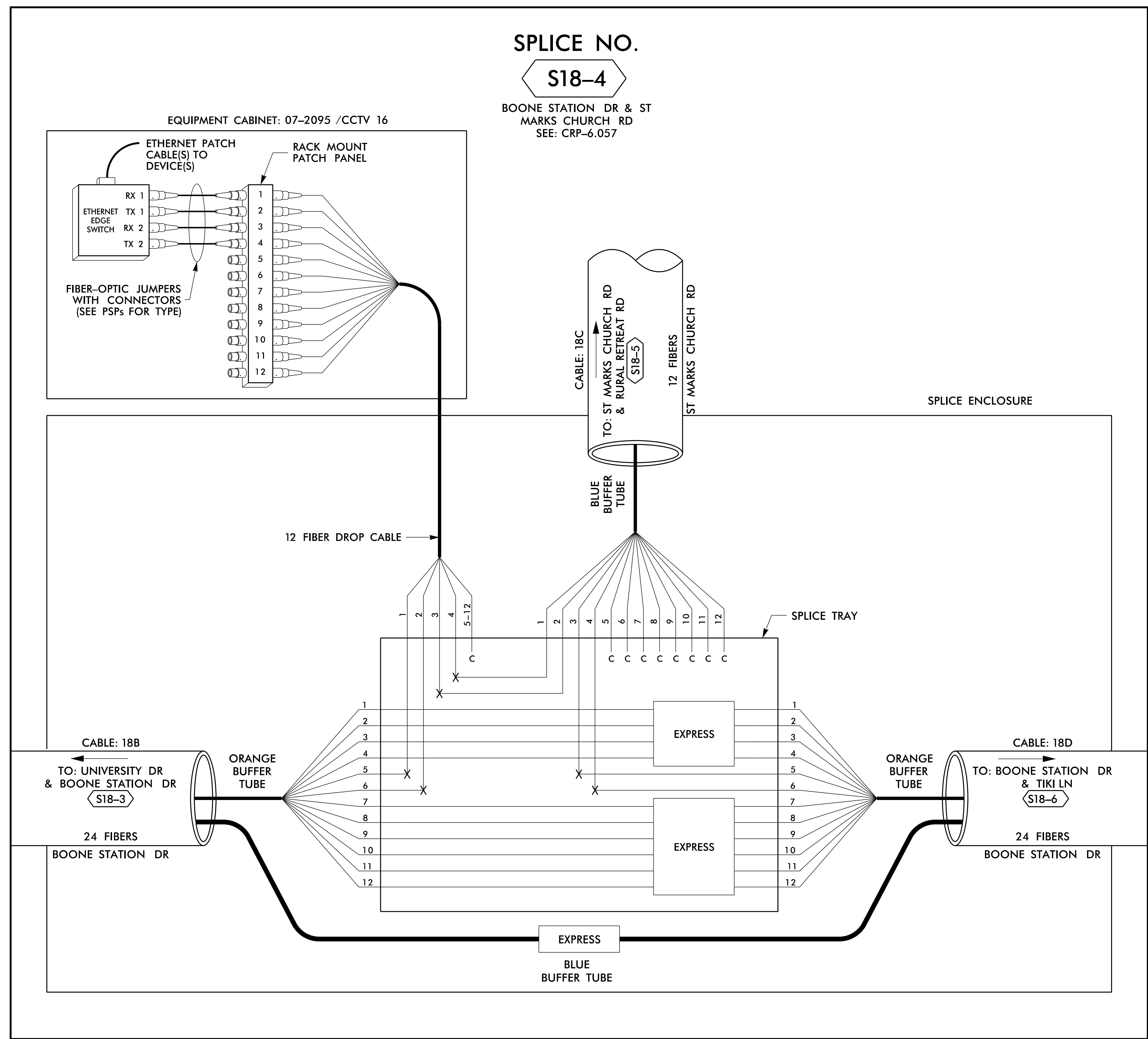

SPLICE NO.

S18-4

BOONE STATION DR & ST
MARKS CHURCH RD
SEE: CRP-6.057

EQUIPMENT CABINET: 07-2095 / CCTV 16

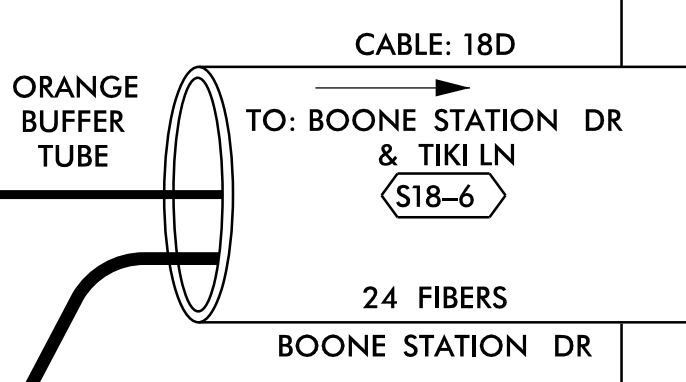
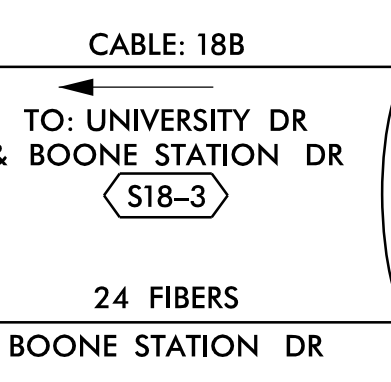
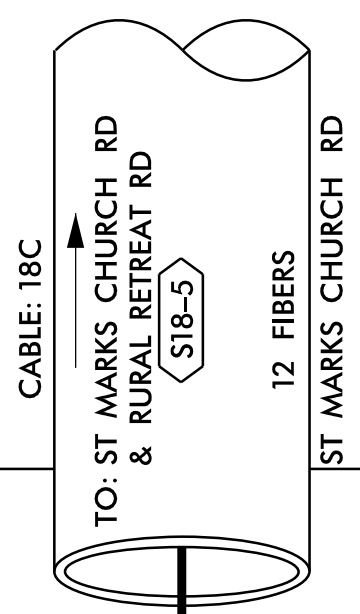
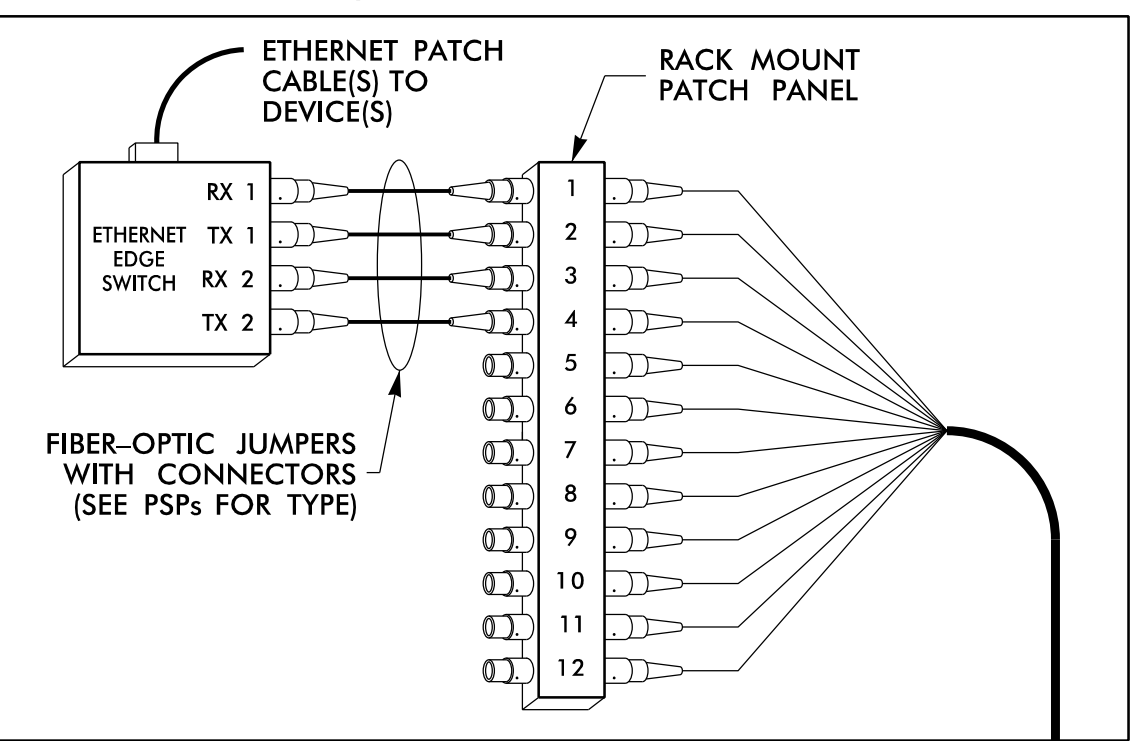

LEGEND

COLOR CODE TIA/EIA 598-B		X = FUSION SPlice INDIVIDUAL FIBER
(1) BLUE	(7) RED	C = CAP AND SEAL
(2) ORANGE	(8) BLACK	
(3) GREEN	(9) YELLOW	EXPRESS
(4) BROWN	(10) VIOLET	BUFFER SPlice
(5) SLATE	(11) ROSE	EXISTING
(6) WHITE	(12) AQUA	

NOTES

- UNUSED FIBERS LEFT COILED AND STORED IN SPLICE TRAY
- UNUSED BUFFER TUBES LEFT COILED AND STORED IN SPLICE ENCLOSURE
- EDGE SWITCH CONFIGURATIONS ARE GENERIC. CONTRACTOR IS RESPONSIBLE FOR DETERMINING/ENSURING THE PROPER TERMINATIONS.

ATKINS

1616 EAST MILLBROOK ROAD, SUITE 160
RALEIGH, NORTH CAROLINA 27609
(919) 876-6888 NCBES #F-0326

DOCUMENT NOT CONSIDERED FINAL
UNLESS ALL SIGNATURES COMPLETED

Prepared for the Offices of:

 750 Greenfield Parkway, Garner, NC 27529
 SCALE: N/A

Burlington-Graham Signal System Fiber-Optic Splicing Details		Burlington & Graham	
Division 7	Alamance County		
PLAN DATE: June 2018	REVIEWED BY: HA BADGETT		
PREPARED BY: BJ SLOCUM	REVIEWED BY: DL JONES		
REVISIONS	INIT.	DATE	

SEAL
 NORTH CAROLINA
 PROFESSIONAL
 SEAL
 040877
 ENGINEER
 BRADFORD J. SLOCUM
 15/2018
 DATE
 CADD File name: FS 4.110.dgn

14 JUN 2018 12:31
 D:\projects\proj\100056469 U-6015 B-C Sig_Sys\Task 11_Comms\F 4.110.dgn
 S:\DCS\653 AT_LUS355433

SPLICE NO.

S18-5

ST MARKS CHURCH RD &
RURAL RETREAT RD
SEE: CRP-6.070

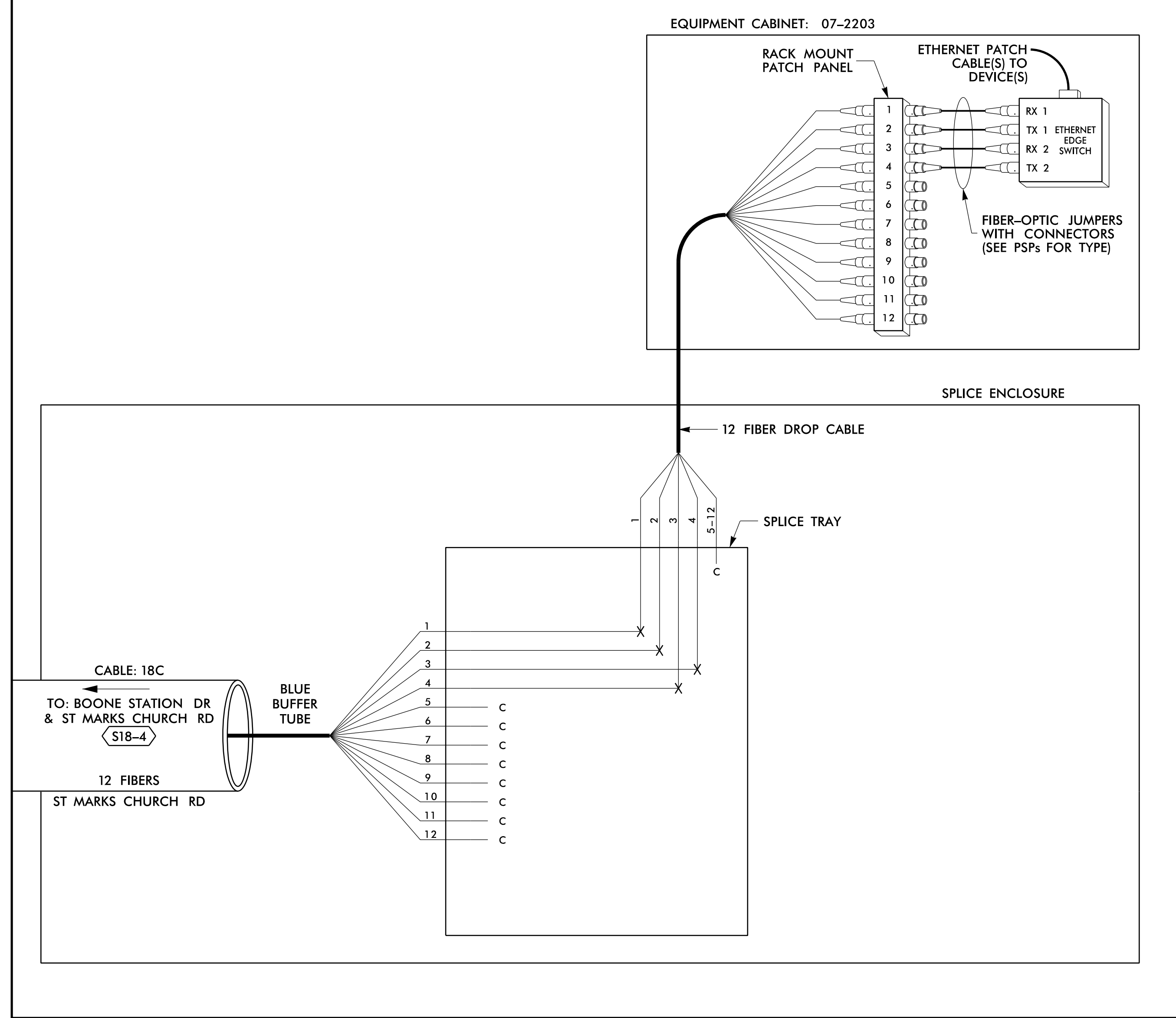

SPLICE NO.

S18-6

BOONE STATION DR & TIKI
SEE: CRP-6.058

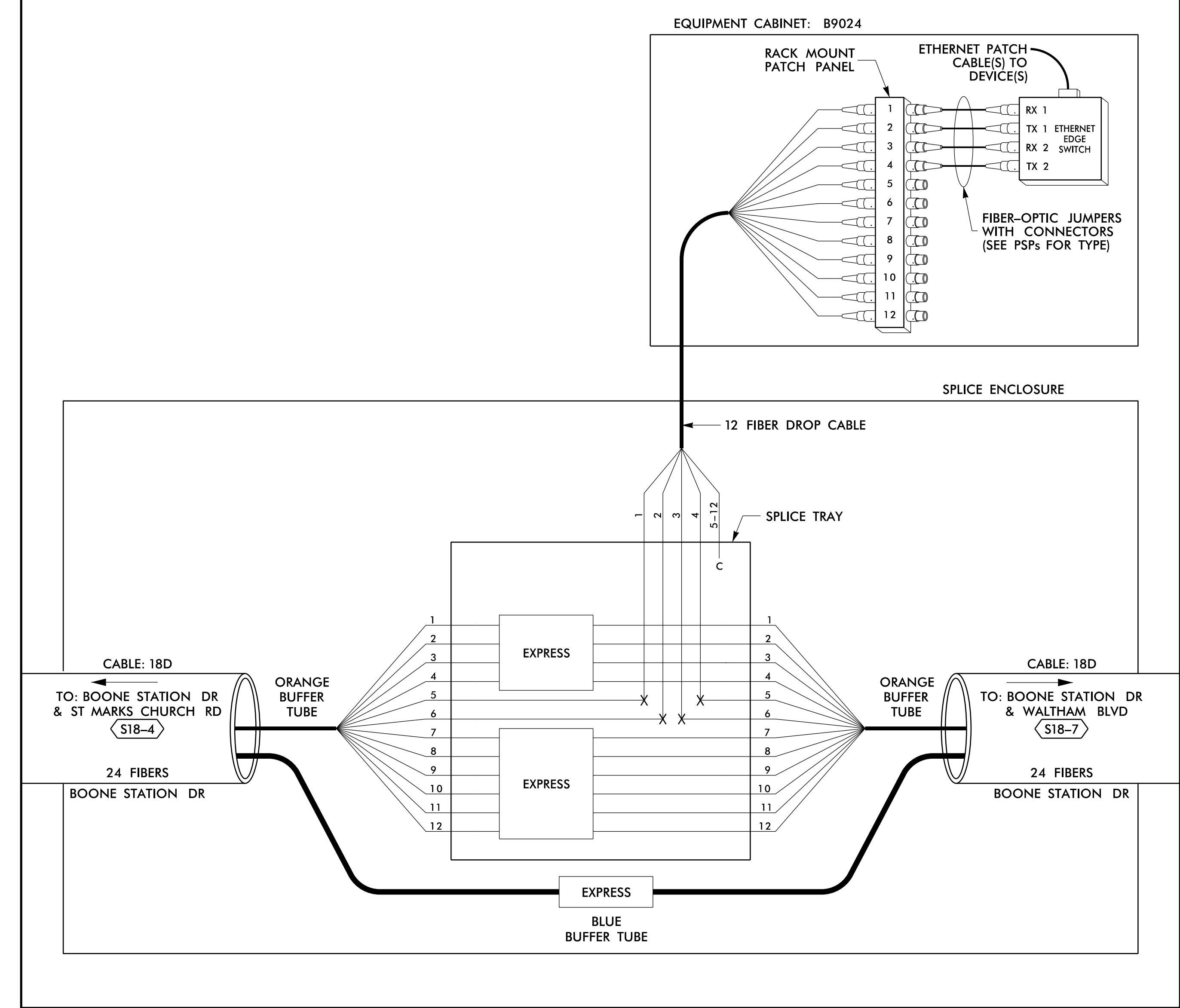

14 JUN 2018 12:31
 D:\projects\proj\100056469 U-6015 B-C Sig Sys\Task 11_Corrs\Fs 4.111.dgn
 S:\033633 AT_LUS355433

LEGEND

X = FUSION SPlice INDIVIDUAL FIBER C = CAP AND SEAL	
(1) BLUE (2) ORANGE (3) GREEN (4) BROWN (5) SLATE (6) WHITE	(7) RED (8) BLACK (9) YELLOW (10) VIOLET (11) ROSE (12) AQUA
EXPRESS BUFFER SPlice EXISTING	EXPRESS ENTIRE BUFFER TUBE /FIBERS THROUGH WITHOUT CUTTING SPlice ALL FIBERS IN BUFFER TUBE COLOR TO COLOR EXISTING BUFFER TUBE /FIBERS DO NOT MODIFY EXISTING SPlices OR EXPRESSED FIBERS.

NOTES

- UNUSED FIBERS LEFT COILED AND STORED IN SPlice TRAY
- UNUSED BUFFER TUBES LEFT COILED AND STORED IN SPlice ENCLOSURE
- EDGE SWITCH CONFIGURATIONS ARE GENERIC. CONTRACTOR IS RESPONSIBLE FOR DETERMINING/ENSURING THE PROPER TERMINATIONS.

ATKINS 1616 EAST MILLBROOK ROAD, SUITE 160
RALEIGH, NORTH CAROLINA 27609
(919) 876-6888 NCBEEs #F-0326

DOCUMENT NOT CONSIDERED FINAL UNLESS ALL SIGNATURES COMPLETED

Prepared for the Offices of: 750 Greenfield Parkway, Garner, NC 27529	Burlington-Graham Signal System Fiber-Optic Splicing Details		SEAL NORTH CAROLINA PROFESSIONAL SEAL 040877 ENGINEER Bradford J. Slocum 15/2018 DATE
	Division 7 Alamance County Burlington & Graham	PLAN DATE: June 2018 PREPARED BY: BJ SLOCUM REVISIONS: _____ SCALE: N/A	

SPLICE NO.

S18-7

BOONE STATION DR &
WALTHAM BLVD
SEE: CRP-6.059

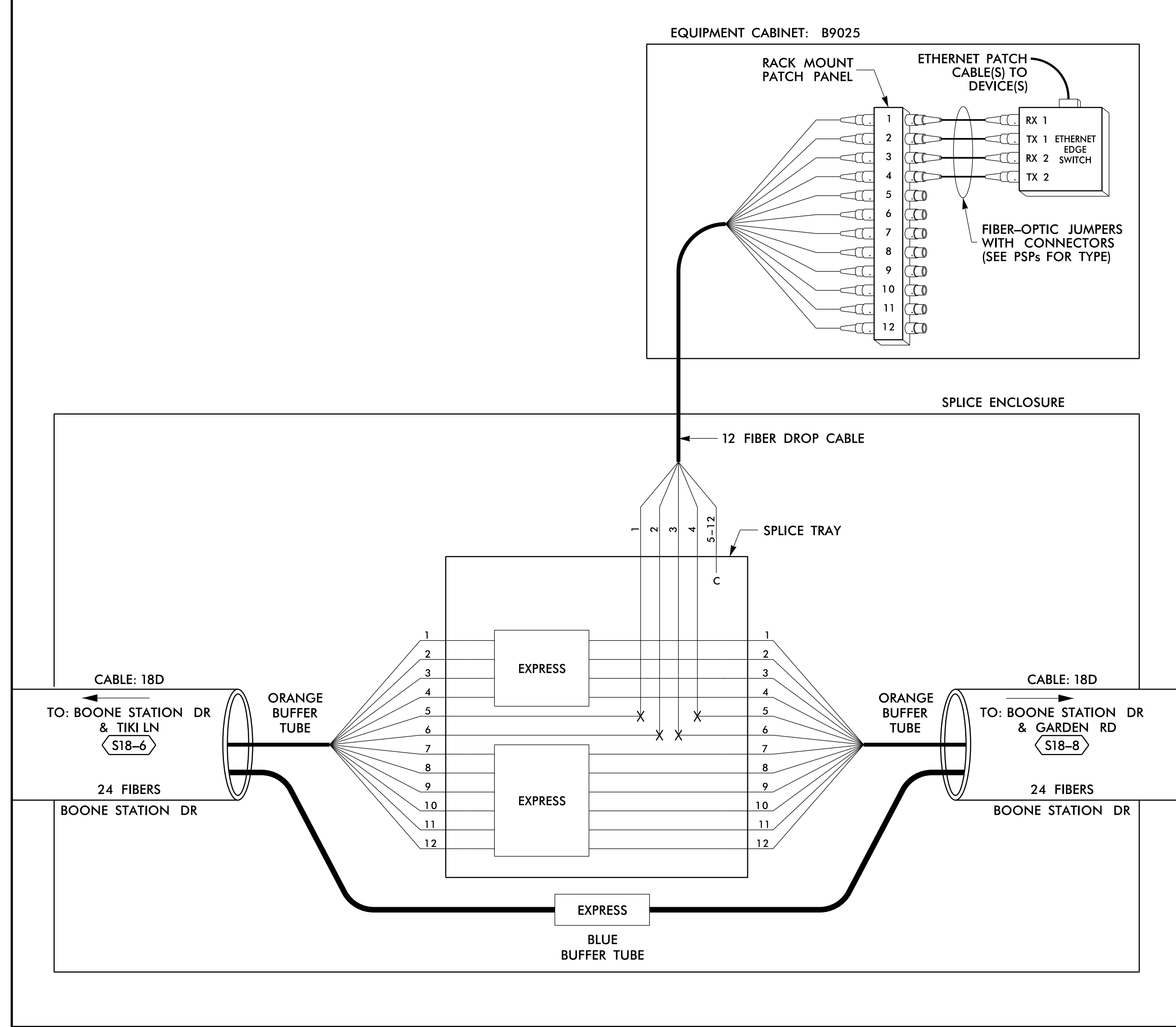

SPLICE NO.

S18-8

BOONE STATION DR &
GARDEN RD
SEE: CRP-6.060

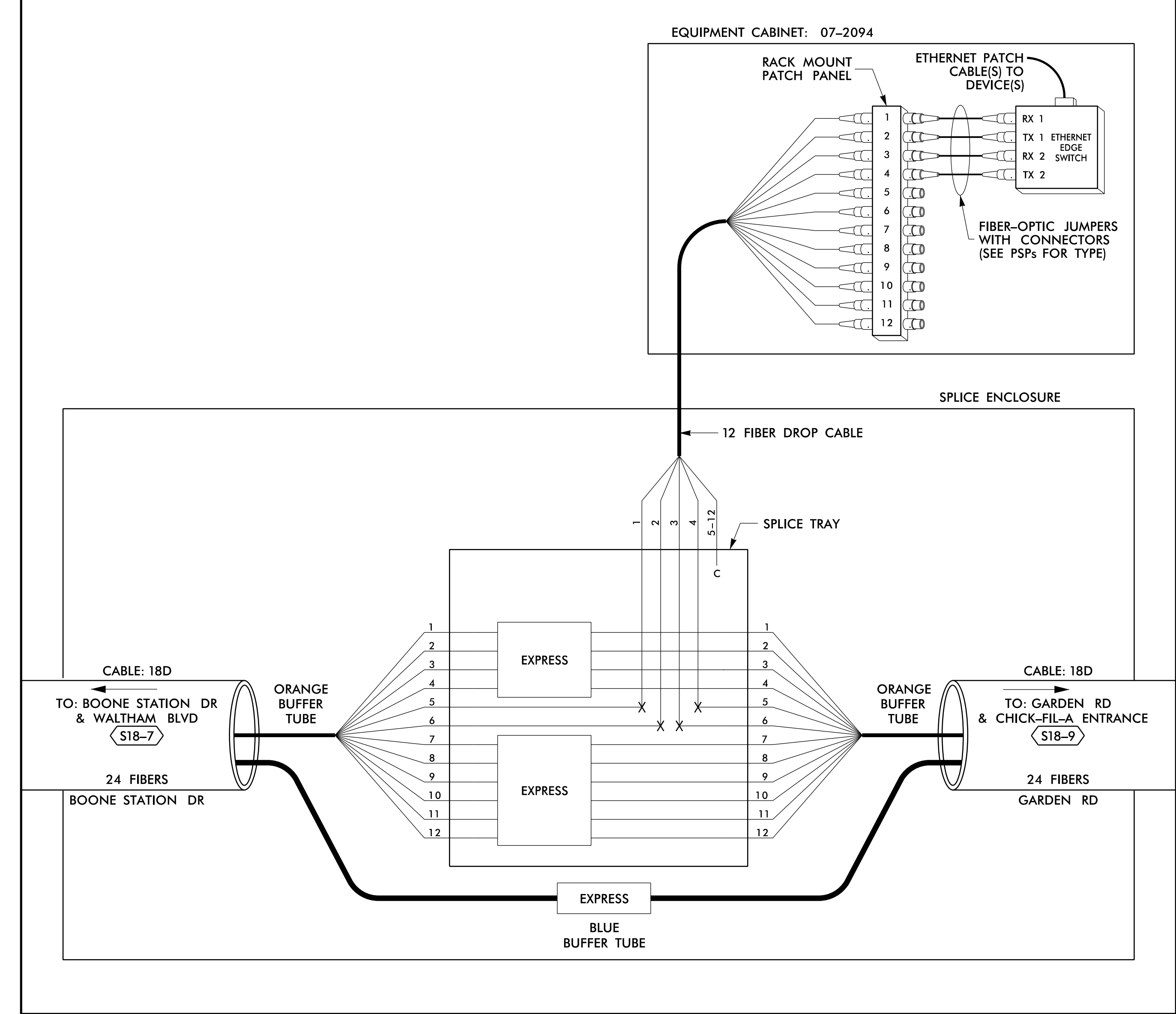

14 JUN 2018 12:31
 D:\projects\proj\11\comms\11_112.dgn
 0:*\t\comms\11\comms\11_112.dgn
 S:\033633 AT LUS355433

LEGEND

COLOR CODE TIA/EIA 598-B		X = FUSION SPlice INDIVIDUAL FIBER C = CAP AND SEAL
(1) BLUE	(7) RED	EXPRESS
(2) ORANGE	(8) BLACK	EXPRESS ENTIRE BUFFER TUBE / FIBERS THROUGH WITHOUT CUTTING
(3) GREEN	(9) YELLOW	BUFFER SPlice
(4) BROWN	(10) VIOLET	BUFFER SPlice
(5) SLATE	(11) ROSE	EXISTING
(6) WHITE	(12) AQUA	EXISTING
		SPlice ALL FIBERS IN BUFFER TUBE COLOR TO COLOR
		EXISTING BUFFER TUBE / FIBERS DO NOT MODIFY EXISTING SPlices OR EXPRESSED FIBERS.

NOTES

- UNUSED FIBERS LEFT COILED AND STORED IN SPlice TRAY
- UNUSED BUFFER TUBES LEFT COILED AND STORED IN SPlice ENCLOSURE
- EDGE SWITCH CONFIGURATIONS ARE GENERIC. CONTRACTOR IS RESPONSIBLE FOR DETERMINING/ENSURING THE PROPER TERMINATIONS.

ATKINS 1616 EAST MILLBROOK ROAD, SUITE 160
RALEIGH, NORTH CAROLINA 27609
(919) 876-6888 NCBEEES #F-0326

Prepared for the Offices of: 750 Greenfield Parkway, Garner, NC 27529	Burlington-Graham Signal System Fiber-Optic Splicing Details		SEAL NORTH CAROLINA PROFESSIONAL ENGINEER SEAL 040877 BRADFORD J. SLOCUM 15/2018 DATE
	Division 7 Alamance County Burlington & Graham	PLAN DATE: June 2018 PREPARED BY: BJ SLOCUM REVISIONS:	
SCALE: N/A	DOCUMENT NOT CONSIDERED FINAL UNLESS ALL SIGNATURES COMPLETED		CAD FILE NAME: FS 4.112.dgn

SPLICE NO.

S18-9

GARDEN RD & CHICK-FIL-A
ENTRANCE
SEE: CRP-6.062

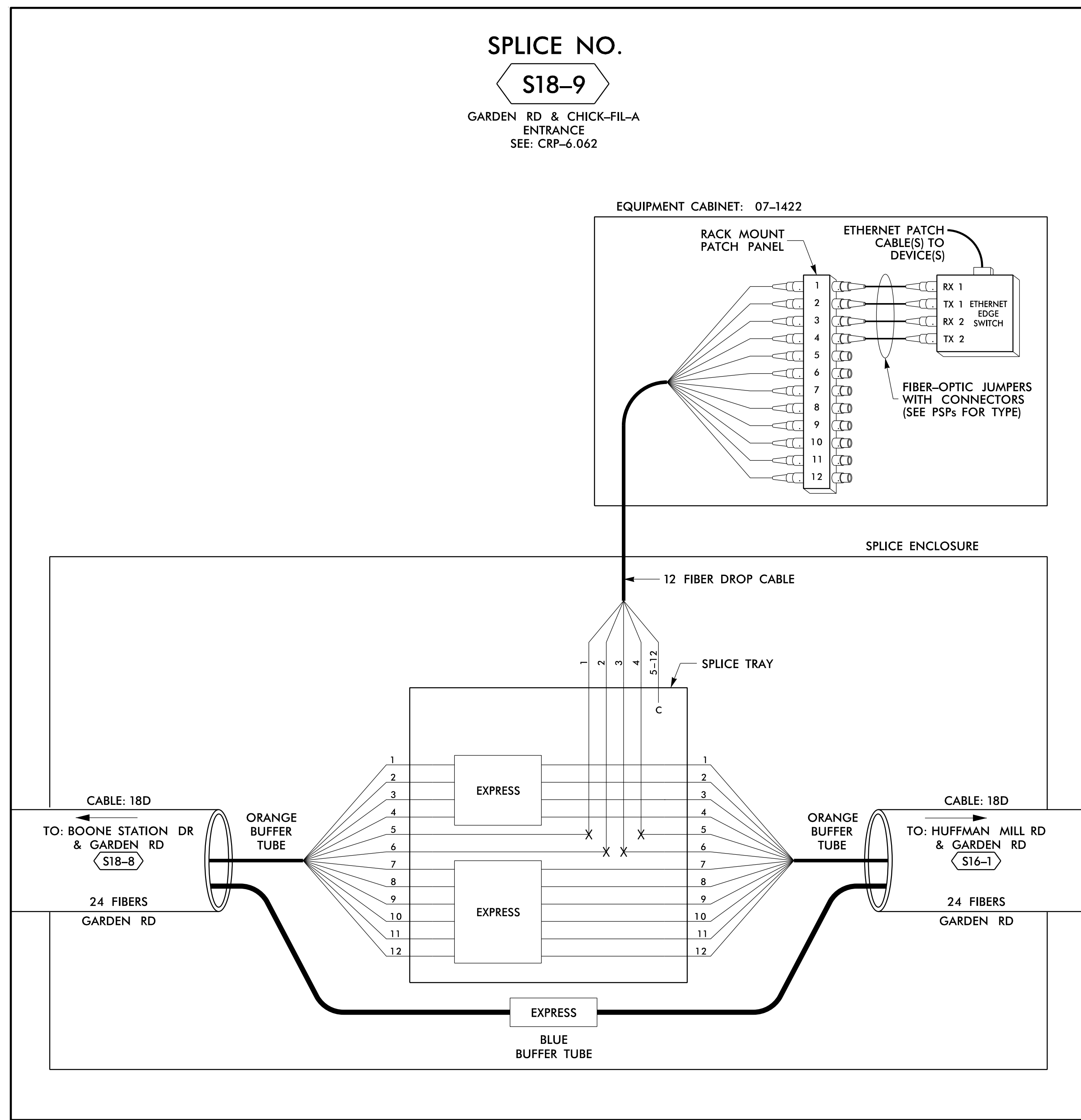

14 JUN 2018 12:31
 D:\Technical\proj\11\comms\11_Coms\Fs 4.113.dgn
 S:\035633 AT_LUS355433

LEGEND

COLOR CODE TIA/EIA 598-B		X = FUSION SPlice INDIVIDUAL FIBER C = CAP AND SEAL
(1) BLUE	(7) RED	EXPRESS
(2) ORANGE	(8) BLACK	EXPRESS ENTIRE BUFFER TUBE / FIBERS THROUGH WITHOUT CUTTING
(3) GREEN	(9) YELLOW	BUFFER SPlice
(4) BROWN	(10) VIOLET	SPlice ALL FIBERS IN BUFFER TUBE COLOR TO COLOR
(5) SLATE	(11) ROSE	EXISTING
(6) WHITE	(12) AQUA	EXISTING BUFFER TUBE / FIBERS. DO NOT MODIFY EXISTING SPlices OR EXPRESSED FIBERS.

NOTES

- UNUSED FIBERS LEFT COILED AND STORED IN SPLICE TRAY
- UNUSED BUFFER TUBES LEFT COILED AND STORED IN SPLICE ENCLOSURE
- EDGE SWITCH CONFIGURATIONS ARE GENERIC. CONTRACTOR IS RESPONSIBLE FOR DETERMINING/ENSURING THE PROPER TERMINATIONS.

ATKINS 1616 EAST MILLBROOK ROAD, SUITE 160
 RALEIGH, NORTH CAROLINA 27609
 (919) 876-6888 NCBEEES #F-0326

DOCUMENT NOT CONSIDERED FINAL UNLESS ALL SIGNATURES COMPLETED

Prepared for the Offices of: 750 Greenfield Parkway, Garner, NC 27529	Burlington-Graham Signal System Fiber-Optic Splicing Details		SEAL NORTH CAROLINA PROFESSIONAL ENGINEER SEAL 040877 BRADFORD J. SLOCUM 15/2018 DATE
	Division 7 Alamance County PLAN DATE: June 2018 PREPARED BY: BJ SLOCUM	Burlington & Graham REVIEWED BY: HA BADGETT REVIEWED BY: DL JONES	
SCALE N/A			CADD File name: FS 4.113.dgn

SPLICE NO.

S19-1

CHURCH ST & WESTBROOK AVE
SEE: CRP-6.007

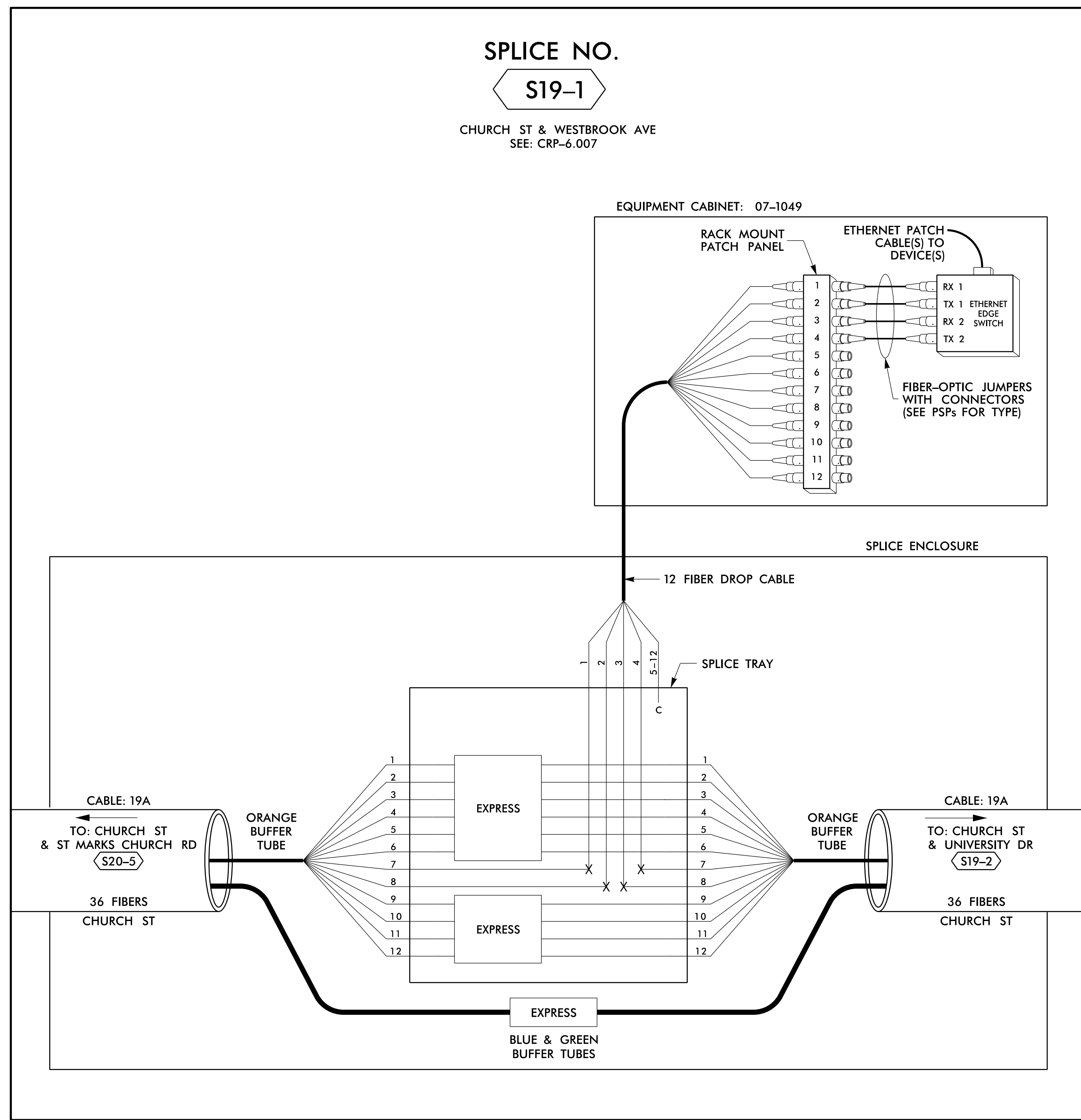

14 JUN 2018 12:31
 D:\Technical\Projects\U-6015 B-C Sig. Sys\Task 11_Coms\F5 4.114.dgn
 S:\DCS\653 AT_LUS355433

LEGEND

COLOR CODE TIA/EIA 598-B		X = FUSION SPlice INDIVIDUAL FIBER C = CAP AND SEAL
(1) BLUE	(7) RED	EXPRESS
(2) ORANGE	(8) BLACK	EXPRESS ENTIRE BUFFER TUBE / FIBERS THROUGH WITHOUT CUTTING
(3) GREEN	(9) YELLOW	BUFFER SPlice
(4) BROWN	(10) VIOLET	SPLICE ALL FIBERS IN BUFFER TUBE COLOR TO COLOR
(5) SLATE	(11) ROSE	EXISTING
(6) WHITE	(12) AQUA	EXISTING BUFFER TUBE / FIBERS. DO NOT MODIFY EXISTING SPLICES OR EXPRESSED FIBERS.

NOTES

- UNUSED FIBERS LEFT COILED AND STORED IN SPLICE TRAY
- UNUSED BUFFER TUBES LEFT COILED AND STORED IN SPLICE ENCLOSURE
- EDGE SWITCH CONFIGURATIONS ARE GENERIC. CONTRACTOR IS RESPONSIBLE FOR DETERMINING/ENSURING THE PROPER TERMINATIONS.

ATKINS 1616 EAST MILLBROOK ROAD, SUITE 160
 RALEIGH, NORTH CAROLINA 27609
 (919) 876-6888 NCBEE# F-0326

DOCUMENT NOT CONSIDERED FINAL UNLESS ALL SIGNATURES COMPLETED

Prepared for the Offices of: 750 Greenfield Parkway, Garner, NC 27529	Burlington-Graham Signal System Fiber-Optic Splicing Details		SEAL NORTH CAROLINA PROFESSIONAL ENGINEER SEAL 040877 BRADFORD J. SLOCUM 15/2018 DATE
	Division 7 Alamance County PLAN DATE: June 2018 PREPARED BY: BJ SLOCUM	Burlington & Graham REVIEWED BY: HA BADGETT REVIEWED BY: DL JONES	
REVISIONS: _____ INIT. _____ DATE _____			

CAAD File name: FS 4.114.dgn

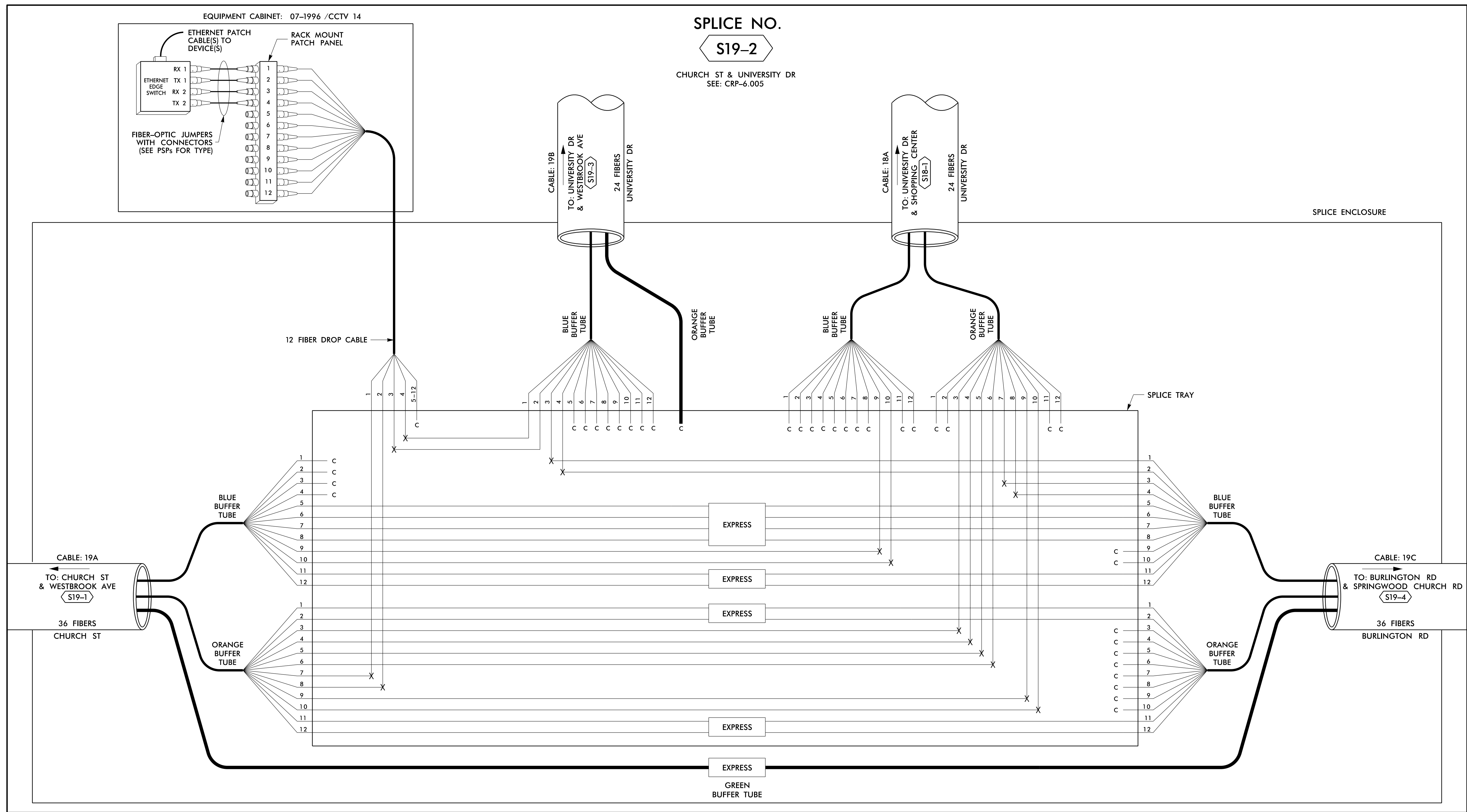

SPLICE NO.
S19-2

CHURCH ST & UNIVERSITY DR
 SEE: CRP-6.005

SPLICE ENCLOSURE

SPLICE TRAY

LEGEND

COLOR CODE TIA/EIA 598-B		X = FUSION SPLICE INDIVIDUAL FIBER C = CAP AND SEAL
(1) BLUE	(7) RED	EXPRESS
(2) ORANGE	(8) BLACK	EXPRESS ENTIRE BUFFER TUBE / FIBERS THROUGH WITHOUT CUTTING
(3) GREEN	(9) YELLOW	BUFFER SPLICE
(4) BROWN	(10) VIOLET	SPLICE ALL FIBERS IN BUFFER TUBE COLOR TO COLOR
(5) SLATE	(11) ROSE	EXISTING
(6) WHITE	(12) AQUA	EXISTING BUFFER TUBE / FIBERS DO NOT MODIFY EXISTING SPLICES OR EXPRESSED FIBERS.

NOTES

- UNUSED FIBERS LEFT COILED AND STORED IN SPLICE TRAY
- UNUSED BUFFER TUBES LEFT COILED AND STORED IN SPLICE ENCLOSURE
- EDGE SWITCH CONFIGURATIONS ARE GENERIC. CONTRACTOR IS RESPONSIBLE FOR DETERMINING/ENSURING THE PROPER TERMINATIONS.

ATKINS 1616 EAST MILLBROOK ROAD, SUITE 160
 RALEIGH, NORTH CAROLINA 27609
 (919) 876-6888 NCBEEES #F-0326

DOCUMENT NOT CONSIDERED FINAL
 UNLESS ALL SIGNATURES COMPLETED

Prepared for the Offices of: 750 Greenfield Parkway, Garner, NC 27529	Burlington-Graham Signal System Fiber-Optic Splicing Details		SEAL NORTH CAROLINA PROFESSIONAL SEAL 040877 ENGINEER Bradford J. Slocum 15/2018
	Division 7 PLAN DATE: June 2018 PREPARED BY: BJ SLOCUM	Alamance County REVIEWED BY: HA BADGETT DL JONES	
SCALE N/A	REVISIONS INIT. DATE		DATE

14-JUN-2018 12:31
 D:\Projects\Burlington-Graham Signal System\Task 11_Comms\F 4.115.dgn
 S:\035353 AT_LUS35353

SPLICE NO.

S19-3

UNIVERSITY DR &
WESTBROOK AVE
SEE: CRP-6.046

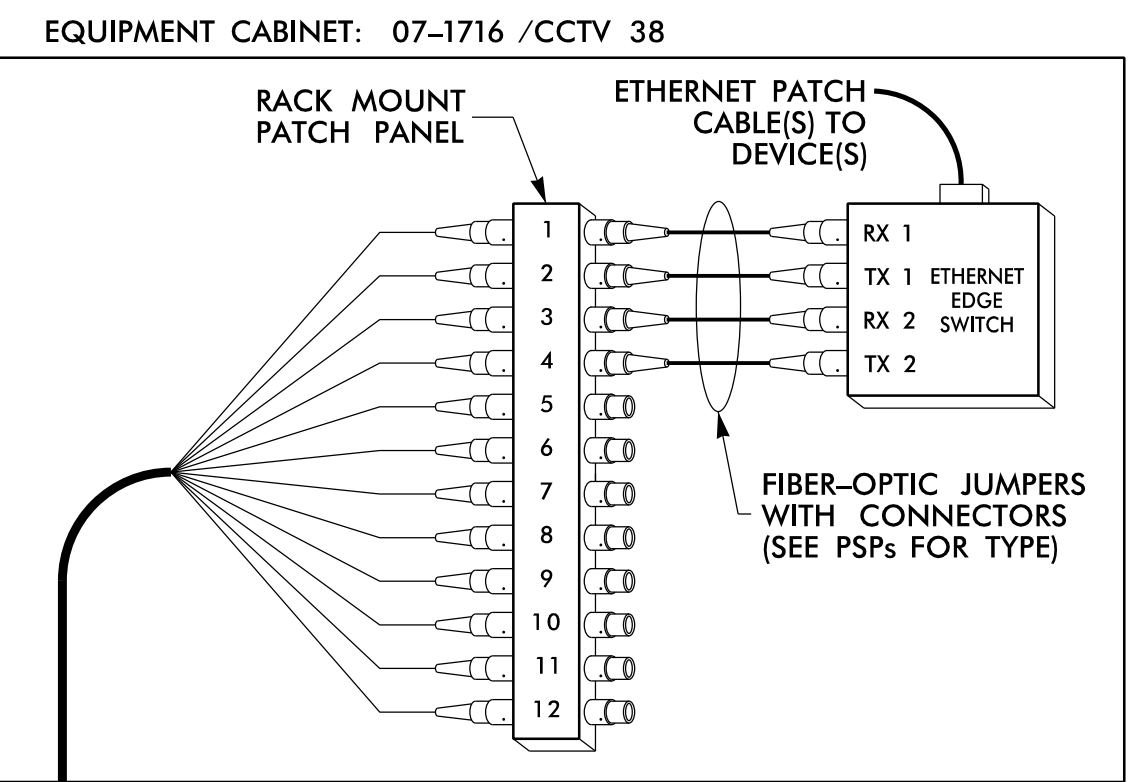

SPLICE ENCLOSURE

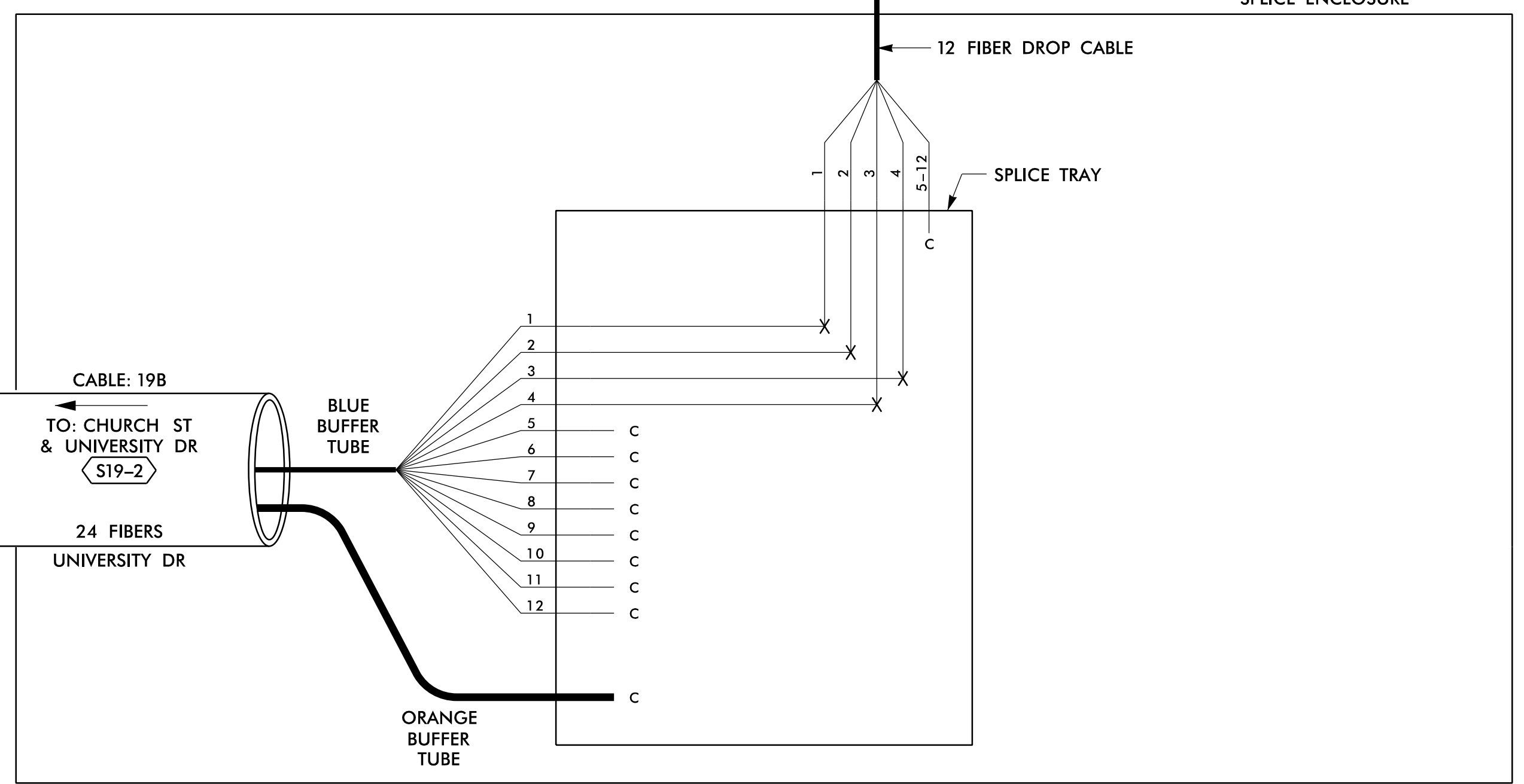

SPLICE NO.

S19-4

BURLINGTON RD & SPRINGWOOD CHURCH RD
SEE: CRP-6.001

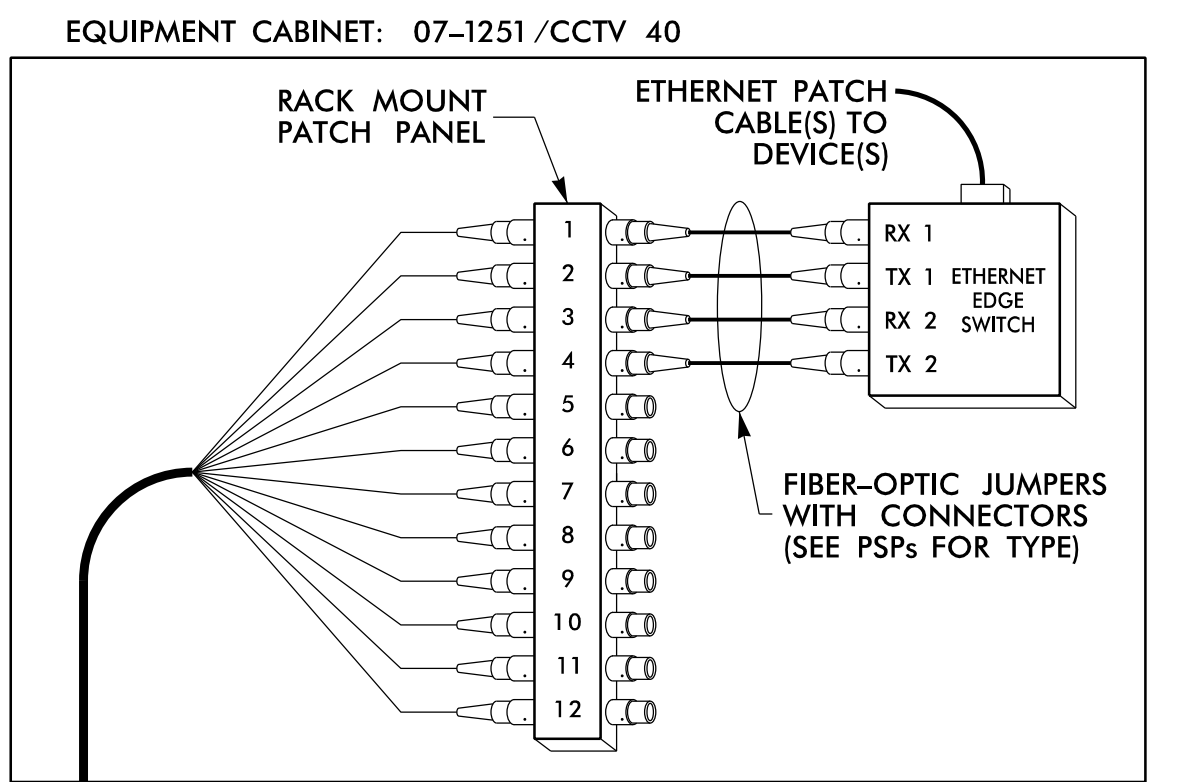

SPLICE ENCLOSURE

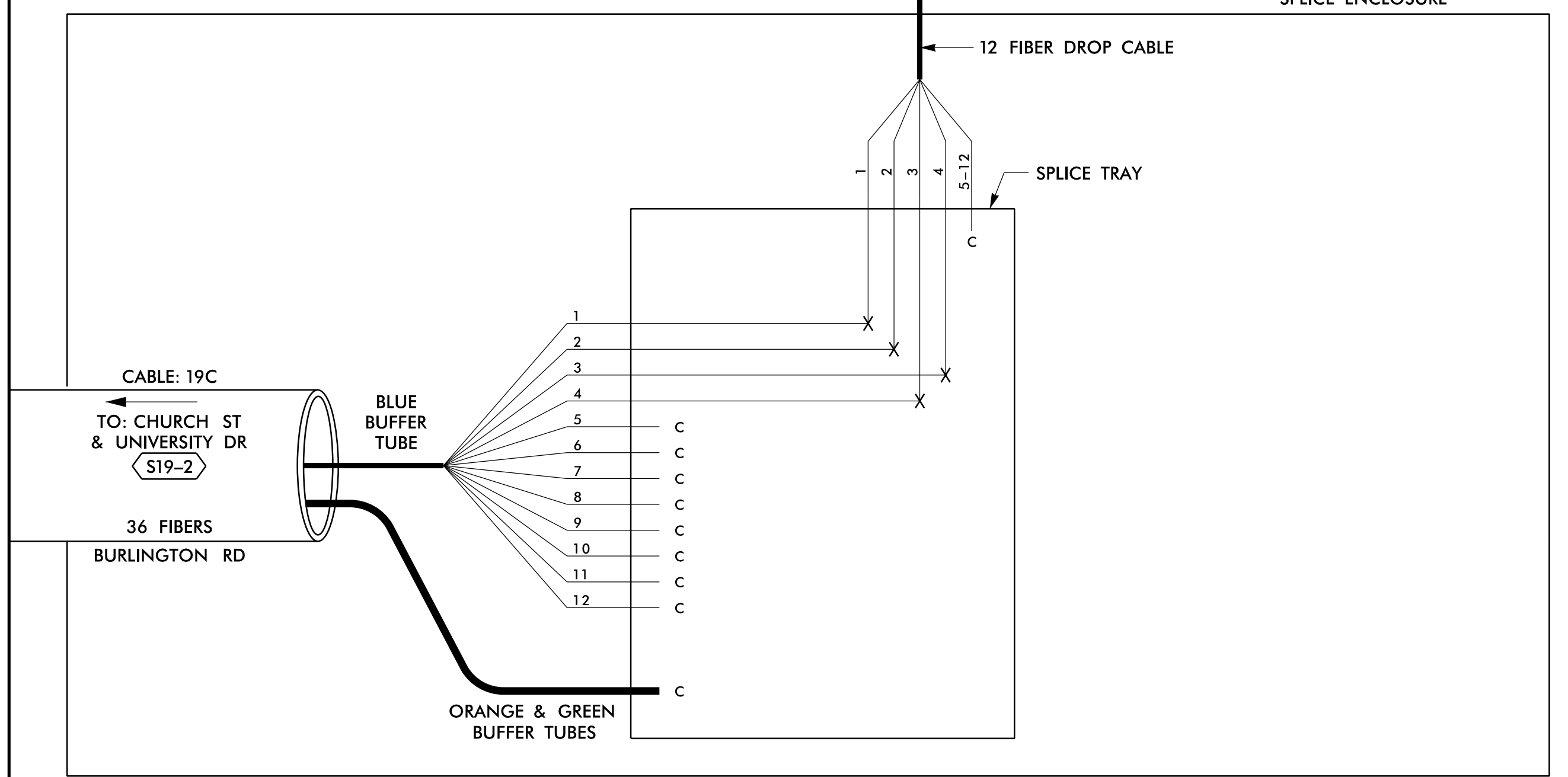

14 JUN 2018 12:31
 D:\projects\proj\11\comms\11_Coms\Fs 4.116.dgn
 S:\035633 AT_LUS355433

LEGEND

COLOR CODE TIA/EIA 598-B		X = FUSION SPlice INDIVIDUAL FIBER C = CAP AND SEAL	
(1) BLUE	(7) RED	EXPRESS	EXPRESS ENTIRE BUFFER TUBE / FIBERS THROUGH WITHOUT CUTTING
(2) ORANGE	(8) BLACK	BUFFER SPlice	SPlice ALL FIBERS IN BUFFER TUBE COLOR TO COLOR
(3) GREEN	(9) YELLOW	EXISTING	EXISTING BUFFER TUBE / FIBERS DO NOT MODIFY EXISTING SPlices OR EXPRESSED FIBERS.
(4) BROWN	(10) VIOLET		
(5) SLATE	(11) ROSE		
(6) WHITE	(12) AQUA		

NOTES

1. UNUSED FIBERS LEFT COILED AND STORED IN SPLICE TRAY
2. UNUSED BUFFER TUBES LEFT COILED AND STORED IN SPLICE ENCLOSURE
3. EDGE SWITCH CONFIGURATIONS ARE GENERIC. CONTRACTOR IS RESPONSIBLE FOR DETERMINING/ENSURING THE PROPER TERMINATIONS.

ATKINS 1616 EAST MILLBROOK ROAD, SUITE 160
RALEIGH, NORTH CAROLINA 27609
(919) 876-6888 NCBEEES #F-0326

DOCUMENT NOT CONSIDERED FINAL UNLESS ALL SIGNATURES COMPLETED

Prepared for the Offices of:  750 Greenfield Parkway, Garner, NC 27529	Burlington-Graham Signal System Fiber-Optic Splicing Details		SEAL NORTH CAROLINA PROFESSIONAL SEAL 040877 ENGINEER Bradford J. Slocum 15/2018 DATE
	Division 7 Alamance County Burlington & Graham	PLAN DATE: June 2018 PREPARED BY: BJ SLOCUM SCALE: N/A	
REVISIONS		INIT. DATE	DATE

SPLICE NO.

S20-1

CHURCH ST & INTERNATIONAL RD
SEE: CRP-6.013

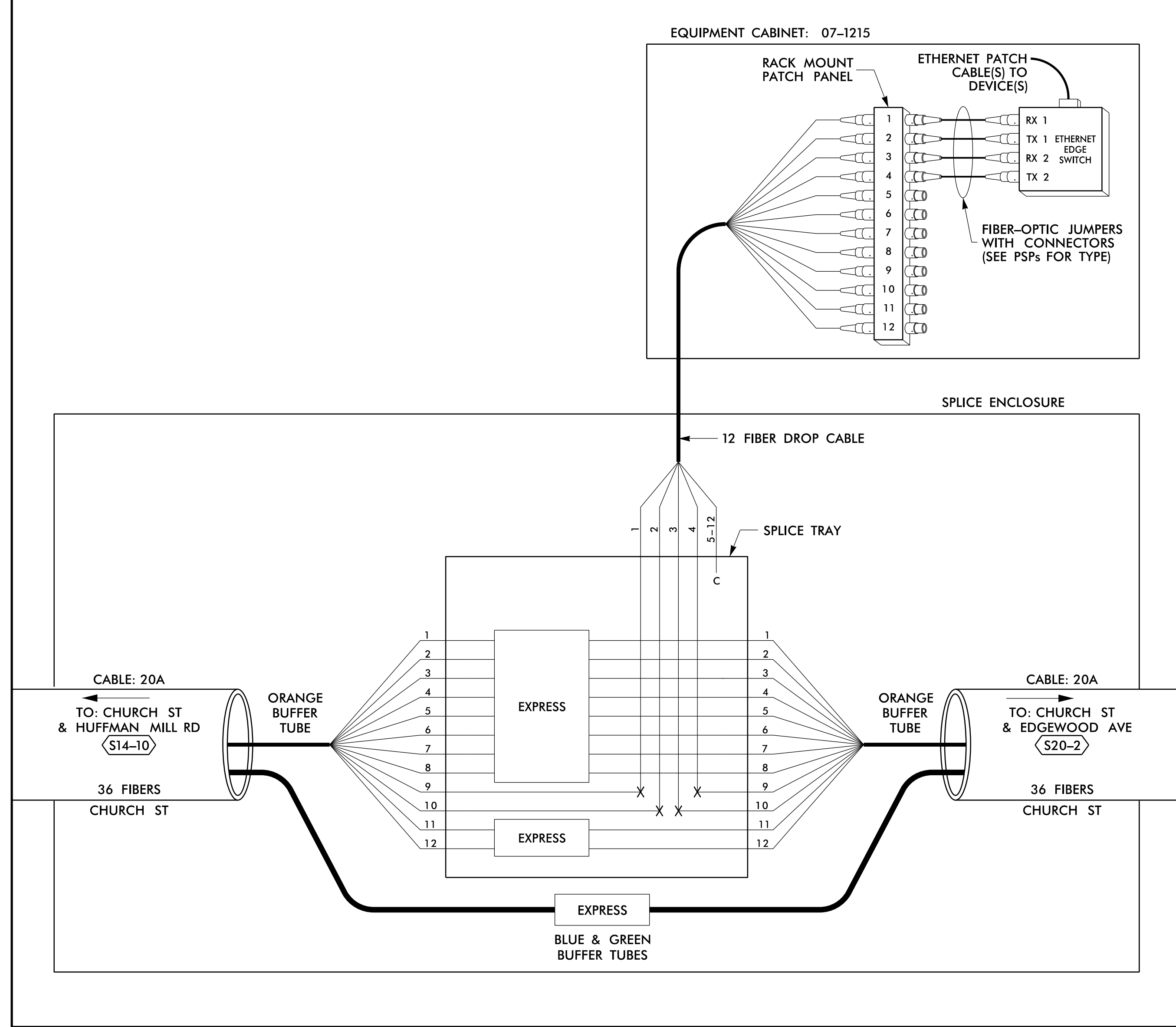

SPLICE NO.

S20-2

CHURCH ST & EDGEWOOD AVE
SEE: CRP-6.012

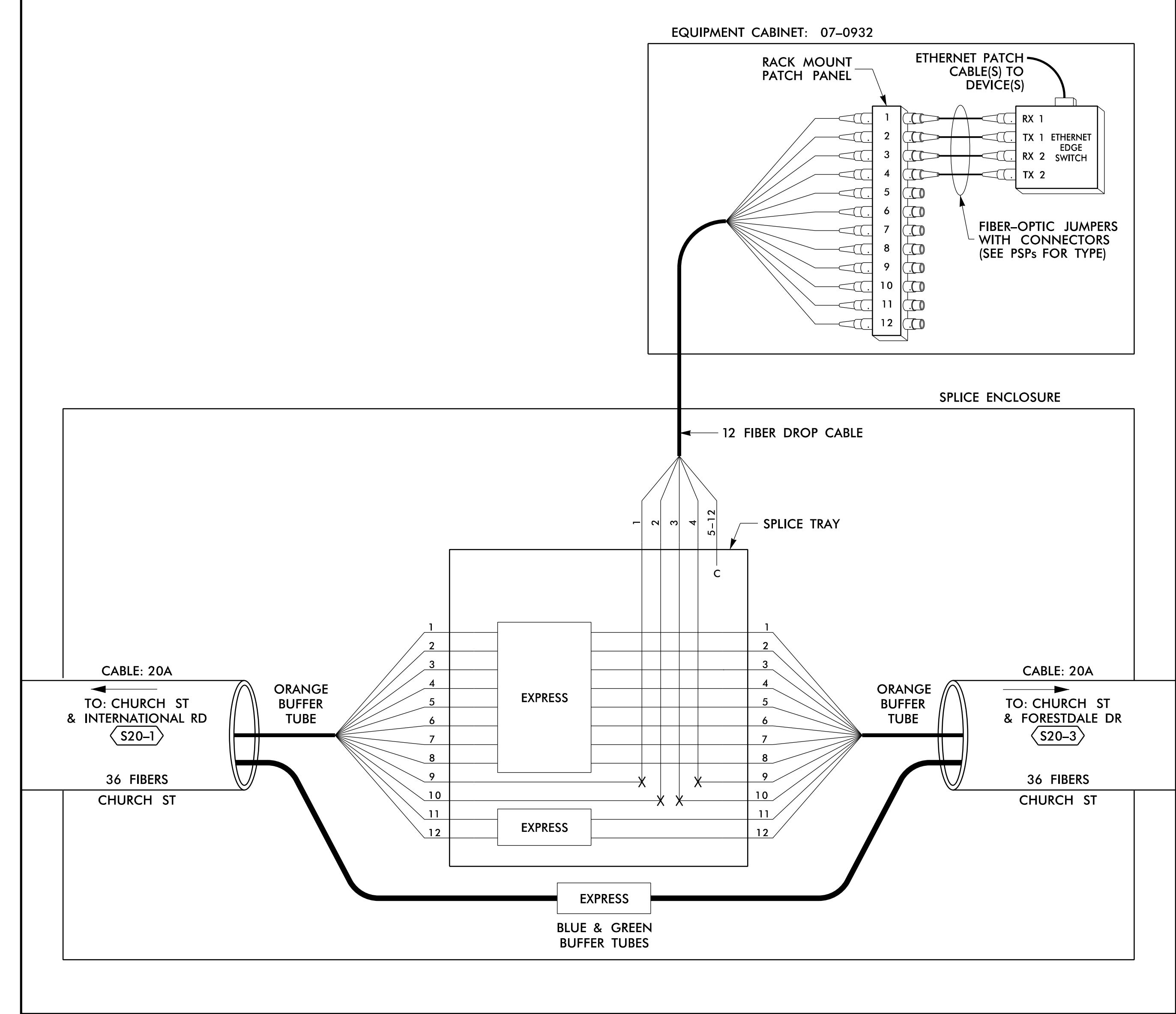

14 JUN 2018 12:31
 D:\projects\proj\11\comms\11_Coms\Fs 4.117.dgn
 0:*\techno\proj\11\comms\11_Coms\Fs 4.117.dgn
 S:\033653 AT LUS355433

LEGEND

COLOR CODE TIA/EIA 598-B		X = FUSION SPlice INDIVIDUAL FIBER C = CAP AND SEAL
(1) BLUE	(7) RED	EXPRESS
(2) ORANGE	(8) BLACK	EXPRESS ENTIRE BUFFER TUBE / FIBERS THROUGH WITHOUT CUTTING
(3) GREEN	(9) YELLOW	BUFFER SPlice
(4) BROWN	(10) VIOLET	SPlice ALL FIBERS IN BUFFER TUBE COLOR TO COLOR
(5) SLATE	(11) ROSE	EXISTING
(6) WHITE	(12) AQUA	EXISTING BUFFER TUBE / FIBERS DO NOT MODIFY EXISTING SPlices OR EXPRESSED FIBERS.

NOTES

- UNUSED FIBERS LEFT COILED AND STORED IN SPLICE TRAY
- UNUSED BUFFER TUBES LEFT COILED AND STORED IN SPLICE ENCLOSURE
- EDGE SWITCH CONFIGURATIONS ARE GENERIC. CONTRACTOR IS RESPONSIBLE FOR DETERMINING/ENSURING THE PROPER TERMINATIONS.

ATKINS 1616 EAST MILLBROOK ROAD, SUITE 160
RALEIGH, NORTH CAROLINA 27609
(919) 876-6888 NCBEE# F-0326

DOCUMENT NOT CONSIDERED FINAL UNLESS ALL SIGNATURES COMPLETED

Prepared for the Offices of: 750 Greenfield Parkway, Garner, NC 27529 SCALE: N/A	Burlington-Graham Signal System Fiber-Optic Splicing Details		SEAL NORTH CAROLINA PROFESSIONAL ENGINEER SEAL 040877 BRADFORD J. SLOCUM 15/2018 DATE
	Division 7 Alamance County PLAN DATE: June 2018 PREPARED BY: BJ SLOCUM	Burlington & Graham REVIEWED BY: HA BADGETT REVIEWED BY: DL JONES	
	REVISIONS	INIT. DATE	
	CAD File name: FS 4.117.dgn		

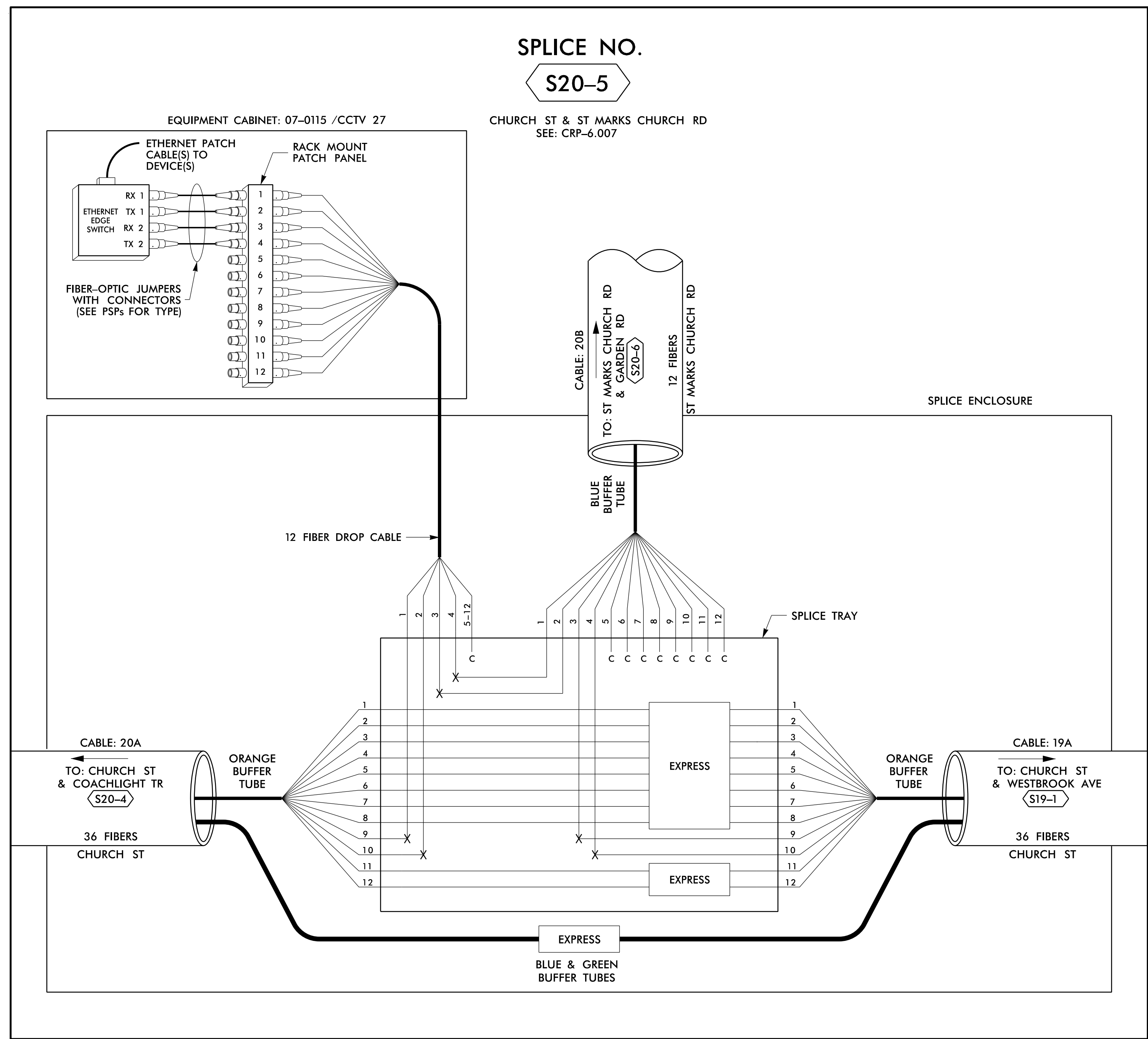

14 JUN 2018 12:31
 D:\Technical\Projects\11-Comms\Task 11-Comms\F 4.119.dgn
 S:\DCS\653 AT LUS355433

COLOR CODE		LEGEND	
(1) BLUE	(7) RED	EXPRESS	EXPRESS ENTIRE BUFFER TUBE / FIBERS THROUGH WITHOUT CUTTING
(2) ORANGE	(8) BLACK	BUFFER SPlice	SPLICE ALL FIBERS IN BUFFER TUBE COLOR TO COLOR
(3) GREEN	(9) YELLOW	EXISTING	EXISTING BUFFER TUBE / FIBERS DO NOT MODIFY EXISTING SPLICES OR EXPRESSED FIBERS.
(4) BROWN	(10) VIOLET		
(5) SLATE	(11) ROSE		
(6) WHITE	(12) AQUA		

- NOTES**
- UNUSED FIBERS LEFT COILED AND STORED IN SPLICE TRAY
 - UNUSED BUFFER TUBES LEFT COILED AND STORED IN SPLICE ENCLOSURE
 - EDGE SWITCH CONFIGURATIONS ARE GENERIC. CONTRACTOR IS RESPONSIBLE FOR DETERMINING/ENSURING THE PROPER TERMINATIONS.

ATKINS

1616 EAST MILLBROOK ROAD, SUITE 160
RALEIGH, NORTH CAROLINA 27609
(919) 876-6888 NCBEE# F-0326

750 Greenfield Parkway, Garner, NC 27529

SCALE: N/A

Burlington-Graham Signal System
Fiber-Optic Splicing Details

Division 7 Alamance County Burlington & Graham

PLAN DATE: June 2018 REVIEWED BY: HA BADGETT

PREPARED BY: BJ SLOCUM REVIEWED BY: DL JONES

REVISIONS	INIT.	DATE

DOCUMENT NOT CONSIDERED FINAL UNLESS ALL SIGNATURES COMPLETED

SEAL
NORTH CAROLINA PROFESSIONAL ENGINEER
BRADFORD J. SLOCUM
040877
15/2018

CADD File name: FS 4.119.dgn

SPLICE NO.

S20-6

ST MARKS CHURCH RD &
GARDEN RD
SEE: CRP-6.069

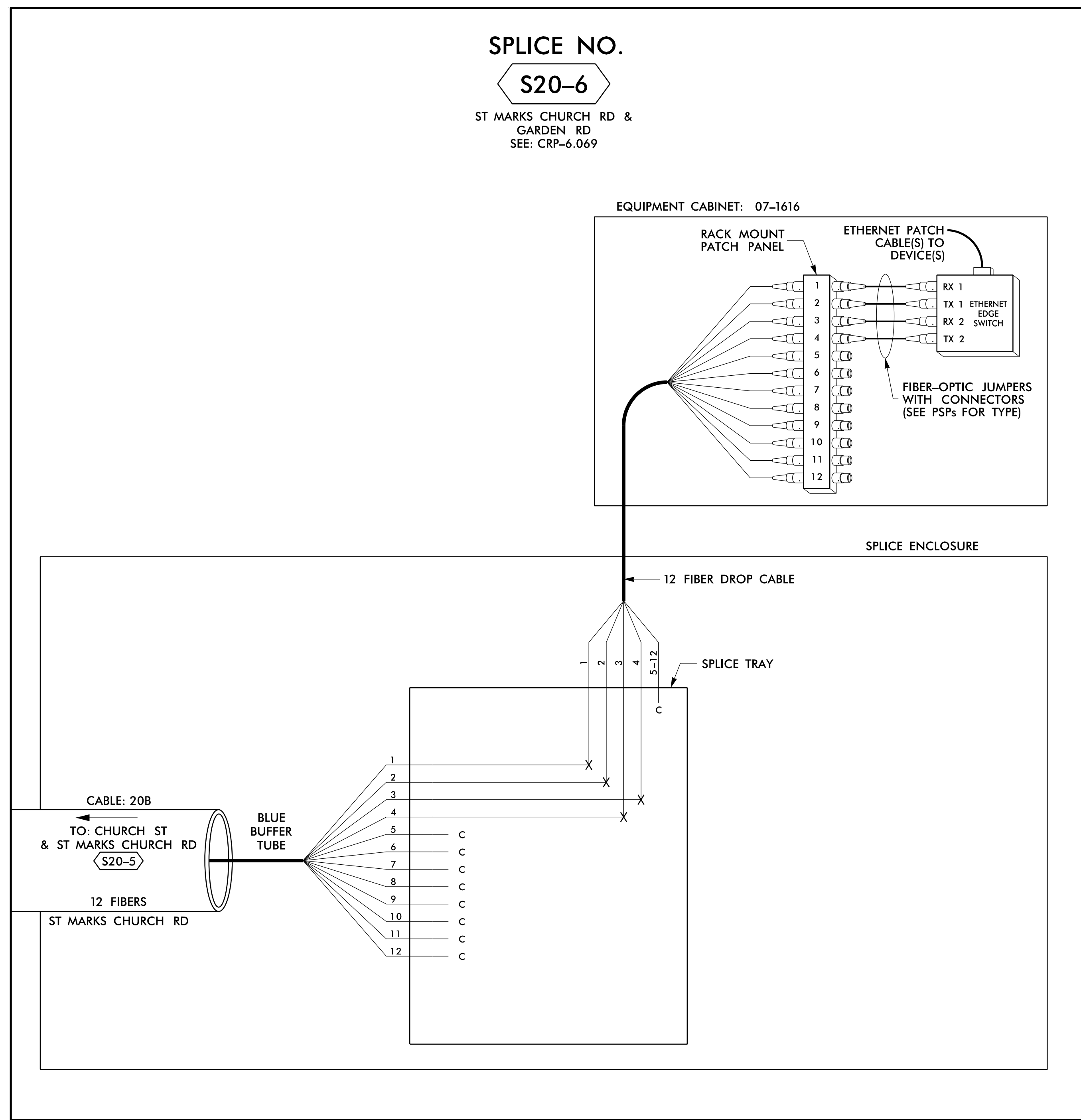

14 JUN 2018 12:31
 D:\Technical\Projects\U-6015 B-C Sig Sys\Task 11_Comms\FS 4.120.dgn
 S:\DCS\653 AT_LUS355433

LEGEND

COLOR CODE TIA/EIA 598-B		X = FUSION SPLICE INDIVIDUAL FIBER
(1) BLUE	(7) RED	C = CAP AND SEAL
(2) ORANGE	(8) BLACK	
(3) GREEN	(9) YELLOW	
(4) BROWN	(10) VIOLET	EXPRESS EXPRESS ENTIRE BUFFER TUBE / FIBERS THROUGH WITHOUT CUTTING
(5) SLATE	(11) ROSE	BUFFER SPLICE SPLICE ALL FIBERS IN BUFFER TUBE COLOR TO COLOR
(6) WHITE	(12) AQUA	EXISTING EXISTING BUFFER TUBE / FIBERS DO NOT MODIFY EXISTING SPLICES OR EXPRESSED FIBERS.

NOTES

- UNUSED FIBERS LEFT COILED AND STORED IN SPLICE TRAY
- UNUSED BUFFER TUBES LEFT COILED AND STORED IN SPLICE ENCLOSURE
- EDGE SWITCH CONFIGURATIONS ARE GENERIC. CONTRACTOR IS RESPONSIBLE FOR DETERMINING/ENSURING THE PROPER TERMINATIONS.

ATKINS 1616 EAST MILLBROOK ROAD, SUITE 160
RALEIGH, NORTH CAROLINA 27609
(919) 876-6888 NCBES #F-0326

DOCUMENT NOT CONSIDERED FINAL UNLESS ALL SIGNATURES COMPLETED

	Prepared for the Offices of: Division 7 Alamance County Burlington & Graham		
	Fiber-Optic Splicing Details		
750 Greenfield Parkway, Garner, NC 27529 SCALE: N/A	PLAN DATE: June 2018 PREPARED BY: BJ SLOCUM	REVIEWED BY: HA BADGETT REVIEWED BY: DL JONES	REVISIONS INIT. DATE

DocuSign Envelope ID: 0FE85FC2-54CD-4048-94C3-548ADCEC8A66
 CAD0 File name: FS 4.120.dgn