

SPLICE NO. S1-4

I-40 EB /I-85 NB & HARDEN ST SEE: CRP-6.106

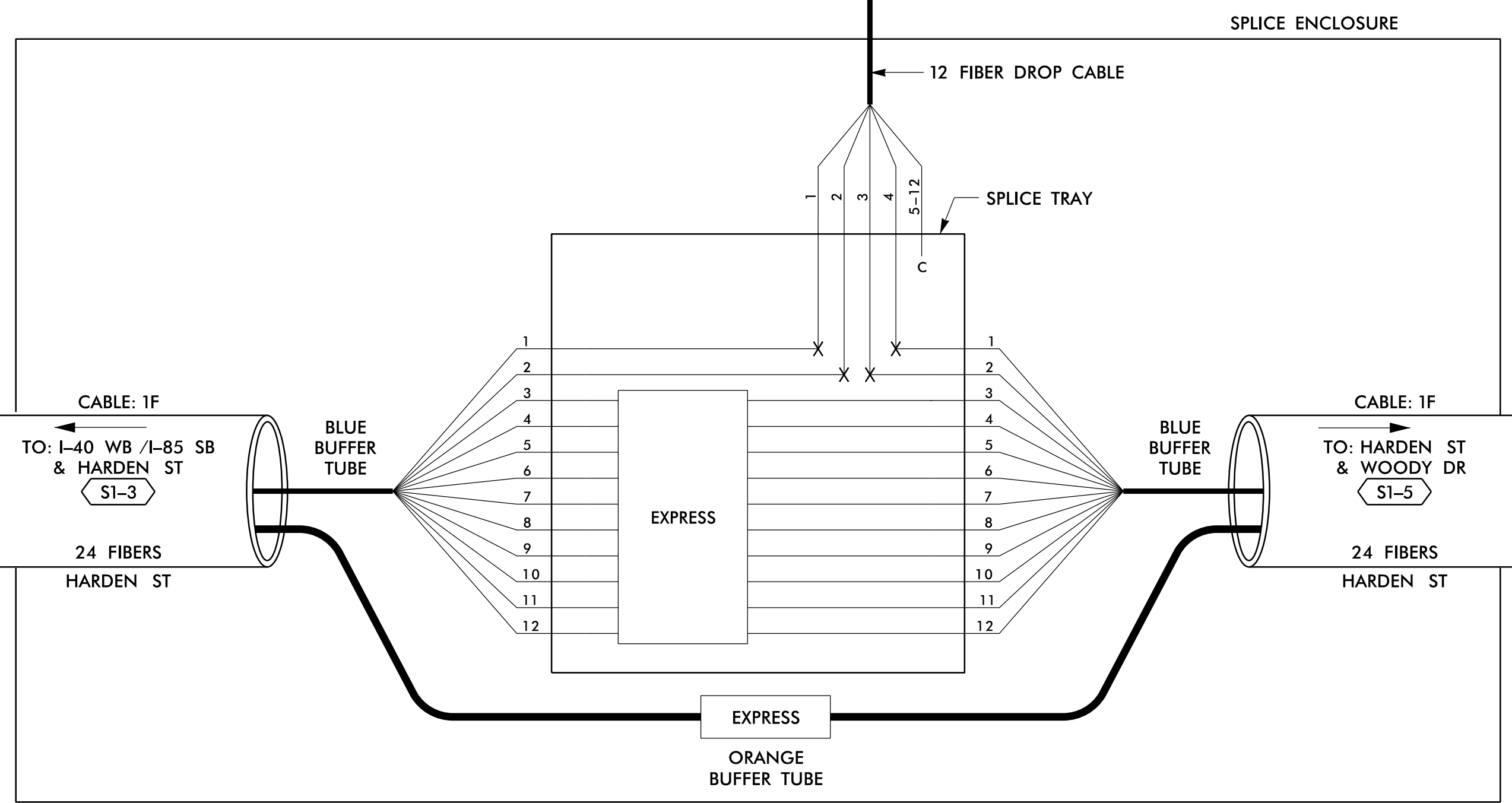
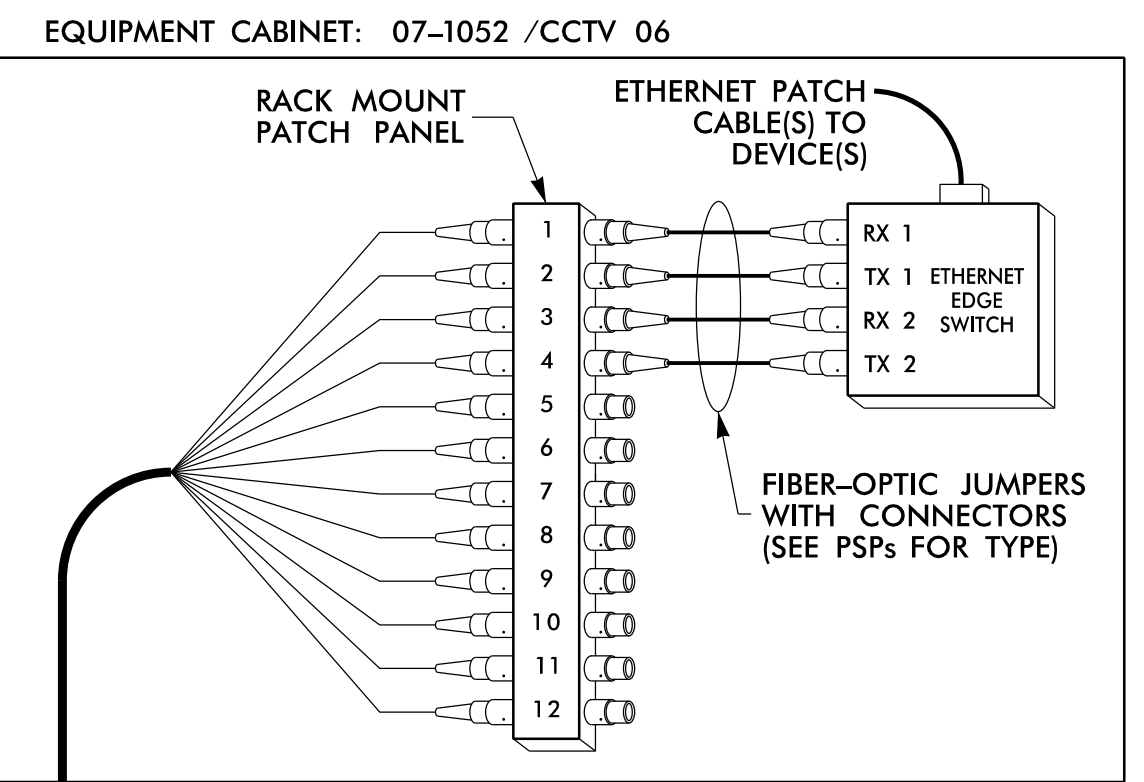

SPLICE NO. S1-5

HARDEN ST & WOODY DR SEE: CRP-6.107

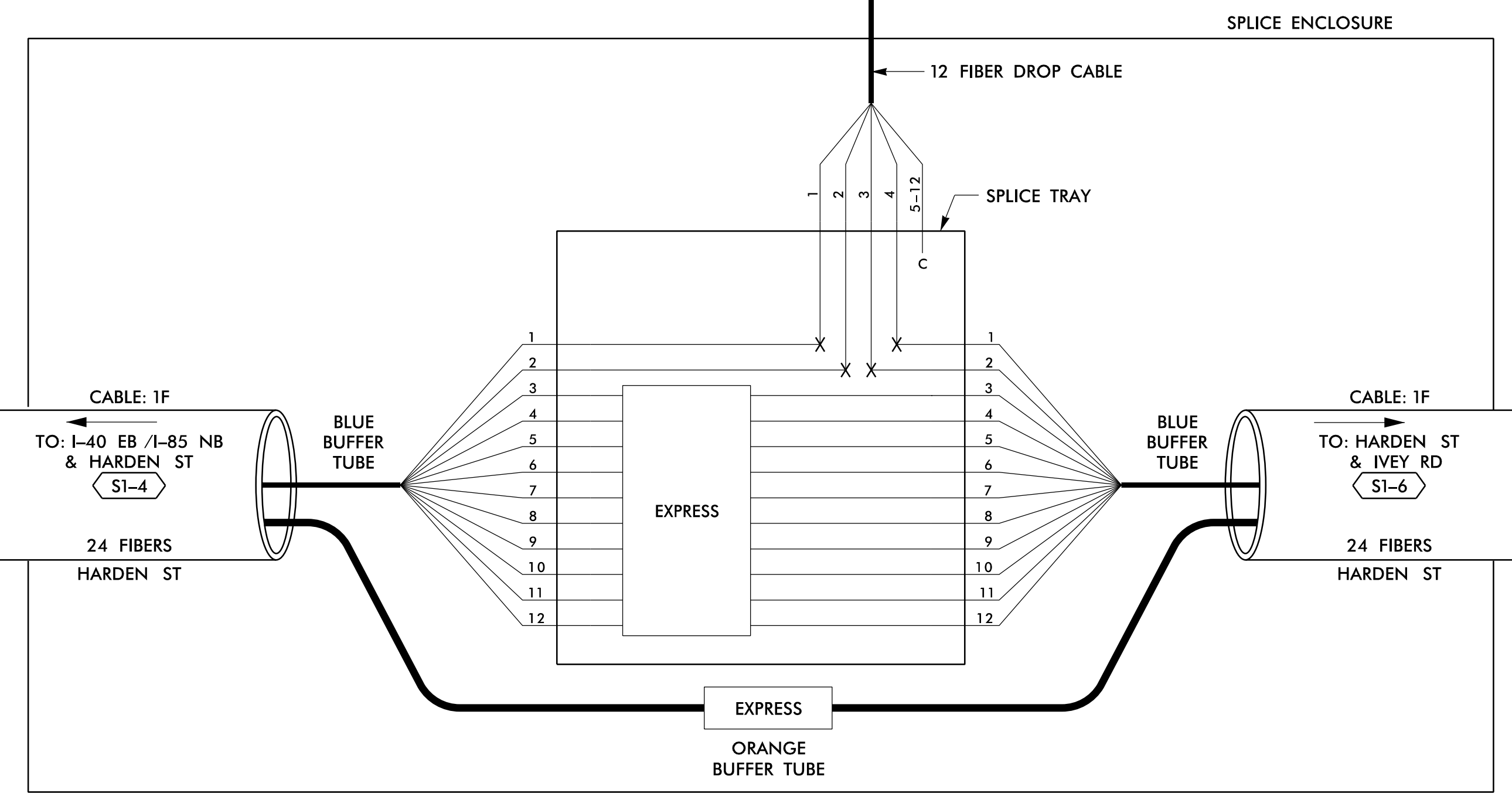
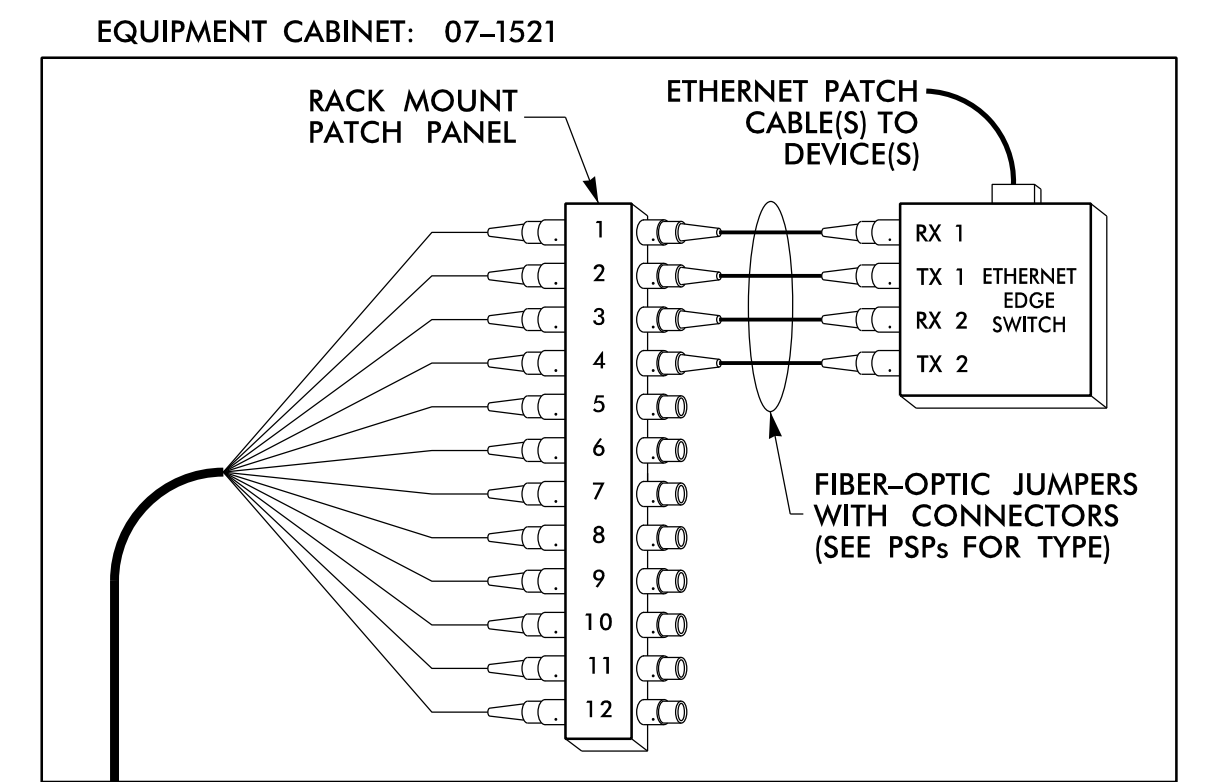

14 JUN 2018 12:05 D:\projects\atkins\proj\100056469 U-6015 B-C Sig Sys\Task 11_Corrs\F S 4.005.dgn

LEGEND

COLOR CODE TIA/EIA 598-B	X = FUSION SPlice INDIVIDUAL FIBER	EXPRESS	EXPRESS ENTIRE BUFFER TUBE /FIBERS THROUGH WITHOUT CUTTING
(1) BLUE (7) RED	C = CAP AND SEAL	BUFFER SPlice	SPlice ALL FIBERS IN BUFFER TUBE COLOR TO COLOR
(2) ORANGE (8) BLACK		EXISTING	EXISTING BUFFER TUBE /FIBERS DO NOT MODIFY EXISTING SPlices OR EXPRESSED FIBERS.
(3) GREEN (9) YELLOW			
(4) BROWN (10) VIOLET			
(5) SLATE (11) ROSE			
(6) WHITE (12) AQUA			

NOTES

- UNUSED FIBERS LEFT COILED AND STORED IN SPLICE TRAY
- UNUSED BUFFER TUBES LEFT COILED AND STORED IN SPLICE ENCLOSURE
- EDGE SWITCH CONFIGURATIONS ARE GENERIC. CONTRACTOR IS RESPONSIBLE FOR DETERMINING/ENSURING THE PROPER TERMINATIONS.

ATKINS 1616 EAST MILLBROOK ROAD, SUITE 160 RALEIGH, NORTH CAROLINA 27609 (919) 876-6888 NCBEEES #F-0326

DOCUMENT NOT CONSIDERED FINAL UNLESS ALL SIGNATURES COMPLETED

<p>750 Greenfield Parkway, Garner, NC 27529</p>	<p>Burlington-Graham Signal System Fiber-Optic Splicing Details</p>														
	<p>Division 7 Alamance County Burlington & Graham</p> <p>PLAN DATE: June 2018 REVIEWED BY: HA BADGETT</p> <p>PREPARED BY: BJ SLOCUM REVIEWED BY: DL JONES</p>														
SCALE: N/A	<table border="1"> <thead> <tr> <th>REVISIONS</th> <th>INIT.</th> <th>DATE</th> </tr> </thead> <tbody> <tr> <td> </td> <td> </td> <td> </td> </tr> <tr> <td> </td> <td> </td> <td> </td> </tr> <tr> <td> </td> <td> </td> <td> </td> </tr> </tbody> </table>		REVISIONS	INIT.	DATE										<p>DATE: 15/2018</p> <p>DATE: 15/2018</p> <p>DATE: 15/2018</p>
REVISIONS	INIT.	DATE													

SPLICE NO.

S1-6

HARDEN ST & IVEY RD
SEE: CRP-6.108

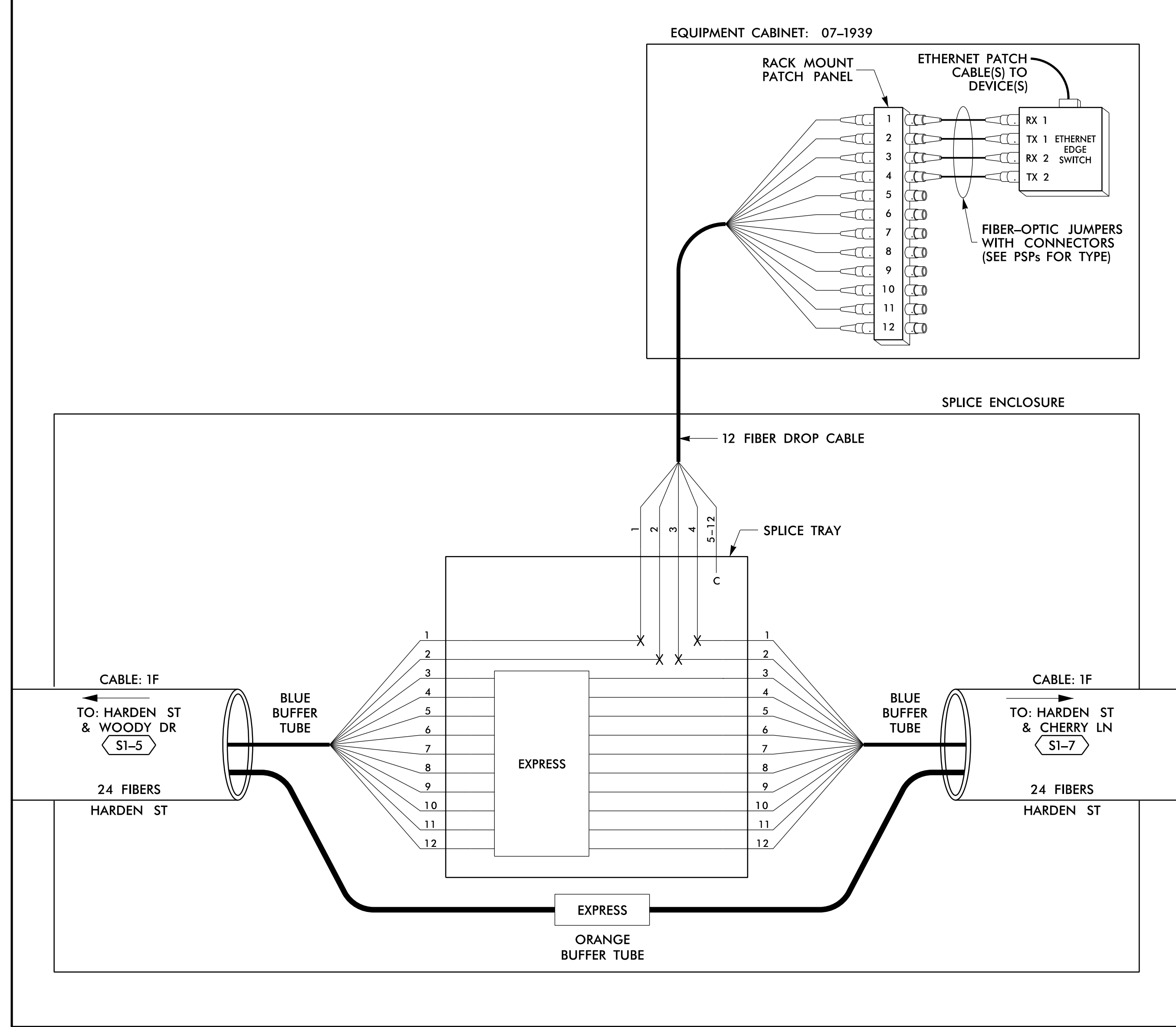

SPLICE NO.

S1-7

HARDEN ST & CHERRY LN
SEE: CRP-6.112

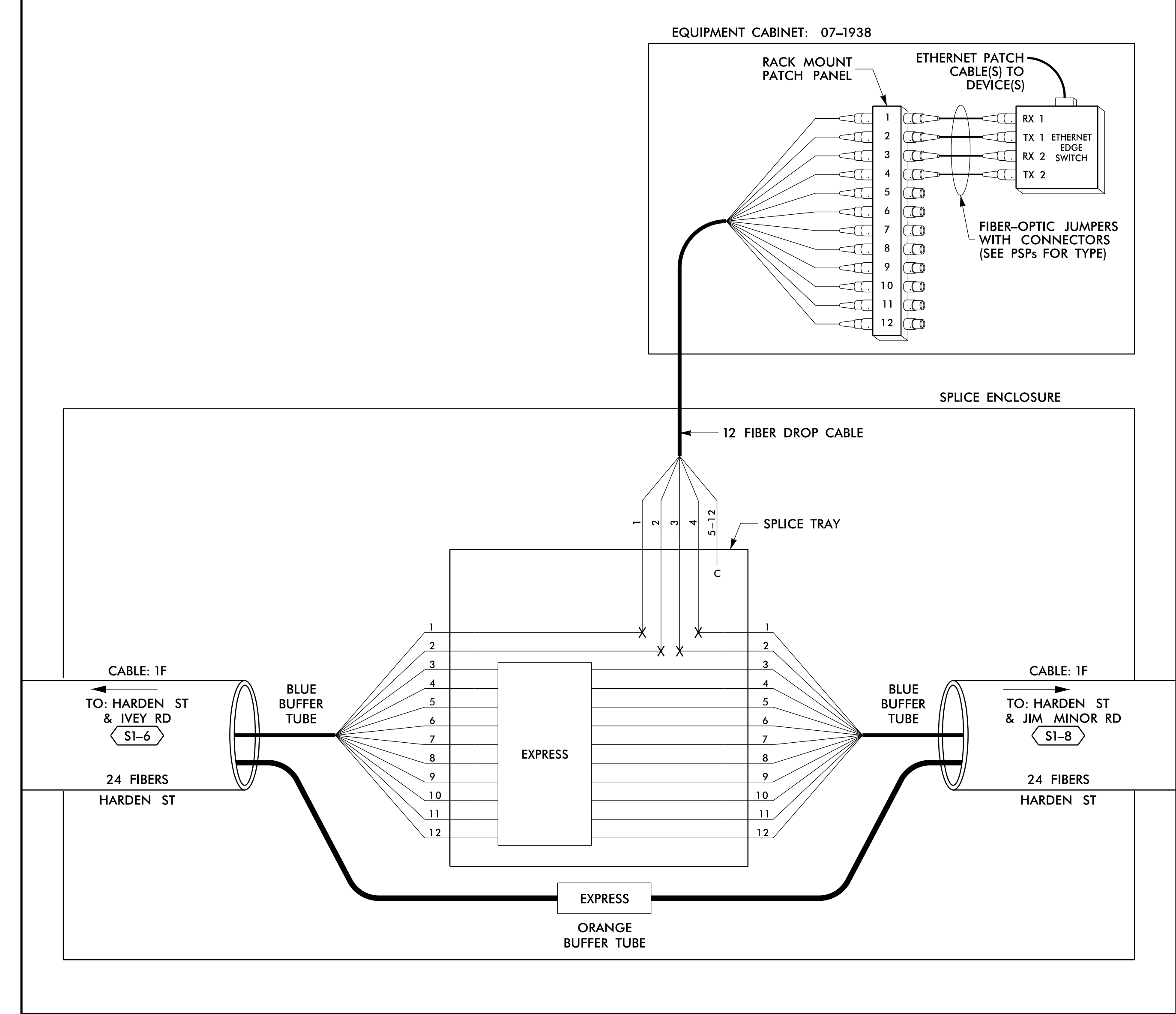

14 JUN 2018 12:05
 D:\projects\proj\cra\tr\off\c\curr\100056469 U-6015 B-C Sig_Sys\Task 11_Corrs\F S 4.006.dgn
 S:\DCS\653 AT_LLUS355433

LEGEND

COLOR CODE TIA/EIA 598-B		X = FUSION SPLICE INDIVIDUAL FIBER	
(1) BLUE	(7) RED	EXPRESS	EXPRESS ENTIRE BUFFER TUBE / FIBERS THROUGH WITHOUT CUTTING
(2) ORANGE	(8) BLACK	BUFFER SPLICE	SPLICE ALL FIBERS IN BUFFER TUBE COLOR TO COLOR
(3) GREEN	(9) YELLOW	EXISTING	EXISTING BUFFER TUBE / FIBERS DO NOT MODIFY EXISTING SPLICES OR EXPRESSED FIBERS.
(4) BROWN	(10) VIOLET		
(5) SLATE	(11) ROSE		
(6) WHITE	(12) AQUA		

NOTES

- UNUSED FIBERS LEFT COILED AND STORED IN SPLICE TRAY
- UNUSED BUFFER TUBES LEFT COILED AND STORED IN SPLICE ENCLOSURE
- EDGE SWITCH CONFIGURATIONS ARE GENERIC. CONTRACTOR IS RESPONSIBLE FOR DETERMINING/ENSURING THE PROPER TERMINATIONS.

ATKINS 1616 EAST MILLBROOK ROAD, SUITE 160
RALEIGH, NORTH CAROLINA 27609
(919) 876-6888 NCBEEES #F-0326

DOCUMENT NOT CONSIDERED FINAL UNLESS ALL SIGNATURES COMPLETED

	Prepared for the Offices of: Burlington-Graham Signal System Fiber-Optic Splicing Details			
	Division 7 Alamance County Burlington & Graham			
	PLAN DATE: June 2018	REVIEWED BY: HA BADGETT		
	PREPARED BY: BJ SLOCUM	REVIEWED BY: DL JONES		
SCALE: N/A	REVISIONS	INIT.	DATE	

DATE: 6/15/2018
 CADD File name: FS 4.006.dgn

SPLICE NO.

S1-8

HARDEN ST & JIM MINOR RD
SEE: CRP-6.113

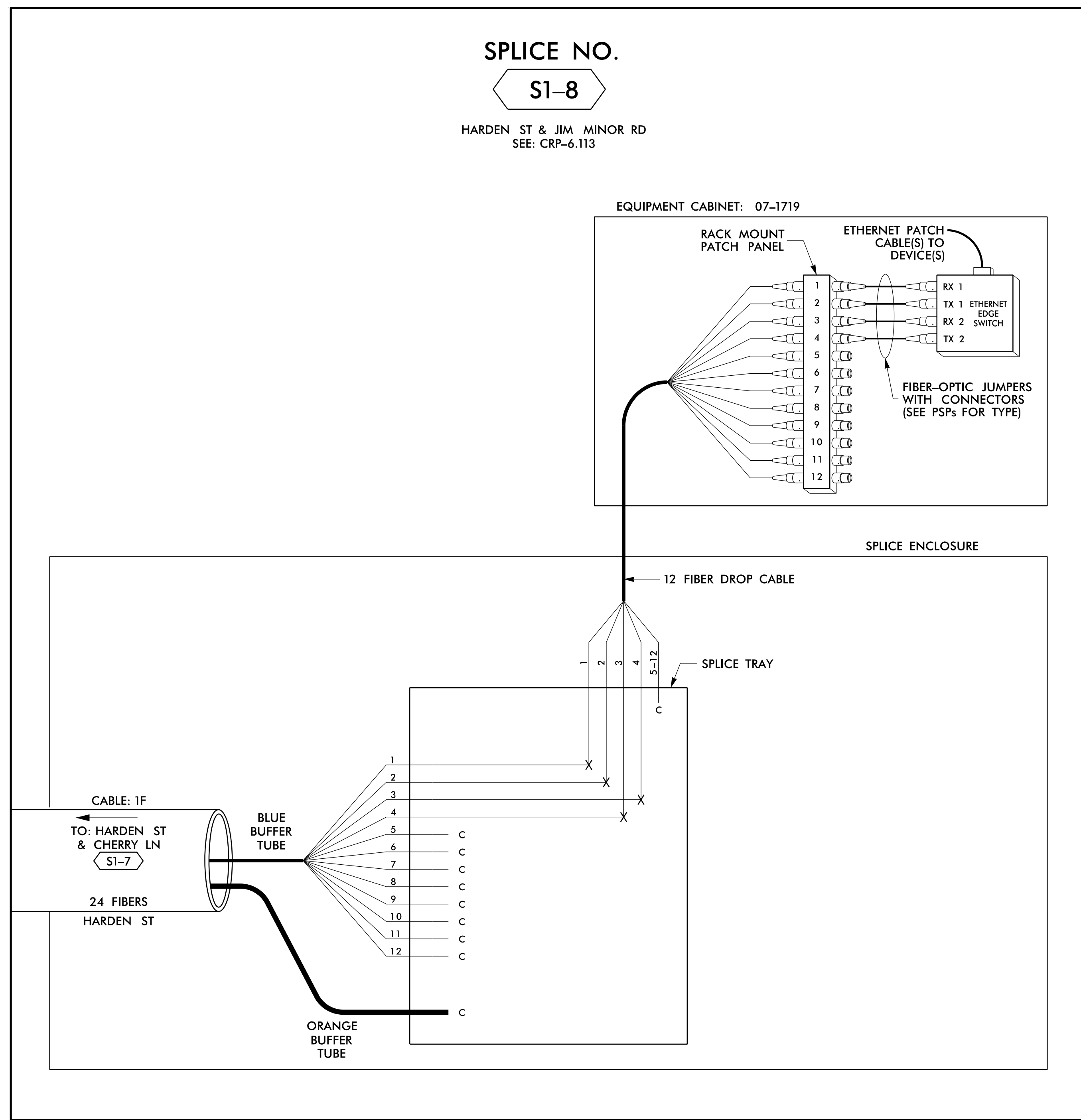

SPLICE NO.

S1-9

HARDEN ST & RIVERBEND RD
SEE: CRP-6.105

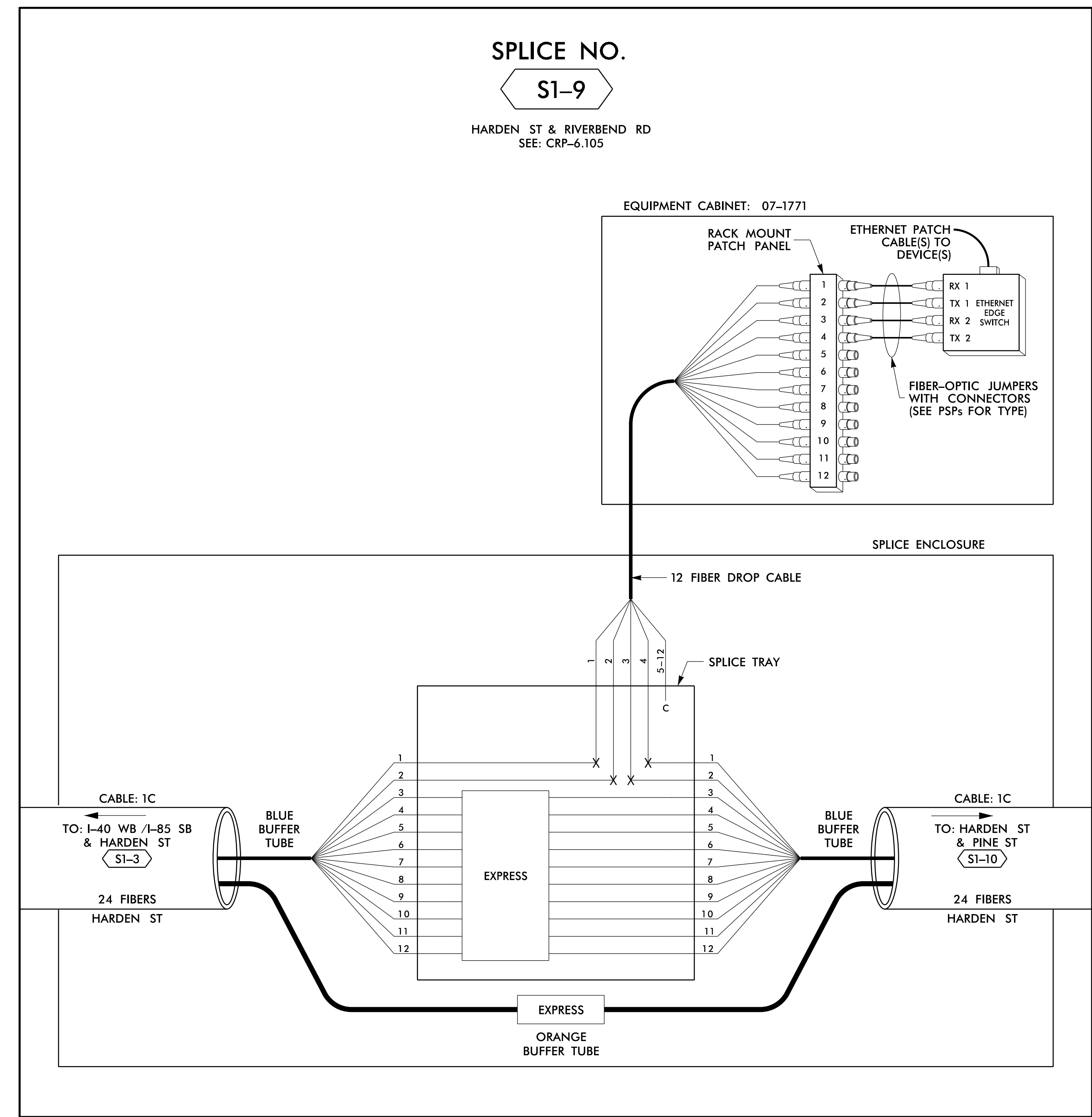

14 JUN 2018 12:06
 D:\projects\atkins\proj\crp\tr\off\c\cur\100056469 U-6015 B-C Sig Sys\Task 11_Coms\F S 4.007.dgn
 S:\033633 AT_LL\3355433

LEGEND

COLOR CODE TIA/EIA 598-B		X = FUSION SPlice INDIVIDUAL FIBER	EXPRESS	EXPRESS ENTIRE BUFFER TUBE /FIBERS THROUGH WITHOUT CUTTING
(1) BLUE	(7) RED	C = CAP AND SEAL	BUFFER SPlice	SPlice ALL FIBERS IN BUFFER TUBE COLOR TO COLOR
(2) ORANGE	(8) BLACK		EXISTING	EXISTING BUFFER TUBE /FIBERS DO NOT MODIFY EXISTING SPlices OR EXPRESSED FIBERS.
(3) GREEN	(9) YELLOW			
(4) BROWN	(10) VIOLET			
(5) SLATE	(11) ROSE			
(6) WHITE	(12) AQUA			

NOTES

- UNUSED FIBERS LEFT COILED AND STORED IN SPLICE TRAY
- UNUSED BUFFER TUBES LEFT COILED AND STORED IN SPLICE ENCLOSURE
- EDGE SWITCH CONFIGURATIONS ARE GENERIC. CONTRACTOR IS RESPONSIBLE FOR DETERMINING/ENSURING THE PROPER TERMINATIONS.

ATKINS 1616 EAST MILLBROOK ROAD, SUITE 160
RALEIGH, NORTH CAROLINA 27609
(919) 876-6888 NCBES #F-0326

DOCUMENT NOT CONSIDERED FINAL UNLESS ALL SIGNATURES COMPLETED

<p>750 Greenfield Parkway, Garner, NC 27529</p>	<p>Burlington-Graham Signal System Fiber-Optic Splicing Details</p> <p>Division 7 Alamance County Burlington & Graham</p>		<p>BRADFORD J. SLOCOM ENGINEER SEAL 040877</p>								
	<p>PLAN DATE: June 2018</p> <p>PREPARED BY: BJ SLOCUM</p>	<p>REVIEWED BY: HA BADGETT</p> <p>REVIEWED BY: DL JONES</p>		<p>DATE</p> <p>DATE</p>							
<p>SCALE: N/A</p>	<p>REVISIONS</p> <table border="1"> <tr> <th>NO.</th> <th>DESCRIPTION</th> <th>INIT.</th> <th>DATE</th> </tr> <tr> <td> </td> <td> </td> <td> </td> <td> </td> </tr> </table>	NO.	DESCRIPTION	INIT.	DATE					<p>DATE</p>	<p>DATE</p>
NO.	DESCRIPTION	INIT.	DATE								

SPLICE NO.

S1-10

HARDEN ST & PINE ST
SEE: CRP-6.104

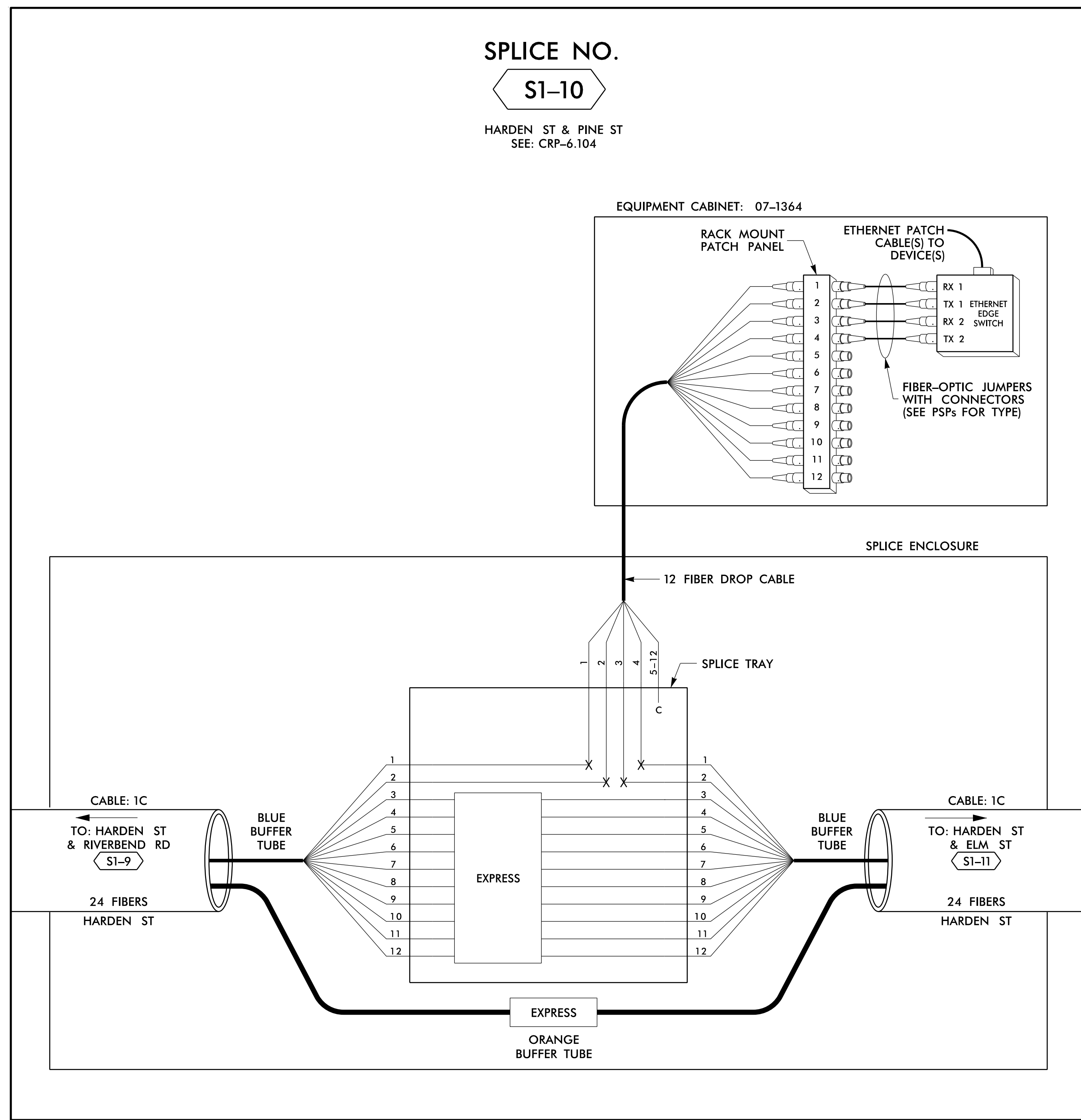

14 JUN 2018 12:06
 D:\Technical\proj\crp\tr\off\c\curr\100056469 U-6015 B-C Sig_Sys\Task 11_Comm\Fs 4_008.dgn
 S:\DCS\653 AT_LLJ355433

LEGEND

COLOR CODE TIA/EIA 598-B		X = FUSION SPLICE INDIVIDUAL FIBER C = CAP AND SEAL
(1) BLUE	(7) RED	EXPRESS EXPRESS ENTIRE BUFFER TUBE / FIBERS THROUGH WITHOUT CUTTING
(2) ORANGE	(8) BLACK	BUFFER SPLICE SPLICE ALL FIBERS IN BUFFER TUBE COLOR TO COLOR
(3) GREEN	(9) YELLOW	EXISTING EXISTING BUFFER TUBE / FIBERS DO NOT MODIFY EXISTING SPLICES OR EXPRESSED FIBERS.
(4) BROWN	(10) VIOLET	
(5) SLATE	(11) ROSE	
(6) WHITE	(12) AQUA	

NOTES

- UNUSED FIBERS LEFT COILED AND STORED IN SPLICE TRAY
- UNUSED BUFFER TUBES LEFT COILED AND STORED IN SPLICE ENCLOSURE
- EDGE SWITCH CONFIGURATIONS ARE GENERIC. CONTRACTOR IS RESPONSIBLE FOR DETERMINING/ENSURING THE PROPER TERMINATIONS.

ATKINS 1616 EAST MILLBROOK ROAD, SUITE 160
 RALEIGH, NORTH CAROLINA 27609
 (919) 876-6888 NCBES #F-0326

DOCUMENT NOT CONSIDERED FINAL UNLESS ALL SIGNATURES COMPLETED

Prepared for the Offices of:  750 Greenfield Parkway, Garner, NC 27529	Burlington-Graham Signal System Fiber-Optic Splicing Details		SEAL NORTH CAROLINA PROFESSIONAL ENGINEER SEAL 040877 BRADFORD J. SLOCUM 15/2018 DATE
	Division 7 Alamance County PLAN DATE: June 2018 PREPARED BY: BJ SLOCUM	Burlington & Graham REVIEWED BY: HA BADGETT REVIEWED BY: DL JONES	

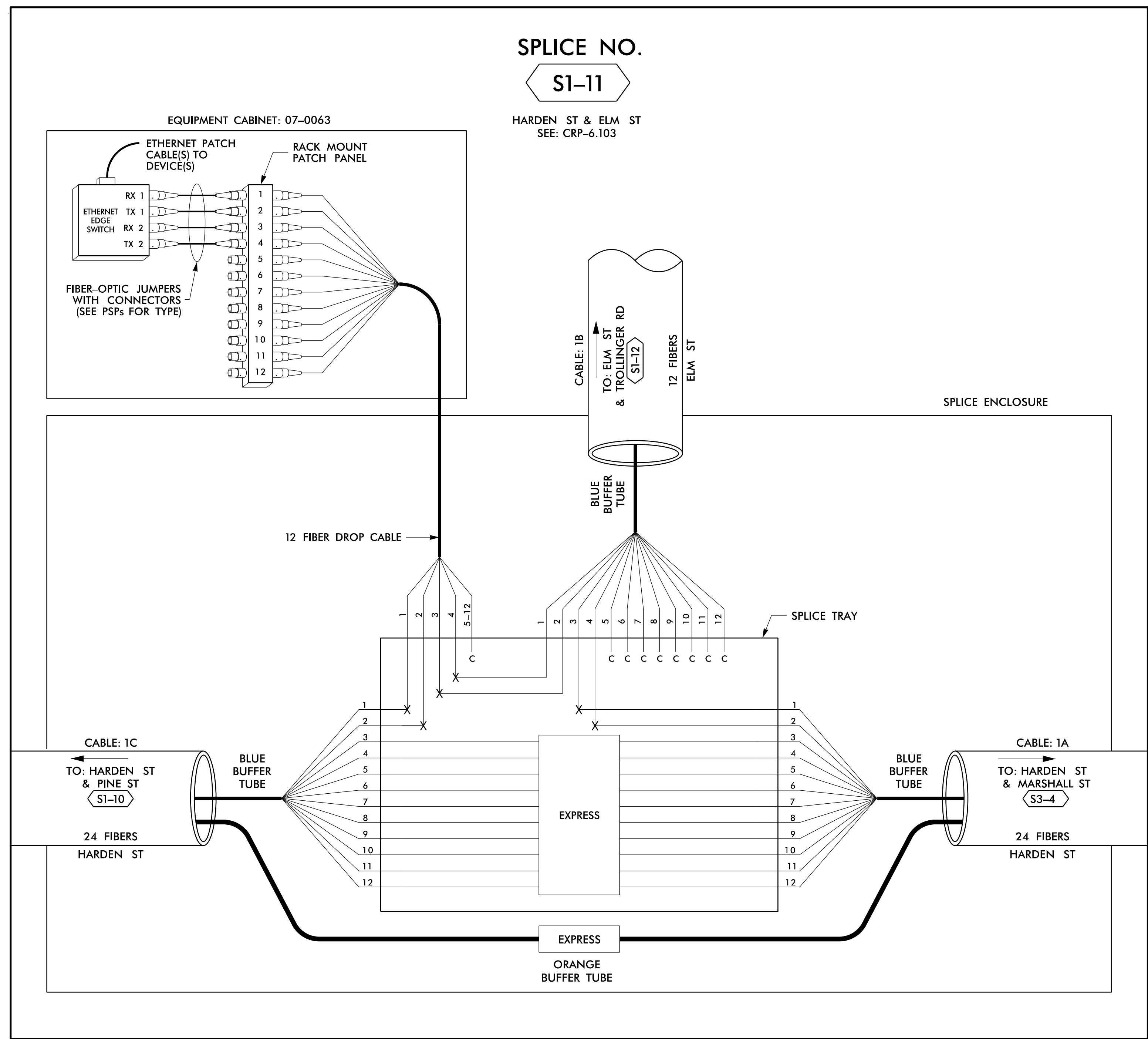

14 JUN 2018 12:07
 D:\projects\11_06015_B-C_Sig_Sys\Task_11_Comms\F_S 4.009.dgn
 S:\035633 AT_LUS355433

COLOR CODE		LEGEND	
TIA/EIA	598-B		
(1) BLUE	(7) RED	EXPRESS	EXPRESS ENTIRE BUFFER TUBE / FIBERS THROUGH WITHOUT CUTTING
(2) ORANGE	(8) BLACK	BUFFER SPLICE	SPLICE ALL FIBERS IN BUFFER TUBE COLOR TO COLOR
(3) GREEN	(9) YELLOW	EXISTING	EXISTING BUFFER TUBE / FIBERS DO NOT MODIFY EXISTING SPLICES OR EXPRESSED FIBERS.
(4) BROWN	(10) VIOLET		
(5) SLATE	(11) ROSE		
(6) WHITE	(12) AQUA		

NOTES
1. UNUSED FIBERS LEFT COILED AND STORED IN SPLICE TRAY
2. UNUSED BUFFER TUBES LEFT COILED AND STORED IN SPLICE ENCLOSURE
3. EDGE SWITCH CONFIGURATIONS ARE GENERIC. CONTRACTOR IS RESPONSIBLE FOR DETERMINING/ENSURING THE PROPER TERMINATIONS.

ATKINS

1616 EAST MILLBROOK ROAD, SUITE 160
 RALEIGH, NORTH CAROLINA 27609
 (919) 876-6888 NCBEEES #F-0326

DOCUMENT NOT CONSIDERED FINAL UNLESS ALL SIGNATURES COMPLETED

Seal: NORTH CAROLINA PROFESSIONAL ENGINEER SEAL 040877

Burlington-Graham Signal System Fiber-Optic Splicing Details

Division 7 Alamance County Burlington & Graham

PLAN DATE: June 2018	REVIEWED BY: HA BADGETT
PREPARED BY: BJ SLOCUM	REVIEWED BY: DL JONES

750 Greenfield Parkway, Garner, NC 27529

SCALE: N/A

REVISIONS: INIT. DATE

DATE: 15/2018

CADD File name: FS_4.009.dgn

SPLICE NO.

S1-12

ELM ST & TROLLINGER RD
SEE: CRP-6.196

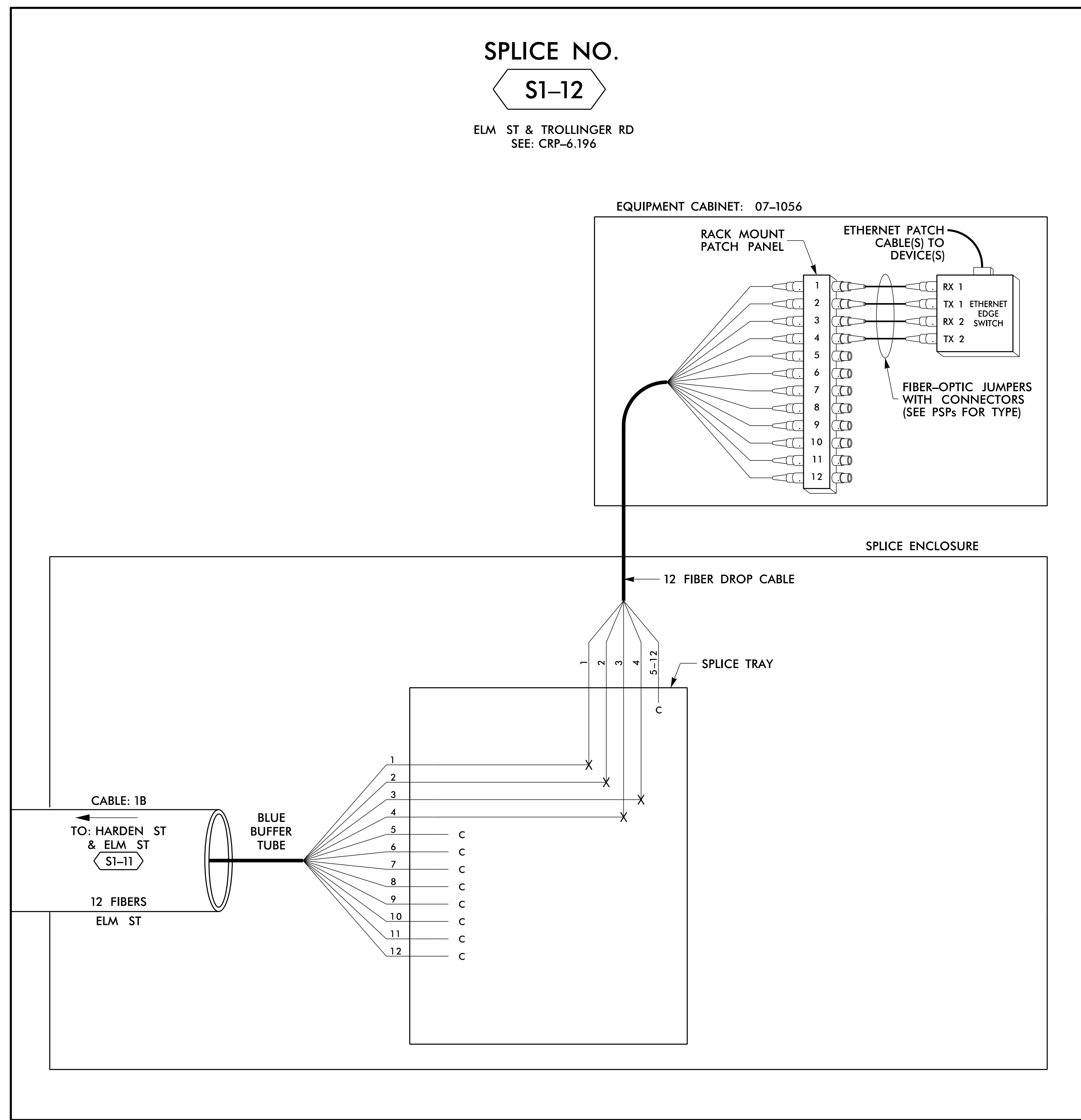

14 JUN 2018 12:07
 D:\Technical\Projects\U-6015 B-C Sig Sys\Task 11_Comms\F5 4.010.dgn
 S:\DCS\653 AT_LUS355433

LEGEND

COLOR CODE TIA/EIA 598-B		X = FUSION SPLICE INDIVIDUAL FIBER	
(1) BLUE	(7) RED	EXPRESS ENTIRE BUFFER TUBE / FIBERS THROUGH WITHOUT CUTTING	
(2) ORANGE	(8) BLACK	C = CAP AND SEAL	
(3) GREEN	(9) YELLOW	BUFFER SPLICE SPLICE ALL FIBERS IN BUFFER TUBE COLOR TO COLOR	
(4) BROWN	(10) VIOLET	EXISTING BUFFER TUBE / FIBERS DO NOT MODIFY EXISTING SPLICES OR EXPRESSED FIBERS.	
(5) SLATE	(11) ROSE		
(6) WHITE	(12) AQUA		

NOTES

- UNUSED FIBERS LEFT COILED AND STORED IN SPLICE TRAY
- UNUSED BUFFER TUBES LEFT COILED AND STORED IN SPLICE ENCLOSURE
- EDGE SWITCH CONFIGURATIONS ARE GENERIC. CONTRACTOR IS RESPONSIBLE FOR DETERMINING/ENSURING THE PROPER TERMINATIONS.

ATKINS 1616 EAST MILLBROOK ROAD, SUITE 160
RALEIGH, NORTH CAROLINA 27609
(919) 876-6888 NCBEEES #F-0326

DOCUMENT NOT CONSIDERED FINAL UNLESS ALL SIGNATURES COMPLETED

<p>Prepared for the Offices of: NORTH CAROLINA DEPARTMENT OF TRANSPORTATION 750 Greenfield Parkway, Garner, NC 27529</p>	<p>Burlington-Graham Signal System Fiber-Optic Splicing Details</p> <p>Division 7 Alamance County Burlington & Graham</p>		<p>SEAL NORTH CAROLINA PROFESSIONAL ENGINEER SEAL 040877 BRADFORD J. SLOCUM 15/2018</p>								
	<p>PLAN DATE: June 2018</p> <p>PREPARED BY: BJ SLOCUM</p>	<p>REVIEWED BY: HA BADGETT</p> <p>REVIEWED BY: DL JONES</p>									
<p>SCALE: N/A</p>	<table border="1"> <thead> <tr> <th>REVISIONS</th> <th>INIT.</th> <th>DATE</th> </tr> </thead> <tbody> <tr> <td> </td> <td> </td> <td> </td> </tr> <tr> <td> </td> <td> </td> <td> </td> </tr> </tbody> </table>	REVISIONS	INIT.	DATE							<p>DATE</p>
REVISIONS	INIT.	DATE									

DocuSign Envelope ID: 70404040
CADD Filename: FS_4.010.dgn

SPLICE NO.

S2-0

I-40 WB /I-85 SB & MM 146.16
SEE: CRP-6.199

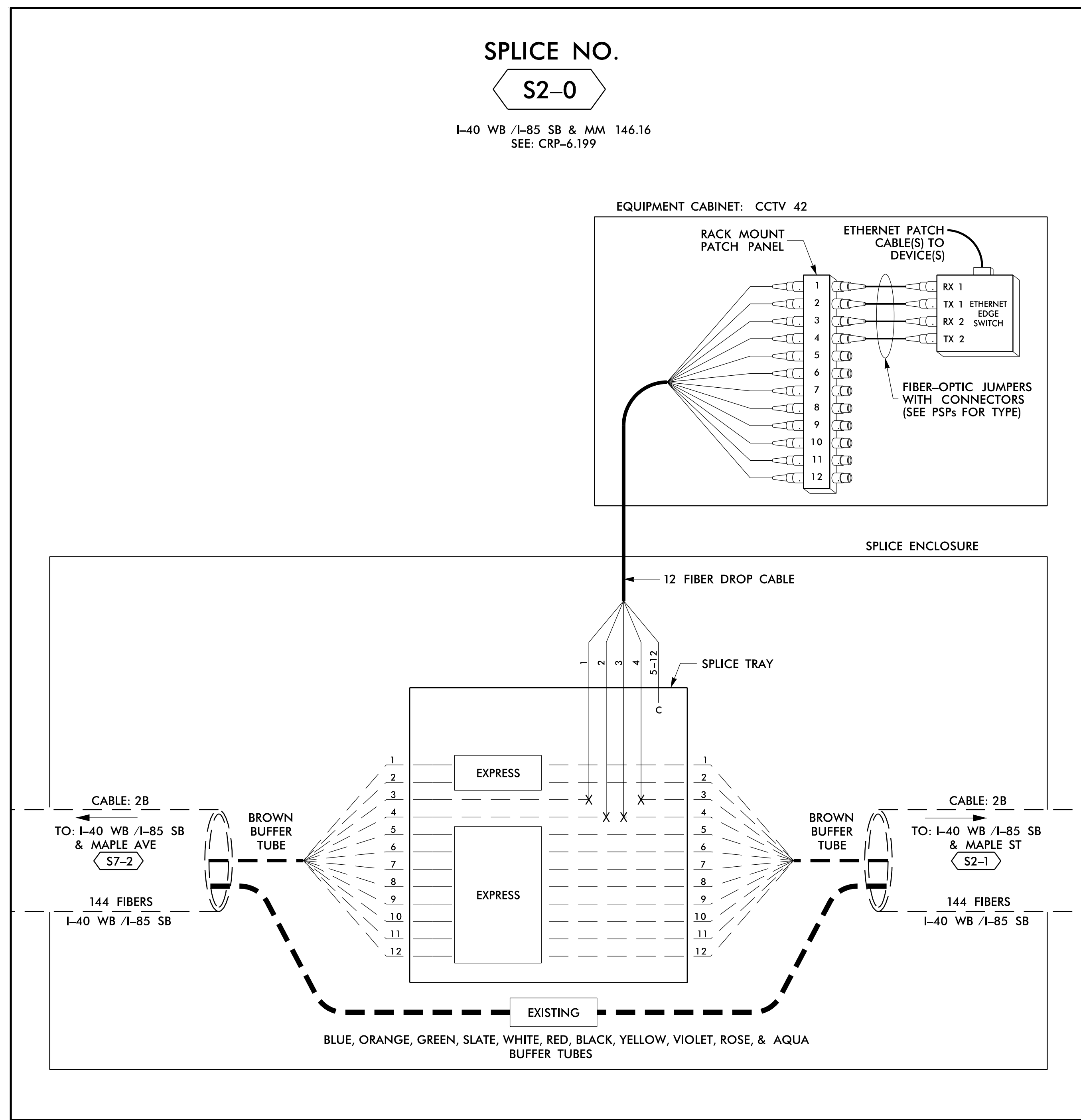

LEGEND

COLOR CODE TIA/EIA 598-B		X = FUSION SPLICE INDIVIDUAL FIBER	EXPRESS	EXPRESS ENTIRE BUFFER TUBE /FIBERS THROUGH WITHOUT CUTTING
(1) BLUE	(7) RED	C = CAP AND SEAL	BUFFER SPLICE	SPLICE ALL FIBERS IN BUFFER TUBE COLOR TO COLOR
(2) ORANGE	(8) BLACK		EXISTING	EXISTING BUFFER TUBE /FIBERS DO NOT MODIFY EXISTING SPLICES OR EXPRESSED FIBERS.
(3) GREEN	(9) YELLOW			
(4) BROWN	(10) VIOLET			
(5) SLATE	(11) ROSE			
(6) WHITE	(12) AQUA			

NOTES

- UNUSED FIBERS LEFT COILED AND STORED IN SPLICE TRAY
- UNUSED BUFFER TUBES LEFT COILED AND STORED IN SPLICE ENCLOSURE
- EDGE SWITCH CONFIGURATIONS ARE GENERIC. CONTRACTOR IS RESPONSIBLE FOR DETERMINING/ENSURING THE PROPER TERMINATIONS.

ATKINS 1616 EAST MILLBROOK ROAD, SUITE 160
RALEIGH, NORTH CAROLINA 27609
(919) 876-6888 NCBES #F-0326

**DOCUMENT NOT CONSIDERED FINAL
UNLESS ALL SIGNATURES COMPLETED**

<p>Prepared for the Offices of: NORTH CAROLINA DEPARTMENT OF TRANSPORTATION Transportation Systems</p>	Burlington-Graham Signal System Fiber-Optic Splicing Details		
	Division 7 Alamance County Burlington & Graham	PLAN DATE: June 2018 PREPARED BY: BJ SLOCUM REVIEWED BY: HA BADGETT REVIEWED BY: DL JONES	
SCALE N/A	REVISIONS INIT. DATE		SEAL NORTH CAROLINA PROFESSIONAL ENGINEER SEAL 040877 BRADFORD J. SLOCUM 15/2018 DATE

14-JUN-2018 12:08
 D:\Technical\proj\040877\off\c\curr\100056469 U-6015 B-C Sig_Sys\Task 11_Comms\F S 4.011.dgn
 SLOCS363 AT LUS355433

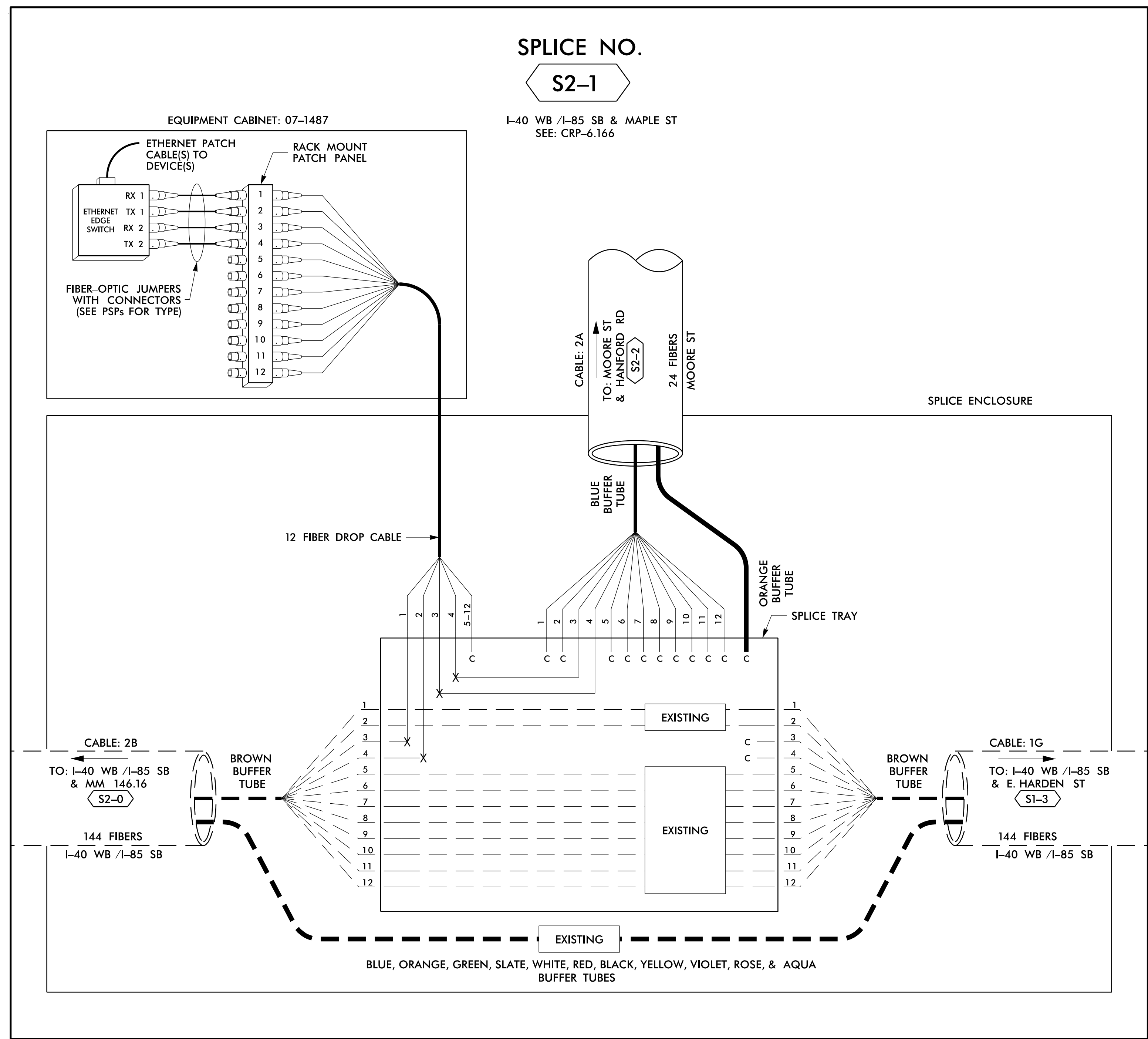

SPLICE NO.
S2-1

I-40 WB /I-85 SB & MAPLE ST
 SEE: CRP-6.166

EQUIPMENT CABINET: 07-1487

SPLICE ENCLOSURE

12 FIBER DROP CABLE

CABLE: 2B

TO: I-40 WB /I-85 SB & MM 146.16
 S2-0

144 FIBERS
 I-40 WB /I-85 SB

CABLE: 1G

TO: I-40 WB /I-85 SB & E. HARDEN ST
 S1-3

144 FIBERS
 I-40 WB /I-85 SB

BLUE, ORANGE, GREEN, SLATE, WHITE, RED, BLACK, YELLOW, VIOLET, ROSE, & AQUA
 BUFFER TUBES

LEGEND

COLOR CODE TIA/EIA 598-B		X = FUSION SPlice INDIVIDUAL FIBER C = CAP AND SEAL	
(1) BLUE	(7) RED	EXPRESS	EXPRESS ENTIRE BUFFER TUBE /FIBERS THROUGH WITHOUT CUTTING
(2) ORANGE	(8) BLACK	BUFFER SPlice	SPlice ALL FIBERS IN BUFFER TUBE COLOR TO COLOR
(3) GREEN	(9) YELLOW	EXISTING	EXISTING BUFFER TUBE /FIBERS DO NOT MODIFY EXISTING SPlices OR EXPRESSED FIBERS.
(4) BROWN	(10) VIOLET		
(5) SLATE	(11) ROSE		
(6) WHITE	(12) AQUA		

NOTES

- UNUSED FIBERS LEFT COILED AND STORED IN SPLICE TRAY
- UNUSED BUFFER TUBES LEFT COILED AND STORED IN SPLICE ENCLOSURE
- EDGE SWITCH CONFIGURATIONS ARE GENERIC. CONTRACTOR IS RESPONSIBLE FOR DETERMINING/ENSURING THE PROPER TERMINATIONS.

ATKINS 1616 EAST MILLBROOK ROAD, SUITE 160
 RALEIGH, NORTH CAROLINA 27609
 (919) 876-6888 NCBEE# F-0326

DOCUMENT NOT CONSIDERED FINAL
 UNLESS ALL SIGNATURES COMPLETED

	Prepared for the Offices of: NORTH CAROLINA DEPARTMENT OF TRANSPORTATION		
	Burlington-Graham Signal System Fiber-Optic Splicing Details		
Division 7 Alamance County Burlington & Graham		PLAN DATE: June 2018 REVIEWED BY: HA BADGETT	
PREPARED BY: BJ SLOCUM		REVIEWED BY: DL JONES	
SCALE: N/A		REVISIONS: _____ INIT. DATE _____	
750 Greenfield Parkway, Garner, NC 27529		CAD FILE NAME: FS_4.012.dgn	

14 JUN 2018 12:08
 D:\Projects\2018\11_Corridor\11_Corridor\11_Corridor.dgn
 S:\033653 AT_LUS355433

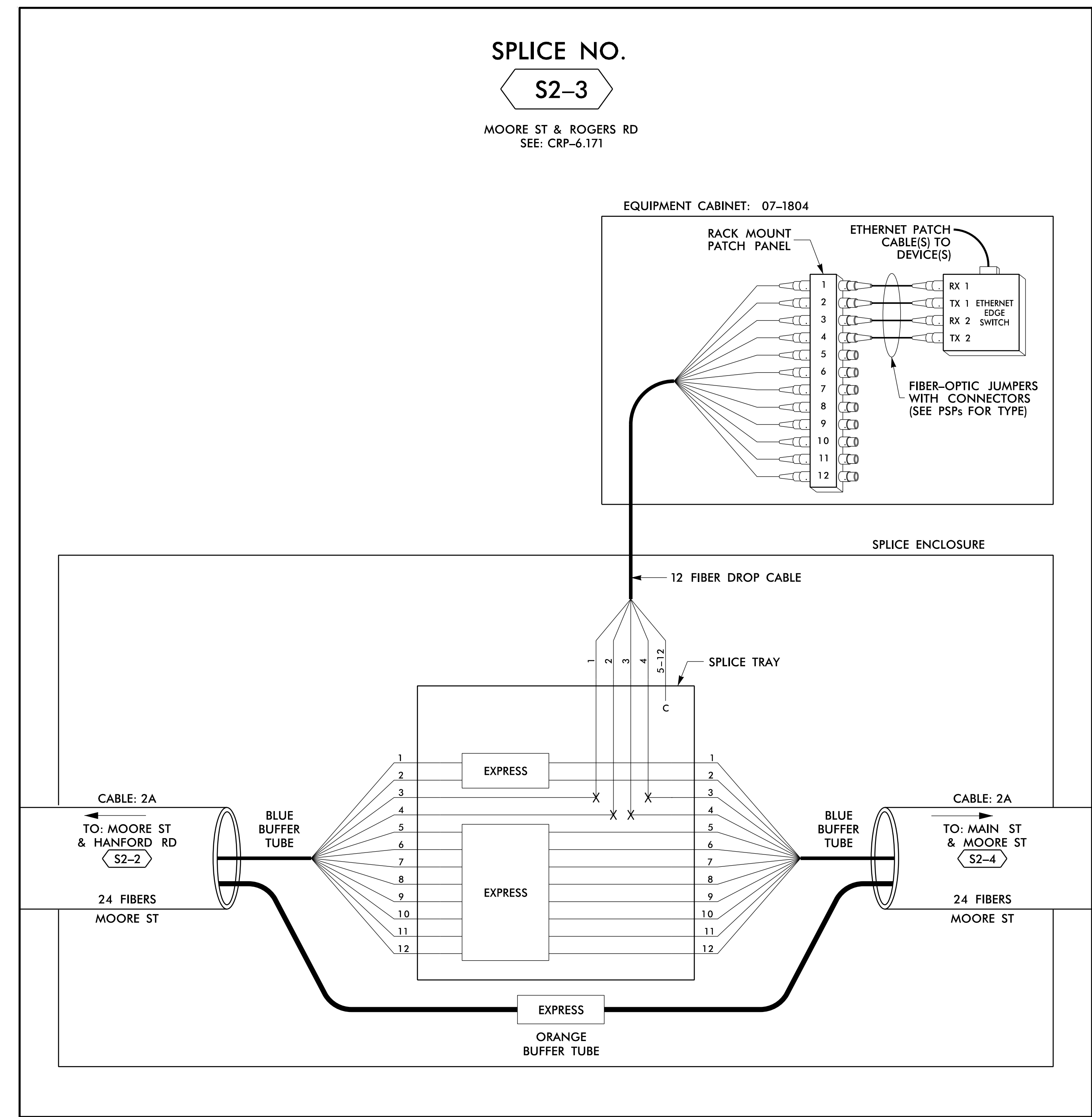
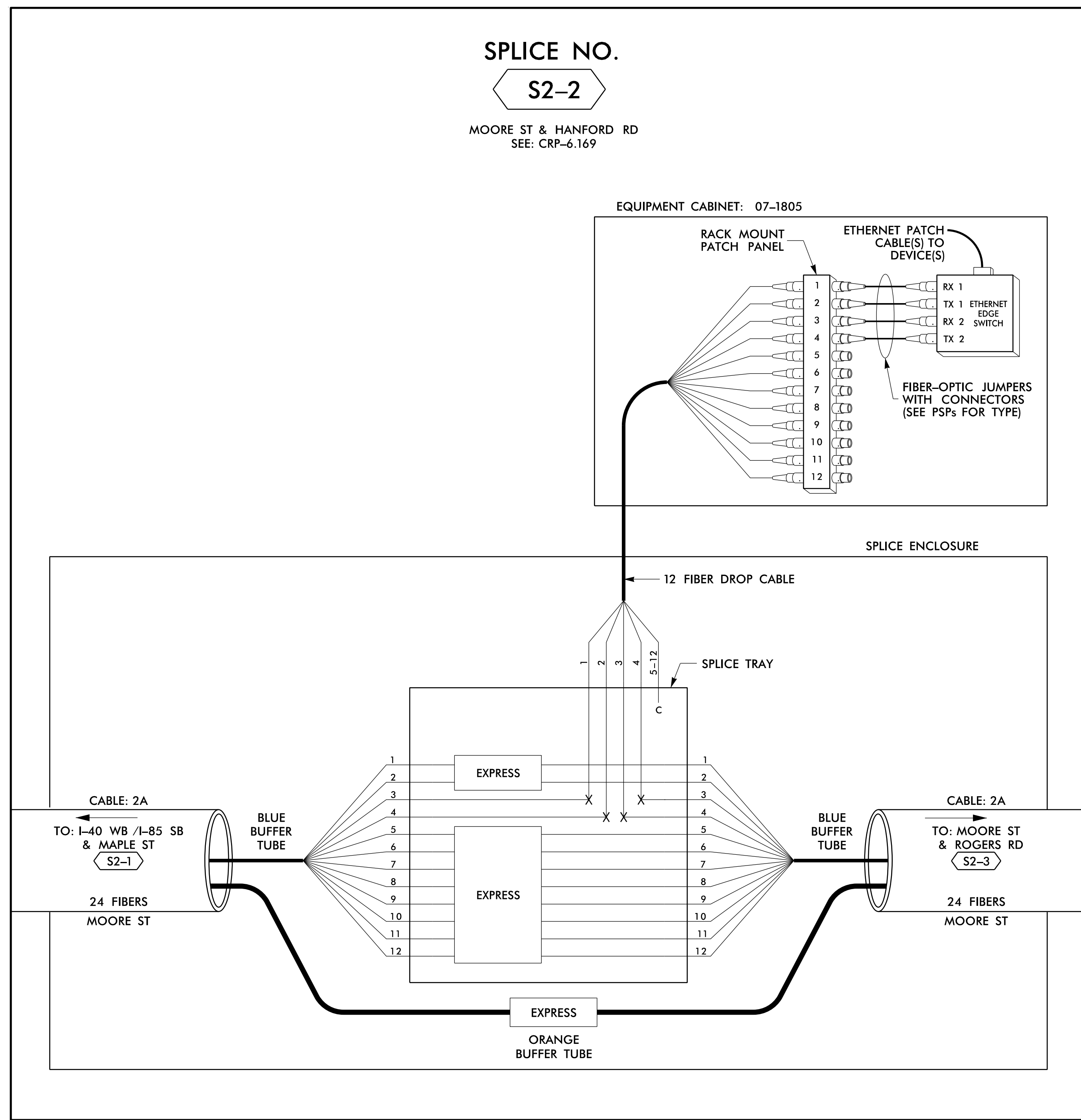

14 JUN 2018 12:09
 D:\projects\proj\100056469 U-6015 B-C Sig Sys\Task 11_Coms\Fs 4.013.dgn
 SLOD3653 AT LUS355433

LEGEND

COLOR CODE TIA/EIA 598-B		X = FUSION SPlice INDIVIDUAL FIBER C = CAP AND SEAL
(1) BLUE	(7) RED	EXPRESS
(2) ORANGE	(8) BLACK	EXPRESS ENTIRE BUFFER TUBE / FIBERS THROUGH WITHOUT CUTTING
(3) GREEN	(9) YELLOW	BUFFER SPlice
(4) BROWN	(10) VIOLET	SPlice ALL FIBERS IN BUFFER TUBE COLOR TO COLOR
(5) SLATE	(11) ROSE	EXISTING
(6) WHITE	(12) AQUA	EXISTING BUFFER TUBE / FIBERS DO NOT MODIFY EXISTING SPlices OR EXPRESSED FIBERS.

- #### NOTES
- UNUSED FIBERS LEFT COILED AND STORED IN SPlice TRAY
 - UNUSED BUFFER TUBES LEFT COILED AND STORED IN SPlice ENCLOSURE
 - EDGE SWITCH CONFIGURATIONS ARE GENERIC. CONTRACTOR IS RESPONSIBLE FOR DETERMINING/ENSURING THE PROPER TERMINATIONS.

1616 EAST MILLBROOK ROAD, SUITE 160
 RALEIGH, NORTH CAROLINA 27609
 (919) 876-6888 NCBEEs #F-0326

DOCUMENT NOT CONSIDERED FINAL UNLESS ALL SIGNATURES COMPLETED

Prepared for the Offices of: DEPARTMENT OF TRANSPORTATION North Carolina Transportation System	
Burlington-Graham Signal System Fiber-Optic Splicing Details	
Division 7 Alamance County Burlington & Graham	
PLAN DATE: June 2018	REVIEWED BY: HA BADGETT
PREPARED BY: BJ SLOCUM	REVIEWED BY: DL JONES
REVISIONS INIT. DATE	
SCALE: N/A	

DATE: 15/2018
 CADD Filename: FS_4.013.dgn

SPLICE NO. S2-4

MAIN ST & MOORE ST SEE: CRP-6.172

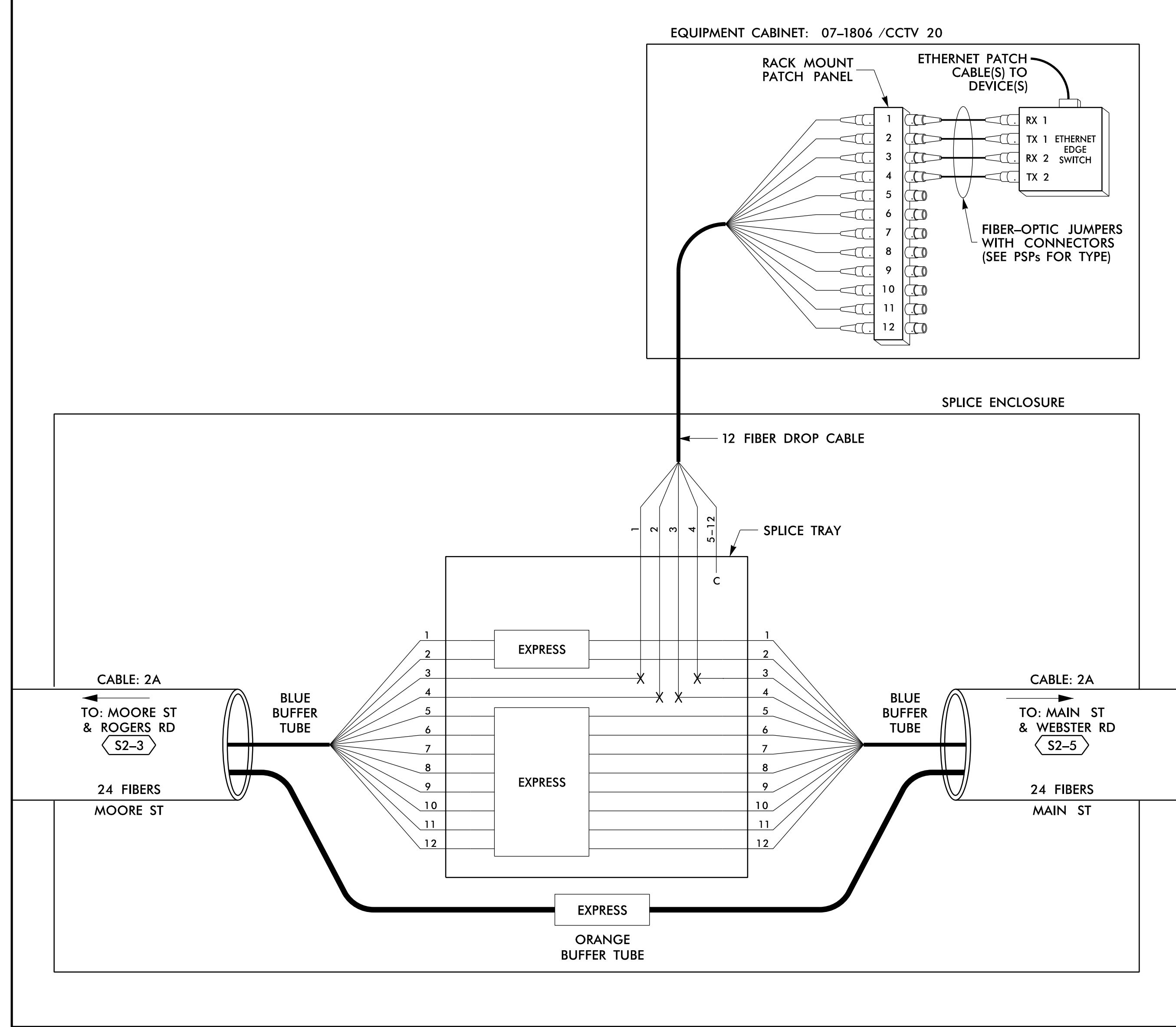

SPLICE NO. S2-5

MAIN ST & WEBSTER RD SEE: CRP-6.173

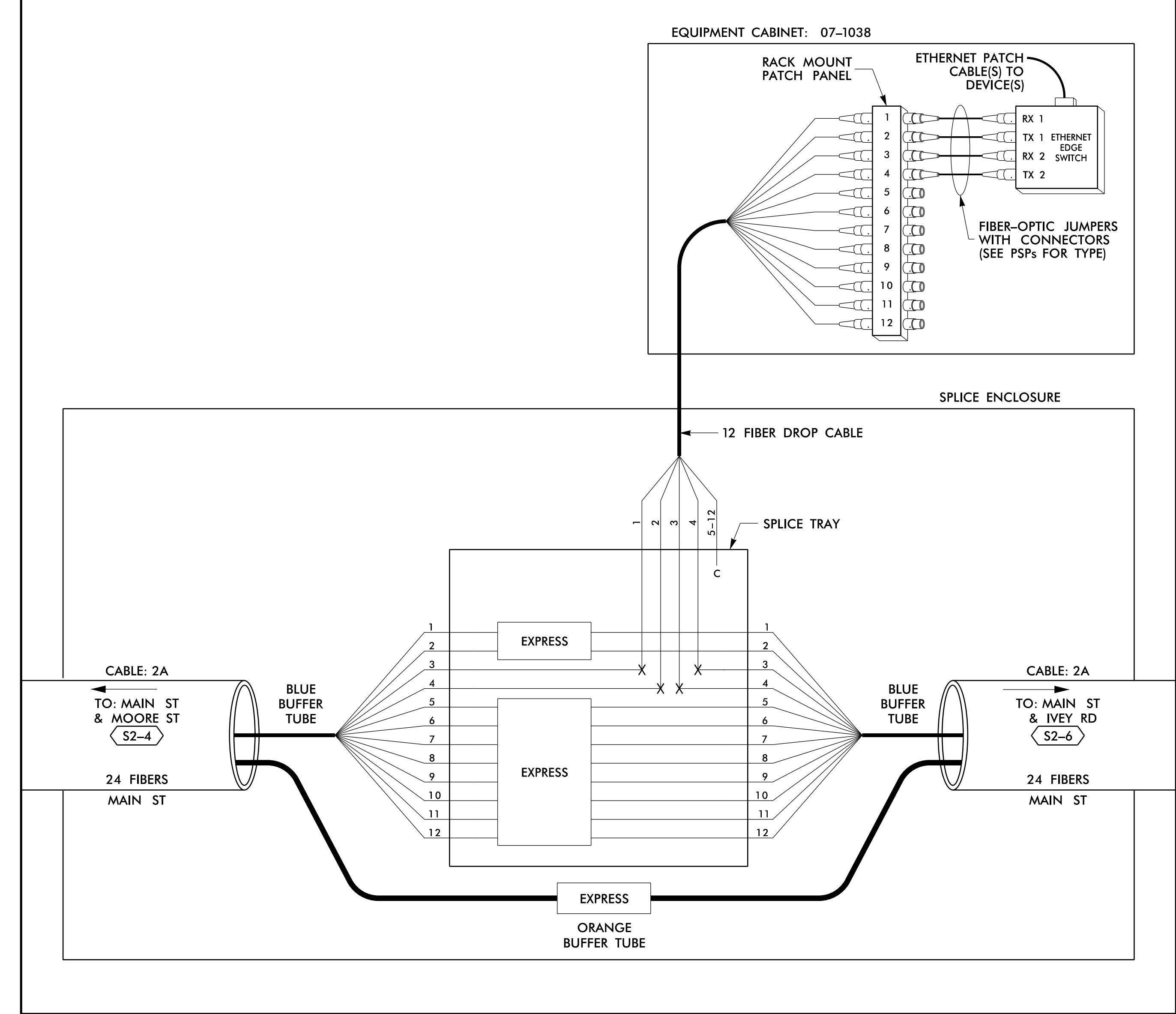

14 JUN 2018 12:09 D:\projects\atkins\proj\crp\off\crp\U-6015 B-C Sig Sys\Task 11_Corrs\Fs 4.014.dgn S:\033653 AT_LUS355433

LEGEND

COLOR CODE TIA/EIA 598-B		X = FUSION SPLICE INDIVIDUAL FIBER	EXPRESS	EXPRESS ENTIRE BUFFER TUBE /FIBERS THROUGH WITHOUT CUTTING
(1) BLUE	(7) RED	C = CAP AND SEAL	BUFFER SPLICE	SPLICE ALL FIBERS IN BUFFER TUBE COLOR TO COLOR
(2) ORANGE	(8) BLACK		EXISTING	EXISTING BUFFER TUBE /FIBERS DO NOT MODIFY EXISTING SPLICES OR EXPRESSED FIBERS.
(3) GREEN	(9) YELLOW			
(4) BROWN	(10) VIOLET			
(5) SLATE	(11) ROSE			
(6) WHITE	(12) AQUA			

NOTES

- UNUSED FIBERS LEFT COILED AND STORED IN SPLICE TRAY
- UNUSED BUFFER TUBES LEFT COILED AND STORED IN SPLICE ENCLOSURE
- EDGE SWITCH CONFIGURATIONS ARE GENERIC. CONTRACTOR IS RESPONSIBLE FOR DETERMINING/ENSURING THE PROPER TERMINATIONS.

ATKINS 1616 EAST MILLBROOK ROAD, SUITE 160 RALEIGH, NORTH CAROLINA 27609 (919) 876-6888 NCBEEES #F-0326

DOCUMENT NOT CONSIDERED FINAL UNLESS ALL SIGNATURES COMPLETED

<p>750 Greenfield Parkway, Garner, NC 27529</p>	<p>Burlington-Graham Signal System Fiber-Optic Splicing Details</p>		
	<p>Division 7 Alamance County Burlington & Graham</p>		
	<p>PLAN DATE: June 2018</p>	<p>REVIEWED BY: HA BADGETT</p>	
	<p>PREPARED BY: BJ SLOCUM</p>	<p>REVIEWED BY: DL JONES</p>	
<p>SCALE: N/A</p>		<p>REVISIONS</p>	<p>INIT. DATE</p>
<p>DATE: 15/2018</p>			

SPLICE NO.

S2-6

MAIN ST & IVEY RD
SEE: CRP-6.174

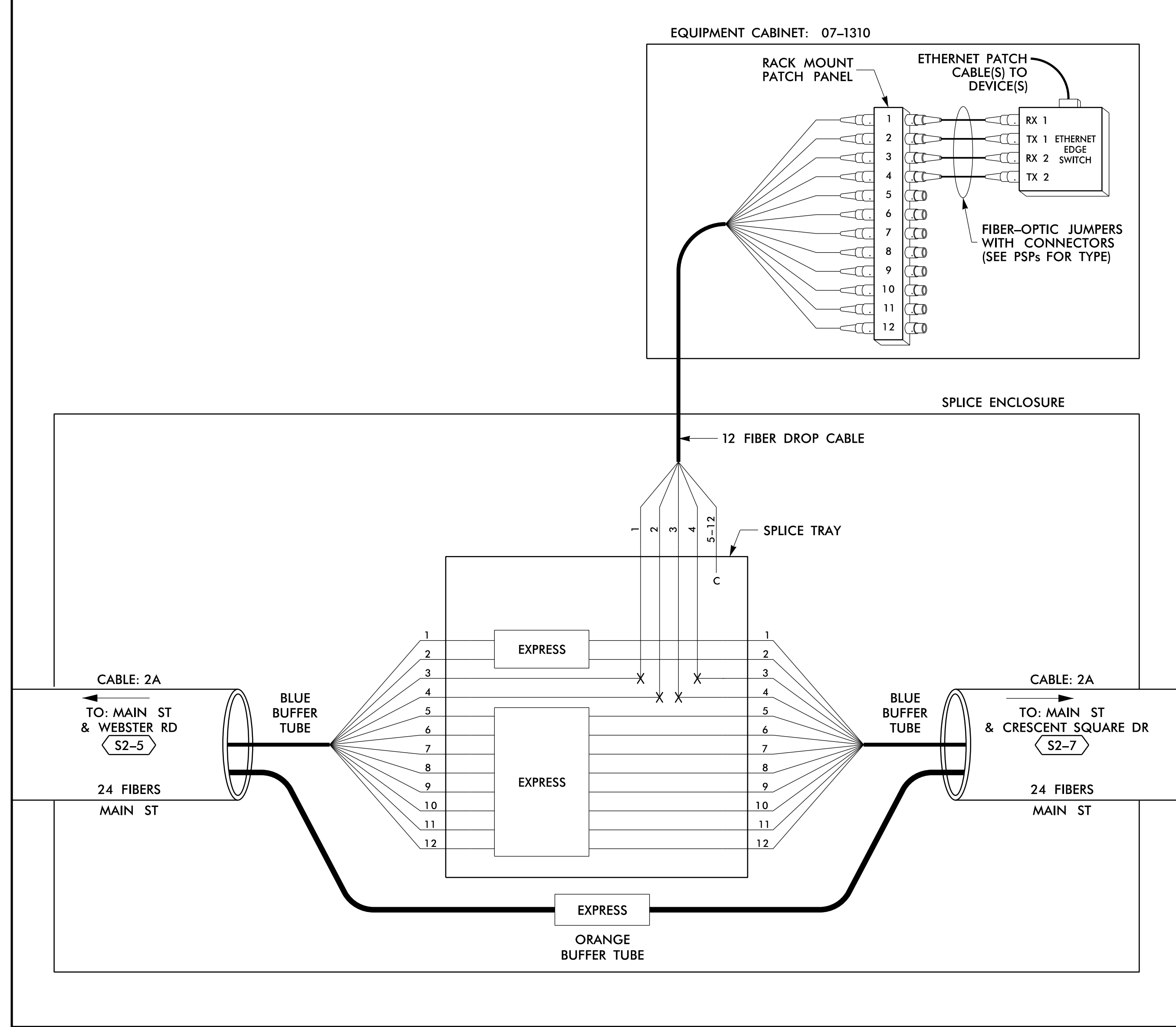

SPLICE NO.

S2-7

MAIN ST & CRESCENT SQUARE DR
SEE: CRP-6.175

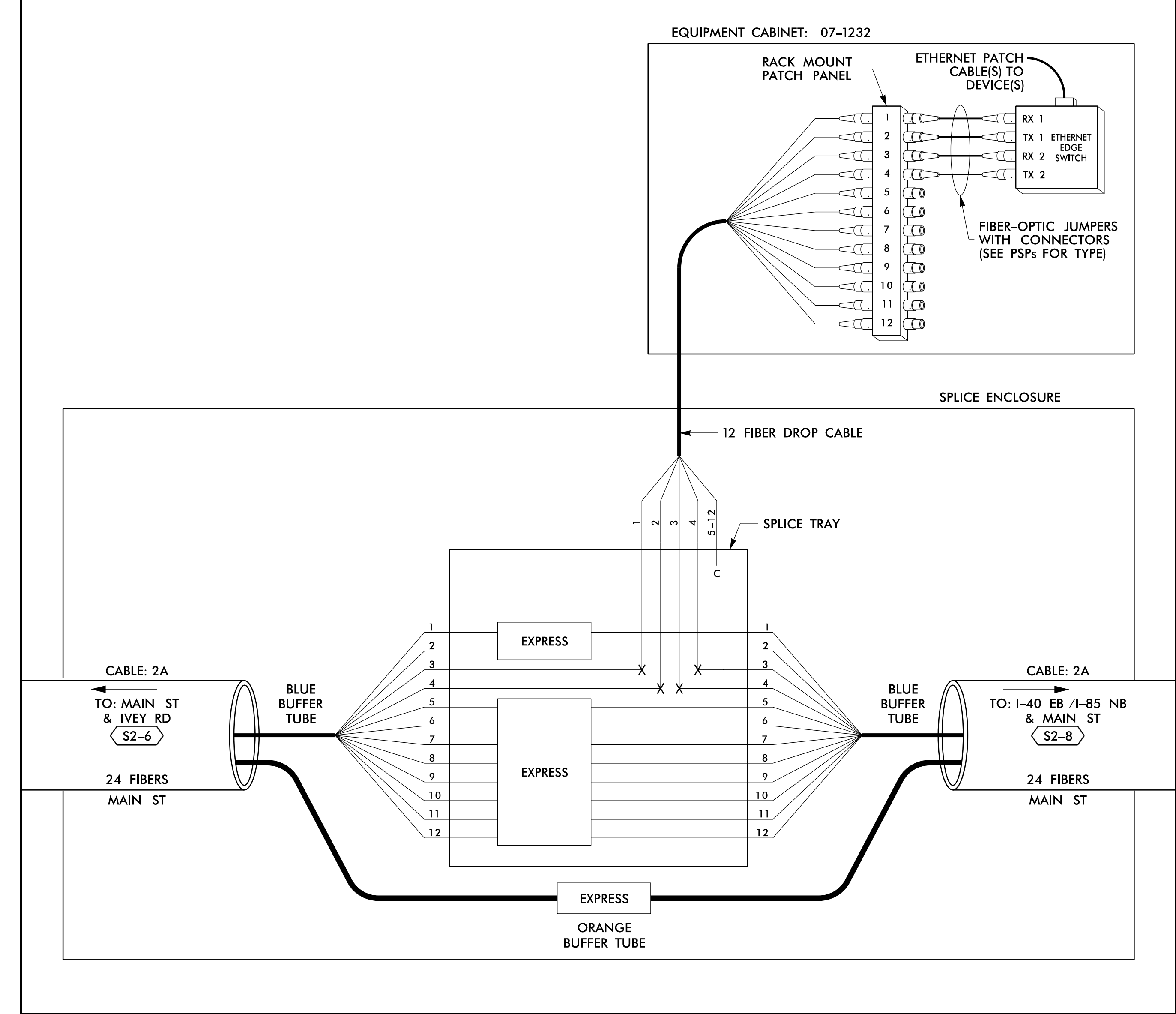

14 JUN 2018 12:10
 D:\projects\atkins\proj\offices\cur\100056469 U-6015 B-C Sig Sys\Task 11_Corrs\F S 4.015.dgn
 SLOD3653 AT LUS355433

LEGEND

COLOR CODE TIA/EIA 598-B		X = FUSION SPlice INDIVIDUAL FIBER C = CAP AND SEAL
(1) BLUE	(7) RED	EXPRESS
(2) ORANGE	(8) BLACK	EXPRESS ENTIRE BUFFER TUBE / FIBERS THROUGH WITHOUT CUTTING
(3) GREEN	(9) YELLOW	BUFFER SPlice
(4) BROWN	(10) VIOLET	SPlice ALL FIBERS IN BUFFER TUBE COLOR TO COLOR
(5) SLATE	(11) ROSE	EXISTING
(6) WHITE	(12) AQUA	EXISTING BUFFER TUBE / FIBERS DO NOT MODIFY EXISTING SPlices OR EXPRESSED FIBERS.

NOTES

- UNUSED FIBERS LEFT COILED AND STORED IN SPLICE TRAY
- UNUSED BUFFER TUBES LEFT COILED AND STORED IN SPLICE ENCLOSURE
- EDGE SWITCH CONFIGURATIONS ARE GENERIC. CONTRACTOR IS RESPONSIBLE FOR DETERMINING/ENSURING THE PROPER TERMINATIONS.

ATKINS 1616 EAST MILLBROOK ROAD, SUITE 160
 RALEIGH, NORTH CAROLINA 27609
 (919) 876-6888 NCBEEES #F-0326

DOCUMENT NOT CONSIDERED FINAL UNLESS ALL SIGNATURES COMPLETED

Prepared for the Offices of: 750 Greenfield Parkway, Garner, NC 27529	Burlington-Graham Signal System Fiber-Optic Splicing Details		SEAL NORTH CAROLINA PROFESSIONAL ENGINEER SEAL 040877 BRADFORD J. SLOCUM 15/2018 DATE
	Division 7 Alamance County PLAN DATE: June 2018 PREPARED BY: BJ SLOCUM	Burlington & Graham REVIEWED BY: HA BADGETT REVIEWED BY: DL JONES	

SPLICE NO.

S2-8

I-40 EB /I-85 NB & MAIN ST
SEE: CRP-6.176

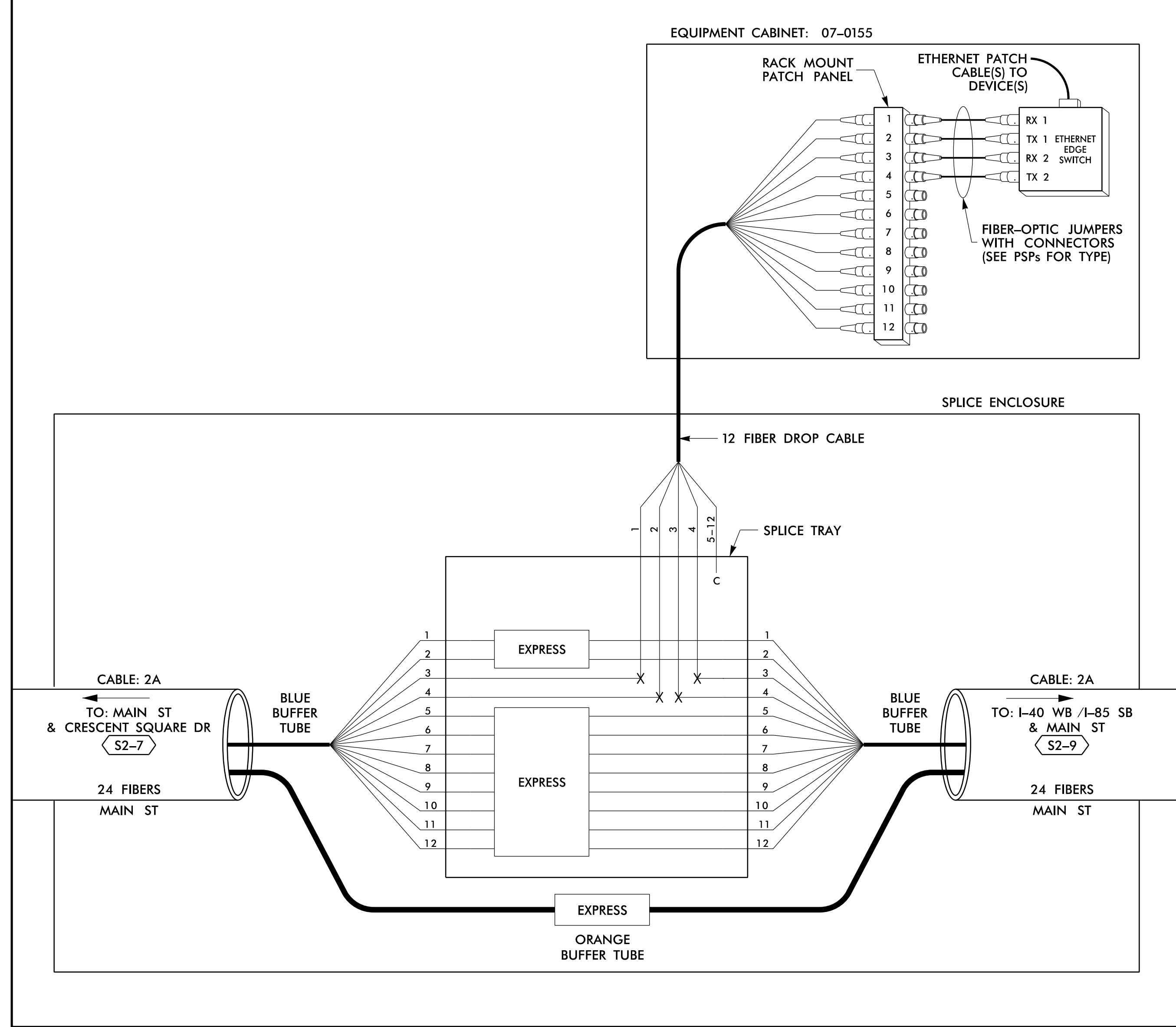

SPLICE NO.

S2-9

I-40 WB /I-85 SB & MAIN ST
SEE: CRP-6.176

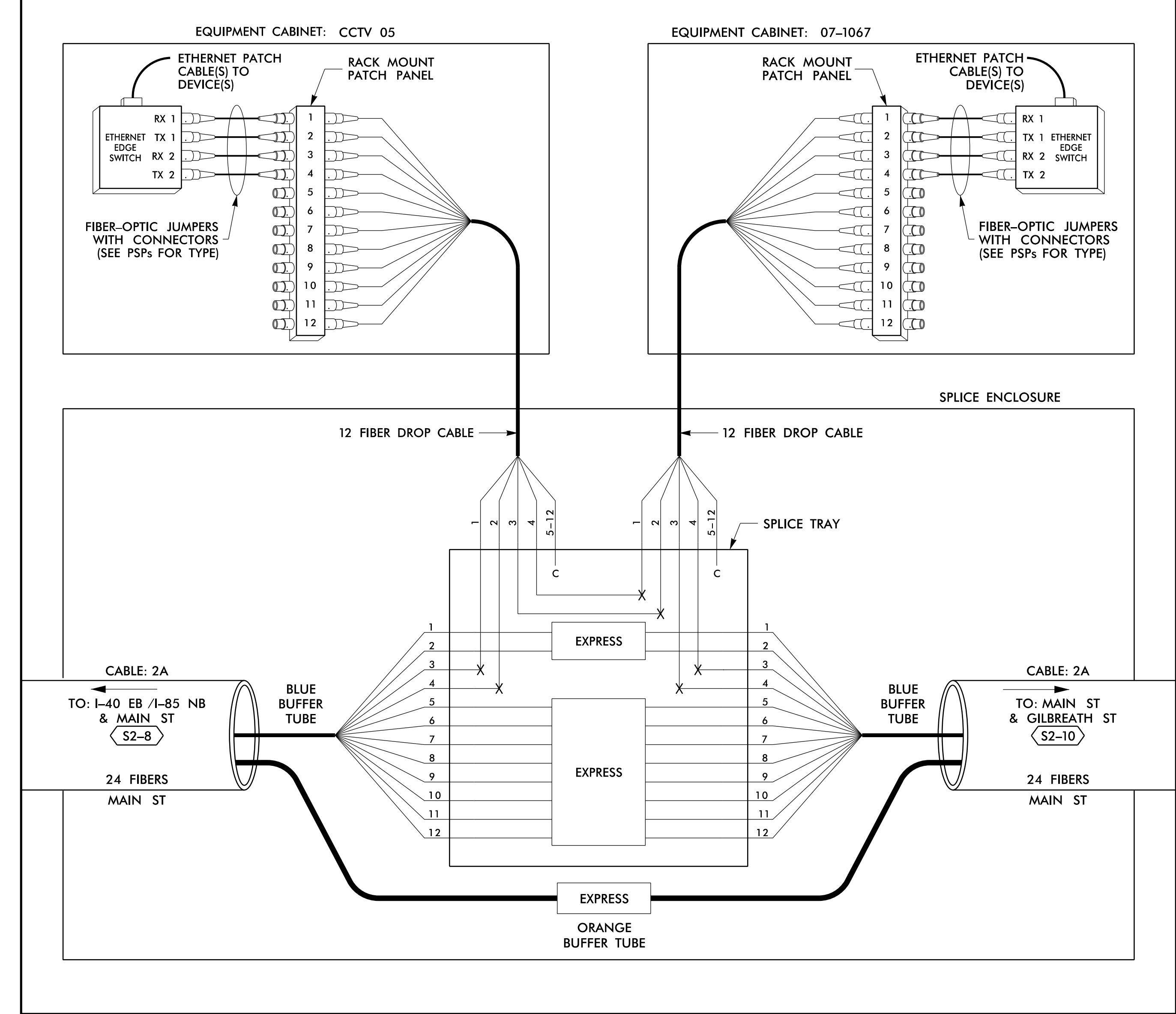

14 JUN 2018 12:10
 D:\Technical\Projects\U-6015 B-C Sig Sys\Task 11_Comms\F5 4.016.dgn
 S:\DCS\653 AT_LUS355433

LEGEND

COLOR CODE TIA/EIA 598-B		X = FUSION SPlice INDIVIDUAL FIBER C = CAP AND SEAL
(1) BLUE	(7) RED	EXPRESS
(2) ORANGE	(8) BLACK	BUFFER SPlice
(3) GREEN	(9) YELLOW	EXISTING
(4) BROWN	(10) VIOLET	
(5) SLATE	(11) ROSE	
(6) WHITE	(12) AQUA	

EXPRESS ENTIRE BUFFER TUBE / FIBERS THROUGH WITHOUT CUTTING
 SPlice ALL FIBERS IN BUFFER TUBE COLOR TO COLOR
 EXISTING BUFFER TUBE / FIBERS DO NOT MODIFY EXISTING SPlices OR EXPRESSED FIBERS.

NOTES

- UNUSED FIBERS LEFT COILED AND STORED IN SPlice TRAY
- UNUSED BUFFER TUBES LEFT COILED AND STORED IN SPlice ENCLOSURE
- EDGE SWITCH CONFIGURATIONS ARE GENERIC. CONTRACTOR IS RESPONSIBLE FOR DETERMINING/ENSURING THE PROPER TERMINATIONS.

ATKINS 1616 EAST MILLBROOK ROAD, SUITE 160
 RALEIGH, NORTH CAROLINA 27609
 (919) 876-6888 NCBEEES #F-0326

DOCUMENT NOT CONSIDERED FINAL UNLESS ALL SIGNATURES COMPLETED

Prepared for the Offices of: 750 Greenfield Parkway, Garner, NC 27529 SCALE: N/A	Burlington-Graham Signal System Fiber-Optic Splicing Details		SEAL NORTH CAROLINA PROFESSIONAL ENGINEER SEAL 040877 BRADFORD J. SLOCUM 15/2018 DATE
	Division 7 Alamance County PLAN DATE: June 2018 PREPARED BY: BJ SLOCUM	Burlington & Graham REVIEWED BY: HA BADGETT REVIEWED BY: DL JONES	

750 Greenfield Parkway, Garner, NC 27529
 SCALE: N/A

SPLICE NO.

S2-10

MAIN ST & GILBREATH ST
SEE: CRP-6.177

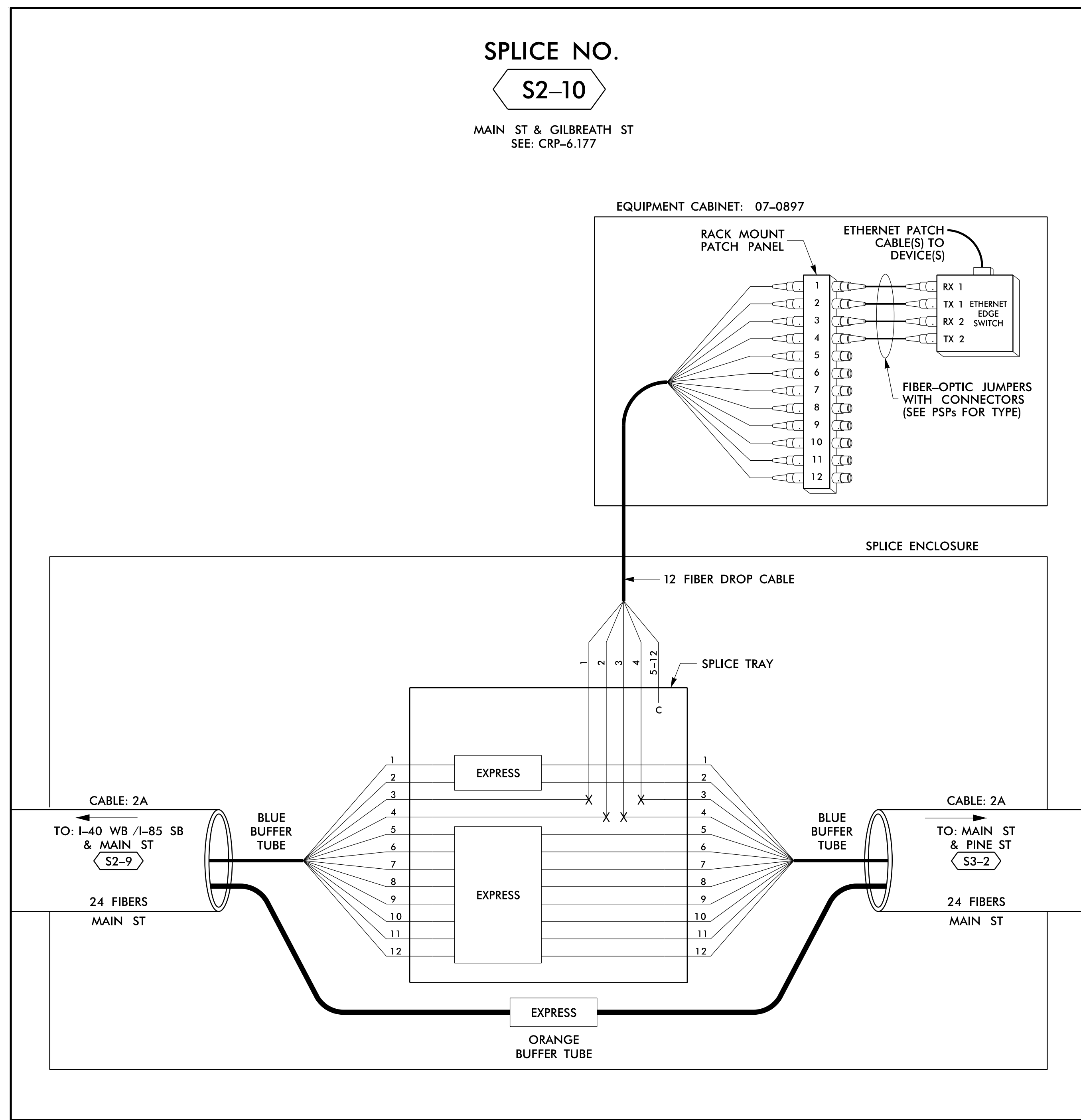

14 JUN 2018 12:11
 D:\Technical\Projects\U-6015 B-C Sig. Sys\Task 11_Comm\F5 4.017.dgn
 S:\DCS\653 AT_LUS355433

LEGEND

COLOR CODE TIA/EIA 598-B		X = FUSION SPlice INDIVIDUAL FIBER C = CAP AND SEAL
(1) BLUE	(7) RED	EXPRESS
(2) ORANGE	(8) BLACK	EXPRESS ENTIRE BUFFER TUBE / FIBERS THROUGH WITHOUT CUTTING
(3) GREEN	(9) YELLOW	BUFFER SPlice
(4) BROWN	(10) VIOLET	SPlice ALL FIBERS IN BUFFER TUBE COLOR TO COLOR
(5) SLATE	(11) ROSE	EXISTING
(6) WHITE	(12) AQUA	EXISTING BUFFER TUBE / FIBERS. DO NOT MODIFY EXISTING SPlices OR EXPRESSED FIBERS.

NOTES

- UNUSED FIBERS LEFT COILED AND STORED IN SPLICE TRAY
- UNUSED BUFFER TUBES LEFT COILED AND STORED IN SPLICE ENCLOSURE
- EDGE SWITCH CONFIGURATIONS ARE GENERIC. CONTRACTOR IS RESPONSIBLE FOR DETERMINING/ENSURING THE PROPER TERMINATIONS.

ATKINS 1616 EAST MILLBROOK ROAD, SUITE 160
 RALEIGH, NORTH CAROLINA 27609
 (919) 876-6888 NCBEEES #F-0326

DOCUMENT NOT CONSIDERED FINAL UNLESS ALL SIGNATURES COMPLETED

Prepared for the Offices of:  750 Greenfield Parkway, Garner, NC 27529	Burlington-Graham Signal System Fiber-Optic Splicing Details		SEAL NORTH CAROLINA PROFESSIONAL ENGINEER SEAL 040877 BRADFORD J. SLOCUM 15/2018 DATE
	Division 7 Alamance County PLAN DATE: June 2018 PREPARED BY: BJ SLOCUM	Burlington & Graham REVIEWED BY: HA BADGETT REVIEWED BY: DL JONES	
SCALE N/A			CADD File name: FS 4.017.dgn

SPLICE NO.
S3-1

HARDEN ST & MAPLE ST
 SEE: CRP-6.101

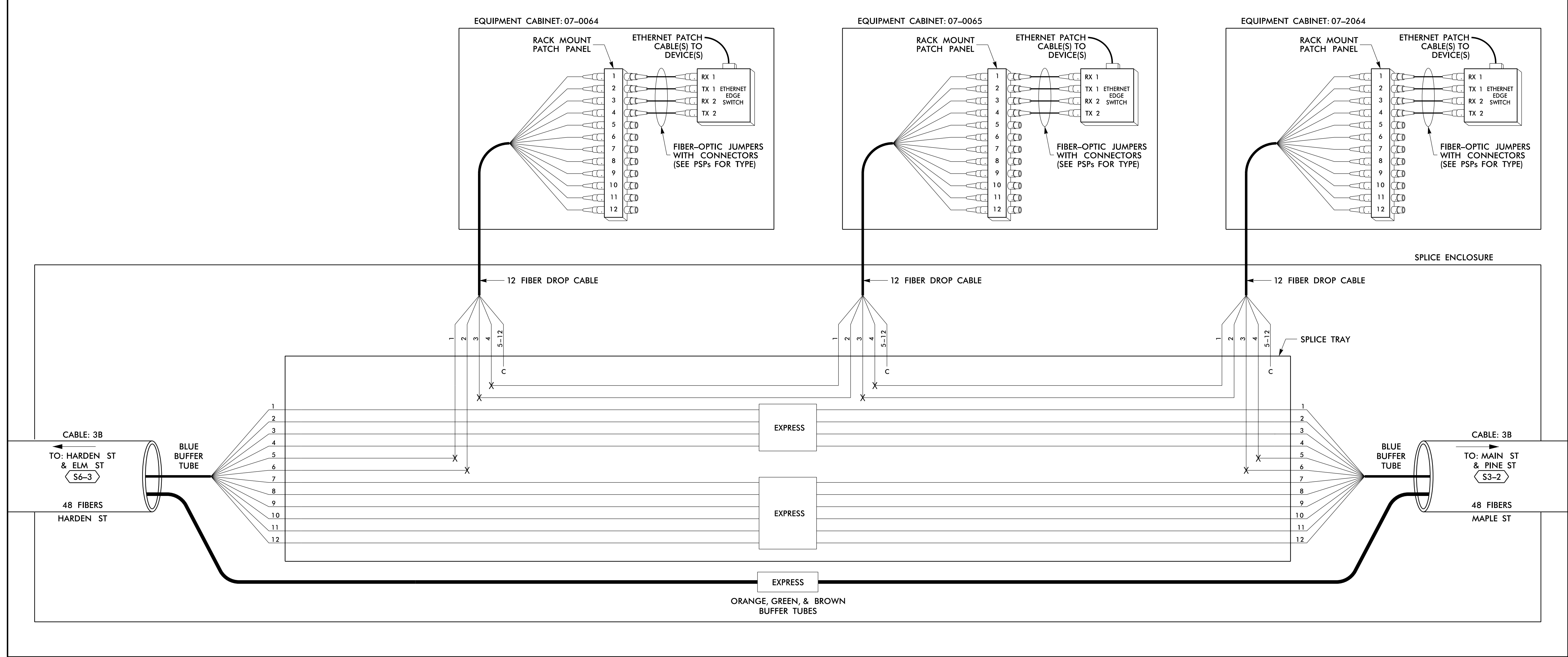

14 JUN 2018 12:11
 D:\Technical\Projects\U-6015 B-C Sig Sys\Task 11_Comm#FS 4.018.dgn
 S:\DCS\653 AT_LUS355433

LEGEND

COLOR CODE TIA/EIA 598-B	X = FUSION SPLICE INDIVIDUAL FIBER	EXPRESS	EXPRESS ENTIRE BUFFER TUBE / FIBERS THROUGH WITHOUT CUTTING
(1) BLUE (7) RED	C = CAP AND SEAL	BUFFER SPLICE	SPLICE ALL FIBERS IN BUFFER TUBE COLOR TO COLOR
(2) ORANGE (8) BLACK		EXISTING	EXISTING BUFFER TUBE / FIBERS DO NOT MODIFY EXISTING SPLICES OR EXPRESSED FIBERS.
(3) GREEN (9) YELLOW			
(4) BROWN (10) VIOLET			
(5) SLATE (11) ROSE			
(6) WHITE (12) AQUA			

- NOTES**
1. UNUSED FIBERS LEFT COILED AND STORED IN SPLICE TRAY
 2. UNUSED BUFFER TUBES LEFT COILED AND STORED IN SPLICE ENCLOSURE
 3. EDGE SWITCH CONFIGURATIONS ARE GENERIC. CONTRACTOR IS RESPONSIBLE FOR DETERMINING/ENSURING THE PROPER TERMINATIONS.

750 Greenfield Parkway, Garner, NC 27529

1616 EAST MILLBROOK ROAD, SUITE 160
 RALEIGH, NORTH CAROLINA 27609
 (919) 876-6888 NCBES #F-0326

**DOCUMENT NOT CONSIDERED FINAL
 UNLESS ALL SIGNATURES COMPLETED**

Prepared for the Offices of:

**Burlington-Graham Signal System
 Fiber-Optic Splicing Details**

Division 7 Alamance County Burlington & Graham

PLAN DATE: June 2018 REVIEWED BY: HA BADGETT

PREPARED BY: BJ SLOCUM REVIEWED BY: DL JONES

REVISIONS	INIT.	DATE

SCALE: N/A

SEAL
 NORTH CAROLINA PROFESSIONAL ENGINEER
 SEAL 040877
 BRADFORD J. SLOCUM
 15/2018
 DATE

CADD File name: FS 4.018.dgn

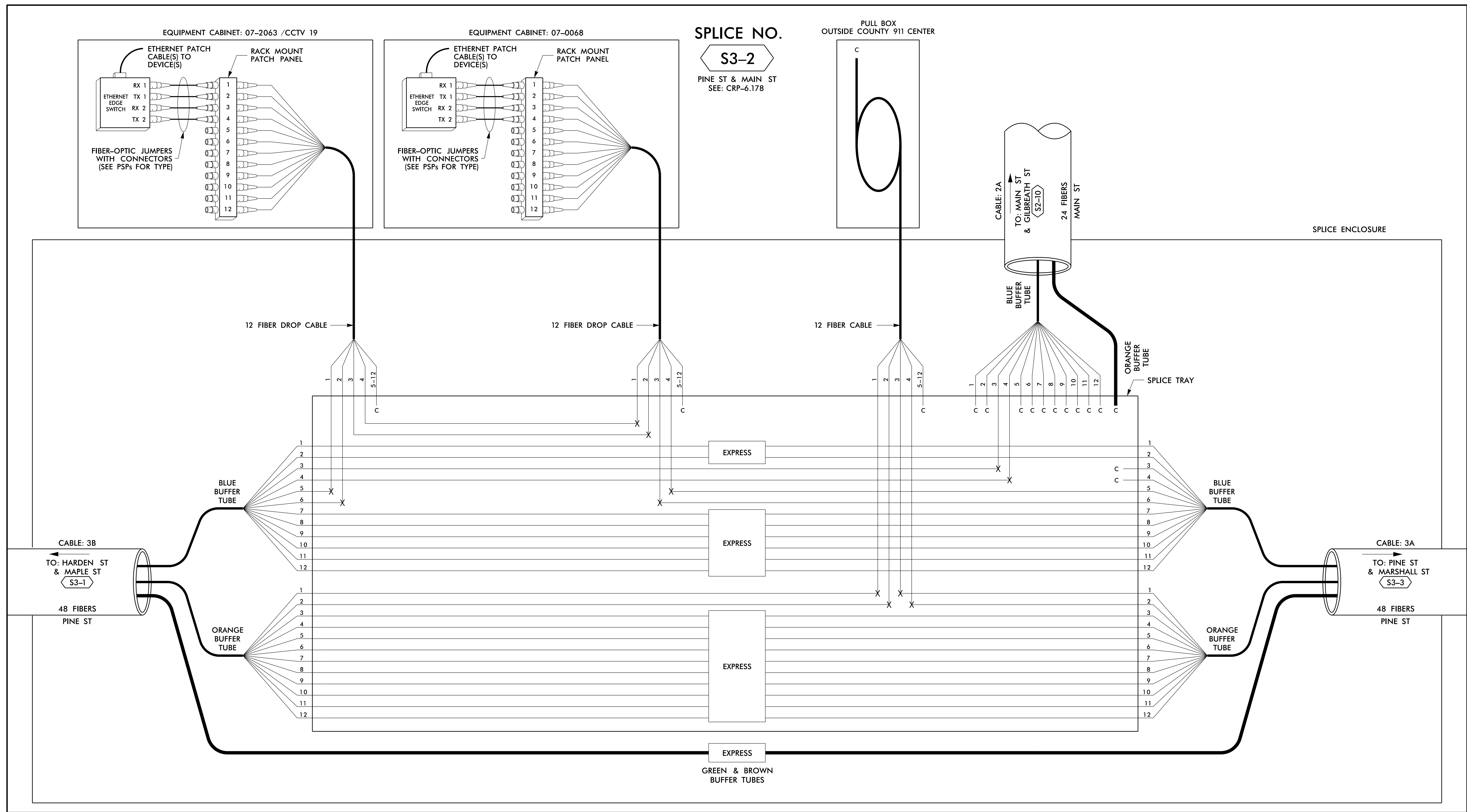

SPLICE NO.
S3-2
 PINE ST & MAIN ST
 SEE: CRP-6.178

SPLICE ENCLOSURE

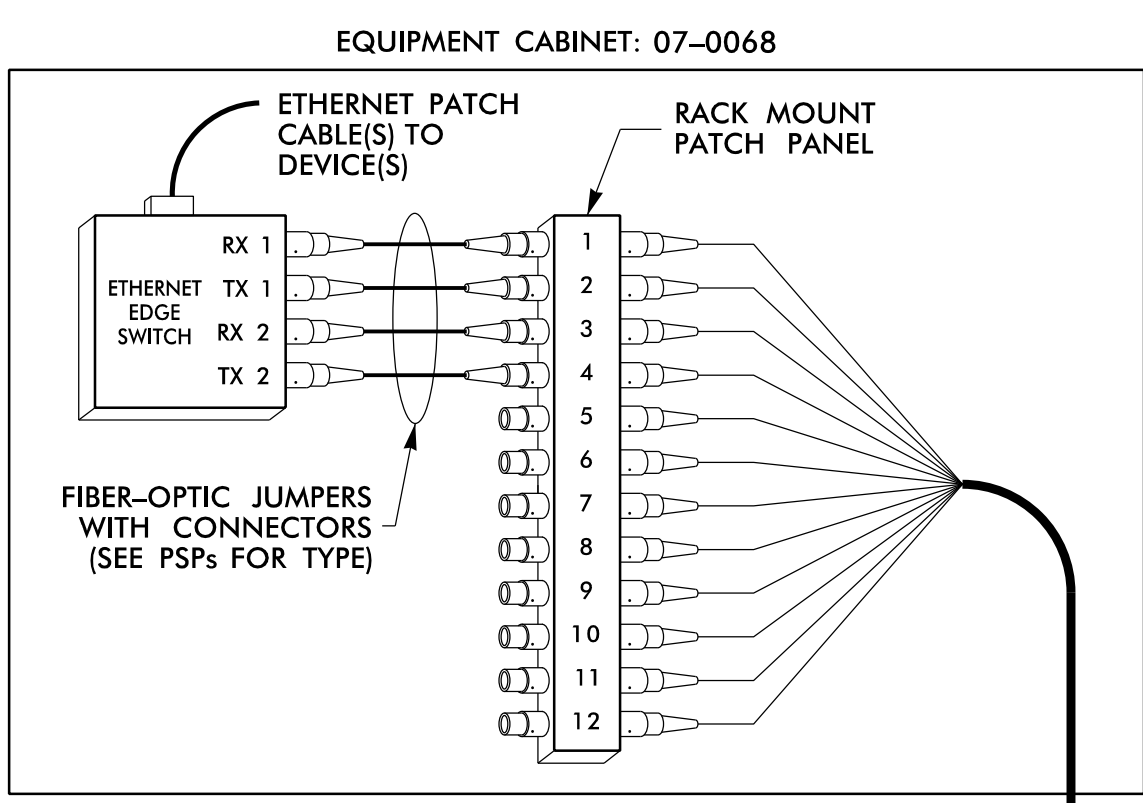
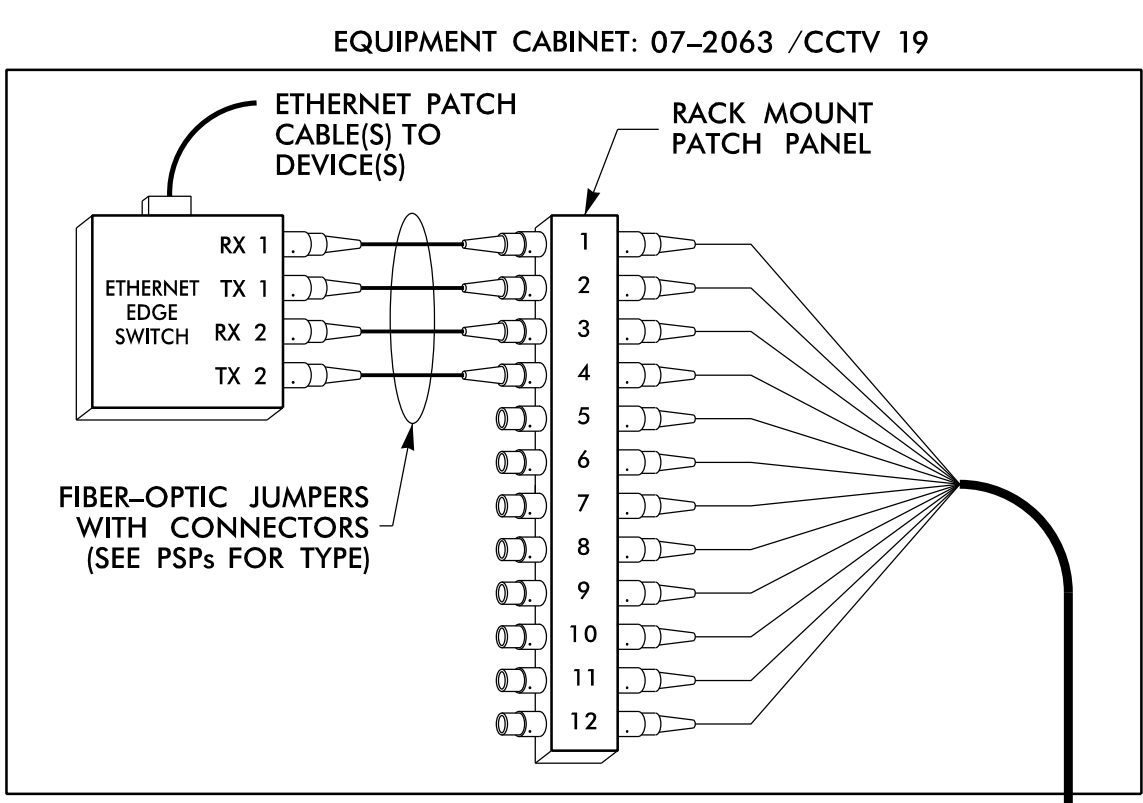

PULL BOX
 OUTSIDE COUNTY 911 CENTER

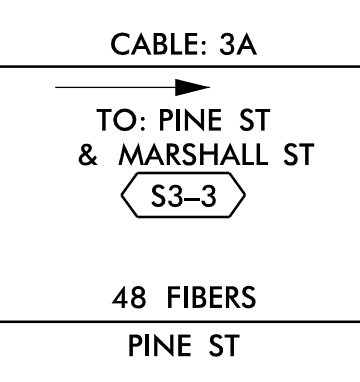
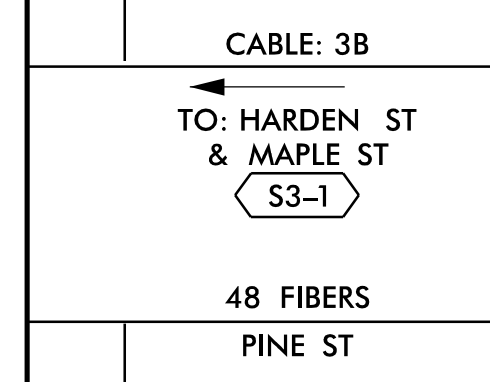
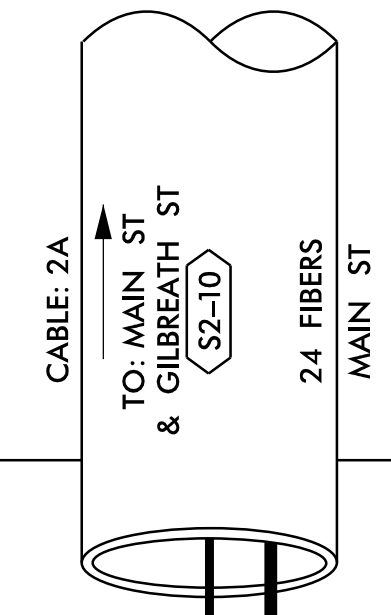

LEGEND

EXPRESS	EXPRESS ENTIRE BUFFER TUBE /FIBERS THROUGH WITHOUT CUTTING
BUFFER SPLICE	SPLICE ALL FIBERS IN BUFFER TUBE COLOR TO COLOR
EXISTING	EXISTING BUFFER TUBE /FIBERS DO NOT MODIFY EXISTING SPLICES OR EXPRESSED FIBERS.

X = FUSION SPLICE INDIVIDUAL FIBER
 C = CAP AND SEAL

COLOR CODE
 TIA/EIA 598-B

(1) BLUE	(7) RED
(2) ORANGE	(8) BLACK
(3) GREEN	(9) YELLOW
(4) BROWN	(10) VIOLET
(5) SLATE	(11) ROSE
(6) WHITE	(12) AQUA

- NOTES**
- UNUSED FIBERS LEFT COILED AND STORED IN SPLICE TRAY
 - UNUSED BUFFER TUBES LEFT COILED AND STORED IN SPLICE ENCLOSURE
 - EDGE SWITCH CONFIGURATIONS ARE GENERIC. CONTRACTOR IS RESPONSIBLE FOR DETERMINING/ENSURING THE PROPER TERMINATIONS.

ATKINS 1616 EAST MILLBROOK ROAD, SUITE 160
 RALEIGH, NORTH CAROLINA 27609
 (919) 876-6888 NCBEEES #F-0326

DOCUMENT NOT CONSIDERED FINAL
 UNLESS ALL SIGNATURES COMPLETED

	Prepared for the Offices of: Burlington-Graham Signal System Fiber-Optic Splicing Details			
	Division 7	Alamance County		Burlington & Graham
	PLAN DATE: June 2018	REVIEWED BY: HA BADGETT		
	PREPARED BY: BJ SLOCUM	REVIEWED BY: DL JONES		
SCALE: N/A	REVISIONS	INIT.	DATE	

CADD File name: FS 4.019.dgn

14 JUN 2018 12:12
 D:\projects\atkins\11\comms\11_00056469 U-6015 B-C Sig_Sys\Task 11_Comms\F S 4.019.dgn
 S:\03563 AT_LUS355433

SPLICE NO.
S3-3

PINE ST & MARSHALL ST
 SEE: CRP-6.180

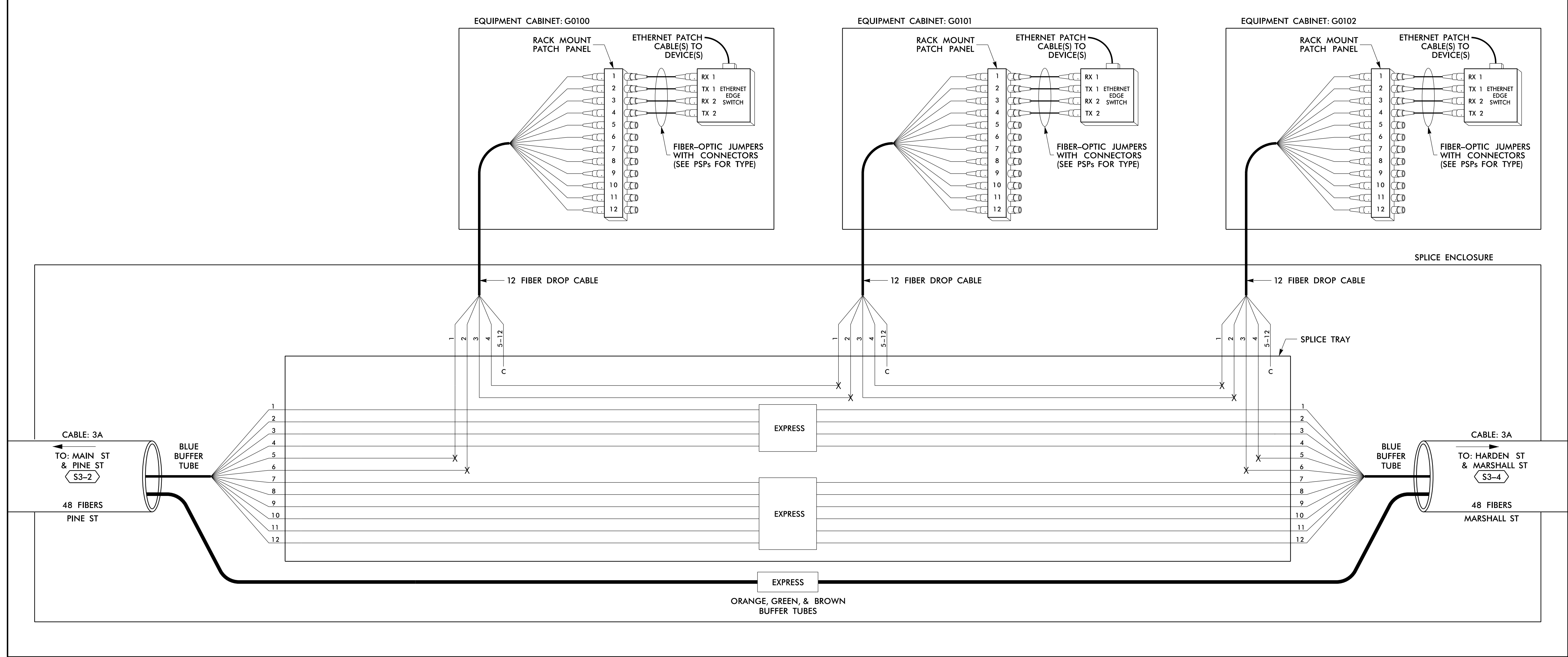

LEGEND

COLOR CODE TIA/EIA 598-B		X = FUSION SPLICE INDIVIDUAL FIBER	EXPRESS	EXPRESS ENTIRE BUFFER TUBE / FIBERS THROUGH WITHOUT CUTTING
(1) BLUE	(7) RED	C = CAP AND SEAL	BUFFER SPLICE	SPLICE ALL FIBERS IN BUFFER TUBE COLOR TO COLOR
(2) ORANGE	(8) BLACK		EXISTING	EXISTING BUFFER TUBE / FIBERS DO NOT MODIFY EXISTING SPLICES OR EXPRESSED FIBERS.
(3) GREEN	(9) YELLOW			
(4) BROWN	(10) VIOLET			
(5) SLATE	(11) ROSE			
(6) WHITE	(12) AQUA			

NOTES

1. UNUSED FIBERS LEFT COILED AND STORED IN SPLICE TRAY
2. UNUSED BUFFER TUBES LEFT COILED AND STORED IN SPLICE ENCLOSURE
3. EDGE SWITCH CONFIGURATIONS ARE GENERIC. CONTRACTOR IS RESPONSIBLE FOR DETERMINING/ENSURING THE PROPER TERMINATIONS.

ATKINS 1616 EAST MILLBROOK ROAD, SUITE 160
 RALEIGH, NORTH CAROLINA 27609
 (919) 876-6888 NCBEEES #F-0326

DOCUMENT NOT CONSIDERED FINAL
 UNLESS ALL SIGNATURES COMPLETED

	Prepared for the Offices of: NORTH CAROLINA DEPARTMENT OF TRANSPORTATION		SEAL NORTH CAROLINA PROFESSIONAL ENGINEER SEAL 040877 BRADFORD J. SLOCUM ENGINEER 15/2018
	Burlington-Graham Signal System Fiber-Optic Splicing Details		
Division 7 Alamance County Burlington & Graham	PLAN DATE: June 2018	REVIEWED BY: HA BADGETT	DATE
PREPARED BY: BJ SLOCUM	REVIEWED BY: DL JONES	DATE	
SCALE: N/A	REVISIONS	INIT.	DATE

14-JUN-2018 12:12
 D:\projects\atkins\proj\off\c\cur\100056469 U-6015 B-C Sig_Sys\Task 11_Comms\F S 4_020.dgn
 S:\DCS\653 AT_LUS355433

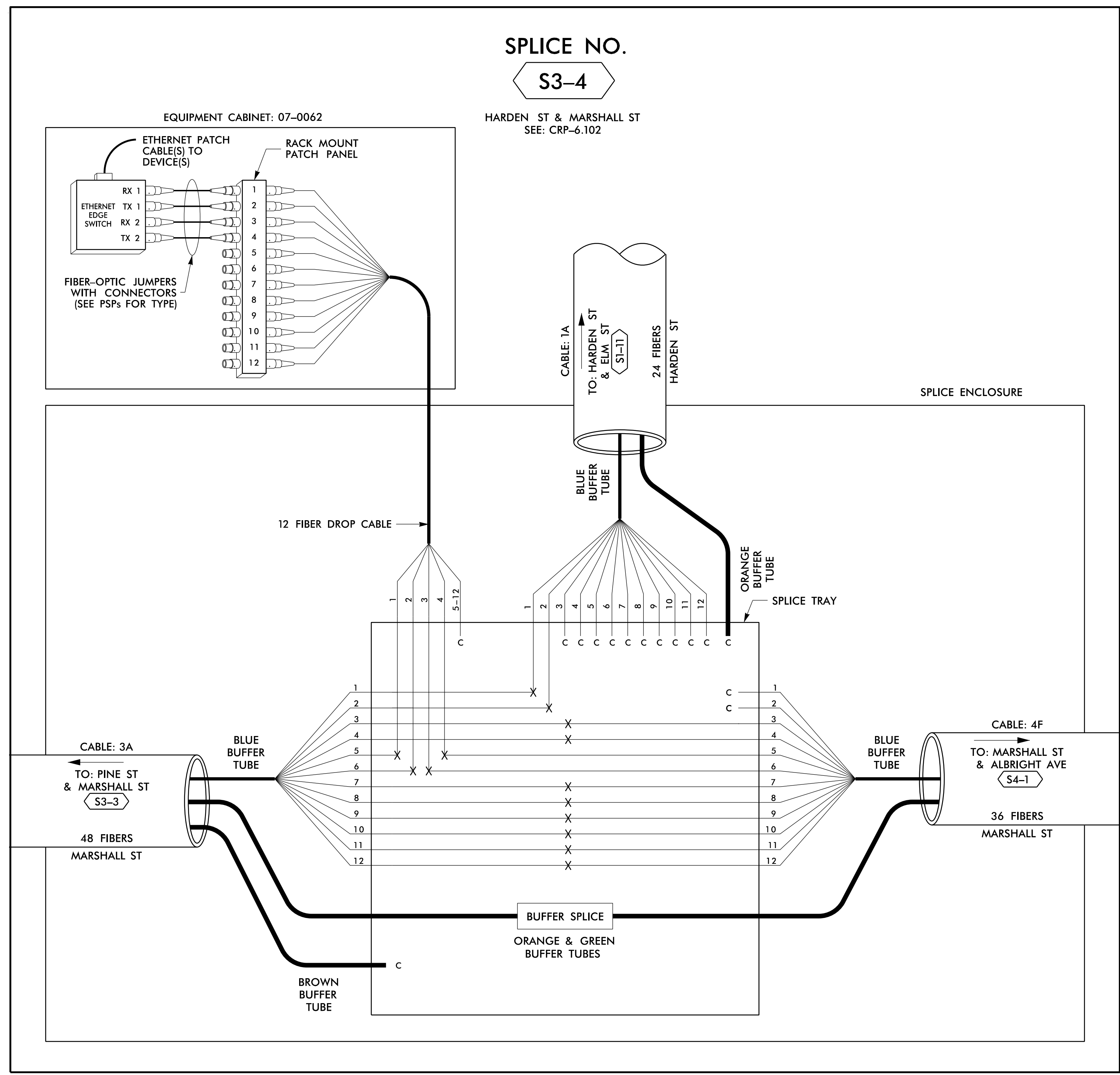

SPLICE NO.
S3-4

HARDEN ST & MARSHALL ST
SEE: CRP-6.102

EQUIPMENT CABINET: 07-0062

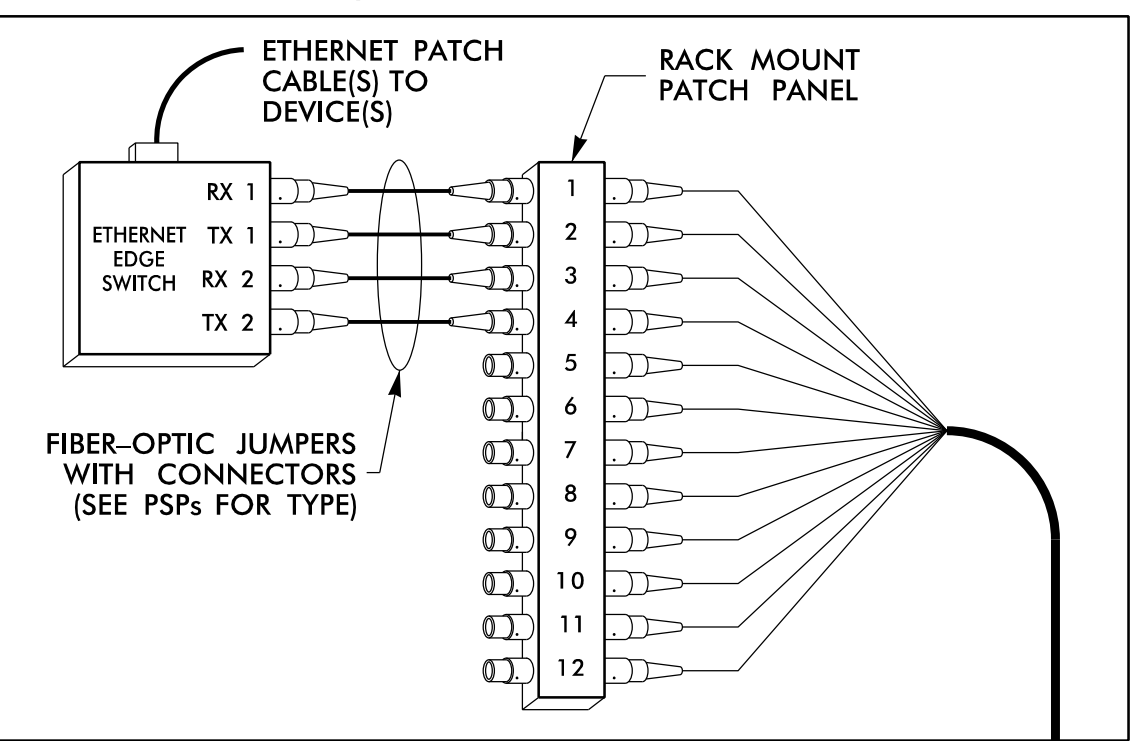

SPLICE ENCLOSURE

12 FIBER DROP CABLE

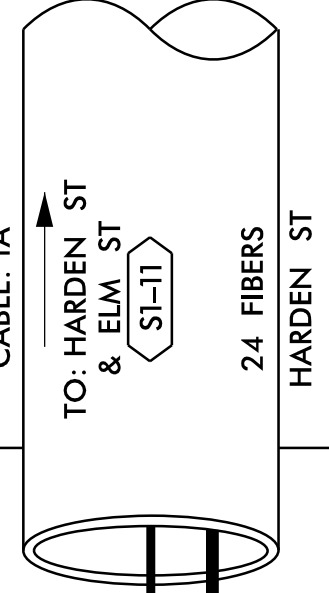

CABLE: 3A
TO: PINE ST & MARSHALL ST
S3-3
48 FIBERS
MARSHALL ST

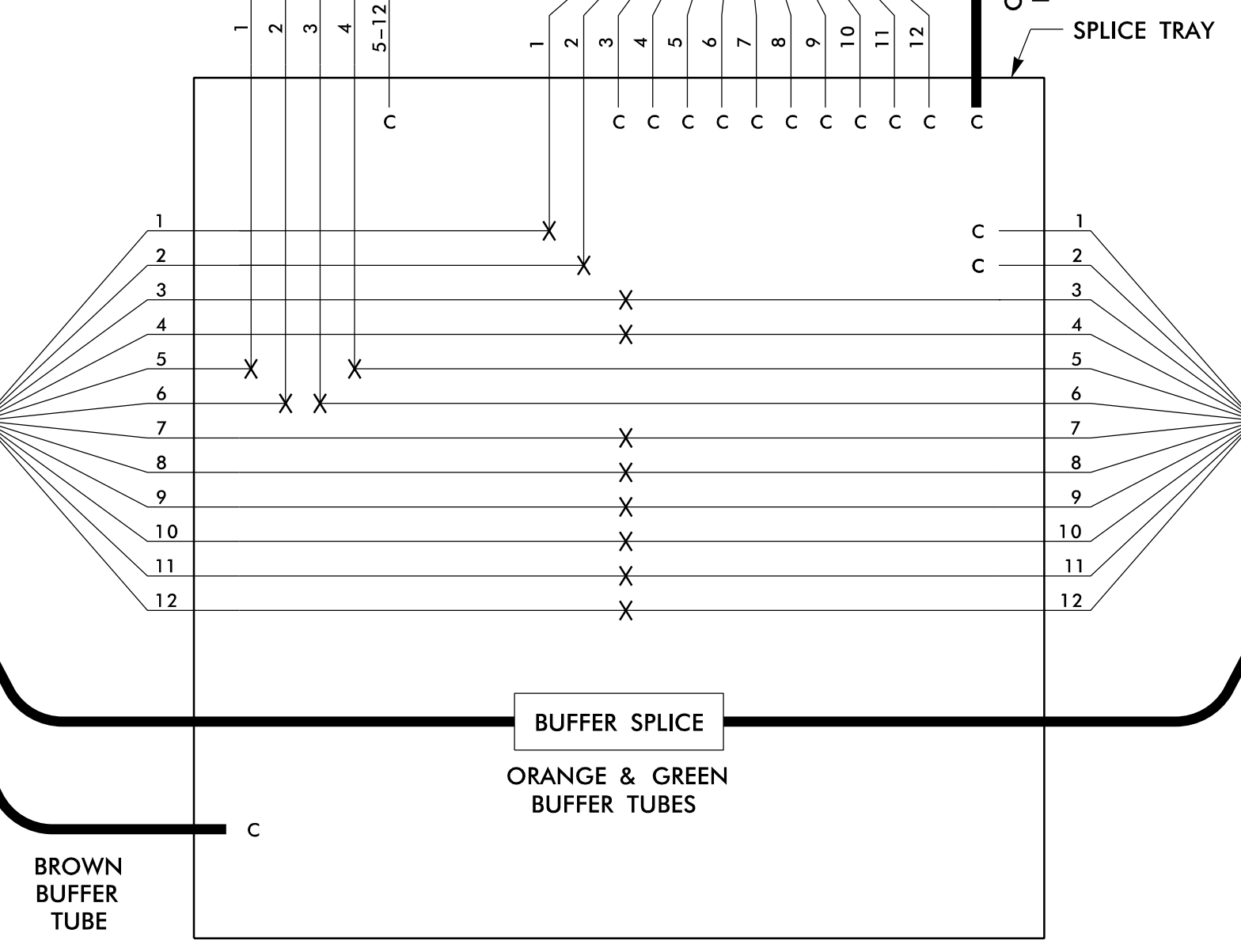
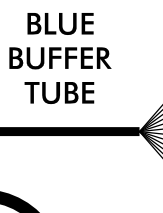

BUFFER SPLICE
ORANGE & GREEN
BUFFER TUBES

CABLE: 4F
TO: MARSHALL ST & ALBRIGHT AVE
S4-1
36 FIBERS
MARSHALL ST

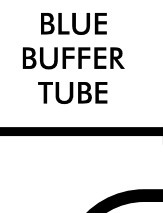

LEGEND

COLOR CODE TIA/EIA 598-B		X = FUSION SPLICE INDIVIDUAL FIBER	
(1) BLUE	(7) RED	EXPRESS ENTIRE BUFFER TUBE / FIBERS THROUGH WITHOUT CUTTING	
(2) ORANGE	(8) BLACK	C = CAP AND SEAL	
(3) GREEN	(9) YELLOW	EXPRESS	
(4) BROWN	(10) VIOLET	BUFFER SPLICE	
(5) SLATE	(11) ROSE	EXISTING	
(6) WHITE	(12) AQUA	SPLICE ALL FIBERS IN BUFFER TUBE COLOR TO COLOR	
		EXISTING BUFFER TUBE / FIBERS DO NOT MODIFY EXISTING SPLICES OR EXPRESSED FIBERS.	

NOTES

- UNUSED FIBERS LEFT COILED AND STORED IN SPLICE TRAY
- UNUSED BUFFER TUBES LEFT COILED AND STORED IN SPLICE ENCLOSURE
- EDGE SWITCH CONFIGURATIONS ARE GENERIC. CONTRACTOR IS RESPONSIBLE FOR DETERMINING/ENSURING THE PROPER TERMINATIONS.

ATKINS 1616 EAST MILLBROOK ROAD, SUITE 160
RALEIGH, NORTH CAROLINA 27609
(919) 876-6888 NCBEE# F-0326

DOCUMENT NOT CONSIDERED FINAL
UNLESS ALL SIGNATURES COMPLETED

Prepared for the Offices of:

750 Greenfield Parkway, Garner, NC 27529
SCALE: N/A

Burlington-Graham Signal System Fiber-Optic Splicing Details		Burlington & Graham	
Division 7	Alamance County		
PLAN DATE: June 2018	REVIEWED BY: HA BADGETT		
PREPARED BY: BJ SLOCUM	REVIEWED BY: DL JONES		
REVISIONS	INIT.	DATE	

SEAL

BRADFORD J. SLOCUM
 ENGINEER
 15/2018
 DATE

14 JUN 2018 12:13
 D:\Projects\Burlington-Graham Signal System\Task 11_Comms\F_S 4_021.dgn
 S:\DCS\653 AT_LUS355433

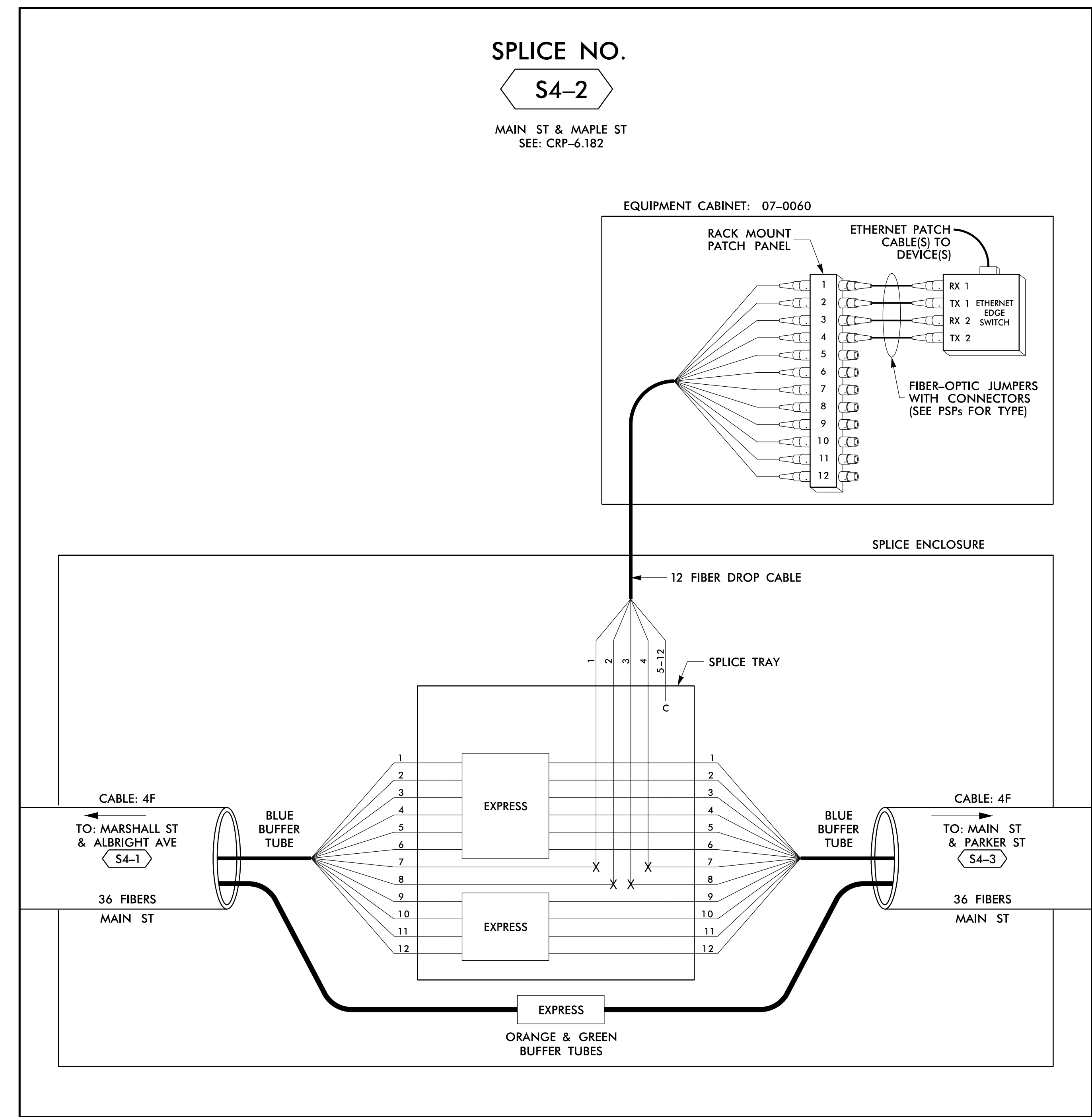
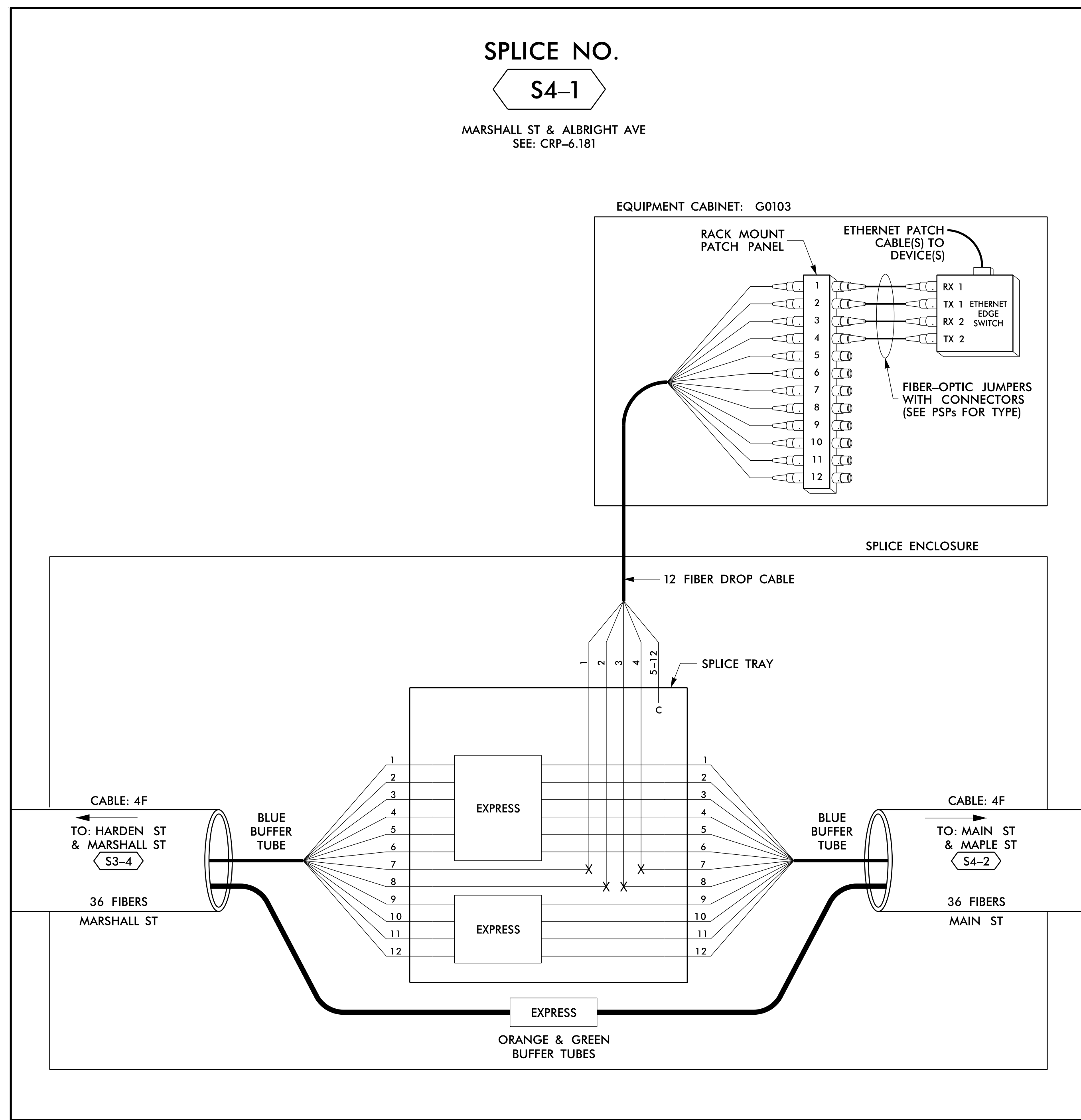

14-JUN-2018 12:13
 D:\projects\atkins\11-Corridor\11-Corridor\11-Corridor.dgn
 S:\projects\atkins\11-Corridor\11-Corridor\11-Corridor.dgn

LEGEND

X = FUSION SPlice INDIVIDUAL FIBER C = CAP AND SEAL	
(1) BLUE (2) ORANGE (3) GREEN (4) BROWN (5) SLATE (6) WHITE	(7) RED (8) BLACK (9) YELLOW (10) VIOLET (11) ROSE (12) AQUA
EXPRESS BUFFER SPlice EXISTING	EXPRESS ENTIRE BUFFER TUBE / FIBERS THROUGH WITHOUT CUTTING SPlice ALL FIBERS IN BUFFER TUBE COLOR TO COLOR EXISTING BUFFER TUBE / FIBERS DO NOT MODIFY EXISTING SPlices OR EXPRESSED FIBERS.

- #### NOTES
- UNUSED FIBERS LEFT COILED AND STORED IN SPLICE TRAY
 - UNUSED BUFFER TUBES LEFT COILED AND STORED IN SPLICE ENCLOSURE
 - EDGE SWITCH CONFIGURATIONS ARE GENERIC. CONTRACTOR IS RESPONSIBLE FOR DETERMINING/ENSURING THE PROPER TERMINATIONS.

ATKINS 1616 EAST MILLBROOK ROAD, SUITE 160
 RALEIGH, NORTH CAROLINA 27609
 (919) 876-6888 NCBES #F-0326

	Prepared for the Offices of: Burlington-Graham Signal System Fiber-Optic Splicing Details		SEAL NORTH CAROLINA PROFESSIONAL SEAL 040877 ENGINEER Bradford J. Slocum
	Division 7 Alamance County Burlington & Graham		
	PLAN DATE: June 2018 PREPARED BY: BJ SLOCUM	REVIEWED BY: HA BADGETT REVIEWED BY: DL JONES	
SCALE: N/A		REVISIONS: _____ INIT. DATE _____	

DOCUMENT NOT CONSIDERED FINAL UNLESS ALL SIGNATURES COMPLETED
 CADD File name: FS_4.022.dgn

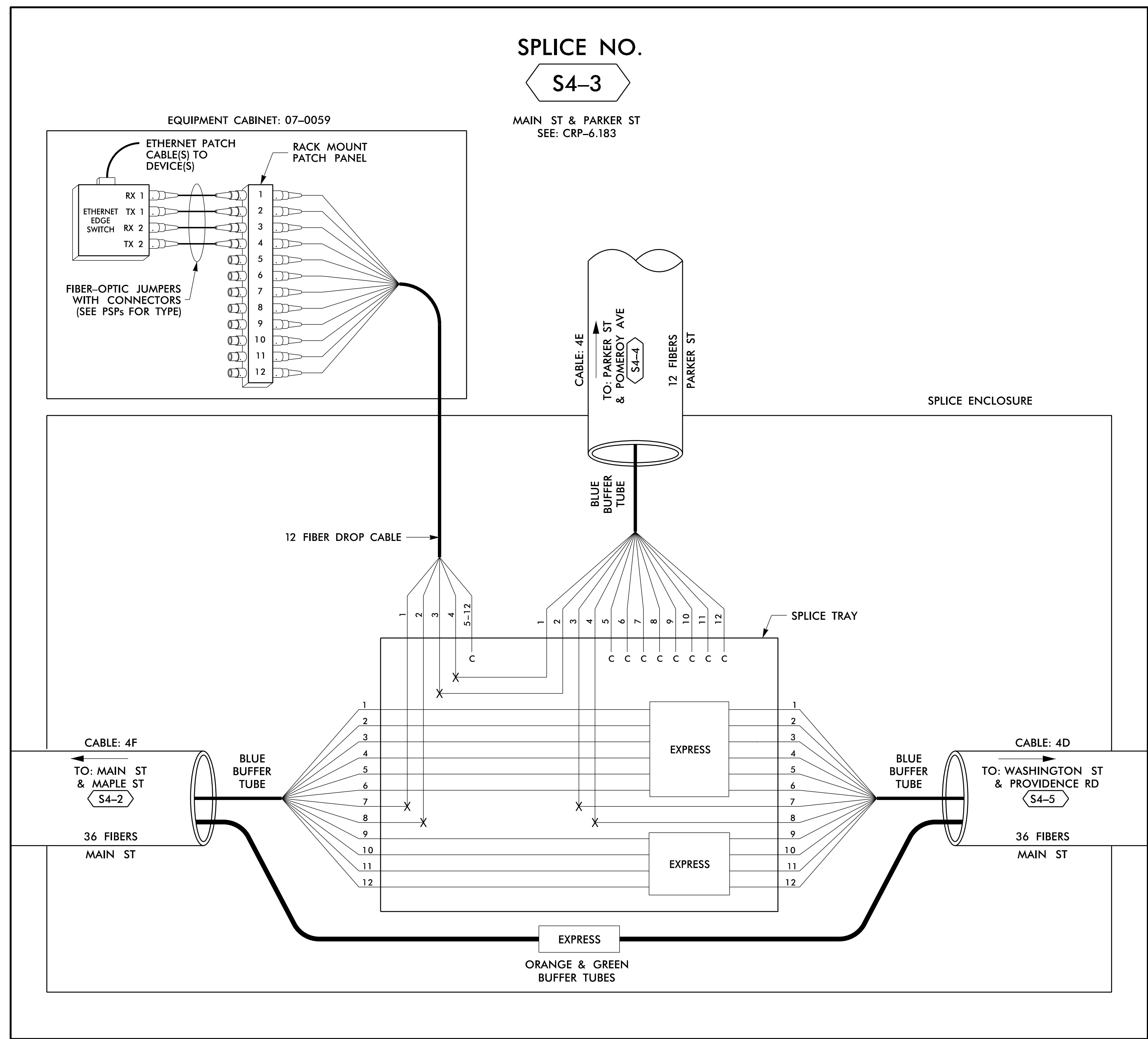

14 JUN 2018 12:14
 D:\Technical\Projects\U-6015 B-C Sig Sys\Task 11_Coms\F4_023.dgn
 S:\DCS\653 AT_LUS355433

COLOR CODE		LEGEND	
(1) BLUE	(7) RED	EXPRESS	EXPRESS ENTIRE BUFFER TUBE / FIBERS THROUGH WITHOUT CUTTING
(2) ORANGE	(8) BLACK	BUFFER SPLICE	SPLICE ALL FIBERS IN BUFFER TUBE COLOR TO COLOR
(3) GREEN	(9) YELLOW	EXISTING	EXISTING BUFFER TUBE / FIBERS DO NOT MODIFY EXISTING SPLICES OR EXPRESSED FIBERS.
(4) BROWN	(10) VIOLET		
(5) SLATE	(11) ROSE		
(6) WHITE	(12) AQUA		

- NOTES**
- UNUSED FIBERS LEFT COILED AND STORED IN SPLICE TRAY
 - UNUSED BUFFER TUBES LEFT COILED AND STORED IN SPLICE ENCLOSURE
 - EDGE SWITCH CONFIGURATIONS ARE GENERIC. CONTRACTOR IS RESPONSIBLE FOR DETERMINING/ENSURING THE PROPER TERMINATIONS.

ATKINS
 1616 EAST MILLBROOK ROAD, SUITE 160
 RALEIGH, NORTH CAROLINA 27609
 (919) 876-6888 NCBEE #F-0326

DOCUMENT NOT CONSIDERED FINAL UNLESS ALL SIGNATURES COMPLETED

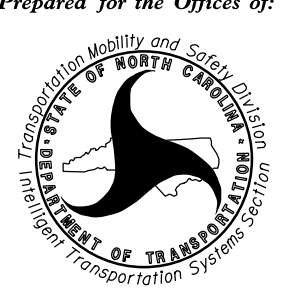
Prepared for the Offices of:  NORTH CAROLINA DEPARTMENT OF TRANSPORTATION		SEAL NORTH CAROLINA PROFESSIONAL ENGINEER SEAL 040877 BRADFORD J. SLOCUM ENGINEER 15/2018 DATE	
Burlington-Graham Signal System Fiber-Optic Splicing Details			
Division 7 Alamance County Burlington & Graham		PLAN DATE: June 2018 REVIEWED BY: HA BADGETT	
PREPARED BY: BJ SLOCUM		REVIEWED BY: DL JONES	
SCALE: N/A		REVISIONS: INIT. DATE	
CADD File name: FS_4.023.dgn			

SPLICE NO.

S4-4

PARKER ST & POMEROY AVE
SEE: CRP-6.194

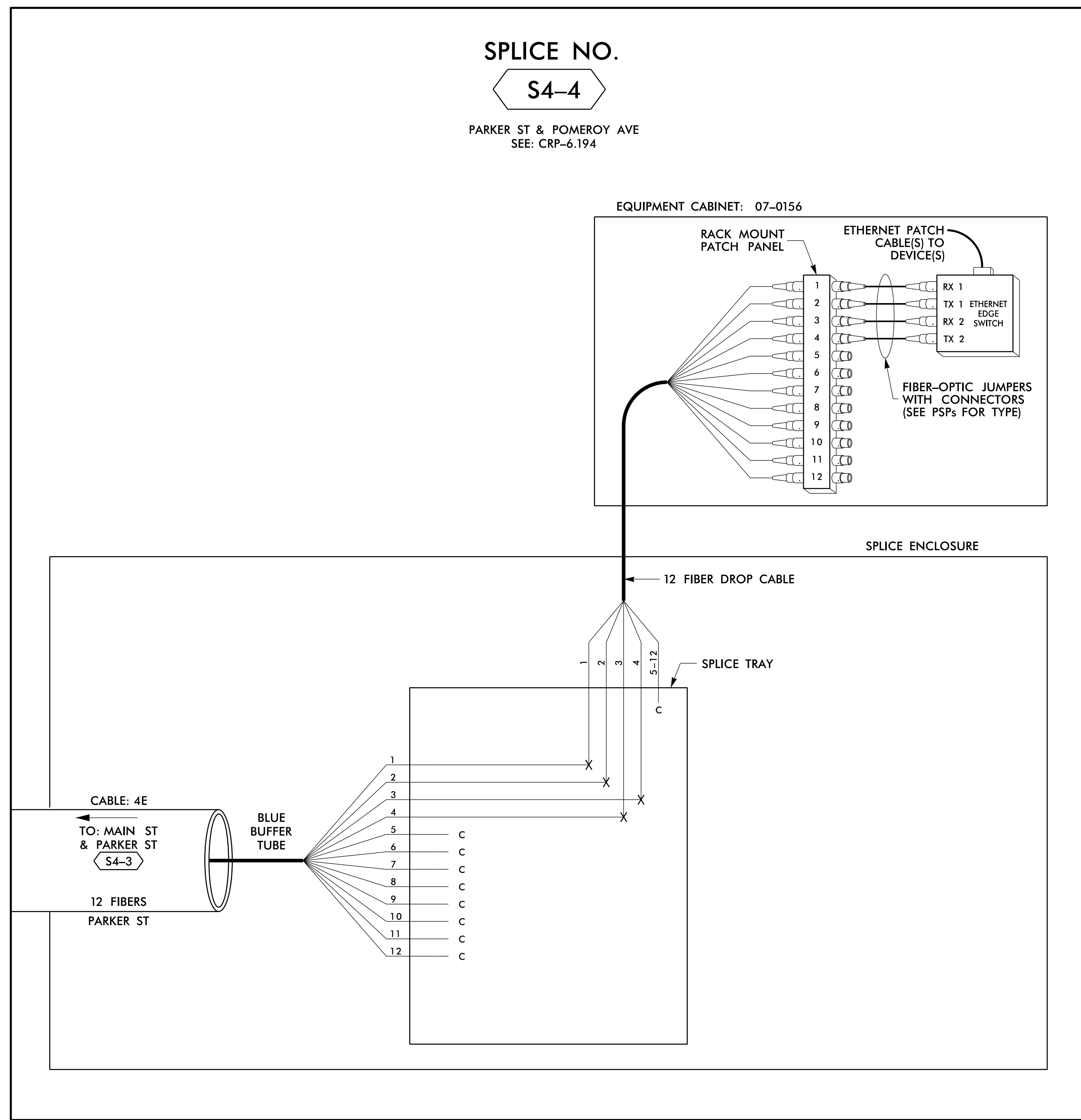

SPLICE NO.

S4-5

WASHINGTON ST & PROVIDENCE RD
SEE: CRP-6.184

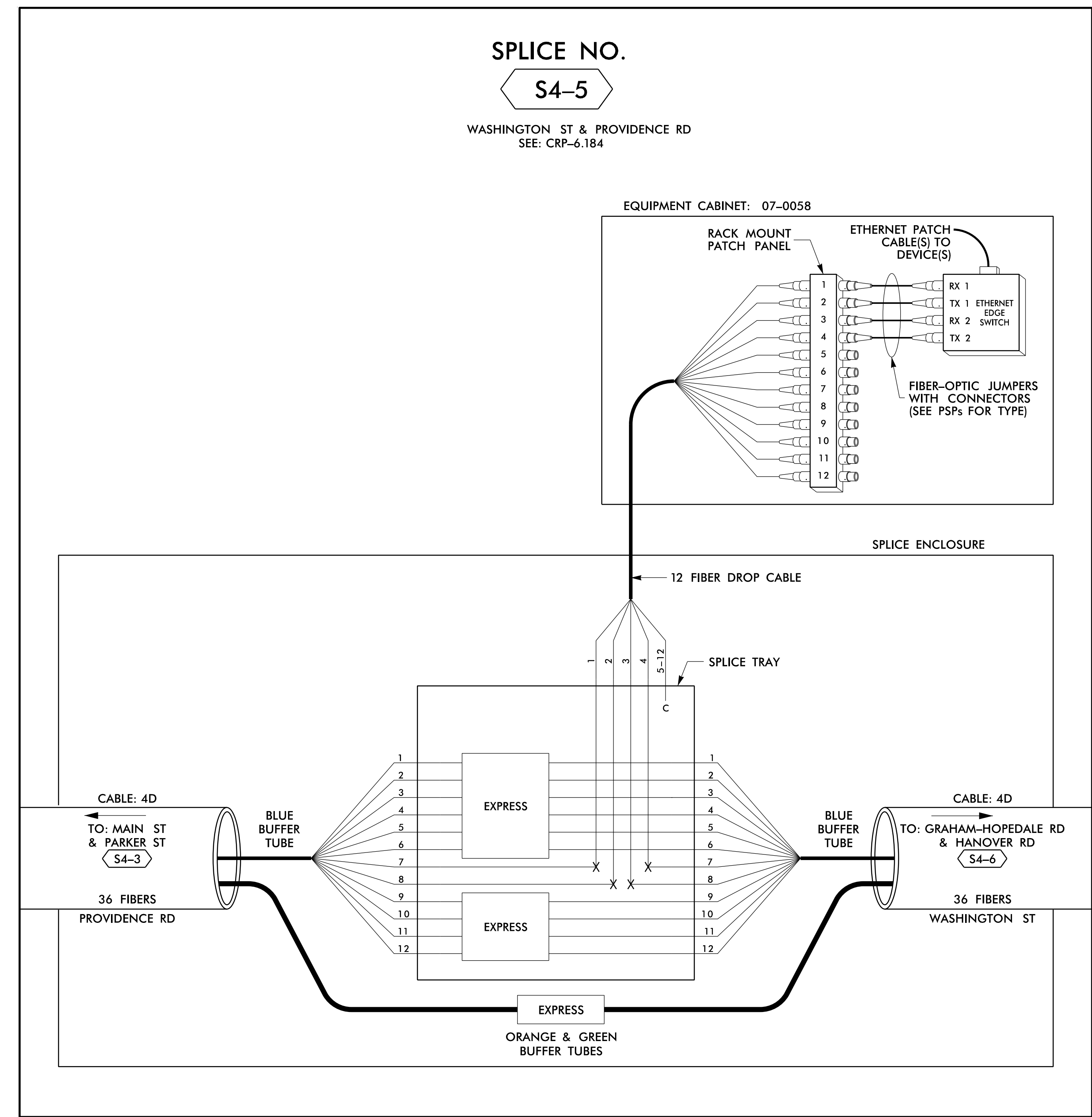

14 JUN 2018 12:14
 D:\projects\proj\11\comms\11_Coms\Fs 4.024.dgn
 0:\work\proj\11\comms\11_Coms\Fs 4.024.dgn
 S:\033633 AT LUS355433

LEGEND

COLOR CODE TIA/EIA 598-B		X = FUSION SPlice INDIVIDUAL FIBER C = CAP AND SEAL
(1) BLUE	(7) RED	EXPRESS
(2) ORANGE	(8) BLACK	EXPRESS ENTIRE BUFFER TUBE / FIBERS THROUGH WITHOUT CUTTING
(3) GREEN	(9) YELLOW	BUFFER SPlice
(4) BROWN	(10) VIOLET	SPlice ALL FIBERS IN BUFFER TUBE COLOR TO COLOR
(5) SLATE	(11) ROSE	EXISTING
(6) WHITE	(12) AQUA	EXISTING BUFFER TUBE / FIBERS DO NOT MODIFY EXISTING SPlices OR EXPRESSED FIBERS.

NOTES

1. UNUSED FIBERS LEFT COILED AND STORED IN SPLICE TRAY
2. UNUSED BUFFER TUBES LEFT COILED AND STORED IN SPLICE ENCLOSURE
3. EDGE SWITCH CONFIGURATIONS ARE GENERIC. CONTRACTOR IS RESPONSIBLE FOR DETERMINING/ENSURING THE PROPER TERMINATIONS.

ATKINS 1616 EAST MILLBROOK ROAD, SUITE 160
RALEIGH, NORTH CAROLINA 27609
(919) 876-6888 NCBEEs #F-0326

DOCUMENT NOT CONSIDERED FINAL UNLESS ALL SIGNATURES COMPLETED

Prepared for the Offices of:  750 Greenfield Parkway, Garner, NC 27529	Burlington-Graham Signal System Fiber-Optic Splicing Details		SEAL NORTH CAROLINA PROFESSIONAL ENGINEER SEAL 040877 BRADFORD J. SLOCUM 15/2018 DATE
	Division 7 Alamance County PLAN DATE: June 2018 PREPARED BY: BJ SLOCUM	Burlington & Graham REVIEWED BY: HA BADGETT REVIEWED BY: DL JONES	

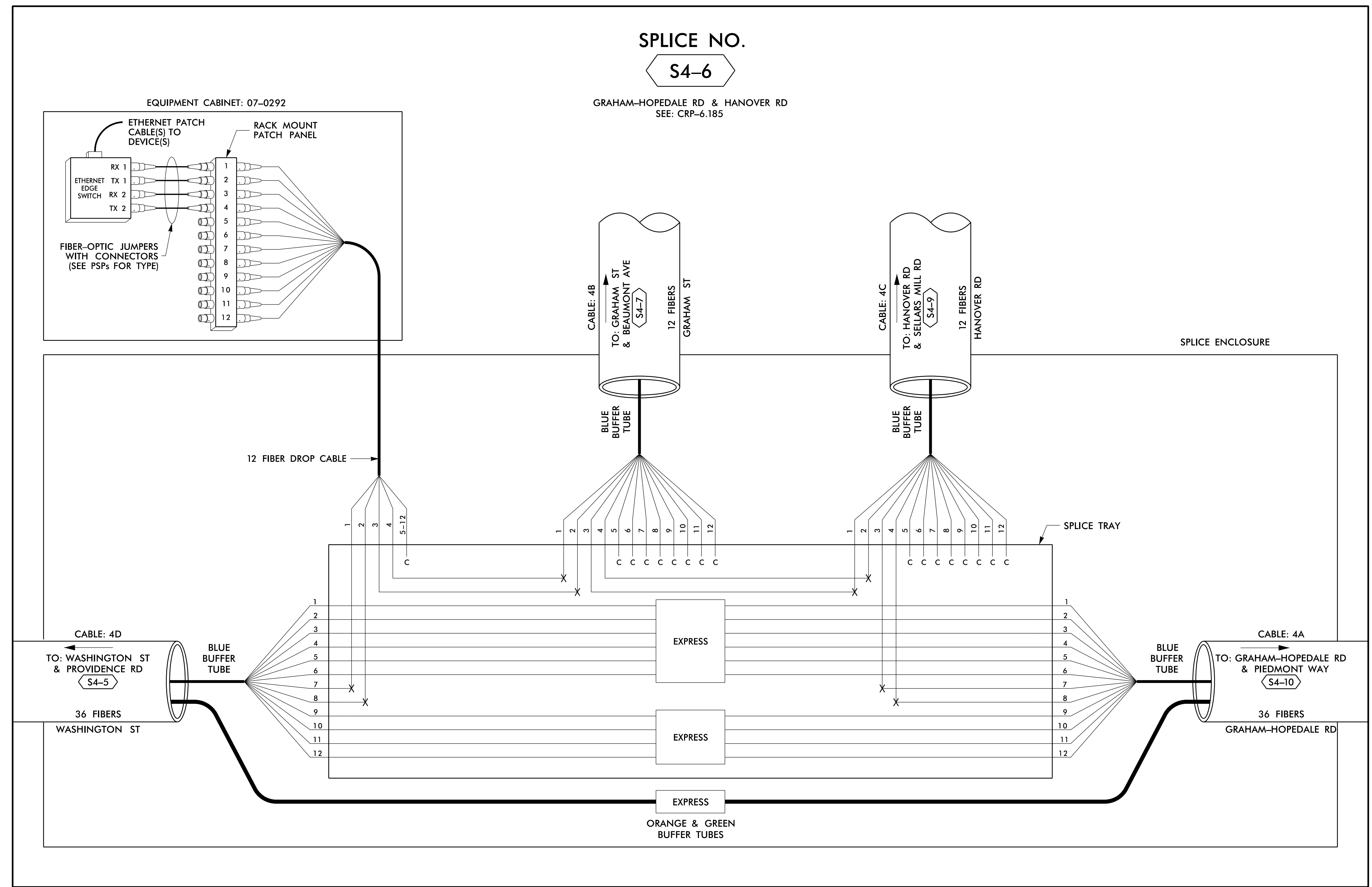

14 JUN 2018 12:15
 D:\projects\proj\11\11_00056469 U-6015 B-C Sig_Sys\Task 11_Corrs\F4_025.dgn
 S:\035633 AT_LUS355433

COLOR CODE		LEGEND	
(1) BLUE	(7) RED	EXPRESS	EXPRESS ENTIRE BUFFER TUBE / FIBERS THROUGH WITHOUT CUTTING
(2) ORANGE	(8) BLACK	BUFFER SPLICE	SPLICE ALL FIBERS IN BUFFER TUBE COLOR TO COLOR
(3) GREEN	(9) YELLOW	EXISTING	EXISTING BUFFER TUBE / FIBERS DO NOT MODIFY EXISTING SPLICES OR EXPRESSED FIBERS.
(4) BROWN	(10) VIOLET		
(5) SLATE	(11) ROSE		
(6) WHITE	(12) AQUA		

- NOTES**
- UNUSED FIBERS LEFT COILED AND STORED IN SPLICE TRAY
 - UNUSED BUFFER TUBES LEFT COILED AND STORED IN SPLICE ENCLOSURE
 - EDGE SWITCH CONFIGURATIONS ARE GENERIC. CONTRACTOR IS RESPONSIBLE FOR DETERMINING/ENSURING THE PROPER TERMINATIONS.

ATKINS

750 Greenfield Parkway, Garner, NC 27529

SCALE: N/A

1616 EAST MILLBROOK ROAD, SUITE 160
 RALEIGH, NORTH CAROLINA 27609
 (919) 876-6888 NCBEEES #F-0326

Burlington-Graham Signal System
Fiber-Optic Splicing Details

Division 7 Alamance County Burlington & Graham

PLAN DATE: June 2018 REVIEWED BY: HA BADGETT

PREPARED BY: BJ SLOCUM REVIEWED BY: DL JONES

REVISIONS	INIT.	DATE

DOCUMENT NOT CONSIDERED FINAL
UNLESS ALL SIGNATURES COMPLETED

SEAL
 NORTH CAROLINA PROFESSIONAL ENGINEER
 SEAL 040877
 BRADFORD J. SLOCUM
 15/2018
 DATE

CADD Filename: FS_4.025.dgn

SPLICE NO.

S4-7

GRAHAM ST & BEAUMONT AVE
SEE: CRP-6.191

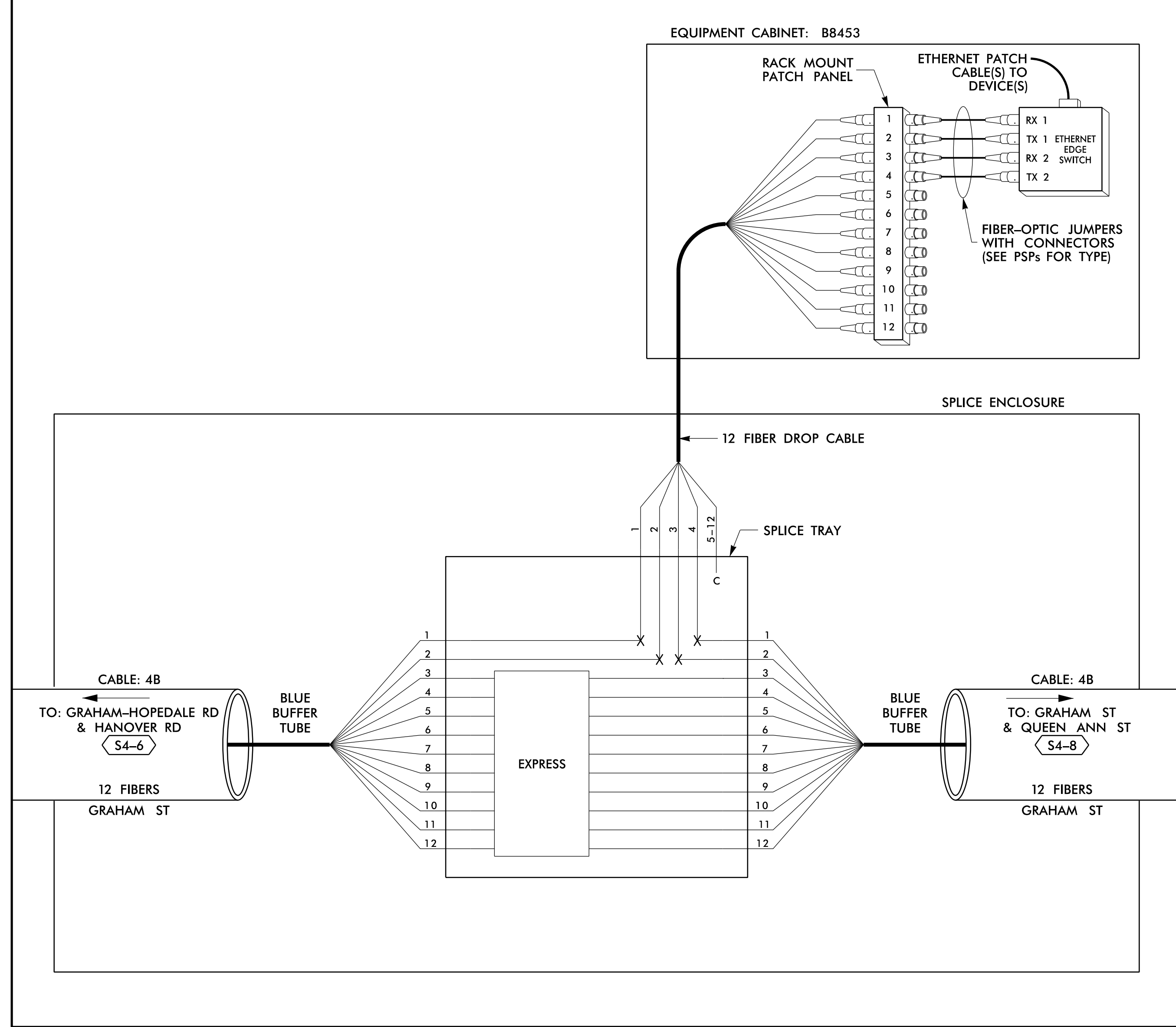

SPLICE NO.

S4-8

GRAHAM ST & QUEEN ANN ST
SEE: CRP-6.190

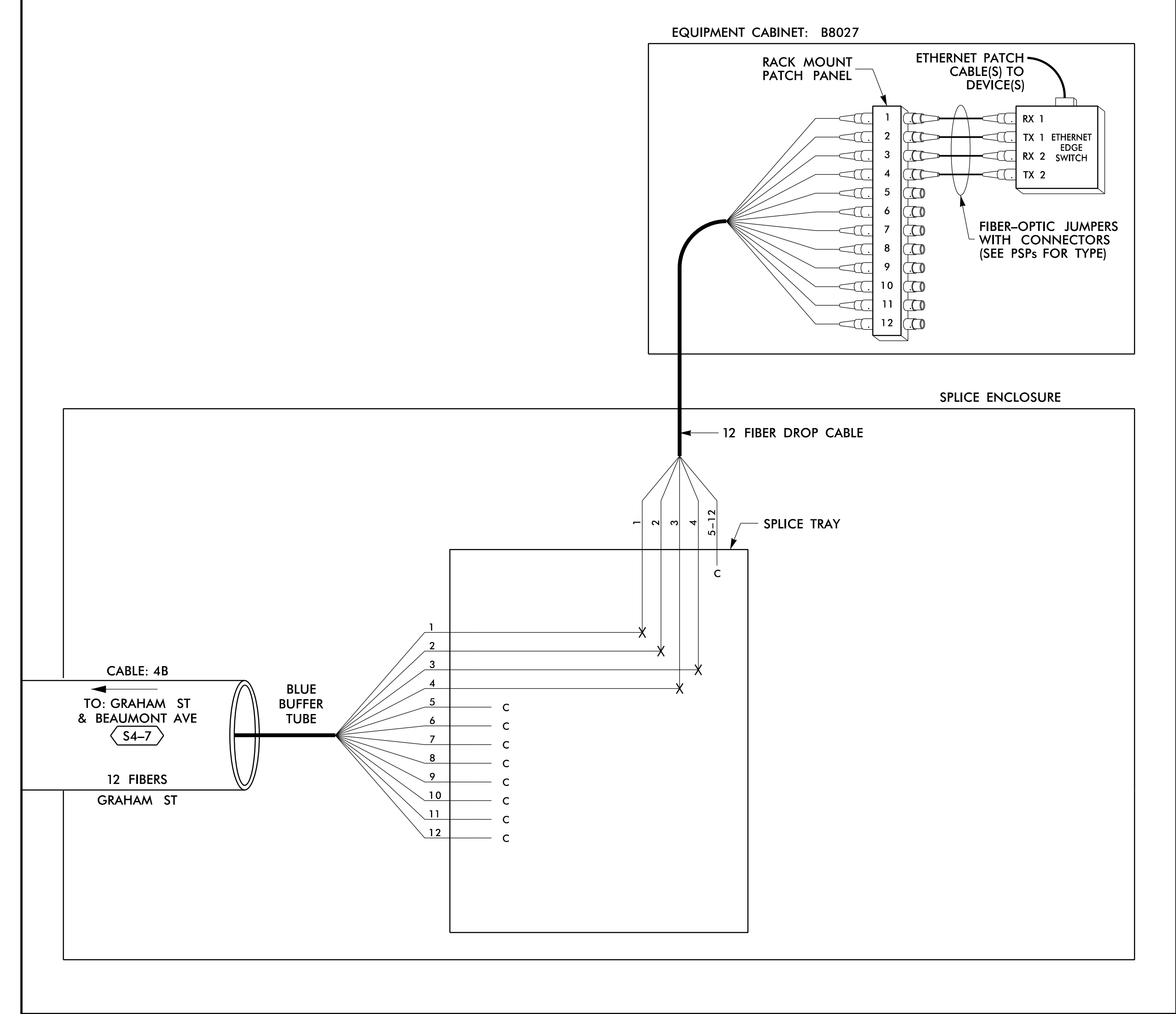

14 JUN 2018 12:15
 D:\projects\proj\11\11_00056469_U-6015_B-C_Sig_Sys\Task_11_Corrs\F_S 4.026.dgn
 S:\033653 AT_LUS355433

LEGEND

COLOR CODE		TIA/EIA 598-B	
(1) BLUE	(7) RED	EXPRESS	EXPRESS ENTIRE BUFFER TUBE / FIBERS THROUGH WITHOUT CUTTING
(2) ORANGE	(8) BLACK	BUFFER SPLICE	SPLICE ALL FIBERS IN BUFFER TUBE COLOR TO COLOR
(3) GREEN	(9) YELLOW	EXISTING	EXISTING BUFFER TUBE / FIBERS DO NOT MODIFY EXISTING SPLICES OR EXPRESSED FIBERS.
(4) BROWN	(10) VIOLET		
(5) SLATE	(11) ROSE		
(6) WHITE	(12) AQUA		

NOTES

1. UNUSED FIBERS LEFT COILED AND STORED IN SPLICE TRAY
2. UNUSED BUFFER TUBES LEFT COILED AND STORED IN SPLICE ENCLOSURE
3. EDGE SWITCH CONFIGURATIONS ARE GENERIC. CONTRACTOR IS RESPONSIBLE FOR DETERMINING/ENSURING THE PROPER TERMINATIONS.

ATKINS 1616 EAST MILLBROOK ROAD, SUITE 160
RALEIGH, NORTH CAROLINA 27609
(919) 876-6888 NCBES #F-0326

DOCUMENT NOT CONSIDERED FINAL UNLESS ALL SIGNATURES COMPLETED

<p>Prepared for the Offices of: NORTH CAROLINA DEPARTMENT OF TRANSPORTATION</p>	<p>Burlington-Graham Signal System Fiber-Optic Splicing Details</p>		
	<p>Division 7 Alamance County</p>	<p>Burlington & Graham</p>	
<p>750 Greenfield Parkway, Garner, NC 27529</p>	<p>PLAN DATE: June 2018</p>	<p>REVIEWED BY: HA BADGETT</p>	<p>DATE: 5/15/2018</p>
<p>SCALE: N/A</p>	<p>PREPARED BY: BJ SLOCUM</p>	<p>REVIEWED BY: DL JONES</p>	<p>DATE: 5/15/2018</p>
<p>REVISIONS</p>		<p>INIT.</p>	<p>DATE</p>
<p>SCALE: N/A</p>			

SPLICE NO.

S4-9

HANOVER RD & SELLARS MILL RD
SEE: CRP-6.193

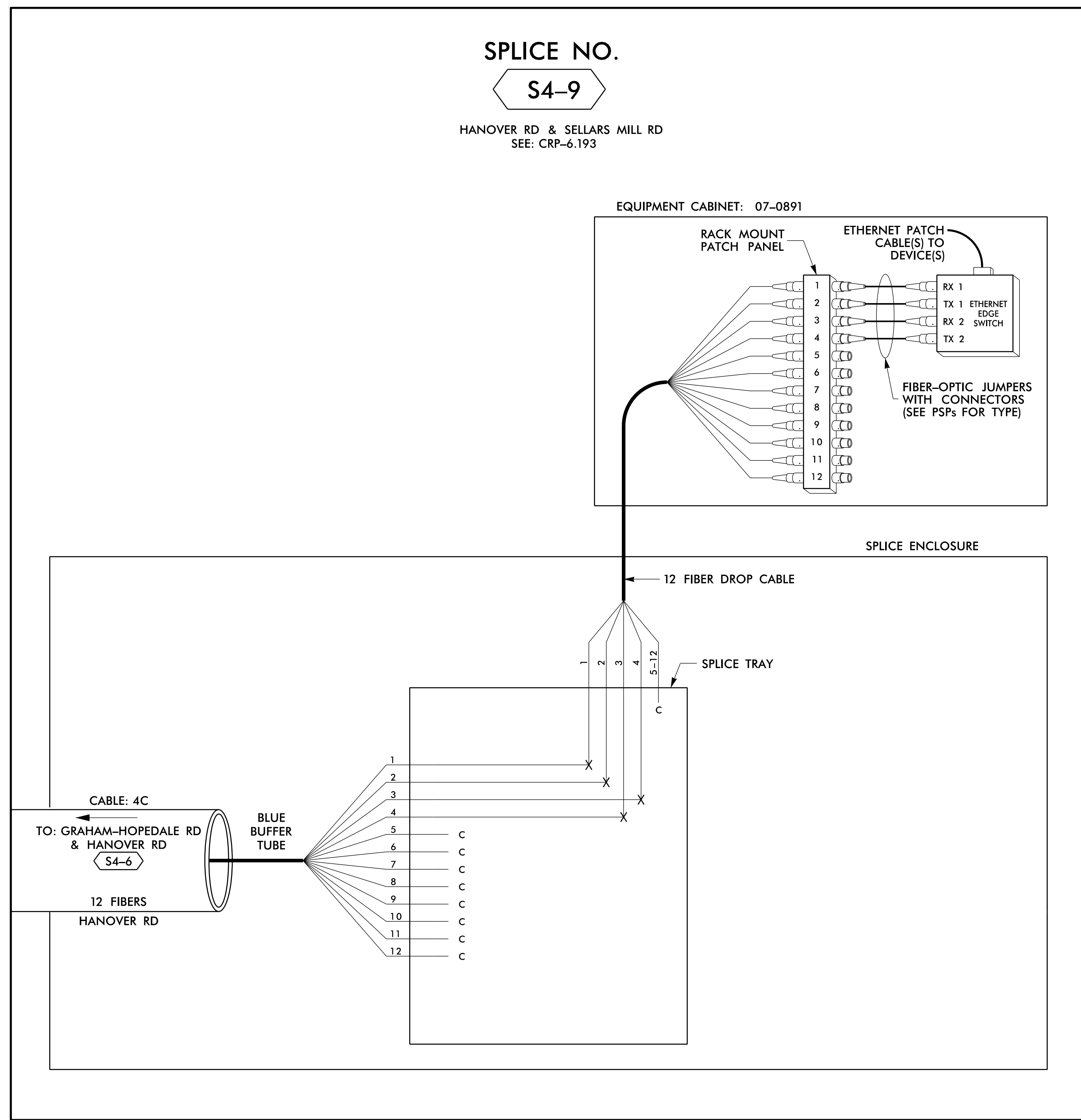

14 JUN 2018 12:16
 D:\Technical\cadd\cadd\proj\off\cadd\U-6015 B-C Sig Sys\Task 11_Comm\F4_027.dgn
 S:\CADD\363 AT_LUS355433

LEGEND

COLOR CODE TIA/EIA 598-B		X = FUSION SPlice INDIVIDUAL FIBER C = CAP AND SEAL
(1) BLUE	(7) RED	EXPRESS ENTIRE BUFFER TUBE / FIBERS THROUGH WITHOUT CUTTING
(2) ORANGE	(8) BLACK	
(3) GREEN	(9) YELLOW	BUFFER SPlice SPlice ALL FIBERS IN BUFFER TUBE COLOR TO COLOR
(4) BROWN	(10) VIOLET	
(5) SLATE	(11) ROSE	EXISTING EXISTING BUFFER TUBE / FIBERS DO NOT MODIFY EXISTING SPlices OR EXPRESSED FIBERS.
(6) WHITE	(12) AQUA	

NOTES

- UNUSED FIBERS LEFT COILED AND STORED IN SPLICE TRAY
- UNUSED BUFFER TUBES LEFT COILED AND STORED IN SPLICE ENCLOSURE
- EDGE SWITCH CONFIGURATIONS ARE GENERIC. CONTRACTOR IS RESPONSIBLE FOR DETERMINING/ENSURING THE PROPER TERMINATIONS.

ATKINS 1616 EAST MILLBROOK ROAD, SUITE 160
 RALEIGH, NORTH CAROLINA 27609
 (919) 876-6888 NCBEEES #F-0326

DOCUMENT NOT CONSIDERED FINAL UNLESS ALL SIGNATURES COMPLETED

Prepared for the Offices of: 750 Greenfield Parkway, Garner, NC 27529	Burlington-Graham Signal System Fiber-Optic Splicing Details		SEAL NORTH CAROLINA PROFESSIONAL ENGINEER SEAL 040877 BRADFORD J. SLOCUM 15/2018 DATE
	Division 7 Alamance County Burlington & Graham	PLAN DATE: June 2018 PREPARED BY: BJ SLOCUM	
SCALE N/A	REVISIONS	INIT. DATE	DATE

CAAD File name: FS 4.027.dgn

SPLICE NO.
S4-10

GRAHAM-HOPEDALE RD & PIEDMONT WAY
SEE: CRP-6.187

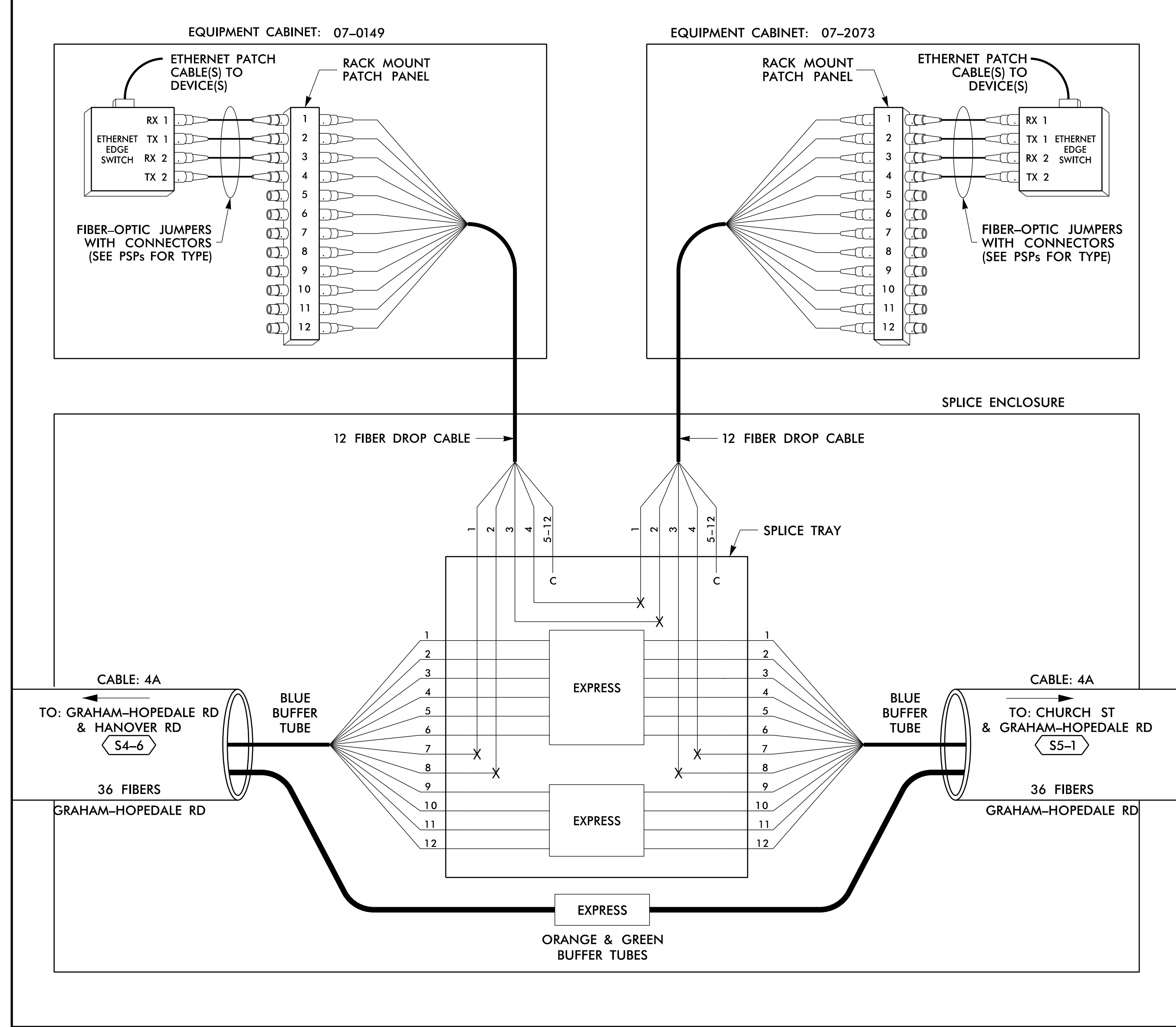

LEGEND

COLOR CODE TIA/EIA 598-B		X = FUSION SPLICE INDIVIDUAL FIBER	
(1) BLUE	(7) RED	EXPRESS	EXPRESS ENTIRE BUFFER TUBE / FIBERS THROUGH WITHOUT CUTTING
(2) ORANGE	(8) BLACK	BUFFER SPLICE	SPLICE ALL FIBERS IN BUFFER TUBE COLOR TO COLOR
(3) GREEN	(9) YELLOW	EXISTING	EXISTING BUFFER TUBE / FIBERS DO NOT MODIFY EXISTING SPLICES OR EXPRESSED FIBERS.
(4) BROWN	(10) VIOLET		
(5) SLATE	(11) ROSE		
(6) WHITE	(12) AQUA		
		C = CAP AND SEAL	

NOTES

- UNUSED FIBERS LEFT COILED AND STORED IN SPLICE TRAY
- UNUSED BUFFER TUBES LEFT COILED AND STORED IN SPLICE ENCLOSURE
- EDGE SWITCH CONFIGURATIONS ARE GENERIC. CONTRACTOR IS RESPONSIBLE FOR DETERMINING/ENSURING THE PROPER TERMINATIONS.

ATKINS 1616 EAST MILLBROOK ROAD, SUITE 160
RALEIGH, NORTH CAROLINA 27609
(919) 876-6888 NCBEEES #F-0326

DOCUMENT NOT CONSIDERED FINAL UNLESS ALL SIGNATURES COMPLETED

	Prepared for the Offices of: NORTH CAROLINA DEPARTMENT OF TRANSPORTATION Transportation Systems		SEAL NORTH CAROLINA PROFESSIONAL SEAL 040877 ENGINEER BRADFORD J. SLOCUM 15/2018
	Burlington-Graham Signal System Fiber-Optic Splicing Details		
Division 7 Alamance County Burlington & Graham		PLAN DATE: June 2018 REVIEWED BY: HA BADGETT	
PREPARED BY: BJ SLOCUM		REVIEWED BY: DL JONES	
SCALE: N/A		REVISIONS: _____ INIT. DATE _____	
CAD00 File name: FS 4.028.dgn			

14-JUN-2018 12:16
 D:\Technical\proj\11\comms\11_00056469 U-6015 B-C Sig_Sys\Task 11_Comms\F S 4_028.dgn
 S:\DCS\653 AT_LUS355433

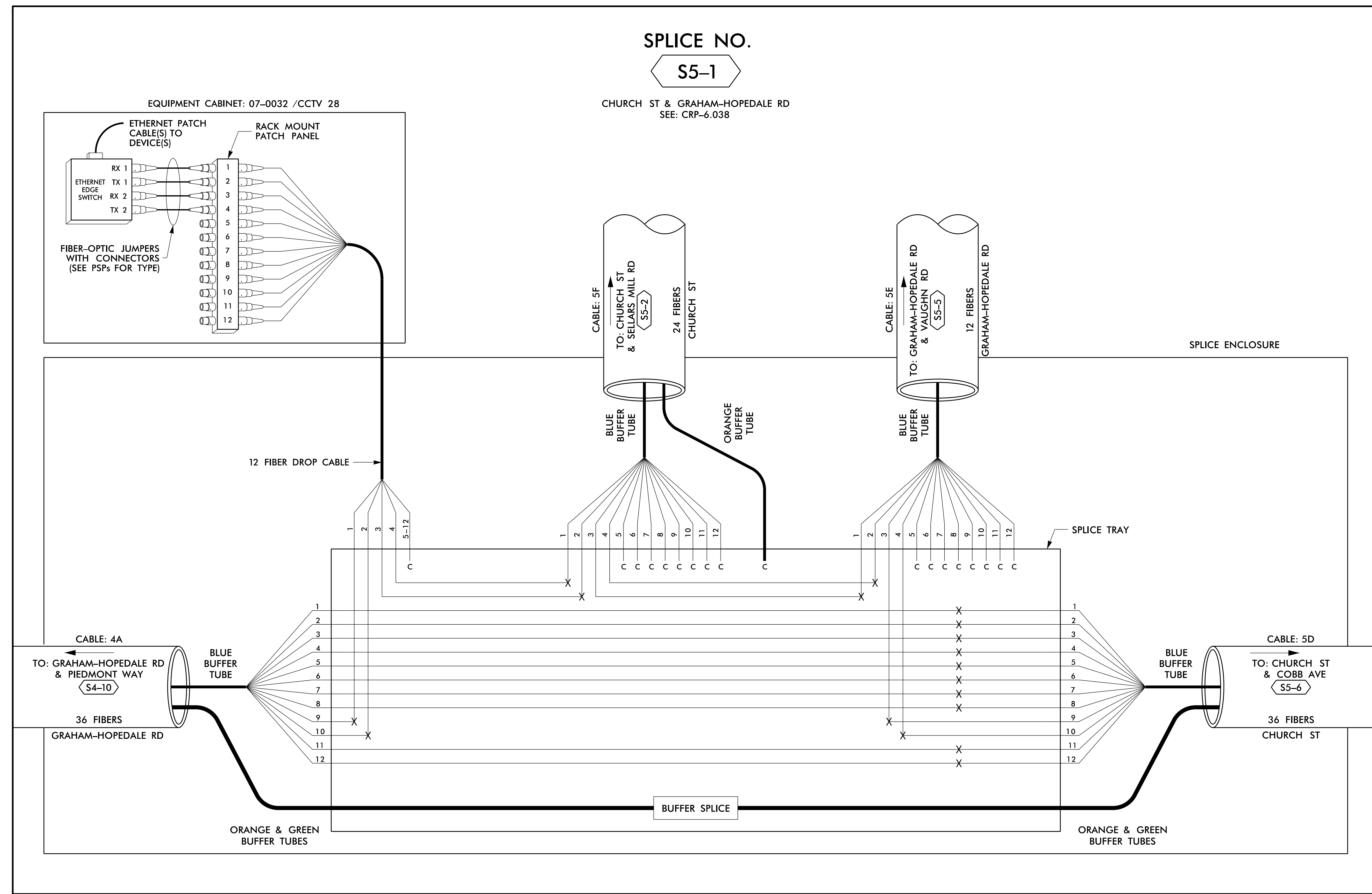

SPLICE NO.
S5-1

CHURCH ST & GRAHAM-HOPEDALE RD
 SEE: CRP-6.038

EQUIPMENT CABINET: 07-0032 /CCTV 28

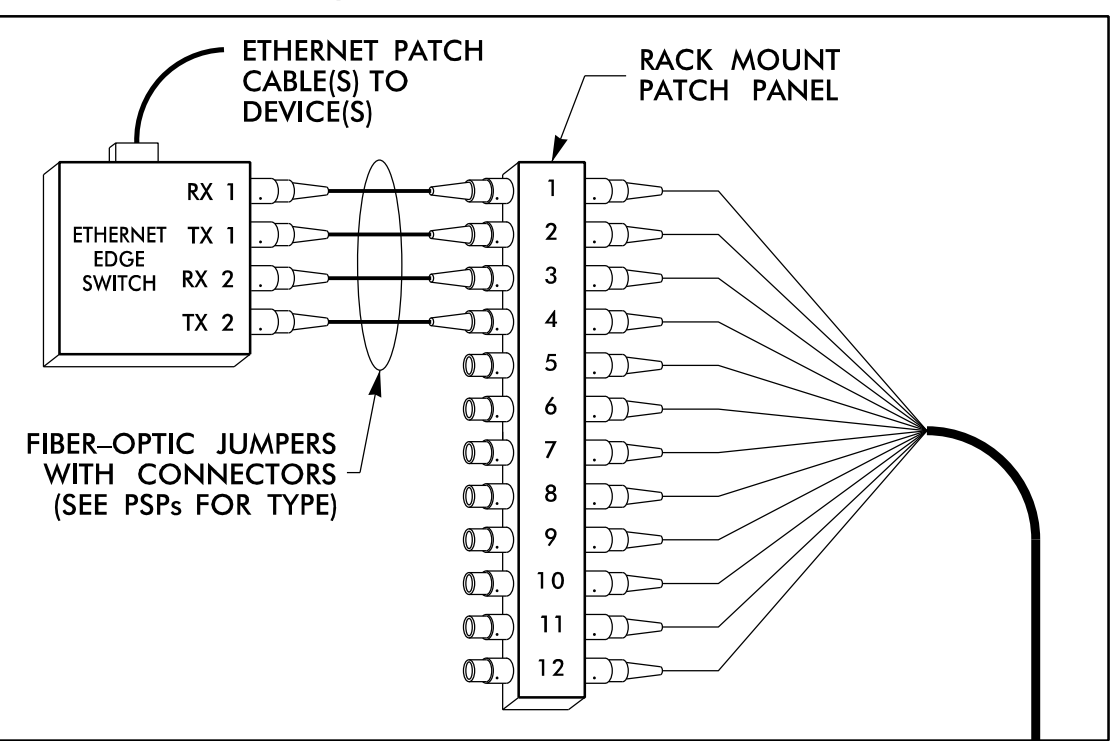

14 JUN 2018 12:16
 D:\projects\proj\11\11_00056469 U-6015 B-C Sig_Sys\Task 11_Coms\F5 4_029.dgn
 SLODC363 AT LUS355433

LEGEND

COLOR CODE TIA/EIA 598-B		X = FUSION SPLICE INDIVIDUAL FIBER C = CAP AND SEAL
(1) BLUE	(7) RED	EXPRESS ENTIRE BUFFER TUBE /FIBERS THROUGH WITHOUT CUTTING
(2) ORANGE	(8) BLACK	
(3) GREEN	(9) YELLOW	BUFFER SPLICE SPLICE ALL FIBERS IN BUFFER TUBE COLOR TO COLOR
(4) BROWN	(10) VIOLET	
(5) SLATE	(11) ROSE	EXISTING BUFFER TUBE /FIBERS DO NOT MODIFY EXISTING SPLICES OR EXPRESSED FIBERS.
(6) WHITE	(12) AQUA	

NOTES

- UNUSED FIBERS LEFT COILED AND STORED IN SPLICE TRAY
- UNUSED BUFFER TUBES LEFT COILED AND STORED IN SPLICE ENCLOSURE
- EDGE SWITCH CONFIGURATIONS ARE GENERIC. CONTRACTOR IS RESPONSIBLE FOR DETERMINING/ENSURING THE PROPER TERMINATIONS.

ATKINS 1616 EAST MILLBROOK ROAD, SUITE 160
 RALEIGH, NORTH CAROLINA 27609
 (919) 876-6888 NCBEEES #F-0326

DOCUMENT NOT CONSIDERED FINAL
 UNLESS ALL SIGNATURES COMPLETED

Prepared for the Offices of: 750 Greenfield Parkway, Garner, NC 27529	Burlington-Graham Signal System Fiber-Optic Splicing Details		SEAL NORTH CAROLINA PROFESSIONAL ENGINEER SEAL 040877 BRADFORD J. SLOCUM 15/2018 DATE
	Division 7 Alamance County Burlington & Graham	PLAN DATE: June 2018 PREPARED BY: BJ SLOCUM SCALE: N/A	
REVISIONS			
INITIALS DATE			

SPLICE NO.

S5-2

CHURCH ST & SELLARS MILL RD
SEE: CRP-6.039

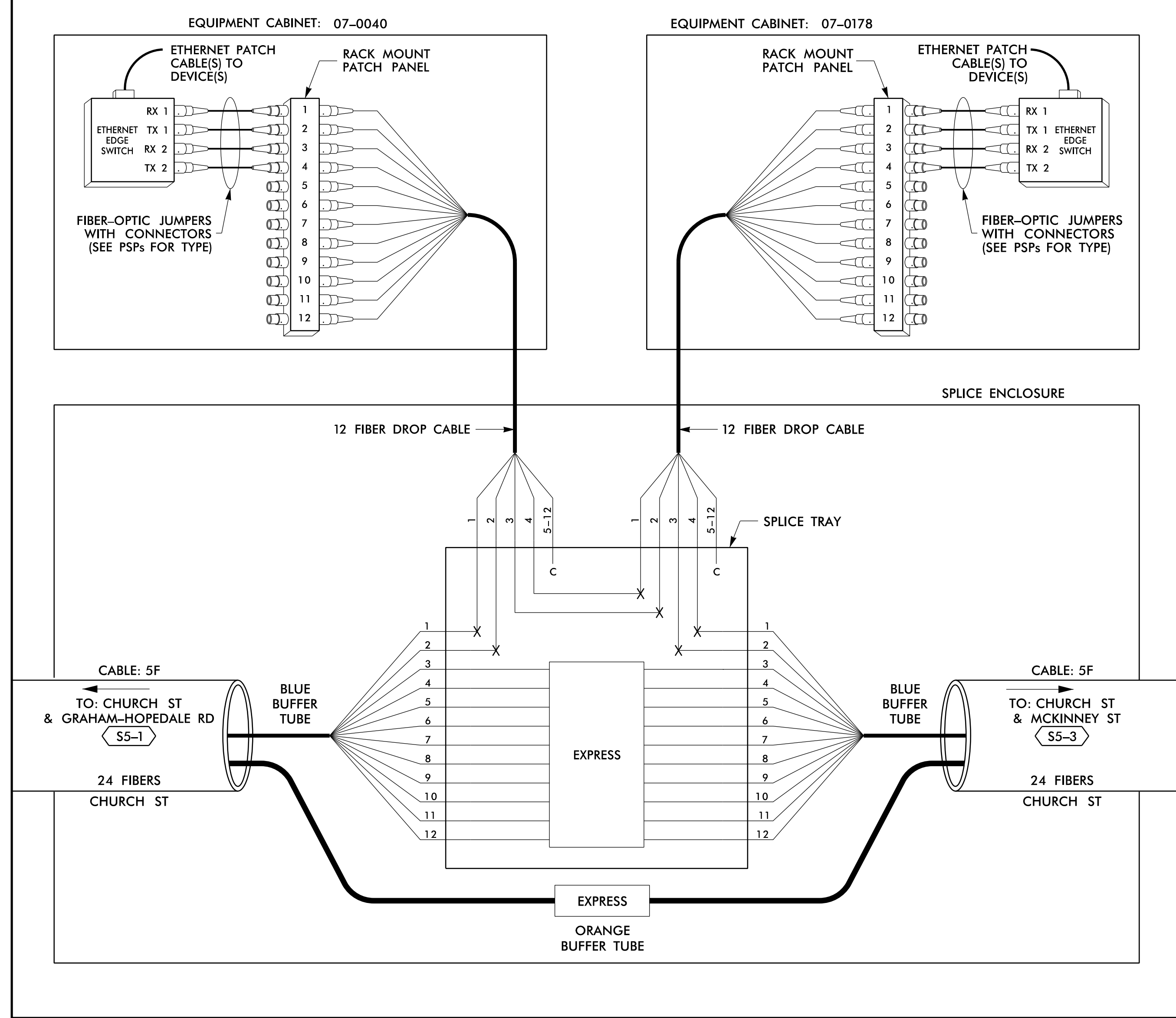

SPLICE NO.

S5-3

CHURCH ST & MCKINNEY ST
SEE: CRP-6.042

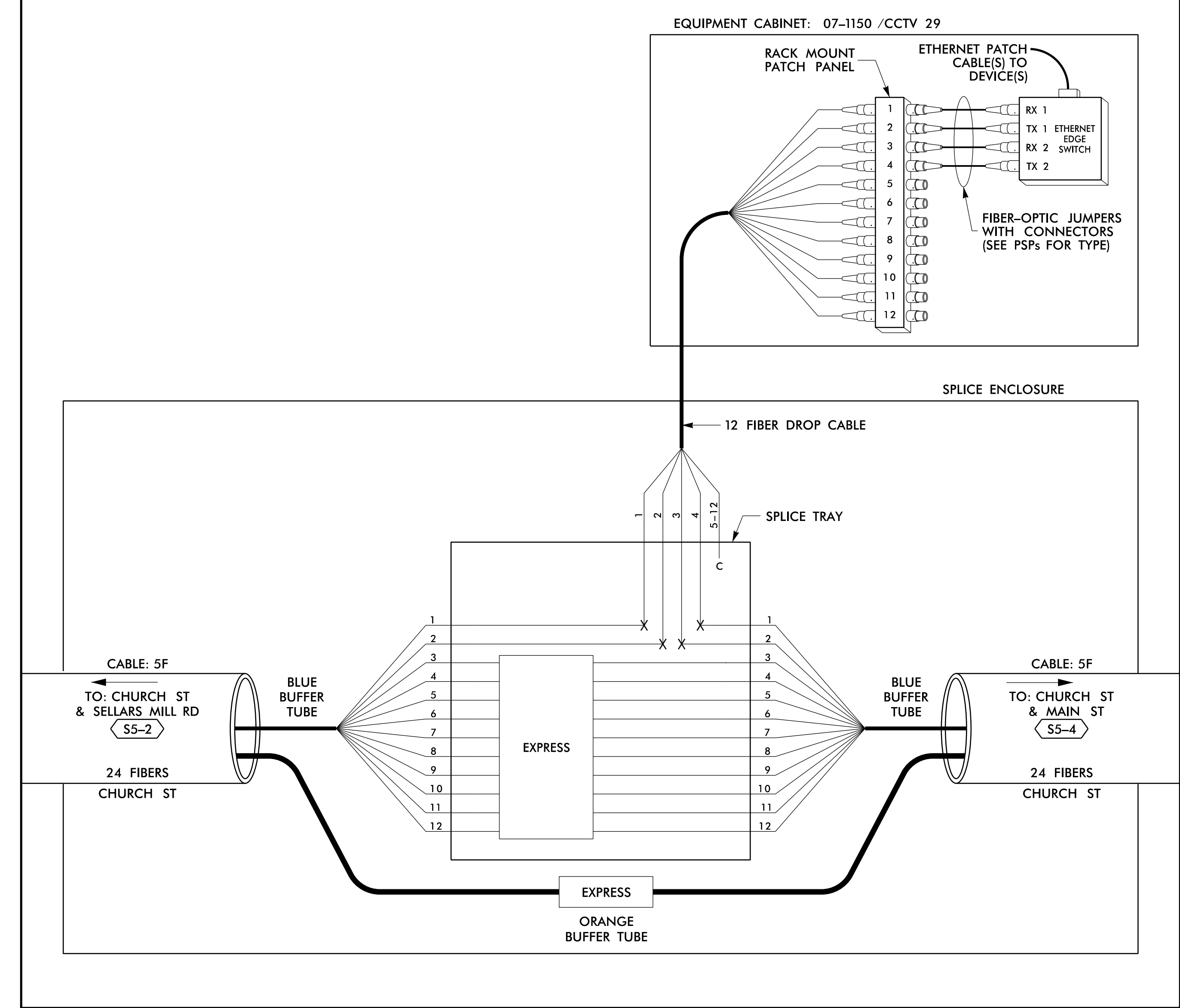

14 JUN 2018 12:17
 D:\Technical\Information\Traffic\Cur\100056469 U-6015 B-C Sig Sys\Task 11_Corrs\F5 4.030.dgn
 SLOJCS653 AT LUS355433

LEGEND

COLOR CODE TIA/EIA 598-B		X = FUSION SPLICE INDIVIDUAL FIBER	
(1) BLUE	(7) RED	EXPRESS	EXPRESS ENTIRE BUFFER TUBE / FIBERS THROUGH WITHOUT CUTTING
(2) ORANGE	(8) BLACK	BUFFER SPLICE	SPLICE ALL FIBERS IN BUFFER TUBE COLOR TO COLOR
(3) GREEN	(9) YELLOW	EXISTING	EXISTING BUFFER TUBE / FIBERS DO NOT MODIFY EXISTING SPLICES OR EXPRESSED FIBERS.
(4) BROWN	(10) VIOLET		
(5) SLATE	(11) ROSE		
(6) WHITE	(12) AQUA		

NOTES

- UNUSED FIBERS LEFT COILED AND STORED IN SPLICE TRAY
- UNUSED BUFFER TUBES LEFT COILED AND STORED IN SPLICE ENCLOSURE
- EDGE SWITCH CONFIGURATIONS ARE GENERIC. CONTRACTOR IS RESPONSIBLE FOR DETERMINING/ENSURING THE PROPER TERMINATIONS.

ATKINS

1616 EAST MILLBROOK ROAD, SUITE 160
RALEIGH, NORTH CAROLINA 27609
(919) 876-6888 NCBEEES #F-0326

DOCUMENT NOT CONSIDERED FINAL
UNLESS ALL SIGNATURES COMPLETED

	Prepared for the Offices of: Burlington-Graham Signal System Fiber-Optic Splicing Details		
	Division 7 PLAN DATE: June 2018 PREPARED BY: BJ SLOCUM	Alamance County REVIEWED BY: HA BADGETT REVIEWED BY: DL JONES	
750 Greenfield Parkway, Garner, NC 27529 SCALE: N/A	REVISIONS: _____ INIT. DATE _____ _____ INIT. DATE _____ _____ INIT. DATE _____		BRADFORD J. SLOCUM ENGINEER DATE: 6/15/2018 CADD File name: FS 4.030.dgn

SPLICE NO.

S5-4

CHURCH ST & MAIN ST
SEE: CRP-6.043

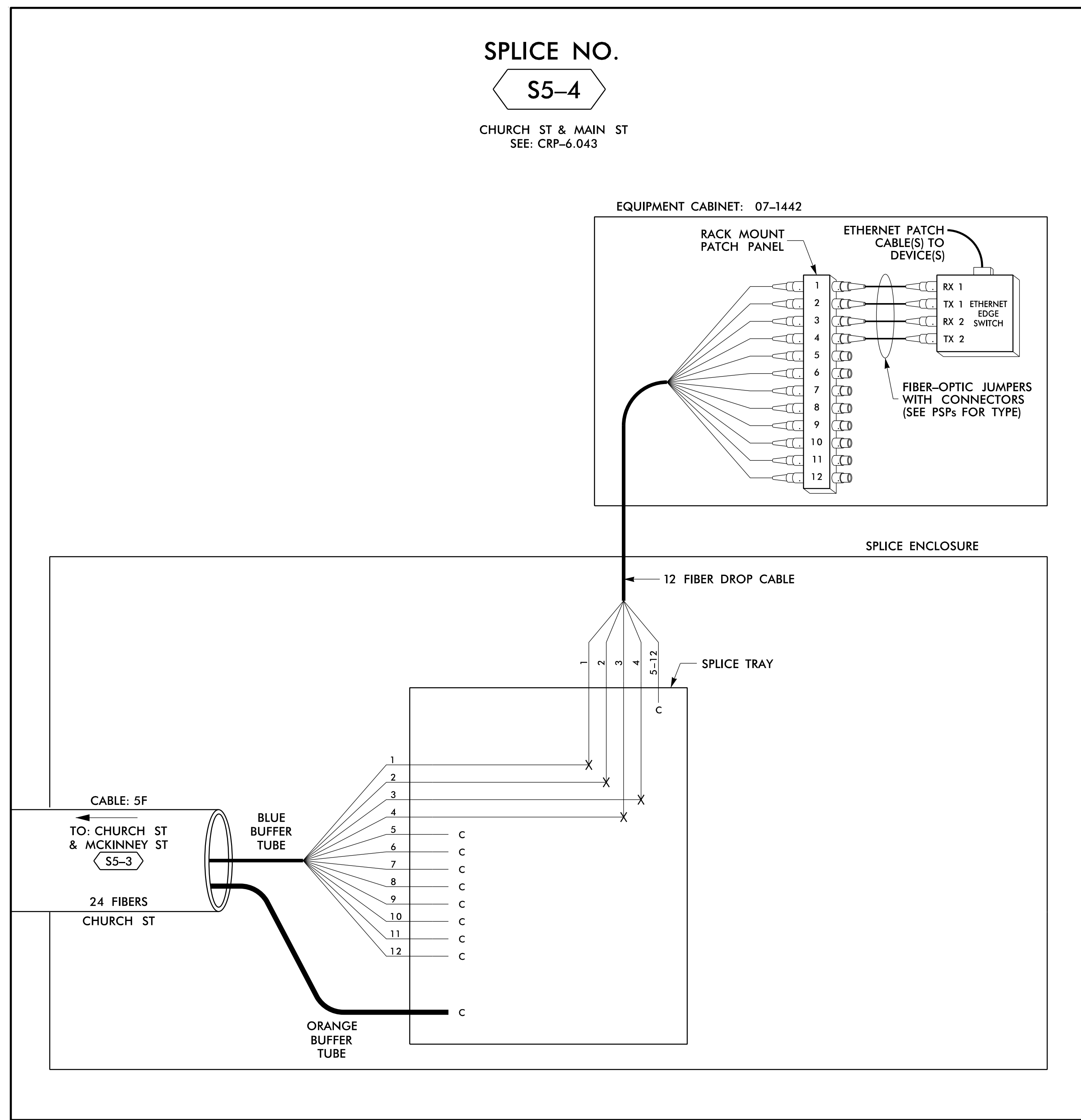

14 JUN 2018 12:17
 D:\Technical\Projects\U-6015 B-C Sig. Sys\Task 11_Comms\F5 4.031.dgn
 SLODC363 AT LUS355433

LEGEND

COLOR CODE TIA/EIA 598-B		X = FUSION SPlice INDIVIDUAL FIBER	
(1) BLUE	(7) RED	EXPRESS	EXPRESS ENTIRE BUFFER TUBE / FIBERS THROUGH WITHOUT CUTTING
(2) ORANGE	(8) BLACK	BUFFER SPlice	SPlice ALL FIBERS IN BUFFER TUBE COLOR TO COLOR
(3) GREEN	(9) YELLOW	EXISTING	EXISTING BUFFER TUBE / FIBERS DO NOT MODIFY EXISTING SPlices OR EXPRESSED FIBERS.
(4) BROWN	(10) VIOLET		
(5) SLATE	(11) ROSE		
(6) WHITE	(12) AQUA		
		C =	CAP AND SEAL

NOTES

1. UNUSED FIBERS LEFT COILED AND STORED IN SPLICE TRAY
2. UNUSED BUFFER TUBES LEFT COILED AND STORED IN SPLICE ENCLOSURE
3. EDGE SWITCH CONFIGURATIONS ARE GENERIC. CONTRACTOR IS RESPONSIBLE FOR DETERMINING/ENSURING THE PROPER TERMINATIONS.

ATKINS 1616 EAST MILLBROOK ROAD, SUITE 160
RALEIGH, NORTH CAROLINA 27609
(919) 876-6888 NCBES #F-0326

DOCUMENT NOT CONSIDERED FINAL UNLESS ALL SIGNATURES COMPLETED

<p>Prepared for the Offices of: NORTH CAROLINA DEPARTMENT OF TRANSPORTATION 750 Greenfield Parkway, Garner, NC 27529</p>	Burlington-Graham Signal System Fiber-Optic Splicing Details		
	Division 7 Alamance County	Burlington & Graham	
PLAN DATE: June 2018	REVIEWED BY: HA BADGETT	PREPARED BY: BJ SLOCUM	REVIEWED BY: DL JONES
SCALE: N/A	REVISIONS	INIT.	DATE

DATE: 6/15/2018
CAD File name: FS_4.031.dgn

SPLICE NO.

S5-5

GRAHAM-HOPEDALE RD & VAUGHN RD
SEE: CRP-6.189

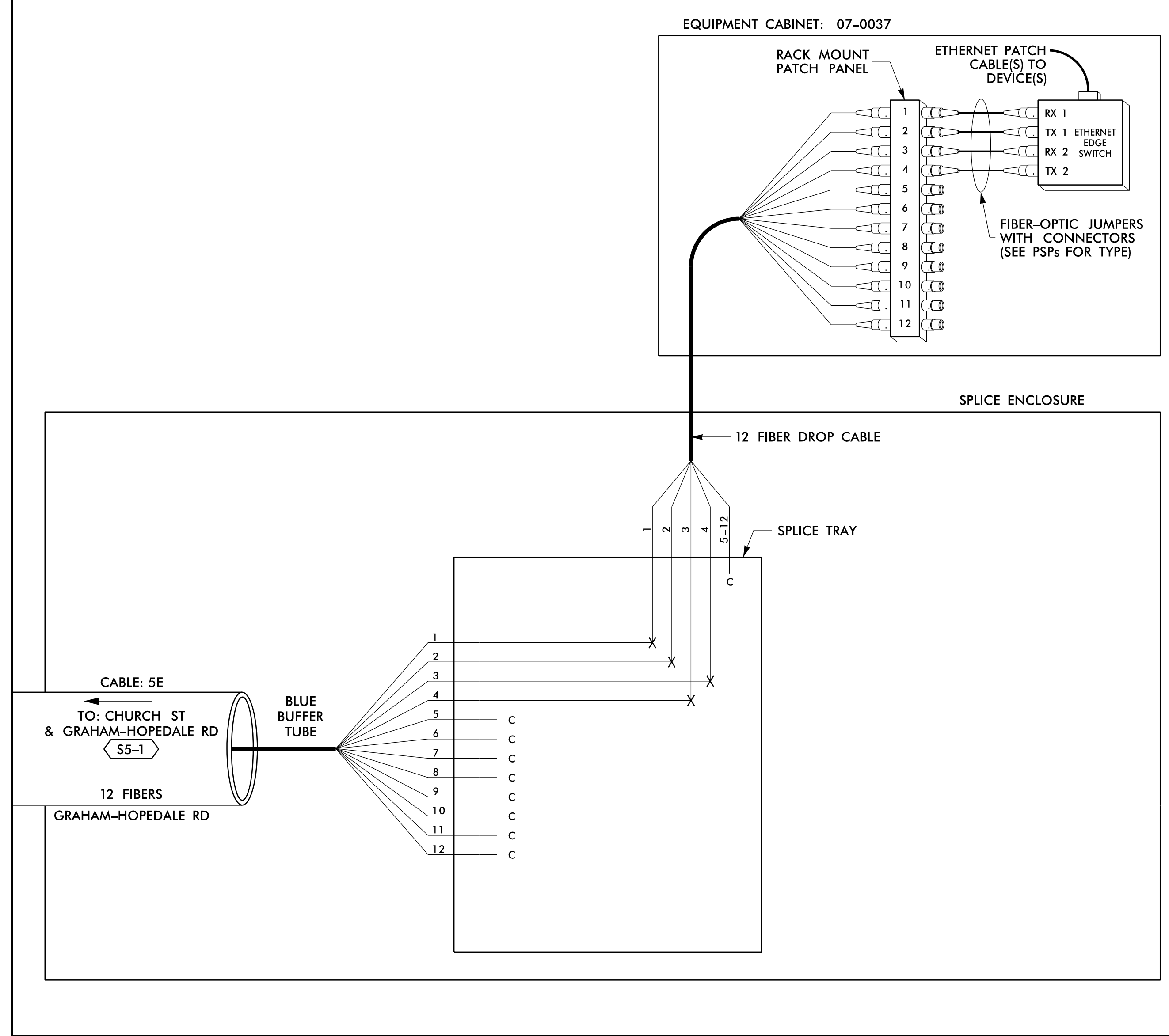

SPLICE NO.

S5-6

CHURCH ST & COBB AVE
SEE: CRP-6.037

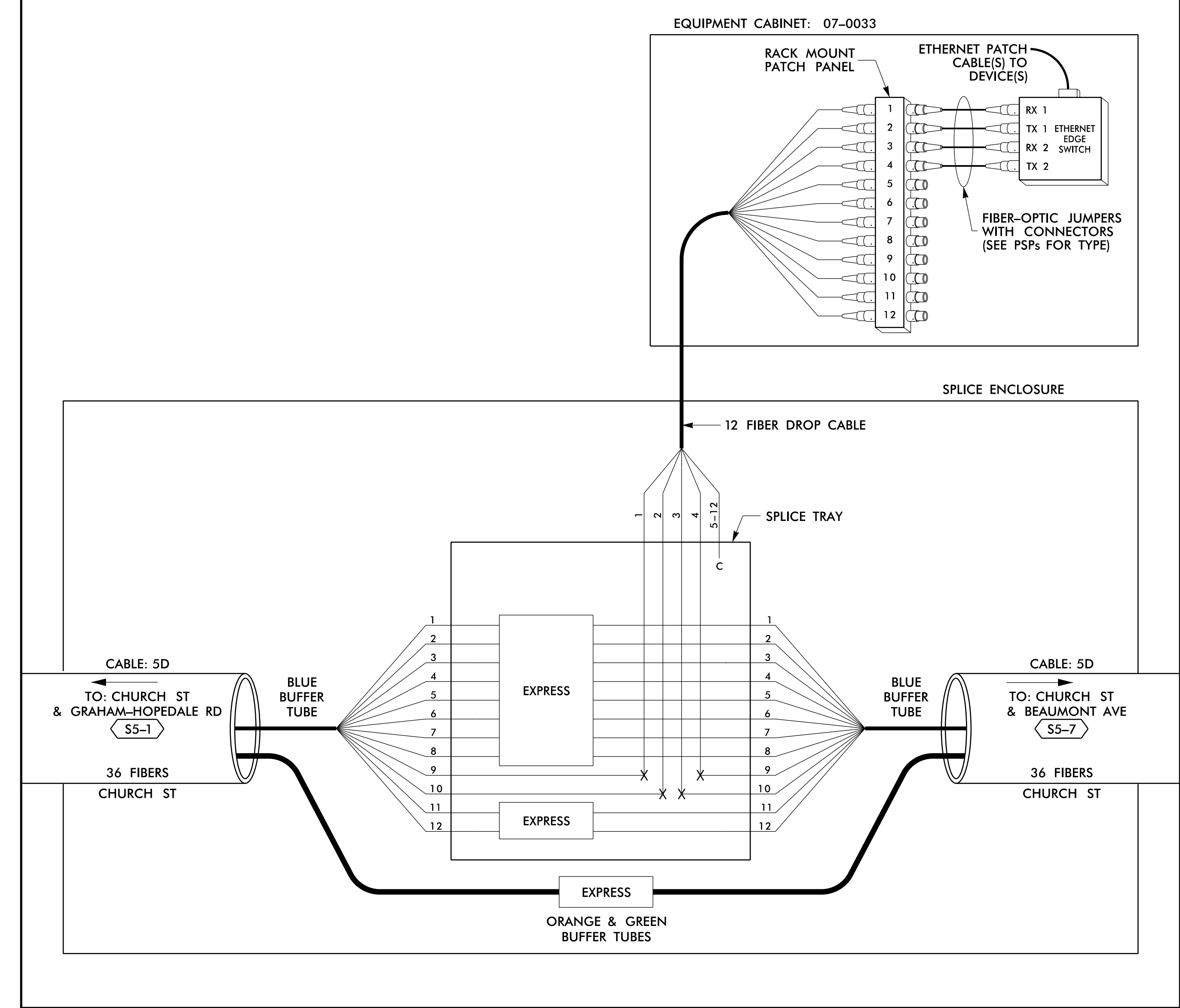

14 JUN 2018 12:18
 D:\projects\proj\11\11_00056469_U-6015_B-C_Sig_Sys\Task_11_Corrs\F5_4_032.dgn
 S:\033653 AT_LUS355433

LEGEND

COLOR CODE		TIA/EIA 598-B	
(1) BLUE	(7) RED	EXPRESS	EXPRESS ENTIRE BUFFER TUBE / FIBERS THROUGH WITHOUT CUTTING
(2) ORANGE	(8) BLACK	BUFFER SPLICE	SPLICE ALL FIBERS IN BUFFER TUBE COLOR TO COLOR
(3) GREEN	(9) YELLOW	EXISTING	EXISTING BUFFER TUBE / FIBERS DO NOT MODIFY EXISTING SPLICES OR EXPRESSED FIBERS.
(4) BROWN	(10) VIOLET		
(5) SLATE	(11) ROSE		
(6) WHITE	(12) AQUA		

NOTES

- UNUSED FIBERS LEFT COILED AND STORED IN SPLICE TRAY
- UNUSED BUFFER TUBES LEFT COILED AND STORED IN SPLICE ENCLOSURE
- EDGE SWITCH CONFIGURATIONS ARE GENERIC. CONTRACTOR IS RESPONSIBLE FOR DETERMINING/ENSURING THE PROPER TERMINATIONS.

ATKINS 1616 EAST MILLBROOK ROAD, SUITE 160
RALEIGH, NORTH CAROLINA 27609
(919) 876-6888 NCBES #F-0326

DOCUMENT NOT CONSIDERED FINAL UNLESS ALL SIGNATURES COMPLETED

Prepared for the Offices of:

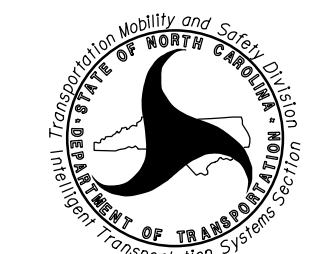

750 Greenfield Parkway, Garner, NC 27529

SCALE: N/A

Burlington-Graham Signal System
Fiber-Optic Splicing Details

Division 7 Alamance County Burlington & Graham

PLAN DATE: June 2018 REVIEWED BY: HA BADGETT

PREPARED BY: BJ SLOCUM REVIEWED BY: DL JONES

REVISIONS	INIT.	DATE

SEAL

NORTH CAROLINA PROFESSIONAL ENGINEER

SEAL 040877

BRADFORD J. SLOCUM

DATE: 6/15/2018

DATE: _____

CAAD File name: FS_4.032.dgn

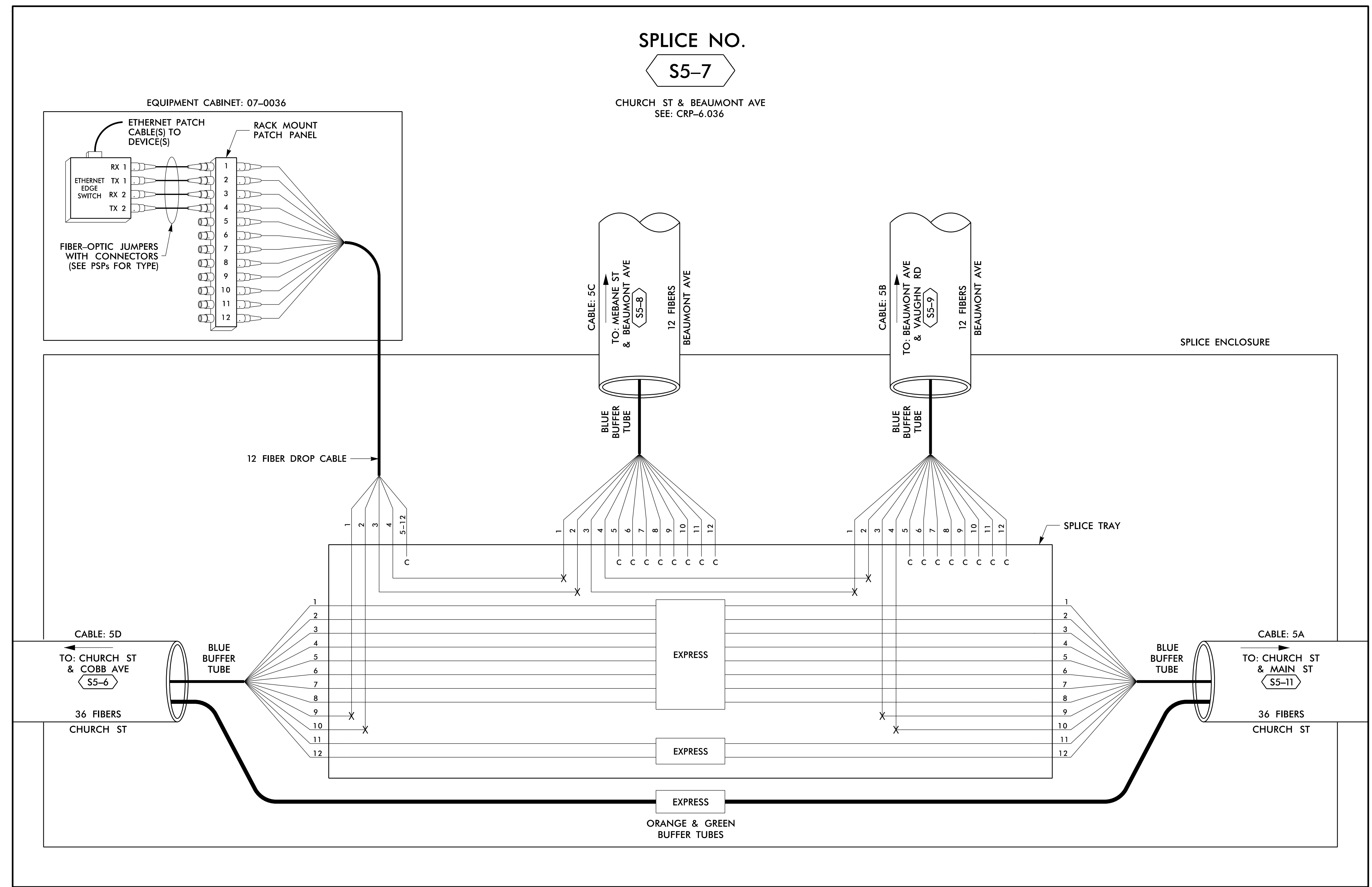

SPLICE NO.
S5-7

CHURCH ST & BEAUMONT AVE
 SEE: CRP-6.036

EQUIPMENT CABINET: 07-0036

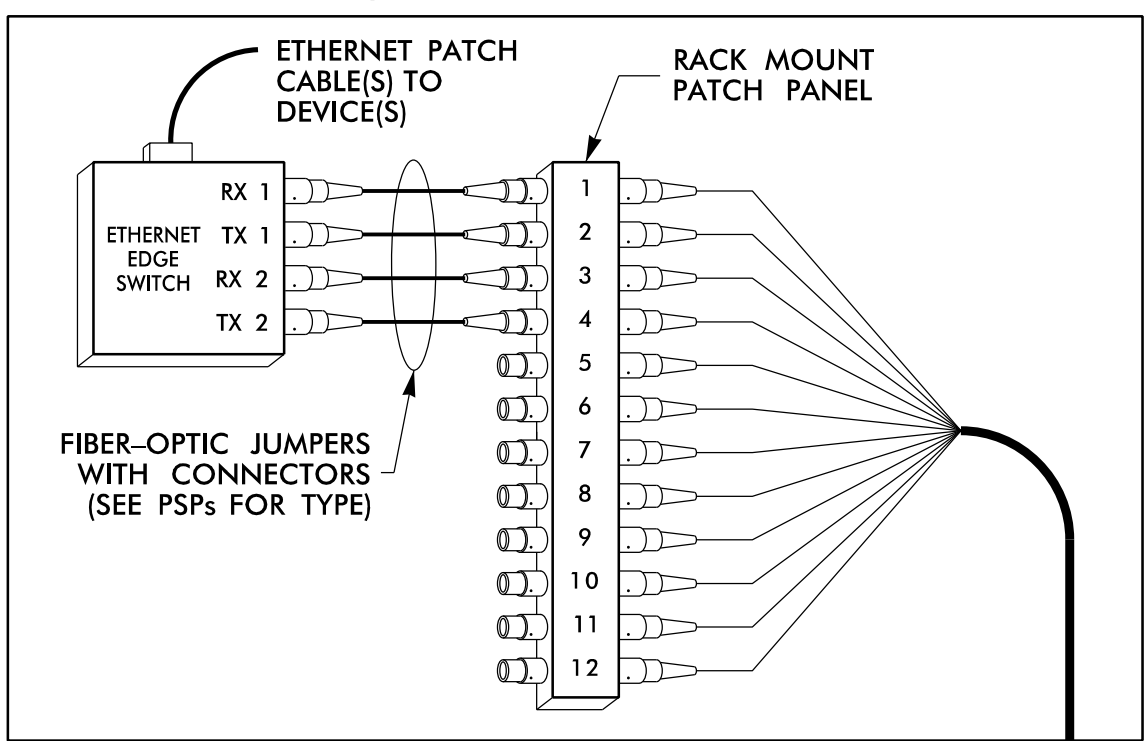

14 JUN 2018 12:18
 D:\projects\proj\11\11_00056469_U-6015_B-C_Sig_Sys\Task_11_Corrs\F_S 4.033.dgn
 S:\DCS\653 AT_LUS355433

LEGEND

COLOR CODE TIA/EIA 598-B		X = FUSION SPLICE INDIVIDUAL FIBER C = CAP AND SEAL
(1) BLUE	(7) RED	EXPRESS
(2) ORANGE	(8) BLACK	EXPRESS ENTIRE BUFFER TUBE / FIBERS THROUGH WITHOUT CUTTING
(3) GREEN	(9) YELLOW	BUFFER SPLICE
(4) BROWN	(10) VIOLET	SPLICE ALL FIBERS IN BUFFER TUBE COLOR TO COLOR
(5) SLATE	(11) ROSE	EXISTING
(6) WHITE	(12) AQUA	EXISTING BUFFER TUBE / FIBERS DO NOT MODIFY EXISTING SPLICES OR EXPRESSED FIBERS.

NOTES

- UNUSED FIBERS LEFT COILED AND STORED IN SPLICE TRAY
- UNUSED BUFFER TUBES LEFT COILED AND STORED IN SPLICE ENCLOSURE
- EDGE SWITCH CONFIGURATIONS ARE GENERIC. CONTRACTOR IS RESPONSIBLE FOR DETERMINING/ENSURING THE PROPER TERMINATIONS.

ATKINS 1616 EAST MILLBROOK ROAD, SUITE 160
 RALEIGH, NORTH CAROLINA 27609
 (919) 876-6888 NCBEEES #F-0326

DOCUMENT NOT CONSIDERED FINAL
 UNLESS ALL SIGNATURES COMPLETED

Prepared for the Offices of: 750 Greenfield Parkway, Garner, NC 27529	Burlington-Graham Signal System Fiber-Optic Splicing Details		SEAL NORTH CAROLINA PROFESSIONAL SEAL 040877 ENGINEER BRADFORD J. SLOCUM 15/2018
	Division 7 Alamance County PLAN DATE: June 2018 PREPARED BY: BJ SLOCUM	Burlington & Graham REVIEWED BY: HA BADGETT REVIEWED BY: DL JONES	

SPLICE NO.

S5-8

MEBANE ST & BEAUMONT AVE
SEE: CRP-6.161

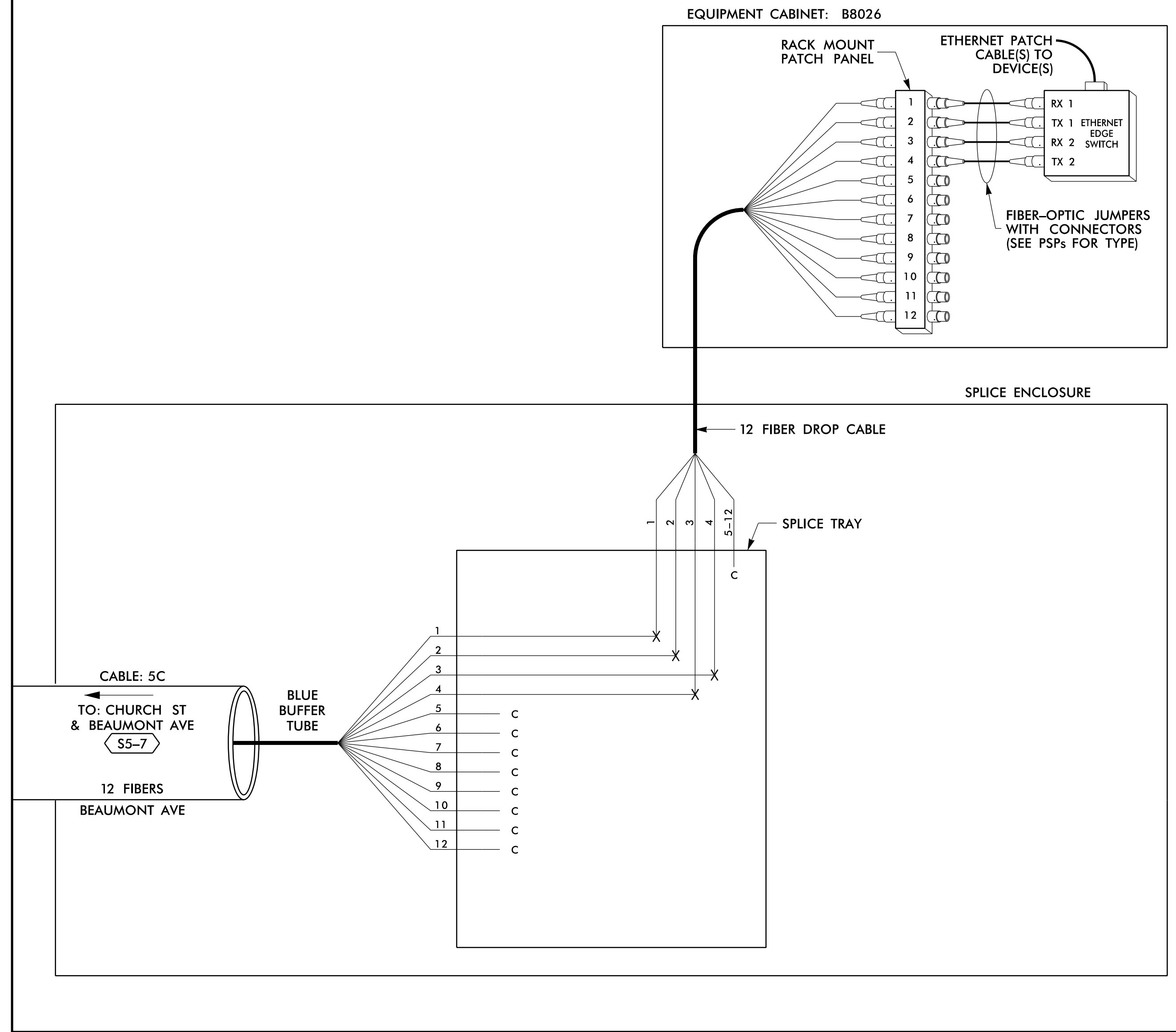

SPLICE NO.

S5-9

BEAUMONT AVE & VAUGHN RD
SEE: CRP-6.162

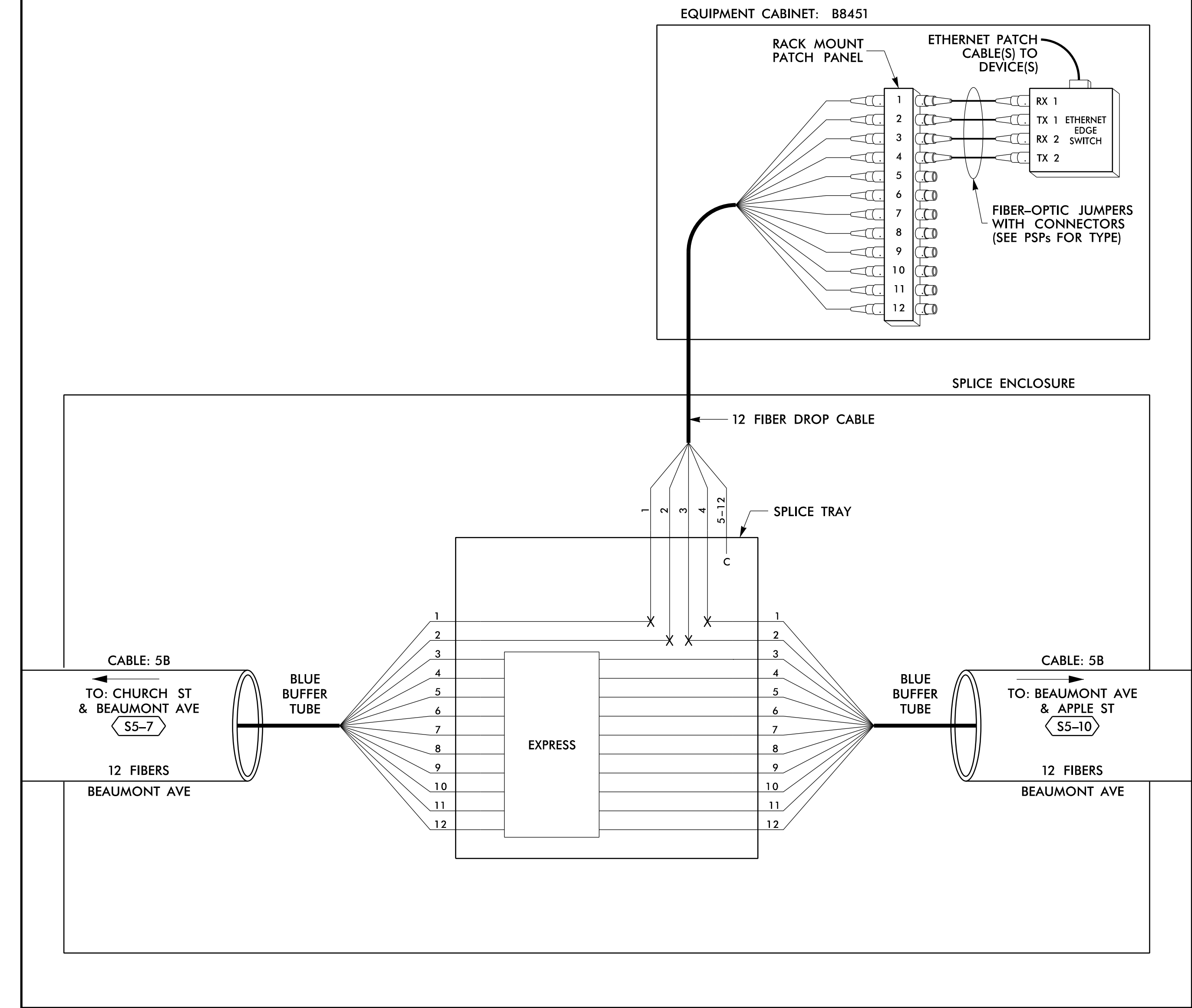

14 JUN 2018 12:19
 D:\Technical\Projects\U-6015 B-C Sig Sys\Task 11_Corrs\F5 4_034.dgn
 S:\DCS\653 AT_LUS355433

LEGEND

COLOR CODE TIA/EIA 598-B		X = FUSION SPlice INDIVIDUAL FIBER	EXPRESS	EXPRESS ENTIRE BUFFER TUBE /FIBERS THROUGH WITHOUT CUTTING
(1) BLUE	(7) RED	C = CAP AND SEAL	BUFFER SPlice	SPlice ALL FIBERS IN BUFFER TUBE COLOR TO COLOR
(2) ORANGE	(8) BLACK		EXISTING	EXISTING BUFFER TUBE /FIBERS DO NOT MODIFY EXISTING SPlices OR EXPRESSED FIBERS.
(3) GREEN	(9) YELLOW			
(4) BROWN	(10) VIOLET			
(5) SLATE	(11) ROSE			
(6) WHITE	(12) AQUA			

NOTES

1. UNUSED FIBERS LEFT COILED AND STORED IN SPLICE TRAY
2. UNUSED BUFFER TUBES LEFT COILED AND STORED IN SPLICE ENCLOSURE
3. EDGE SWITCH CONFIGURATIONS ARE GENERIC. CONTRACTOR IS RESPONSIBLE FOR DETERMINING/ENSURING THE PROPER TERMINATIONS.

ATKINS 1616 EAST MILLBROOK ROAD, SUITE 160
RALEIGH, NORTH CAROLINA 27609
(919) 876-6888 NCBEEs #F-0326

DOCUMENT NOT CONSIDERED FINAL UNLESS ALL SIGNATURES COMPLETED

<p>750 Greenfield Parkway, Garner, NC 27529</p>	<p>Burlington-Graham Signal System Fiber-Optic Splicing Details</p>		
	<p>Division 7 Alamance County</p>	<p>Burlington & Graham</p>	
<p>SCALE: N/A</p>	<p>PLAN DATE: June 2018</p>	<p>REVIEWED BY: HA BADGETT</p>	<p>DATE: 5/15/2018</p>
<p>PREPARED BY: BJ SLOCUM</p>	<p>REVIEWED BY: DL JONES</p>	<p>DATE: 5/15/2018</p>	<p>DATE: 5/15/2018</p>
<p>REVISIONS</p>	<p>INIT.</p>	<p>DATE</p>	<p>DATE</p>

SPLICE NO.
S5-10

BEAUMONT AVE & APPLE ST
SEE: CRP-6.165

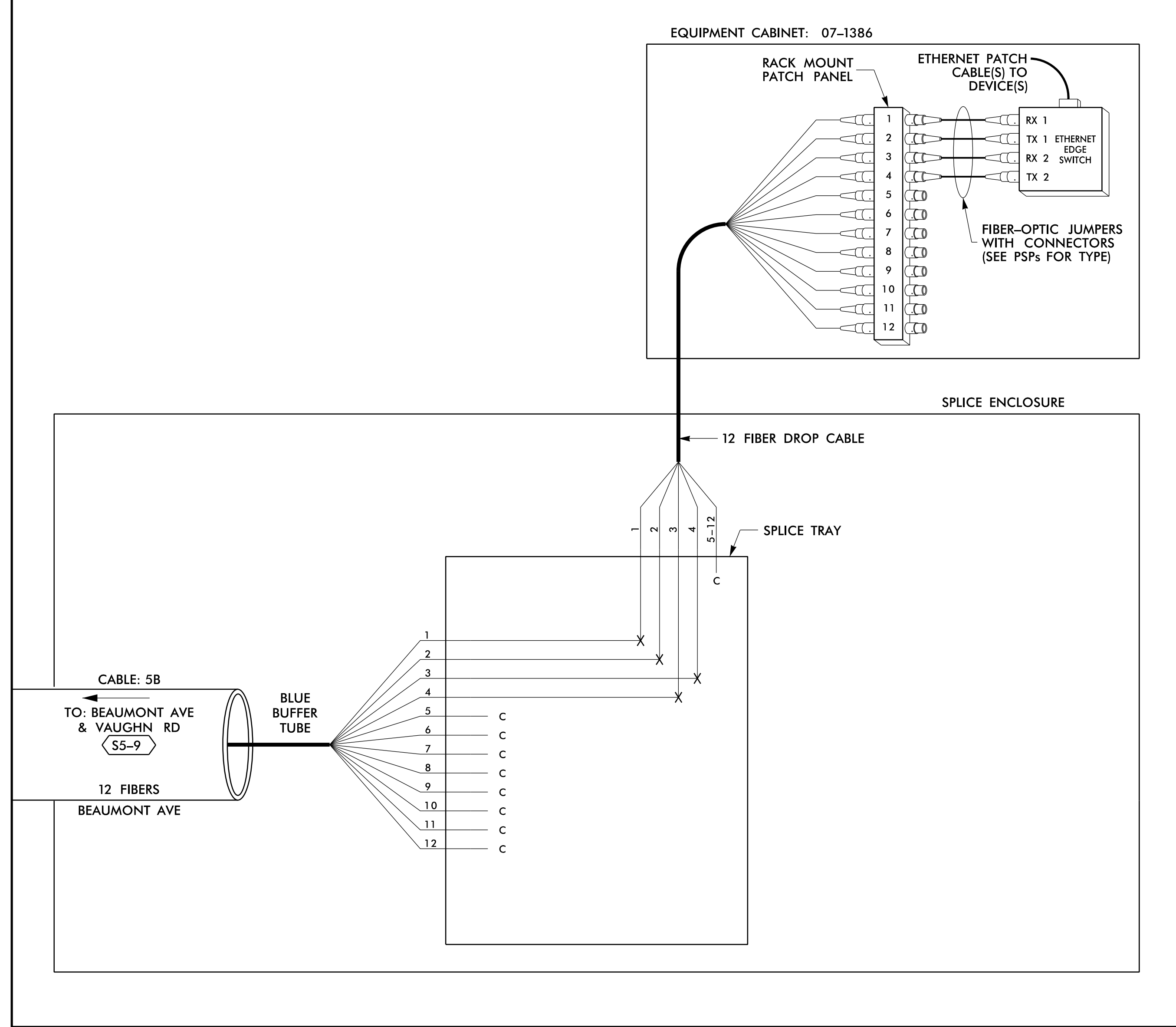

SPLICE NO.
S5-11

CHURCH ST & MAIN ST
SEE: CRP-6.035

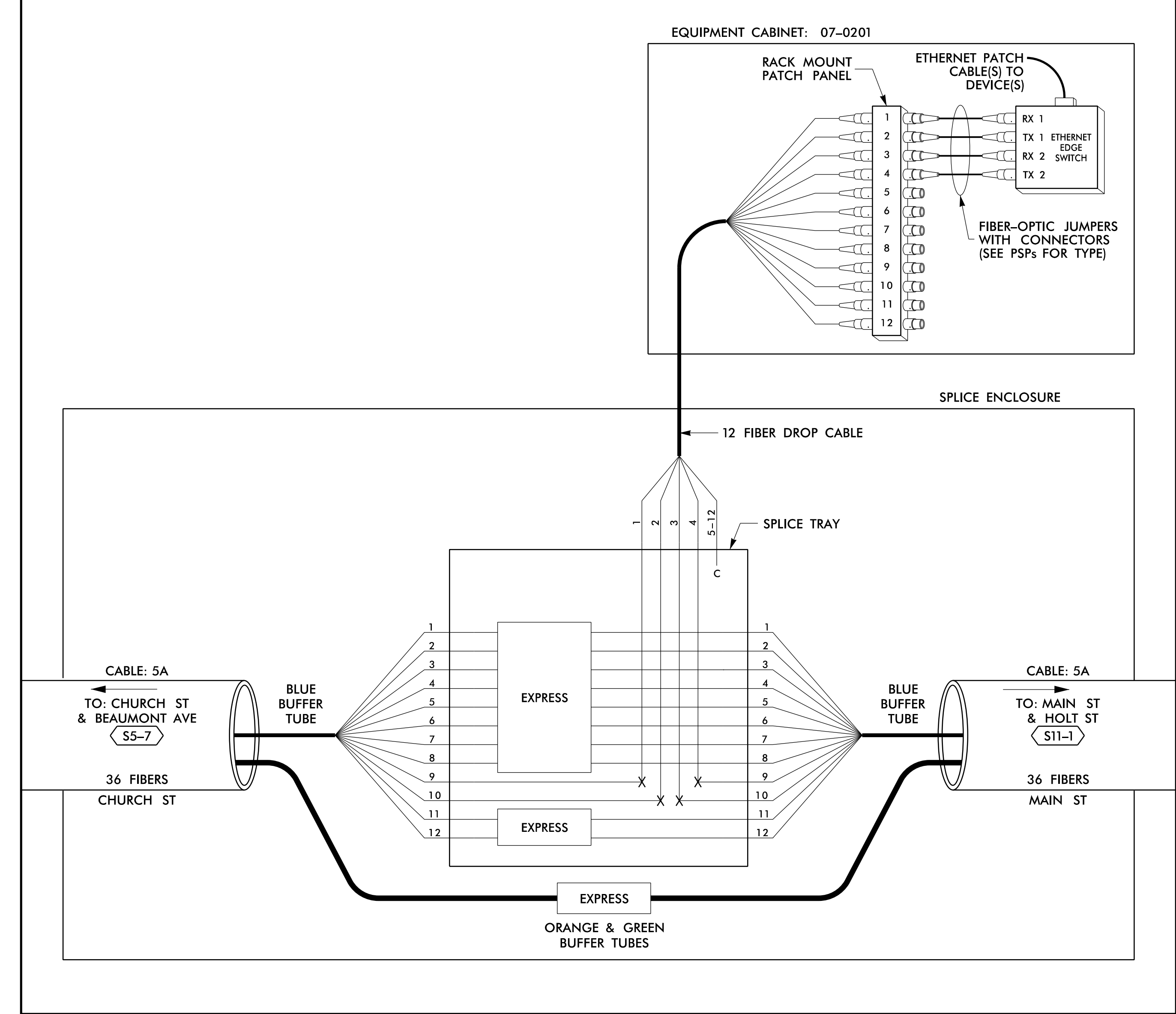

14 JUN 2018 12:19
 D:\projects\proj\11\1100056469 U-6015 B-C Sig Sys\Task 11_Corrs\F5 4.035.dgn
 S:\033633 AT_LUS355433

LEGEND

COLOR CODE TIA/EIA 598-B		X = FUSION SPlice INDIVIDUAL FIBER	
(1) BLUE	(7) RED	EXPRESS	EXPRESS ENTIRE BUFFER TUBE / FIBERS THROUGH WITHOUT CUTTING
(2) ORANGE	(8) BLACK	BUFFER SPlice	SPlice ALL FIBERS IN BUFFER TUBE COLOR TO COLOR
(3) GREEN	(9) YELLOW	EXISTING	EXISTING BUFFER TUBE / FIBERS DO NOT MODIFY EXISTING SPlices OR EXPRESSED FIBERS.
(4) BROWN	(10) VIOLET		
(5) SLATE	(11) ROSE		
(6) WHITE	(12) AQUA		
		C =	CAP AND SEAL

NOTES

- UNUSED FIBERS LEFT COILED AND STORED IN SPLICE TRAY
- UNUSED BUFFER TUBES LEFT COILED AND STORED IN SPLICE ENCLOSURE
- EDGE SWITCH CONFIGURATIONS ARE GENERIC. CONTRACTOR IS RESPONSIBLE FOR DETERMINING/ENSURING THE PROPER TERMINATIONS.

ATKINS 1616 EAST MILLBROOK ROAD, SUITE 160
RALEIGH, NORTH CAROLINA 27609
(919) 876-6888 NCBEEs #F-0326

DOCUMENT NOT CONSIDERED FINAL UNLESS ALL SIGNATURES COMPLETED

	Prepared for the Offices of: 	
	Burlington-Graham Signal System Fiber-Optic Splicing Details	
	Division 7 Alamance County PLAN DATE: June 2018 PREPARED BY: BJ SLOCUM	Burlington & Graham REVIEWED BY: HA BADGETT REVIEWED BY: DL JONES
750 Greenfield Parkway, Garner, NC 27529 SCALE: N/A	REVISIONS: _____ INIT. DATE _____ _____ _____	

DATE: 6/15/2018
CADD Filename: FS 4.035.dgn

SPLICE NO.

S6-1

HARDEN ST & LAVISTA DR
SEE: CRP-6.097

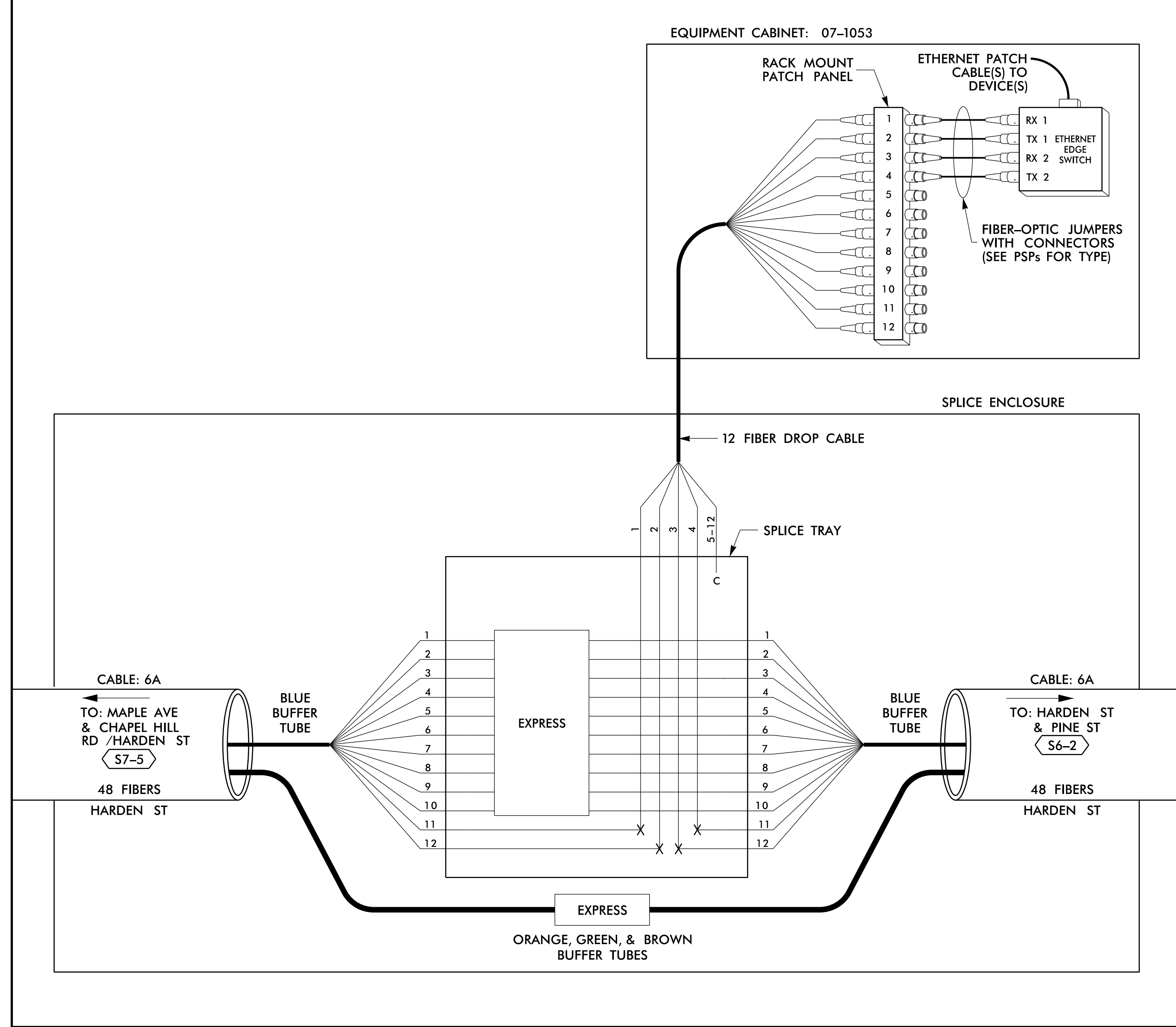

SPLICE NO.

S6-2

HARDEN ST & PINE ST
SEE: CRP-6.099

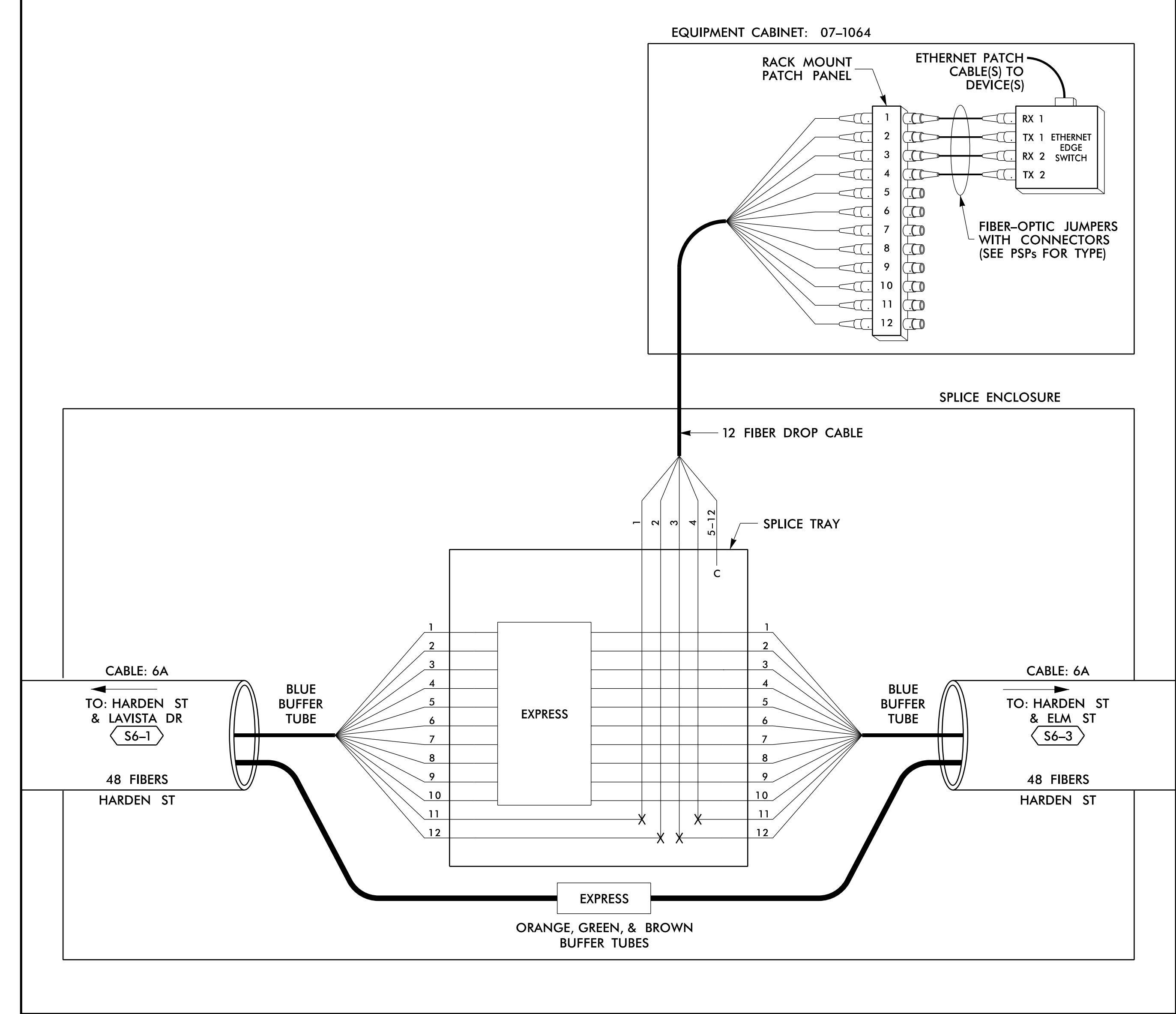

14 JUN 2018 12:19
 D:\projects\atkins\proj\crp\off\crp\100056463 U-6015 B-C Sig Sys\Task 11_Corrs\F S 4.036.dgn
 SLOJ3653 AT LUS355433

LEGEND

COLOR CODE TIA/EIA 598-B		X = FUSION SPlice INDIVIDUAL FIBER	
(1) BLUE	(7) RED	EXPRESS	EXPRESS ENTIRE BUFFER TUBE / FIBERS THROUGH WITHOUT CUTTING
(2) ORANGE	(8) BLACK	BUFFER SPlice	SPlice ALL FIBERS IN BUFFER TUBE COLOR TO COLOR
(3) GREEN	(9) YELLOW	EXISTING	EXISTING BUFFER TUBE / FIBERS DO NOT MODIFY EXISTING SPlices OR EXPRESSED FIBERS.
(4) BROWN	(10) VIOLET		
(5) SLATE	(11) ROSE		
(6) WHITE	(12) AQUA		

NOTES

- UNUSED FIBERS LEFT COILED AND STORED IN SPLICE TRAY
- UNUSED BUFFER TUBES LEFT COILED AND STORED IN SPLICE ENCLOSURE
- EDGE SWITCH CONFIGURATIONS ARE GENERIC. CONTRACTOR IS RESPONSIBLE FOR DETERMINING/ENSURING THE PROPER TERMINATIONS.

ATKINS 1616 EAST MILLBROOK ROAD, SUITE 160
RALEIGH, NORTH CAROLINA 27609
(919) 876-6888 NCBEEES #F-0326

DOCUMENT NOT CONSIDERED FINAL UNLESS ALL SIGNATURES COMPLETED

	Burlington-Graham Signal System Fiber-Optic Splicing Details			
	Division 7 Alamance County	Burlington & Graham		
	PLAN DATE: June 2018	REVIEWED BY: HA BADGETT		REVIEWED BY: DL JONES
	PREPARED BY: BJ SLOCUM	DATE: 6/15/2018		
SCALE: N/A	REVISIONS	INIT.	DATE	

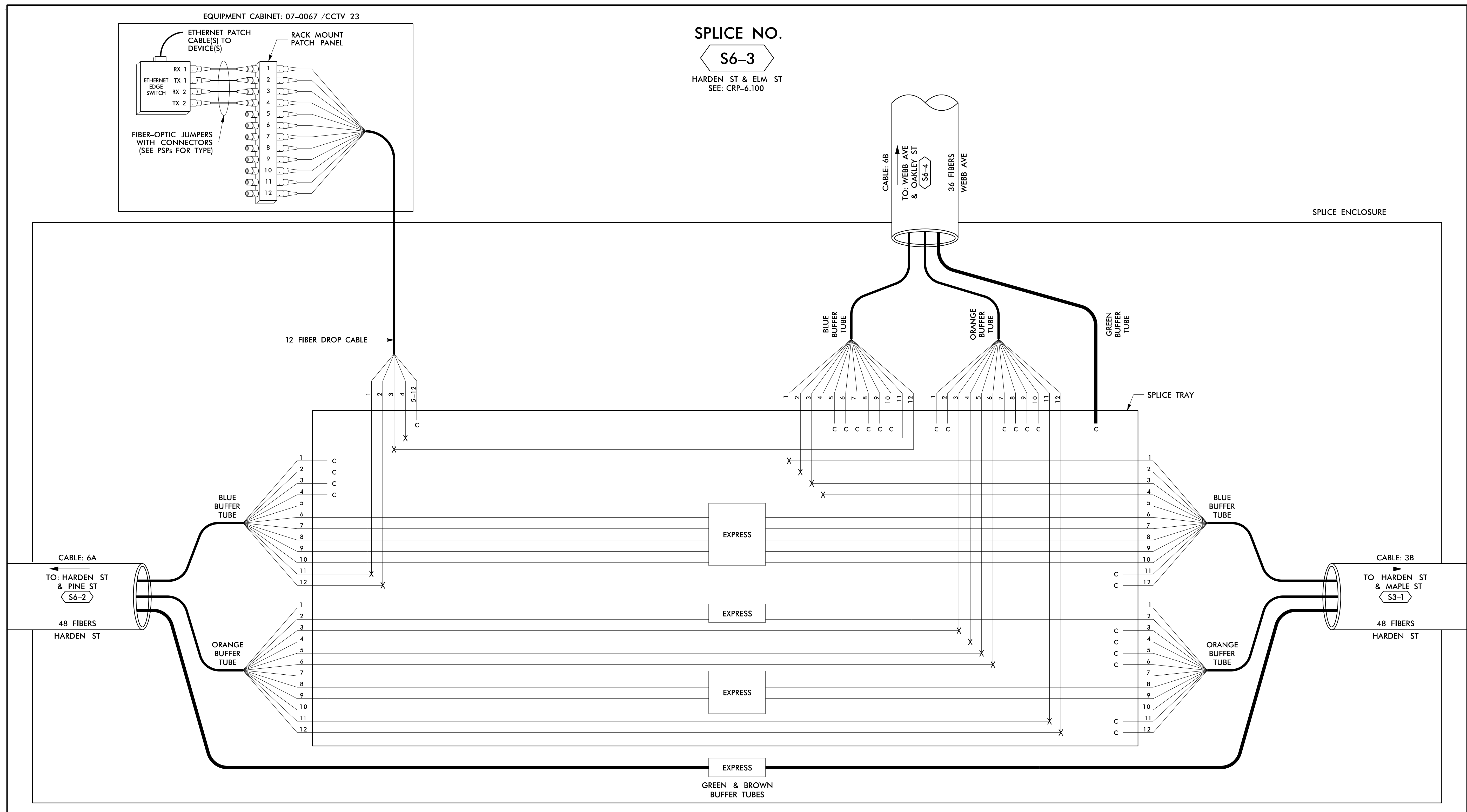

SPLICE NO.
S6-3
 HARDEN ST & ELM ST
 SEE: CRP-6.100

SPLICE ENCLOSURE

LEGEND

EXPRESS	EXPRESS ENTIRE BUFFER TUBE / FIBERS THROUGH WITHOUT CUTTING
BUFFER SPLICE	SPLICE ALL FIBERS IN BUFFER TUBE COLOR TO COLOR
EXISTING	EXISTING BUFFER TUBE / FIBERS DO NOT MODIFY EXISTING SPLICES OR EXPRESSED FIBERS.

X = FUSION SPLICE INDIVIDUAL FIBER
 C = CAP AND SEAL

COLOR CODE
 TIA/EIA 598-B

(1) BLUE	(7) RED
(2) ORANGE	(8) BLACK
(3) GREEN	(9) YELLOW
(4) BROWN	(10) VIOLET
(5) SLATE	(11) ROSE
(6) WHITE	(12) AQUA

- NOTES**
- UNUSED FIBERS LEFT COILED AND STORED IN SPLICE TRAY
 - UNUSED BUFFER TUBES LEFT COILED AND STORED IN SPLICE ENCLOSURE
 - EDGE SWITCH CONFIGURATIONS ARE GENERIC. CONTRACTOR IS RESPONSIBLE FOR DETERMINING/ENSURING THE PROPER TERMINATIONS.

14 JUN 2018 12:19
 D:\Projects\proj\11\comms\11_00056469 U-6015 B-C Sig_Sys\Task 11_Comms\F5 4.037.dgn
 S:\033653 AT_LUS355433

ATKINS 1616 EAST MILLBROOK ROAD, SUITE 160
 RALEIGH, NORTH CAROLINA 27609
 (919) 876-6888 NCBEEES #F-0326

DOCUMENT NOT CONSIDERED FINAL UNLESS ALL SIGNATURES COMPLETED

<p>750 Greenfield Parkway, Garner, NC 27529</p>	<p>Burlington-Graham Signal System Fiber-Optic Splicing Details</p>		
	Division 7 Alamance County PLAN DATE: June 2018 PREPARED BY: BJ SLOCUM	Burlington & Graham REVIEWED BY: HA BADGETT DL JONES	
SCALE: N/A	REVISIONS: _____ INIT. DATE _____		DATE: 15/2018 CADD File name: FS_4.037.dgn

SPLICE NO.

S6-4

WEBB AVE & OAKLEY ST
SEE: CRP-6.126

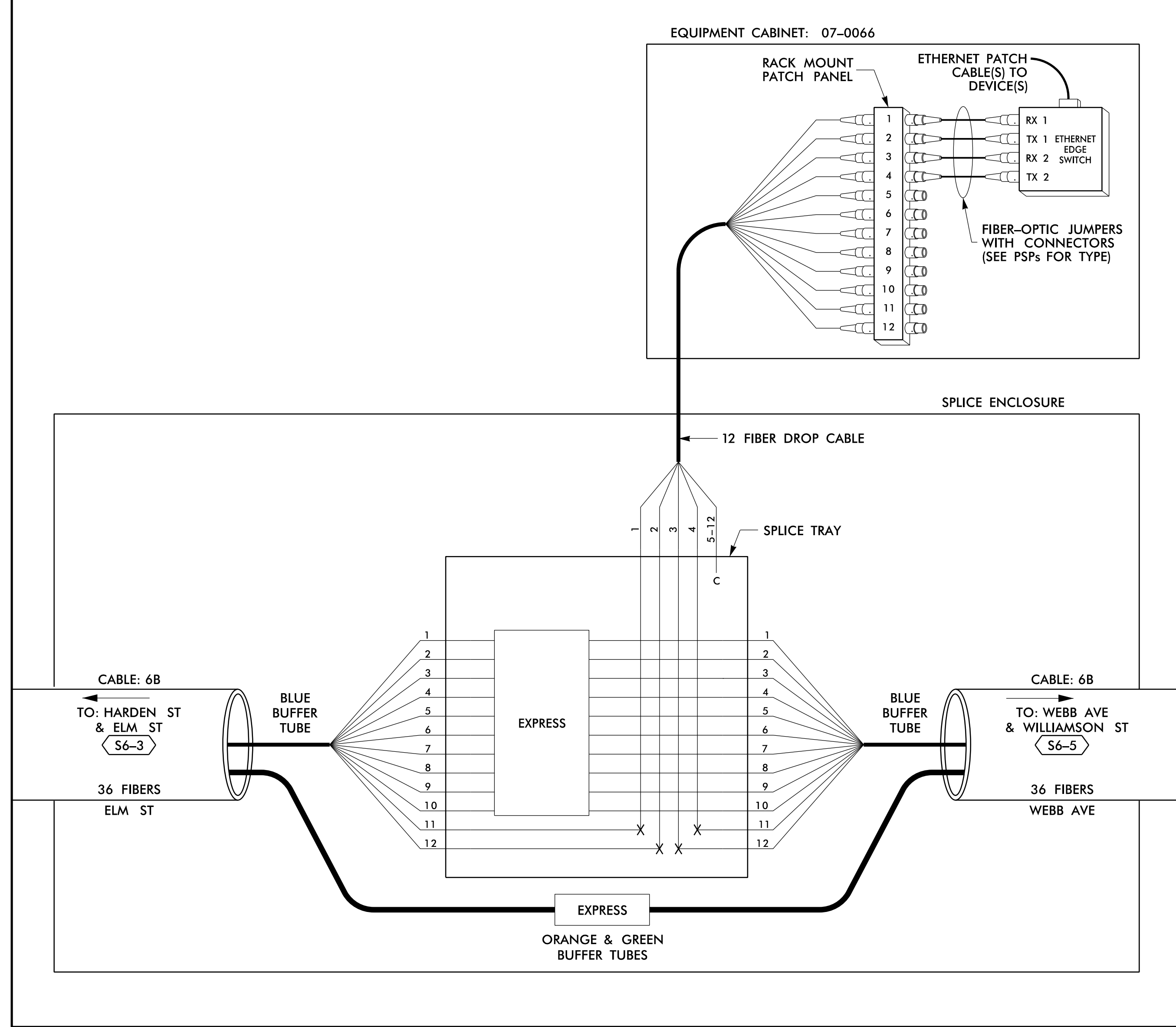

SPLICE NO.

S6-5

WEBB AVE & WILLIAMSON ST
SEE: CRP-6.124

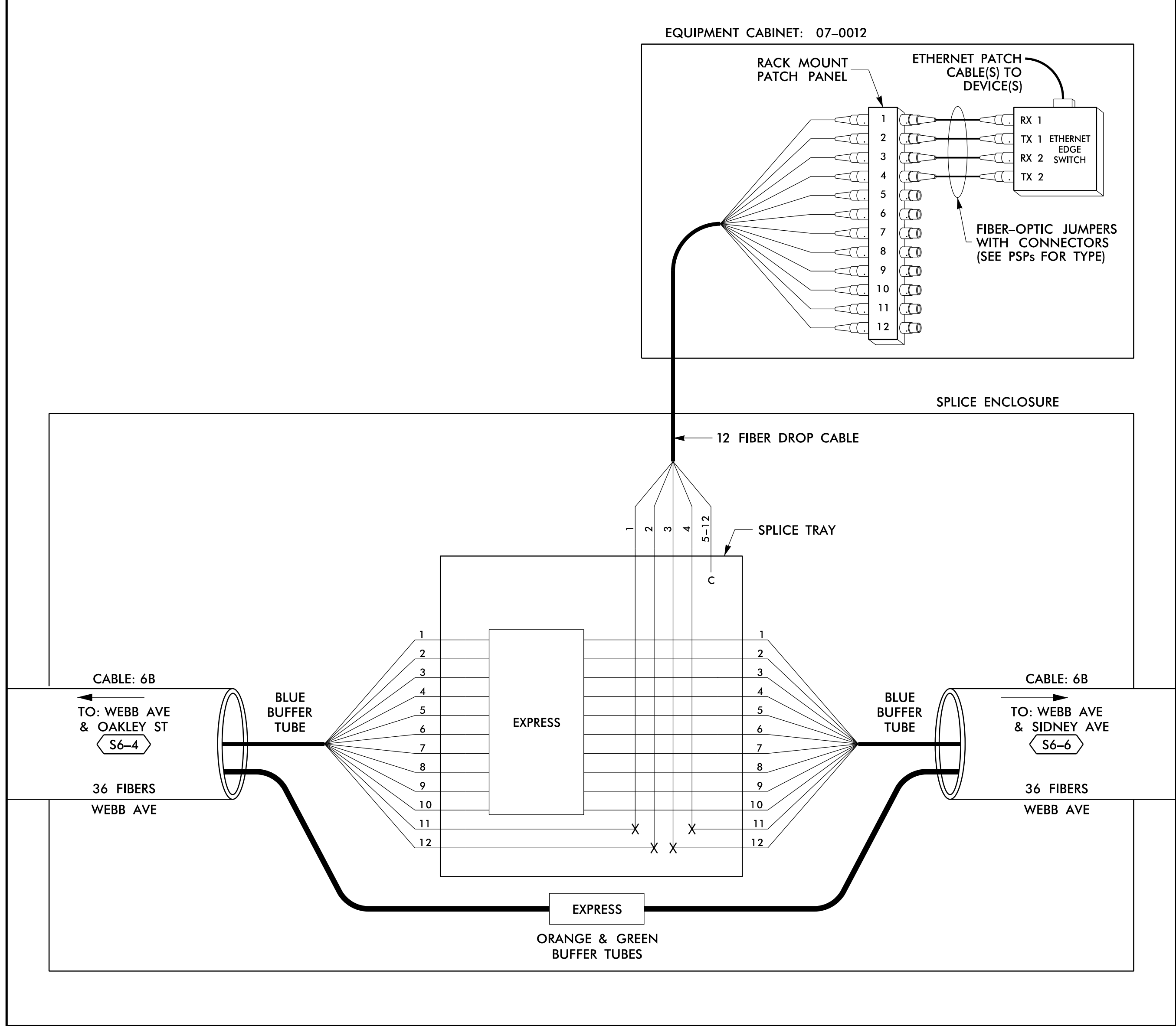

14 JUN 2018 12:19
 D:\Technical\Projects\U-6015 B-C Sig Sys\Task 11_Comm\Fs 4.038.dgn
 S:\CS3653 AT_LUS355433

LEGEND

COLOR CODE TIA/EIA 598-B		X = FUSION SPLICE INDIVIDUAL FIBER	
(1) BLUE	(7) RED	EXPRESS	EXPRESS ENTIRE BUFFER TUBE / FIBERS THROUGH WITHOUT CUTTING
(2) ORANGE	(8) BLACK	BUFFER SPLICE	SPLICE ALL FIBERS IN BUFFER TUBE COLOR TO COLOR
(3) GREEN	(9) YELLOW	EXISTING	EXISTING BUFFER TUBE / FIBERS DO NOT MODIFY EXISTING SPLICES OR EXPRESSED FIBERS.
(4) BROWN	(10) VIOLET		
(5) SLATE	(11) ROSE		
(6) WHITE	(12) AQUA		

NOTES

- UNUSED FIBERS LEFT COILED AND STORED IN SPLICE TRAY
- UNUSED BUFFER TUBES LEFT COILED AND STORED IN SPLICE ENCLOSURE
- EDGE SWITCH CONFIGURATIONS ARE GENERIC. CONTRACTOR IS RESPONSIBLE FOR DETERMINING/ENSURING THE PROPER TERMINATIONS.

ATKINS 1616 EAST MILLBROOK ROAD, SUITE 160
RALEIGH, NORTH CAROLINA 27609
(919) 876-6888 NCBES #F-0326

DOCUMENT NOT CONSIDERED FINAL UNLESS ALL SIGNATURES COMPLETED

	Burlington-Graham Signal System Fiber-Optic Splicing Details		
	Division 7 Alamance County	Burlington & Graham	
PLAN DATE: June 2018	REVIEWED BY: HA BADGETT	PREPARED BY: BJ SLOCUM	REVIEWED BY: DL JONES
SCALE: N/A	REVISIONS	INIT.	DATE

DATE: 6/15/2018
CADD File name: FS 4.038.dgn

SPLICE NO.

S6-6

WEBB AVE & SIDNEY AVE
SEE: CRP-6.123

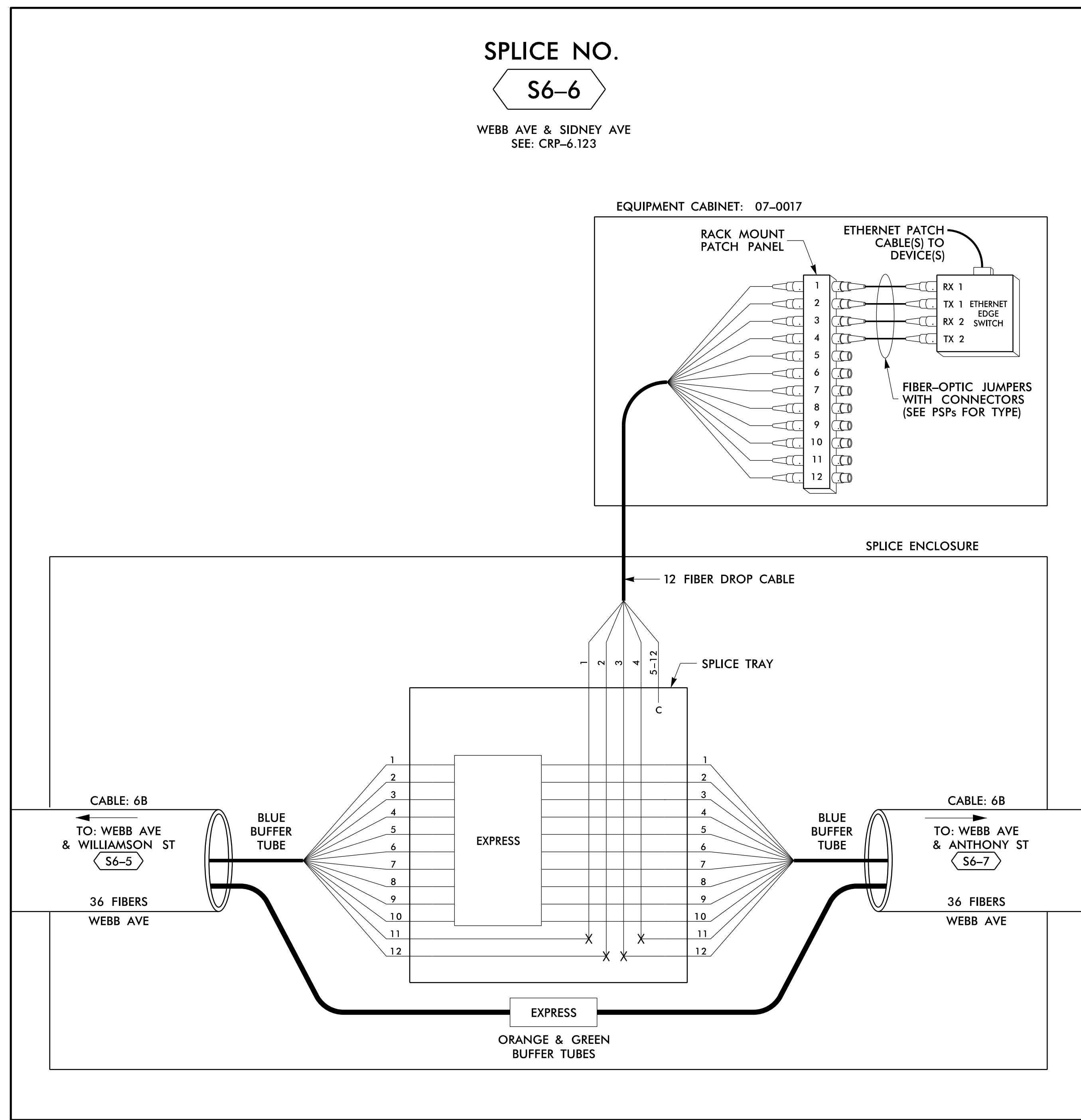

14 JUN 2018 12:19
 D:\Technical\Drawings\Task\U-6015 B-C Sig Sys\Task 11_Corrs\F5 4.039.dgn
 S:\DCS\653 AT_LUS\55433

LEGEND

COLOR CODE TIA/EIA 598-B		X = FUSION SPlice INDIVIDUAL FIBER C = CAP AND SEAL
(1) BLUE	(7) RED	EXPRESS EXPRESS ENTIRE BUFFER TUBE / FIBERS THROUGH WITHOUT CUTTING
(2) ORANGE	(8) BLACK	BUFFER SPlice SPlice ALL FIBERS IN BUFFER TUBE COLOR TO COLOR
(3) GREEN	(9) YELLOW	EXISTING EXISTING BUFFER TUBE / FIBERS DO NOT MODIFY EXISTING SPlices OR EXPRESSED FIBERS.
(4) BROWN	(10) VIOLET	
(5) SLATE	(11) ROSE	
(6) WHITE	(12) AQUA	

NOTES

- UNUSED FIBERS LEFT COILED AND STORED IN SPLICE TRAY
- UNUSED BUFFER TUBES LEFT COILED AND STORED IN SPLICE ENCLOSURE
- EDGE SWITCH CONFIGURATIONS ARE GENERIC. CONTRACTOR IS RESPONSIBLE FOR DETERMINING/ENSURING THE PROPER TERMINATIONS.

ATKINS 1616 EAST MILLBROOK ROAD, SUITE 160
 RALEIGH, NORTH CAROLINA 27609
 (919) 876-6888 NCBEEES #F-0326

DOCUMENT NOT CONSIDERED FINAL UNLESS ALL SIGNATURES COMPLETED

Prepared for the Offices of:  750 Greenfield Parkway, Garner, NC 27529	Burlington-Graham Signal System Fiber-Optic Splicing Details		SEAL NORTH CAROLINA PROFESSIONAL ENGINEER SEAL 040877 BRADFORD J. SLOCUM 15/2018 DATE
	Division 7 Alamance County PLAN DATE: June 2018 PREPARED BY: BJ SLOCUM	Burlington & Graham REVIEWED BY: HA BADGETT REVIEWED BY: DL JONES	
SCALE N/A			CADD File name: FS_4.039.dgn

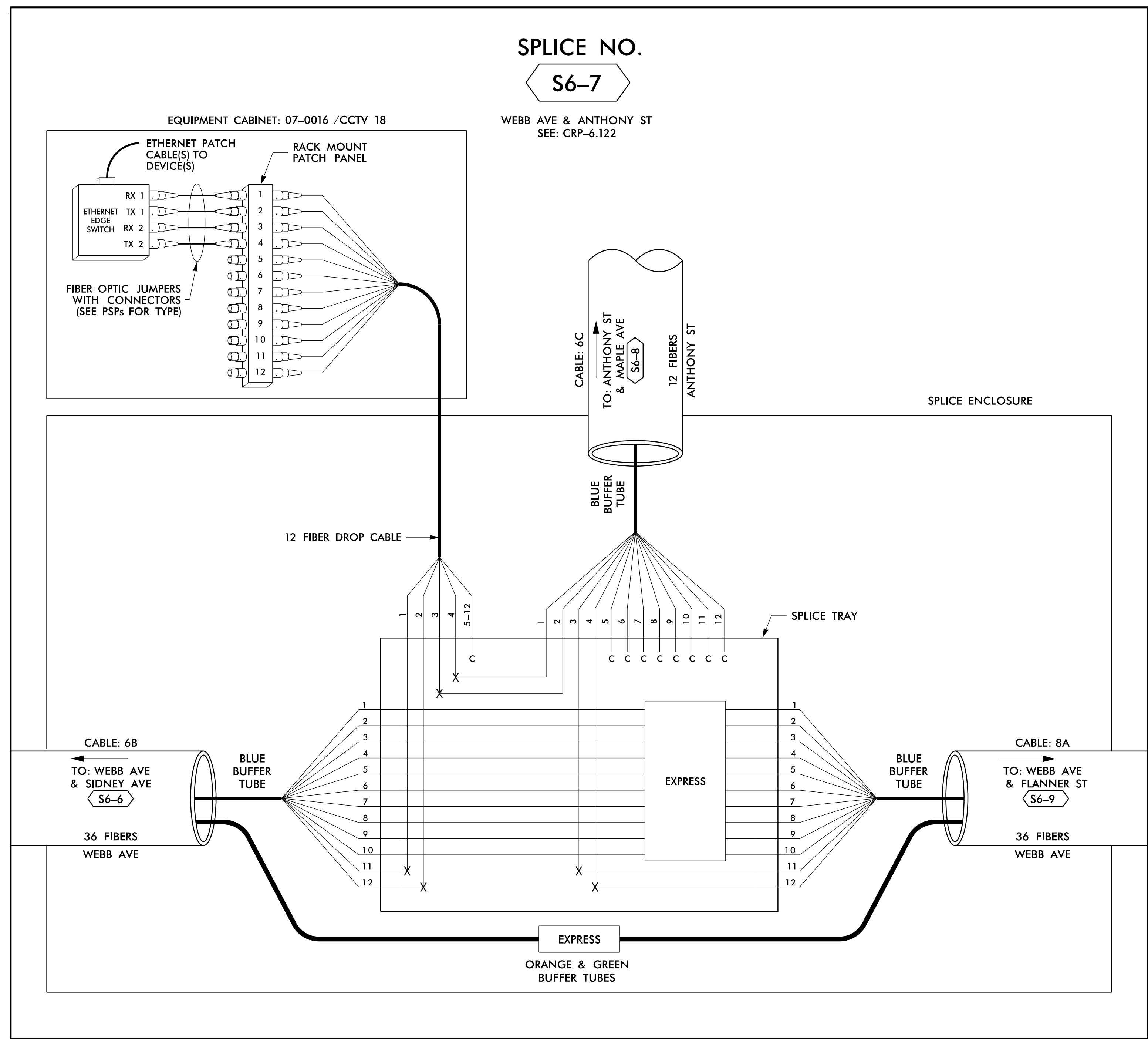

14 JUN 2018 12:20
 D:\Technical\Information\Traffic\Cur*100056469 U=6015 B=C Sig_Sys*Task 11_Corrs*FS 4_040.dgn
 SLOCS363 AT LUS355433

LEGEND

COLOR CODE TIA/EIA 598-B	X = FUSION SPlice INDIVIDUAL FIBER C = CAP AND SEAL
(1) BLUE (7) RED (2) ORANGE (8) BLACK (3) GREEN (9) YELLOW (4) BROWN (10) VIOLET (5) SLATE (11) ROSE (6) WHITE (12) AQUA	EXPRESS BUFFER SPlice EXISTING
	EXPRESS ENTIRE BUFFER TUBE /FIBERS THROUGH WITHOUT CUTTING SPlice ALL FIBERS IN BUFFER TUBE COLOR TO COLOR EXISTING BUFFER TUBE /FIBERS DO NOT MODIFY EXISTING SPlices OR EXPRESSED FIBERS.

- NOTES**
- UNUSED FIBERS LEFT COILED AND STORED IN SPLICE TRAY
 - UNUSED BUFFER TUBES LEFT COILED AND STORED IN SPLICE ENCLOSURE
 - EDGE SWITCH CONFIGURATIONS ARE GENERIC. CONTRACTOR IS RESPONSIBLE FOR DETERMINING/ENSURING THE PROPER TERMINATIONS.

ATKINS 1616 EAST MILLBROOK ROAD, SUITE 160
 RALEIGH, NORTH CAROLINA 27609
 (919) 876-6888 NCBEEs #F-0326

DOCUMENT NOT CONSIDERED FINAL UNLESS ALL SIGNATURES COMPLETED

Prepared for the Offices of: 		Burlington-Graham Signal System Fiber-Optic Splicing Details Division 7 Alamance County Burlington & Graham PLAN DATE: June 2018 REVIEWED BY: HA BADGETT PREPARED BY: BJ SLOCUM REVIEWED BY: DL JONES	
750 Greenfield Parkway, Garner, NC 27529 SCALE: N/A			
REVISIONS INIT. DATE		SEAL NORTH CAROLINA PROFESSIONAL ENGINEER BRADFORD J. SLOCUM 15/2018 DATE	

CADD File name: FS 4.040.dgn

SPLICE NO.

S6-8

ANTHONY ST & MAPLE AVE
SEE: CRP-6.129

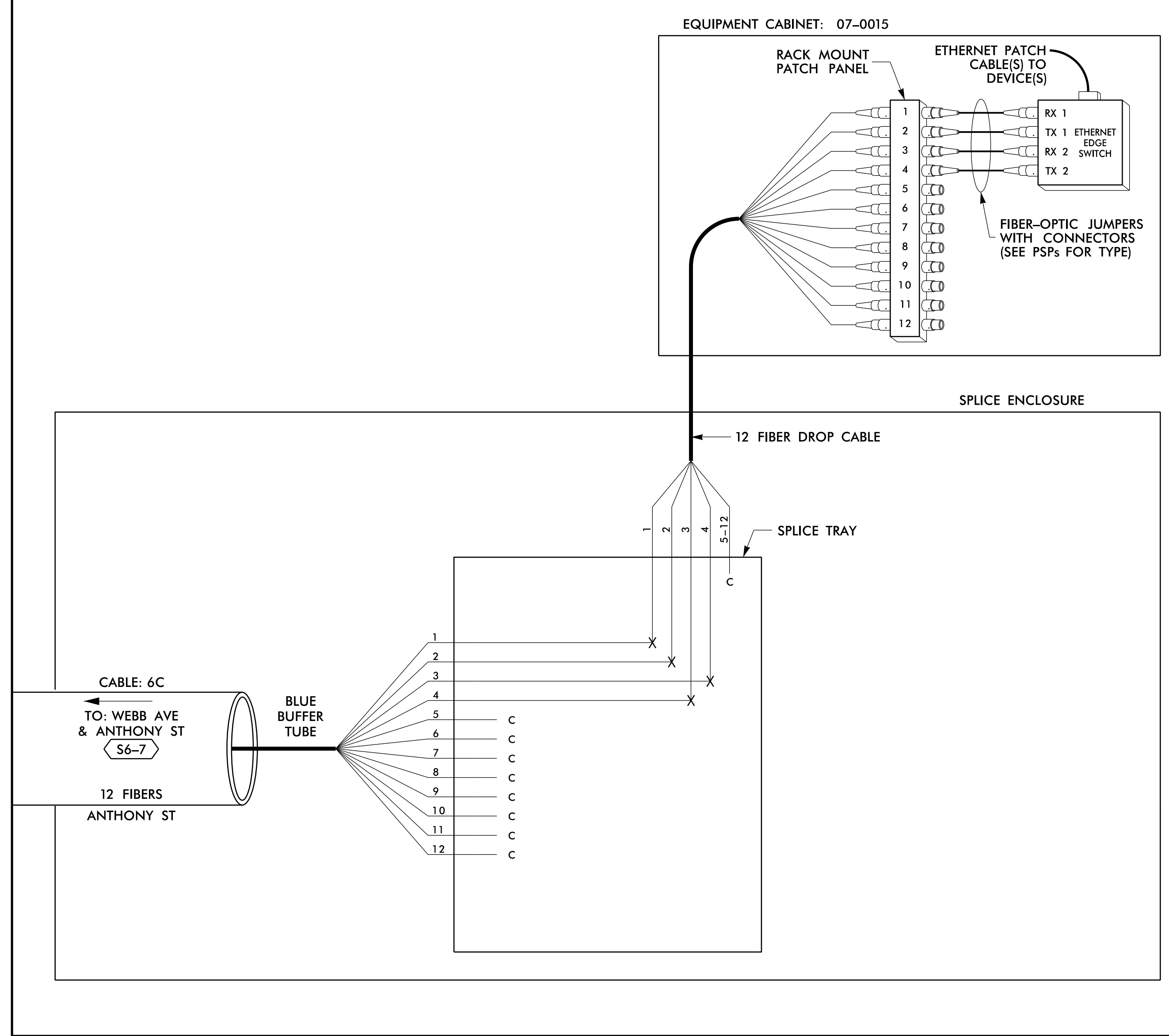

SPLICE NO.

S6-9

WEBB AVE & FLANNER ST
SEE: CRP-6.121

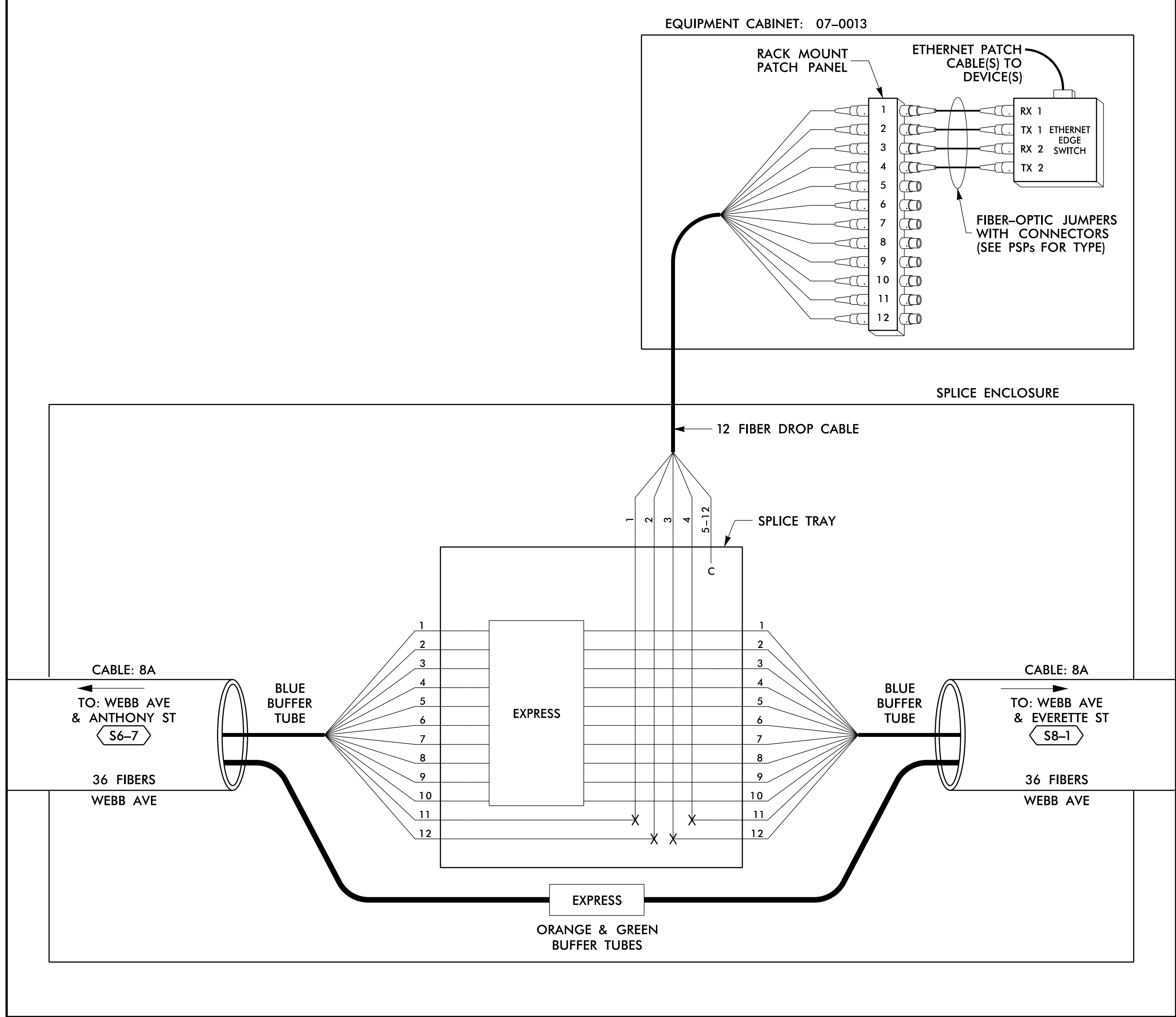

14 JUN 2018 12:20
 D:\projects\atkins\proj\offices\cur\100056469 U-6015 B-C Sig Sys\Task 11_Corrs\F S 4.041.dgn
 SLOD3653 AT LUS355433

LEGEND

COLOR CODE TIA/EIA 598-B		X = FUSION SPlice INDIVIDUAL FIBER C = CAP AND SEAL
(1) BLUE	(7) RED	EXPRESS
(2) ORANGE	(8) BLACK	BUFFER SPlice
(3) GREEN	(9) YELLOW	EXISTING
(4) BROWN	(10) VIOLET	
(5) SLATE	(11) ROSE	
(6) WHITE	(12) AQUA	

EXPRESS ENTIRE BUFFER TUBE / FIBERS THROUGH WITHOUT CUTTING
 SPlice ALL FIBERS IN BUFFER TUBE COLOR TO COLOR
 EXISTING BUFFER TUBE / FIBERS DO NOT MODIFY EXISTING SPlices OR EXPRESSED FIBERS.

NOTES

- UNUSED FIBERS LEFT COILED AND STORED IN SPlice TRAY
- UNUSED BUFFER TUBES LEFT COILED AND STORED IN SPlice ENCLOSURE
- EDGE SWITCH CONFIGURATIONS ARE GENERIC. CONTRACTOR IS RESPONSIBLE FOR DETERMINING/ENSURING THE PROPER TERMINATIONS.

ATKINS 1616 EAST MILLBROOK ROAD, SUITE 160
 RALEIGH, NORTH CAROLINA 27609
 (919) 876-6888 NCBEEs #F-0326

DOCUMENT NOT CONSIDERED FINAL UNLESS ALL SIGNATURES COMPLETED

Prepared for the Offices of: 750 Greenfield Parkway, Garner, NC 27529 SCALE: N/A	Burlington-Graham Signal System Fiber-Optic Splicing Details		SEAL NORTH CAROLINA PROFESSIONAL ENGINEER SEAL 040877 BRADFORD J. SLOCUM 15/2018 DATE
	Division 7 Alamance County PLAN DATE: June 2018 PREPARED BY: BJ SLOCUM	Burlington & Graham REVIEWED BY: HA BADGETT REVIEWED BY: DL JONES	
	REVISIONS	INIT. DATE	
	CADD File name: FS_4.041.dgn		

SPLICE NO.

S7-1

I-40 WB /I-85 SB & TUCKER ST
SEE: CRP-6.198

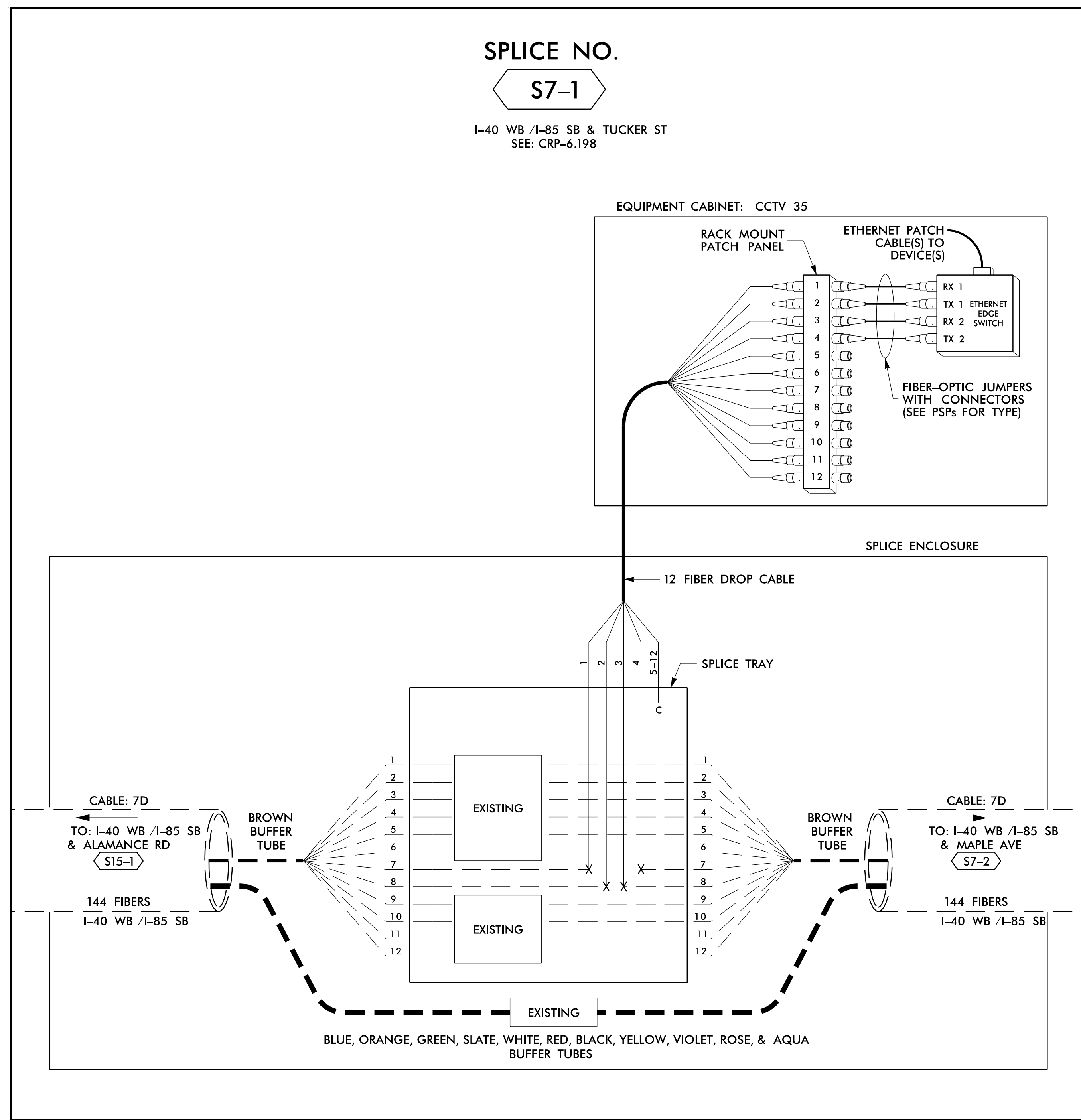

14 JUN 2018 12:20
 D:\Technical\Information\Traffic\Cur\100056469 U-6015 B-C Sig Sys\Task 11_Corrs\F S 4.042.dgn
 SLODC363 AT LUS355433

LEGEND

COLOR CODE TIA/EIA 598-B		X = FUSION SPLICE INDIVIDUAL FIBER C = CAP AND SEAL
(1) BLUE	(7) RED	EXPRESS
(2) ORANGE	(8) BLACK	EXPRESS ENTIRE BUFFER TUBE / FIBERS THROUGH WITHOUT CUTTING
(3) GREEN	(9) YELLOW	BUFFER SPLICE
(4) BROWN	(10) VIOLET	SPLICE ALL FIBERS IN BUFFER TUBE COLOR TO COLOR
(5) SLATE	(11) ROSE	EXISTING
(6) WHITE	(12) AQUA	EXISTING BUFFER TUBE / FIBERS DO NOT MODIFY EXISTING SPLICES OR EXPRESSED FIBERS.

NOTES

- UNUSED FIBERS LEFT COILED AND STORED IN SPLICE TRAY
- UNUSED BUFFER TUBES LEFT COILED AND STORED IN SPLICE ENCLOSURE
- EDGE SWITCH CONFIGURATIONS ARE GENERIC. CONTRACTOR IS RESPONSIBLE FOR DETERMINING/ENSURING THE PROPER TERMINATIONS.

ATKINS 1616 EAST MILLBROOK ROAD, SUITE 160
 RALEIGH, NORTH CAROLINA 27609
 (919) 876-6888 NCBEEES #F-0326

DOCUMENT NOT CONSIDERED FINAL UNLESS ALL SIGNATURES COMPLETED

Prepared for the Offices of:  750 Greenfield Parkway, Garner, NC 27529	Burlington-Graham Signal System Fiber-Optic Splicing Details		SEAL NORTH CAROLINA PROFESSIONAL ENGINEER SEAL 040877 BRADFORD J. SLOCUM 15/2018 DATE
	Division 7 Alamance County PLAN DATE: June 2018 PREPARED BY: BJ SLOCUM	Burlington & Graham REVIEWED BY: HA BADGETT REVIEWED BY: DL JONES	
REVISIONS: INIT. DATE			

SPLICE NO.

S7-2

I-40 WB /I-85 SB & MAPLE AVE
SEE: CRP-6.115

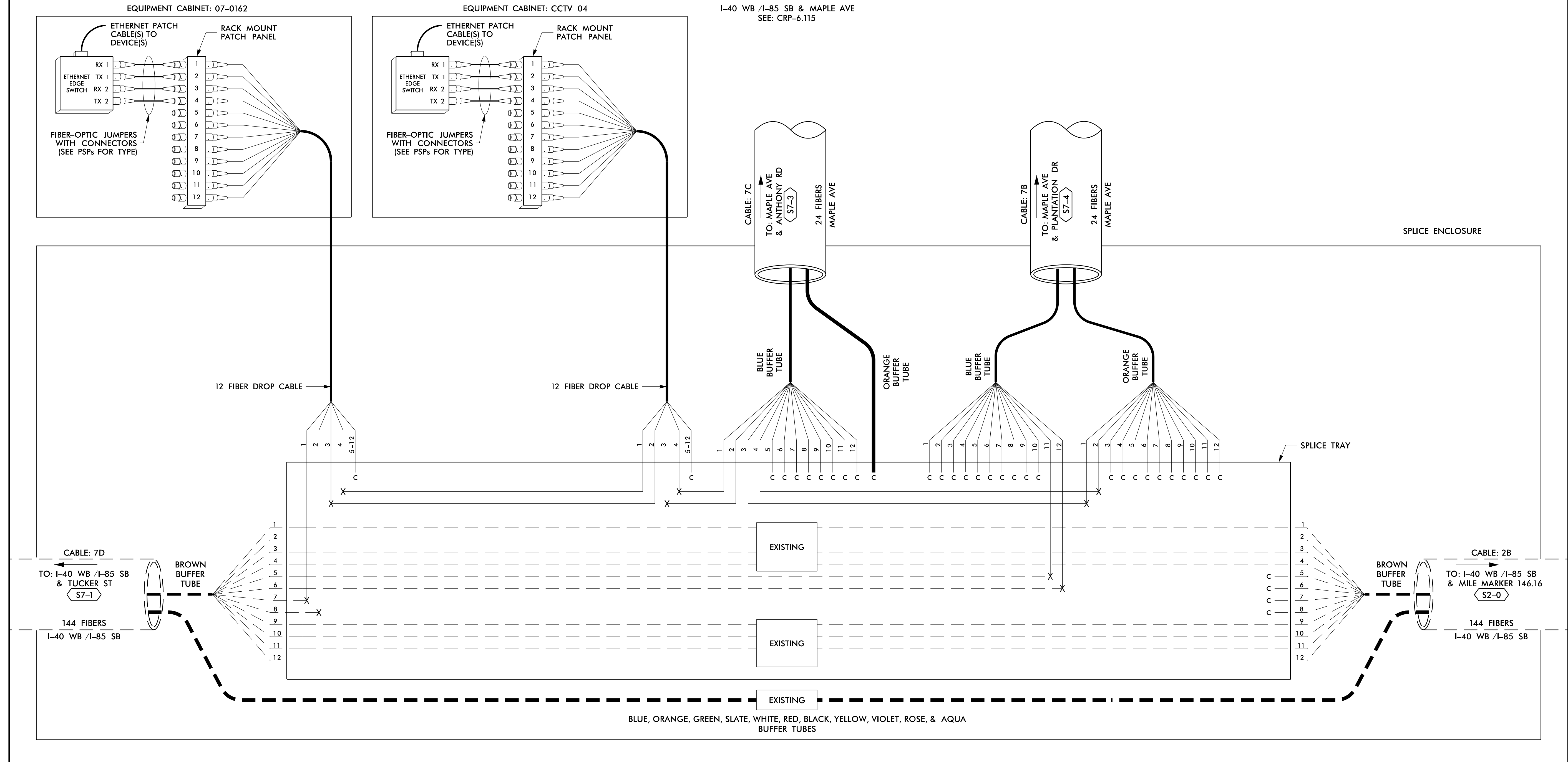

LEGEND

COLOR CODE TIA/EIA 598-B		X = FUSION SPLICE INDIVIDUAL FIBER	
(1) BLUE	(7) RED	EXPRESS	EXPRESS ENTIRE BUFFER TUBE /FIBERS THROUGH WITHOUT CUTTING
(2) ORANGE	(8) BLACK	BUFFER SPLICE	SPLICE ALL FIBERS IN BUFFER TUBE COLOR TO COLOR
(3) GREEN	(9) YELLOW	EXISTING	EXISTING BUFFER TUBE /FIBERS DO NOT MODIFY EXISTING SPLICES OR EXPRESSED FIBERS.
(4) BROWN	(10) VIOLET		
(5) SLATE	(11) ROSE		
(6) WHITE	(12) AQUA		

NOTES

- UNUSED FIBERS LEFT COILED AND STORED IN SPLICE TRAY
- UNUSED BUFFER TUBES LEFT COILED AND STORED IN SPLICE ENCLOSURE
- EDGE SWITCH CONFIGURATIONS ARE GENERIC. CONTRACTOR IS RESPONSIBLE FOR DETERMINING/ENSURING THE PROPER TERMINATIONS.

ATKINS 1616 EAST MILLBROOK ROAD, SUITE 160
RALEIGH, NORTH CAROLINA 27609
(919) 876-6888 NCBEEES #F-0326

	Prepared for the Offices of: NORTH CAROLINA DEPARTMENT OF TRANSPORTATION Transportation Systems		SEAL NORTH CAROLINA PROFESSIONAL ENGINEER SEAL 040877 BRADFORD J. SLOCUM ENGINEER 15/2018 DATE
	Burlington-Graham Signal System Fiber-Optic Splicing Details		
	Division 7 Alamance County PLAN DATE: June 2018 PREPARED BY: BJ SLOCUM	Burlington & Graham REVIEWED BY: HA BADGETT REVIEWED BY: DL JONES	
	750 Greenfield Parkway, Garner, NC 27529 SCALE: N/A	REVISIONS INIT. DATE	

14 JUN 2018 12:20
 D:\projects\atkins\proj\11\1100056469 U-6015 B-C Sig_Sys\Task 11_Comms\F S 4.043.dgn
 S:\035633 AT_LUS355433

SPLICE NO.

S7-3

MAPLE AVE & HANFORD RD
SEE: CRP-6.114

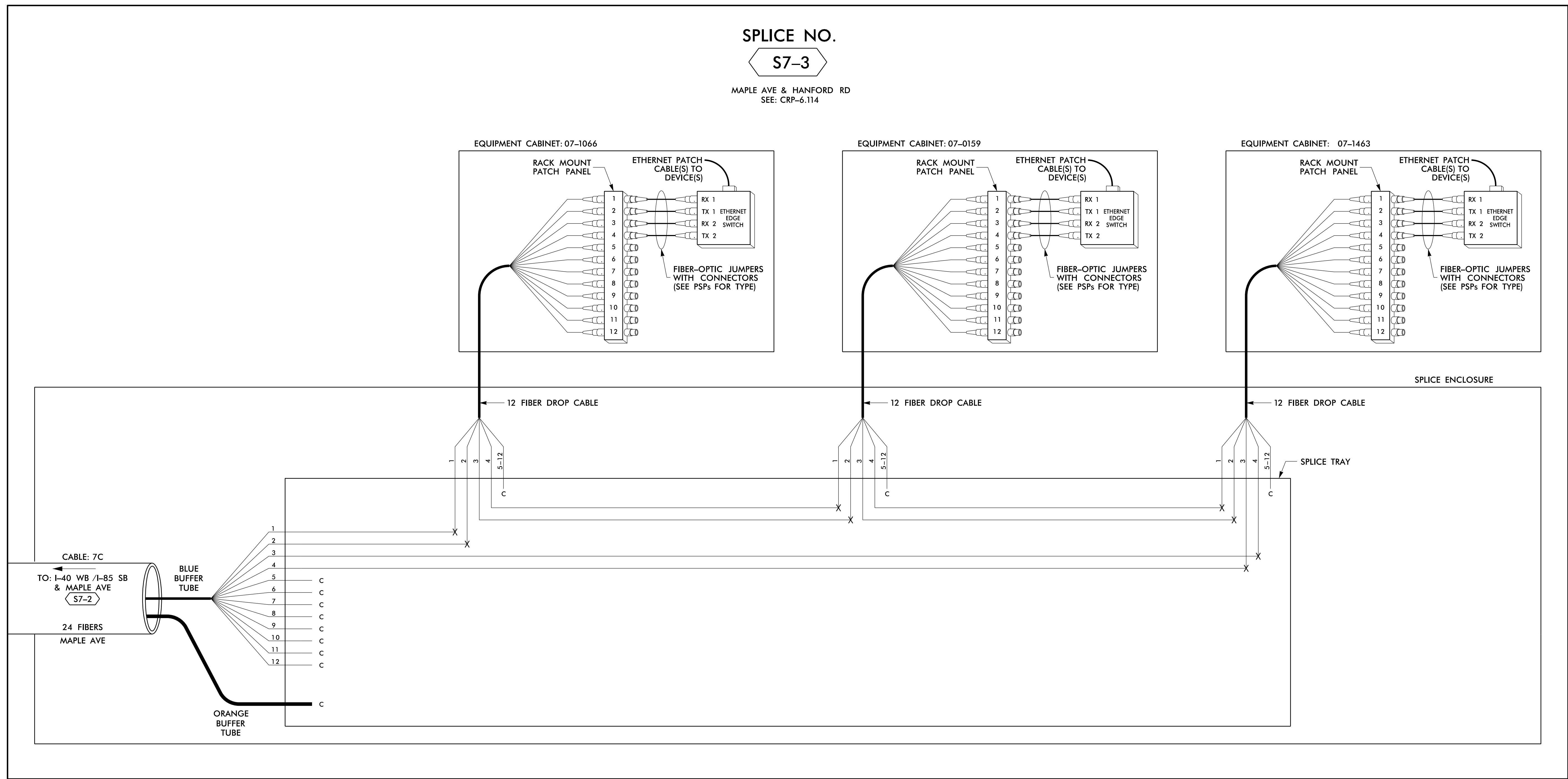

LEGEND

COLOR CODE TIA/EIA 598-B		X = FUSION SPLICE INDIVIDUAL FIBER	
(1) BLUE	(7) RED	EXPRESS	EXPRESS ENTIRE BUFFER TUBE / FIBERS THROUGH WITHOUT CUTTING
(2) ORANGE	(8) BLACK	BUFFER SPLICE	SPLICE ALL FIBERS IN BUFFER TUBE COLOR TO COLOR
(3) GREEN	(9) YELLOW	EXISTING	EXISTING BUFFER TUBE / FIBERS DO NOT MODIFY EXISTING SPLICES OR EXPRESSED FIBERS.
(4) BROWN	(10) VIOLET		
(5) SLATE	(11) ROSE		
(6) WHITE	(12) AQUA		

NOTES

1. UNUSED FIBERS LEFT COILED AND STORED IN SPLICE TRAY
2. UNUSED BUFFER TUBES LEFT COILED AND STORED IN SPLICE ENCLOSURE
3. EDGE SWITCH CONFIGURATIONS ARE GENERIC. CONTRACTOR IS RESPONSIBLE FOR DETERMINING/ENSURING THE PROPER TERMINATIONS.

ATKINS 1616 EAST MILLBROOK ROAD, SUITE 160
RALEIGH, NORTH CAROLINA 27609
(919) 876-6888 NCBEEES #F-0326

DOCUMENT NOT CONSIDERED FINAL
UNLESS ALL SIGNATURES COMPLETED

<p>Prepared for the Offices of: NORTH CAROLINA DEPARTMENT OF TRANSPORTATION 750 Greenfield Parkway, Garner, NC 27529</p>	<p>Burlington-Graham Signal System Fiber-Optic Splicing Details</p>			
	Division 7	Alamance County		Burlington & Graham
	PLAN DATE: June 2018	REVIEWED BY: HA BADGETT		
	PREPARED BY: BJ SLOCUM	REVIEWED BY: DL JONES		
SCALE: N/A	REVISIONS	INIT.	DATE	

14 JUN 2018 12:20
 D:\projects\atkins\proj\offices\cur\100056469 U-6015 B-C Sig_Sys\Task 11_Comms\F S 4.044.dgn
 S:\DCS\653 AT_LUS355433

SPLICE NO.

S7-4

MAPLE AVE & PLANTATION DR
SEE: CRP-6.115

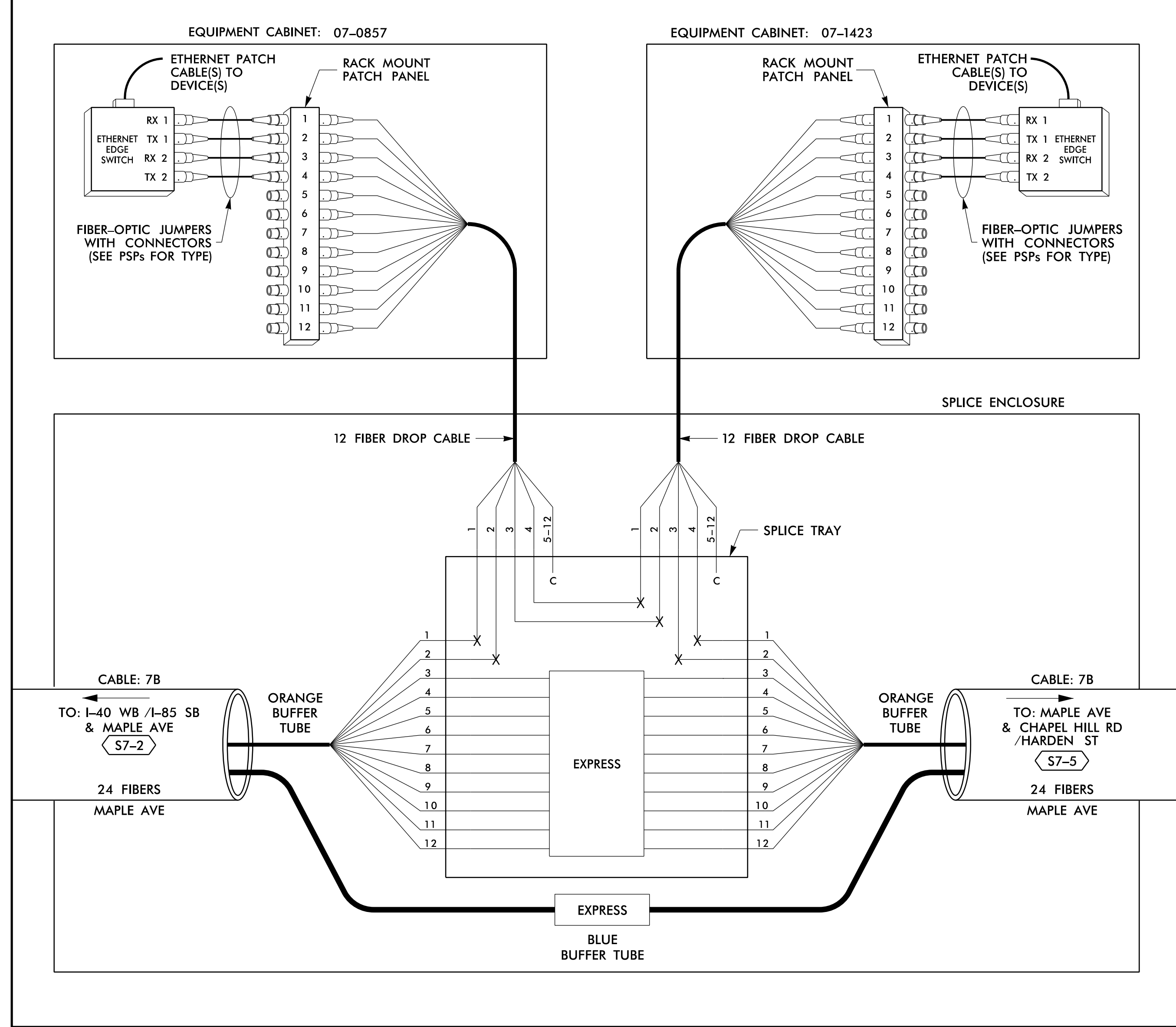

LEGEND

COLOR CODE TIA/EIA 598-B		X = FUSION SPLICE INDIVIDUAL FIBER	
(1) BLUE	(7) RED	EXPRESS	EXPRESS ENTIRE BUFFER TUBE / FIBERS THROUGH WITHOUT CUTTING
(2) ORANGE	(8) BLACK	BUFFER SPLICE	SPLICE ALL FIBERS IN BUFFER TUBE COLOR TO COLOR
(3) GREEN	(9) YELLOW	EXISTING	EXISTING BUFFER TUBE / FIBERS DO NOT MODIFY EXISTING SPLICES OR EXPRESSED FIBERS.
(4) BROWN	(10) VIOLET		
(5) SLATE	(11) ROSE		
(6) WHITE	(12) AQUA		

NOTES

- UNUSED FIBERS LEFT COILED AND STORED IN SPLICE TRAY
- UNUSED BUFFER TUBES LEFT COILED AND STORED IN SPLICE ENCLOSURE
- EDGE SWITCH CONFIGURATIONS ARE GENERIC. CONTRACTOR IS RESPONSIBLE FOR DETERMINING/ENSURING THE PROPER TERMINATIONS.

14 JUN 2018 12:20
 D:\Technical\Information\Triff\c\Cur*100056469 U=6015 B=C Sig Sys\Task 11_Corrs\F S 4.045.dgn
 SLODC3633 AT LUS355433

ATKINS 1616 EAST MILLBROOK ROAD, SUITE 160
RALEIGH, NORTH CAROLINA 27609
(919) 876-6888 NCBEE# F-0326

**DOCUMENT NOT CONSIDERED FINAL
UNLESS ALL SIGNATURES COMPLETED**

 Prepared for the Offices of: NORTH CAROLINA DEPARTMENT OF TRANSPORTATION Transportation Systems	Burlington-Graham Signal System Fiber-Optic Splicing Details		SEAL NORTH CAROLINA PROFESSIONAL SEAL 040877 ENGINEER Bradford J. Slocum 15/2018
	Division 7 Alamance County Burlington & Graham	PLAN DATE: June 2018 REVIEWED BY: HA BADGETT	
750 Greenfield Parkway, Garner, NC 27529 SCALE: N/A	PREPARED BY: BJ SLOCUM	REVIEWED BY: DL JONES	REVISIONS INIT. DATE

SPLICE NO.

S7-5

MAPLE AVE & CHAPEL HILL RD/HARDEN ST
SEE: CRP-6.096

EQUIPMENT CABINET: 07-0043 /CCTV 37

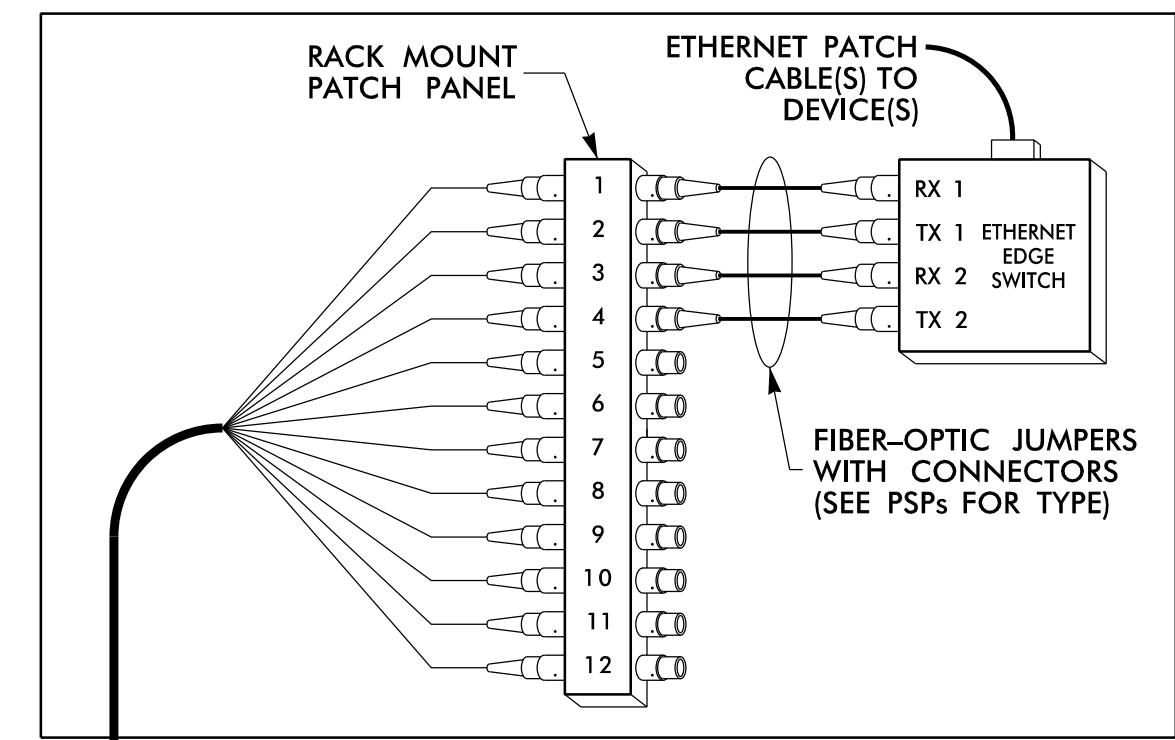

SPLICE ENCLOSURE

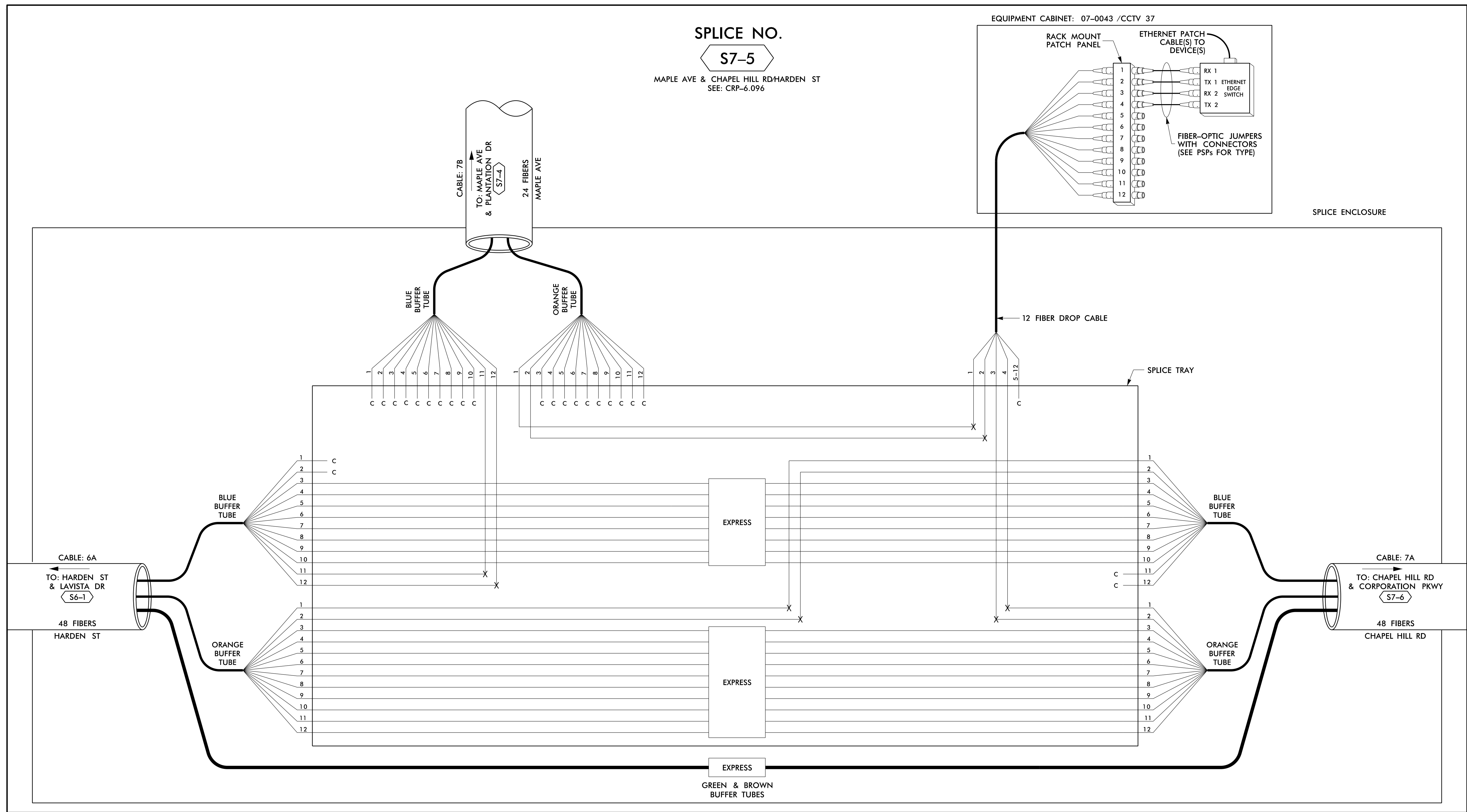

14 JUN 2018 12:20 D:\projects\atkins\proj\offices\cur\100056469 U-6015 B-C Sig Sys\Task 11_Coms#FS 4.046.dgn S:\DCS\653 AT_LUS355433

LEGEND

COLOR CODE TIA/EIA 598-B		X = FUSION SPlice INDIVIDUAL FIBER	
(1) BLUE	(7) RED	EXPRESS	EXPRESS ENTIRE BUFFER TUBE /FIBERS THROUGH WITHOUT CUTTING
(2) ORANGE	(8) BLACK	BUFFER SPlice	SPlice ALL FIBERS IN BUFFER TUBE COLOR TO COLOR
(3) GREEN	(9) YELLOW	EXISTING	EXISTING BUFFER TUBE /FIBERS DO NOT MODIFY EXISTING SPlices OR EXPRESSED FIBERS.
(4) BROWN	(10) VIOLET		
(5) SLATE	(11) ROSE		
(6) WHITE	(12) AQUA		
		C =	CAP AND SEAL

NOTES

- UNUSED FIBERS LEFT COILED AND STORED IN SPLICE TRAY
- UNUSED BUFFER TUBES LEFT COILED AND STORED IN SPLICE ENCLOSURE
- EDGE SWITCH CONFIGURATIONS ARE GENERIC. CONTRACTOR IS RESPONSIBLE FOR DETERMINING/ENSURING THE PROPER TERMINATIONS.

ATKINS

1616 EAST MILLBROOK ROAD, SUITE 160
RALEIGH, NORTH CAROLINA 27609
(919) 876-6888 NCBEE# F-0326

DOCUMENT NOT CONSIDERED FINAL
UNLESS ALL SIGNATURES COMPLETED

	Burlington-Graham Signal System Fiber-Optic Splicing Details									
	Division 7 PLAN DATE: June 2018 PREPARED BY: BJ SLOCUM	Alamance County REVIEWED BY: HA BADGETT REVIEWED BY: DL JONES								
750 Greenfield Parkway, Garner, NC 27529 SCALE: N/A	Revisions Table: <table border="1"> <tr> <th>NO.</th> <th>REVISIONS</th> <th>INIT.</th> <th>DATE</th> </tr> <tr> <td> </td> <td> </td> <td> </td> <td> </td> </tr> </table>	NO.	REVISIONS	INIT.	DATE					Burlington & Graham SEAL 040877 ENGINEER Bradford J. Slocum 15/2018 DATE
NO.	REVISIONS	INIT.	DATE							

SPLICE NO.
S7-6

CHAPEL HILL RD & CORPORATION PKWY
SEE: CRP-6.095

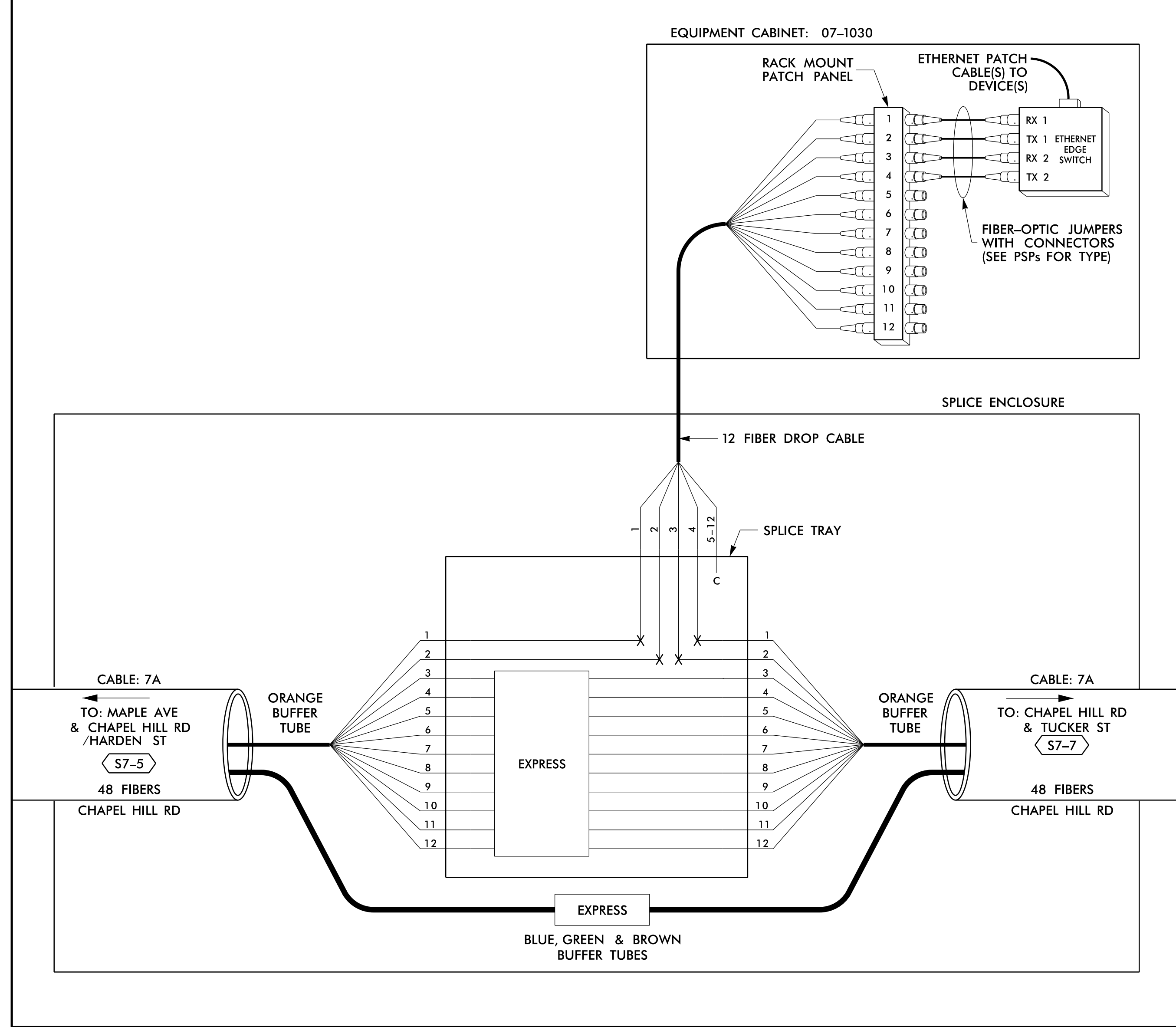

SPLICE NO.
S7-7

CHAPEL HILL RD & TUCKER ST
SEE: CRP-6.092

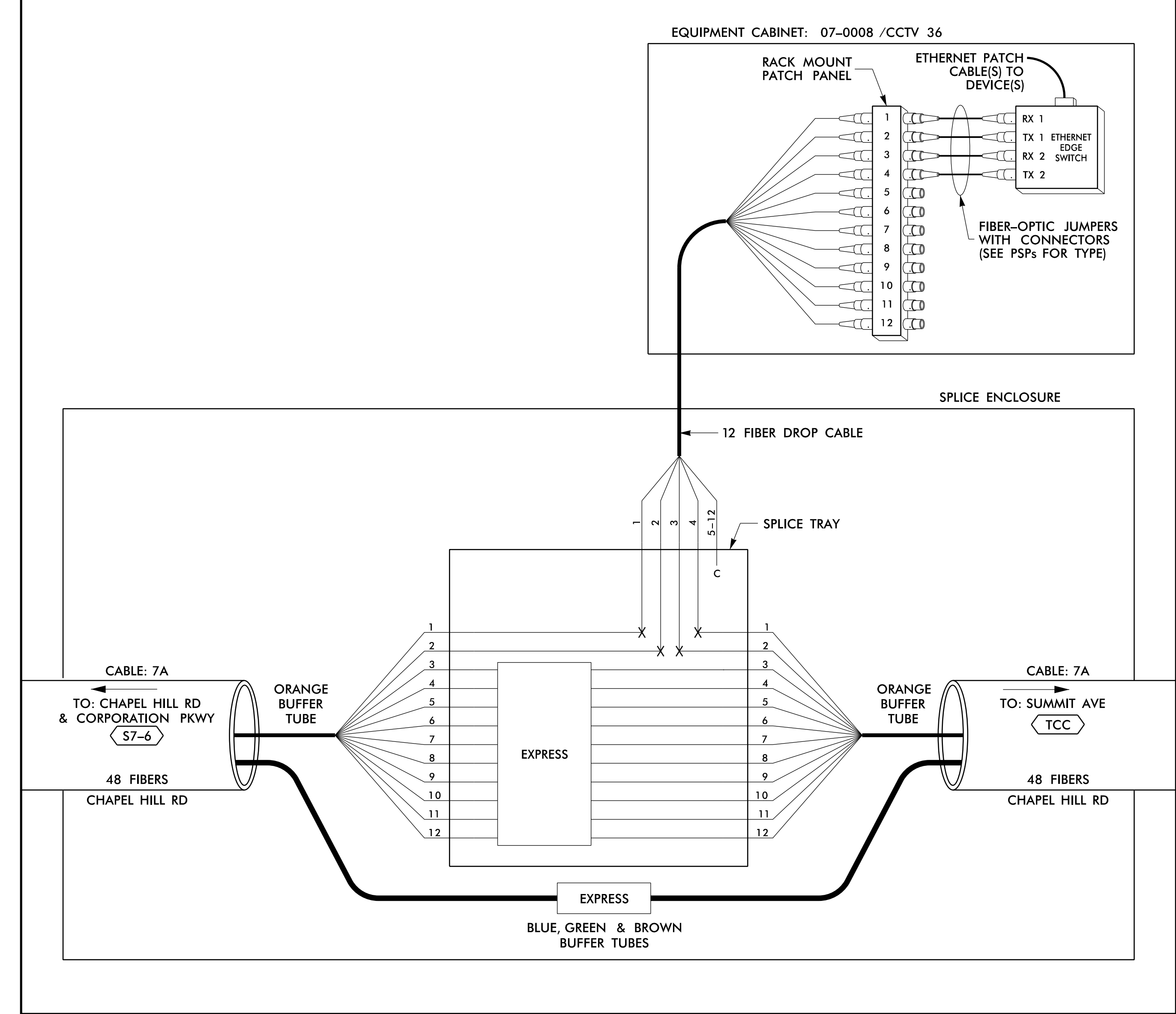

14 JUN 2018 12:20
 D:\projects\proj\chapel\tr\off\c\cur\100056469 U-6015 B-C Sig Sys\Task 11_Corps\F S 4.047.dgn
 SLOD3653 AT LUS355433

LEGEND

COLOR CODE TIA/EIA 598-B		X = FUSION SPLICE INDIVIDUAL FIBER	EXPRESS	EXPRESS ENTIRE BUFFER TUBE / FIBERS THROUGH WITHOUT CUTTING
(1) BLUE	(7) RED	C = CAP AND SEAL	BUFFER SPLICE	SPLICE ALL FIBERS IN BUFFER TUBE COLOR TO COLOR
(2) ORANGE	(8) BLACK		EXISTING	EXISTING BUFFER TUBE / FIBERS DO NOT MODIFY EXISTING SPLICES OR EXPRESSED FIBERS.
(3) GREEN	(9) YELLOW			
(4) BROWN	(10) VIOLET			
(5) SLATE	(11) ROSE			
(6) WHITE	(12) AQUA			

NOTES

- UNUSED FIBERS LEFT COILED AND STORED IN SPLICE TRAY
- UNUSED BUFFER TUBES LEFT COILED AND STORED IN SPLICE ENCLOSURE
- EDGE SWITCH CONFIGURATIONS ARE GENERIC. CONTRACTOR IS RESPONSIBLE FOR DETERMINING/ENSURING THE PROPER TERMINATIONS.

ATKINS 1616 EAST MILLBROOK ROAD, SUITE 160
RALEIGH, NORTH CAROLINA 27609
(919) 876-6888 NCBEE# F-0326

DOCUMENT NOT CONSIDERED FINAL UNLESS ALL SIGNATURES COMPLETED

<p>750 Greenfield Parkway, Garner, NC 27529</p>	<p>Burlington-Graham Signal System Fiber-Optic Splicing Details</p>										
	<p>Division 7 Alamance County</p>	<p>Burlington & Graham</p>									
	<p>PLAN DATE: June 2018</p>	<p>REVIEWED BY: HA BADGETT</p>									
	<p>PREPARED BY: BJ SLOCUM</p>	<p>REVIEWED BY: DL JONES</p>									
<p>SCALE: N/A</p>	<table border="1"> <thead> <tr> <th>REVISIONS</th> <th>INIT.</th> <th>DATE</th> </tr> </thead> <tbody> <tr> <td> </td> <td> </td> <td> </td> </tr> <tr> <td> </td> <td> </td> <td> </td> </tr> </tbody> </table>	REVISIONS	INIT.	DATE							<p>DATE: 15/2018</p> <p>DATE: 15/2018</p>
REVISIONS	INIT.	DATE									

SPLICE NO.

S8-1

WEBB AVE & EVERETTE ST
SEE: CRP-6.121

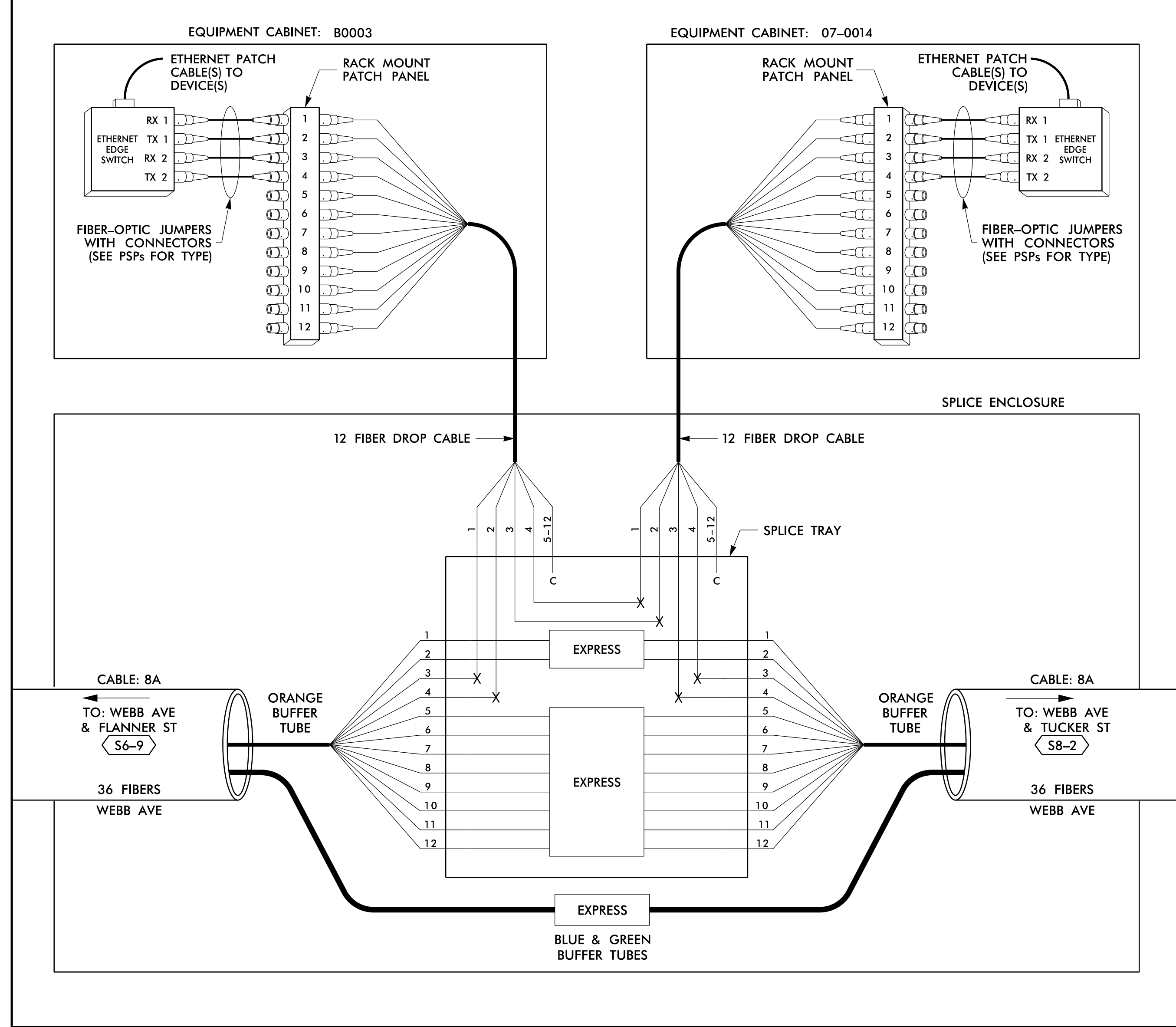

14-JUN-2018 12:20
 D:\Technical\Information\Traffic\Cur*100056469 U-6015 B-C Sig_Sys*Task 11_Corrs*FS 4.048.dgn
 S:\DCS\653 AT_LUS355433

LEGEND

COLOR CODE TIA/EIA 598-B		X = FUSION SPLICE INDIVIDUAL FIBER C = CAP AND SEAL
(1) BLUE	(7) RED	EXPRESS
(2) ORANGE	(8) BLACK	BUFFER SPLICE
(3) GREEN	(9) YELLOW	EXISTING
(4) BROWN	(10) VIOLET	
(5) SLATE	(11) ROSE	
(6) WHITE	(12) AQUA	

EXPRESS ENTIRE BUFFER TUBE / FIBERS THROUGH WITHOUT CUTTING
 SPLICE ALL FIBERS IN BUFFER TUBE COLOR TO COLOR
 EXISTING BUFFER TUBE / FIBERS DO NOT MODIFY EXISTING SPLICES OR EXPRESSED FIBERS.

NOTES

- UNUSED FIBERS LEFT COILED AND STORED IN SPLICE TRAY
- UNUSED BUFFER TUBES LEFT COILED AND STORED IN SPLICE ENCLOSURE
- EDGE SWITCH CONFIGURATIONS ARE GENERIC. CONTRACTOR IS RESPONSIBLE FOR DETERMINING/ENSURING THE PROPER TERMINATIONS.

ATKINS 1616 EAST MILLBROOK ROAD, SUITE 160
 RALEIGH, NORTH CAROLINA 27609
 (919) 876-6888 NCBEEES #F-0326

DOCUMENT NOT CONSIDERED FINAL UNLESS ALL SIGNATURES COMPLETED

Prepared for the Offices of: NORTH CAROLINA DEPARTMENT OF TRANSPORTATION 750 Greenfield Parkway, Garner, NC 27529	Burlington-Graham Signal System Fiber-Optic Splicing Details		SEAL NORTH CAROLINA PROFESSIONAL ENGINEER SEAL 040877 BRADFORD J. SLOCUM 15/2018 DATE
	Division 7 Alamance County PLAN DATE: June 2018 PREPARED BY: BJ SLOCUM	Burlington & Graham REVIEWED BY: HA BADGETT REVIEWED BY: DL JONES	
SCALE N/A			CAD00 File name: FS 4.048.dgn

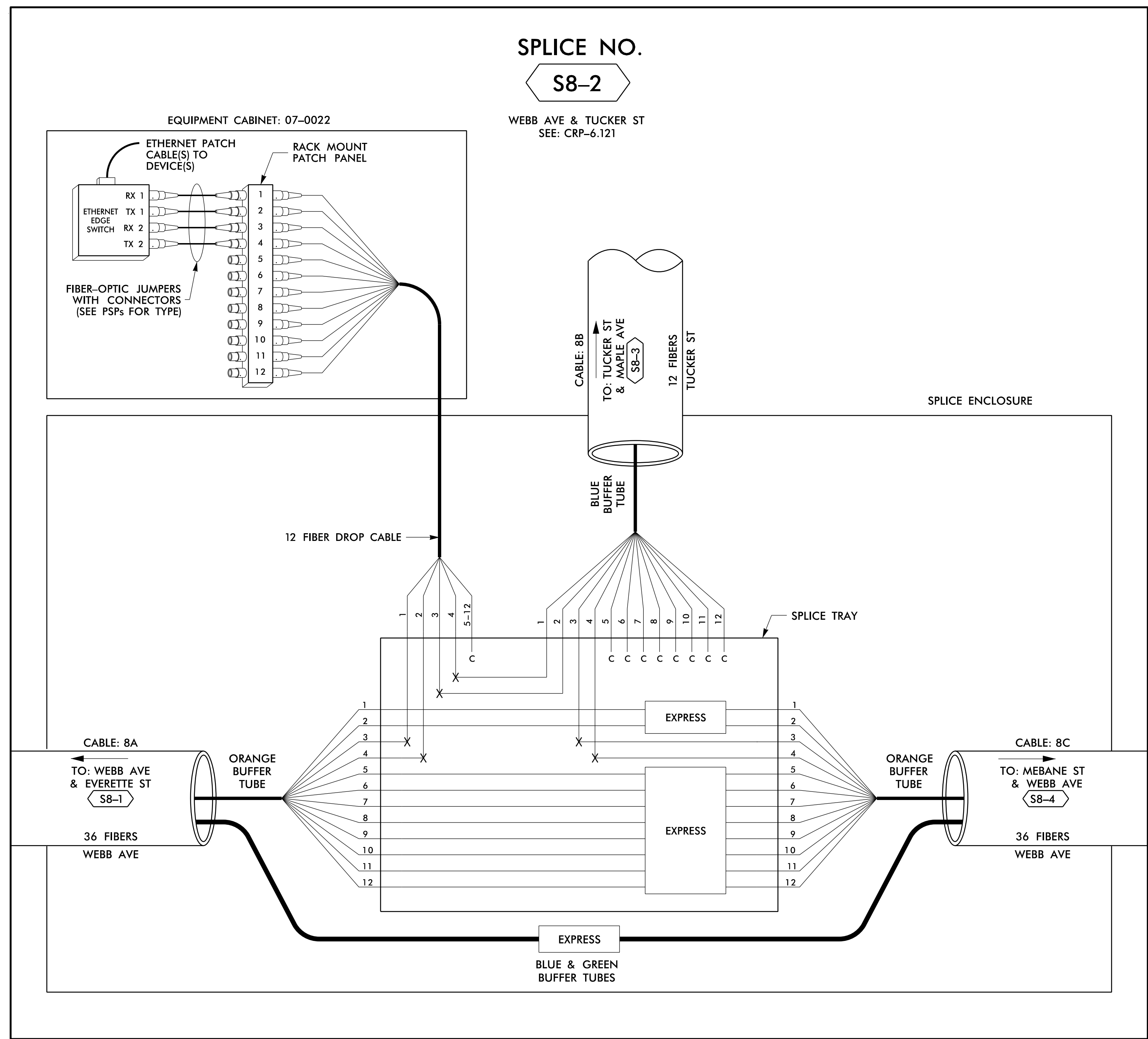

14 JUN 2018 12:20
 D:\Technical\Projects\Traffic\06015_B-C_Sig_Sys\Task_11_Comms\F_S_4_049.dgn
 S:\DCS\653 AT_LUS355433

LEGEND

X = FUSION SPlice INDIVIDUAL FIBER	
C = CAP AND SEAL	
EXPRESS	EXPRESS ENTIRE BUFFER TUBE / FIBERS THROUGH WITHOUT CUTTING
BUFFER SPlice	SPlice ALL FIBERS IN BUFFER TUBE COLOR TO COLOR
EXISTING	EXISTING BUFFER TUBE / FIBERS DO NOT MODIFY EXISTING SPlices OR EXPRESSED FIBERS.

- ### NOTES
- UNUSED FIBERS LEFT COILED AND STORED IN SPlice TRAY
 - UNUSED BUFFER TUBES LEFT COILED AND STORED IN SPlice ENCLOSURE
 - EDGE SWITCH CONFIGURATIONS ARE GENERIC. CONTRACTOR IS RESPONSIBLE FOR DETERMINING/ENSURING THE PROPER TERMINATIONS.

750 Greenfield Parkway, Garner, NC 27529

1616 EAST MILLBROOK ROAD, SUITE 160
 RALEIGH, NORTH CAROLINA 27609
 (919) 876-6888 NCBEEES #F-0326

**DOCUMENT NOT CONSIDERED FINAL
UNLESS ALL SIGNATURES COMPLETED**

Burlington-Graham Signal System

Fiber-Optic Splicing Details

Division 7 Alamance County Burlington & Graham

PLAN DATE: June 2018 REVIEWED BY: HA BADGETT

PREPARED BY: BJ SLOCUM REVIEWED BY: DL JONES

REVISIONS	INIT.	DATE

SCALE: N/A

BRADFORD J. SLOCUM
 ENGINEER
 STATE OF NORTH CAROLINA
 License No. 040877

DocuSign
 Bradford J. Slocum 6/15/2018
 DATE

CADD File name: FS_4.049.dgn

SPLICE NO.

S8-3

TUCKER ST & MAPLE AVE
SEE: CRP-6.128

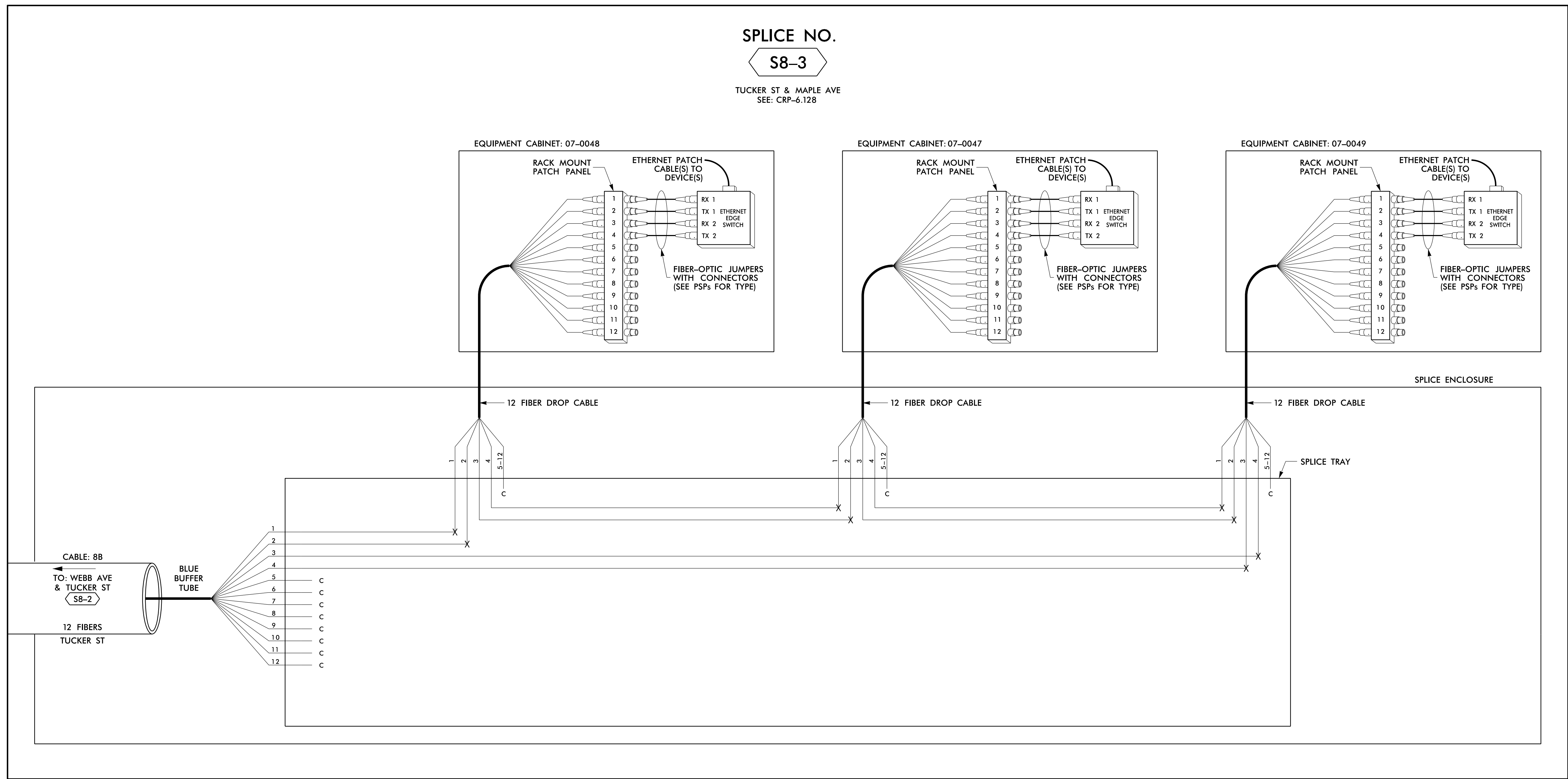

LEGEND

<table border="1"> <tr> <td>COLOR CODE</td> <td>TIA/EIA</td> <td>598-B</td> </tr> </table>		COLOR CODE	TIA/EIA	598-B	X = FUSION SPLICE INDIVIDUAL FIBER C = CAP AND SEAL
COLOR CODE	TIA/EIA	598-B			
(1) BLUE	(7) RED	EXPRESS	EXPRESS ENTIRE BUFFER TUBE / FIBERS THROUGH WITHOUT CUTTING		
(2) ORANGE	(8) BLACK	BUFFER SPLICE	SPLICE ALL FIBERS IN BUFFER TUBE COLOR TO COLOR		
(3) GREEN	(9) YELLOW	EXISTING	EXISTING BUFFER TUBE / FIBERS DO NOT MODIFY EXISTING SPLICES OR EXPRESSED FIBERS.		
(4) BROWN	(10) VIOLET				
(5) SLATE	(11) ROSE				
(6) WHITE	(12) AQUA				

NOTES

- UNUSED FIBERS LEFT COILED AND STORED IN SPLICE TRAY
- UNUSED BUFFER TUBES LEFT COILED AND STORED IN SPLICE ENCLOSURE
- EDGE SWITCH CONFIGURATIONS ARE GENERIC. CONTRACTOR IS RESPONSIBLE FOR DETERMINING/ENSURING THE PROPER TERMINATIONS.

ATKINS 1616 EAST MILLBROOK ROAD, SUITE 160
RALEIGH, NORTH CAROLINA 27609
(919) 876-6888 NCBEEES #F-0326

DOCUMENT NOT CONSIDERED FINAL UNLESS ALL SIGNATURES COMPLETED

Prepared for the Offices of: 750 Greenfield Parkway, Garner, NC 27529 SCALE: N/A	Burlington-Graham Signal System Fiber-Optic Splicing Details		SEAL NORTH CAROLINA PROFESSIONAL ENGINEER SEAL 040877 BRADFORD J. SLOCUM 15/2018 DATE
	Division 7 Alamance County PLAN DATE: June 2018 PREPARED BY: BJ SLOCUM	Burlington & Graham REVIEWED BY: HA BADGETT REVIEWED BY: DL JONES	

14 JUN 2018 12:20
 D:\projects\proj\com\tr\off\c\cur\100056469 U-6015 B-C Sig Sys\Task 11_Comm\F S 4.050.dgn
 SLOCUM3 AT LUS355433

SPLICE NO.

S8-4

MEBANE ST & WEBB AVE
SEE: CRP-6.120

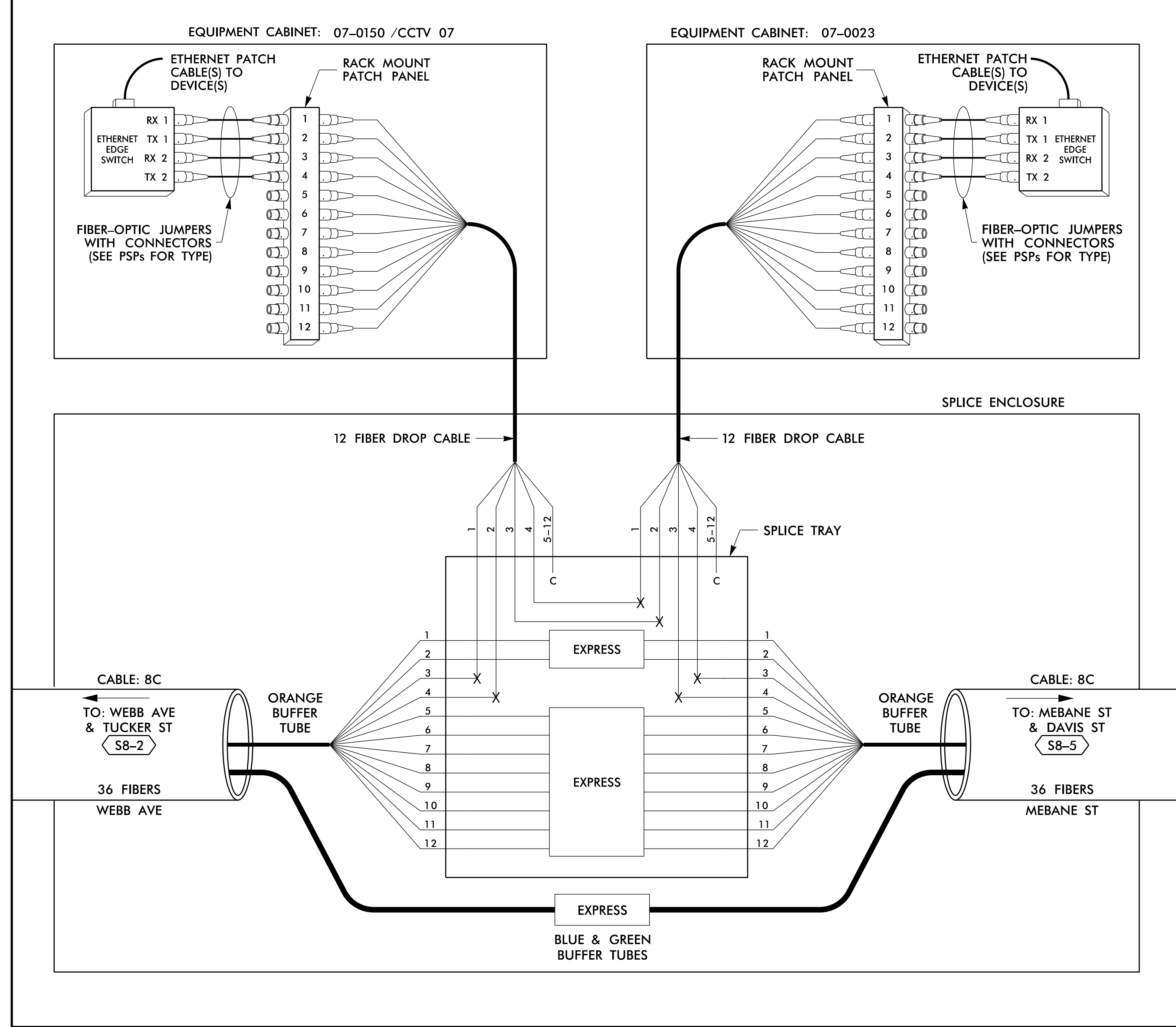

LEGEND

<p>COLOR CODE TIA/EIA 598-B</p>		<p>X = FUSION SPLICE INDIVIDUAL FIBER</p>
(1) BLUE	(7) RED	EXPRESS
(2) ORANGE	(8) BLACK	BUFFER SPLICE
(3) GREEN	(9) YELLOW	EXISTING
(4) BROWN	(10) VIOLET	
(5) SLATE	(11) ROSE	
(6) WHITE	(12) AQUA	

EXPRESS ENTIRE BUFFER TUBE / FIBERS THROUGH WITHOUT CUTTING

BUFFER SPLICE SPLICE ALL FIBERS IN BUFFER TUBE COLOR TO COLOR

EXISTING EXISTING BUFFER TUBE / FIBERS DO NOT MODIFY EXISTING SPLICES OR EXPRESSED FIBERS.

NOTES

- UNUSED FIBERS LEFT COILED AND STORED IN SPLICE TRAY
- UNUSED BUFFER TUBES LEFT COILED AND STORED IN SPLICE ENCLOSURE
- EDGE SWITCH CONFIGURATIONS ARE GENERIC. CONTRACTOR IS RESPONSIBLE FOR DETERMINING/ENSURING THE PROPER TERMINATIONS.

ATKINS 1616 EAST MILLBROOK ROAD, SUITE 160
RALEIGH, NORTH CAROLINA 27609
(919) 876-6888 NCBEEES #F-0326

DOCUMENT NOT CONSIDERED FINAL UNLESS ALL SIGNATURES COMPLETED

	<p>Burlington-Graham Signal System Fiber-Optic Splicing Details</p>		
	<p>Division 7 Alamance County</p>	<p>Burlington & Graham</p>	
<p>750 Greenfield Parkway, Garner, NC 27529</p>	<p>PLAN DATE: June 2018</p>	<p>REVIEWED BY: HA BADGETT</p>	<p>DATE: 15/2018</p>
<p>SCALE: N/A</p>	<p>PREPARED BY: BJ SLOCUM</p>	<p>REVIEWED BY: DL JONES</p>	<p>DATE: 15/2018</p>
<p>REVISIONS</p>	<p>INIT.</p>	<p>DATE</p>	<p>DATE</p>

CADD File name: FS_4.051.dgn

14-JUN-2018 12:21
 D:\Projects\Burlington-Graham\Traffic\06015_B-C_Sig_Sys\Task_11_Comms\F_S_4_051.dgn
 SLOCUM AT LUS355433

SPLICE NO.

S8-5

MEBANE ST & DAVIS ST
SEE: CRP-6.119

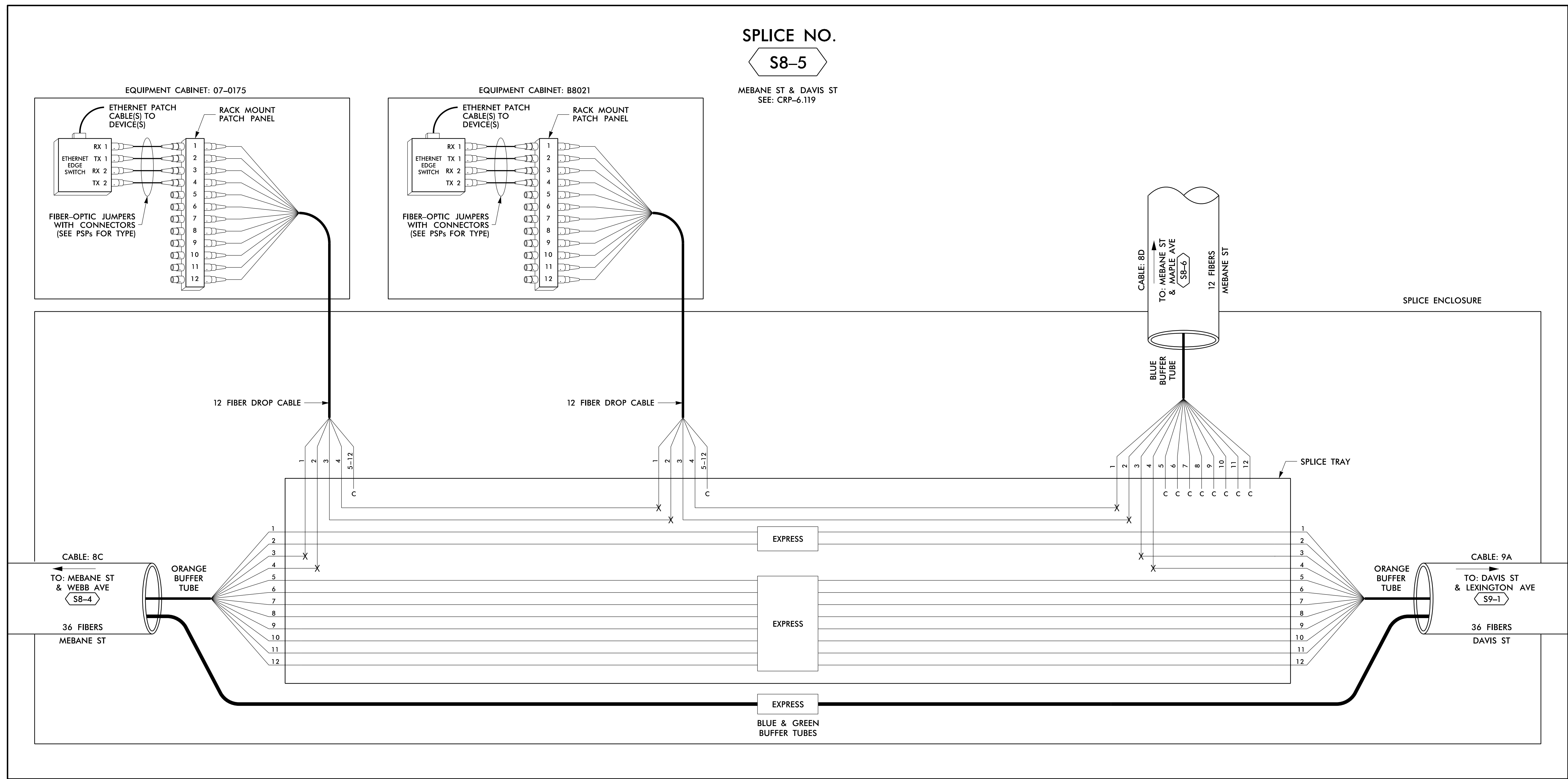

14 JUN 2018 12:22
 D:\Technical\Projects\U-6015 B-C Sig Sys\Task 11_Comm#FS 4.052.dgn
 S:\03563 AT_LUS355433

LEGEND

COLOR CODE TIA/EIA 598-B		X = FUSION SPLICE INDIVIDUAL FIBER C = CAP AND SEAL
(1) BLUE	(7) RED	EXPRESS ENTIRE BUFFER TUBE / FIBERS THROUGH WITHOUT CUTTING
(2) ORANGE	(8) BLACK	
(3) GREEN	(9) YELLOW	SPLICE ALL FIBERS IN BUFFER TUBE COLOR TO COLOR
(4) BROWN	(10) VIOLET	
(5) SLATE	(11) ROSE	EXISTING BUFFER TUBE / FIBERS DO NOT MODIFY EXISTING SPLICES OR EXPRESSED FIBERS.
(6) WHITE	(12) AQUA	

NOTES

- UNUSED FIBERS LEFT COILED AND STORED IN SPLICE TRAY
- UNUSED BUFFER TUBES LEFT COILED AND STORED IN SPLICE ENCLOSURE
- EDGE SWITCH CONFIGURATIONS ARE GENERIC. CONTRACTOR IS RESPONSIBLE FOR DETERMINING/ENSURING THE PROPER TERMINATIONS.

ATKINS 1616 EAST MILLBROOK ROAD, SUITE 160
 RALEIGH, NORTH CAROLINA 27609
 (919) 876-6888 NCBEEES #F-0326

Prepared for the Offices of: 750 Greenfield Parkway, Garner, NC 27529	Burlington-Graham Signal System Fiber-Optic Splicing Details		SEAL NORTH CAROLINA PROFESSIONAL SEAL 040877 ENGINEER Bradford J. Slocum 15/2018 DATE
	Division 7 Alamance County	Burlington & Graham	
	PLAN DATE: June 2018	REVIEWED BY: HA BADGETT	
	PREPARED BY: BJ SLOCUM	REVIEWED BY: DL JONES	
SCALE N/A	REVISIONS	INIT. DATE	DATE

DOCUMENT NOT CONSIDERED FINAL UNLESS ALL SIGNATURES COMPLETED

CAAD File name: FS_4.052.dgn

SPLICE NO.

S8-6

MEBANE ST & MAPLE AVE
SEE: CRP-6.119

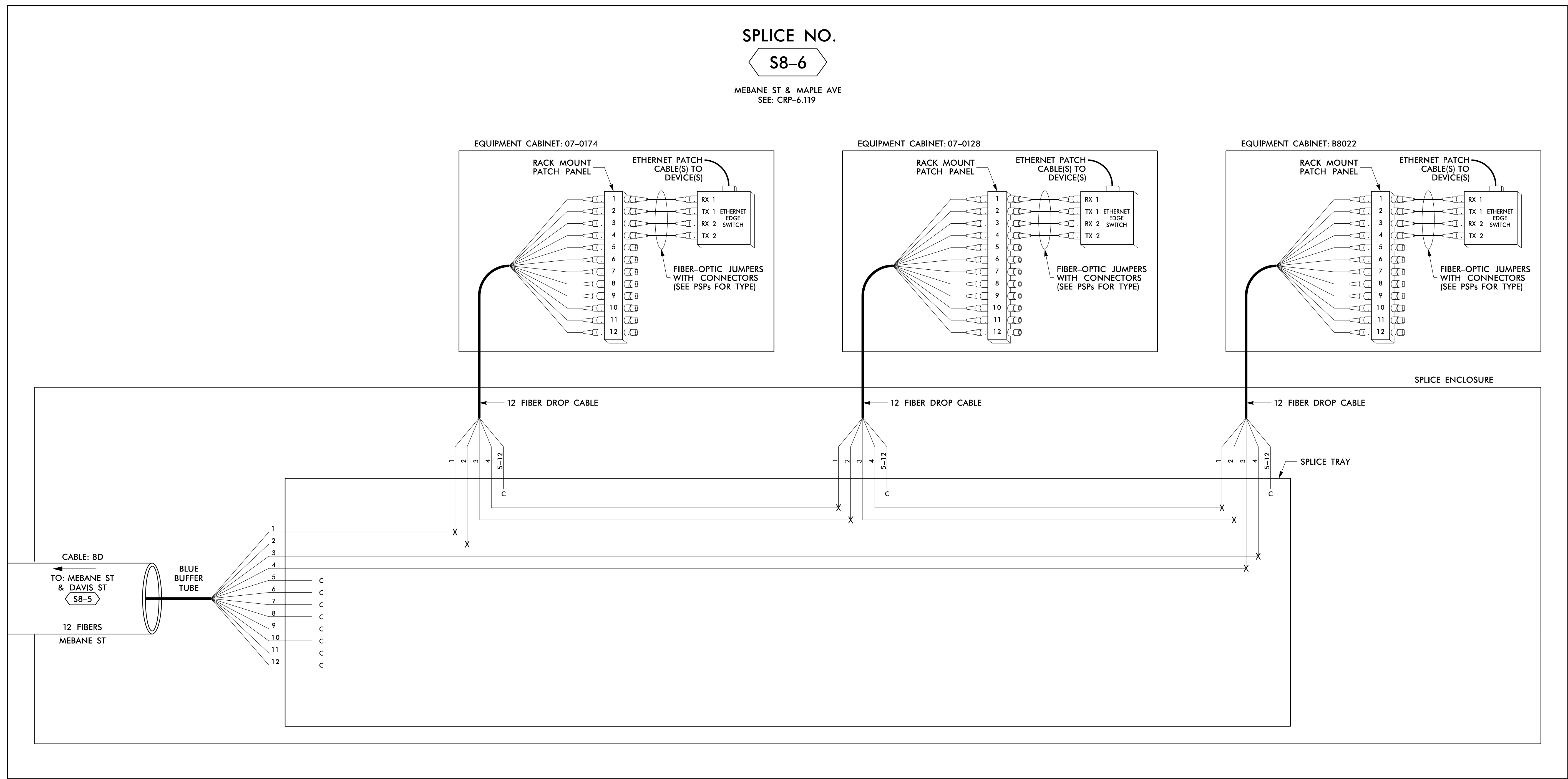

LEGEND

COLOR CODE TIA/EIA 598-B		X = FUSION SPLICE INDIVIDUAL FIBER	
(1) BLUE	(7) RED	EXPRESS ENTIRE BUFFER TUBE / FIBERS THROUGH WITHOUT CUTTING	
(2) ORANGE	(8) BLACK	C = CAP AND SEAL	
(3) GREEN	(9) YELLOW	EXPRESS	
(4) BROWN	(10) VIOLET	BUFFER SPLICE	
(5) SLATE	(11) ROSE	SPLICE ALL FIBERS IN BUFFER TUBE COLOR TO COLOR	
(6) WHITE	(12) AQUA	EXISTING	
		EXISTING BUFFER TUBE / FIBERS DO NOT MODIFY EXISTING SPLICES OR EXPRESSED FIBERS.	

NOTES

- UNUSED FIBERS LEFT COILED AND STORED IN SPLICE TRAY
- UNUSED BUFFER TUBES LEFT COILED AND STORED IN SPLICE ENCLOSURE
- EDGE SWITCH CONFIGURATIONS ARE GENERIC. CONTRACTOR IS RESPONSIBLE FOR DETERMINING/ENSURING THE PROPER TERMINATIONS.

ATKINS 1616 EAST MILLBROOK ROAD, SUITE 160
RALEIGH, NORTH CAROLINA 27609
(919) 876-6888 NCBEEES #F-0326

DOCUMENT NOT CONSIDERED FINAL UNLESS ALL SIGNATURES COMPLETED

<p>750 Greenfield Parkway, Garner, NC 27529</p>	<p>Burlington-Graham Signal System Fiber-Optic Splicing Details</p>							
	<p>Division 7 Alamance County Burlington & Graham</p>							
	<p>PLAN DATE: June 2018</p>	<p>REVIEWED BY: HA BADGETT</p>						
	<p>PREPARED BY: BJ SLOCUM</p>	<p>REVIEWED BY: DL JONES</p>						
<p>SCALE: N/A</p>	<table border="1"> <tr> <th>REVISIONS</th> <th>INIT.</th> <th>DATE</th> </tr> <tr> <td> </td> <td> </td> <td> </td> </tr> </table>	REVISIONS	INIT.	DATE				<p>DATE: 15/2018</p>
REVISIONS	INIT.	DATE						

14-JUN-2018 12:22
 D:\projects\atkins\proj\offices\cur\100056469 U-6015 B-C Sig_Sys\Task 11_Comms\F S 4.053.dgn
 S:\DCS\653 AT_LUS355433

SPLICE NO.
S9-2

MAPLE AVE & SPRING ST
 SEE: CRP-6.117

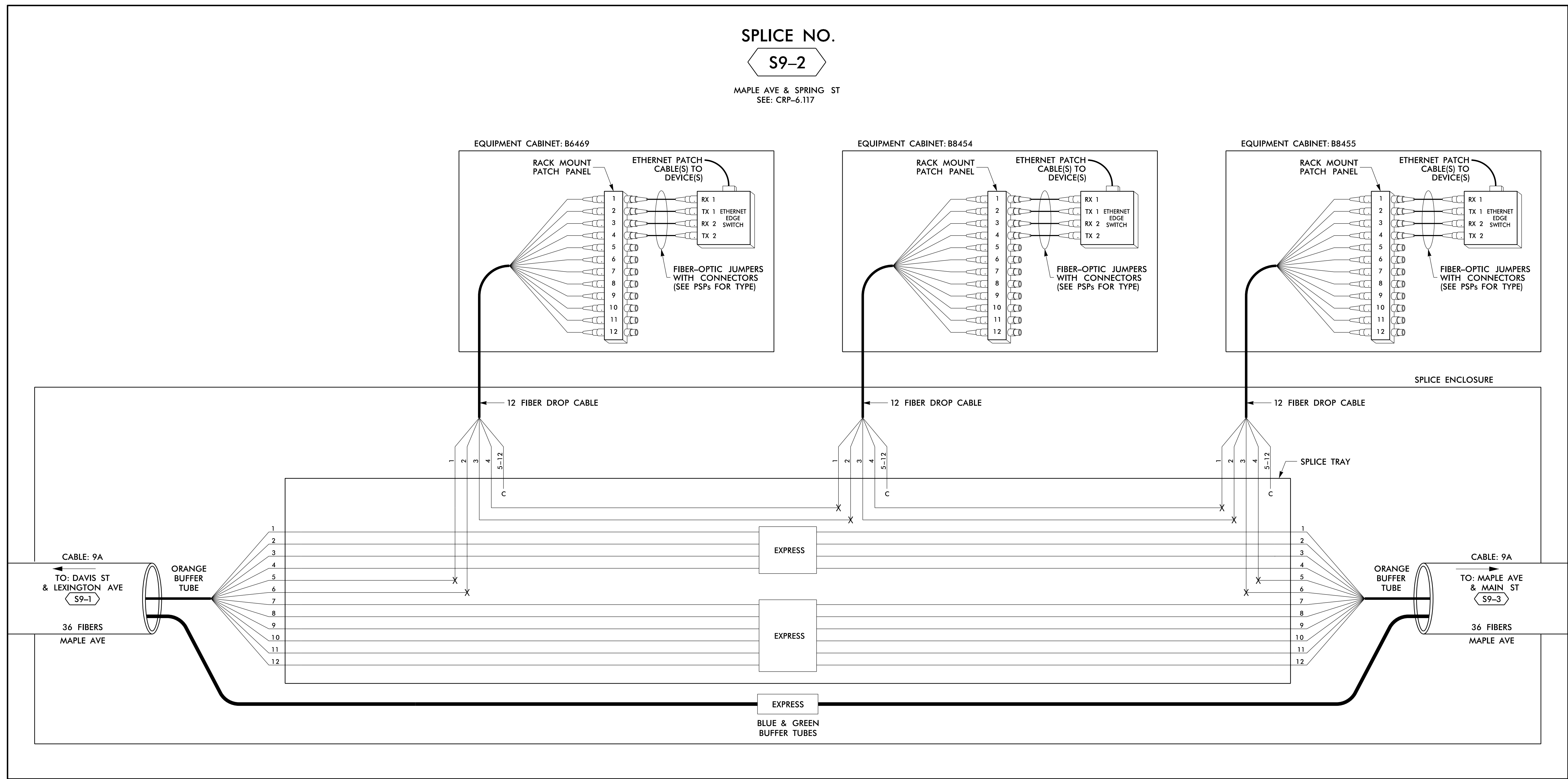

LEGEND

(1) BLUE	(7) RED	EXPRESS	EXPRESS ENTIRE BUFFER TUBE / FIBERS THROUGH WITHOUT CUTTING
(2) ORANGE	(8) BLACK	BUFFER SPLICE	SPLICE ALL FIBERS IN BUFFER TUBE COLOR TO COLOR
(3) GREEN	(9) YELLOW	EXISTING	EXISTING BUFFER TUBE / FIBERS DO NOT MODIFY EXISTING SPLICES OR EXPRESSED FIBERS.
(4) BROWN	(10) VIOLET		
(5) SLATE	(11) ROSE		
(6) WHITE	(12) AQUA		

X = FUSION SPLICE INDIVIDUAL FIBER
 C = CAP AND SEAL

- NOTES**
- UNUSED FIBERS LEFT COILED AND STORED IN SPLICE TRAY
 - UNUSED BUFFER TUBES LEFT COILED AND STORED IN SPLICE ENCLOSURE
 - EDGE SWITCH CONFIGURATIONS ARE GENERIC. CONTRACTOR IS RESPONSIBLE FOR DETERMINING/ENSURING THE PROPER TERMINATIONS.

14 JUN 2018 12:23
 D:\Technical\Information\Traffic\Cur*100056469 U-6015 B-C Sig Sys*Task 11_Corrs*FS 4_055.dgn
 S:\DCS\653 AT_LUS355433

ATKINS

1616 EAST MILLBROOK ROAD, SUITE 160
 RALEIGH, NORTH CAROLINA 27609
 (919) 876-6888 NCBEEES #F-0326

Burlington-Graham Signal System
Fiber-Optic Splicing Details

Division 7 Alamance County Burlington & Graham

PLAN DATE: June 2018 REVIEWED BY: HA BADGETT

PREPARED BY: BJ SLOCUM REVIEWED BY: DL JONES

REVISIONS	INIT.	DATE

SCALE: N/A

SEAL

NORTH CAROLINA PROFESSIONAL ENGINEER

SEAL 040877

BRADFORD J. SLOCUM

15/2018

DATE

DATE

DATE

DOCUMENT NOT CONSIDERED FINAL UNLESS ALL SIGNATURES COMPLETED

CADD File name: FS 4.055.dgn

SPLICE NO.
S9-3

MAPLE AVE & MAIN ST
SEE: CRP-6.116

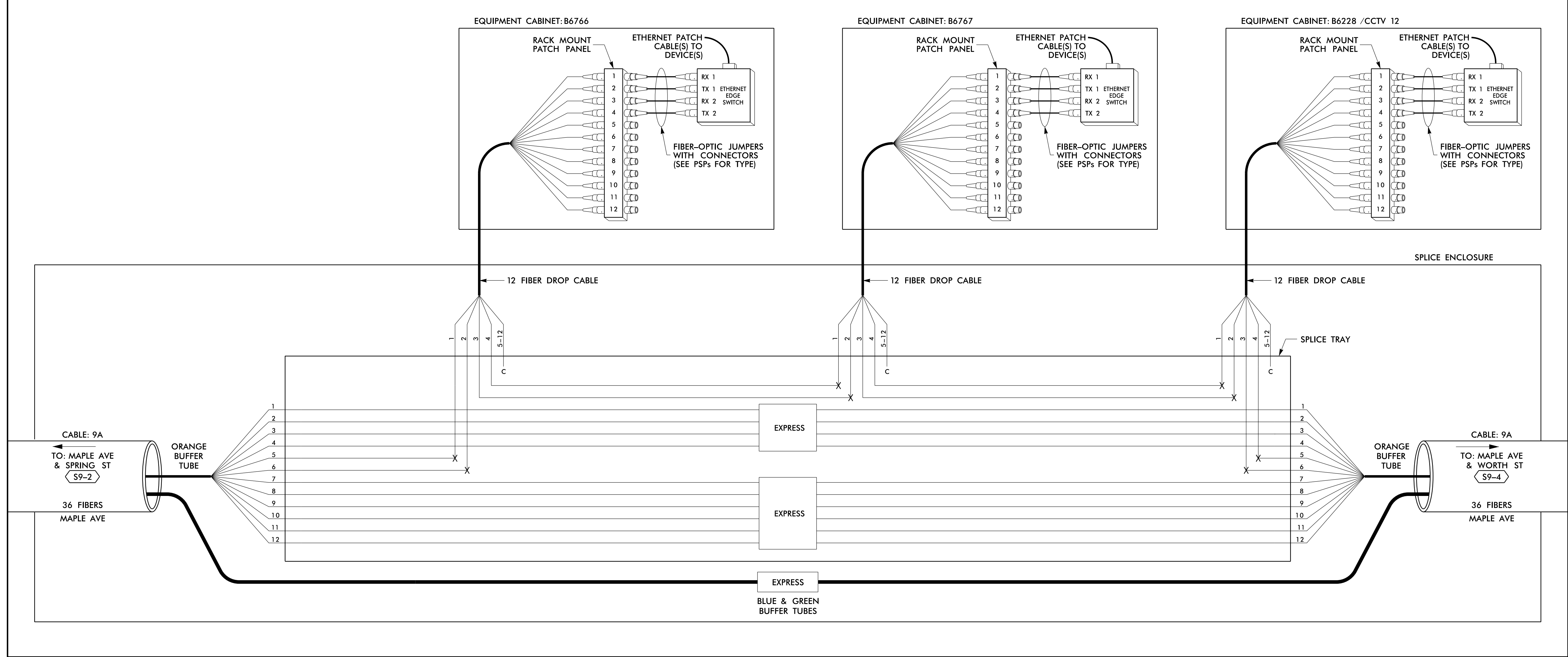

LEGEND

<table border="0"> <tr> <td>(1) BLUE</td> <td>(7) RED</td> </tr> <tr> <td>(2) ORANGE</td> <td>(8) BLACK</td> </tr> <tr> <td>(3) GREEN</td> <td>(9) YELLOW</td> </tr> <tr> <td>(4) BROWN</td> <td>(10) VIOLET</td> </tr> <tr> <td>(5) SLATE</td> <td>(11) ROSE</td> </tr> <tr> <td>(6) WHITE</td> <td>(12) AQUA</td> </tr> </table>	(1) BLUE	(7) RED	(2) ORANGE	(8) BLACK	(3) GREEN	(9) YELLOW	(4) BROWN	(10) VIOLET	(5) SLATE	(11) ROSE	(6) WHITE	(12) AQUA	<table border="0"> <tr> <td>EXPRESS</td> <td>EXPRESS ENTIRE BUFFER TUBE / FIBERS THROUGH WITHOUT CUTTING</td> </tr> <tr> <td>BUFFER SPLICE</td> <td>SPLICE ALL FIBERS IN BUFFER TUBE COLOR TO COLOR</td> </tr> <tr> <td>EXISTING</td> <td>EXISTING BUFFER TUBE / FIBERS DO NOT MODIFY EXISTING SPLICES OR EXPRESSED FIBERS.</td> </tr> </table>	EXPRESS	EXPRESS ENTIRE BUFFER TUBE / FIBERS THROUGH WITHOUT CUTTING	BUFFER SPLICE	SPLICE ALL FIBERS IN BUFFER TUBE COLOR TO COLOR	EXISTING	EXISTING BUFFER TUBE / FIBERS DO NOT MODIFY EXISTING SPLICES OR EXPRESSED FIBERS.
(1) BLUE	(7) RED																		
(2) ORANGE	(8) BLACK																		
(3) GREEN	(9) YELLOW																		
(4) BROWN	(10) VIOLET																		
(5) SLATE	(11) ROSE																		
(6) WHITE	(12) AQUA																		
EXPRESS	EXPRESS ENTIRE BUFFER TUBE / FIBERS THROUGH WITHOUT CUTTING																		
BUFFER SPLICE	SPLICE ALL FIBERS IN BUFFER TUBE COLOR TO COLOR																		
EXISTING	EXISTING BUFFER TUBE / FIBERS DO NOT MODIFY EXISTING SPLICES OR EXPRESSED FIBERS.																		

- NOTES**
1. UNUSED FIBERS LEFT COILED AND STORED IN SPLICE TRAY
 2. UNUSED BUFFER TUBES LEFT COILED AND STORED IN SPLICE ENCLOSURE
 3. EDGE SWITCH CONFIGURATIONS ARE GENERIC. CONTRACTOR IS RESPONSIBLE FOR DETERMINING/ENSURING THE PROPER TERMINATIONS.

14 JUN 2018 12:24
 D:\projects\proj\com\tr\off\c\cur*100056469 U=6015 B=C Sig Sys*Task 11_Corrs#FS 4_056.dgn
 S:\DCS\653 AT_LUS355433

ATKINS

1616 EAST MILLBROOK ROAD, SUITE 160
RALEIGH, NORTH CAROLINA 27609
(919) 876-6888 NCBEE# F-0326

**DOCUMENT NOT CONSIDERED FINAL
UNLESS ALL SIGNATURES COMPLETED**

Prepared for the Offices of: NORTH CAROLINA DEPARTMENT OF TRANSPORTATION	
Burlington-Graham Signal System Fiber-Optic Splicing Details	
Division 7 Alamance County Burlington & Graham	
PLAN DATE: June 2018	REVIEWED BY: HA BADGETT
PREPARED BY: BJ SLOCUM	REVIEWED BY: DL JONES
REVISIONS INIT. DATE	
SCALE: N/A	

BRADFORD J. SLOCUM
ENGINEER
040877
15/2018

DATE: _____
CAD File Name: FS 4.056.dgn

SPLICE NO.

S9-4

MAPLE AVE & WORTH ST
SEE: CRP-6.116

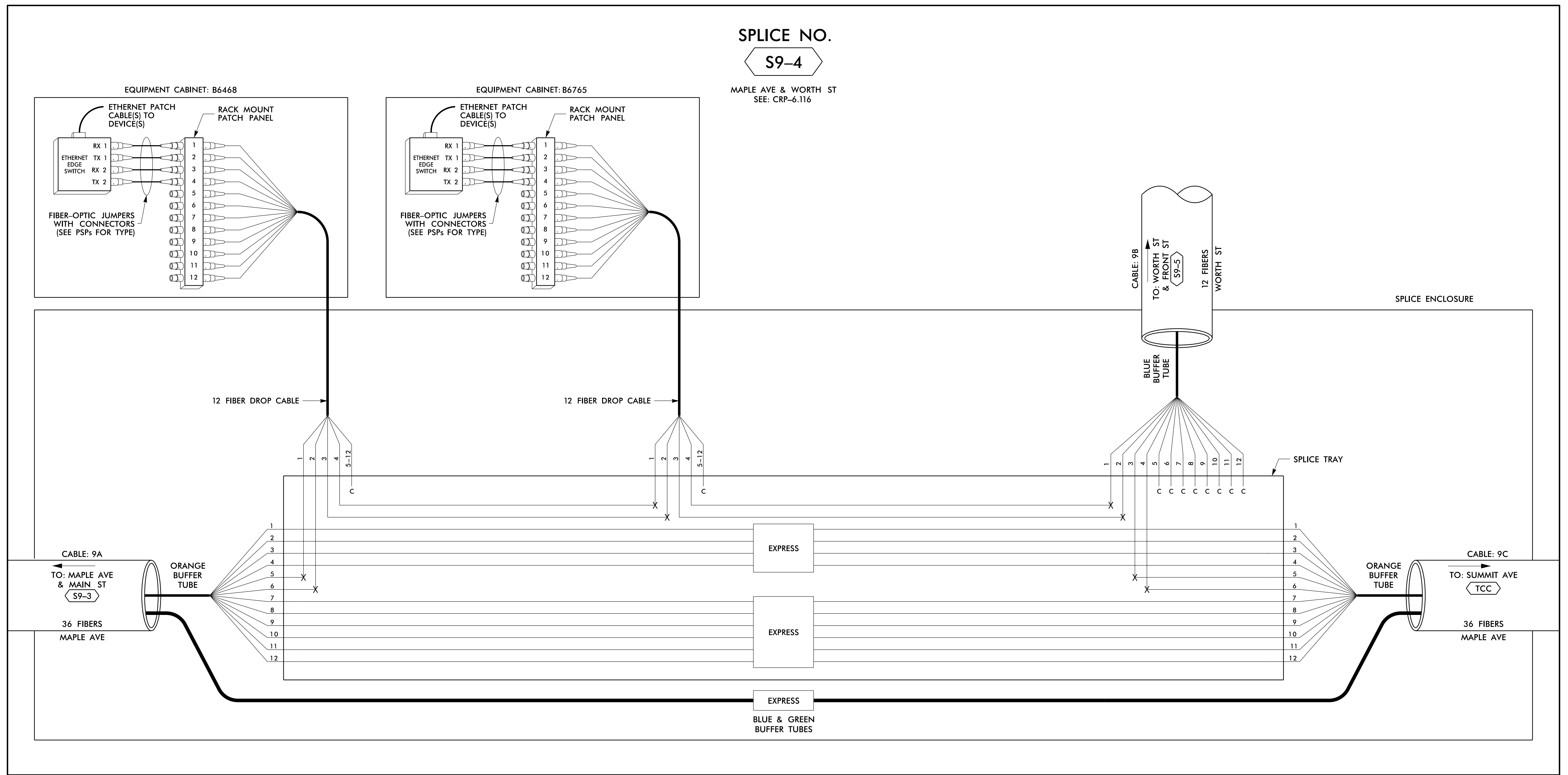

LEGEND

COLOR CODE TIA/EIA 598-B		X = FUSION SPLICE INDIVIDUAL FIBER	
(1) BLUE	(7) RED	C = CAP AND SEAL	
(2) ORANGE	(8) BLACK		EXPRESS ENTIRE BUFFER TUBE / FIBERS THROUGH WITHOUT CUTTING
(3) GREEN	(9) YELLOW		BUFFER SPLICE SPLICE ALL FIBERS IN BUFFER TUBE COLOR TO COLOR
(4) BROWN	(10) VIOLET		EXISTING BUFFER TUBE / FIBERS DO NOT MODIFY EXISTING SPLICES OR EXPRESSED FIBERS.
(5) SLATE	(11) ROSE		
(6) WHITE	(12) AQUA		

NOTES

- UNUSED FIBERS LEFT COILED AND STORED IN SPLICE TRAY
- UNUSED BUFFER TUBES LEFT COILED AND STORED IN SPLICE ENCLOSURE
- EDGE SWITCH CONFIGURATIONS ARE GENERIC. CONTRACTOR IS RESPONSIBLE FOR DETERMINING/ENSURING THE PROPER TERMINATIONS.

ATKINS 1616 EAST MILLBROOK ROAD, SUITE 160
RALEIGH, NORTH CAROLINA 27609
(919) 876-6888 NCBEEES #F-0326

Prepared for the Offices of:

 State of North Carolina
 Department of Transportation

**Burlington-Graham Signal System
Fiber-Optic Splicing Details**

Division 7 Alamance County Burlington & Graham

PLAN DATE: June 2018 REVIEWED BY: HA BADGETT
 PREPARED BY: BJ SLOCUM REVIEWED BY: DL JONES

REVISIONS	INIT.	DATE

SCALE: N/A

750 Greenfield Parkway, Garner, NC 27529

15/2018
 CAD FILE NAME: FS_4.057.dgn

DOCUMENT NOT CONSIDERED FINAL UNLESS ALL SIGNATURES COMPLETED

SEAL
 NORTH CAROLINA PROFESSIONAL ENGINEER
 SEAL 040877
 BRADFORD J. SLOCUM
 15/2018

14 JUN 2018 12:24
 D:\projects\atkins\crp\offices\crp\1100056469 U-6015 B-C Sig_Sys\Task 11_Comm#FS 4.057.dgn
 SLOCUM363 AT LUS355433

SPLICE NO.

S9-5

WORTH ST & FRONT ST
SEE: CRP-6.127

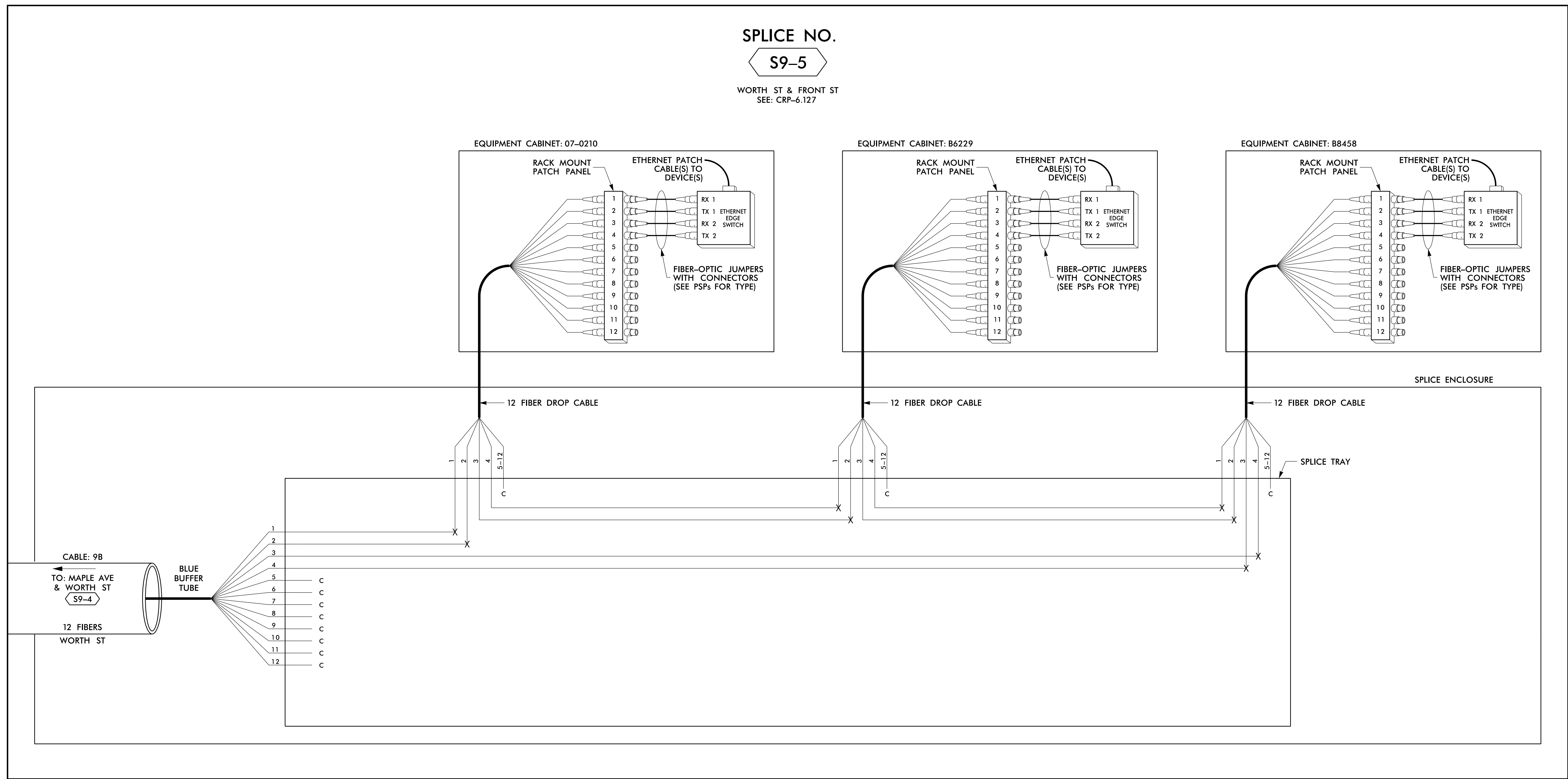

14 JUN 2018 12:25
D:\Technical\Projects\U-6015 B-C Sig Sys\Task 11_Comms\F S 4.058.dgn
S:\DCS\653 AT_LUS\355433

LEGEND

COLOR CODE TIA/EIA 598-B		X = FUSION SPlice INDIVIDUAL FIBER	
(1) BLUE	(7) RED	EXPRESS	EXPRESS ENTIRE BUFFER TUBE /FIBERS THROUGH WITHOUT CUTTING
(2) ORANGE	(8) BLACK	BUFFER SPlice	SPLICE ALL FIBERS IN BUFFER TUBE COLOR TO COLOR
(3) GREEN	(9) YELLOW	EXISTING	EXISTING BUFFER TUBE /FIBERS DO NOT MODIFY EXISTING SPLICES OR EXPRESSED FIBERS.
(4) BROWN	(10) VIOLET		
(5) SLATE	(11) ROSE		
(6) WHITE	(12) AQUA		
		C =	CAP AND SEAL

NOTES

- UNUSED FIBERS LEFT COILED AND STORED IN SPLICE TRAY
- UNUSED BUFFER TUBES LEFT COILED AND STORED IN SPLICE ENCLOSURE
- EDGE SWITCH CONFIGURATIONS ARE GENERIC. CONTRACTOR IS RESPONSIBLE FOR DETERMINING/ENSURING THE PROPER TERMINATIONS.

ATKINS 1616 EAST MILLBROOK ROAD, SUITE 160
RALEIGH, NORTH CAROLINA 27609
(919) 876-6888 NCBEEES #F-0326

	Burlington-Graham Signal System Fiber-Optic Splicing Details		
	Division 7 Alamance County PLAN DATE: June 2018 PREPARED BY: BJ SLOCUM	Burlington & Graham REVIEWED BY: HA BADGETT REVIEWED BY: DL JONES	

DOCUMENT NOT CONSIDERED FINAL UNLESS ALL SIGNATURES COMPLETED

DATE: 6/15/2018
CAD File name: FS 4.058.dgn

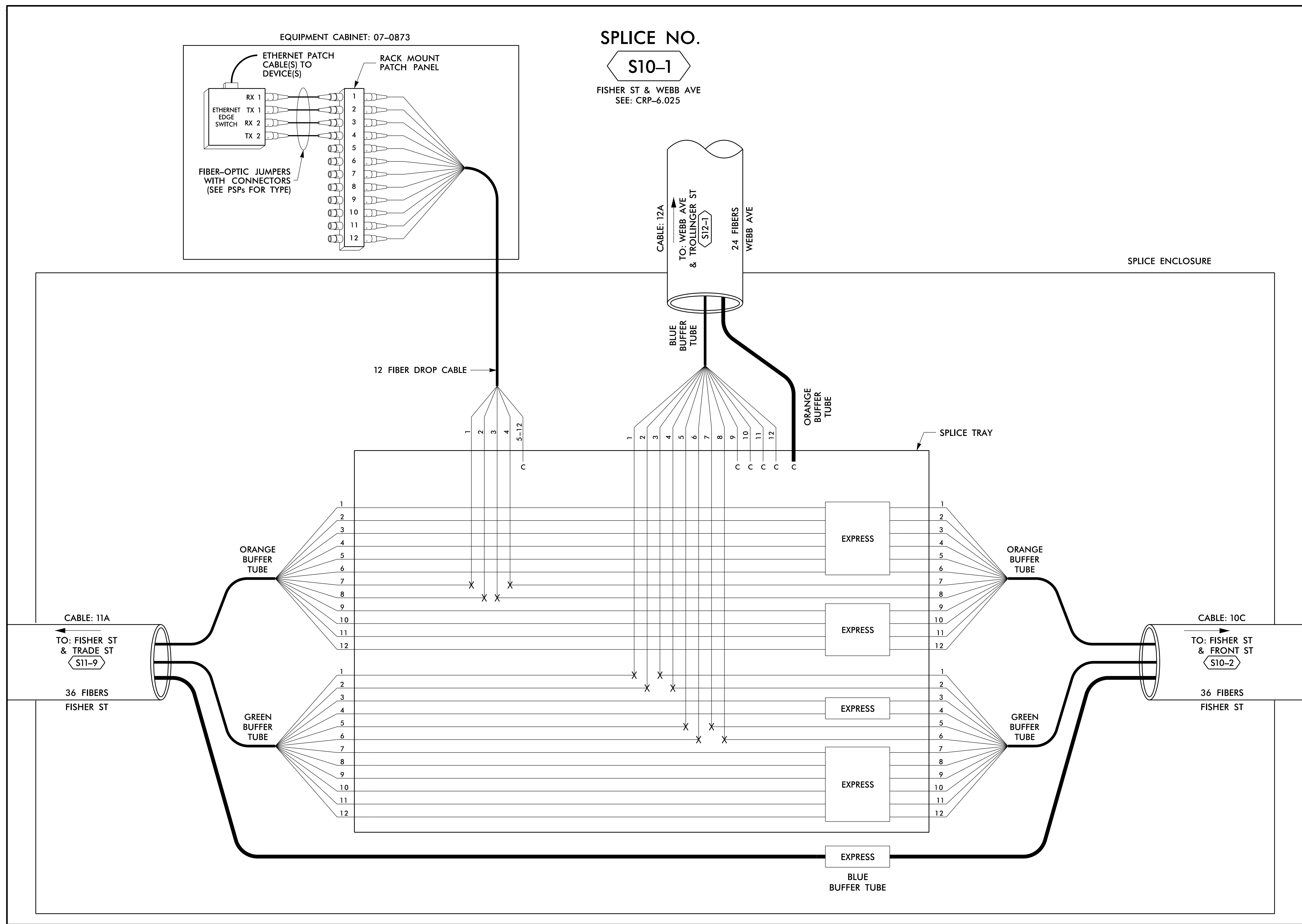

14 JUN 2018 12:25
 D:\projects\11_00056469_U-6015_B-C_Sig_Sys\Task_11_Comms#FS 4.059.dgn
 S:\003653 AT_LUS355433

LEGEND

COLOR CODE TIA/EIA 598-B		X = FUSION SPlice INDIVIDUAL FIBER
(1) BLUE	(7) RED	C = CAP AND SEAL
(2) ORANGE	(8) BLACK	
(3) GREEN	(9) YELLOW	
(4) BROWN	(10) VIOLET	
(5) SLATE	(11) ROSE	
(6) WHITE	(12) AQUA	
EXPRESS		EXPRESS ENTIRE BUFFER TUBE / FIBERS THROUGH WITHOUT CUTTING
BUFFER SPlice		SPlice ALL FIBERS IN BUFFER TUBE COLOR TO COLOR
EXISTING		EXISTING BUFFER TUBE / FIBERS DO NOT MODIFY EXISTING SPlices OR EXPRESSED FIBERS.

- NOTES**
- UNUSED FIBERS LEFT COILED AND STORED IN SPICE TRAY
 - UNUSED BUFFER TUBES LEFT COILED AND STORED IN SPICE ENCLURE
 - EDGE SWITCH CONFIGURATIONS ARE GENERIC. CONTRACTOR IS RESPONSIBLE FOR DETERMINING/ENSURING THE PROPER TERMINATIONS.

ATKINS 1616 EAST MILLBROOK ROAD, SUITE 160
 RALEIGH, NORTH CAROLINA 27609
 (919) 876-6888 NCBEEES #F-0326

DOCUMENT NOT CONSIDERED FINAL UNLESS ALL SIGNATURES COMPLETED

	Burlington-Graham Signal System Fiber-Optic Splicing Details		
	Division 7 Alamance County Burlington & Graham	REVIEWED BY: HA BADGETT	
PLAN DATE: June 2018	PREPARED BY: BJ SLOCUM	REVIEWED BY: DL JONES	DATE: 6/15/2018
SCALE: N/A	REVISIONS	INIT.	DATE
CADD File name: FS 4.059.dgn			

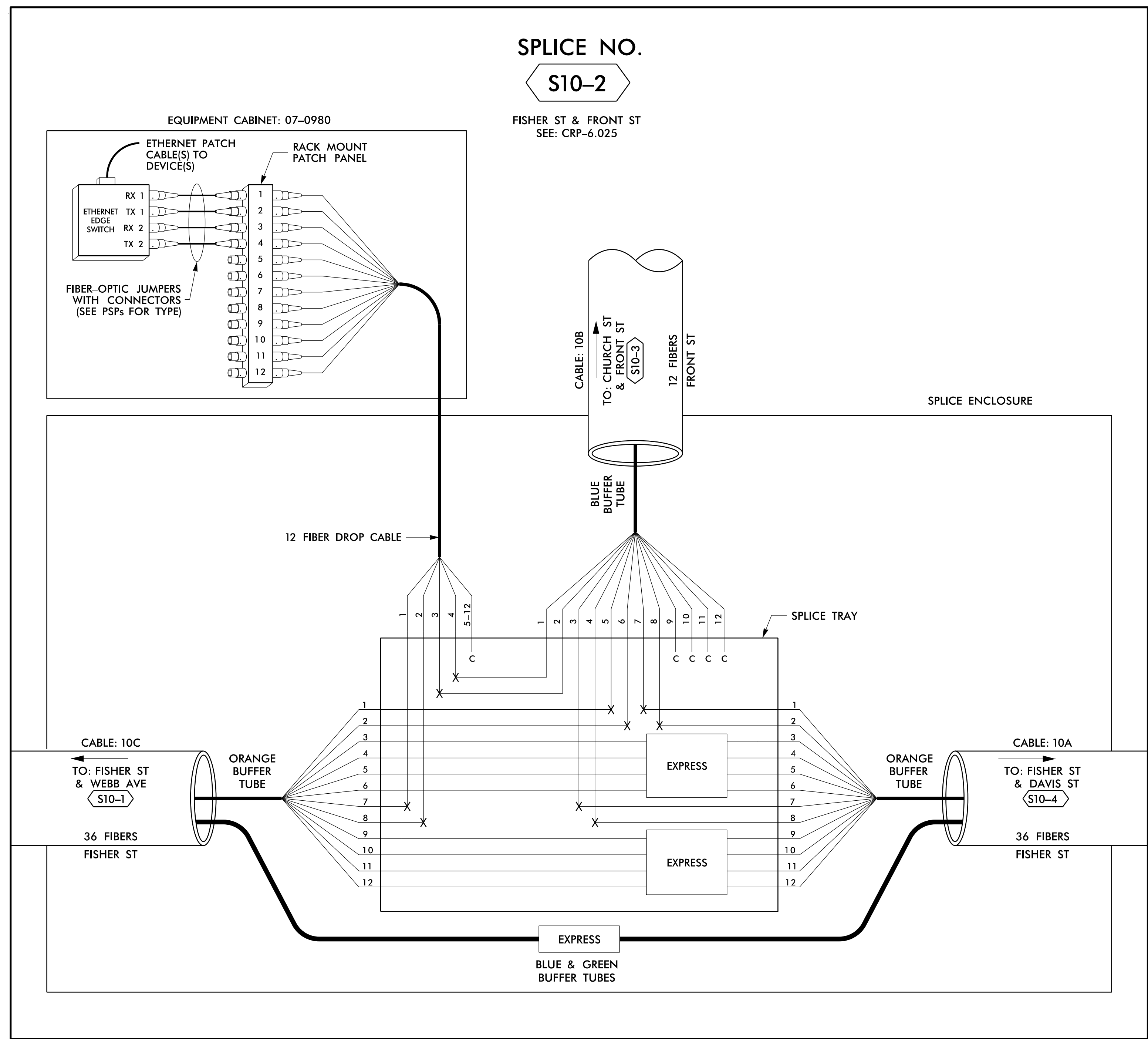

14 JUN 2018 12:26
 D:\projects\proj\100056469 U-6015 B-C Sig Sys\Task 11_Coms\Fs 4.060.dgn
 S:\DCS\653 AT LUS355433

COLOR CODE		LEGEND	
(1) BLUE	(7) RED	EXPRESS	EXPRESS ENTIRE BUFFER TUBE / FIBERS THROUGH WITHOUT CUTTING
(2) ORANGE	(8) BLACK	BUFFER SPLICE	SPLICE ALL FIBERS IN BUFFER TUBE COLOR TO COLOR
(3) GREEN	(9) YELLOW	EXISTING	EXISTING BUFFER TUBE / FIBERS DO NOT MODIFY EXISTING SPLICES OR EXPRESSED FIBERS.
(4) BROWN	(10) VIOLET		
(5) SLATE	(11) ROSE		
(6) WHITE	(12) AQUA		

X = FUSION SPLICE INDIVIDUAL FIBER
 C = CAP AND SEAL

- NOTES**
- UNUSED FIBERS LEFT COILED AND STORED IN SPLICE TRAY
 - UNUSED BUFFER TUBES LEFT COILED AND STORED IN SPLICE ENCLOSURE
 - EDGE SWITCH CONFIGURATIONS ARE GENERIC. CONTRACTOR IS RESPONSIBLE FOR DETERMINING/ENSURING THE PROPER TERMINATIONS.

ATKINS 1616 EAST MILLBROOK ROAD, SUITE 160
RALEIGH, NORTH CAROLINA 27609
(919) 876-6888 NCBEEs #F-0326

DOCUMENT NOT CONSIDERED FINAL UNLESS ALL SIGNATURES COMPLETED

<p>750 Greenfield Parkway, Garner, NC 27529</p>	Prepared for the Offices of: NORTH CAROLINA DEPARTMENT OF TRANSPORTATION Division 7 Alameda County Burlington & Graham		
	Burlington-Graham Signal System Fiber-Optic Splicing Details		
SCALE: N/A	PLAN DATE: June 2018 PREPARED BY: BJ SLOCUM	REVIEWED BY: HA BADGETT REVIEWED BY: DL JONES	SEAL NORTH CAROLINA PROFESSIONAL ENGINEER BRADFORD J. SLOCUM 15/2018

SPLICE NO.

S10-3

CHURCH ST & FRONT ST
SEE: CRP-6.025

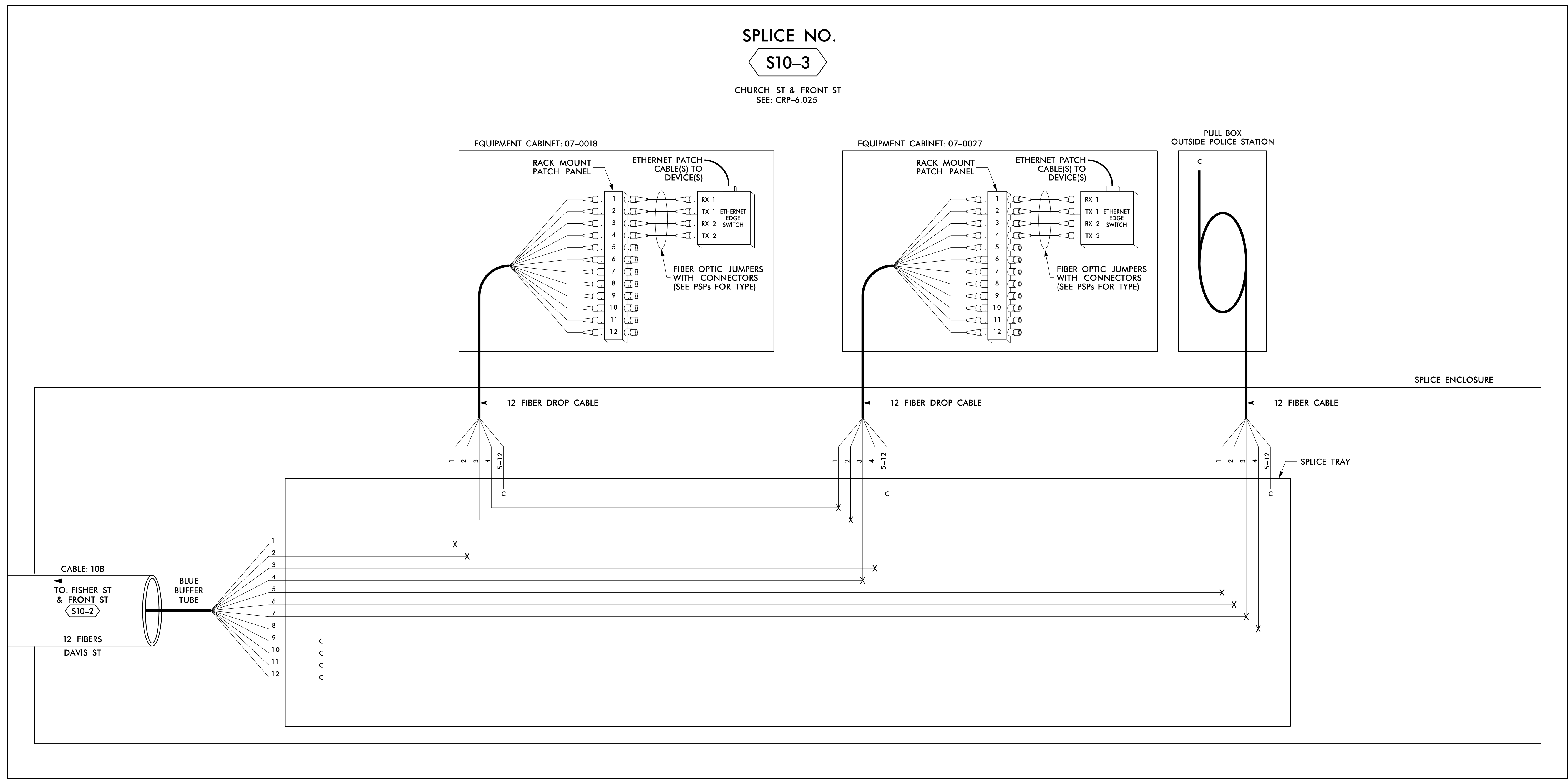

14 JUN 2018 12:26
D:\projects\proj\cra\tr\off\c\cur\100056469 U-6015 B-C Sig Sys\Task 11_Comm\FS 4.061.dgn
SLODC3633 AT LUS355433

LEGEND

COLOR CODE TIA/EIA 598-B		X = FUSION SPlice INDIVIDUAL FIBER
(1) BLUE	(7) RED	C = CAP AND SEAL
(2) ORANGE	(8) BLACK	
(3) GREEN	(9) YELLOW	
(4) BROWN	(10) VIOLET	EXPRESS
(5) SLATE	(11) ROSE	BUFFER SPlice
(6) WHITE	(12) AQUA	EXISTING
		EXPRESS ENTIRE BUFFER TUBE /FIBERS THROUGH WITHOUT CUTTING
		BUFFER SPlice SPlice ALL FIBERS IN BUFFER TUBE COLOR TO COLOR
		EXISTING BUFFER TUBE /FIBERS DO NOT MODIFY EXISTING SPlices OR EXPRESSED FIBERS.

NOTES

- UNUSED FIBERS LEFT COILED AND STORED IN SPLICE TRAY
- UNUSED BUFFER TUBES LEFT COILED AND STORED IN SPLICE ENCLOSURE
- EDGE SWITCH CONFIGURATIONS ARE GENERIC. CONTRACTOR IS RESPONSIBLE FOR DETERMINING/ENSURING THE PROPER TERMINATIONS.

ATKINS 1616 EAST MILLBROOK ROAD, SUITE 160
RALEIGH, NORTH CAROLINA 27609
(919) 876-6888 NCBEE# F-0326

**DOCUMENT NOT CONSIDERED FINAL
UNLESS ALL SIGNATURES COMPLETED**

 Prepared for the Offices of: NORTH CAROLINA DEPARTMENT OF TRANSPORTATION 750 Greenfield Parkway, Garner, NC 27529	Burlington-Graham Signal System Fiber-Optic Splicing Details		SEAL NORTH CAROLINA PROFESSIONAL SEAL 040877 ENGINEER Bradford J. Slocum 6/15/2018 DATE
	Division 7 Alamance County Burlington & Graham	PLAN DATE: June 2018 REVIEWED BY: HA BADGETT	
	SCALE: N/A	PREPARED BY: BJ SLOCUM REVIEWED BY: DL JONES	REVISIONS INIT. DATE
	CAD0 File name: FS 4.061.dgn		

SPLICE NO.

S10-4

FISHER ST & DAVIS ST
SEE: CRP-6.025

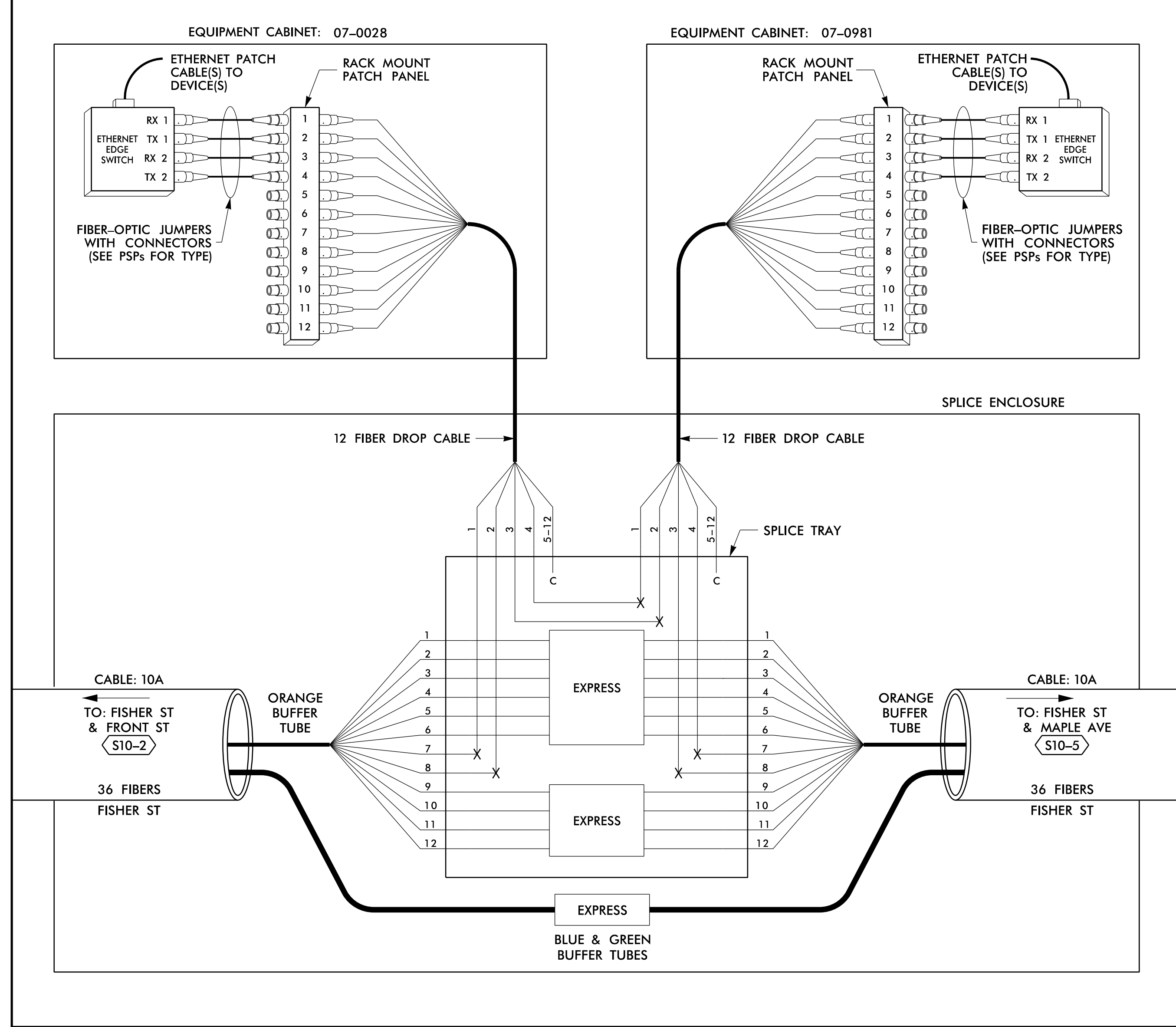

LEGEND

COLOR CODE TIA/EIA 598-B		X = FUSION SPLICE INDIVIDUAL FIBER	
(1) BLUE	(7) RED	EXPRESS	EXPRESS ENTIRE BUFFER TUBE / FIBERS THROUGH WITHOUT CUTTING
(2) ORANGE	(8) BLACK	BUFFER SPLICE	SPLICE ALL FIBERS IN BUFFER TUBE COLOR TO COLOR
(3) GREEN	(9) YELLOW	EXISTING	EXISTING BUFFER TUBE / FIBERS DO NOT MODIFY EXISTING SPLICES OR EXPRESSED FIBERS.
(4) BROWN	(10) VIOLET		
(5) SLATE	(11) ROSE		
(6) WHITE	(12) AQUA		

NOTES

- UNUSED FIBERS LEFT COILED AND STORED IN SPLICE TRAY
- UNUSED BUFFER TUBES LEFT COILED AND STORED IN SPLICE ENCLOSURE
- EDGE SWITCH CONFIGURATIONS ARE GENERIC. CONTRACTOR IS RESPONSIBLE FOR DETERMINING/ENSURING THE PROPER TERMINATIONS.

14 JUN 2018 12:27
 D:\Technical\Information\Truff\c\Cur*100056469 U=6015 B=C Sig_Sys*Task 11_Corrs#FS 4.062.dgn
 SLODC363 AT LUS355433

ATKINS 1616 EAST MILLBROOK ROAD, SUITE 160
 RALEIGH, NORTH CAROLINA 27609
 (919) 876-6888 NCBEE# F-0326

**DOCUMENT NOT CONSIDERED FINAL
 UNLESS ALL SIGNATURES COMPLETED**

	Prepared for the Offices of: 		
	Burlington-Graham Signal System Fiber-Optic Splicing Details		
Division 7 Alamance County Burlington & Graham		PLAN DATE: June 2018 REVIEWED BY: HA BADGETT	
PREPARED BY: BJ SLOCUM		REVIEWED BY: DL JONES	
SCALE: N/A		REVISIONS: _____ INIT. DATE _____	

SPLICE NO.
S10-5

FISHER ST & MAPLE AVE
SEE: CRP-6.024

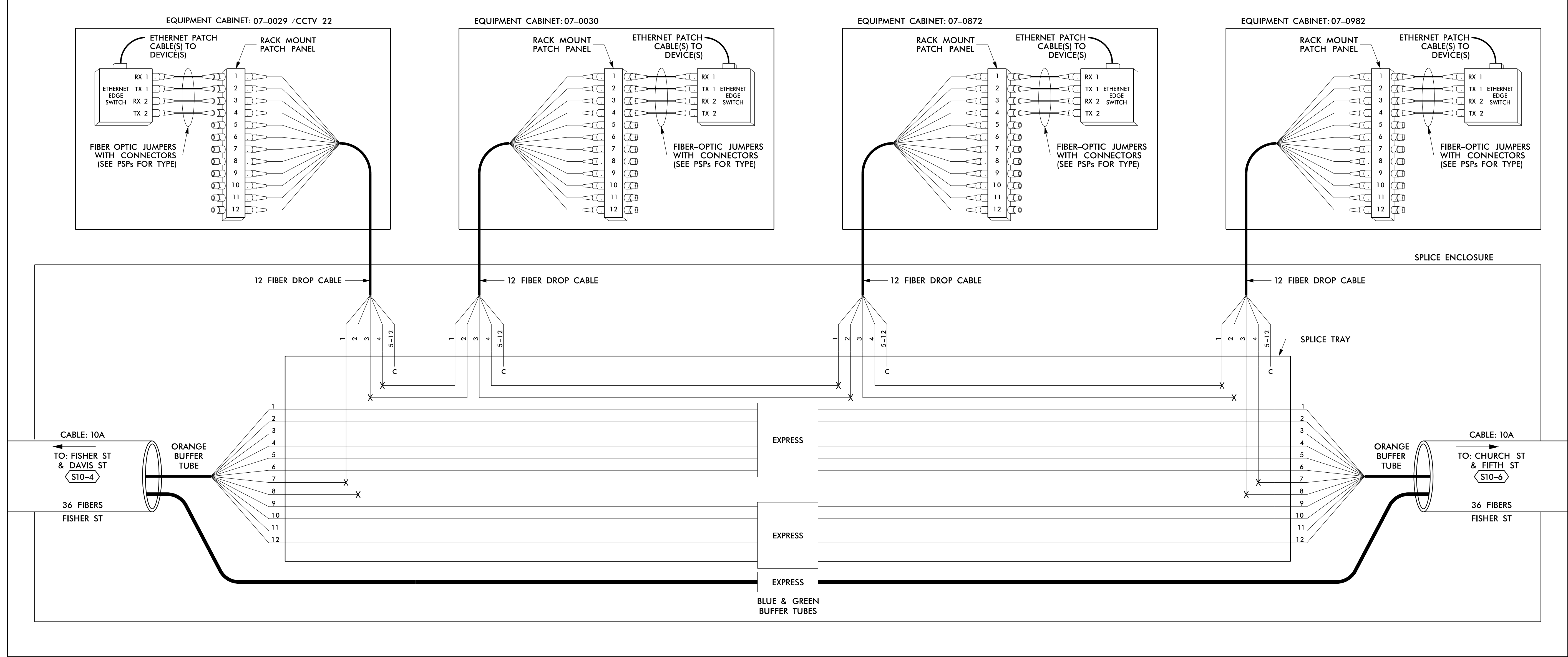

LEGEND

(1) BLUE	(7) RED	EXPRESS	EXPRESS ENTIRE BUFFER TUBE / FIBERS THROUGH WITHOUT CUTTING
(2) ORANGE	(8) BLACK	BUFFER SPLICE	SPLICE ALL FIBERS IN BUFFER TUBE COLOR TO COLOR
(3) GREEN	(9) YELLOW	EXISTING	EXISTING BUFFER TUBE / FIBERS DO NOT MODIFY EXISTING SPLICES OR EXPRESSED FIBERS.
(4) BROWN	(10) VIOLET		
(5) SLATE	(11) ROSE		
(6) WHITE	(12) AQUA		

X = FUSION SPLICE INDIVIDUAL FIBER
C = CAP AND SEAL

- NOTES**
- UNUSED FIBERS LEFT COILED AND STORED IN SPLICE TRAY
 - UNUSED BUFFER TUBES LEFT COILED AND STORED IN SPLICE ENCLOSURE
 - EDGE SWITCH CONFIGURATIONS ARE GENERIC. CONTRACTOR IS RESPONSIBLE FOR DETERMINING/ENSURING THE PROPER TERMINATIONS.

14 JUN 2018 12:27
 D:\projects\proj\com\tr\off\c\cur*100056469 U=6015 B=C Sig_Sys*Task 11_Corrs#FS 4.063.dgn
 S:\DCS\653 AT LUS355433

ATKINS

1616 EAST MILLBROOK ROAD, SUITE 160
RALEIGH, NORTH CAROLINA 27609
(919) 876-6888 NCBES #F-0326

Burlington-Graham Signal System
Fiber-Optic Splicing Details

Division 7 Alamance County Burlington & Graham

PLAN DATE: June 2018 REVIEWED BY: HA BADGETT

PREPARED BY: BJ SLOCUM REVIEWED BY: DL JONES

REVISIONS	INIT.	DATE

SCALE: N/A

SEAL

NORTH CAROLINA PROFESSIONAL ENGINEER

SEAL 040877

BRADFORD J. SLOCUM

DATE: 6/15/2018

DATE: _____

CADD File name: FS 4.063.dgn

DOCUMENT NOT CONSIDERED FINAL UNLESS ALL SIGNATURES COMPLETED

SPLICE NO.

S10-6

CHURCH ST & FIFTH ST
SEE: CRP-6.024

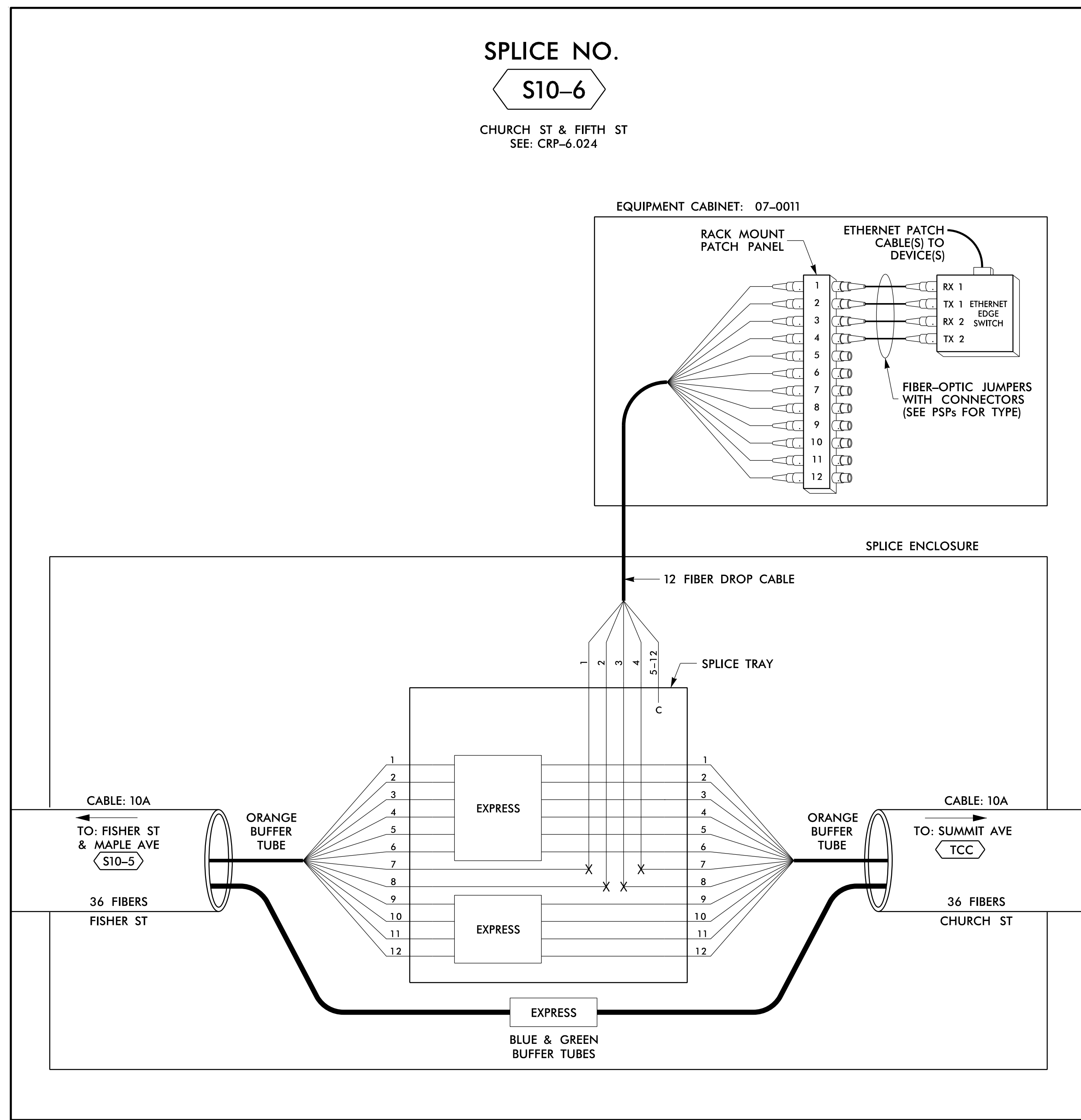

14 JUN 2018 12:27
 D:\Technical\Information\Traffic\Cur*100056469 U=6015 B=C Sig_Sys*Task 11_Corrs*FS 4.064.dgn
 S:\DCS\653 AT_LUS355433

LEGEND

COLOR CODE TIA/EIA 598-B		X = FUSION SPlice INDIVIDUAL FIBER C = CAP AND SEAL
(1) BLUE	(7) RED	EXPRESS ENTIRE BUFFER TUBE / FIBERS THROUGH WITHOUT CUTTING
(2) ORANGE	(8) BLACK	
(3) GREEN	(9) YELLOW	BUFFER SPlice SPlice ALL FIBERS IN BUFFER TUBE COLOR TO COLOR
(4) BROWN	(10) VIOLET	
(5) SLATE	(11) ROSE	EXISTING EXISTING BUFFER TUBE / FIBERS DO NOT MODIFY EXISTING SPlices OR EXPRESSED FIBERS.
(6) WHITE	(12) AQUA	

NOTES

- UNUSED FIBERS LEFT COILED AND STORED IN SPLICE TRAY
- UNUSED BUFFER TUBES LEFT COILED AND STORED IN SPLICE ENCLOSURE
- EDGE SWITCH CONFIGURATIONS ARE GENERIC. CONTRACTOR IS RESPONSIBLE FOR DETERMINING/ENSURING THE PROPER TERMINATIONS.

ATKINS 1616 EAST MILLBROOK ROAD, SUITE 160
 RALEIGH, NORTH CAROLINA 27609
 (919) 876-6888 NCBEEES #F-0326

DOCUMENT NOT CONSIDERED FINAL UNLESS ALL SIGNATURES COMPLETED

Prepared for the Offices of: 750 Greenfield Parkway, Garner, NC 27529	Burlington-Graham Signal System Fiber-Optic Splicing Details		SEAL NORTH CAROLINA PROFESSIONAL ENGINEER SEAL 040877 BRADFORD J. SLOCUM 15/2018 DATE
	Division 7 Alamance County Burlington & Graham	PLAN DATE: June 2018 PREPARED BY: BJ SLOCUM	
SCALE N/A	REVISIONS INIT. DATE		DATE

CAAD File name: FS 4.064.dgn

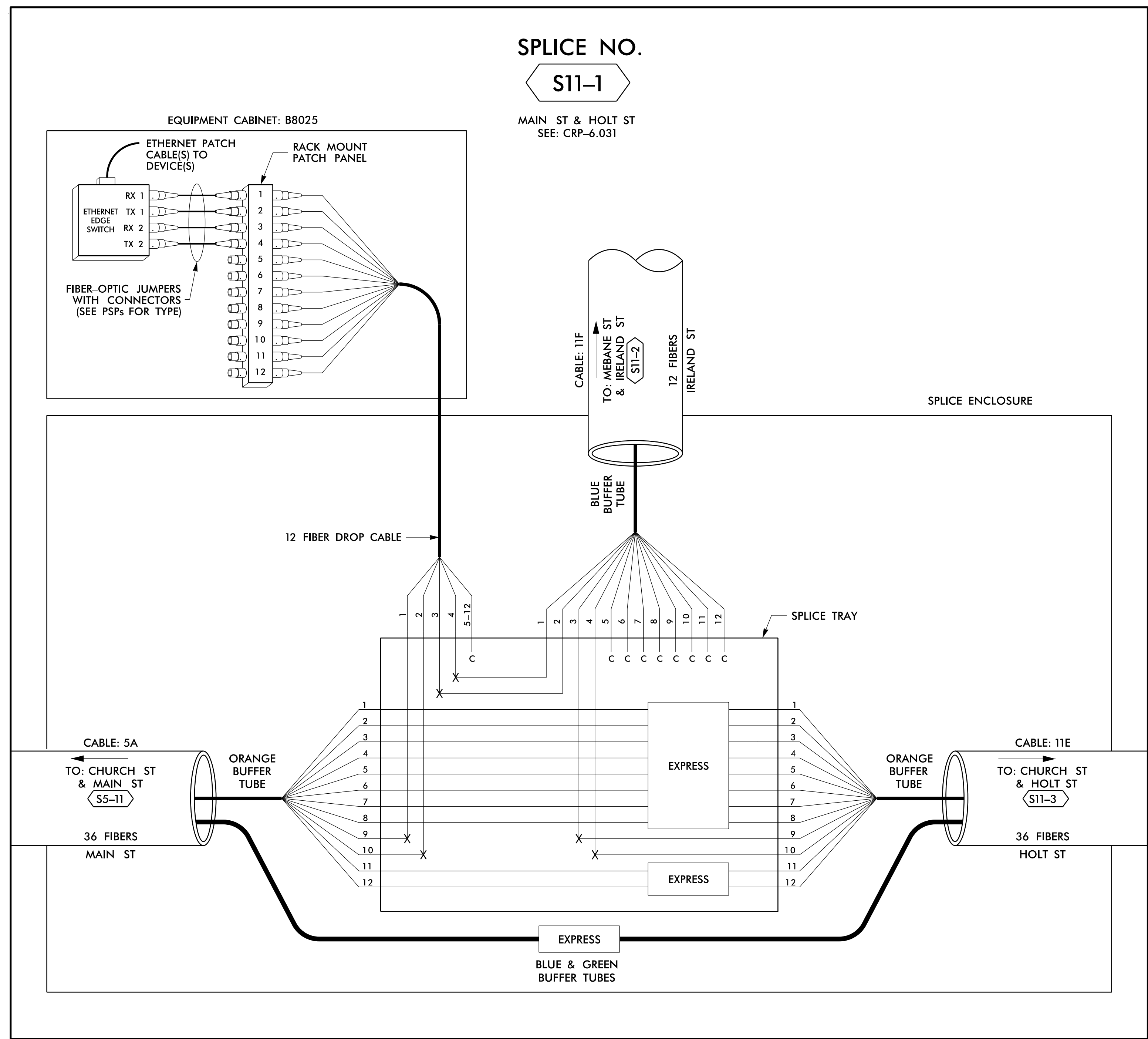

14 JUN 2018 12:28
 D:\Technical\Projects\U-6015 B-C Sig Sys\Task 11_Coms\F4.065.dgn
 S:\DCS\653 AT LUS355433

COLOR CODE		LEGEND	
(1) BLUE	(7) RED	EXPRESS	EXPRESS ENTIRE BUFFER TUBE / FIBERS THROUGH WITHOUT CUTTING
(2) ORANGE	(8) BLACK	BUFFER SPlice	SPLICE ALL FIBERS IN BUFFER TUBE COLOR TO COLOR
(3) GREEN	(9) YELLOW	EXISTING	EXISTING BUFFER TUBE / FIBERS DO NOT MODIFY EXISTING SPLICES OR EXPRESSED FIBERS.
(4) BROWN	(10) VIOLET		
(5) SLATE	(11) ROSE		
(6) WHITE	(12) AQUA		

- NOTES**
- UNUSED FIBERS LEFT COILED AND STORED IN SPLICE TRAY
 - UNUSED BUFFER TUBES LEFT COILED AND STORED IN SPLICE ENCLOSURE
 - EDGE SWITCH CONFIGURATIONS ARE GENERIC. CONTRACTOR IS RESPONSIBLE FOR DETERMINING/ENSURING THE PROPER TERMINATIONS.

ATKINS

1616 EAST MILLBROOK ROAD, SUITE 160
RALEIGH, NORTH CAROLINA 27609
(919) 876-6888 NCBEEs #F-0326

**DOCUMENT NOT CONSIDERED FINAL
UNLESS ALL SIGNATURES COMPLETED**

Prepared for the Offices of: NORTH CAROLINA DEPARTMENT OF TRANSPORTATION	
Burlington-Graham Signal System Fiber-Optic Splicing Details	
Division 7 Alamance County Burlington & Graham	
PLAN DATE: June 2018	REVIEWED BY: HA BADGETT
PREPARED BY: BJ SLOCUM	REVIEWED BY: DL JONES
SCALE: N/A	
REVISIONS	INIT. DATE

SEAL

BRADFORD J. SLOCUM
ENGINEER
15/2018

DATE

CADD File name: FS 4.065.dgn

SPLICE NO.

S11-2

MEBANE ST & IRELAND ST
SEE: CRP-6.032

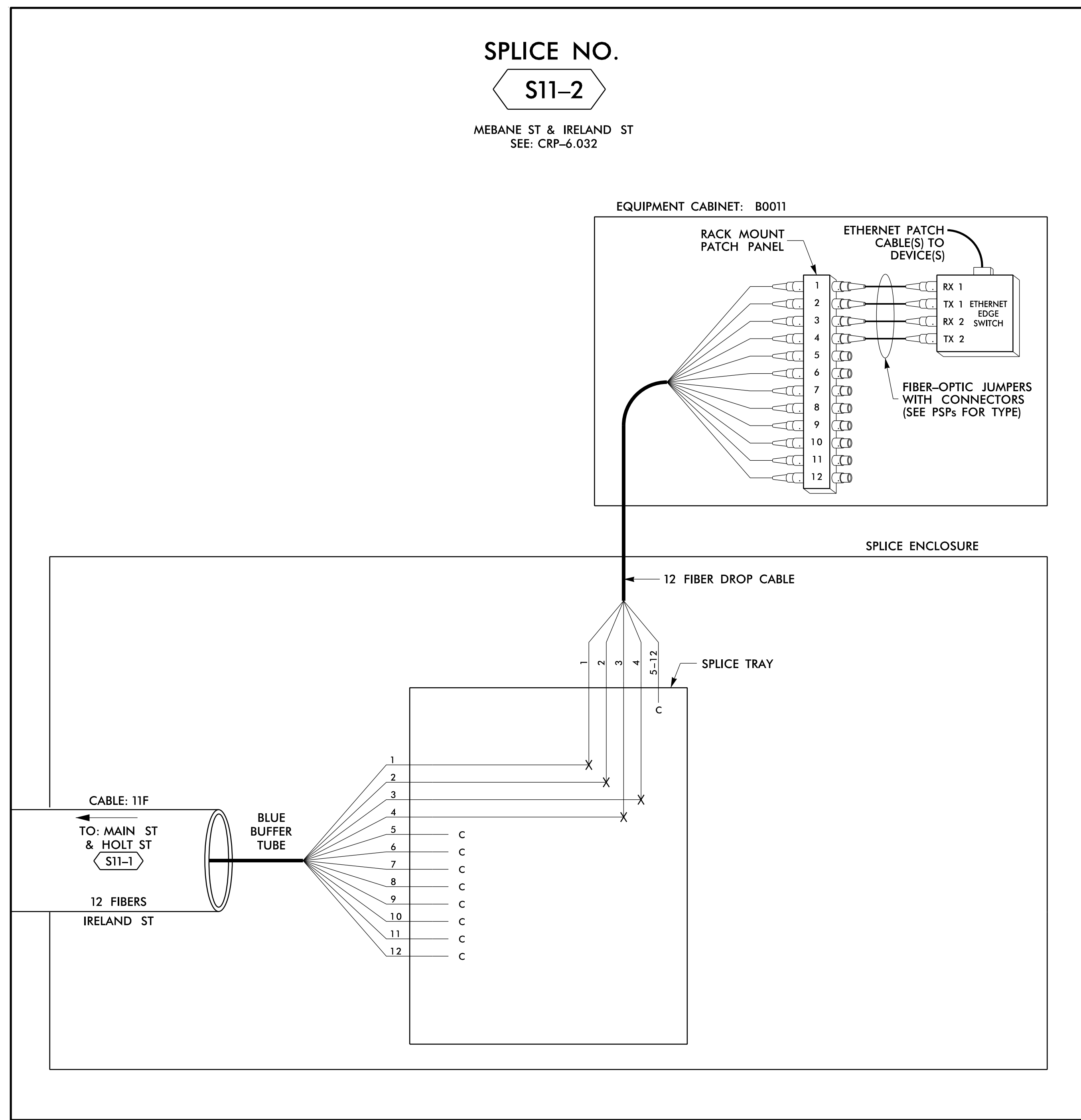

14 JUN 2018 12:28
 D:\Technical\Projects\U-6015 B-C Sig Sys\Task 11_Comms\F S 4.066.dgn
 S:\DCS\653 AT_LUS355433

LEGEND

COLOR CODE TIA/EIA 598-B		X = FUSION SPlice INDIVIDUAL FIBER C = CAP AND SEAL
(1) BLUE	(7) RED	EXPRESS EXPRESS ENTIRE BUFFER TUBE /FIBERS THROUGH WITHOUT CUTTING
(2) ORANGE	(8) BLACK	
(3) GREEN	(9) YELLOW	BUFFER SPlice SPlice ALL FIBERS IN BUFFER TUBE COLOR TO COLOR
(4) BROWN	(10) VIOLET	
(5) SLATE	(11) ROSE	EXISTING EXISTING BUFFER TUBE /FIBERS DO NOT MODIFY EXISTING SPlices OR EXPRESSED FIBERS.
(6) WHITE	(12) AQUA	

NOTES

- UNUSED FIBERS LEFT COILED AND STORED IN SPLICE TRAY
- UNUSED BUFFER TUBES LEFT COILED AND STORED IN SPLICE ENCLOSURE
- EDGE SWITCH CONFIGURATIONS ARE GENERIC. CONTRACTOR IS RESPONSIBLE FOR DETERMINING/ENSURING THE PROPER TERMINATIONS.

ATKINS 1616 EAST MILLBROOK ROAD, SUITE 160
 RALEIGH, NORTH CAROLINA 27609
 (919) 876-6888 NCBEEES #F-0326

DOCUMENT NOT CONSIDERED FINAL UNLESS ALL SIGNATURES COMPLETED

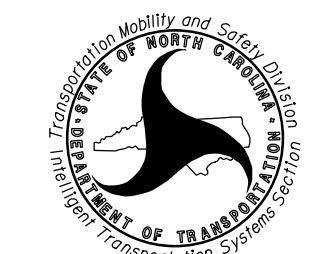
Prepared for the Offices of:  750 Greenfield Parkway, Garner, NC 27529	Burlington-Graham Signal System Fiber-Optic Splicing Details		SEAL NORTH CAROLINA PROFESSIONAL ENGINEER SEAL 040877 BRADFORD J. SLOCUM 15/2018 DATE
	Division 7 Alamance County Burlington & Graham	PLAN DATE: June 2018 REVIEWED BY: HA BADGETT	
SCALE N/A	REVISIONS	INIT. DATE	CAD00 File name: FS 4.066.dgn

SPLICE NO.

S11-3

CHURCH ST & HOLT ST
SEE: CRP-6.028

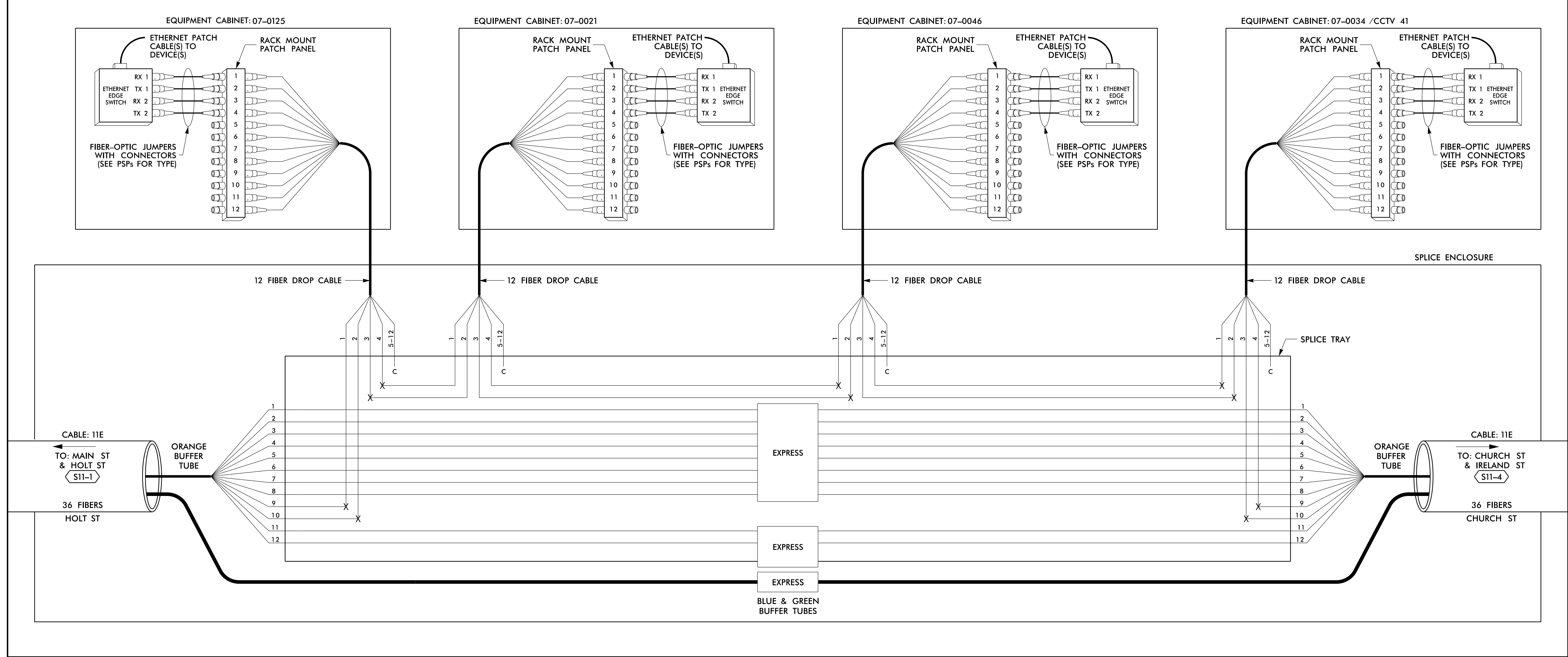

LEGEND

COLOR CODE TIA/EIA 598-B		X = FUSION SPLICE INDIVIDUAL FIBER	
(1) BLUE	(7) RED	EXPRESS	EXPRESS ENTIRE BUFFER TUBE / FIBERS THROUGH WITHOUT CUTTING
(2) ORANGE	(8) BLACK	BUFFER SPLICE	SPLICE ALL FIBERS IN BUFFER TUBE COLOR TO COLOR
(3) GREEN	(9) YELLOW	EXISTING	EXISTING BUFFER TUBE / FIBERS DO NOT MODIFY EXISTING SPLICES OR EXPRESSED FIBERS.
(4) BROWN	(10) VIOLET		
(5) SLATE	(11) ROSE		
(6) WHITE	(12) AQUA		

NOTES

- UNUSED FIBERS LEFT COILED AND STORED IN SPLICE TRAY
- UNUSED BUFFER TUBES LEFT COILED AND STORED IN SPLICE ENCLOSURE
- EDGE SWITCH CONFIGURATIONS ARE GENERIC. CONTRACTOR IS RESPONSIBLE FOR DETERMINING/ENSURING THE PROPER TERMINATIONS.

ATKINS 1616 EAST MILLBROOK ROAD, SUITE 160
RALEIGH, NORTH CAROLINA 27609
(919) 876-6888 NCBES #F-0326

DOCUMENT NOT CONSIDERED FINAL
UNLESS ALL SIGNATURES COMPLETED

	Burlington-Graham Signal System Fiber-Optic Splicing Details		
	Division 7 Alamance County Burlington & Graham		
PLAN DATE: June 2018 PREPARED BY: BJ SLOCUM	REVIEWED BY: HA BADGETT REVIEWED BY: DL JONES		
SCALE: N/A	REVISIONS	INIT. DATE	DATE

750 Greenfield Parkway, Garner, NC 27529

15/2018
DATE
CAD0 File name: FS 4.067.dgn

14-JUN-2018 12:29
 D:\Technical\Information\Traffic\Cur*100056469 U=6015 B=C Sig_Sys*Task 11_Corrs*FS 4.067.dgn
 SLOCUM3 AT LUS355433

SPLICE NO. S11-4

CHURCH ST & IRELAND ST SEE: CRP-6.029

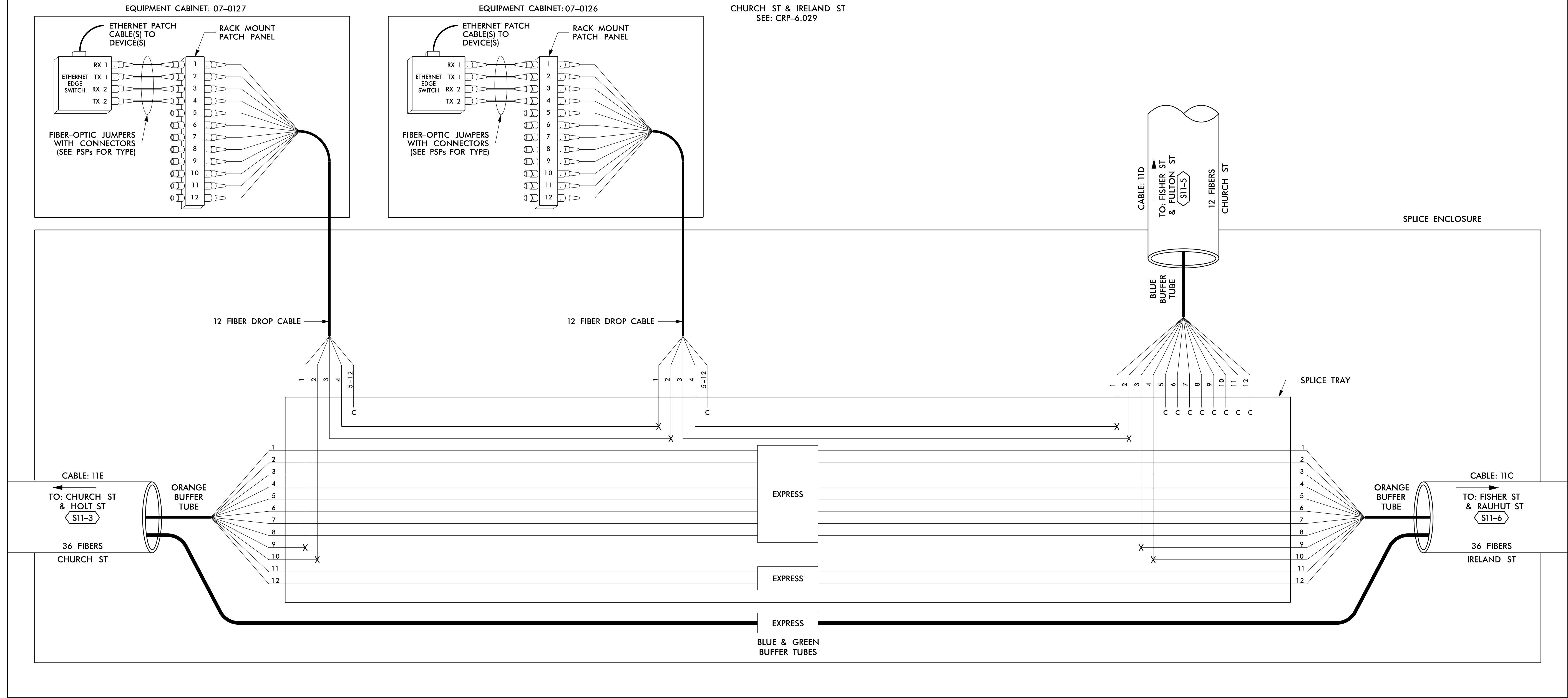

14 JUN 2018 12:29 D:\Technical\11_Comm\Task 11_Comm\Fs 4.068.dgn S:\033633 AT LUS355433

LEGEND

COLOR CODE TIA/EIA 598-B		X = FUSION SPLICE INDIVIDUAL FIBER	
(1) BLUE	(7) RED	EXPRESS	EXPRESS ENTIRE BUFFER TUBE / FIBERS THROUGH WITHOUT CUTTING
(2) ORANGE	(8) BLACK	BUFFER SPLICE	SPLICE ALL FIBERS IN BUFFER TUBE COLOR TO COLOR
(3) GREEN	(9) YELLOW	EXISTING	EXISTING BUFFER TUBE / FIBERS DO NOT MODIFY EXISTING SPLICES OR EXPRESSED FIBERS.
(4) BROWN	(10) VIOLET		
(5) SLATE	(11) ROSE		
(6) WHITE	(12) AQUA		

NOTES

- UNUSED FIBERS LEFT COILED AND STORED IN SPLICE TRAY
- UNUSED BUFFER TUBES LEFT COILED AND STORED IN SPLICE ENCLOSURE
- EDGE SWITCH CONFIGURATIONS ARE GENERIC. CONTRACTOR IS RESPONSIBLE FOR DETERMINING/ENSURING THE PROPER TERMINATIONS.

ATKINS 1616 EAST MILLBROOK ROAD, SUITE 160 RALEIGH, NORTH CAROLINA 27609 (919) 876-6888 NCBEEES #F-0326

Prepared for the Offices of:

 Department of Transportation, State of North Carolina

Burlington-Graham Signal System
 Fiber-Optic Splicing Details

Division 7 Alamance County Burlington & Graham

PLAN DATE: June 2018 REVIEWED BY: HA BADGETT
 PREPARED BY: BJ SLOCUM REVIEWED BY: DL JONES

REVISIONS	INIT.	DATE

SCALE: N/A

750 Greenfield Parkway, Garner, NC 27529

SEAL NORTH CAROLINA PROFESSIONAL ENGINEER SEAL 040877 BRADFORD J. SLOCUM

DocuSign ID: 15/2018 DATE

CADD File name: FS 4.068.dgn

SPLICE NO.

S11-5

FISHER ST & FULTON ST
SEE: CRP-6.030

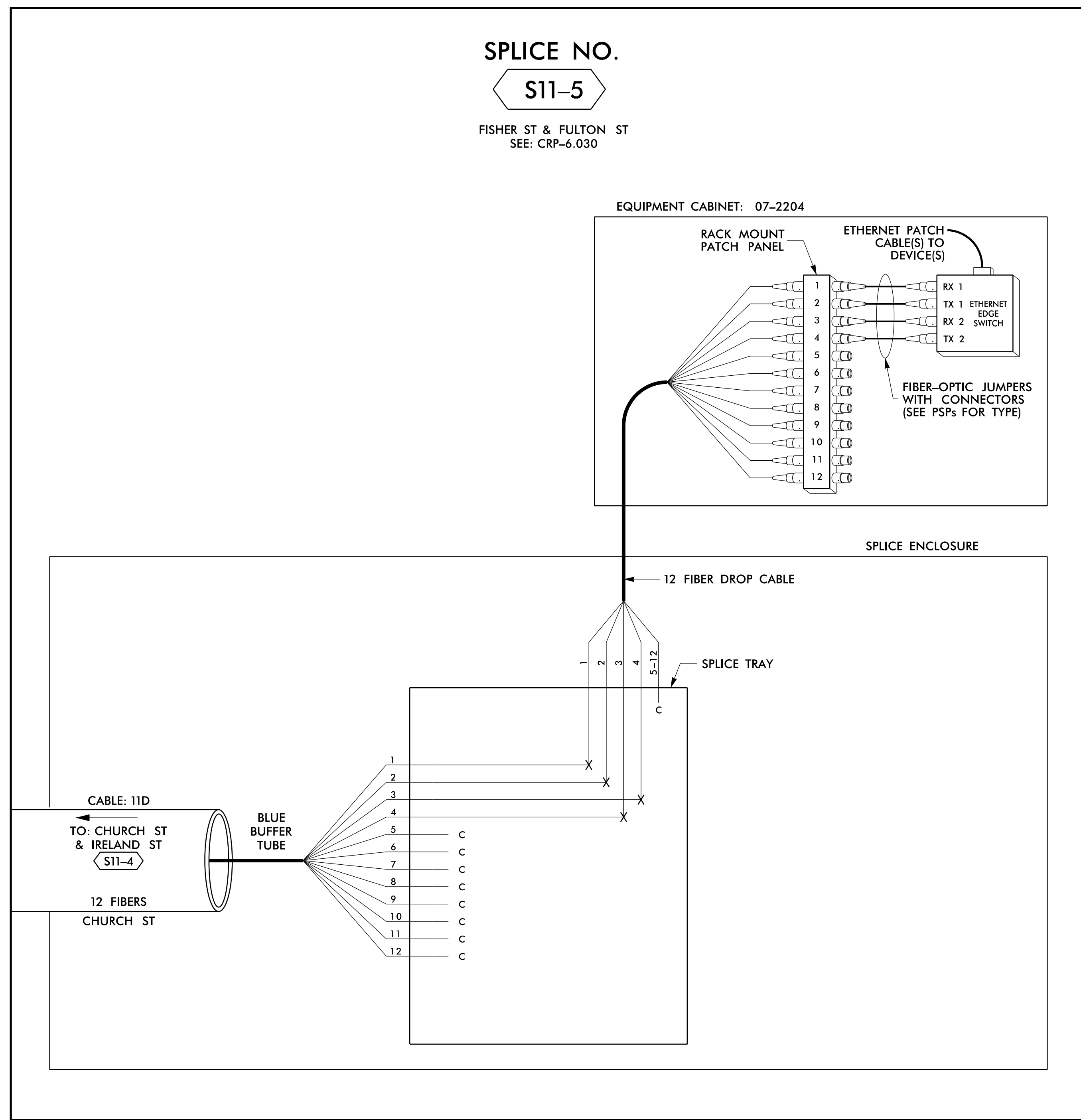

14 JUN 2018 12:29
 D:\Technical\Projects\U-6015 B-C Sig. Sys\Task 11_Comms\F S 4.069.dgn
 S:\DCS\653 AT_LUS355433

LEGEND

COLOR CODE TIA/EIA 598-B		X = FUSION SPlice INDIVIDUAL FIBER C = CAP AND SEAL
(1) BLUE	(7) RED	EXPRESS ENTIRE BUFFER TUBE / FIBERS THROUGH WITHOUT CUTTING
(2) ORANGE	(8) BLACK	
(3) GREEN	(9) YELLOW	BUFFER SPlice SPlice ALL FIBERS IN BUFFER TUBE COLOR TO COLOR
(4) BROWN	(10) VIOLET	
(5) SLATE	(11) ROSE	EXISTING EXISTING BUFFER TUBE / FIBERS DO NOT MODIFY EXISTING SPlices OR EXPRESSED FIBERS.
(6) WHITE	(12) AQUA	

NOTES

- UNUSED FIBERS LEFT COILED AND STORED IN SPLICE TRAY
- UNUSED BUFFER TUBES LEFT COILED AND STORED IN SPLICE ENCLOSURE
- EDGE SWITCH CONFIGURATIONS ARE GENERIC. CONTRACTOR IS RESPONSIBLE FOR DETERMINING/ENSURING THE PROPER TERMINATIONS.

ATKINS 1616 EAST MILLBROOK ROAD, SUITE 160
 RALEIGH, NORTH CAROLINA 27609
 (919) 876-6888 NCBEEES #F-0326

DOCUMENT NOT CONSIDERED FINAL UNLESS ALL SIGNATURES COMPLETED

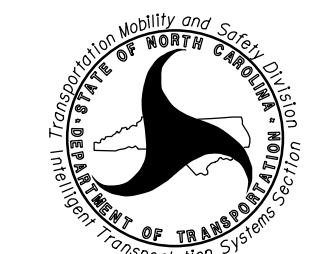
Prepared for the Offices of:  750 Greenfield Parkway, Garner, NC 27529	Burlington-Graham Signal System Fiber-Optic Splicing Details		SEAL NORTH CAROLINA PROFESSIONAL ENGINEER SEAL 040877 BRADFORD J. SLOCUM 15/2018 DATE
	Division 7 Alamance County Burlington & Graham	PLAN DATE: June 2018 PREPARED BY: BJ SLOCUM	
SCALE N/A	REVISIONS		INIT. DATE
CADD File name: FS 4.069.dgn			DATE

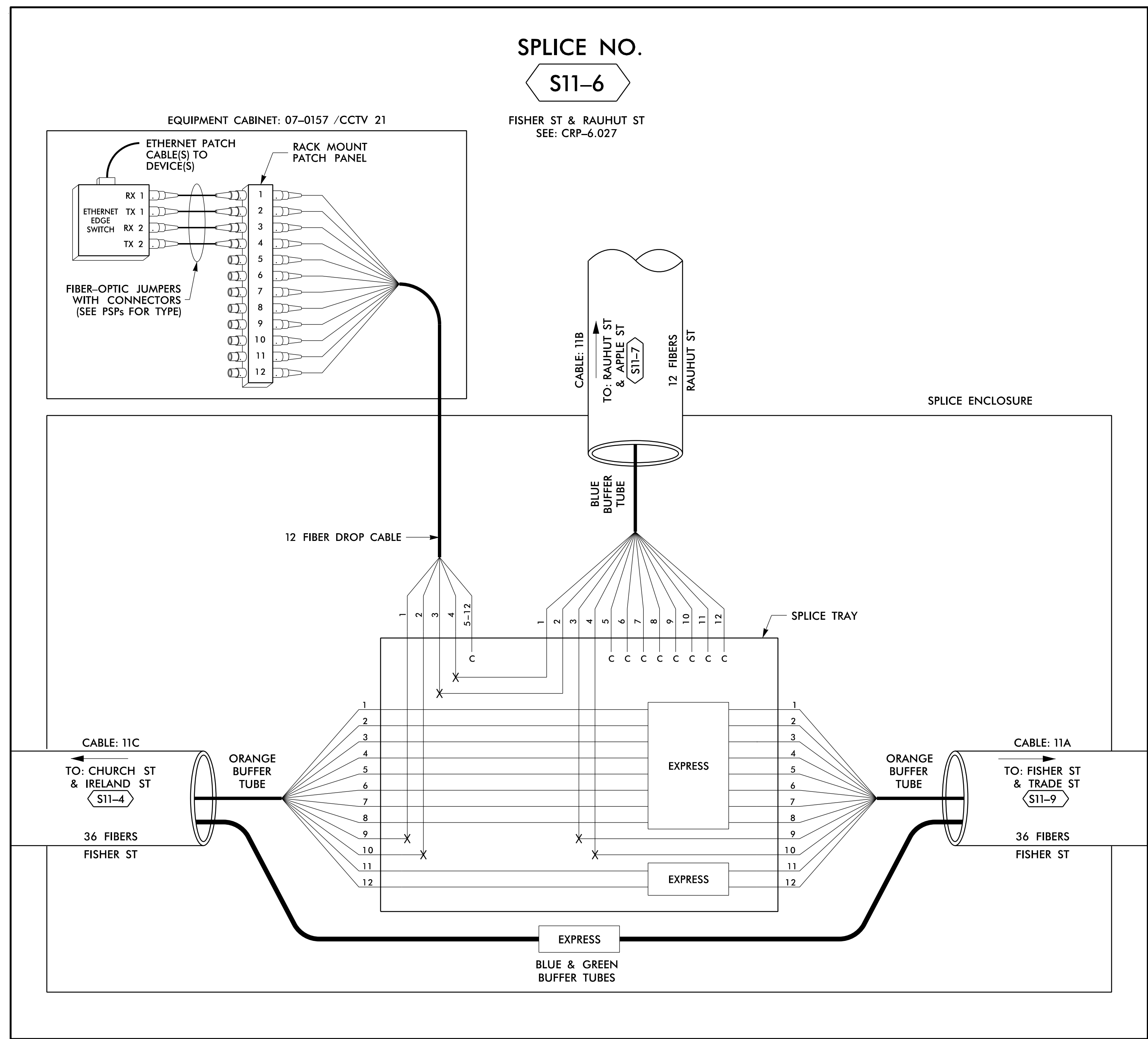

SPLICE NO.
S11-6

FISHER ST & RAUHUT ST
SEE: CRP-6.027

EQUIPMENT CABINET: 07-0157 / CCTV 21

SPLICE ENCLOSURE

12 FIBER DROP CABLE

CABLE: 11B
TO: RAUHUT ST & APPLE ST
S11-7
12 FIBERS
RAUHUT ST

CABLE: 11C
TO: CHURCH ST & IRELAND ST
S11-4
36 FIBERS
FISHER ST

ORANGE BUFFER TUBE

EXPRESS

ORANGE BUFFER TUBE

CABLE: 11A
TO: FISHER ST & TRADE ST
S11-9
36 FIBERS
FISHER ST

EXPRESS
BLUE & GREEN
BUFFER TUBES

LEGEND

COLOR CODE TIA/EIA 598-B		X = FUSION SPlice INDIVIDUAL FIBER	
(1) BLUE	(7) RED	EXPRESS	EXPRESS ENTIRE BUFFER TUBE / FIBERS THROUGH WITHOUT CUTTING
(2) ORANGE	(8) BLACK	BUFFER SPlice	SPlice ALL FIBERS IN BUFFER TUBE COLOR TO COLOR
(3) GREEN	(9) YELLOW	EXISTING	EXISTING BUFFER TUBE / FIBERS. DO NOT MODIFY EXISTING SPlices OR EXPRESSED FIBERS.
(4) BROWN	(10) VIOLET		
(5) SLATE	(11) ROSE		
(6) WHITE	(12) AQUA		

NOTES

- UNUSED FIBERS LEFT COILED AND STORED IN SPLICE TRAY
- UNUSED BUFFER TUBES LEFT COILED AND STORED IN SPLICE ENCLOSURE
- EDGE SWITCH CONFIGURATIONS ARE GENERIC. CONTRACTOR IS RESPONSIBLE FOR DETERMINING/ENSURING THE PROPER TERMINATIONS.

14 JUN 2018 12:29
 D:\Technical\Information\Traffic\Cur*100056469 U=6015 B=C Sig_Sys*Task 11_Corrs*FS 4_070.dgn
 S:\DCS\653 AT LUS355433

ATKINS 1616 EAST MILLBROOK ROAD, SUITE 160
RALEIGH, NORTH CAROLINA 27609
(919) 876-6888 NCBEE# F-0326

DOCUMENT NOT CONSIDERED FINAL
UNLESS ALL SIGNATURES COMPLETED

Prepared for the Offices of:

 750 Greenfield Parkway, Garner, NC 27529
 SCALE: N/A

Burlington-Graham Signal System Fiber-Optic Splicing Details		Burlington & Graham	
Division 7	Alamance County		
PLAN DATE: June 2018	REVIEWED BY: HA BADGETT		
PREPARED BY: BJ SLOCUM	REVIEWED BY: DL JONES		
REVISIONS	INIT.	DATE	

SEAL
 NORTH CAROLINA
 PROFESSIONAL
 SEAL
 040877
 ENGINEER
 Bradford J. Slocum
 15/2018
 DATE
 CADD File name: FS 4.070.dgn

SPLICE NO.

S11-9

FISHER ST & TRADE ST
SEE: CRP-6.026

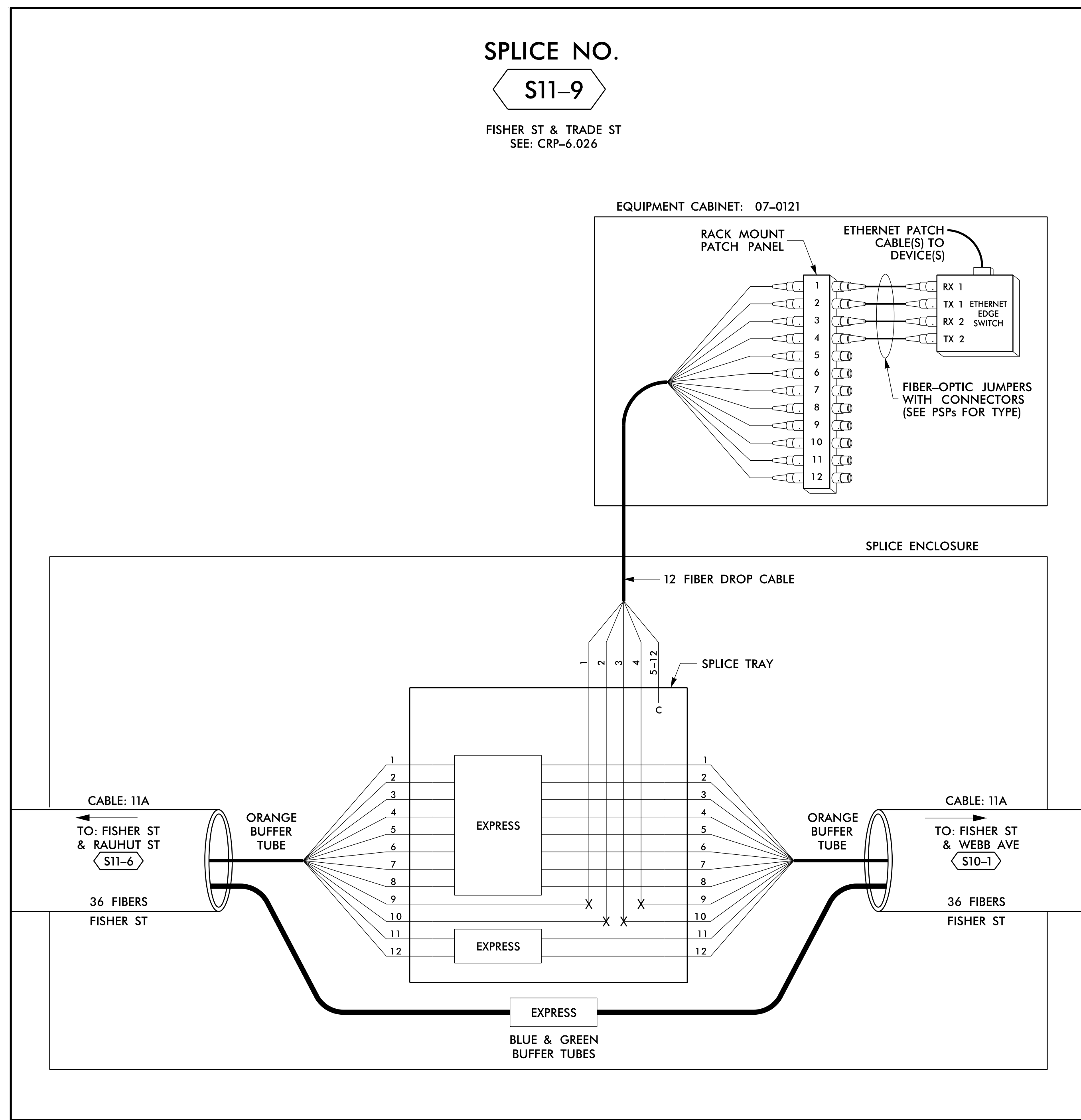

14 JUN 2018 12:29
 D:\Technical\Projects\U-6015 B-C Sig Sys\Task 11_Comms\F5 4.072.dgn
 S:\DCS\653 AT_LUS355433

LEGEND

COLOR CODE TIA/EIA 598-B		X = FUSION SPlice INDIVIDUAL FIBER C = CAP AND SEAL
(1) BLUE	(7) RED	EXPRESS
(2) ORANGE	(8) BLACK	EXPRESS ENTIRE BUFFER TUBE / FIBERS THROUGH WITHOUT CUTTING
(3) GREEN	(9) YELLOW	BUFFER SPlice
(4) BROWN	(10) VIOLET	SPlice ALL FIBERS IN BUFFER TUBE COLOR TO COLOR
(5) SLATE	(11) ROSE	EXISTING
(6) WHITE	(12) AQUA	EXISTING BUFFER TUBE / FIBERS. DO NOT MODIFY EXISTING SPlices OR EXPRESSED FIBERS.

NOTES

- UNUSED FIBERS LEFT COILED AND STORED IN SPLICE TRAY
- UNUSED BUFFER TUBES LEFT COILED AND STORED IN SPLICE ENCLOSURE
- EDGE SWITCH CONFIGURATIONS ARE GENERIC. CONTRACTOR IS RESPONSIBLE FOR DETERMINING/ENSURING THE PROPER TERMINATIONS.

ATKINS 1616 EAST MILLBROOK ROAD, SUITE 160
 RALEIGH, NORTH CAROLINA 27609
 (919) 876-6888 NCBEEES #F-0326

DOCUMENT NOT CONSIDERED FINAL UNLESS ALL SIGNATURES COMPLETED

Prepared for the Offices of:  750 Greenfield Parkway, Garner, NC 27529	Burlington-Graham Signal System Fiber-Optic Splicing Details		SEAL NORTH CAROLINA PROFESSIONAL ENGINEER SEAL 040877 BRADFORD J. SLOCUM 15/2018 DATE
	Division 7 Alamance County PLAN DATE: June 2018 PREPARED BY: BJ SLOCUM	Burlington & Graham REVIEWED BY: HA BADGETT REVIEWED BY: DL JONES	
SCALE N/A	CADD File name: FS 4.072.dgn		

SPLICE NO. S12-1

WEBB AVE & TROLLINGER ST
SEE: CRP-6.142

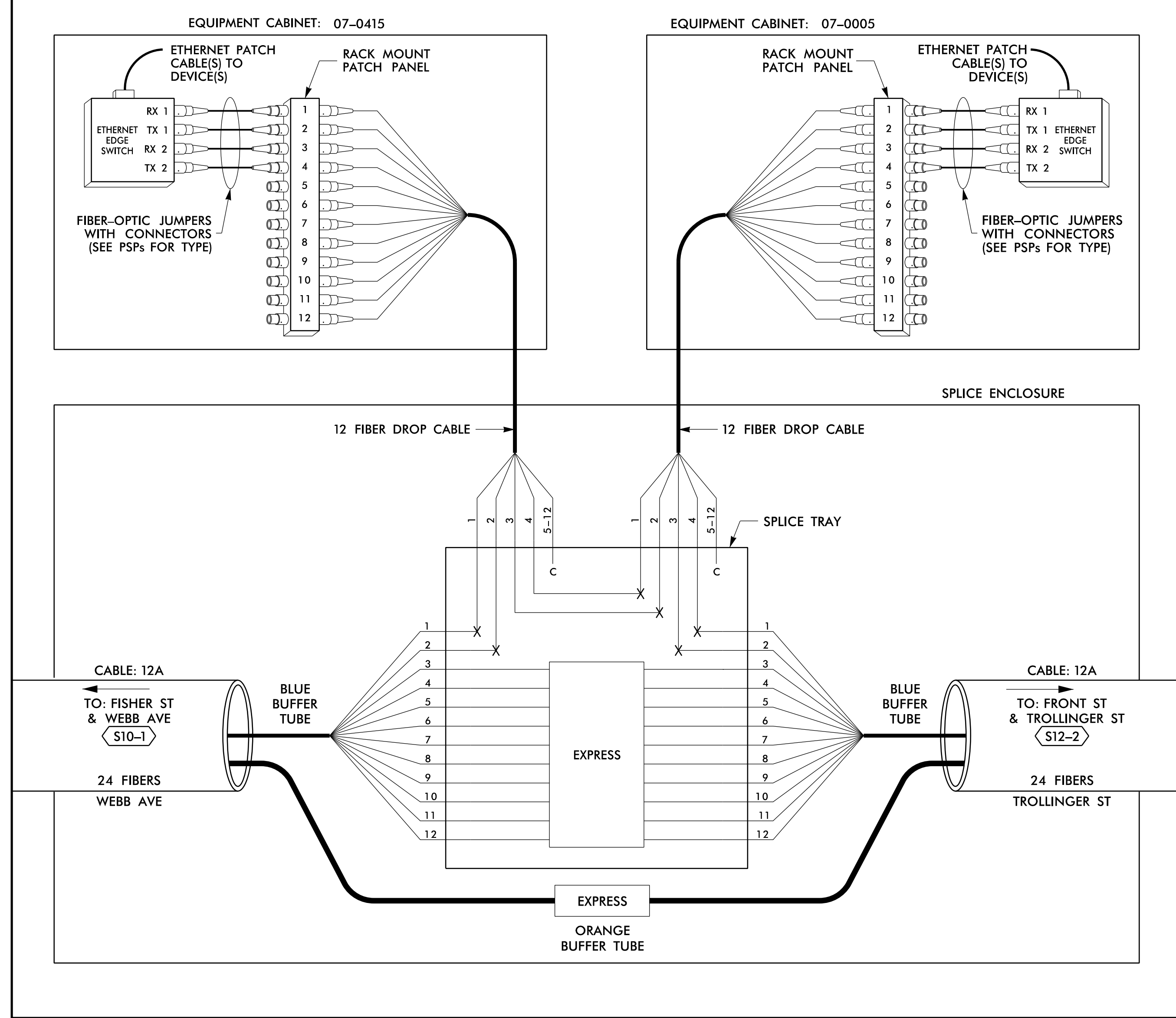

SPLICE NO. S12-2

FRONT ST & TROLLINGER ST
SEE: CRP-6.140

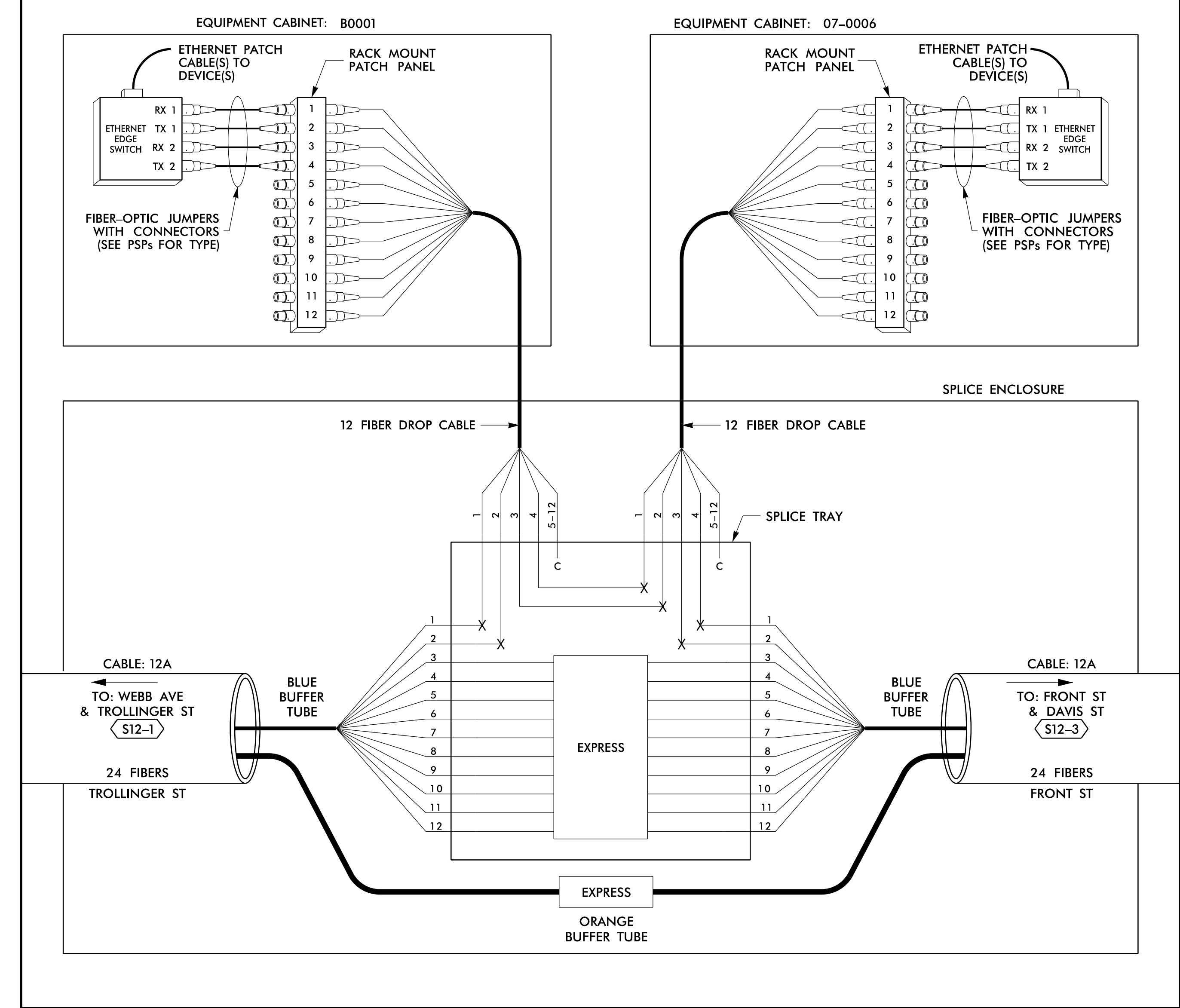

14 JUN 2018 12:29
D:\projects\proj\csm\tr\off\c\cur\100056469 U-6015 B-C Sig_Sys\Task 11_Coms\F S 4.073.dgn
SLOCUM AT LUIS355433

LEGEND

COLOR CODE TIA/EIA 598-B		X = FUSION SPLICE INDIVIDUAL FIBER	
(1) BLUE	(7) RED	EXPRESS	EXPRESS ENTIRE BUFFER TUBE / FIBERS THROUGH WITHOUT CUTTING
(2) ORANGE	(8) BLACK	BUFFER SPLICE	SPLICE ALL FIBERS IN BUFFER TUBE COLOR TO COLOR
(3) GREEN	(9) YELLOW	EXISTING	EXISTING BUFFER TUBE / FIBERS DO NOT MODIFY EXISTING SPLICES OR EXPRESSED FIBERS.
(4) BROWN	(10) VIOLET		
(5) SLATE	(11) ROSE		
(6) WHITE	(12) AQUA		

NOTES

- UNUSED FIBERS LEFT COILED AND STORED IN SPLICE TRAY
- UNUSED BUFFER TUBES LEFT COILED AND STORED IN SPLICE ENCLOSURE
- EDGE SWITCH CONFIGURATIONS ARE GENERIC. CONTRACTOR IS RESPONSIBLE FOR DETERMINING/ENSURING THE PROPER TERMINATIONS.

ATKINS 1616 EAST MILLBROOK ROAD, SUITE 160
RALEIGH, NORTH CAROLINA 27609
(919) 876-6888 NCBES #F-0326

DOCUMENT NOT CONSIDERED FINAL
UNLESS ALL SIGNATURES COMPLETED

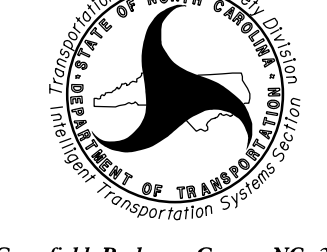
Prepared for the Offices of:

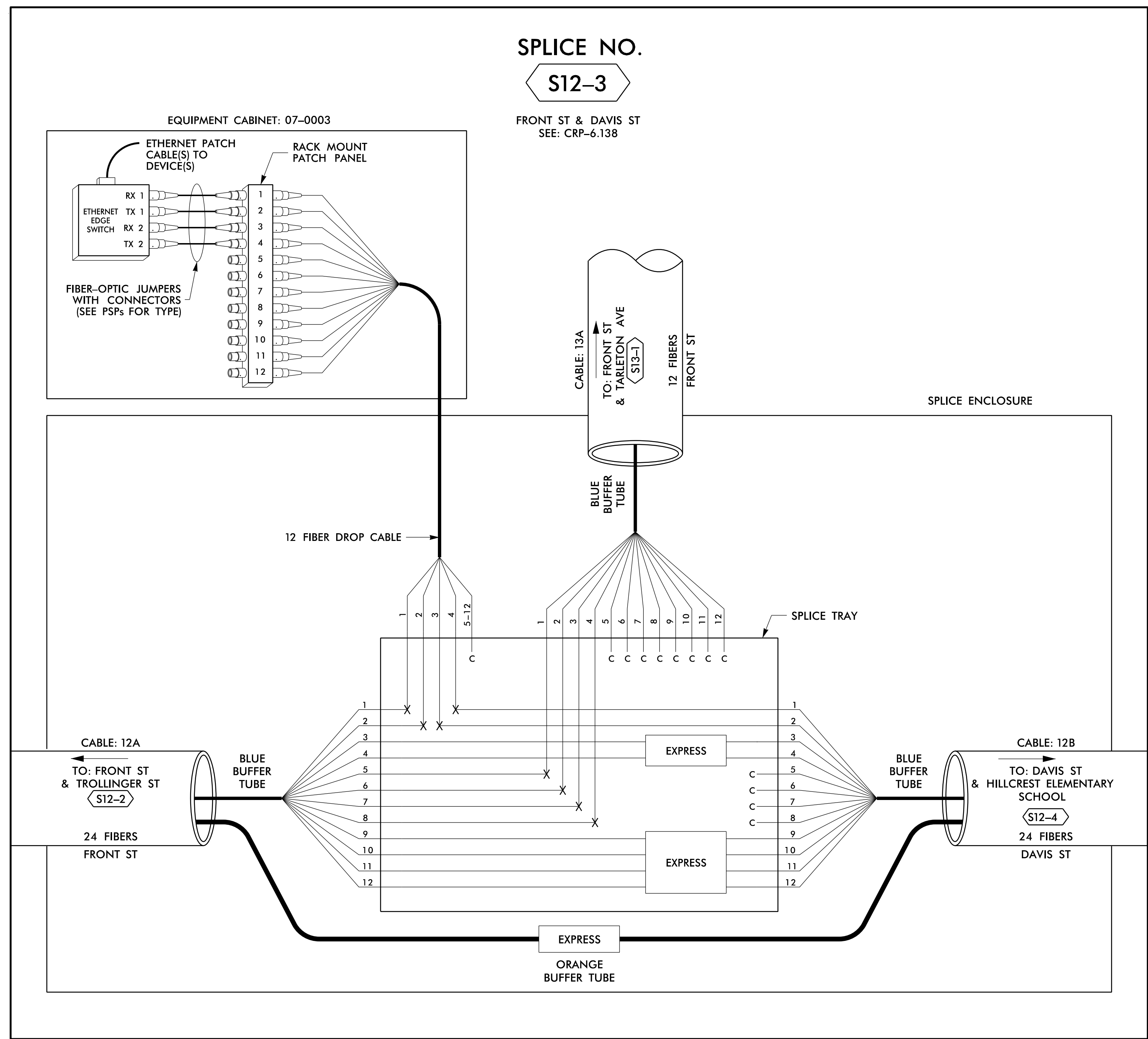
 Burlington-Graham Signal System
 Fiber-Optic Splicing Details
 Division 7 Alamance County Burlington & Graham
 PLAN DATE: June 2018 REVIEWED BY: HA BADGETT
 PREPARED BY: BJ SLOCUM REVIEWED BY: DL JONES
 SCALE: N/A
 REVISIONS: _____ INIT. DATE _____
 SEAL NORTH CAROLINA PROFESSIONAL ENGINEER SEAL 040877
 BRADFORD J. SLOCUM
 DATE: 6/15/2018
 CADD Filename: FS 4.073.dgn



14 JUN 2018 12:29
 D:\projects\atkins\proj\11\1100056469 U-6015 B-C Sig_Sys\Task 11_Coms\F5 4.074.dgn
 S:\DCS\653 AT_LUS355433

COLOR CODE		LEGEND	
(1) BLUE	(7) RED	X = FUSION SPlice INDIVIDUAL FIBER	EXPRESS
(2) ORANGE	(8) BLACK	C = CAP AND SEAL	EXPRESS ENTIRE BUFFER TUBE /FIBERS THROUGH WITHOUT CUTTING
(3) GREEN	(9) YELLOW		BUFFER SPlice
(4) BROWN	(10) VIOLET		SPlice ALL FIBERS IN BUFFER TUBE COLOR TO COLOR
(5) SLATE	(11) ROSE		EXISTING
(6) WHITE	(12) AQUA		EXISTING BUFFER TUBE /FIBERS DO NOT MODIFY EXISTING SPlices OR EXPRESSED FIBERS.

- NOTES**
- UNUSED FIBERS LEFT COILED AND STORED IN SPLICE TRAY
 - UNUSED BUFFER TUBES LEFT COILED AND STORED IN SPLICE ENCLOSURE
 - EDGE SWITCH CONFIGURATIONS ARE GENERIC. CONTRACTOR IS RESPONSIBLE FOR DETERMINING/ENSURING THE PROPER TERMINATIONS.

750 Greenfield Parkway, Garner, NC 27529

1616 EAST MILLBROOK ROAD, SUITE 160
RALEIGH, NORTH CAROLINA 27609
(919) 876-6888 NCBES #F-0326

DOCUMENT NOT CONSIDERED FINAL UNLESS ALL SIGNATURES COMPLETED

ATKINS		Burlington-Graham Signal System Fiber-Optic Splicing Details	
Division 7 Alamance County		Burlington & Graham	
PLAN DATE: June 2018	REVIEWED BY: HA BADGETT		
PREPARED BY: BJ SLOCUM	REVIEWED BY: DL JONES		
SCALE: N/A	REVISIONS	INIT.	DATE

CADD File name: FS 4.074.dgn

SPLICE NO.
S12-4

DAVIS ST & HILLCREST ELEMENTARY SCHOOL
SEE: CRP-6.134

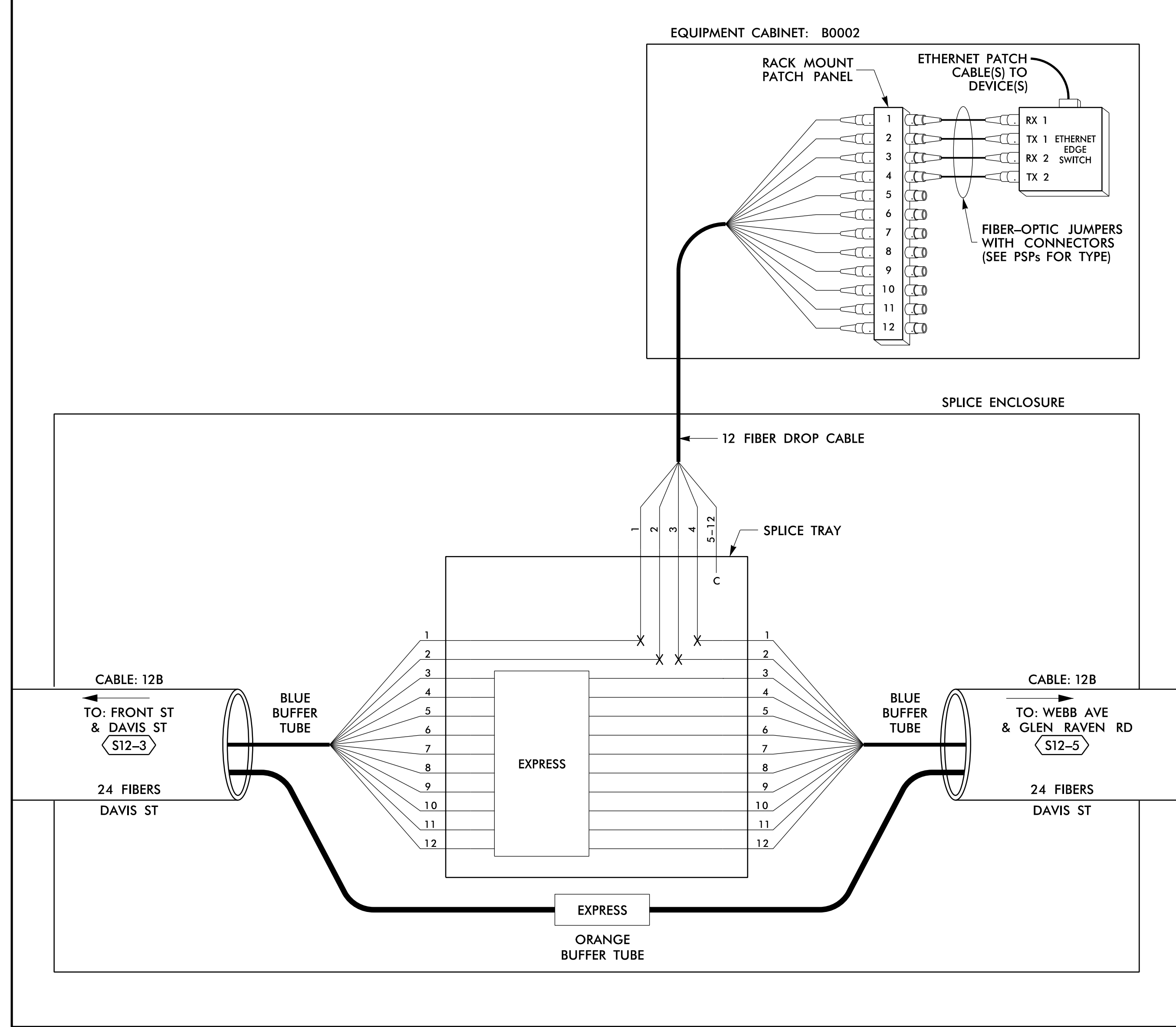

SPLICE NO.
S12-5

WEBB AVE & GLEN RAVEN RD
SEE: CRP-6.133

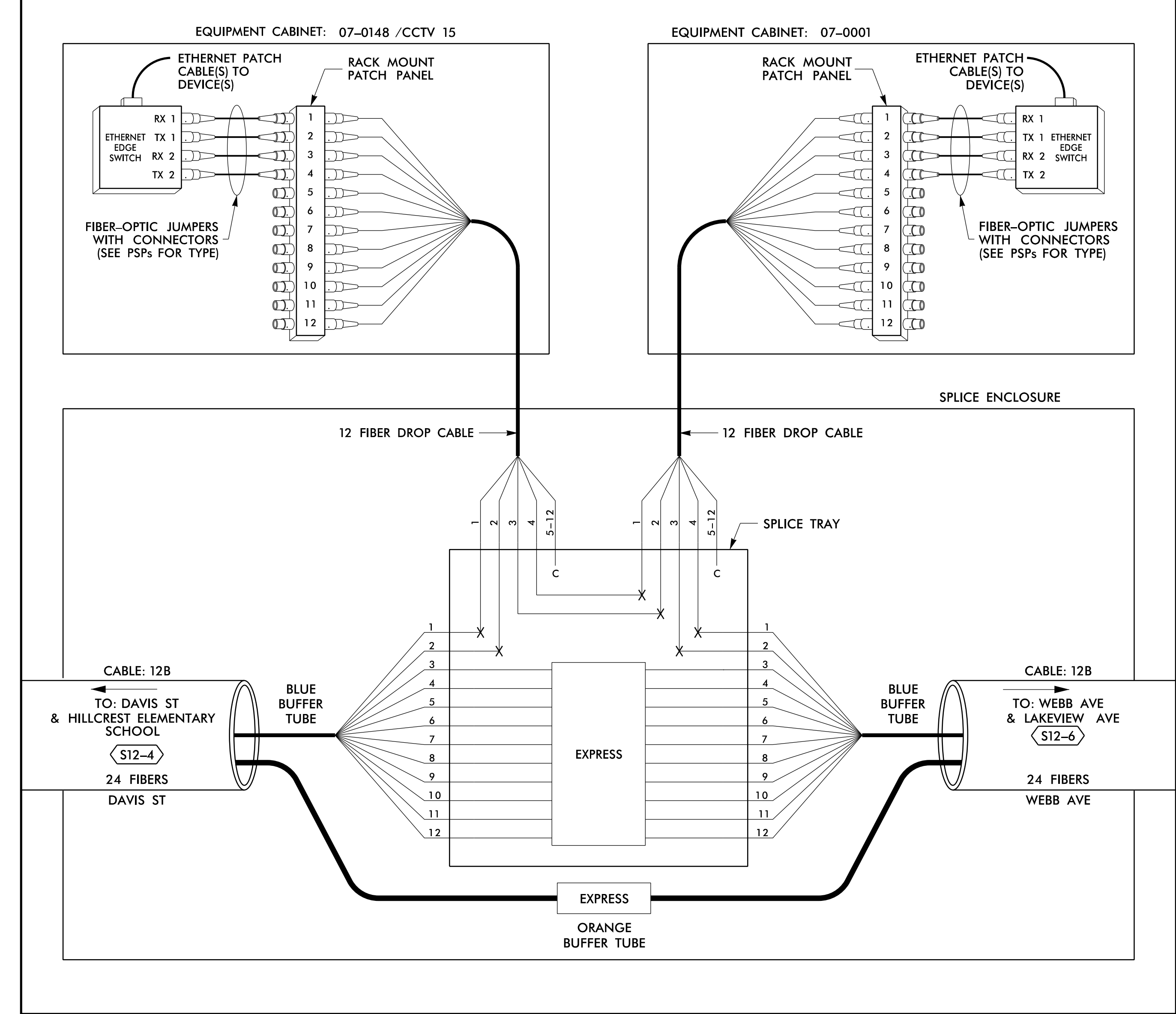

14 JUN 2018 12:29
 D:\projects\atkins\proj\off\c\cur\100056469 U-6015 B-C Sig Sys\Task 11_Corrs\F S 4.075.dgn
 S:\DCS\653 AT_LUS355433

LEGEND

COLOR CODE TIA/EIA 598-B		X = FUSION SPlice INDIVIDUAL FIBER	EXPRESS	EXPRESS ENTIRE BUFFER TUBE / FIBERS THROUGH WITHOUT CUTTING
(1) BLUE	(7) RED	C = CAP AND SEAL	BUFFER SPlice	SPlice ALL FIBERS IN BUFFER TUBE COLOR TO COLOR
(2) ORANGE	(8) BLACK		EXISTING	EXISTING BUFFER TUBE / FIBERS DO NOT MODIFY EXISTING SPlices OR EXPRESSED FIBERS.
(3) GREEN	(9) YELLOW			
(4) BROWN	(10) VIOLET			
(5) SLATE	(11) ROSE			
(6) WHITE	(12) AQUA			

NOTES

- UNUSED FIBERS LEFT COILED AND STORED IN SPLICE TRAY
- UNUSED BUFFER TUBES LEFT COILED AND STORED IN SPLICE ENCLOSURE
- EDGE SWITCH CONFIGURATIONS ARE GENERIC. CONTRACTOR IS RESPONSIBLE FOR DETERMINING/ENSURING THE PROPER TERMINATIONS.

ATKINS 1616 EAST MILLBROOK ROAD, SUITE 160
RALEIGH, NORTH CAROLINA 27609
(919) 876-6888 NCBES #F-0326

DOCUMENT NOT CONSIDERED FINAL
UNLESS ALL SIGNATURES COMPLETED

<p>750 Greenfield Parkway, Garner, NC 27529</p>	Prepared for the Offices of: 		SEAL NORTH CAROLINA PROFESSIONAL ENGINEER BRADFORD J. SLOCUM 040877 15/2018
	Burlington-Graham Signal System Fiber-Optic Splicing Details		
Division 7 Alamance County Burlington & Graham	PLAN DATE: June 2018 PREPARED BY: BJ SLOCUM	REVIEWED BY: HA BADGETT REVIEWED BY: DL JONES	REVISIONS INIT. DATE
SCALE N/A	CADD File name: FS 4.075.dgn		