

**This electronic collection of documents is provided
for the convenience of the user
and is Not a Certified Document –**

**The documents contained herein were originally issued
and sealed by the individuals whose names and license
numbers appear on each page, on the dates appearing
with their signature on that page.**

**This file or an individual page
shall not be considered a certified document.**

TIP PROJECT: U-2412A

CONTRACT:

**STATE OF NORTH CAROLINA
DEPARTMENT OF TRANSPORTATION**

**GUILFORD COUNTY
SIGNING PLAN**

**LOCATION: SR 1486/SR 4121 (GREENSBORO/HIGHPOINT RD) FROM PROPOSED
US 311 BYPASS TO WEST OF SR 1480 (VICKERY CHAPEL RD)**

<small>PROJECT REFERENCE NO.</small> U-2412A	<small>SHEET NO.</small> SIGN - 1
<small>DocuSigned by:</small> APPROVED <i>Kevin W. Bisby</i> <small>30E3C8ABDF464B1...</small>	
<small>DATE:</small> 3/18/2018	
	

ROADWAY STANDARD DRAWINGS

THE FOLLOWING ROADWAY STANDARDS AS APPEAR IN "ROADWAY STANDARD DRAWINGS" - PROJECT SERVICES UNIT - N.C. DEPARTMENT OF TRANSPORTATION - RALEIGH, N.C., DATED JANUARY 2018 ARE APPLICABLE TO THIS PROJECT AND BY REFERENCE HEREBY ARE CONSIDERED A PART OF THESE PLANS:

<u>STD. NO.</u>	<u>TITLE</u>
901.10	TYPE 'A' SIGNS
901.20	TYPE 'B' SIGNS
901.50	ARROWS AND SHIELDS
901.70	SIGN STRINGERS AND SUPPORT SPACING
901.80	SIGN MOUNTING DETAILS - FOR TYPE A AND TYPE B SIGNS
903.10	GROUND MOUNTED SIGN SUPPORTS
904.10	ORIENTATION OF GROUND MOUNTED SIGNS
904.50	MOUNTING OF TYPE 'D', 'E' AND 'F' SIGNS ON 'U' CHANNEL POSTS
910.20	SCHOOL MARKED AND UNMARKED CROSSWALKS / SPEED REDUCTION REQUIREMENTS
910.50	SIGNING FOR SPEED REDUCTION ZONE
1264.01	OBJECT MARKERS - TYPES
1264.02	OBJECT MARKERS - INSTALLATION

PROJECT NOTES

1. DISPOSAL OF SIGN, A OR B (GROUND MOUNTED)
2. DISPOSAL OF SIGN, D, E OR F
3. DISPOSAL OF SUPPORT, U-CHANNEL
4. ERECT TYPE B SIGN ON EXISTING SUPPORTS
5. DISPOSAL OF SIGN SYSTEM, STEEL BEAM

GENERAL NOTES

- . SIGNS FURNISHED BY STATE
- . CONFIRM IN WRITING AT LEAST 4 MONTHS IN ADVANCE, THE ACTUAL DATE THE DEPARTMENT FURNISHED SIGNS WILL BE REQUIRED.
- . ALL TYPE 'D' SIGNS SHALL BE MOUNTED ON TWO U-CHANNEL POSTS UNLESS OTHERWISE INDICATED ON THE PLANS.
- . IF REMOVAL OR RELOCATION OF SIGNS ON PRIVATE STREET (NON-STATE MAINTAINED) IS REQUIRED DUE TO CONSTRUCTION, THE CONTRACTOR SHALL INFORM THE ENGINEER. THE WORK WILL BE COMPLETED BY OTHERS.
- . WHEN NOT STATIONED OR DIMENSIONED ON PLANS, ALL 'E' AND 'F' SIGNS SHALL BE FIELD LOCATED BY THE ENGINEER
- . ALL EXISTING SIGNS ON "U" CHANNEL POST WITHIN THE PROJECT LIMITS SHALL BE REMOVED AND DISPOSED OF UNLESS OTHERWISE NOTED ON PLANS.
- . THE BACKGROUND FOR TYPE E & F SIGNS SHALL BE TYPE C REFLECTIVE SHEETING.
- . DO NOT BEGIN FABRICATION FOR TYPES A & B SIGNS MOUNTED ON OVERHEAD STRUCTURES OR STEEL SUPPORTS UNTIL "S" DIMENSIONS HAVE BEEN FIELD VERIFIED.
- . SEE ROADWAY PLANS FOR GUARD/GUIDE RAIL DETAILS.

SUMMARY OF QUANTITIES

ITEM NO.	SEC.	DESCRIPTION	QUANTITY	UNITS
4048000000-E	902	REINFORCED CONCRETE SIGN FOUNDATIONS	2	CY
4054000000-E	902	PLAIN CONCRETE SIGN FOUNDATIONS	1	CY
4060000000-E	903	SUPPORTS, BREAKAWAY STEEL BEAM	890	LB
4066000000-E	903	SUPPORTS, SIMPLE STEEL BEAM	637	LB
4072000000-E	903	SUPPORTS, 3-LB STEEL U-CHANNEL	1,900	LF
4096000000-N	904	SIGN ERECTION, TYPE D	7	EA
4102000000-N	904	SIGN ERECTION, TYPE E	101	EA
4108000000-N	904	SIGN ERECTION, TYPE F	2	EA
4110000000-N	904	SIGN ERECTION, TYPE A (GROUND MOUNTED)	3	EA
4110000000-N	904	SIGN ERECTION, TYPE B (GROUND MOUNTED)	2	EA
4152000000-N	907	DISPOSAL OF SIGN SYSTEM, STEELBEAM	2	EA
4155000000-N	907	DISPOSAL OF SIGN SYSTEM, U-CHANNEL	54	EA
4192000000-N	907	DISPOSAL OF SUPPORT, U-CHANNEL	5	EA
4236000000-N	907	DISPOSAL OF SIGN, A & B (GROUND MOUNTED)	1	EA
4238000000-N	907	DISPOSAL OF SIGN, D, E OR F	5	EA

INDEX

<u>SHEET NO.</u>	<u>DESCRIPTION</u>
SIGN-1	TITLE SHEET
SIGN-2	SUPPORT INFORMATION
SIGN-3-3A	E AND F SHEETS
SIGN-4-4B	SIGN DESIGNS
SIGN-5-30	SIGNING PLAN SHEETS

PLAN PREPARED FOR: N.C.D.O.T. SIGNING AND DELINEATION UNIT AND DESIGN BUILD UNIT

K. L. JORDAN SIGNING & DELINEATION REGIONAL ENGINEER

D. H. BEARD SIGNING & DELINEATION PROJECT DESIGN ENGINEER

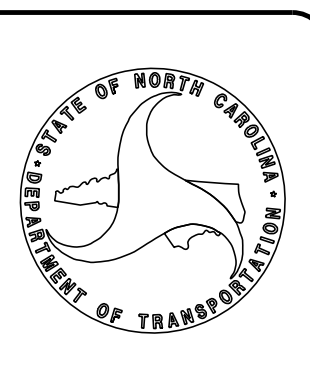

PLANS PREPARED BY :

RK&K
RUMMEL, KLEPPER & KAHL, LLP
900 RIDGEFIELD DRIVE SUITE 350
RALEIGH, NORTH CAROLINA 27609-3960
NC LICENSE NO. F-0112 (919) 878-9560

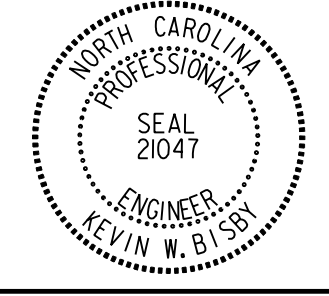
TIP NO.	SHEET NO.
U-2412A	SIGN-2
Approved by: <i>Kevin W. Bisby</i> <small>3CE3C9ABDF4681...</small> DATE: 3/18/2018	
SEAL 	
DOCUMENT NOT CONSIDERED FINAL UNLESS ALL SIGNATURES COMPLETED	

Version: 3.1 Posted: 6/2/2017

NUMBER	SIGN			ROADWAY STATION	NUMBER OF SUPPORTS	BEAM SECTION	SUPPORT TYPE BA or S	OMNI COUPLER	ATTACHMENT METHOD	MOUNTING METHOD	HORIZONTAL CLEARANCE* (ft.)	SUPPORT SPACING	LENGTH (ft)			LEFT SUPPORT (ft)			CENTER SUPPORT (ft)			RIGHT SUPPORT (ft)			SUPPORT WEIGHTS		FOOTINGS				FIELD VERIFIED SEE NOTE 2 (mm/dd/yy)	
	TYPE	SIZE (in.)											SNS HT	MTG HT	EMBED-MENT	S	L	LENGTH	S	L	LENGTH	S	L	LENGTH	B/A (lbs.)	SIMPLE (lbs.)	DIAMETER (ft.)	DEPTH (ft.)	REINFORCED (c.y.)	PLAIN (c.y.)		
		w	x																													h
102	A	180	x	126	-L- STA 13+50 (LT)	2	W6x12	S	N/A	N/A	N/A	8.00	8.79	10.50	7.00	4.0	-0.64	16.86	20.86	0.00	0.00	0.00	-0.68	16.82	20.82	0.00	500.16	1.5	4.5	0.59	0.00	_____
103	A	102	x	84	-L- STA 21+50 (LT)	2	S4x7.7	BA	N/A	N/A	N/A	30.00	4.98	7.00	7.00	3.5	2.51	16.51	20.01	0.00	0.00	0.00	1.72	15.72	19.22	342.10	0	1.0	4	0.00	0.23	_____
104	A	150	x	84	-L- STA 29+50 (LT)	2	W6x12	BA	N/A	N/A	N/A	30.00	7.33	7.00	7.00	3.5	2.81	16.81	20.31	0.00	0.00	0.00	1.34	15.34	18.84	547.80	0	1.5	4	0.52	0.00	_____
105	B	90	x	42	-L- STA 217+00 (LT)	2	S3x5.7	S	N/A	N/A	N/A	8.00	4.40	3.50	7.00	2.0	-0.49	10.01	12.01	0.00	0.00	0.00	-0.59	9.91	11.91	0.00	136.344	1.0	2.5	0.00	0.15	_____

TOTAL	TOTAL	TOTAL	TOTAL
889.90	636.50	1.11	0.38
USE:	890.00	637.00	2.00 1.00

NOTES:



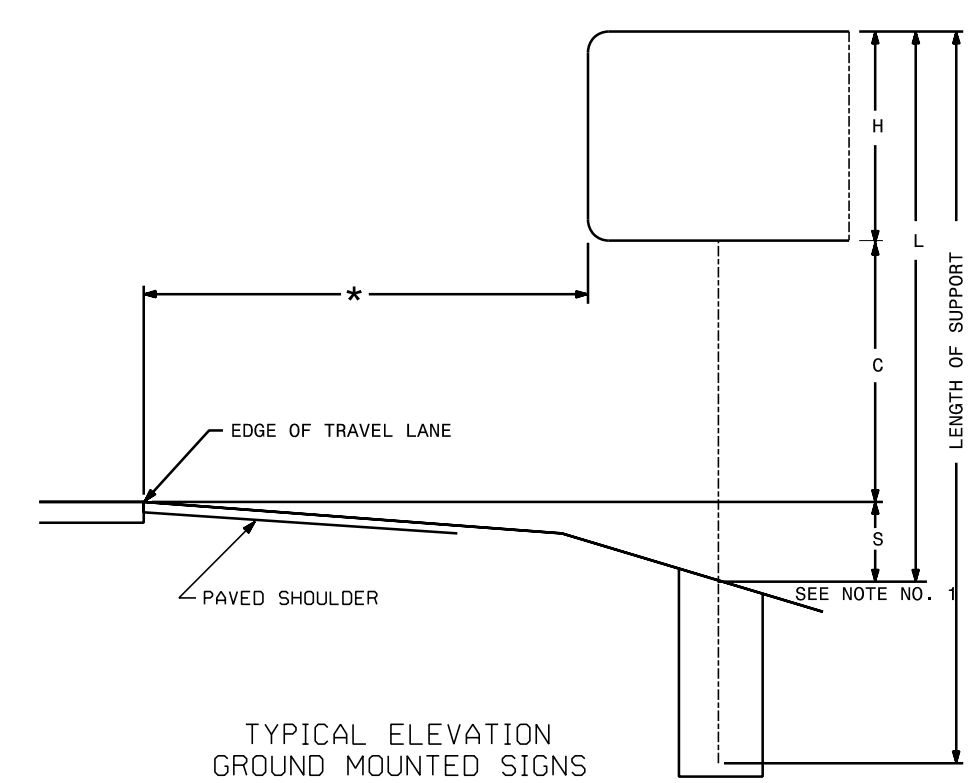









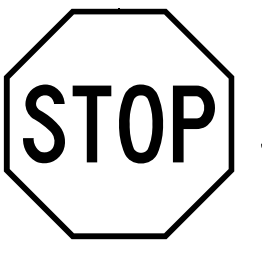
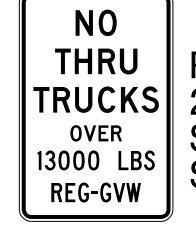





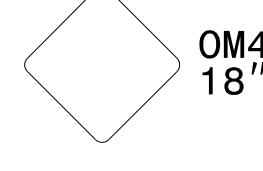

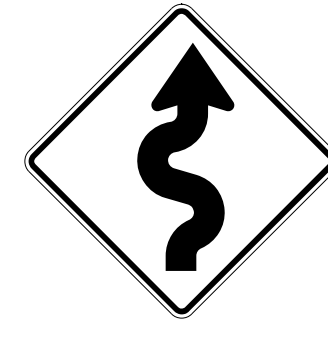
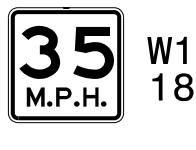
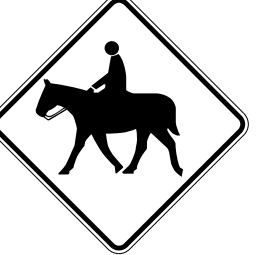

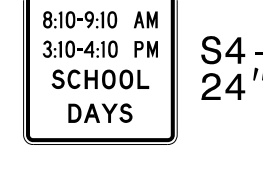
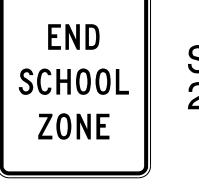

- DIMENSION "S" REPRESENTS AN INCREASE (+), OR A DECREASE (-) IN POLE LENGTH, RELATIVE TO THE ELEVATION OF THE EDGE OF PAVEMENT.
- FIELD VERIFICATIONS SHALL BE REQUIRED FOR ALL SUPPORTS, SEE (*) ARTICLE 903-3. FABRICATORS SHALL BE AISC CERTIFIED IN CATEGORY 1, SEE (*) ARTICLE 1072-1. (*) = N.C.D.O.T. STANDARD SPECIFICATIONS FOR ROADS AND STRUCTURES
- PLAN LOCATIONS FOR EXISTING UTILITIES ARE BASED ON THE BEST AVAILABLE INFORMATION AND, THEREFORE MAY NOT BE PRECISELY ACCURATE. THEREFORE, IT IS INCUMBENT UPON THE CONTRACTOR TO DETERMINE THE EXACT LOCATION OF UTILITIES BEFORE BEGINNING WORK IN A LOCATION.

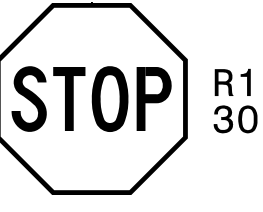
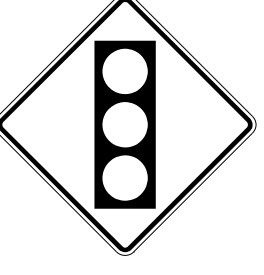

PLANS PREPARED BY :
RK&K
 RUMMEL, KLEPPER & KAHL, LLP
 900 RIDGEFIELD DRIVE SUITE 350
 RALEIGH, NORTH CAROLINA 27609-3960
 NC LICENSE NO. F-0112 (919) 878-9560

TYPE "A" and "B"
 GROUND MOUNTED SIGNS
 SUPPORT CHART



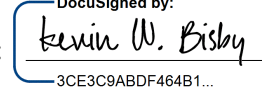
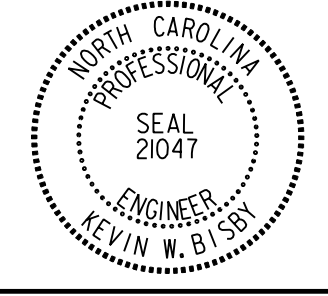

\$DATE\$
 \$FILEL\$
 EJJH/MJH

<p>401 QUANTITY REQ'D 18</p>  R4-7 24"X30" ONE "U" POST PER SIGN	<p>402 QUANTITY REQ'D 1</p>  R5-1 36"X36" ONE "U" POST PER SIGN	<p>403 QUANTITY REQ'D 7</p>  R1-1 36"X36" ONE "U" POST PER SIGN TWO "U" POSTS PER SIGN WHEN MOUNTED WITH SIGN 408	<p>404 QUANTITY REQ'D 3</p>  R12-3 (MOD) 24"X36" SEE SIGN-4B FOR SIGN DESIGN ONE "U" POST PER SIGN	<p>405 QUANTITY REQ'D 2</p>  R2-1 24"X30" ONE "U" POST PER SIGN	<p>406 QUANTITY REQ'D 4</p>  R3-7R 36"X36" ONE "U" POST PER SIGN	
<p>407 QUANTITY REQ'D 2</p>  R6-1R 54"X18" TWO "U" POSTS PER SIGN	<p>408 QUANTITY REQ'D 4</p>  R6-1R 36"X12" ONE "U" POST PER SIGN MOUNT BELOW SIGN 403 IN THREE INSTALLATIONS	<p>409 QUANTITY REQ'D 1</p>  R3-18 24"X24" MOUNT BACK TO BACK WITH SIGN 401 IN ONE INSTALLATION	<p>410 QUANTITY REQ'D 5</p>  W14-1 30"X30" ONE "U" POST PER SIGN	<p>411 QUANTITY REQ'D 9</p>  OM4-3 18"X18" ONE "U" POST PER SIGN	<p>412 QUANTITY REQ'D 5</p>  R2-1 24"X30" ONE "U" POST PER SIGN	<p>413 QUANTITY REQ'D 1</p>  W1-5R 36"X36" ONE "U" POST PER SIGN
<p>414 QUANTITY REQ'D 1</p>  W13-1P 18"X18" MOUNT BELOW SIGN 413 IN ONE INSTALLATION	<p>415 QUANTITY REQ'D 1</p>  W11-7 30"X30" ONE "U" POST PER SIGN	<p>416 QUANTITY REQ'D 1</p>  S4-3 24"X8" MOUNT ABOVE SIGN 417 IN ONE INSTALLATION	<p>417 QUANTITY REQ'D 1</p>  R2-1 24"X30" ONE "U" POST PER SIGN	<p>418 QUANTITY REQ'D 1</p>  S4-1A 24"X24" MOUNT BELOW SIGN 417 IN ONE INSTALLATION	<p>419 QUANTITY REQ'D 1</p>  S5-2 24"X30" ONE "U" POST PER SIGN	<p>420 QUANTITY REQ'D 4</p>  R2-1 24"X30" ONE "U" POST PER SIGN
<p>421 QUANTITY REQ'D 1</p>  S1-1 36"X36" ONE "U" POST PER SIGN	<p>422 QUANTITY REQ'D 1</p>  W16-9P 24"X12" MOUNT BELOW SIGN 421 IN ONE INSTALLATION	<p>423 QUANTITY REQ'D 4</p>  R1-1 30"X30" ONE "U" POST PER SIGN	<p>424 QUANTITY REQ'D 1</p>  W3-3 30"X30" ONE "U" POST PER SIGN	<p>425 QUANTITY REQ'D 1</p>  R3-9b 24"X36" ONE "U" POST PER SIGN	<p>426 QUANTITY REQ'D 1</p>  W1-2AL 30"X30" ONE "U" POST PER SIGN	<p>427 QUANTITY REQ'D 1</p>  S4-5 36"X36" ONE "U" POST PER SIGN
<p>428 QUANTITY REQ'D 4</p>  R2-1 36"X48" TWO "U" POSTS PER SIGN	<p>429 QUANTITY REQ'D 6</p>  R2-1 36"X48" TWO "U" POSTS PER SIGN	<p>430 QUANTITY REQ'D 4</p>  W3-5 48"X48" TWO "U" POSTS PER SIGN	<p>431 QUANTITY REQ'D 1</p>  W3-5 36"X36" ONE "U" POST PER SIGN	<p>PLANS PREPARED BY : RK&K RUMMEL, KLEPPER & KAHL, LLP 900 RIDGEFIELD DRIVE SUITE 350 RALEIGH, NORTH CAROLINA 27609-3960 NC LICENSE NO. F-0112 (919) 878-9560</p>		

TIP NO. U-2412A	SHEET NO. SIGN-3
DocuSigned by: APPROVED:  <small>3CE3C8ABDF44B1</small>	
DATE: 3/18/2018	
SEAL 	
DOCUMENT NOT CONSIDERED FINAL UNLESS ALL SIGNATURES COMPLETED	

DATE: \$
FILEL: \$
EJH/ZMLH

TYPE "E" SIGNS

	<p>(432) QUANTITY REQ'D 2</p> <div style="text-align: center;">  <p>R3-7L 36"X36"</p> </div> <p>ONE "U" POST PER SIGN</p>	<p>(433) QUANTITY REQ'D 1</p> <div style="text-align: center;">  <p>R5-1 36"X24"</p> </div> <p>ONE "U" POST PER SIGN</p>	<p>(434) QUANTITY REQ'D 2</p> <div style="text-align: center;">  <p>R1-2 36"X36"</p> </div> <p>ONE "U" POST PER SIGN</p>	<p>(501)</p> <div style="display: flex; justify-content: space-around;"> <div style="text-align: center;"> <p>M3-4 24"X12"</p> <p>M1-1 24"X24"</p> <p>M6-3 21"X15"</p> </div> <div style="text-align: center;"> <p>WEST INTERSTATE 74</p> <p>↑</p> </div> <div style="text-align: center;"> <p>EAST INTERSTATE 74</p> <p>→</p> </div> <div style="text-align: center;"> <p>M3-2 24"X12"</p> <p>M1-1 24"X24"</p> <p>M6-1 21"X15"</p> </div> </div> <p>TWO "U" POSTS PER SIGN</p>	<p>(502)</p> <div style="text-align: center;">  <p>M2-1 21"X15"</p> <p>M1-1 24"X24"</p> </div> <p>ONE "U" POST PER SIGN</p>
--	--	---	---	---	--

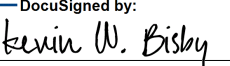
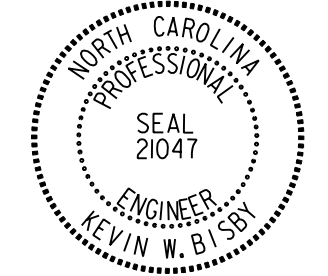
TIP NO. U-2412A	SHEET NO. SIGN-3A
DocuSigned by: APPROVED:  <small>3CE3CMBDF46481..</small>	
DATE: 3/18/2018	
SEAL 	
DOCUMENT NOT CONSIDERED FINAL UNLESS ALL SIGNATURES COMPLETED	

--	--	--	--	--	--	--	--	--	--

PLANS PREPARED BY :

RK&K

RUMMEL, KLEPPER & KAHL, LLP
 900 RIDGEFIELD DRIVE SUITE 350
 RALEIGH, NORTH CAROLINA 27609-3960
 NC LICENSE NO. F-0112 (919) 878-9560

TYPE "E" and "F" SIGNS

\$DATE\$
 \$FILEL\$
 EJJH/MJH

APPROVED: *Kevin W. Bisby*
30E3C8ASDF4681...
 DATE: 3/18/2018

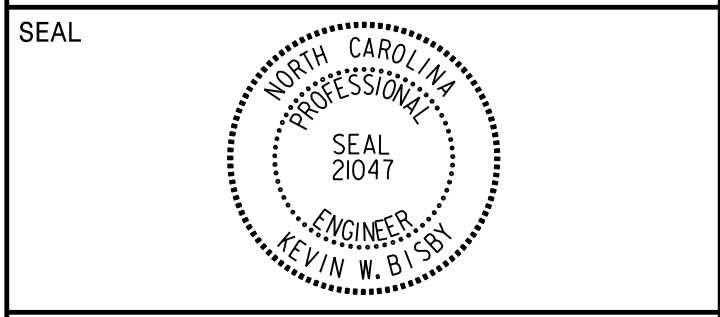

DOCUMENT NOT CONSIDERED FINAL
 UNLESS ALL SIGNATURES COMPLETED

SIGN NUMBER: 101 TYPE: B QUANTITY: 1 SIGN WIDTH: 9'-0" HEIGHT: 3'-0" TOTAL AREA: 27.0 Sq.Ft. BORDER TYPE: FLUSH RECESS: 0" WIDTH: 1" RADII: 3" NO. Z BARS: 2 LENGTH: 100.0	BACKG COLOR: Green COPY COLOR: White <table border="1"> <thead> <tr> <th>SYMBOL</th> <th>X</th> <th>Y</th> <th>WID</th> <th>HT</th> </tr> </thead> <tbody> <tr> <td>AR_Type D</td> <td>8.5</td> <td>21</td> <td>8</td> <td>12</td> </tr> <tr> <td>AR_Type D</td> <td>74.2</td> <td>5</td> <td>8</td> <td>12</td> </tr> </tbody> </table> MAT'L: 0.125" (3.2 mm) ALUMINUM	SYMBOL	X	Y	WID	HT	AR_Type D	8.5	21	8	12	AR_Type D	74.2	5	8	12	DESIGN BY: K. Bisby CHECKED BY: D. Sears Feb 22, 2018 PROJECT ID: U-2412A LOCATION: Offsite DIV: 7
SYMBOL	X	Y	WID	HT													
AR_Type D	8.5	21	8	12													
AR_Type D	74.2	5	8	12													

Spacing Factor is 1 unless specified otherwise

LETTER POSITIONS

Letter spacings are to start of next letter

Series/Size	Text Length
D 2000	75
D 2000	44.4

FILENAME: U2412A_SGN_DESIGN NORTH CAROLINA D.O.T. SIGN DETAIL

SIGN NUMBER: 102 TYPE: A QUANTITY: 1 SIGN WIDTH: 15'-0" HEIGHT: 6'-6" TOTAL AREA: 157.5 Sq.Ft. BORDER TYPE: FLUSH RECESS: 0" WIDTH: 2" RADII: 12" NO. Z BARS: 3 LENGTH: 172.0	BACKG COLOR: Green COPY COLOR: White <table border="1"> <thead> <tr> <th>SYMBOL</th> <th>X</th> <th>Y</th> <th>WID</th> <th>HT</th> </tr> </thead> <tbody> <tr> <td>M1_1</td> <td>68.2</td> <td>91.3</td> <td>24</td> <td>24</td> </tr> <tr> <td>AR_Type A</td> <td>40.5</td> <td>85.5</td> <td>10.7</td> <td>16.8</td> </tr> <tr> <td>M1_1</td> <td>43</td> <td>29.5</td> <td>24</td> <td>24</td> </tr> <tr> <td>AR_Type A</td> <td>151.7</td> <td>26.8</td> <td>10.7</td> <td>16.8</td> </tr> </tbody> </table> MAT'L: 0.125" (3.2 mm) ALUMINUM	SYMBOL	X	Y	WID	HT	M1_1	68.2	91.3	24	24	AR_Type A	40.5	85.5	10.7	16.8	M1_1	43	29.5	24	24	AR_Type A	151.7	26.8	10.7	16.8	DESIGN BY: K. Bisby CHECKED BY: D. Sears Feb 22, 2018 PROJECT ID: U-2412A LOCATION: -L- STA 13+50 DIV: 7
SYMBOL	X	Y	WID	HT																							
M1_1	68.2	91.3	24	24																							
AR_Type A	40.5	85.5	10.7	16.8																							
M1_1	43	29.5	24	24																							
AR_Type A	151.7	26.8	10.7	16.8																							

Spacing Factor is 1 unless specified otherwise

LETTER POSITIONS

Letter spacings are to start of next letter

Series/Size	Text Length
E 2000	30.9
EM 2000	77.6
E 2000	32.5
EM 2000	129.5

FILENAME: U2412A_SGN_DESIGN NORTH CAROLINA D.O.T. SIGN DETAIL

SIGN NUMBER: 103 TYPE: A QUANTITY: 1 SIGN WIDTH: 8'-6" HEIGHT: 7'-0" TOTAL AREA: 59.5 Sq.Ft. BORDER TYPE: FLUSH RECESS: 0" WIDTH: 2" RADII: 9" NO. Z BARS: 2 LENGTH: 94.0	BACKG COLOR: Green COPY COLOR: White <table border="1"> <thead> <tr> <th>SYMBOL</th> <th>X</th> <th>Y</th> <th>WID</th> <th>HT</th> </tr> </thead> <tbody> <tr> <td>M1_1</td> <td>18.5</td> <td>47</td> <td>24</td> <td>24</td> </tr> </tbody> </table> MAT'L: 0.125" (3.2 mm) ALUMINUM	SYMBOL	X	Y	WID	HT	M1_1	18.5	47	24	24	DESIGN BY: K. Bisby CHECKED BY: D. Sears Feb 22, 2018 PROJECT ID: U-2412A LOCATION: -L- STA 21+50 DIV: 7
SYMBOL	X	Y	WID	HT								
M1_1	18.5	47	24	24								

Spacing Factor is 1 unless specified otherwise

LETTER POSITIONS

Letter spacings are to start of next letter

Series/Size	Text Length
E 2000	30.9
EM 2000	77.6
E 2000	65.2

FILENAME: U2412A_SGN_DESIGN NORTH CAROLINA D.O.T. SIGN DETAIL

SIGN NUMBER: 104 TYPE: A QUANTITY: 1 SIGN WIDTH: 12'-6" HEIGHT: 7'-0" TOTAL AREA: 87.5 Sq.Ft. BORDER TYPE: FLUSH RECESS: 0" WIDTH: 2" RADII: 9" NO. Z BARS: 2 LENGTH: 142.0	BACKG COLOR: Green COPY COLOR: White <table border="1"> <thead> <tr> <th>SYMBOL</th> <th>X</th> <th>Y</th> <th>WID</th> <th>HT</th> </tr> </thead> <tbody> <tr> <td>M1_1</td> <td>41.7</td> <td>46.9</td> <td>24</td> <td>24</td> </tr> </tbody> </table> MAT'L: 0.125" (3.2 mm) ALUMINUM	SYMBOL	X	Y	WID	HT	M1_1	41.7	46.9	24	24	DESIGN BY: K. Bisby CHECKED BY: B. Holden Feb 22, 2018 PROJECT ID: U-2412A LOCATION: -L- STA 29+50 DIV: 7
SYMBOL	X	Y	WID	HT								
M1_1	41.7	46.9	24	24								

Spacing Factor is 1 unless specified otherwise

LETTER POSITIONS

Letter spacings are to start of next letter

Series/Size	Text Length
E 2000	32.5
EM 2000	129.5
E 2000	88.6

FILENAME: U2412A_SGN_DESIGN NORTH CAROLINA D.O.T. SIGN DETAIL

PLANS PREPARED BY :
RK&K
 RUMMEL, KLEPPER & KAHL, LLP
 900 RIDGEFIELD DRIVE SUITE 350
 RALEIGH, NORTH CAROLINA 27609-3960
 NC LICENSE NO. F-0112 (919) 878-9560

SIGN DESIGNS

\$DATE:\$
 \$FILEL:\$
 E:JH/ZMLH

APPROVED: *Kevin W. Bisby*
 DATE: 3/18/2018

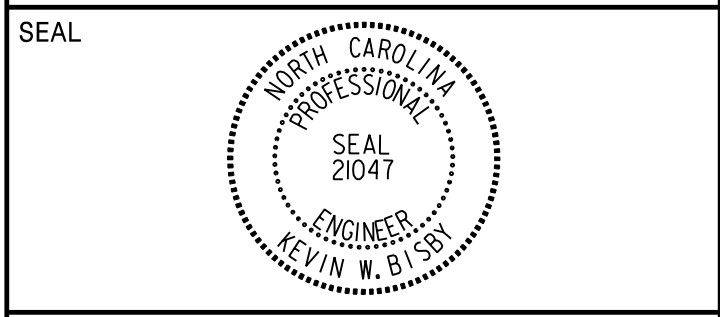

DOCUMENT NOT CONSIDERED FINAL
 UNLESS ALL SIGNATURES COMPLETED

SIGN NUMBER: 105 **BACKG COLOR: Green** **DESIGN BY: K. Bisby** **CHECKED BY: D. Sears** **Feb 22, 2018**
TYPE: B **COPY COLOR: White** **PROJECT ID: U-2412A** **LOCATION: -L- STA 217+00** **DIV: 7**

QUANTITY: 1
 SIGN WIDTH: 7'-6"
 HEIGHT: 3'-6"
 TOTAL AREA: 26.3 Sq.Ft.

SYMBOL	X	Y	WID	HT
AR_Type D	10.6	25.2	8	12
AR_Type D	70.6	6.8	8	12

MAT'L: 0.125" (3.2 mm) ALUMINUM

USE NOTES: 1, 2

- Legend and border(except those that are colored black) shall be direct applied Grade C sheeting.
- Background shall be Grade C reflective sheeting.
- Shields: A, B, and C type arrows shall be on 0.032" (0.8mm) aluminum and demountable.

Spacing Factor is 1 unless specified otherwise

LETTER POSITIONS

Letter spacings are to start of next letter

Series/Size	Text Length
D 2000	52.8
D 2000	55.1

FILENAME: U2412A_SGN_DESIGN NORTH CAROLINA D.O.T. SIGN DETAIL

SIGN NUMBER: 301 **BACKG COLOR: Green** **DESIGN BY: K. Bisby** **CHECKED BY: D. Sears** **Feb 22, 2018**
TYPE: D **COPY COLOR: White** **PROJECT ID: U-2412A** **LOCATION: Offsite** **DIV: 7**

QUANTITY: 1
 SIGN WIDTH: 7'-0"
 HEIGHT: 2'-0"
 TOTAL AREA: 14.0 Sq.Ft.

SYMBOL	X	Y	WID	HT
AR_Type D	9.8	8	8	12

MAT'L: 0.125" (3.2 mm) ALUMINUM

USE NOTES: 1, 2

- Legend and border(except those that are colored black) shall be direct applied Grade C sheeting.
- Background shall be Grade C reflective sheeting.
- Shields: A, B, and C type arrows shall be on 0.032" (0.8mm) aluminum and demountable.

Spacing Factor is 1 unless specified otherwise

LETTER POSITIONS

Letter spacings are to start of next letter

Series/Size	Text Length
D 2000	44.4

FILENAME: U2412A_SGN_DESIGN NORTH CAROLINA D.O.T. SIGN DETAIL

SIGN NUMBER: 302 **BACKG COLOR: Green** **DESIGN BY: K. Bisby** **CHECKED BY: D. Sears** **Feb 10, 2018**
TYPE: D **COPY COLOR: White** **PROJECT ID: U-2412A** **LOCATION: -L- STA 20+00** **DIV: 7**

QUANTITY: 1
 SIGN WIDTH: 7'-6"
 HEIGHT: 2'-0"
 TOTAL AREA: 15.0 Sq.Ft.

SYMBOL	X	Y	WID	HT
AR_Type D	7.4	8	8	12

MAT'L: 0.125" (3.2 mm) ALUMINUM

USE NOTES: 1, 2

- Legend and border(except those that are colored black) shall be direct applied Grade C sheeting.
- Background shall be Grade C reflective sheeting.
- Shields: A, B, and C type arrows shall be on 0.032" (0.8mm) aluminum and demountable.

Spacing Factor is 1 unless specified otherwise

LETTER POSITIONS

Letter spacings are to start of next letter

Series/Size	Text Length
D 2000	55.1

FILENAME: U2412A_SGN_DESIGN NORTH CAROLINA D.O.T. SIGN DETAIL

SIGN NUMBER: 303, 304 **BACKG COLOR: Green** **DESIGN BY: K. Bisby** **CHECKED BY: D. Sears** **Feb 22, 2018**
TYPE: D **COPY COLOR: White** **PROJECT ID: U-2412A** **LOCATION: Varies** **DIV: 7**

QUANTITY: 2
 SIGN WIDTH: 6'-0"
 HEIGHT: 2'-0"
 TOTAL AREA: 12.0 Sq.Ft.

SYMBOL	X	Y	WID	HT
AR_Type D	8.5	8	8	12

MAT'L: 0.125" (3.2 mm) ALUMINUM

USE NOTES: 1, 2

- Legend and border(except those that are colored black) shall be direct applied Grade C sheeting.
- Background shall be Grade C reflective sheeting.
- Shields: A, B, and C type arrows shall be on 0.032" (0.8mm) aluminum and demountable.

Spacing Factor is 1 unless specified otherwise

LETTER POSITIONS

Letter spacings are to start of next letter

Series/Size	Text Length
D 2000	55

FILENAME: U2412A_SGN_DESIGN NORTH CAROLINA D.O.T. SIGN DETAIL

PLANS PREPARED BY:
RK&K
 RUMMEL, KLEPPER & KAHL, LLP
 900 RIDGEFIELD DRIVE SUITE 350
 RALEIGH, NORTH CAROLINA 27609-3960
 NC LICENSE NO. F-0112 (919) 878-9560

SIGN DESIGNS

\$DATE\$
 \$FILEL\$
 EJJH/MCH

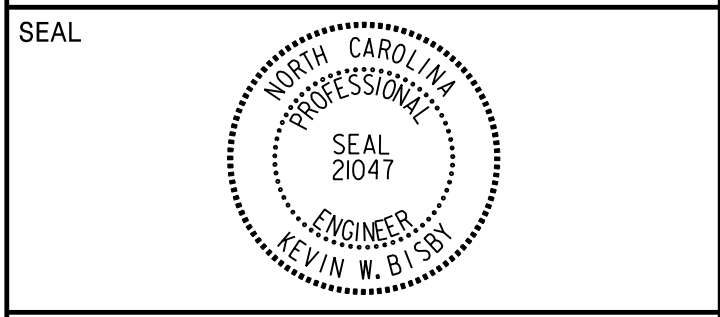

DOCUMENT NOT CONSIDERED FINAL
UNLESS ALL SIGNATURES COMPLETED

SIGN NUMBER: 305
TYPE: D
QUANTITY: 1
SIGN WIDTH: 7'-6"
HEIGHT: 2'-0"
TOTAL AREA: 15.0 Sq.-Ft.
BORDER TYPE: FLUSH
RECESS: 0"
WIDTH: 1"
RADIUS: 3"
NO. Z BARS: LENGTH:

BACKG COLOR: Green
COPY COLOR: White

SYMBOL	X	Y	WID	HT
AR_Type D	10.4	6	8	12

MAT'L: 0.125" (3.2 mm) ALUMINUM

DESIGN BY: K. Bisby
PROJECT ID: U-2412A
CHECKED BY: D. Sears
LOCATION: -L- STA 205+00
Feb 22, 2018
DIV: 7

USE NOTES: 1, 2

- Legend and border(except those that are colored black) shall be direct applied Grade C sheeting.
- Background shall be Grade C reflective sheeting.
- Shields: A, B, and C type arrows shall be on 0.032" (0.8mm) aluminum and demountable.

Spacing Factor is 1 unless specified otherwise

LETTER POSITIONS

Letter spacings are to start of next letter

	G	r	e	e	n	s	b	o	r	o		Series/Size Text Length	
	26.4	7	3.7	5.5	5.8	5.8	4.8	5.8	6.2	3.7	4.9	10.4	D 2000 53.1

FILENAME: U2412A_SGN_DESIGN
NORTH CAROLINA D.O.T. SIGN DETAIL

SIGN NUMBER: 306
TYPE: D
QUANTITY: 1
SIGN WIDTH: 6'-0"
HEIGHT: 3'-6"
TOTAL AREA: 21.0 Sq.-Ft.
BORDER TYPE: FLUSH
RECESS: 0"
WIDTH: 0.75"
RADIUS: 3"
NO. Z BARS: LENGTH:

BACKG COLOR: Green
COPY COLOR: White

SYMBOL	X	Y	WID	HT
AR_Type D	9.3	30.3	6	9
AR_Type D	8.7	18	6	9
AR_Type D	54.4	4.3	6	9

MAT'L: 0.125" (3.2 mm) ALUMINUM

DESIGN BY: K. Bisby
PROJECT ID: U-2412A
CHECKED BY: D. Sears
LOCATION: Offsite
Feb 22, 2018
DIV: 7

USE NOTES: 1, 2

- Legend and border(except those that are colored black) shall be direct applied Grade C sheeting.
- Background shall be Grade C reflective sheeting.
- Shields: A, B, and C type arrows shall be on 0.032" (0.8mm) aluminum and demountable.

Spacing Factor is 1 unless specified otherwise

LETTER POSITIONS

Letter spacings are to start of next letter

	J	a	m	e	s	t	o	w	n		Series/Size Text Length		
	21.3	4.9	4.6	6.8	4	3.1	2.8	4.1	7.5	3.5	9.3	D 2000 41.3	
	23.7	5.4	1.9	4.8	3.5	6	4.6	4.6	2.2	4.1	2.4	8.7	D 2000 39.6
	8.6	5.3	2.8	4.1	4.4	4.3	3.6	4.3	4.6	2.8	3.7	23.6	D 2000 39.8

FILENAME: U2412A_SGN_DESIGN
NORTH CAROLINA D.O.T. SIGN DETAIL

SIGN NUMBER: 307
TYPE: D
QUANTITY: 1
SIGN WIDTH: 6'-0"
HEIGHT: 2'-6"
TOTAL AREA: 15.0 Sq.-Ft.
BORDER TYPE: FLUSH
RECESS: 0"
WIDTH: 1"
RADIUS: 3"
NO. Z BARS: LENGTH:

BACKG COLOR: Green
COPY COLOR: White

SYMBOL	X	Y	WID	HT
AR_Type D	8.6	19.2	6	9
AR_Type D	54.4	4.8	6	9

MAT'L: 0.125" (3.2 mm) ALUMINUM

DESIGN BY: K. Bisby
PROJECT ID: U-2412A
CHECKED BY: D. Sears
LOCATION: Offsite
Feb 22, 2018
DIV: 7

USE NOTES: 1, 2

- Legend and border(except those that are colored black) shall be direct applied Grade C sheeting.
- Background shall be Grade C reflective sheeting.
- Shields: A, B, and C type arrows shall be on 0.032" (0.8mm) aluminum and demountable.

Spacing Factor is 1 unless specified otherwise

LETTER POSITIONS

Letter spacings are to start of next letter

	G	r	e	e	n	s	b	o	r	o		Series/Size Text Length	
	23.6	5.3	2.8	4.1	4.4	4.3	3.6	4.3	4.6	2.8	3.7	8.6	D 2000 39.6
	8.8	5.4	1.9	4.8	3.5	6	4.6	4.6	2.2	4.1	2.4	23.6	D 2000 39.6

FILENAME: U2412A_SGN_DESIGN
NORTH CAROLINA D.O.T. SIGN DETAIL

SIGN NUMBER: 404
TYPE: E
QUANTITY: 2
SIGN WIDTH: 2'-0"
HEIGHT: 3'-0"
TOTAL AREA: 6.0 Sq.-Ft.
BORDER TYPE: RECESSED
RECESS: 0.38"
WIDTH: 0.63"
RADIUS: 1.5"
NO. Z BARS: LENGTH:

BACKG COLOR: White
COPY COLOR: Black

SYMBOL	X	Y	WID	HT
--------	---	---	-----	----

MAT'L: 0.125" (3.2 mm) ALUMINUM

DESIGN BY: K. Bisby
PROJECT ID: U-2412A
CHECKED BY: D. Sears
LOCATION: Varies
Feb 12, 2018
DIV: 7

USE NOTES: 1, 2

- Legend and border(except those that are colored black) shall be direct applied Grade C sheeting.
- Background shall be Grade C reflective sheeting.
- Shields: A, B, and C type arrows shall be on 0.032" (0.8mm) aluminum and demountable.

Spacing Factor is 1 unless specified otherwise

LETTER POSITIONS

Letter spacings are to start of next letter

	N	O										Series/Size Text Length
	8.8	3.6	2.8	8.8								D 2000 6.4
	5.6	3.1	3.7	3.4	2.7	5.6						D 2000 12.9
	2.2	3.1	3.4	3.6	3.6	3.2	2.7	2.2				D 2000 19.6
	8	2.1	2.3	2	1.7	8						D 2000 8.1
	1	3	0	0	0		L	B	S			C 2000 18.3
	2.8	1.1	2.1	2.3	2.3	1.8	3	2	2	1.7	2.8	C 2000 14
	5	2.2	2	2	1.4	2	2	2.3	5			C 2000 14

FILENAME: U2412A_SGN_DESIGN
NORTH CAROLINA D.O.T. SIGN DETAIL

PLANS PREPARED BY :
RK&K
RUMMEL, KLEPPER & KAHL, LLP
900 RIDGEFIELD DRIVE SUITE 350
RALEIGH, NORTH CAROLINA 27609-3960
NC LICENSE NO. F-0112 (919) 878-9560

SIGN DESIGNS

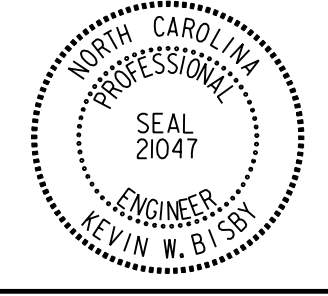
TIP NO. U-2412A	SHEET NO. SIGN-5
APPROVED: <i>Kevin W. Bishop</i> 3/23/2018	
DATE: 3/18/2018	
SEAL 	
DOCUMENT NOT CONSIDERED FINAL UNLESS ALL SIGNATURES COMPLETED	

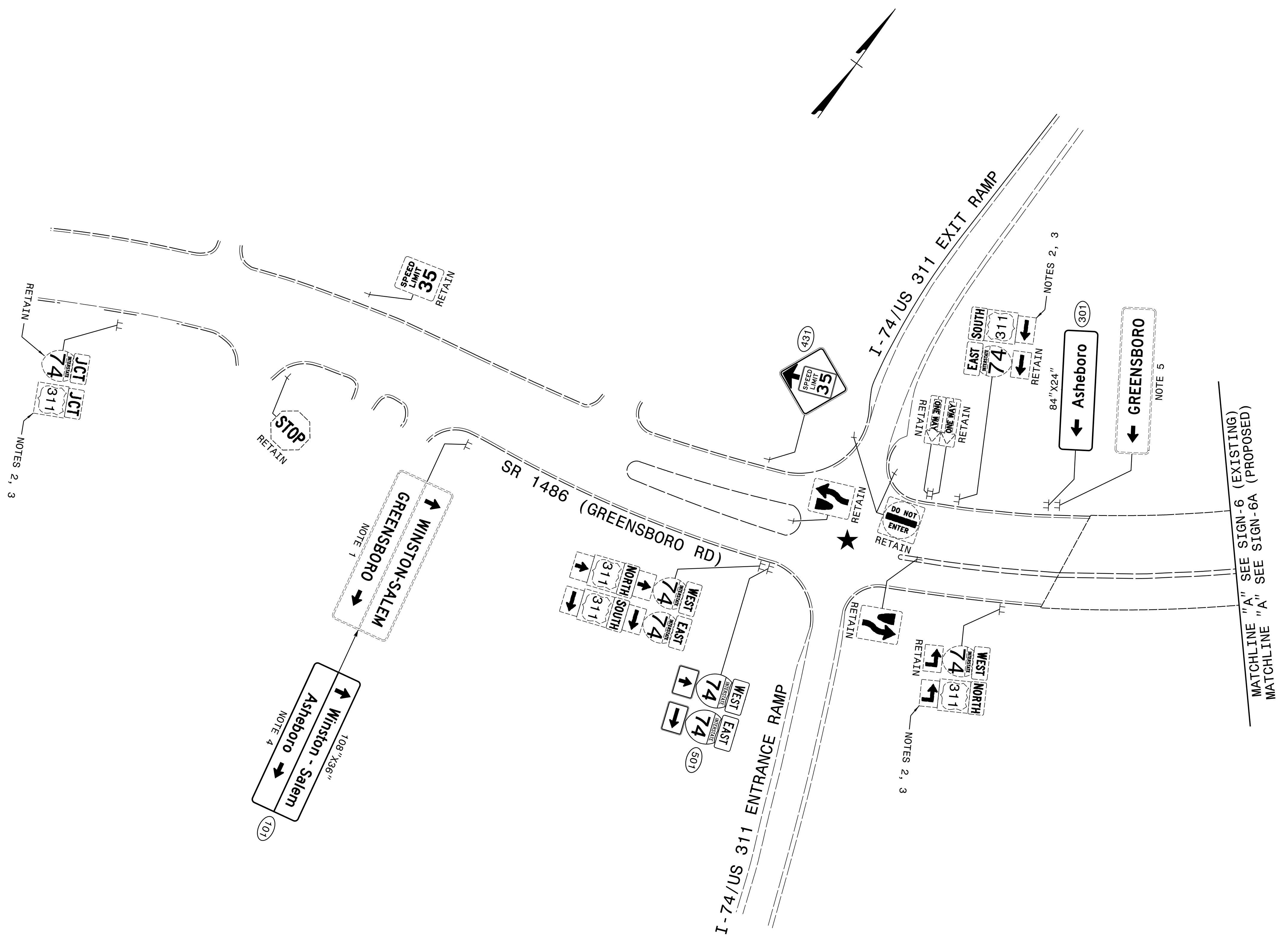

\$DATE\$
\$FILEL\$
EJH/ZMLH

★ TRAFFIC SIGNAL

PLANS PREPARED BY :

RK&K

RUMMEL, KLEPPER & KAHL, LLP
900 RIDGEFIELD DRIVE SUITE 350
RALEIGH, NORTH CAROLINA 27609-3960
NC LICENSE NO. F-0112 (919) 878-9560

EXISTING and PROPOSED SIGNS

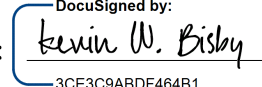
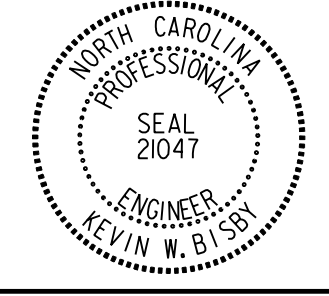
TIP NO.	SHEET NO.
U-2412A	SIGN-6
APPROVED:  -3CE3C8ABDF46B1-	
DATE: 3/18/2018	
SEAL	
	
DOCUMENT NOT CONSIDERED FINAL UNLESS ALL SIGNATURES COMPLETED	

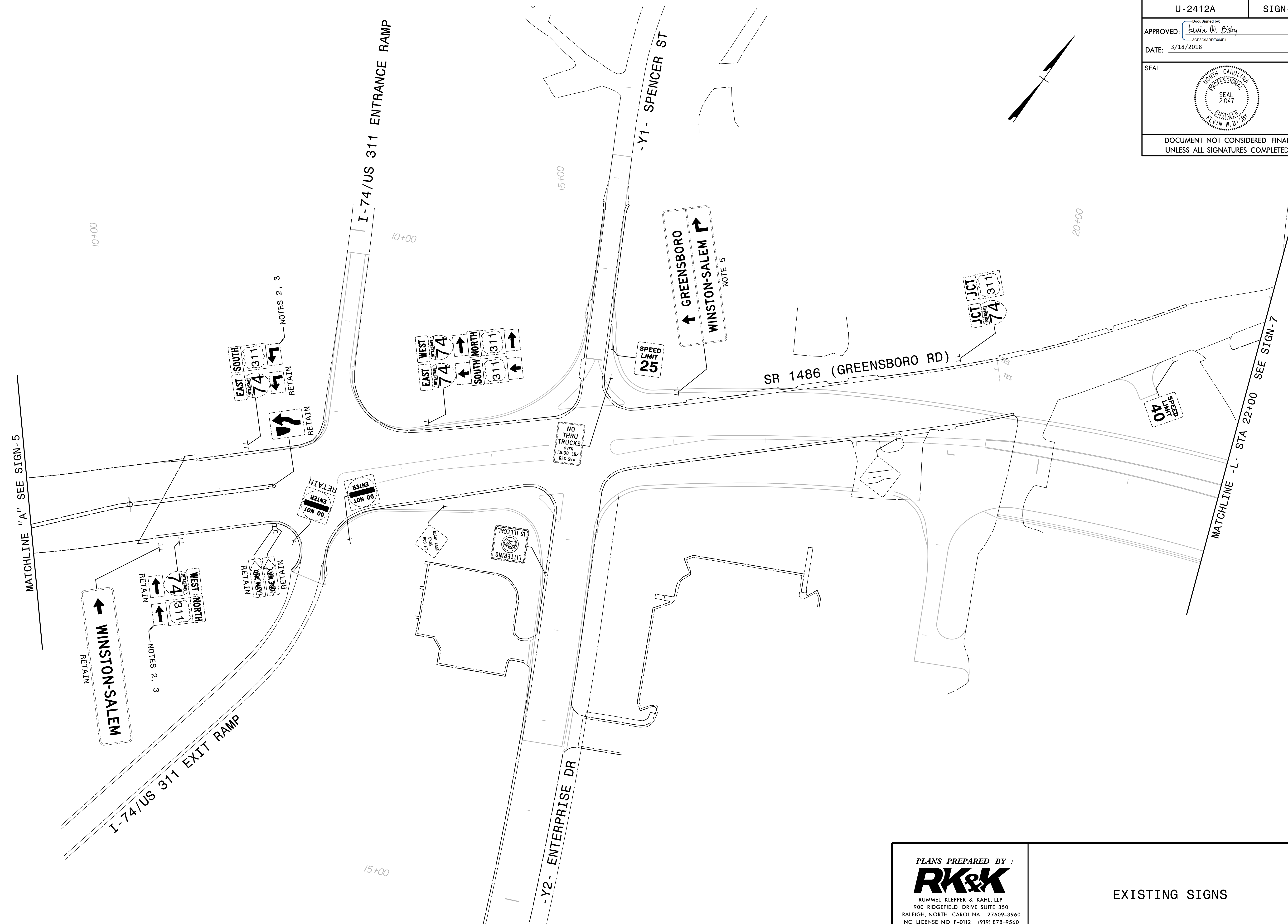

\$DATE:\$
\$FILEL:\$
EJH/ZMLH

PLANS PREPARED BY :

RK&K

RUMMEL, KLEPPER & KAHL, LLP
 900 RIDGEFIELD DRIVE SUITE 350
 RALEIGH, NORTH CAROLINA 27609-3960
 NC LICENSE NO. F-0112 (919) 878-9560

EXISTING SIGNS

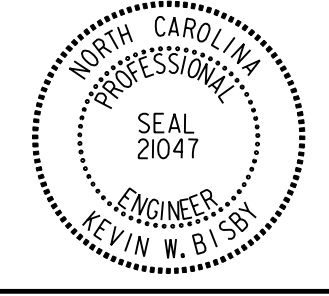
TIP NO.	SHEET NO.
U-2412A	SIGN-6A
APPROVED: <i>Kevin W. Bishop</i>	
DATE: 3/18/2018	
SEAL	
	
DOCUMENT NOT CONSIDERED FINAL UNLESS ALL SIGNATURES COMPLETED	

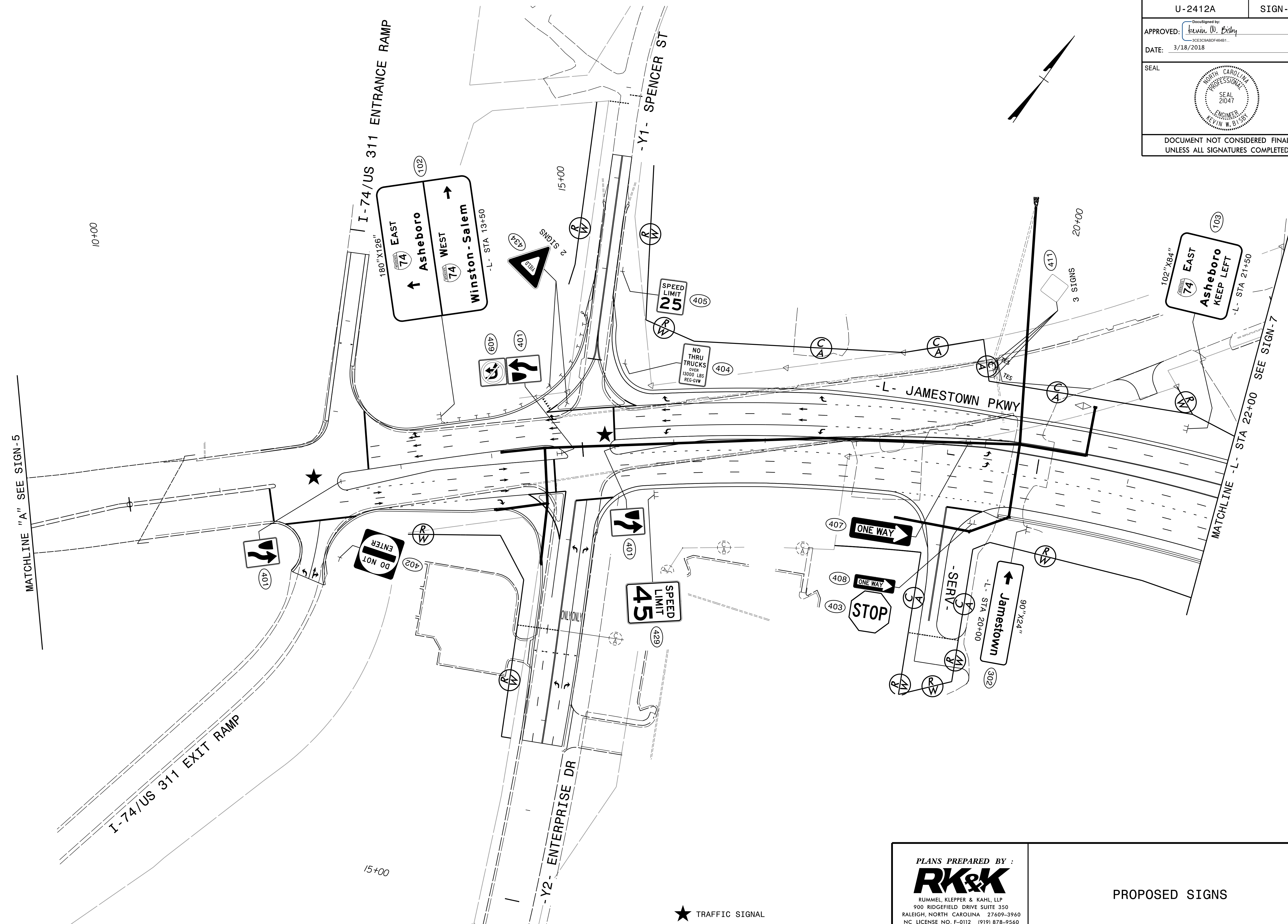

\$DATE\$
\$FILEL\$
EJH/ZMLH

PLANS PREPARED BY :

RK&K

RUMMEL, KLEPPER & KAHL, LLP
 900 RIDGEFIELD DRIVE SUITE 350
 RALEIGH, NORTH CAROLINA 27609-3960
 NC LICENSE NO. F-0112 (919) 878-9560

PROPOSED SIGNS

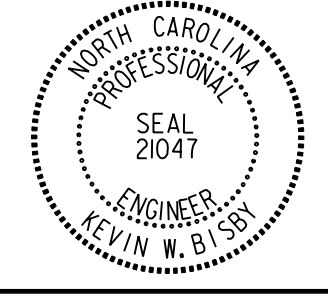
TIP NO.	SHEET NO.
U-2412A	SIGN-7
Approved by: <i>Kevin W. Bishop</i> <small>REGISTERED PROFESSIONAL ENGINEER</small> DATE: 3/18/2018	
SEAL 	
DOCUMENT NOT CONSIDERED FINAL UNLESS ALL SIGNATURES COMPLETED	

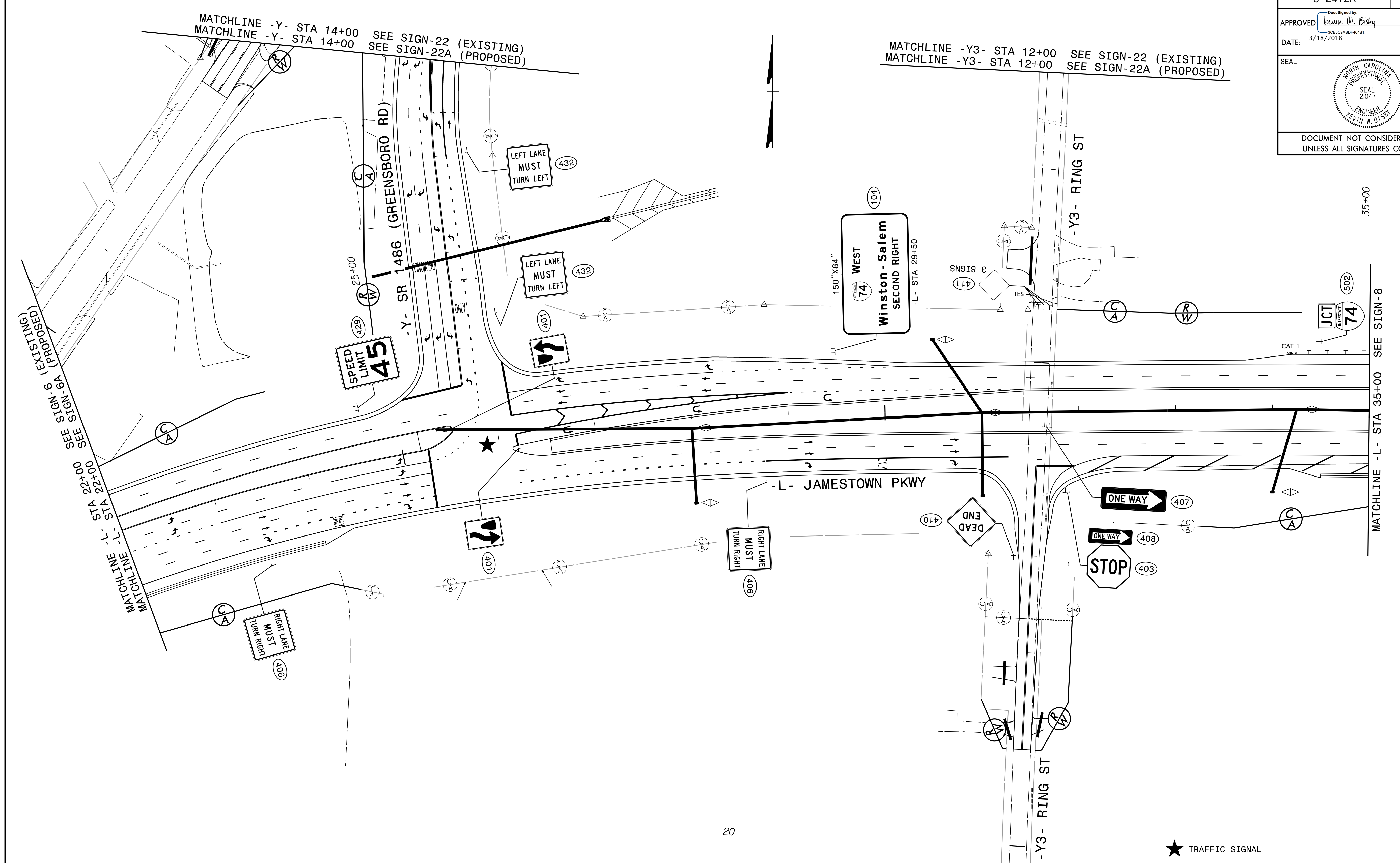

20

★ TRAFFIC SIGNAL

PLANS PREPARED BY :



RUMMEL, KLEPPER & KAHL, LLP
 900 RIDGEFIELD DRIVE SUITE 350
 RALEIGH, NORTH CAROLINA 27609-3960
 NC LICENSE NO. F-0112 (919) 878-9560

PROPOSED SIGNS

\$DATE\$
\$FILEL\$
EJH/ZMLH

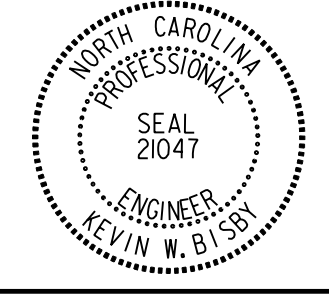
TIP NO. U-2412A	SHEET NO. SIGN-8
APPROVED: <i>Kevin W. Bisby</i> <small>3CE3C9ARD0F46481</small>	
DATE: 3/18/2018	
SEAL 	
DOCUMENT NOT CONSIDERED FINAL UNLESS ALL SIGNATURES COMPLETED	

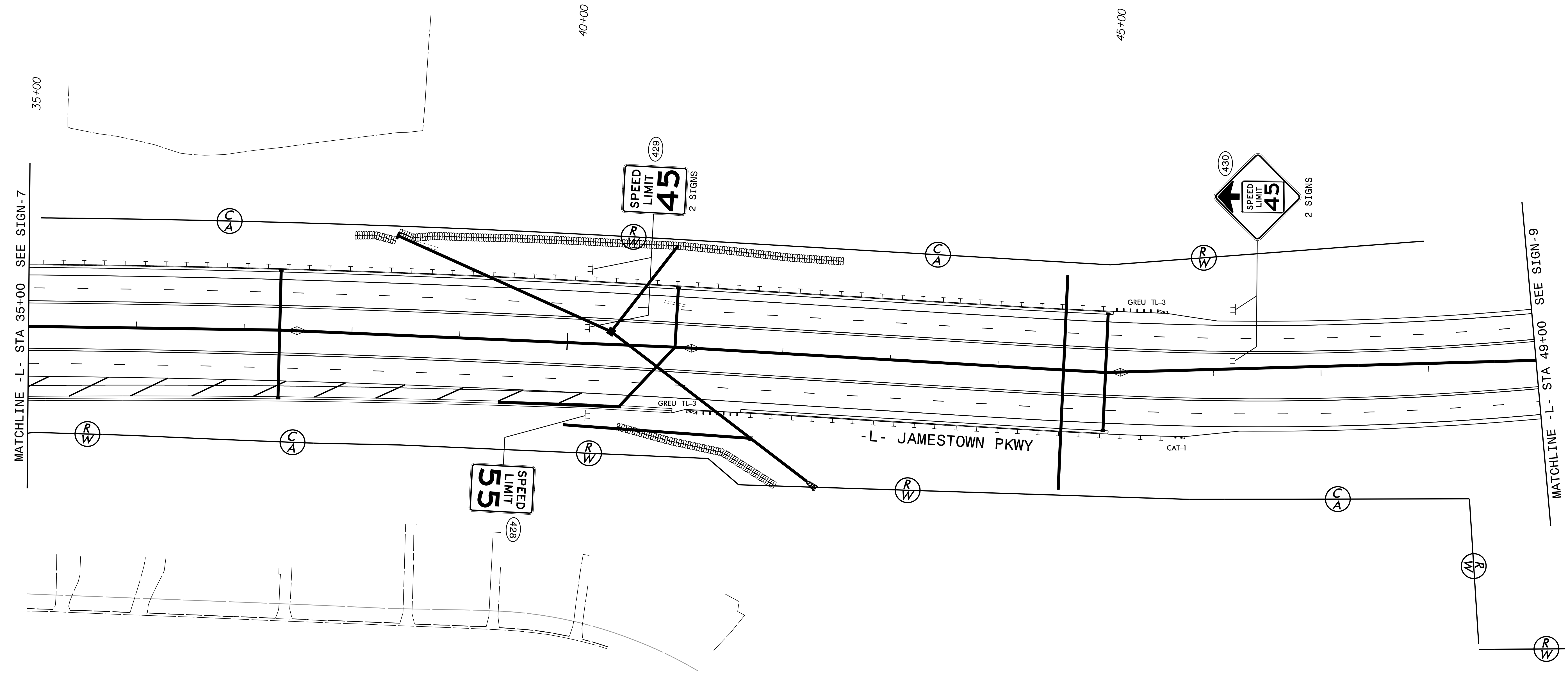
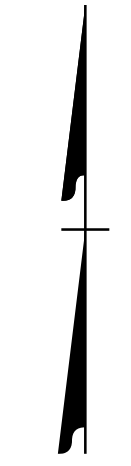

\$DATE\$
\$FILEL\$
EJH/ZMLH

PLANS PREPARED BY :

RK&K

RUMMEL, KLEPPER & KAHL, LLP
900 RIDGEFIELD DRIVE SUITE 350
RALEIGH, NORTH CAROLINA 27609-3960
NC LICENSE NO. F-0112 (919) 878-9560

PROPOSED SIGNS

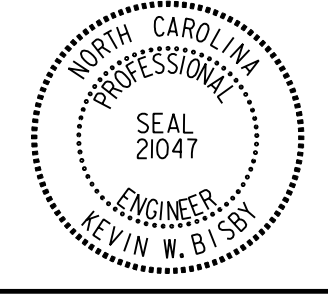
TIP NO. U-2412A	SHEET NO. SIGN-9
APPROVED: <i>Kevin W. Bisley</i>	
DATE: 3/18/2018	
SEAL 	
DOCUMENT NOT CONSIDERED FINAL UNLESS ALL SIGNATURES COMPLETED	

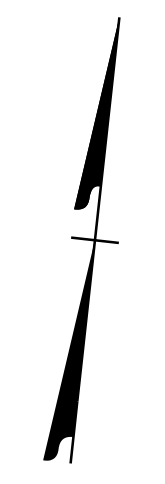
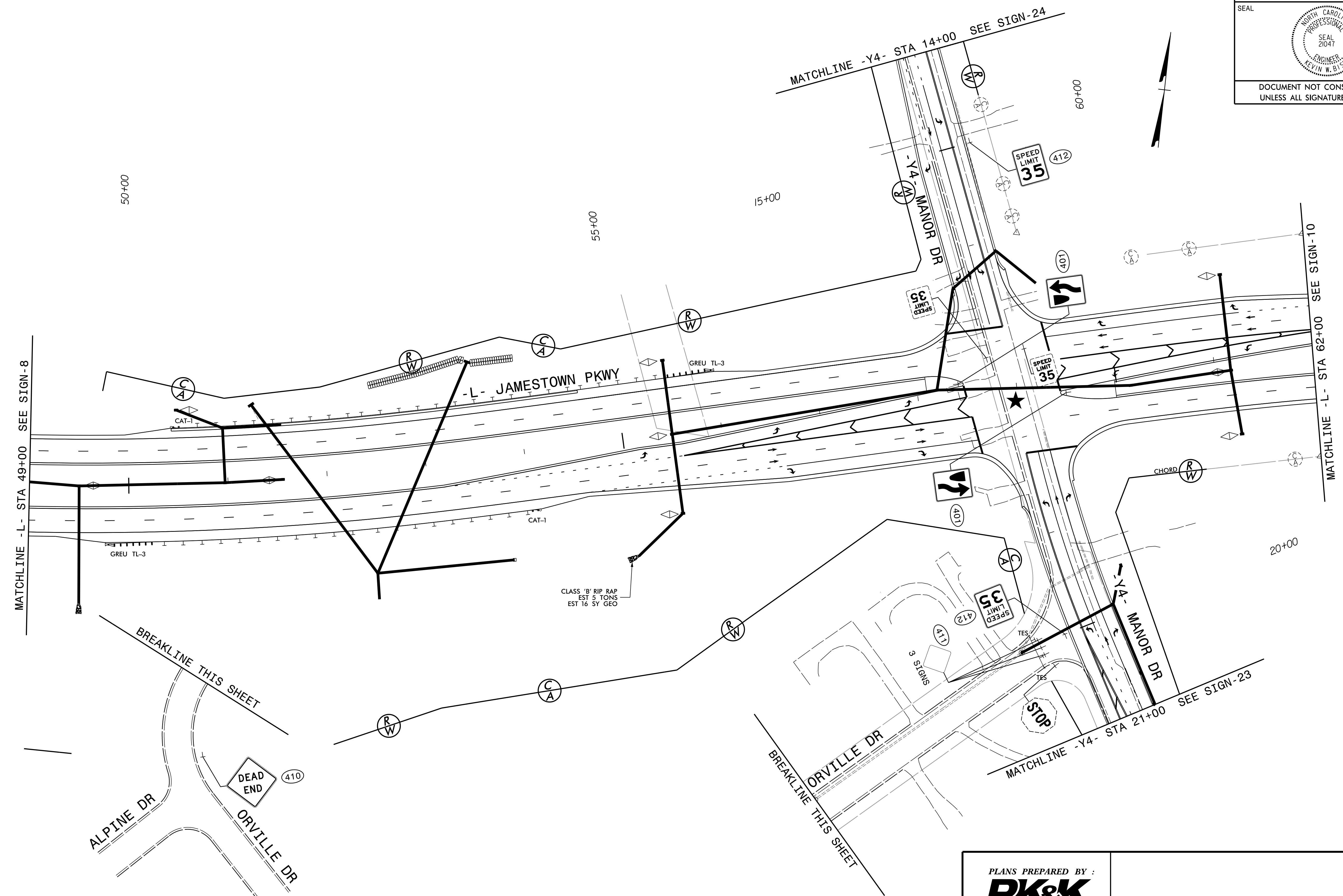

MATCHLINE -L- STA 49+00 SEE SIGN-8

MATCHLINE -Y4- STA 14+00 SEE SIGN-24

MATCHLINE -L- STA 62+00 SEE SIGN-10

MATCHLINE -Y4- STA 21+00 SEE SIGN-23

BREAKLINE THIS SHEET

BREAKLINE THIS SHEET

ALPINE DR

ORVILLE DR

-L- JAMESTOWN PKWY

ORVILLE DR

MANOR DR

CLASS 'B' RIP RAP
EST 5 TONS
EST 16 SY GEO

★ TRAFFIC SIGNAL

PLANS PREPARED BY :
RK&K
 RUMMEL, KLEPPER & KAHL, LLP
 900 RIDGEFIELD DRIVE SUITE 350
 RALEIGH, NORTH CAROLINA 27609-3960
 NC LICENSE NO. F-0112 (919) 878-9560

EXISTING and PROPOSED SIGNS

DATE: \$
 FILE: \$
 EJK/ZMLH

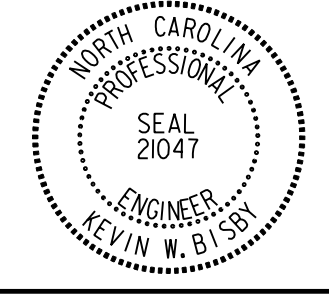
TIP NO. U-2412A	SHEET NO. SIGN-10
APPROVED: <i>Kevin W. Eshy</i> <small>3CE3CMBDF464B1...</small>	
DATE: 3/18/2018	
SEAL 	
DOCUMENT NOT CONSIDERED FINAL UNLESS ALL SIGNATURES COMPLETED	

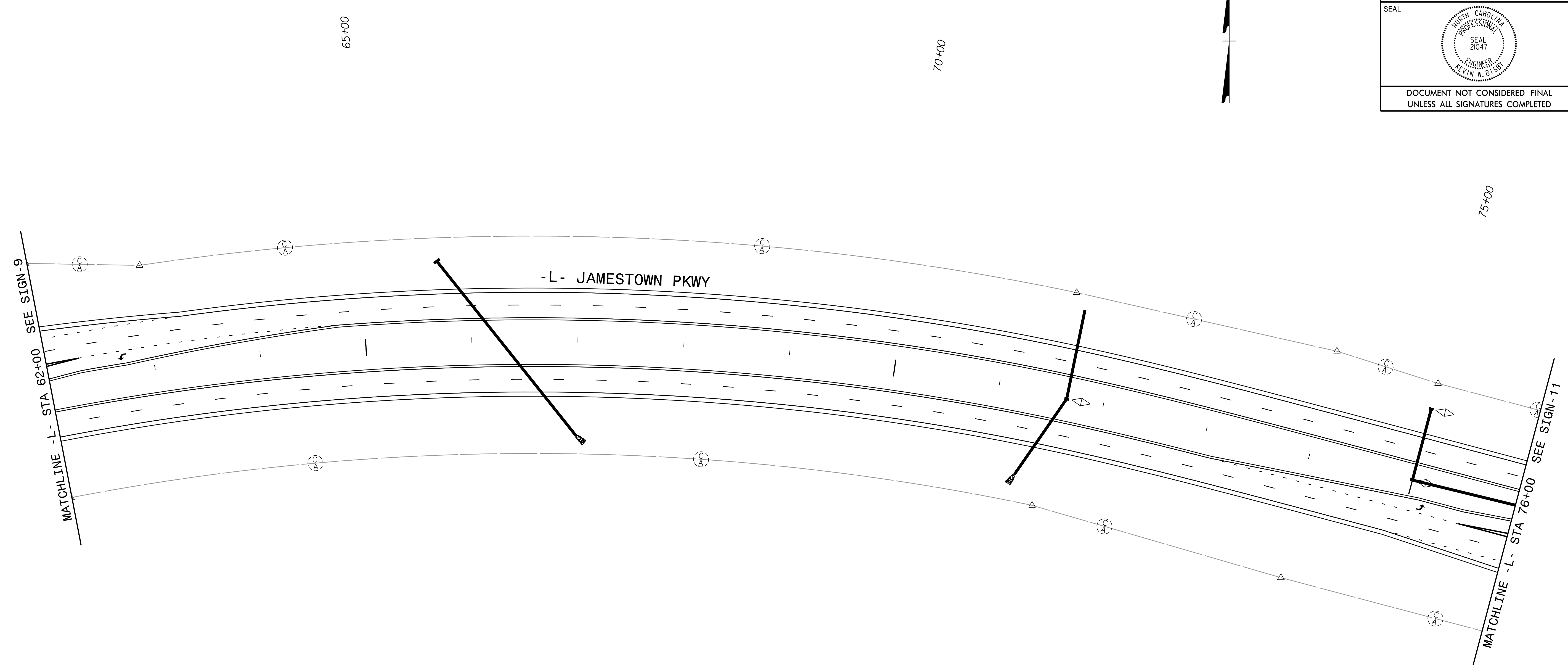
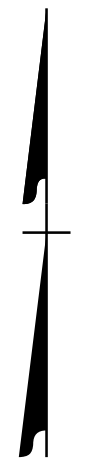

\$DATE\$
\$FILEL\$
EJH/ZMLH

PLANS PREPARED BY :
RK&K
 RUMMEL, KLEPPER & KAHL, LLP
 900 RIDGEFIELD DRIVE SUITE 350
 RALEIGH, NORTH CAROLINA 27609-3960
 NC LICENSE NO. F-0112 (919) 878-9560

NO SIGNING WORK

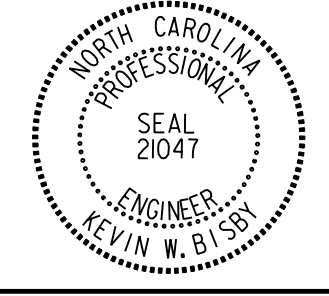
TIP NO. U-2412A	SHEET NO. SIGN-11
APPROVED: <i>Kevin W. Bisby</i> -3CE3C9ABDF4681-	
DATE: 3/18/2018	
SEAL 	
DOCUMENT NOT CONSIDERED FINAL UNLESS ALL SIGNATURES COMPLETED	

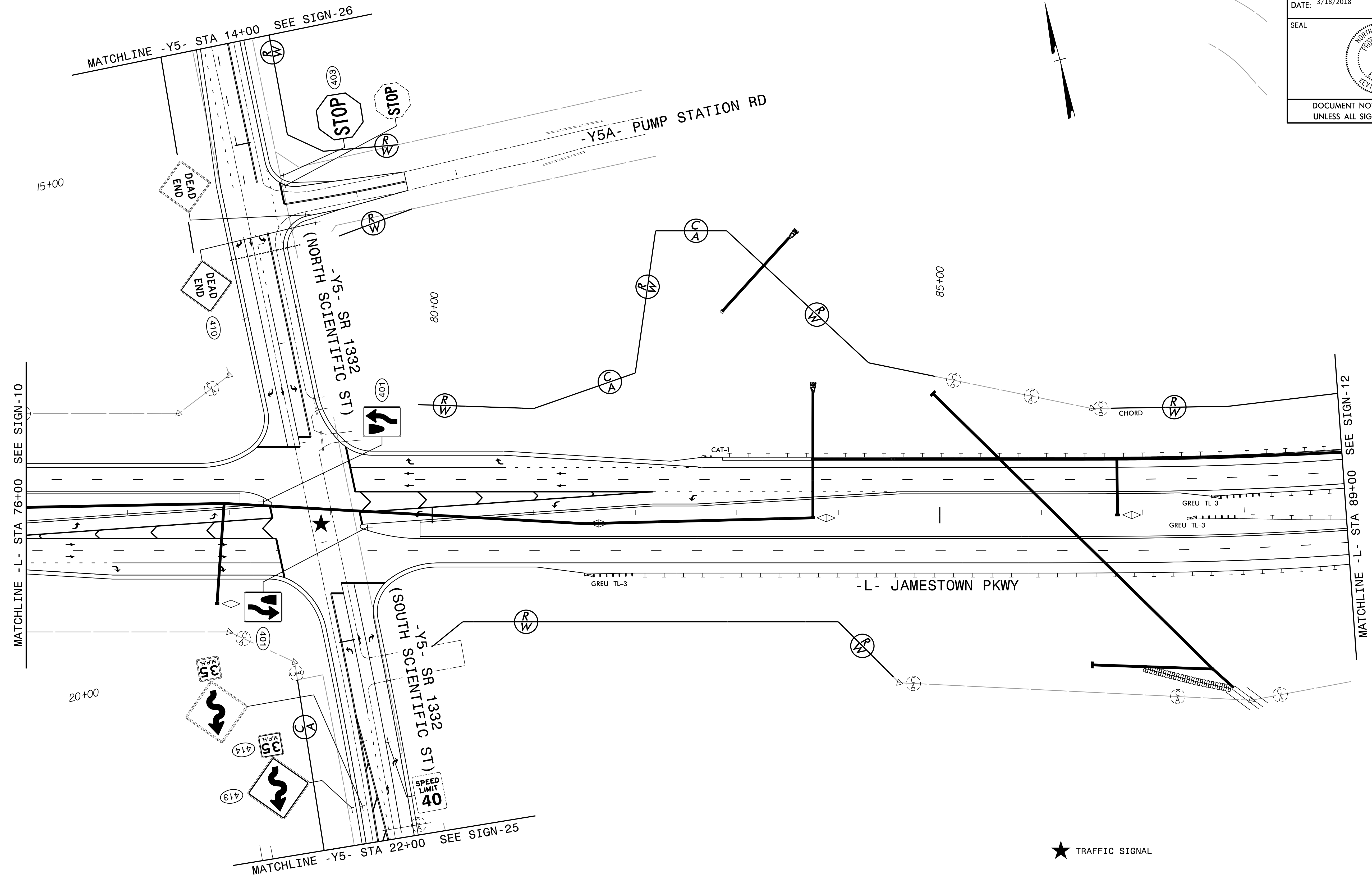

★ TRAFFIC SIGNAL

PLANS PREPARED BY :
RK&K
 RUMMEL, KLEPPER & KAHL, LLP
 900 RIDGEFIELD DRIVE SUITE 350
 RALEIGH, NORTH CAROLINA 27609-3960
 NC LICENSE NO. F-0112 (919) 878-9560

EXISTING and PROPOSED SIGNS

\$DATE\$
\$FILEL\$
EJH/ZMLH

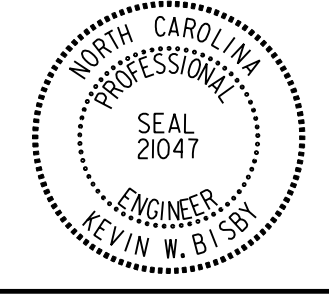
TIP NO.	SHEET NO.
U-2412A	SIGN-12
APPROVED: <i>Kevin W. Bishop</i> SCENC980DF48481	
DATE: 3/18/2018	
SEAL	
	
DOCUMENT NOT CONSIDERED FINAL UNLESS ALL SIGNATURES COMPLETED	

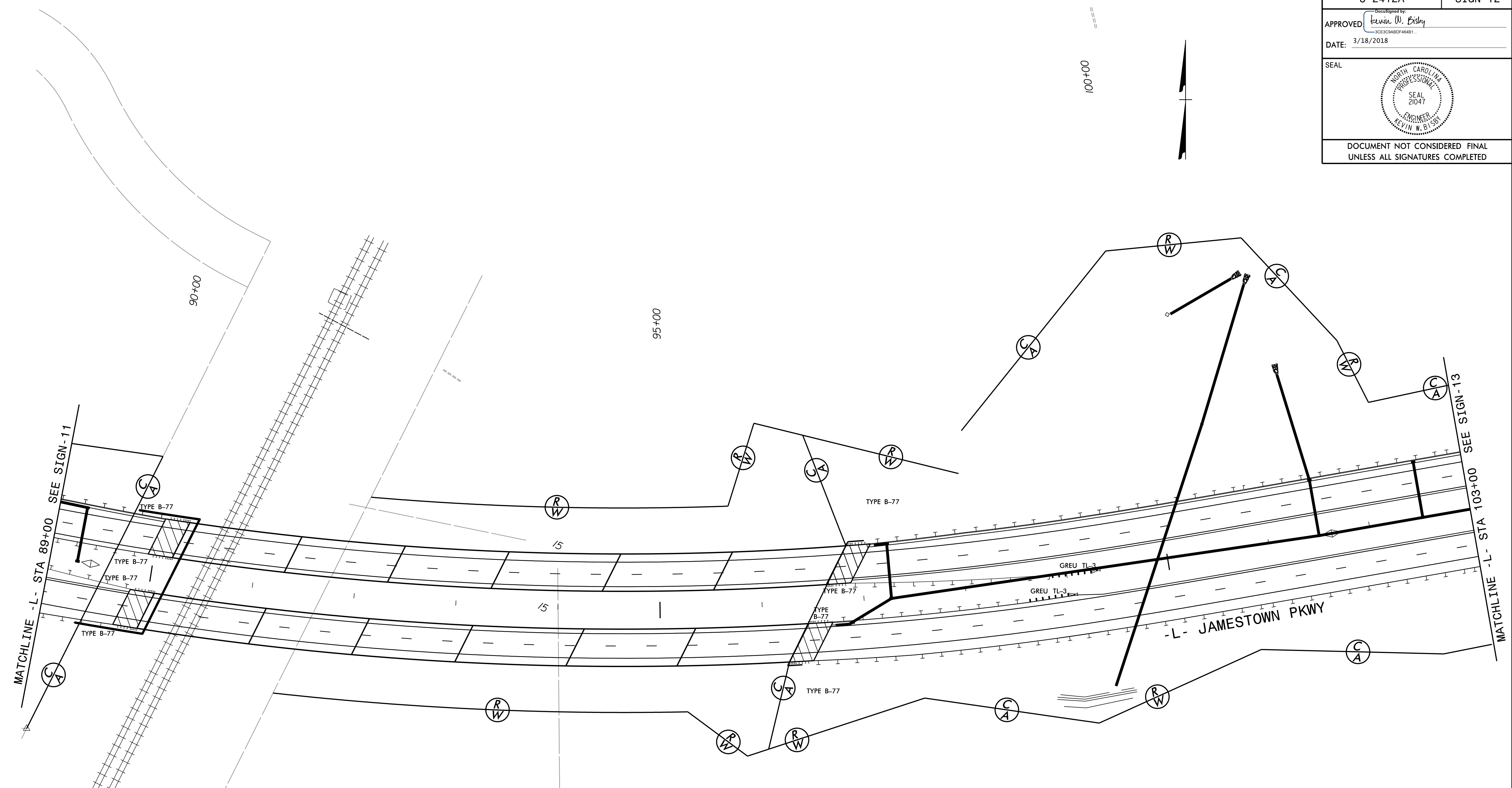

\$DATE\$
\$FILEL\$
EJH/ZMLH

PLANS PREPARED BY :

RK&K

RUMMEL, KLEPPER & KAHL, LLP
900 RIDGEFIELD DRIVE SUITE 350
RALEIGH, NORTH CAROLINA 27609-3960
NC LICENSE NO. F-0112 (919) 878-9560

NO SIGNING WORK

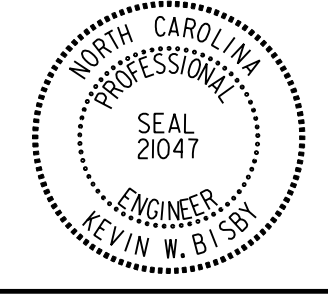
TIP NO. U-2412A	SHEET NO. SIGN-13
DocuSigned by: APPROVED: <i>Kevin W. Eiskay</i> 3CE32C8ARD444811	
DATE: 3/18/2018	
SEAL 	
DOCUMENT NOT CONSIDERED FINAL UNLESS ALL SIGNATURES COMPLETED	

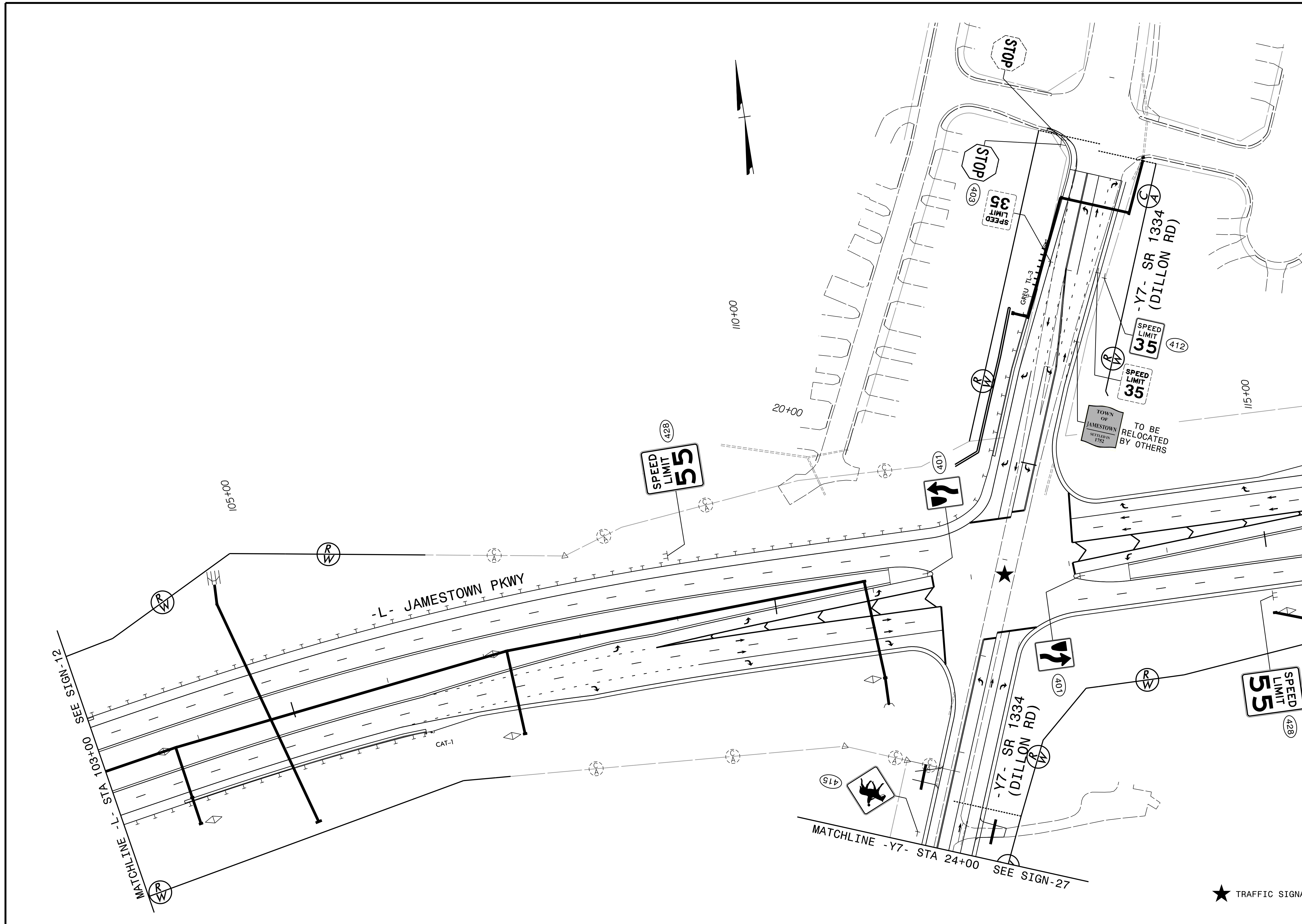

★ TRAFFIC SIGNAL

PLANS PREPARED BY :
RK&K
 RUMMEL, KLEPPER & KAHL, LLP
 900 RIDGEFIELD DRIVE SUITE 350
 RALEIGH, NORTH CAROLINA 27609-3960
 NC LICENSE NO. F-0112 (919) 878-9560

EXISTING and PROPOSED SIGNS

DATE: \$
FILED: \$
EJH/ZMLH

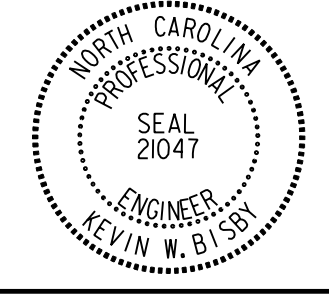
TIP NO. U-2412A	SHEET NO. SIGN-14
APPROVED: <i>Kevin W. Esby</i> <small>3CE3C8ABDF46481...</small>	
DATE: 3/18/2018	
SEAL 	
DOCUMENT NOT CONSIDERED FINAL UNLESS ALL SIGNATURES COMPLETED	

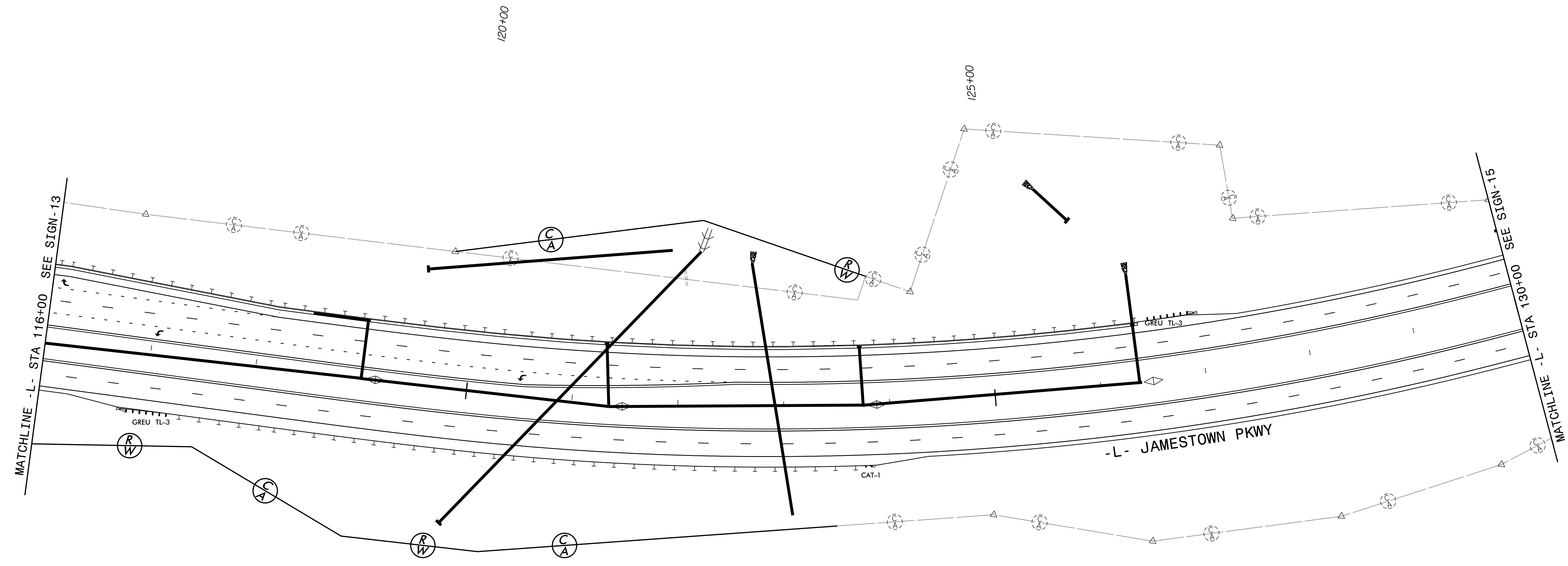
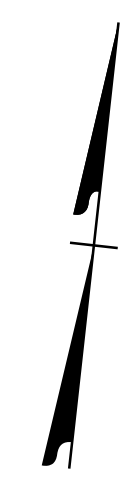

\$DATE\$
\$FILEL\$
EJH/ZMLH

PLANS PREPARED BY :

RK&K

RUMMEL, KLEPPER & KAHL, LLP
900 RIDGEFIELD DRIVE SUITE 350
RALEIGH, NORTH CAROLINA 27609-3960
NC LICENSE NO. F-0112 (919) 878-9560

NO SIGNING WORK

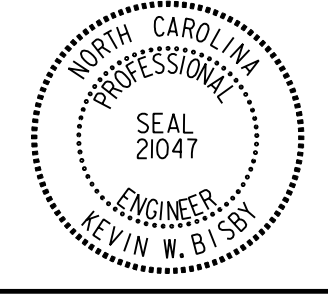
TIP NO. U-2412A	SHEET NO. SIGN-15
APPROVED: <i>Kevin W. Bisby</i> 302539ABDF484B1	
DATE: 3/18/2018	
SEAL 	
DOCUMENT NOT CONSIDERED FINAL UNLESS ALL SIGNATURES COMPLETED	

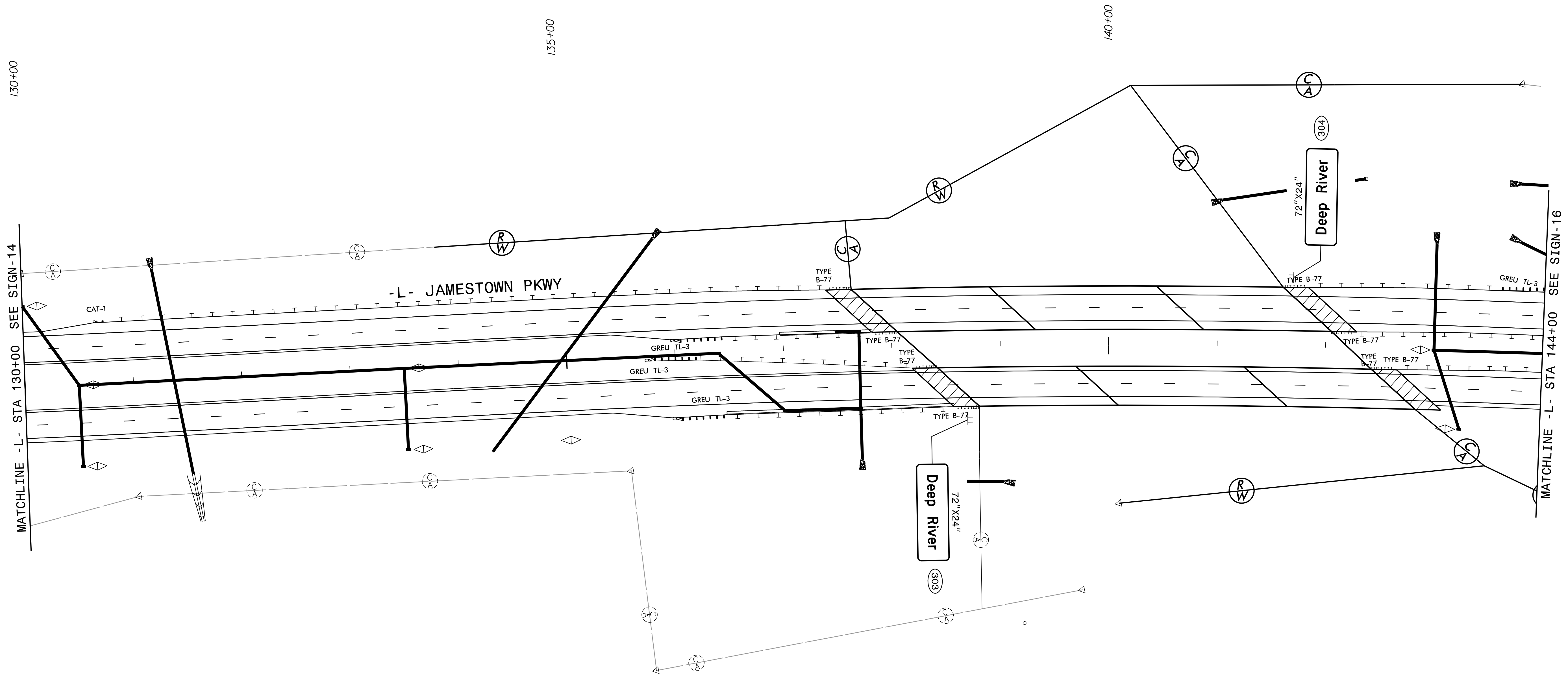
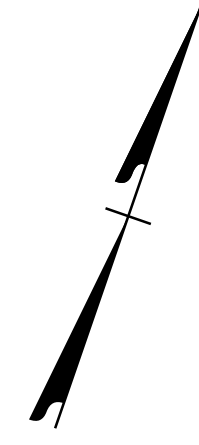

\$DATE\$
\$FILEL\$
EJH/XLH

PLANS PREPARED BY :

RK&K

RUMMEL, KLEPPER & KAHL, LLP
900 RIDGEFIELD DRIVE SUITE 350
RALEIGH, NORTH CAROLINA 27609-3960
NC LICENSE NO. F-0112 (919) 878-9560

PROPOSED SIGNS

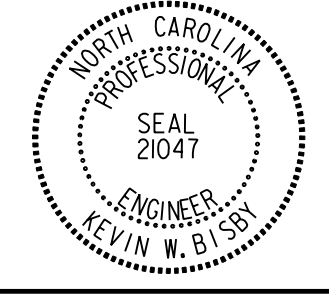
TIP NO. U-2412A	SHEET NO. SIGN-16
Approved by: <i>Kevin W. Bishop</i> DATE: 3/18/2018	
SEAL 	
DOCUMENT NOT CONSIDERED FINAL UNLESS ALL SIGNATURES COMPLETED	

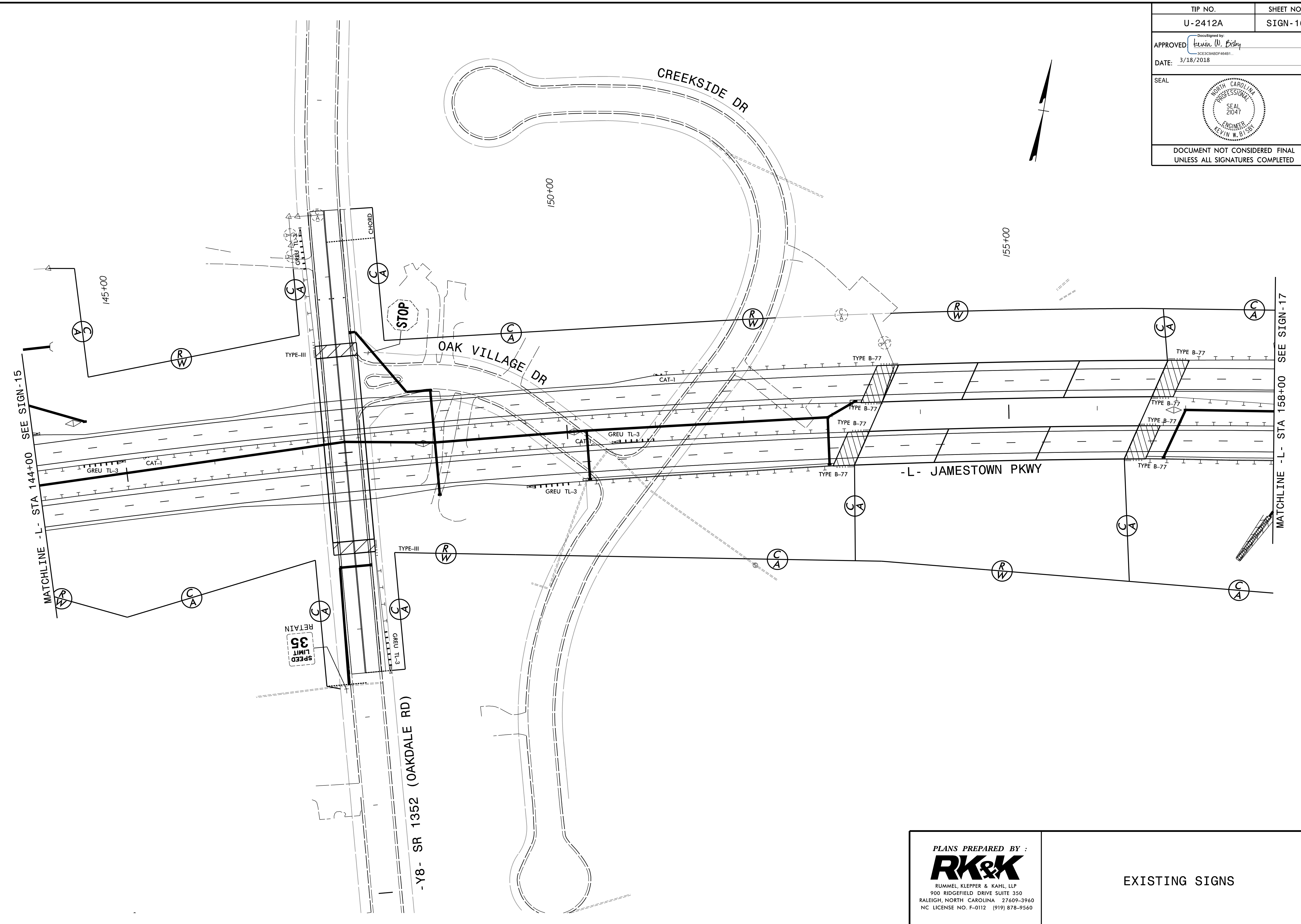

\$DATE\$
\$FILEL\$
EJH/ZMLH

PLANS PREPARED BY :

RK&K

RUMMEL, KLEPPER & KAHL, LLP
 900 RIDGEFIELD DRIVE SUITE 350
 RALEIGH, NORTH CAROLINA 27609-3960
 NC LICENSE NO. F-0112 (919) 878-9560

EXISTING SIGNS

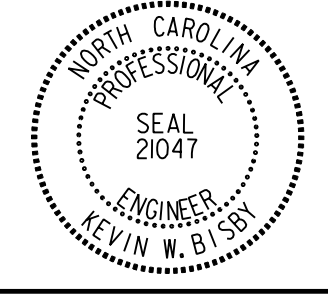
TIP NO. U-2412A	SHEET NO. SIGN-18
APPROVED: <i>Kevin W. Bishop</i> 3/18/2018	
DATE: 3/18/2018	
SEAL 	
DOCUMENT NOT CONSIDERED FINAL UNLESS ALL SIGNATURES COMPLETED	

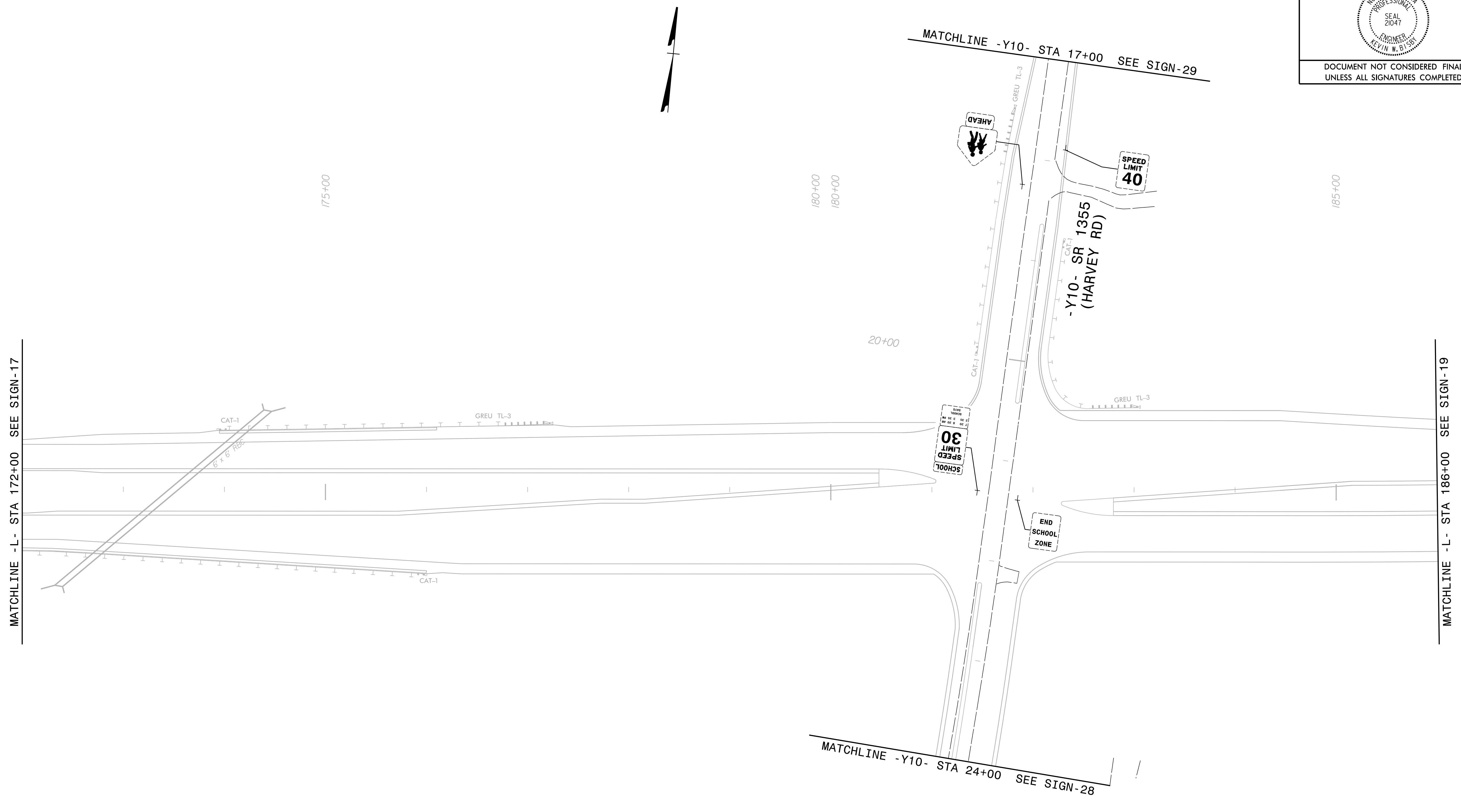

\$DATE\$
\$FILEL\$
EJH/ZMLH

PLANS PREPARED BY :

RK&K

RUMMEL, KLEPPER & KAHL, LLP
900 RIDGEFIELD DRIVE SUITE 350
RALEIGH, NORTH CAROLINA 27609-3960
NC LICENSE NO. F-0112 (919) 878-9560

EXISTING SIGNS

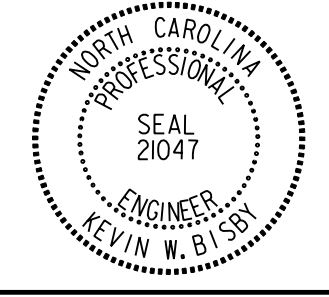
TIP NO. U-2412A	SHEET NO. SIGN-18A
APPROVED: <i>Kevin W. Bisby</i> 3CE3C9ABDF44B1	
DATE: 3/18/2018	
SEAL 	
DOCUMENT NOT CONSIDERED FINAL UNLESS ALL SIGNATURES COMPLETED	

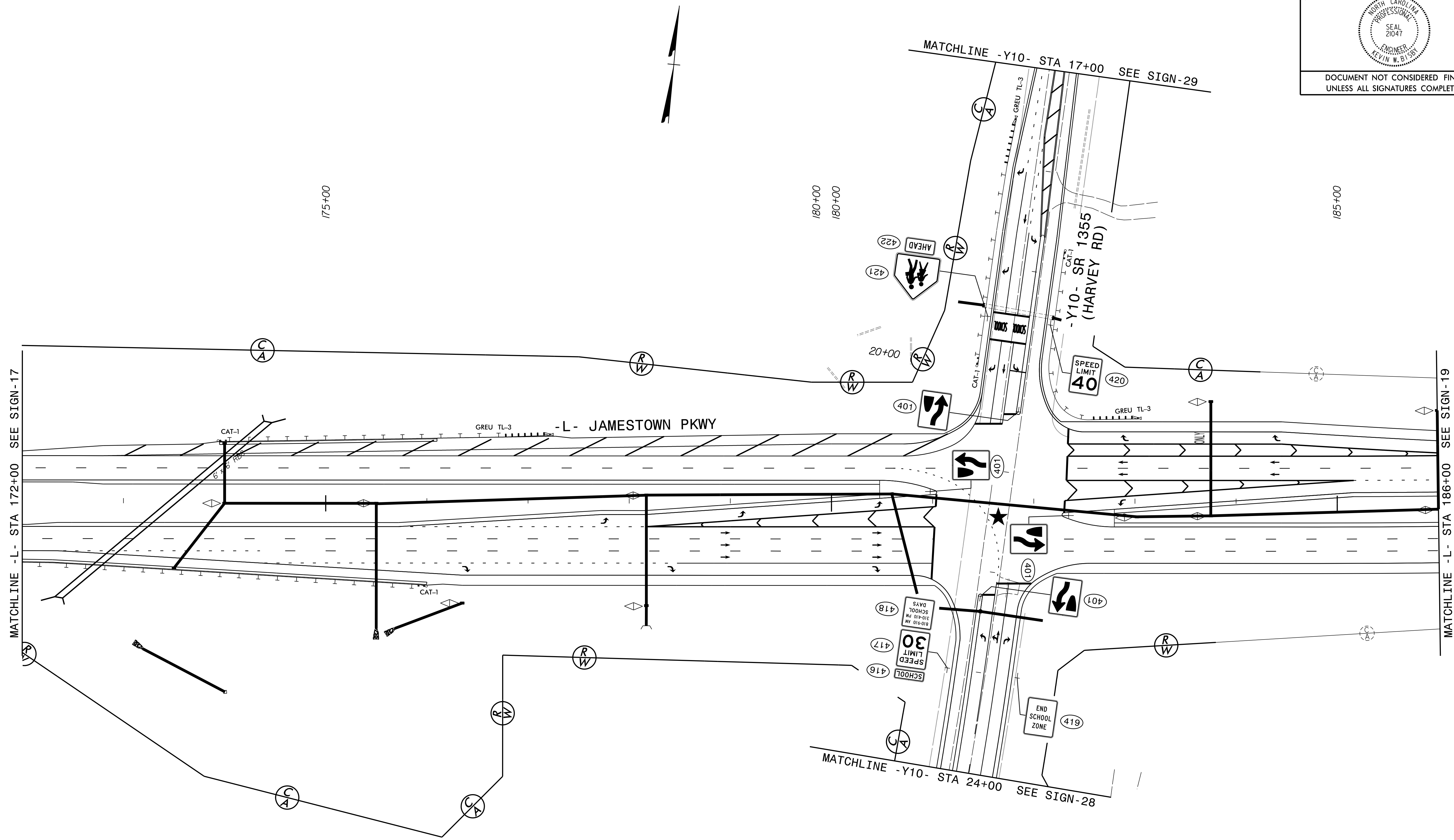

★ TRAFFIC SIGNAL

PLANS PREPARED BY :
RK&K
 RUMMEL, KLEPPER & KAHL, LLP
 900 RIDGEFIELD DRIVE SUITE 350
 RALEIGH, NORTH CAROLINA 27609-3960
 NC LICENSE NO. F-0112 (919) 878-9560

PROPOSED SIGNS

DATE: \$
FILE: \$
EJH/ZMLH

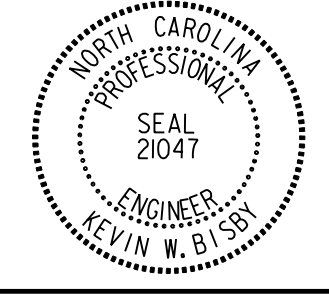
TIP NO. U-2412A	SHEET NO. SIGN-19
APPROVED: <i>Kevin W. Bixby</i> 3/18/2018	
DATE: 3/18/2018	
SEAL 	
DOCUMENT NOT CONSIDERED FINAL UNLESS ALL SIGNATURES COMPLETED	

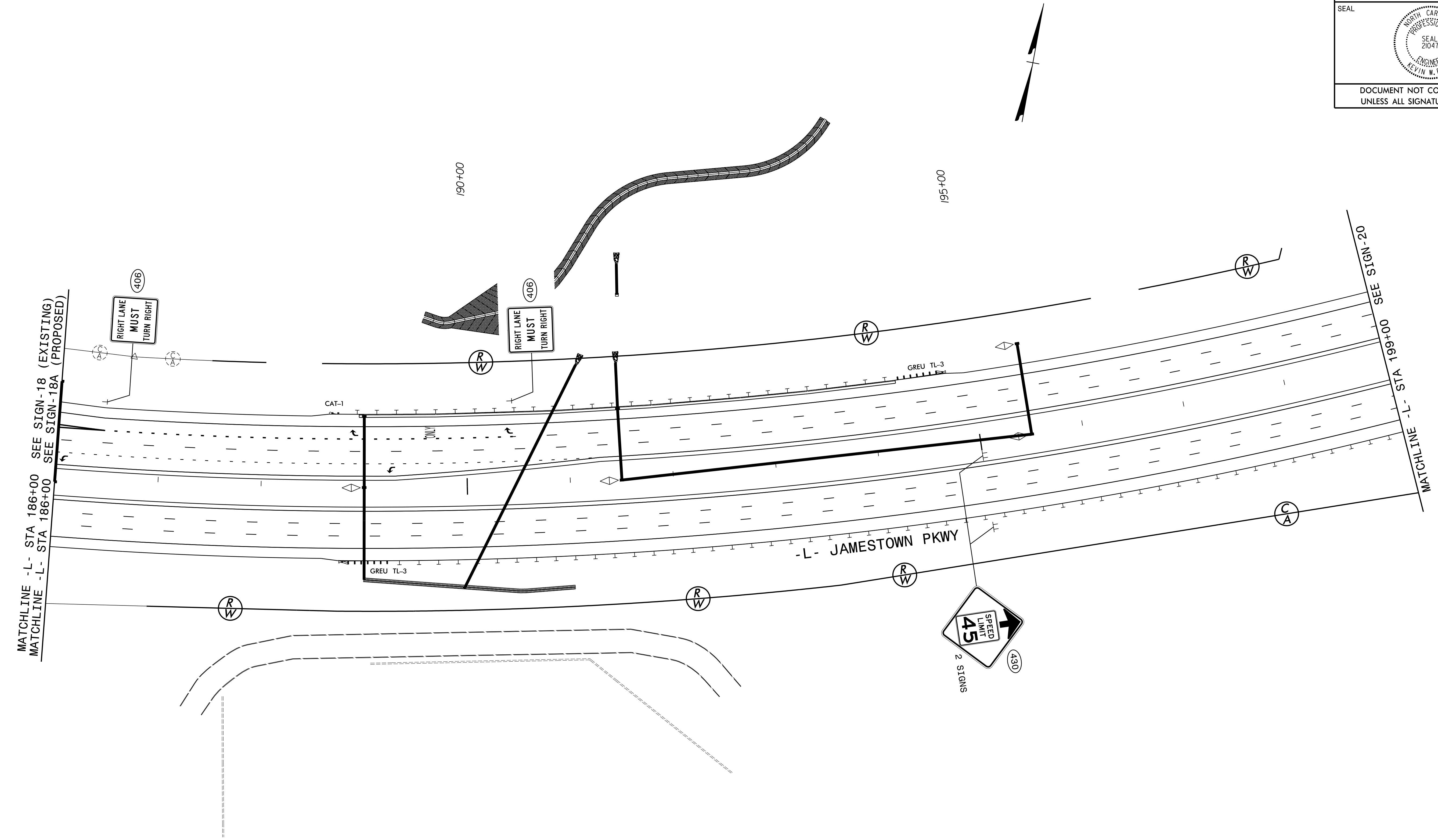

DATE: \$
FILED: \$
EJH/ZMLH

PLANS PREPARED BY :
RK&K
 RUMMEL, KLEPPER & KAHL, LLP
 900 RIDGEFIELD DRIVE SUITE 350
 RALEIGH, NORTH CAROLINA 27609-3960
 NC LICENSE NO. F-0112 (919) 878-9560

PROPOSED SIGNS

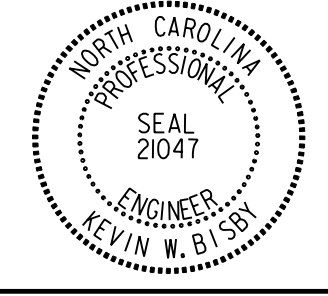
TIP NO.	SHEET NO.
U-2412A	SIGN-20
APPROVED: <i>Kevin W. Bisby</i>	
DATE: 3/18/2018	
SEAL	
	
DOCUMENT NOT CONSIDERED FINAL UNLESS ALL SIGNATURES COMPLETED	

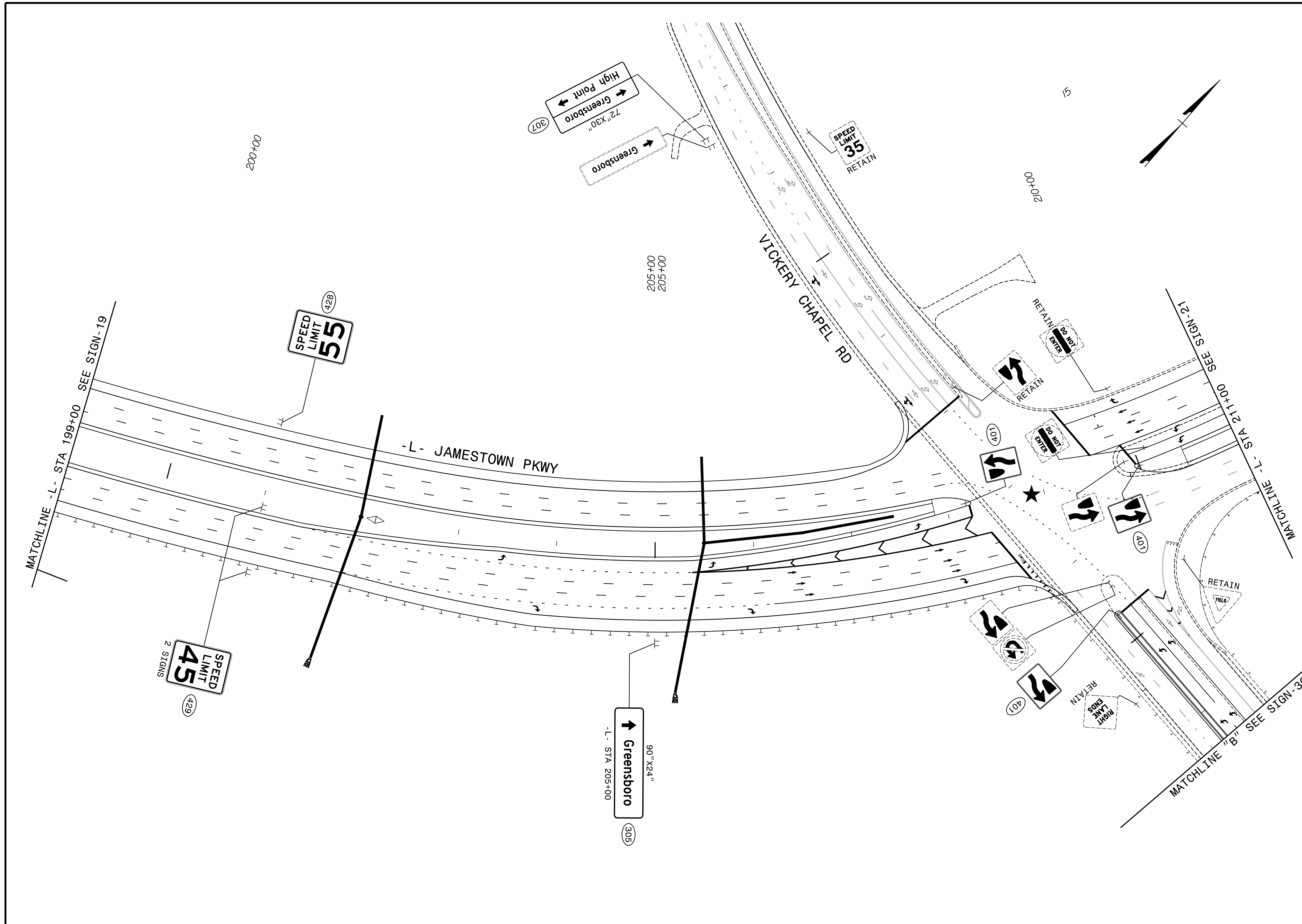

★ TRAFFIC SIGNAL

PLANS PREPARED BY :

RK&K

RUMMEL, KLEPPER & KAHL, LLP
 900 RIDGEFIELD DRIVE SUITE 350
 RALEIGH, NORTH CAROLINA 27609-3960
 NC LICENSE NO. F-0112 (919) 878-9560

EXISTING and PROPOSED SIGNS

\$DATE\$
\$FILEL\$
EJH/ZMLH

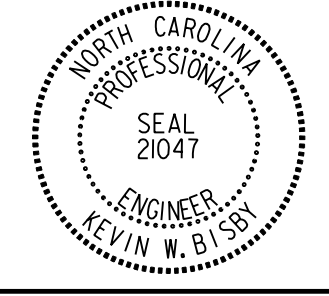
TIP NO. U-2412A	SHEET NO. SIGN-22
APPROVED: <i>Kevin W. Bisby</i> 3CE3C9ABDF46B1	
DATE: 3/18/2018	
SEAL 	
DOCUMENT NOT CONSIDERED FINAL UNLESS ALL SIGNATURES COMPLETED	

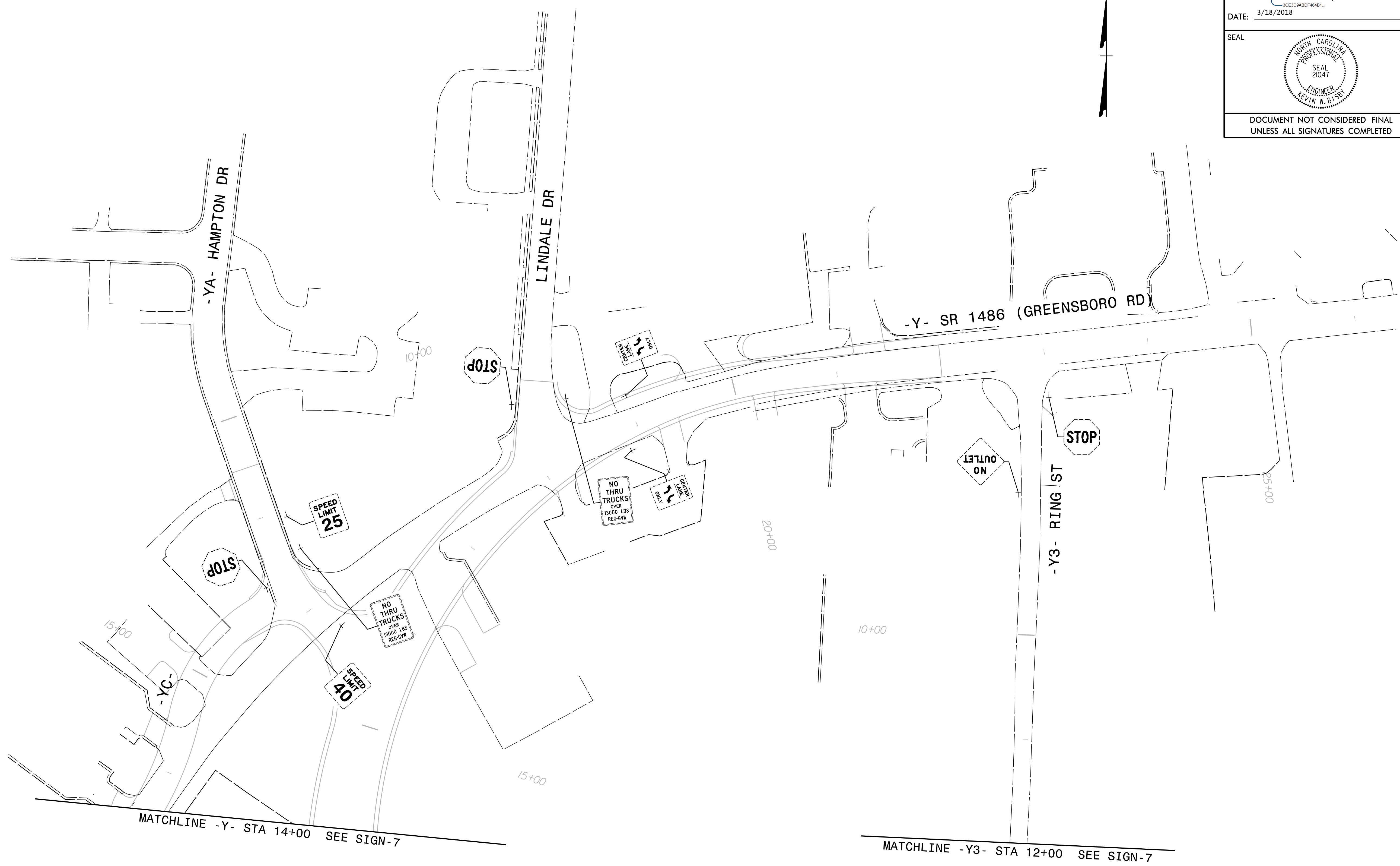

\$DATE\$
\$FILEL\$
EJH/ZMLH

PLANS PREPARED BY :
RK&K
 RUMMEL, KLEPPER & KAHL, LLP
 900 RIDGEFIELD DRIVE SUITE 350
 RALEIGH, NORTH CAROLINA 27609-3960
 NC LICENSE NO. F-0112 (919) 878-9560

EXISTING SIGNS

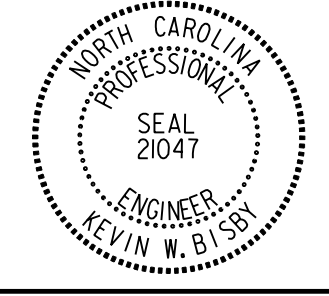
TIP NO. U-2412A	SHEET NO. SIGN-22A
APPROVED: <i>Kevin W. Biskay</i> 3CE3CB8DF46481	
DATE: 3/18/2018	
SEAL 	
DOCUMENT NOT CONSIDERED FINAL UNLESS ALL SIGNATURES COMPLETED	

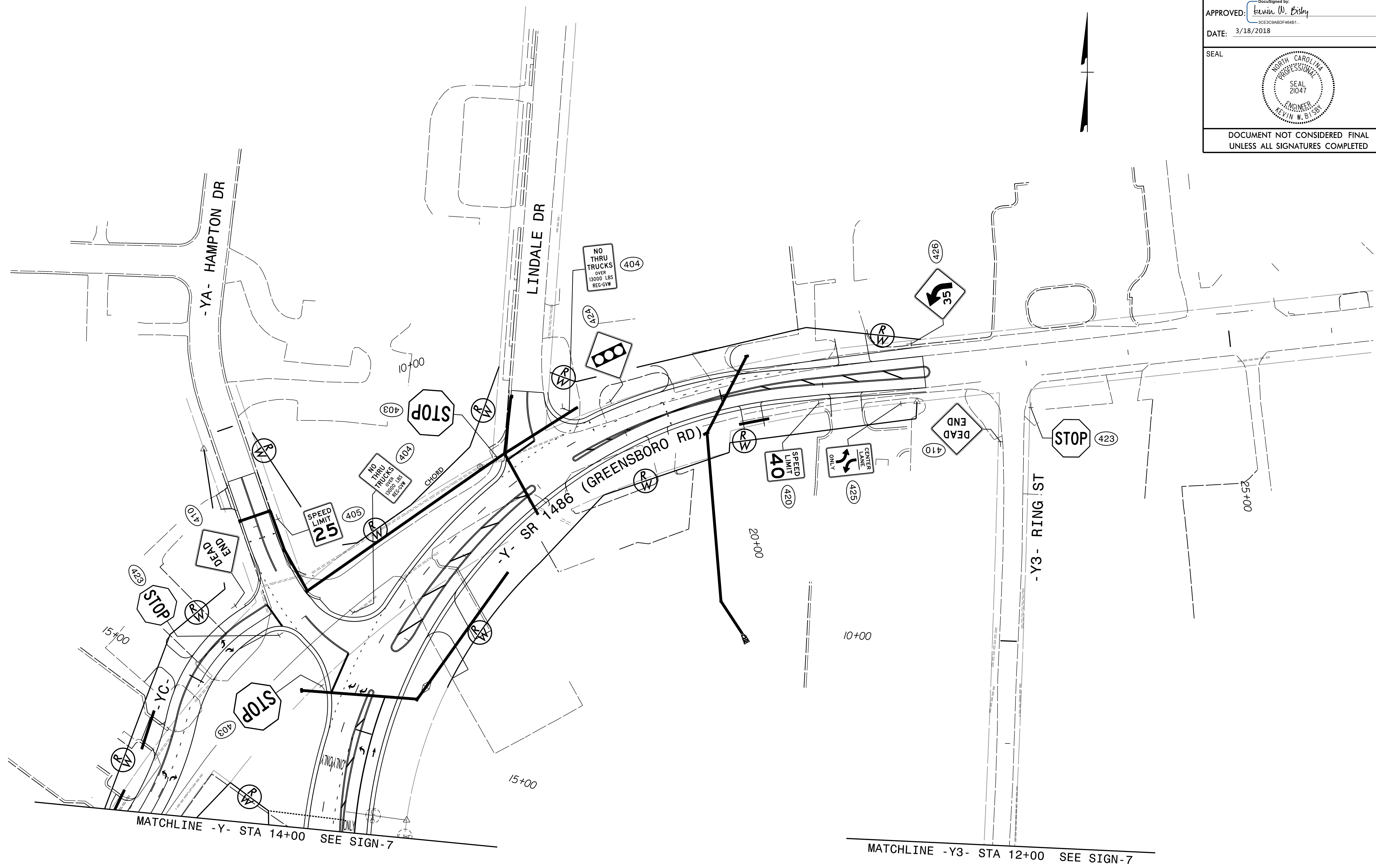

DATE: \$
FILED: \$
EJH/ZMLH

PLANS PREPARED BY :
RK&K
 RUMMEL, KLEPPER & KAHL, LLP
 900 RIDGEFIELD DRIVE SUITE 350
 RALEIGH, NORTH CAROLINA 27609-3960
 NC LICENSE NO. F-0112 (919) 878-9560

PROPOSED SIGNS

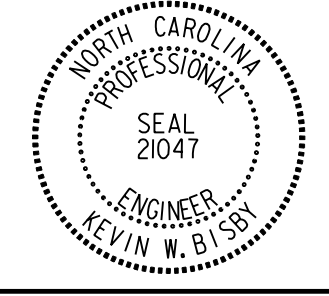
TIP NO. U-2412A	SHEET NO. SIGN-23
APPROVED: <i>Kevin W. Bishop</i> 3/18/2018	
DATE: 3/18/2018	
SEAL 	
DOCUMENT NOT CONSIDERED FINAL UNLESS ALL SIGNATURES COMPLETED	

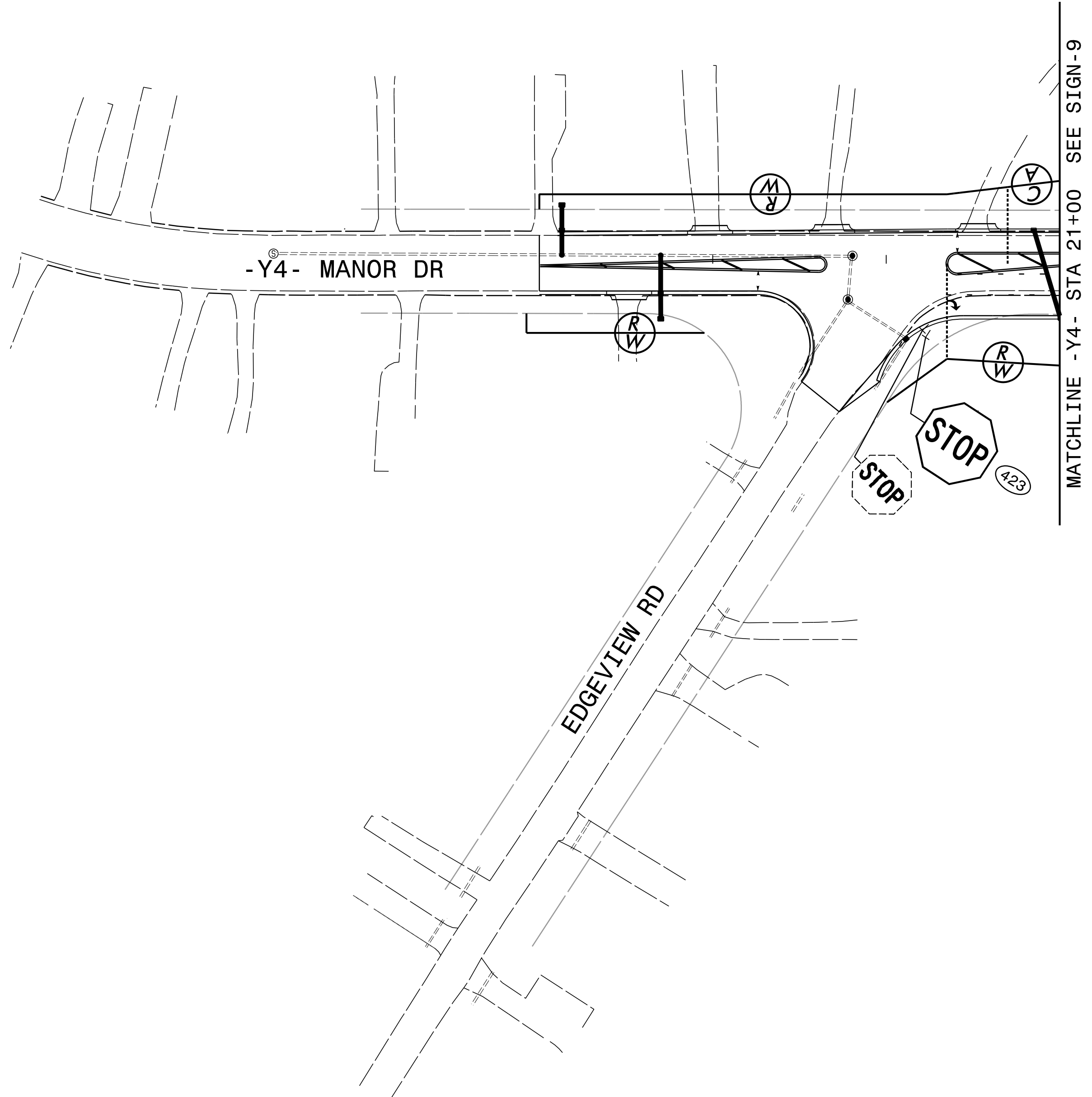

\$DATE\$
\$FILEL\$
EJH/ZMLH

PLANS PREPARED BY :
RK&K
 RUMMEL, KLEPPER & KAHL, LLP
 900 RIDGEFIELD DRIVE SUITE 350
 RALEIGH, NORTH CAROLINA 27609-3960
 NC LICENSE NO. F-0112 (919) 878-9560

EXISTING and PROPOSED SIGNS

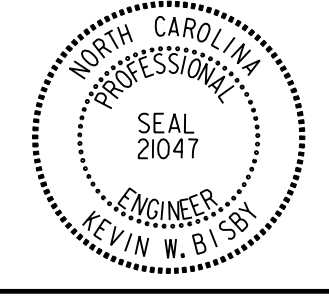
TIP NO. U-2412A	SHEET NO. SIGN-24
APPROVED: <i>Kevin W. Bishop</i> 3/18/2018	
DATE: 3/18/2018	
SEAL 	
DOCUMENT NOT CONSIDERED FINAL UNLESS ALL SIGNATURES COMPLETED	

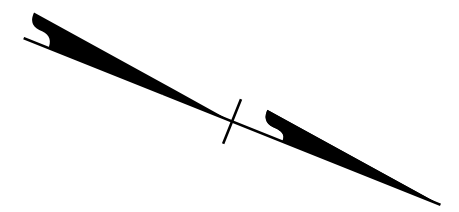

00+01

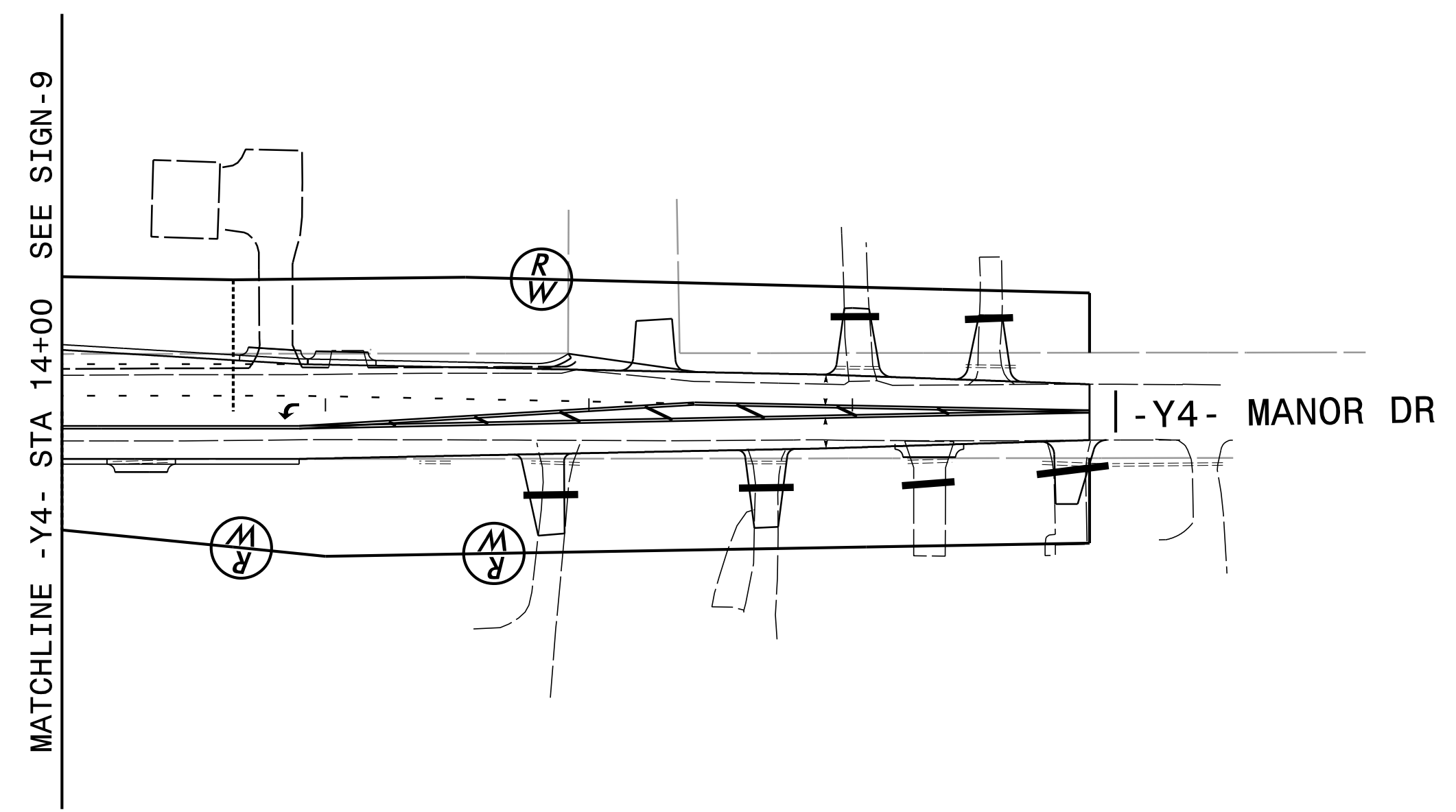

\$DATE\$
\$FILEL\$
EJH/MJH

PLANS PREPARED BY :

 RUMMEL, KLEPPER & KAHL, LLP
 900 RIDGEFIELD DRIVE SUITE 350
 RALEIGH, NORTH CAROLINA 27609-3960
 NC LICENSE NO. F-0112 (919) 878-9560

NO SIGNING WORK

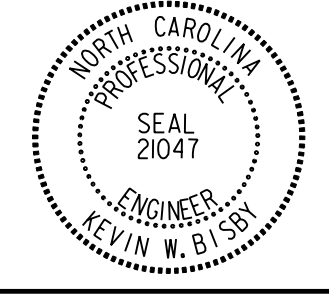
TIP NO. U-2412A	SHEET NO. SIGN-25
APPROVED: <i>Kevin W. Bishop</i> <small>REGISTERED PROFESSIONAL ENGINEER</small>	
DATE: 3/18/2018	
SEAL	
	
DOCUMENT NOT CONSIDERED FINAL UNLESS ALL SIGNATURES COMPLETED	

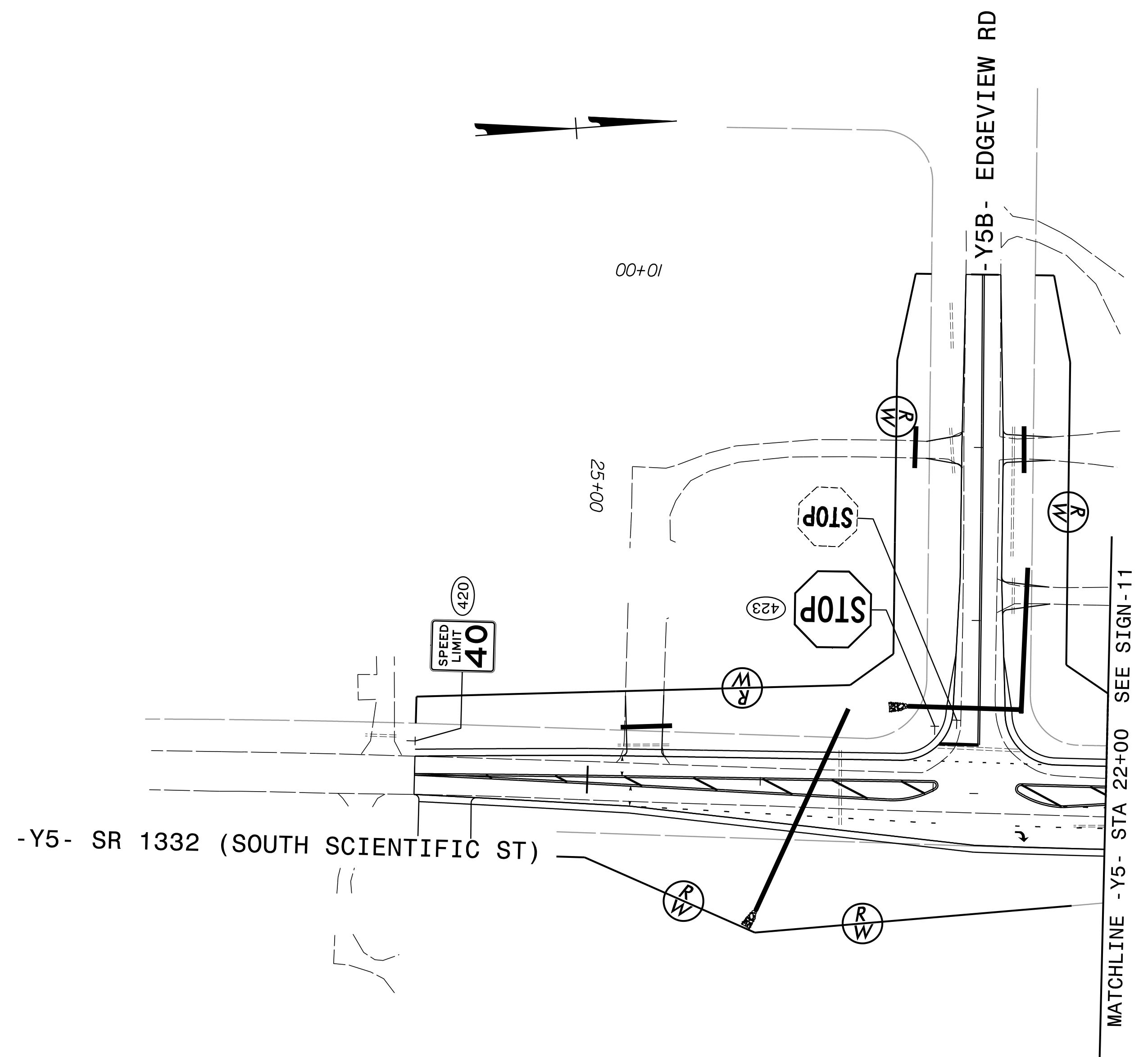

\$DATE\$
\$FILEL\$
EJH/MLH

PLANS PREPARED BY :

RK&K

RUMMEL, KLEPPER & KAHL, LLP
 900 RIDGEFIELD DRIVE SUITE 350
 RALEIGH, NORTH CAROLINA 27609-3960
 NC LICENSE NO. F-0112 (919) 878-9560

EXISTING and PROPOSED SIGNS

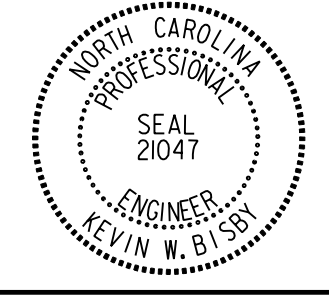
TIP NO. U-2412A	SHEET NO. SIGN-26
APPROVED: <i>Kevin W. Bisby</i> <small>REGISTERED PROFESSIONAL ENGINEER</small>	
DATE: 3/18/2018	
SEAL	
	
DOCUMENT NOT CONSIDERED FINAL UNLESS ALL SIGNATURES COMPLETED	



00+01

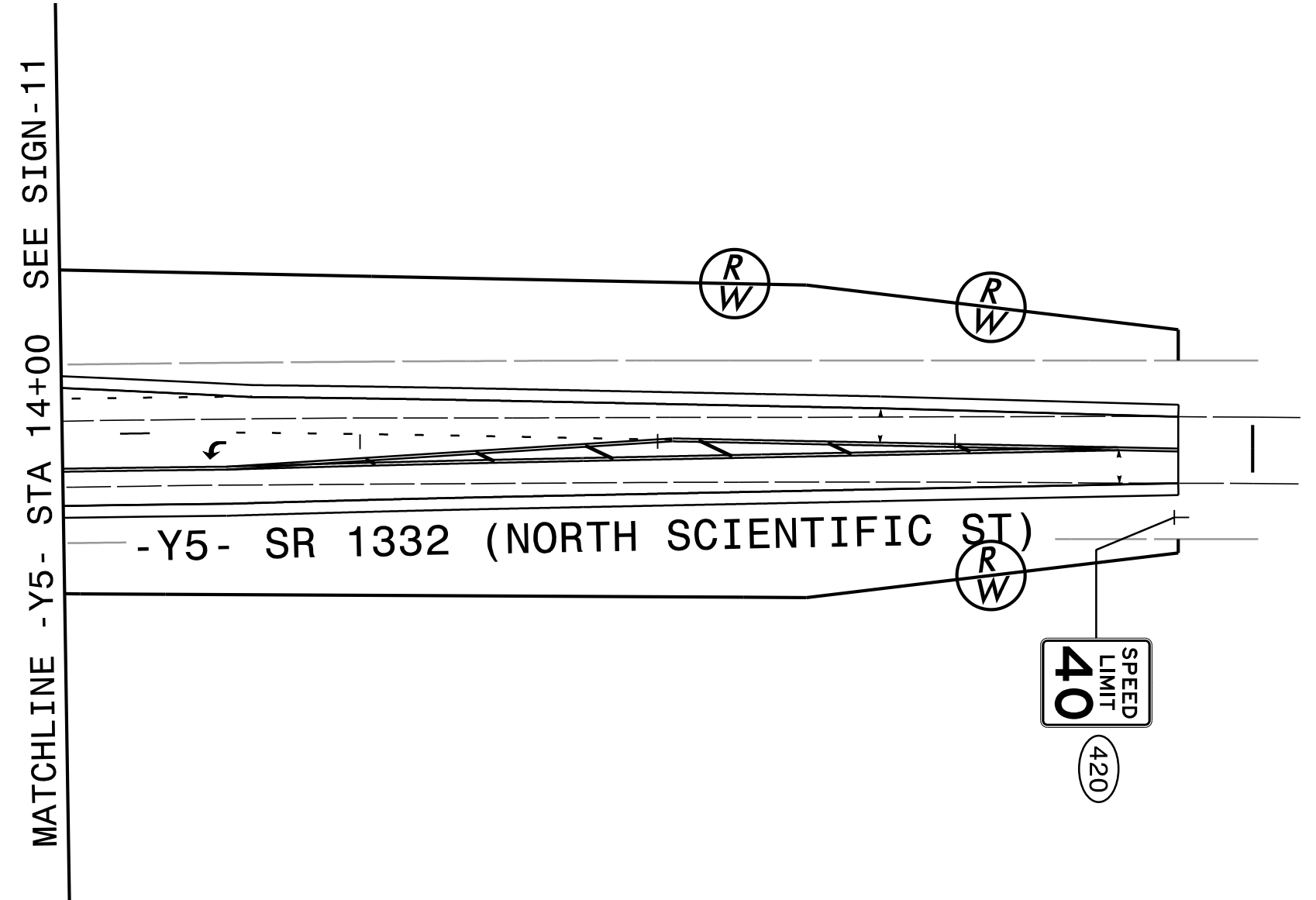

\$DATE\$
\$FILEL\$
EJH/MJH

PLANS PREPARED BY :

RK&K

RUMMEL, KLEPPER & KAHL, LLP
 900 RIDGEFIELD DRIVE SUITE 350
 RALEIGH, NORTH CAROLINA 27609-3960
 NC LICENSE NO. F-0112 (919) 878-9560

PROPOSED SIGNS

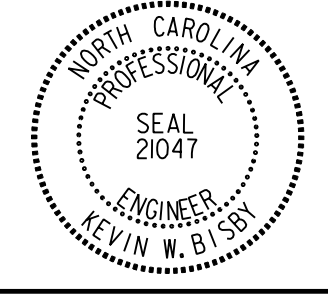
TIP NO. U-2412A	SHEET NO. SIGN-27
APPROVED: <i>Kevin W. Bishop</i> DATE: 3/18/2018	
SEAL 	
DOCUMENT NOT CONSIDERED FINAL UNLESS ALL SIGNATURES COMPLETED	

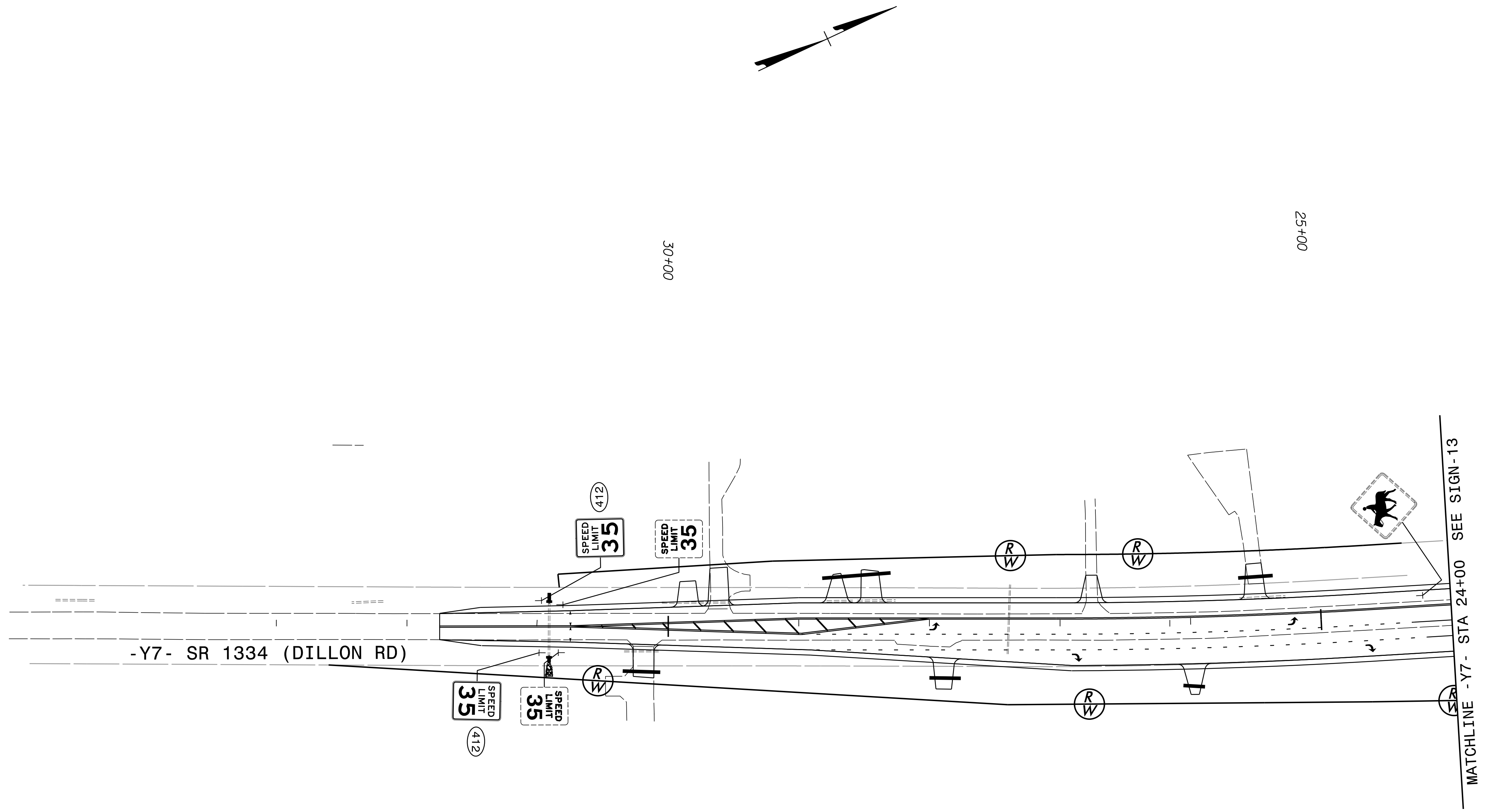

\$DATE\$
\$FILEL\$
EJH/ZMLH

PLANS PREPARED BY :

RK&K

RUMMEL, KLEPPER & KAHL, LLP
900 RIDGEFIELD DRIVE SUITE 350
RALEIGH, NORTH CAROLINA 27609-3960
NC LICENSE NO. F-0112 (919) 878-9560

EXISTING and PROPOSED SIGNS

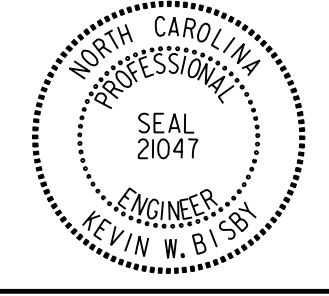
TIP NO. U-2412A	SHEET NO. SIGN-28
APPROVED: <i>Kevin W. Bishop</i> 3CE3C9ABDF44B1...	
DATE: 3/18/2018	
SEAL 	
DOCUMENT NOT CONSIDERED FINAL UNLESS ALL SIGNATURES COMPLETED	

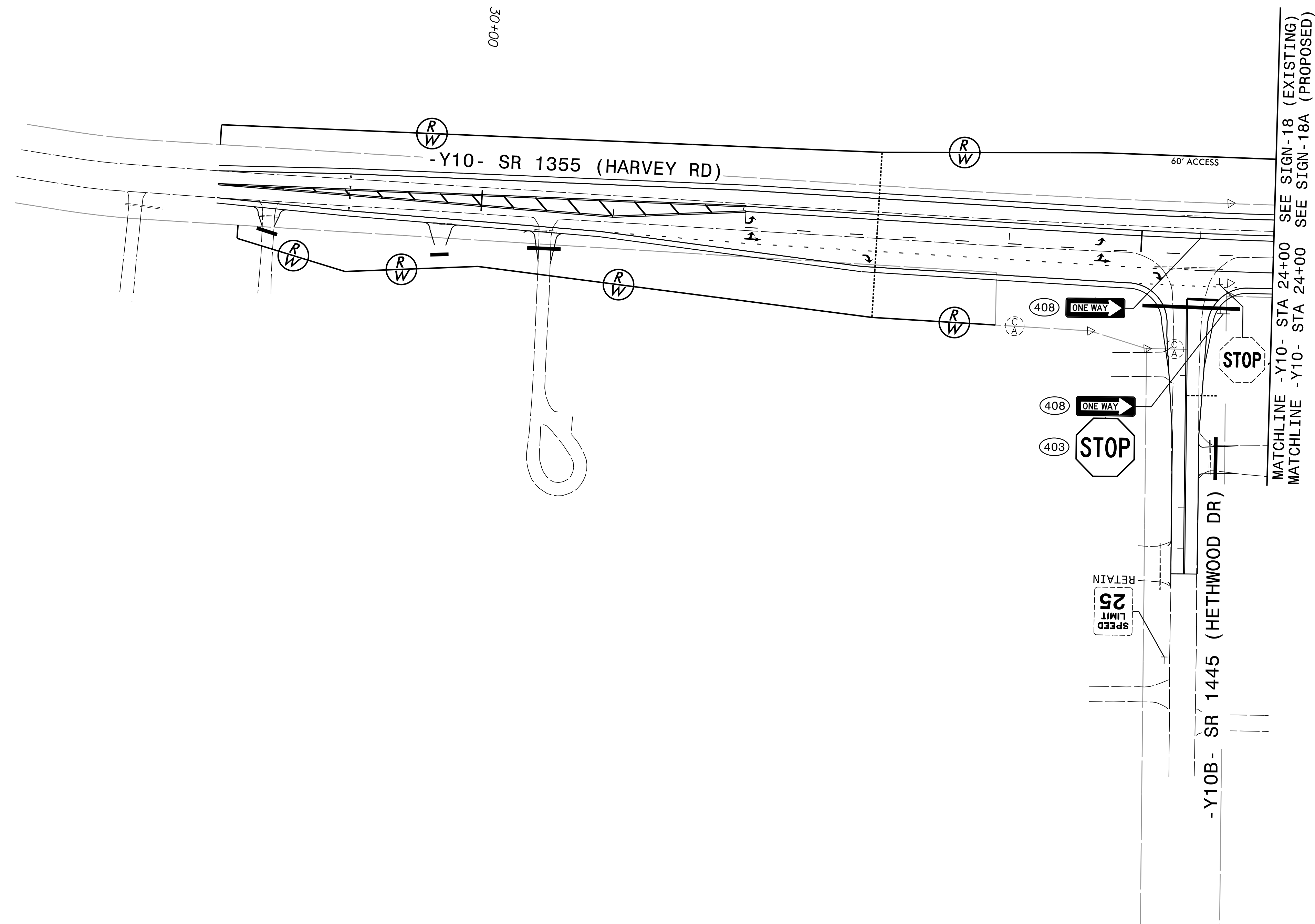

\$DATE\$
\$FILEL\$
EJH/ZMLH

PLANS PREPARED BY :

RK&K

RUMMEL, KLEPPER & KAHL, LLP
900 RIDGEFIELD DRIVE SUITE 350
RALEIGH, NORTH CAROLINA 27609-3960
NC LICENSE NO. F-0112 (919) 878-9560

EXISTING and PROPOSED SIGNS

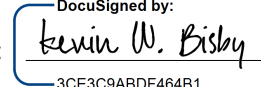
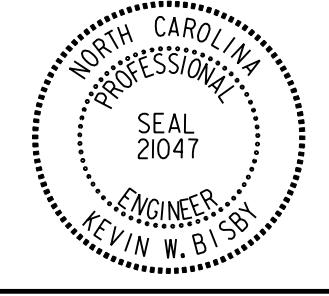
TIP NO. U-2412A	SHEET NO. SIGN-29
APPROVED:  3CE3C9ABDF44B1...	
DATE: 3/18/2018	
SEAL 	
DOCUMENT NOT CONSIDERED FINAL UNLESS ALL SIGNATURES COMPLETED	

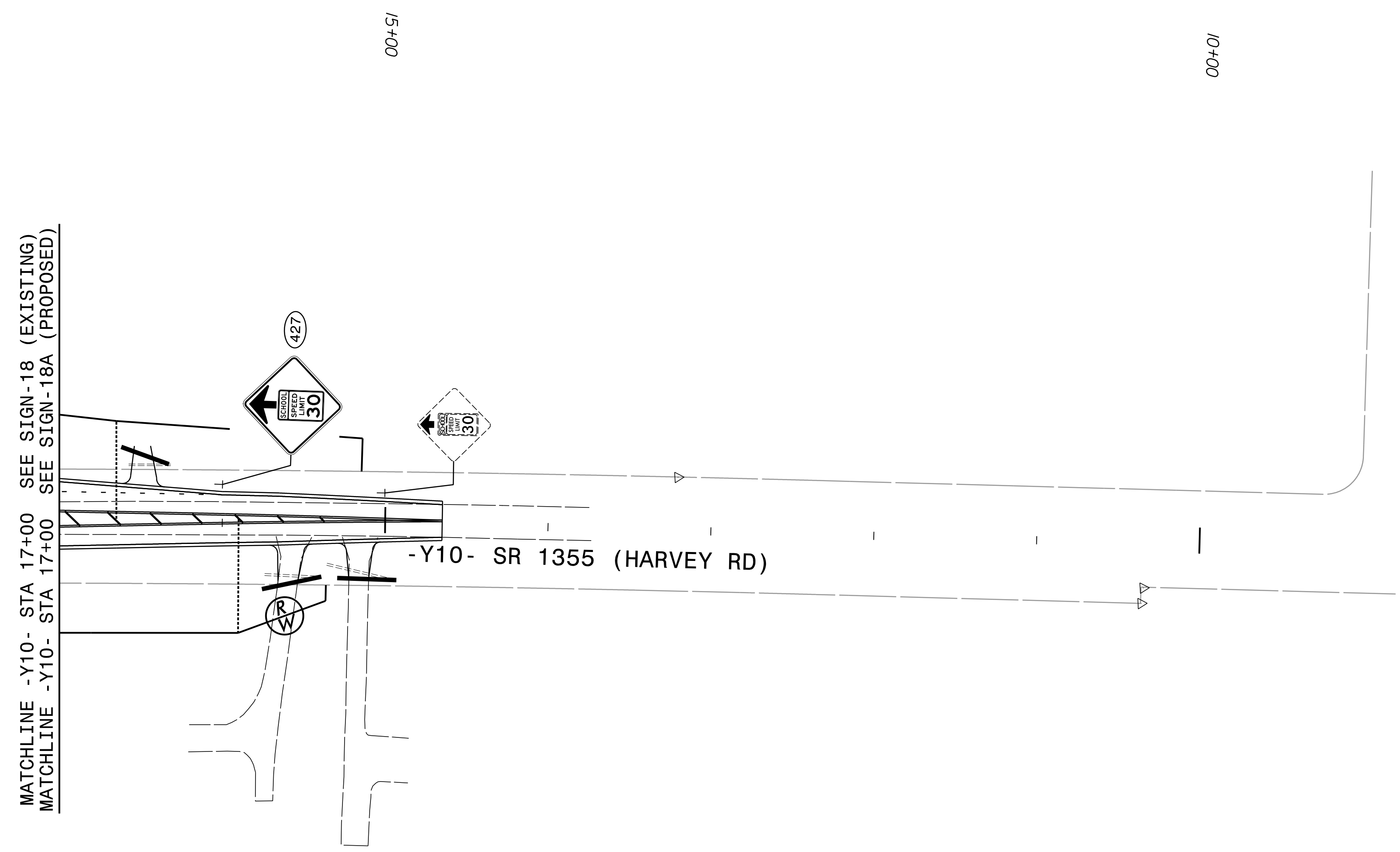

\$DATE\$
\$FILEL\$
EJH/ZMLH

PLANS PREPARED BY :

RK&K

RUMMEL, KLEPPER & KAHL, LLP
 900 RIDGEFIELD DRIVE SUITE 350
 RALEIGH, NORTH CAROLINA 27609-3960
 NC LICENSE NO. F-0112 (919) 878-9560

EXISTING and PROPOSED SIGNS

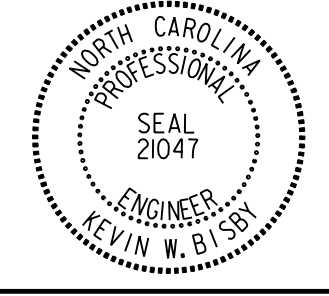
TIP NO. U-2412A	SHEET NO. SIGN-30
APPROVED: <i>Kevin W. Eshy</i> <small>DocuSigned by: 3CE3CMBDF464B1..</small>	
DATE: 3/18/2018	
SEAL 	
DOCUMENT NOT CONSIDERED FINAL UNLESS ALL SIGNATURES COMPLETED	

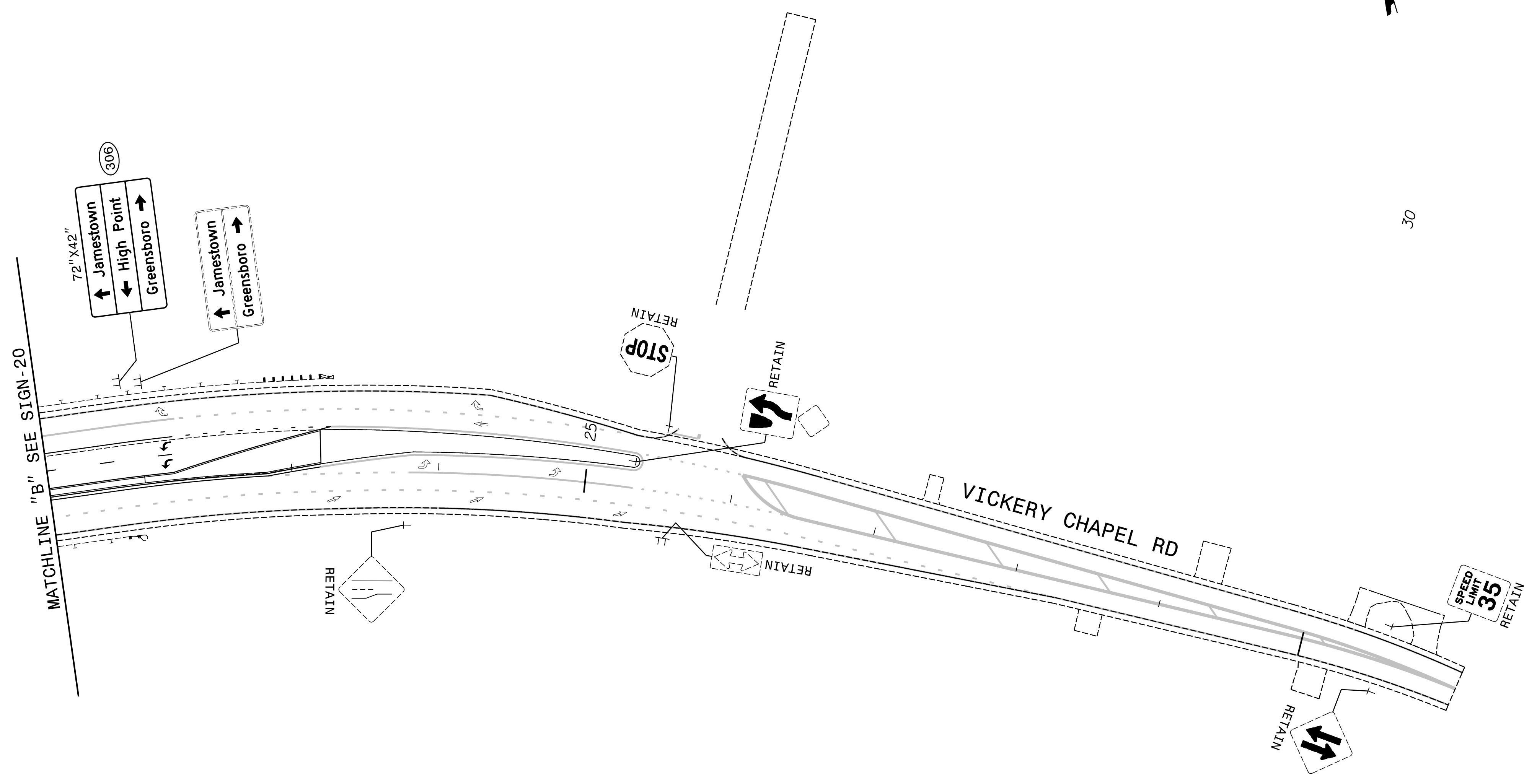
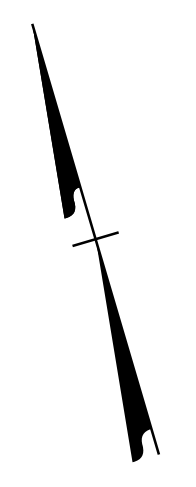

\$DATE\$
\$FILEL\$
EJH/ZMLH

PLANS PREPARED BY :
RK&K
 RUMMEL, KLEPPER & KAHL, LLP
 900 RIDGEFIELD DRIVE SUITE 350
 RALEIGH, NORTH CAROLINA 27609-3960
 NC LICENSE NO. F-0112 (919) 878-9560

EXISTING and PROPOSED SIGNS