

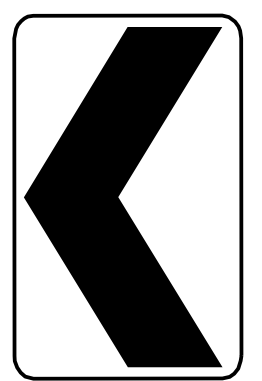









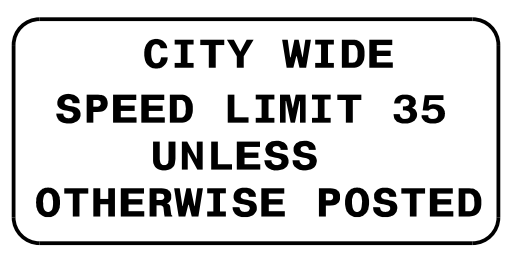



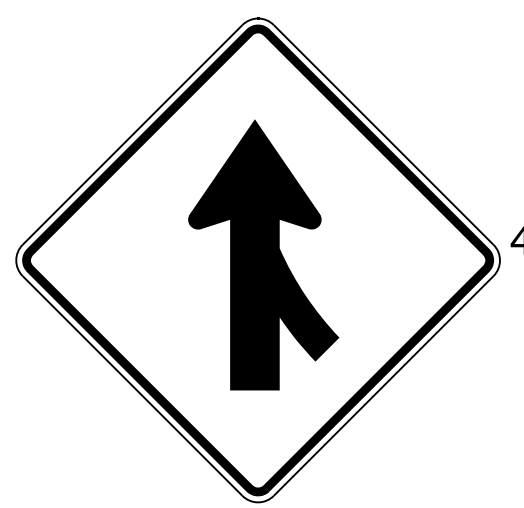
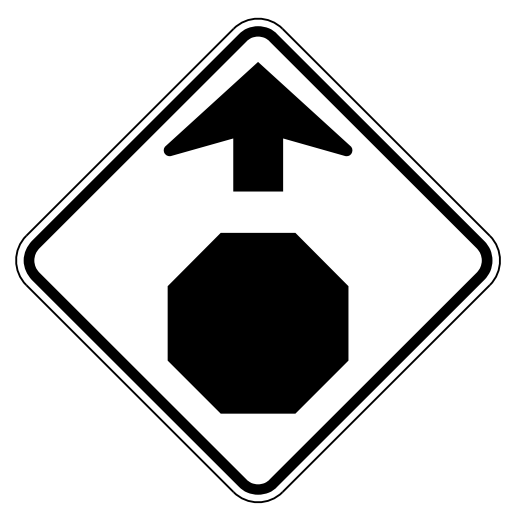



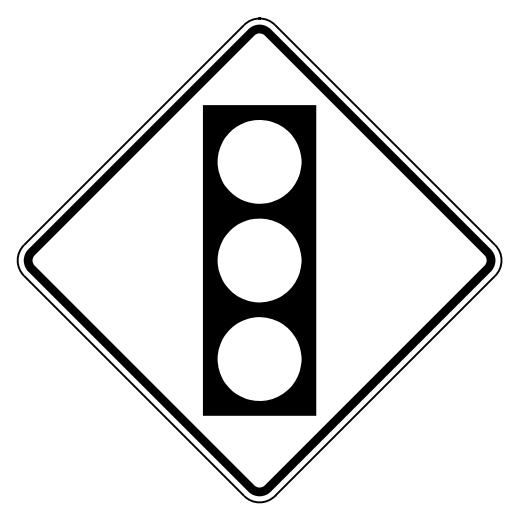

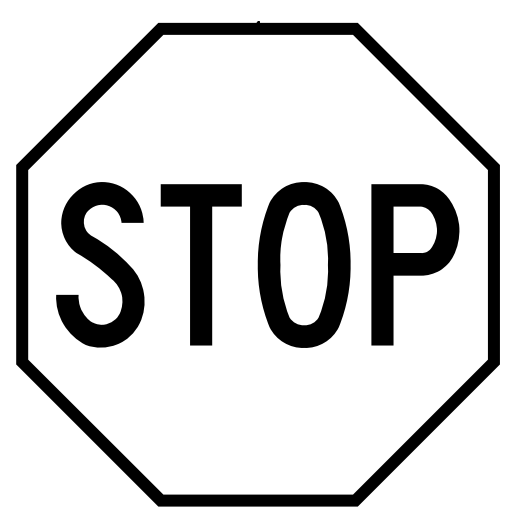

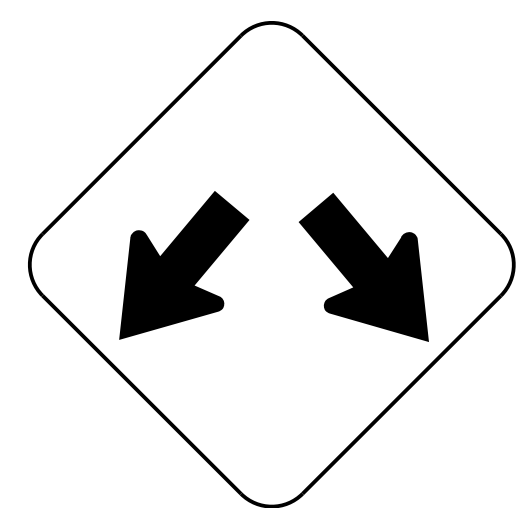
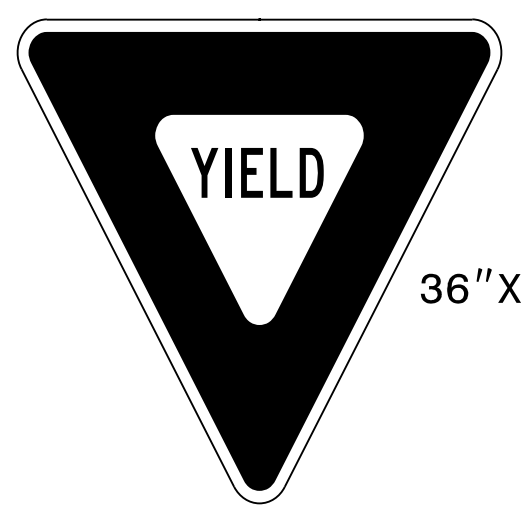

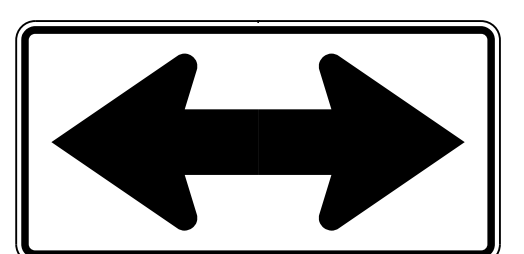
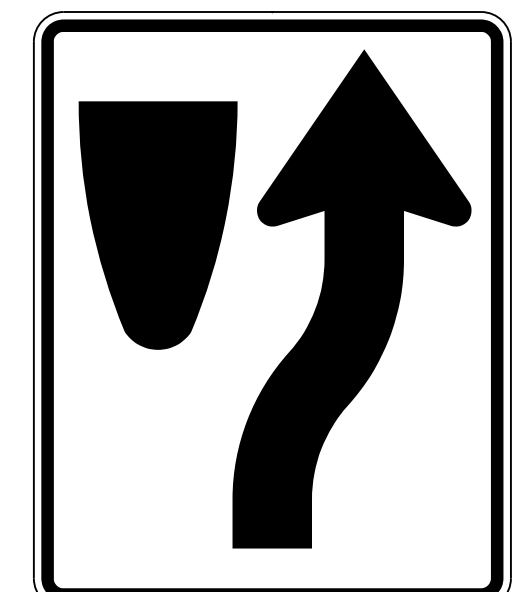

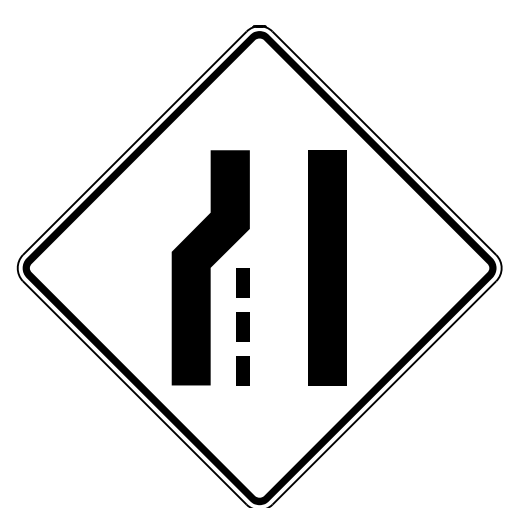
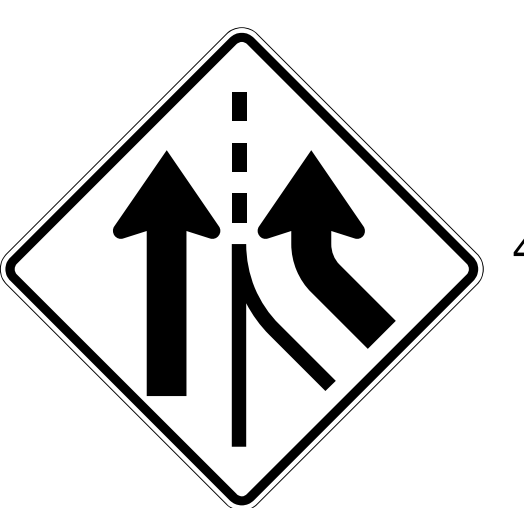
**This electronic collection of documents is provided  
for the convenience of the user  
and is Not a Certified Document –**

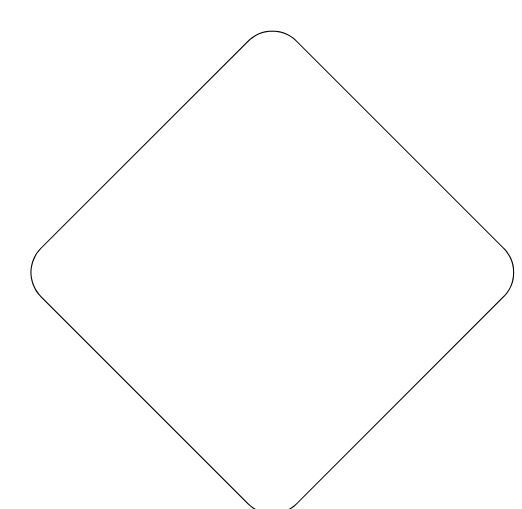
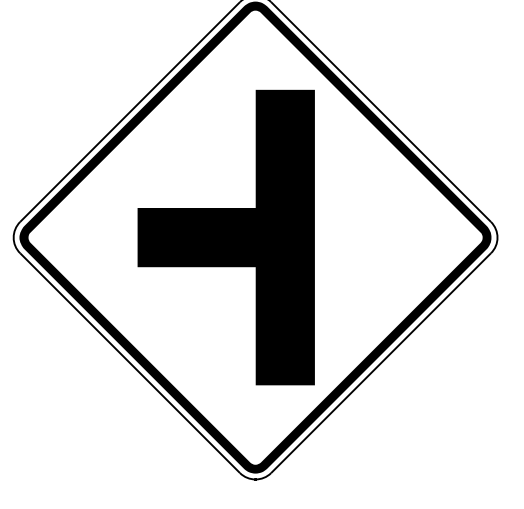

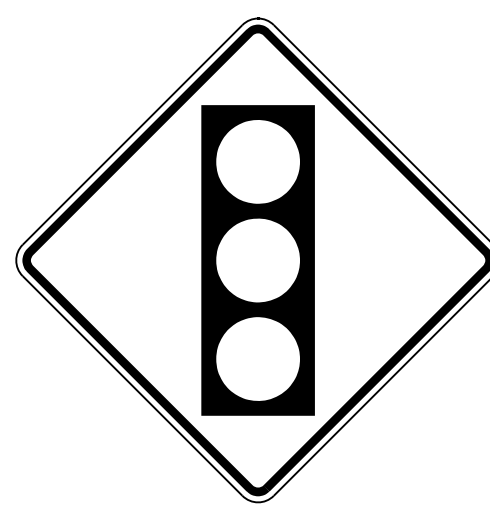

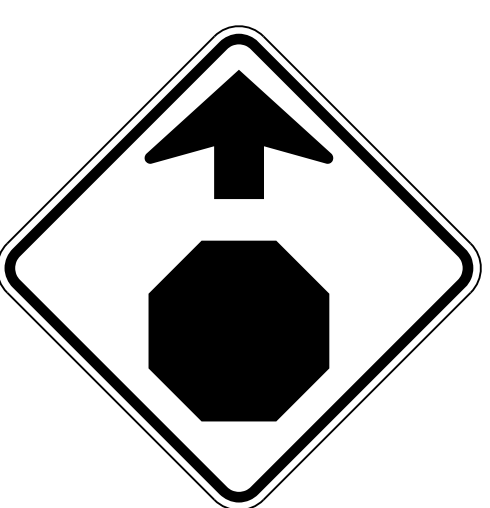

**The documents contained herein were originally issued  
and sealed by the individuals whose names and license  
numbers appear on each page, on the dates appearing  
with their signature on that page.**

**This file or an individual page  
shall not be considered a certified document.**

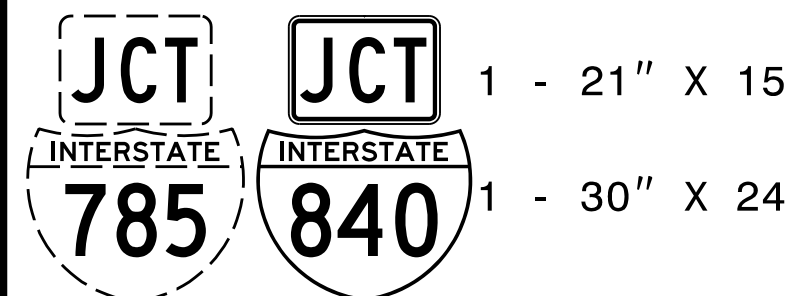
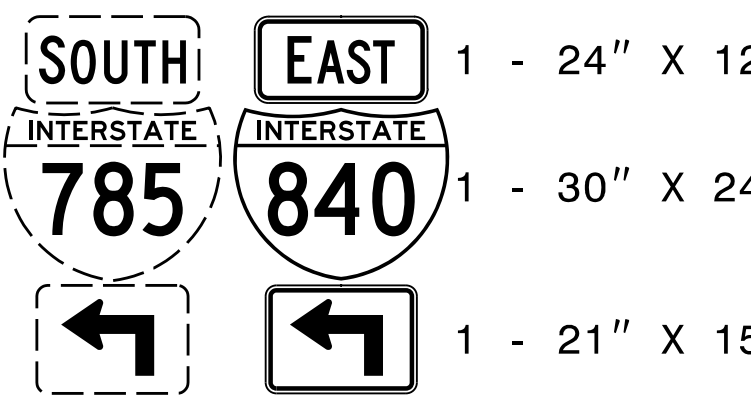
<p>401 QUANTITY REQ'D 13</p>  <p>30" X 36" W1-8 (L)</p> <p>INSTALL ON TWO U-POSTS PER SIGN IN 4 INSTALLATIONS INSTALL ON ONE BARRIER SUPPORT (LARGE) PER SIGN IN 9 INSTALLATIONS INSTALL 28 INCH HORIZONTAL CROSS BRACING LEAVING A 1 INCH MARGIN FROM LEFT AND RIGHT EDGES OF SIGN INSTALLATION HEIGHT: BOTTOM OF SIGN SHALL BE 4 FEET ABOVE THE EDGE OF TRAVEL LANE ELEVATION (RIGHT EDGE LINE OF RAMP) ALL OTHER PORTIONS OF ROADWAY STANDARD DRAWING 904.50 APPLY</p>	<p>410 QUANTITY REQ'D 12</p>  <p>36" X 24" R5-1a</p> <p>ONE "U" POST PER SIGN</p>	<p>415 QUANTITY REQ'D 1</p>  <p>42" X 30" R2-27</p> <p>TWO "U" POSTS PER SIGN</p>	<p>420 QUANTITY REQ'D 1</p>  <p>18" X 18" W13-1P</p> <p>MOUNT BELOW SIGN 419 IN 1 INSTALLATION</p>	<p>424 QUANTITY REQ'D 1</p>  <p>24" X 30" R2-1</p> <p>ONE "U" POST PER SIGN</p>	<p>TIP NO. U-2525C SHEET NO. SIGN-4CC</p> <p>APPROVED: <i>Charles A. Johnson, III</i> DATE: 12/14/2017</p> <p>SEAL</p>  <p>DOCUMENT NOT CONSIDERED FINAL UNLESS ALL SIGNATURES COMPLETED</p>	
<p>402 QUANTITY REQ'D 11</p>  <p>48" X 48" W4-1</p> <p>TWO "U" POSTS PER SIGN</p>	<p>406 QUANTITY REQ'D 2</p>  <p>30" X 30" W3-1</p> <p>ONE "U" POST PER SIGN</p>	<p>411 QUANTITY REQ'D 8</p>  <p>36" X 36" R5-1</p> <p>ONE "U" POST PER SIGN</p>	<p>416 QUANTITY REQ'D 1</p>  <p>30" X 30" W14-1</p> <p>ONE "U" POST PER SIGN</p>	<p>421 QUANTITY REQ'D 1</p>  <p>24" X 30" S5-2</p> <p>MOUNT BELOW SIGN 417 IN 1 INSTALLATION</p>	<p>425 QUANTITY REQ'D 1</p>  <p>48" X 48" W3-3</p> <p>TWO "U" POSTS PER SIGN</p>	<p>428 QUANTITY REQ'D 1</p>  <p>36" X 36" W9-1(R)</p> <p>ONE "U" POST PER SIGN</p>
<p>403 QUANTITY REQ'D 1</p>  <p>48" X 48" W1-2</p> <p>TWO "U" POSTS PER SIGN</p>	<p>407 QUANTITY REQ'D 7</p>  <p>36" X 36" R1-1</p> <p>ONE "U" POST PER SIGN</p>	<p>412 QUANTITY REQ'D 5</p>  <p>54" X 18" R6-1(R)</p> <p>TWO "U" POSTS PER SIGN</p>	<p>417 QUANTITY REQ'D 2</p>  <p>24" X 30" R2-1</p> <p>ONE "U" POST PER SIGN</p>	<p>422 QUANTITY REQ'D 3</p>  <p>36" X 36" W12-1</p> <p>ONE "U" POST PER SIGN</p>	<p>426 QUANTITY REQ'D 1</p>  <p>36" X 36" X 36" R1-2</p> <p>ONE "U" POST PER SIGN</p>	<p>429 QUANTITY REQ'D 1</p>  <p>30" X 18" W16-2aP</p> <p>MOUNT BELOW SIGN 428 IN 1 INSTALLATION</p>
<p>404 QUANTITY REQ'D 1</p>  <p>30" X 30" W13-1P</p> <p>MOUNT BELOW SIGN 403 IN 1 INSTALLATION</p>	<p>408 QUANTITY REQ'D 2</p>  <p>48" X 24" W1-7</p> <p>TWO "U" POSTS PER SIGN</p>	<p>413 QUANTITY REQ'D 17</p>  <p>24" X 30" R4-7(R)</p> <p>ONE "U" POST PER SIGN</p>	<p>418 QUANTITY REQ'D 2</p>  <p>36" X 36" R3-7(R)</p> <p>ONE "U" POST PER SIGN</p>	<p>423 QUANTITY REQ'D 2</p>  <p>30" X 36" R2-1</p> <p>ONE "U" POST PER SIGN</p>	<p>427 QUANTITY REQ'D 1</p>  <p>48" X 48" W4-2</p> <p>TWO "U" POSTS PER SIGN</p>	<p>430 QUANTITY REQ'D 1</p>  <p>48" X 48" W4-3(L)</p> <p>TWO "U" POSTS PER SIGN</p>
<p>405 QUANTITY REQ'D 1</p>  <p>30" X 30" W14-2</p> <p>ONE "U" POST PER SIGN</p>	<p>409 QUANTITY REQ'D 14</p>  <p>48" X 60" R2-1</p> <p>TWO "U" POSTS PER SIGN</p>	<p>414 QUANTITY REQ'D 11</p>  <p>18" X 18" OM1-3</p> <p>MOUNT BELOW SIGN 413 IN 11 INSTALLATIONS</p>	<p>419 QUANTITY REQ'D 1</p>  <p>30" X 30" W2-2 (L)</p> <p>ONE "U" POST PER SIGN</p>	<p><b>HNTB</b></p> <p>HNTB NORTH CAROLINA, P.C. 343 E. Six Forks Road, Suite 200 Raleigh, North Carolina 27609 NC License No: C-1554 (919) 546-8997</p>	<p><b>TYPE E SIGNS</b></p>	

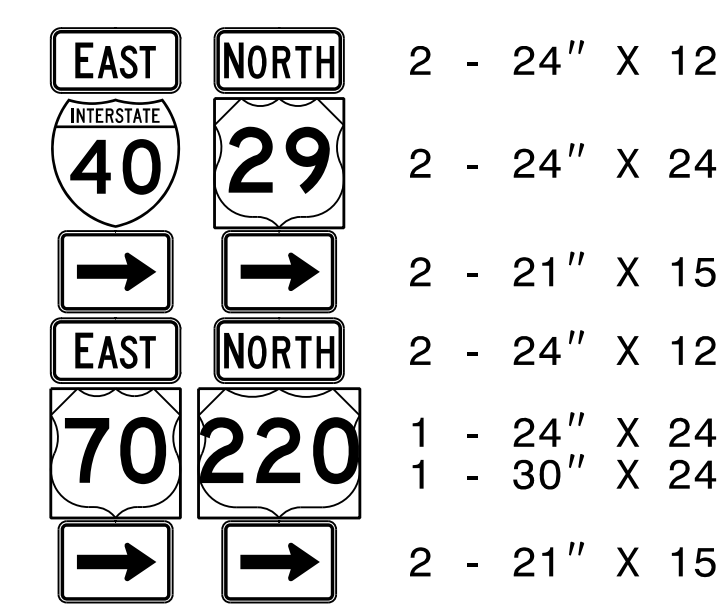
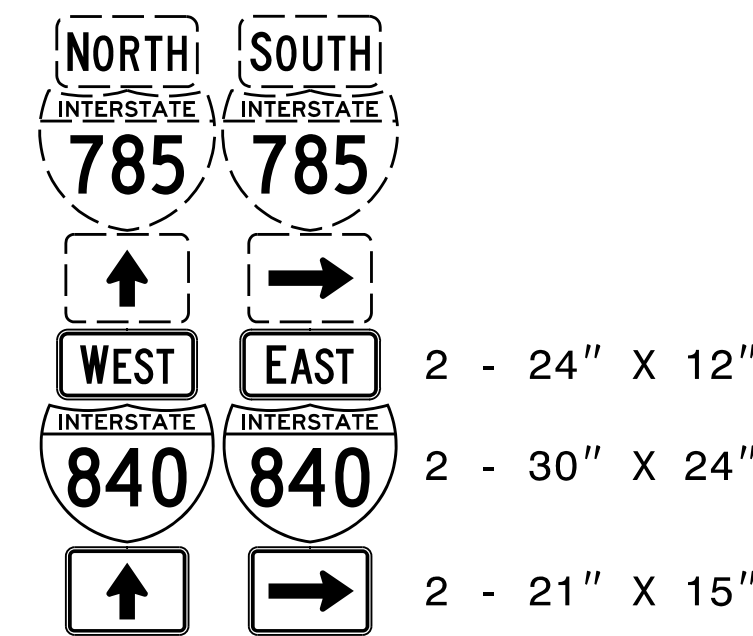
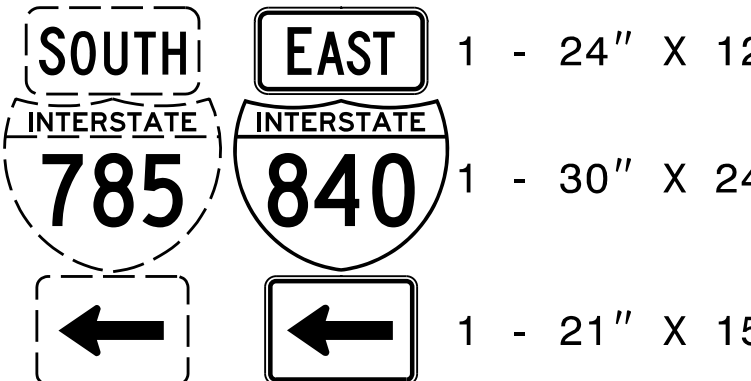
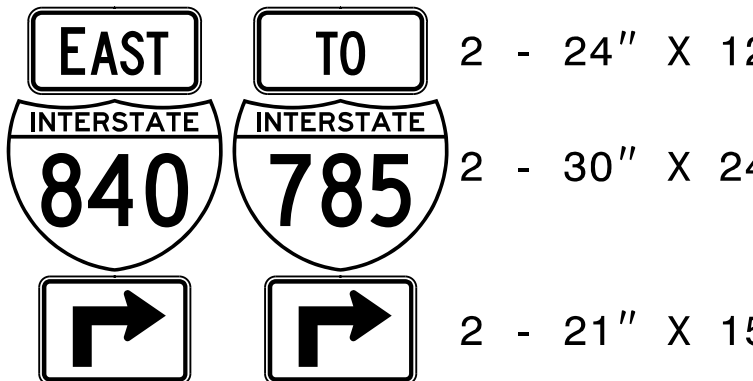
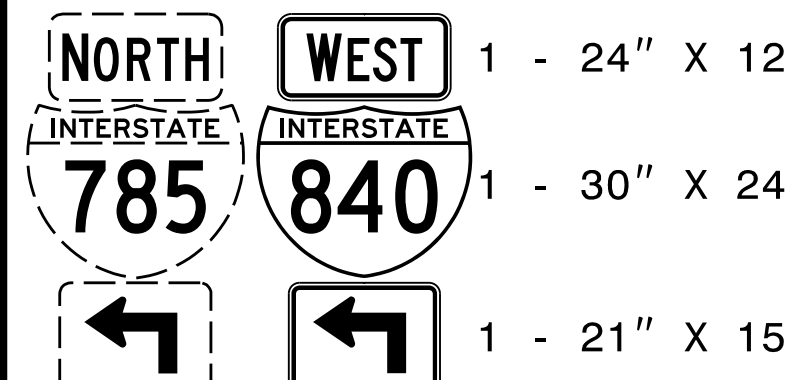
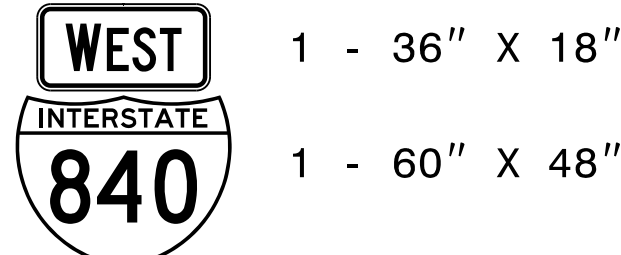

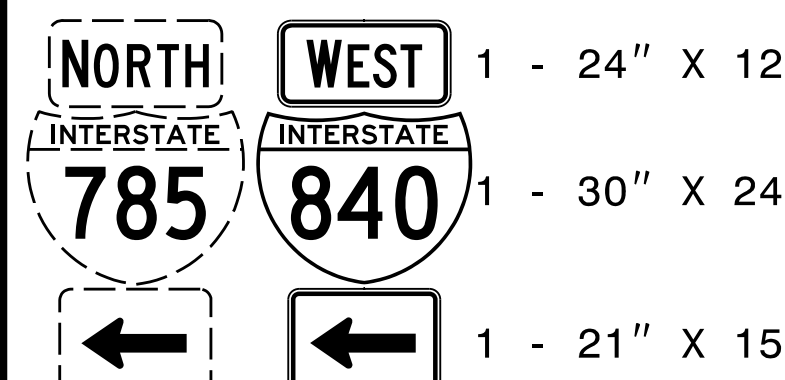
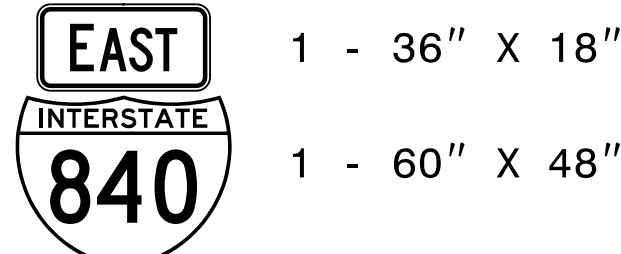

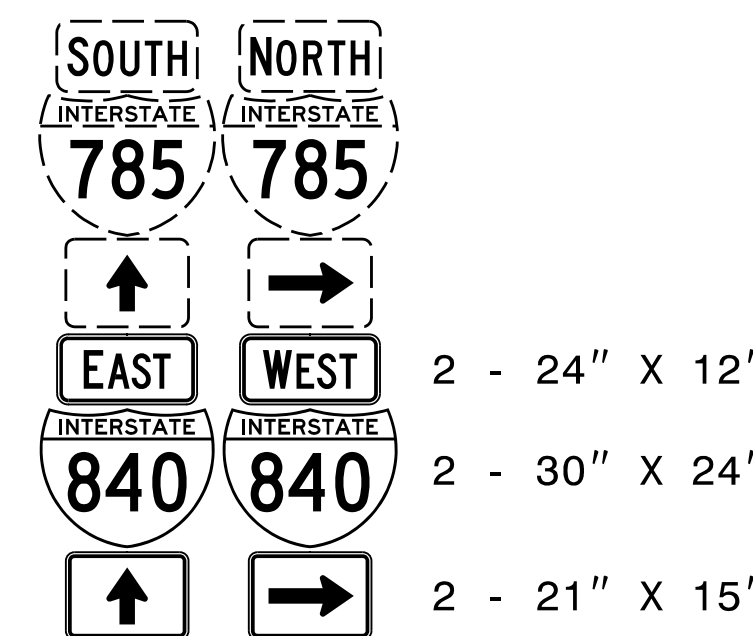
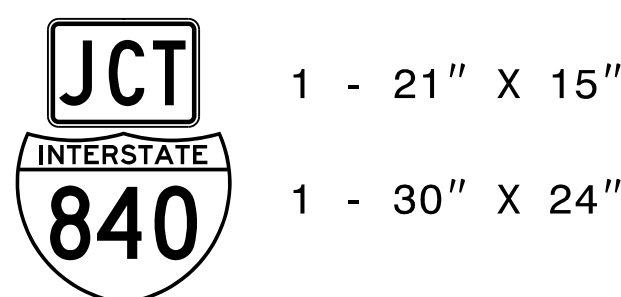
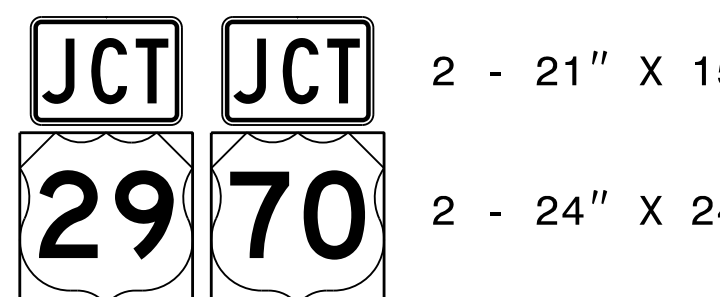

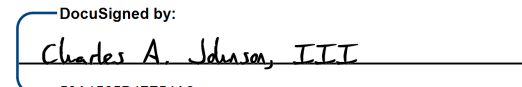
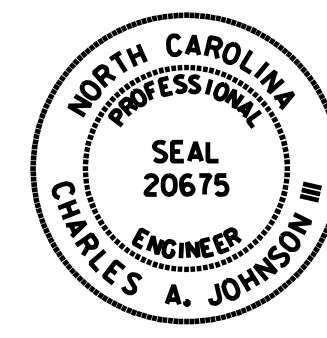



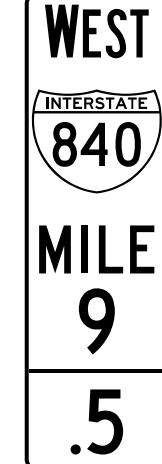















<p>(431) QUANTITY REQ'D 1</p>  <p>36" X 36" W3-5</p> <p>ONE "U" POST PER SIGN</p>					
<p>(432) QUANTITY REQ'D 1</p>  <p>36" X 36" W3-3</p> <p>ONE "U" POST PER SIGN</p>					
<p>(433) QUANTITY REQ'D 1</p>  <p>24" X 24" R5-2</p> <p>ONE "U" POST PER SIGN</p>					
<p>(434) QUANTITY REQ'D 1</p>  <p>48" X 48" W3-1</p> <p>TWO "U" POSTS PER SIGN</p>					

TIP NO. U-2525C	SHEET NO. SIGN-4DD
<small>DocuSigned by:</small> APPROVED: <u>Charles A. Johnson, III</u> <small>15A1565847F548E</small>	
DATE: 12/14/2017	
SEAL	
	
<b>DOCUMENT NOT CONSIDERED FINAL UNLESS ALL SIGNATURES COMPLETED</b>	

<p>501 505 523 525</p>  <p>1 - 21" X 15" 1 - 30" X 24"</p> <p>TWO "U" POSTS PER ASSEMBLY</p>	<p>507 524</p>  <p>1 - 24" X 12" 1 - 30" X 24" 1 - 21" X 15"</p> <p>TWO "U" POSTS PER ASSEMBLY</p>	<p>512 518</p>  <p>1 - 24" X 12" 1 - 30" X 24" 1 - 21" X 15"</p> <p>ONE "U" POST PER ASSEMBLY</p>	<p>531</p>  <p>2 - 24" X 12" 2 - 24" X 24" 2 - 21" X 15" 2 - 24" X 12" 1 - 24" X 24" 1 - 30" X 24" 2 - 21" X 15"</p> <p>TWO "U" POSTS PER ASSEMBLY</p>		
<p>502</p>  <p>2 - 24" X 12" 2 - 30" X 24" 2 - 21" X 15"</p> <p>TWO "U" POSTS PER ASSEMBLY</p>	<p>508</p>  <p>1 - 24" X 12" 1 - 30" X 24" 1 - 21" X 15"</p> <p>TWO "U" POSTS PER ASSEMBLY</p>	<p>514 520</p>  <p>2 - 24" X 12" 2 - 30" X 24" 2 - 21" X 15"</p> <p>TWO "U" POSTS PER ASSEMBLY</p>			
<p>503 526</p>  <p>1 - 24" X 12" 1 - 30" X 24" 1 - 21" X 15"</p> <p>TWO "U" POSTS PER ASSEMBLY</p>	<p>509 515 521</p>  <p>1 - 36" X 18" 1 - 60" X 48"</p> <p>TWO "U" POSTS PER ASSEMBLY</p>	<p>527 528</p>  <p>1 - 36" X 18" 1 - 48" X 48"</p> <p>TWO "U" POSTS PER ASSEMBLY</p>			
<p>504</p>  <p>1 - 24" X 12" 1 - 30" X 24" 1 - 21" X 15"</p> <p>TWO "U" POSTS PER ASSEMBLY</p>	<p>510 516 522</p>  <p>1 - 36" X 18" 1 - 60" X 48"</p> <p>TWO "U" POSTS PER ASSEMBLY</p>	<p>529</p>  <p>1 - 36" X 18" 1 - 48" X 48"</p> <p>TWO "U" POSTS PER ASSEMBLY</p>			
<p>506</p>  <p>2 - 24" X 12" 2 - 30" X 24" 2 - 21" X 15"</p> <p>TWO "U" POSTS PER ASSEMBLY</p>	<p>511 513 517 519</p>  <p>1 - 21" X 15" 1 - 30" X 24"</p> <p>ONE "U" POST PER ASSEMBLY</p>	<p>530</p>  <p>2 - 21" X 15" 2 - 24" X 24"</p> <p>TWO "U" POSTS PER ASSEMBLY</p>			

TIP NO. U-2525C	SHEET NO. SIGN-4EE
APPROVED:  <small>DocuSigned by: Charles A. Johnson, III 55A1952047F5A6B...</small>	
DATE: 12/14/2017	
SEAL	
	
<b>DOCUMENT NOT CONSIDERED FINAL UNLESS ALL SIGNATURES COMPLETED</b>	

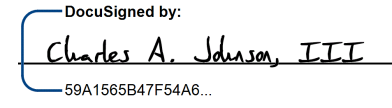
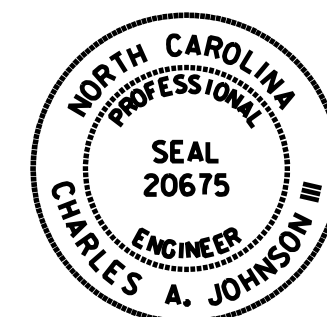

<p>QUANTITY REQ'D 1</p>  <p>18" X 60" D10-5</p> <p>ONE "U" POST PER SIGN</p>	<p>QUANTITY REQ'D 1</p>  <p>18" X 60" D10-5</p> <p>ONE "U" POST PER SIGN</p>	<p>QUANTITY REQ'D 1</p>  <p>18" X 54" D10-4</p> <p>ONE "U" POST PER SIGN</p>	<p>QUANTITY REQ'D 1</p>  <p>18" X 54" D10-4</p> <p>ONE "U" POST PER SIGN</p>	<p>QUANTITY REQ'D 1</p>  <p>18" X 54" D10-4</p> <p>ONE "U" POST PER SIGN</p>	<p>QUANTITY REQ'D 1</p>  <p>18" X 54" D10-4</p> <p>ONE "U" POST PER SIGN</p>
<p>QUANTITY REQ'D 1</p>  <p>18" X 60" D10-5</p> <p>ONE "U" POST PER SIGN</p>	<p>QUANTITY REQ'D 1</p>  <p>18" X 54" D10-4</p> <p>ONE "U" POST PER SIGN</p>	<p>QUANTITY REQ'D 1</p>  <p>18" X 54" D10-4</p> <p>ONE "U" POST PER SIGN</p>	<p>QUANTITY REQ'D 1</p>  <p>18" X 60" D10-5</p> <p>ONE "U" POST PER SIGN</p>	<p>QUANTITY REQ'D 1</p>  <p>18" X 60" D10-5</p> <p>ONE "U" POST PER SIGN</p>	<p>QUANTITY REQ'D 1</p>  <p>18" X 60" D10-5</p> <p>ONE "U" POST PER SIGN</p>
<p>QUANTITY REQ'D 1</p>  <p>18" X 54" D10-4</p> <p>ONE "U" POST PER SIGN</p>	<p>QUANTITY REQ'D 1</p>  <p>18" X 54" D10-4</p> <p>ONE "U" POST PER SIGN</p>	<p>QUANTITY REQ'D 1</p>  <p>18" X 60" D10-5</p> <p>ONE "U" POST PER SIGN</p>	<p>QUANTITY REQ'D 1</p>  <p>18" X 60" D10-5</p> <p>ONE "U" POST PER SIGN</p>	<p>QUANTITY REQ'D 1</p>  <p>18" X 60" D10-5</p> <p>ONE "U" POST PER SIGN</p>	<p>QUANTITY REQ'D 1</p>  <p>18" X 60" D10-5</p> <p>ONE "U" POST PER SIGN</p>
<p>QUANTITY REQ'D 1</p>  <p>18" X 54" D10-4</p> <p>ONE "U" POST PER SIGN</p>	<p>QUANTITY REQ'D 1</p>  <p>18" X 60" D10-5</p> <p>ONE "U" POST PER SIGN</p>	<p>QUANTITY REQ'D 1</p>  <p>18" X 60" D10-5</p> <p>ONE "U" POST PER SIGN</p>	<p>QUANTITY REQ'D 1</p>  <p>18" X 54" D10-4</p> <p>ONE "U" POST PER SIGN</p>	<p>QUANTITY REQ'D 1</p>  <p>18" X 54" D10-4</p> <p>ONE "U" POST PER SIGN</p>	<p>QUANTITY REQ'D 1</p>  <p>18" X 54" D10-4</p> <p>ONE "U" POST PER SIGN</p>
<p>QUANTITY REQ'D 1</p>  <p>18" X 60" D10-5</p> <p>ONE "U" POST PER SIGN</p>	<p>QUANTITY REQ'D 1</p>  <p>18" X 60" D10-5</p> <p>ONE "U" POST PER SIGN</p>	<p>QUANTITY REQ'D 1</p>  <p>18" X 54" D10-4</p> <p>ONE "U" POST PER SIGN</p>			

TIP NO. U-2525C	SHEET NO. SIGN-4FF
APPROVED:  <small>DocuSigned by: Charles A. Johnson, III 19A156847F548E</small>	
DATE: 12/14/2017	
	
<b>DOCUMENT NOT CONSIDERED FINAL UNLESS ALL SIGNATURES COMPLETED</b>	

**MILEMARKERS**

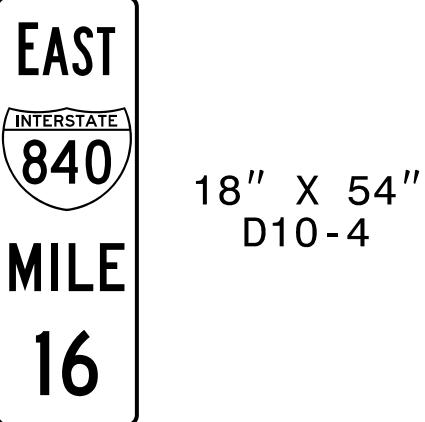
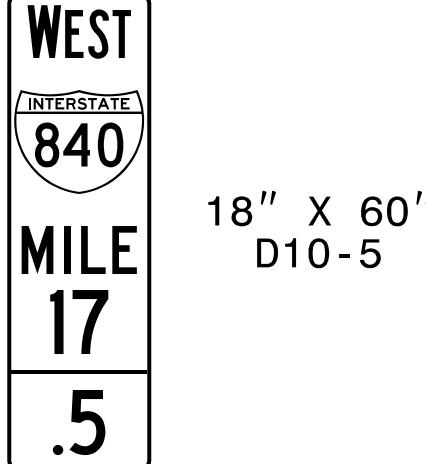
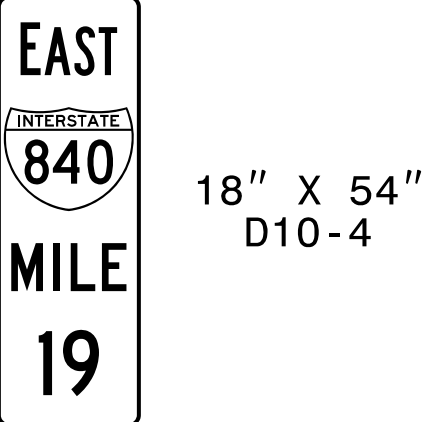
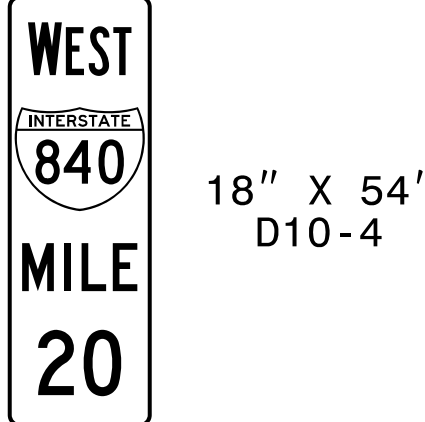
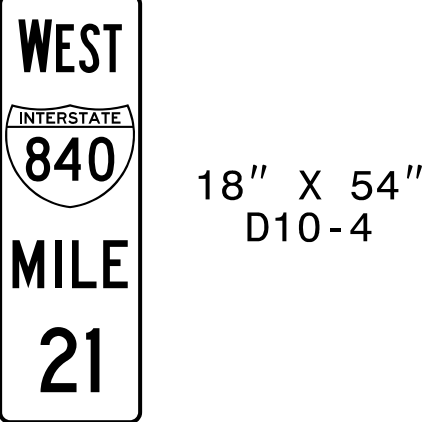
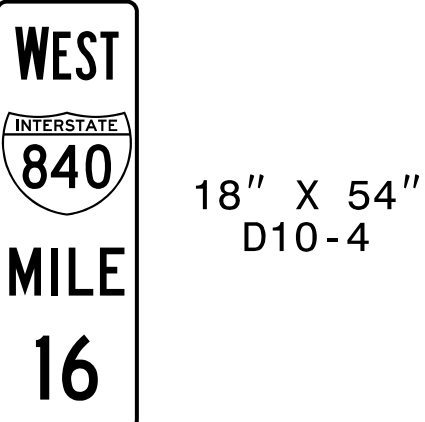
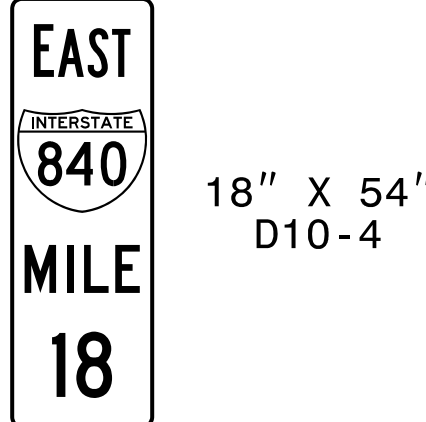
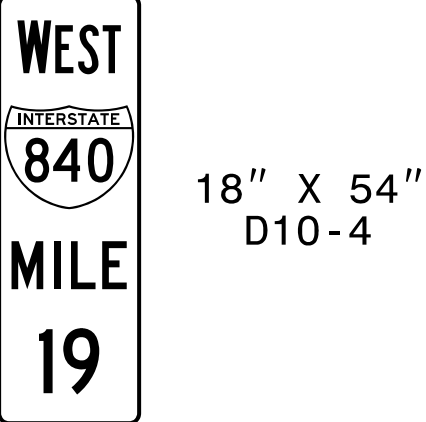
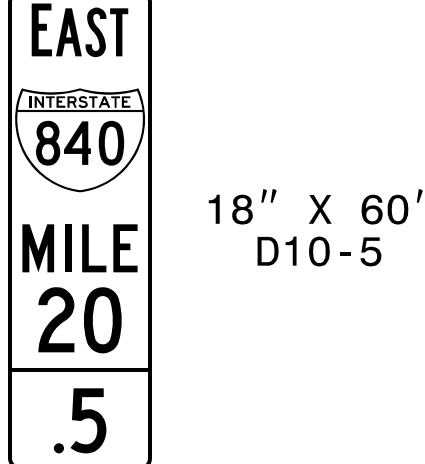
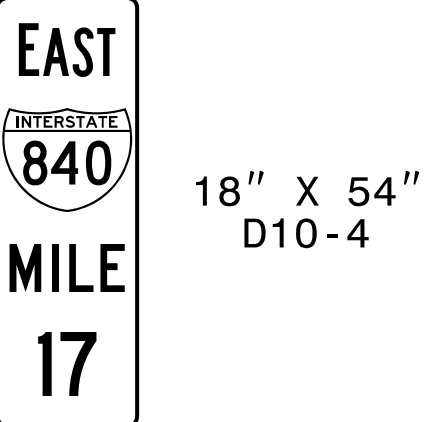
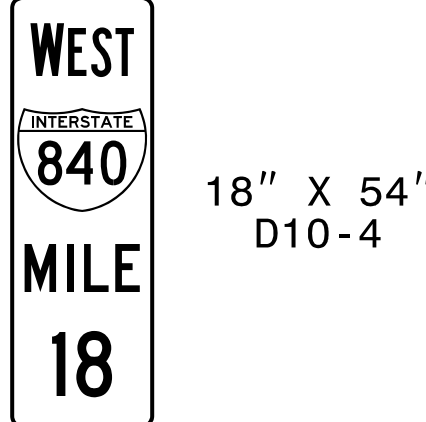
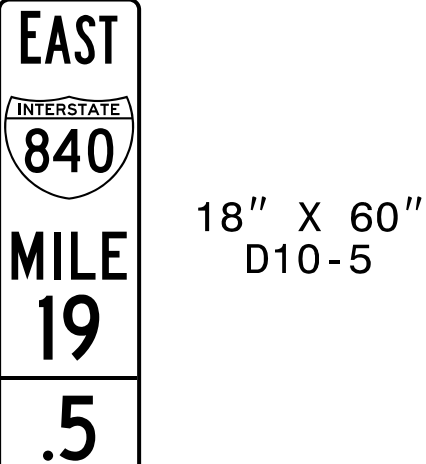
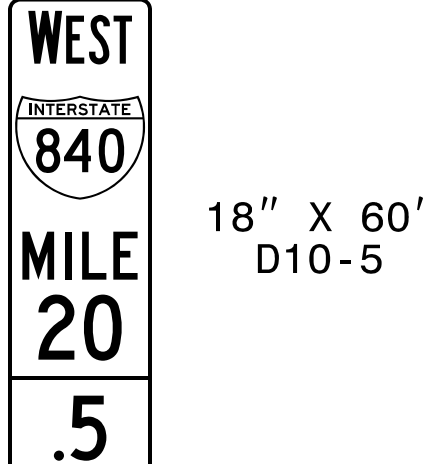
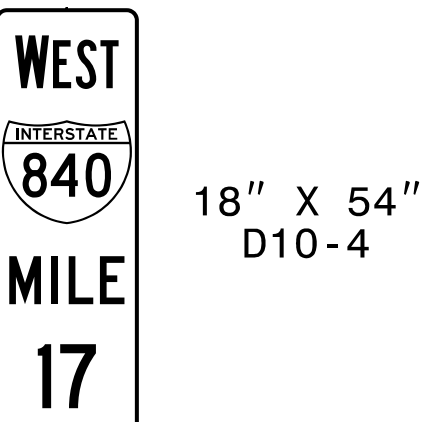
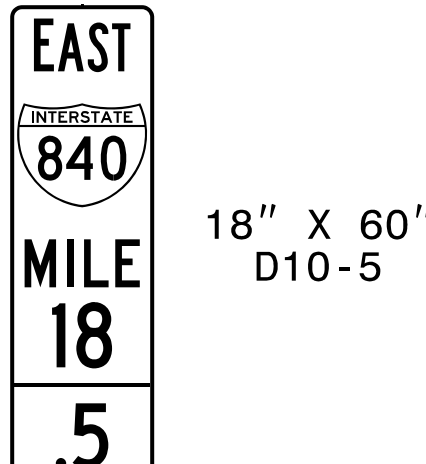
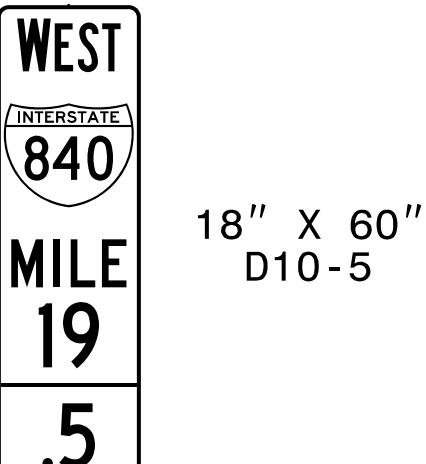
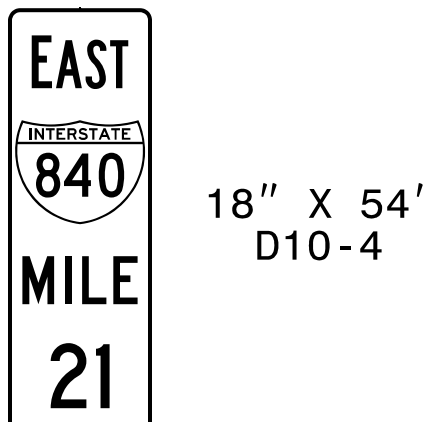
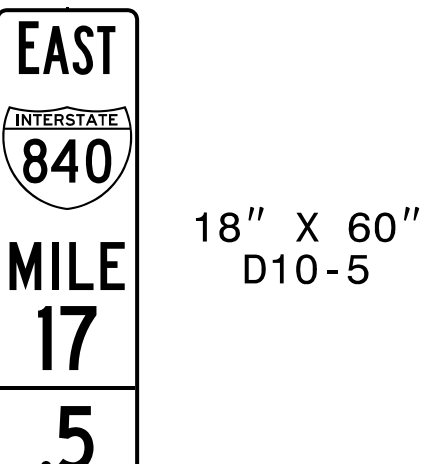
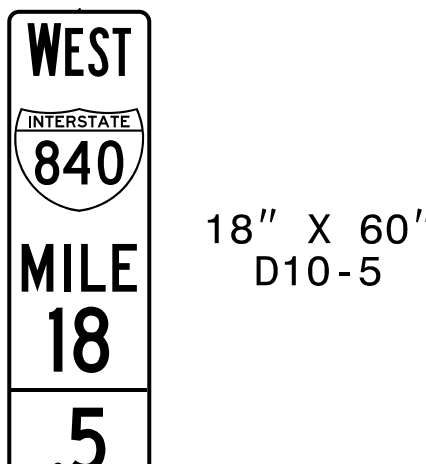
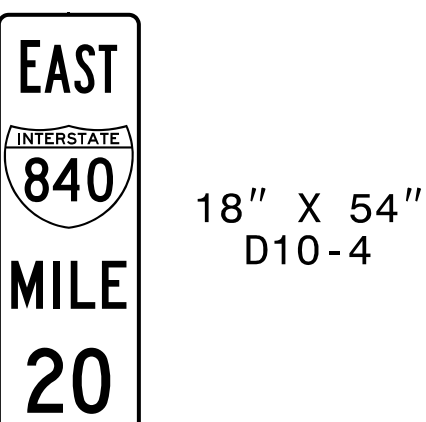
<p>QUANTITY REQ'D 1</p>  <p>18" X 54" D10-4</p> <p>ONE "U" POST PER SIGN</p>	<p>QUANTITY REQ'D 1</p>  <p>18" X 60" D10-5</p> <p>ONE "U" POST PER SIGN</p>	<p>QUANTITY REQ'D 1</p>  <p>18" X 54" D10-4</p> <p>ONE "U" POST PER SIGN</p>	<p>QUANTITY REQ'D 1</p>  <p>18" X 54" D10-4</p> <p>ONE "U" POST PER SIGN</p>	<p>QUANTITY REQ'D 1</p>  <p>18" X 54" D10-4</p> <p>ONE "U" POST PER SIGN</p>		
<p>QUANTITY REQ'D 1</p>  <p>18" X 54" D10-4</p> <p>ONE "U" POST PER SIGN</p>	<p>QUANTITY REQ'D 1</p>  <p>18" X 54" D10-4</p> <p>ONE "U" POST PER SIGN</p>	<p>QUANTITY REQ'D 1</p>  <p>18" X 54" D10-4</p> <p>ONE "U" POST PER SIGN</p>	<p>QUANTITY REQ'D 1</p>  <p>18" X 60" D10-5</p> <p>ONE "U" POST PER SIGN</p>			
<p>QUANTITY REQ'D 1</p>  <p>18" X 54" D10-4</p> <p>ONE "U" POST PER SIGN</p>	<p>QUANTITY REQ'D 1</p>  <p>18" X 54" D10-4</p> <p>ONE "U" POST PER SIGN</p>	<p>QUANTITY REQ'D 1</p>  <p>18" X 60" D10-5</p> <p>ONE "U" POST PER SIGN</p>	<p>QUANTITY REQ'D 1</p>  <p>18" X 60" D10-5</p> <p>ONE "U" POST PER SIGN</p>			
<p>QUANTITY REQ'D 1</p>  <p>18" X 54" D10-4</p> <p>ONE "U" POST PER SIGN</p>	<p>QUANTITY REQ'D 1</p>  <p>18" X 60" D10-5</p> <p>ONE "U" POST PER SIGN</p>	<p>QUANTITY REQ'D 1</p>  <p>18" X 60" D10-5</p> <p>ONE "U" POST PER SIGN</p>	<p>QUANTITY REQ'D 1</p>  <p>18" X 54" D10-4</p> <p>ONE "U" POST PER SIGN</p>			
<p>QUANTITY REQ'D 1</p>  <p>18" X 60" D10-5</p> <p>ONE "U" POST PER SIGN</p>	<p>QUANTITY REQ'D 1</p>  <p>18" X 60" D10-5</p> <p>ONE "U" POST PER SIGN</p>	<p>QUANTITY REQ'D 1</p>  <p>18" X 54" D10-4</p> <p>ONE "U" POST PER SIGN</p>				

TIP NO. U-2525C	SHEET NO. SIGN-4GG
APPROVED: <u>Charles A. Johnson, III</u> <small>15A156847F548E</small>	
DATE: 12/14/2017	
SEAL	
	
DOCUMENT NOT CONSIDERED FINAL UNLESS ALL SIGNATURES COMPLETED	

MILEMARKERS

TIP NO. U-2525C	SHEET NO. SIGN-5
APPROVED: <i>Charles A. Johnson, III</i> <small>SEA156284775446</small>	
DATE: 12/14/2017	
SEAL	
	
DOCUMENT NOT CONSIDERED FINAL UNLESS ALL SIGNATURES COMPLETED	

SIGN 6001

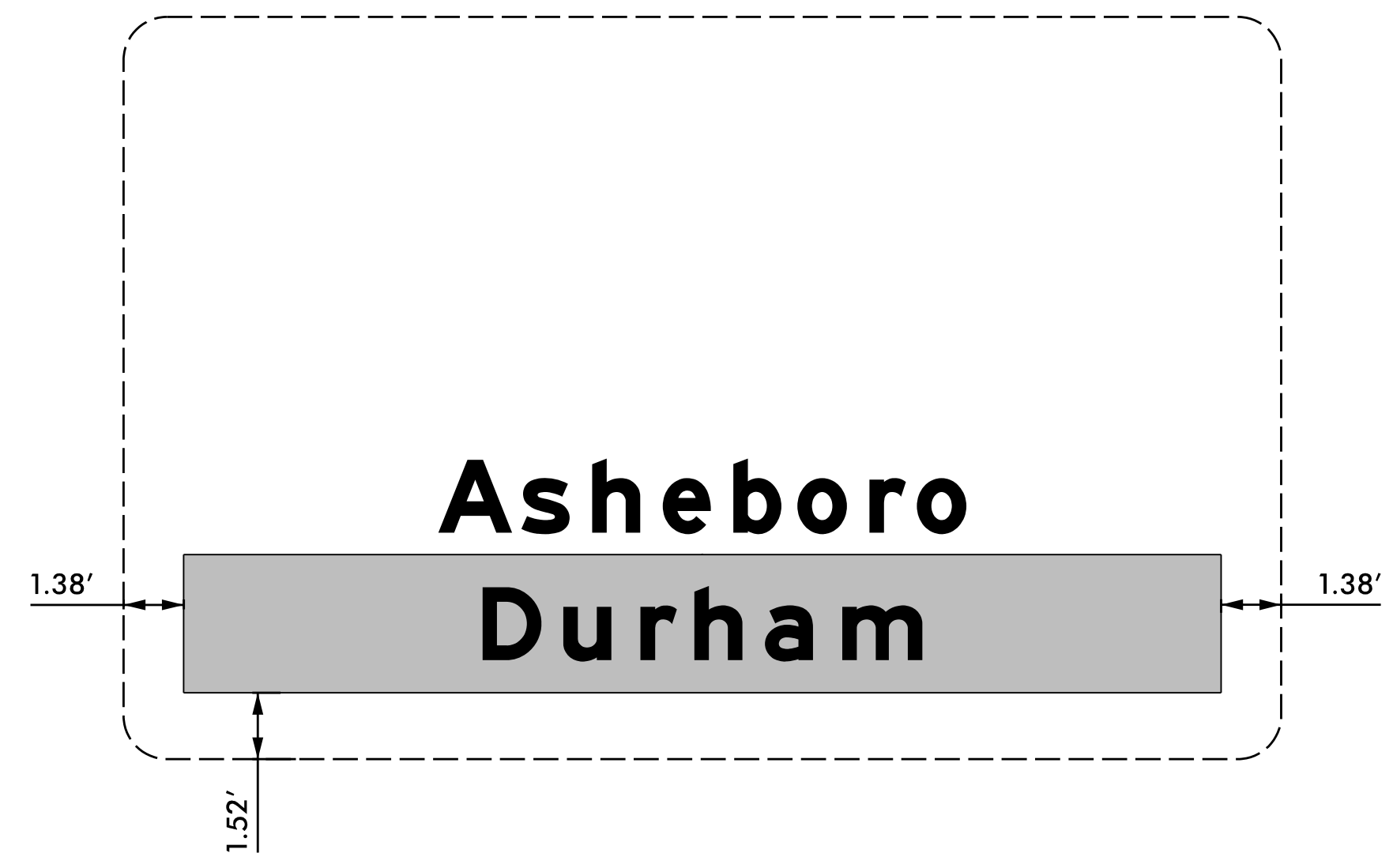

SIGNS 6002, 6003

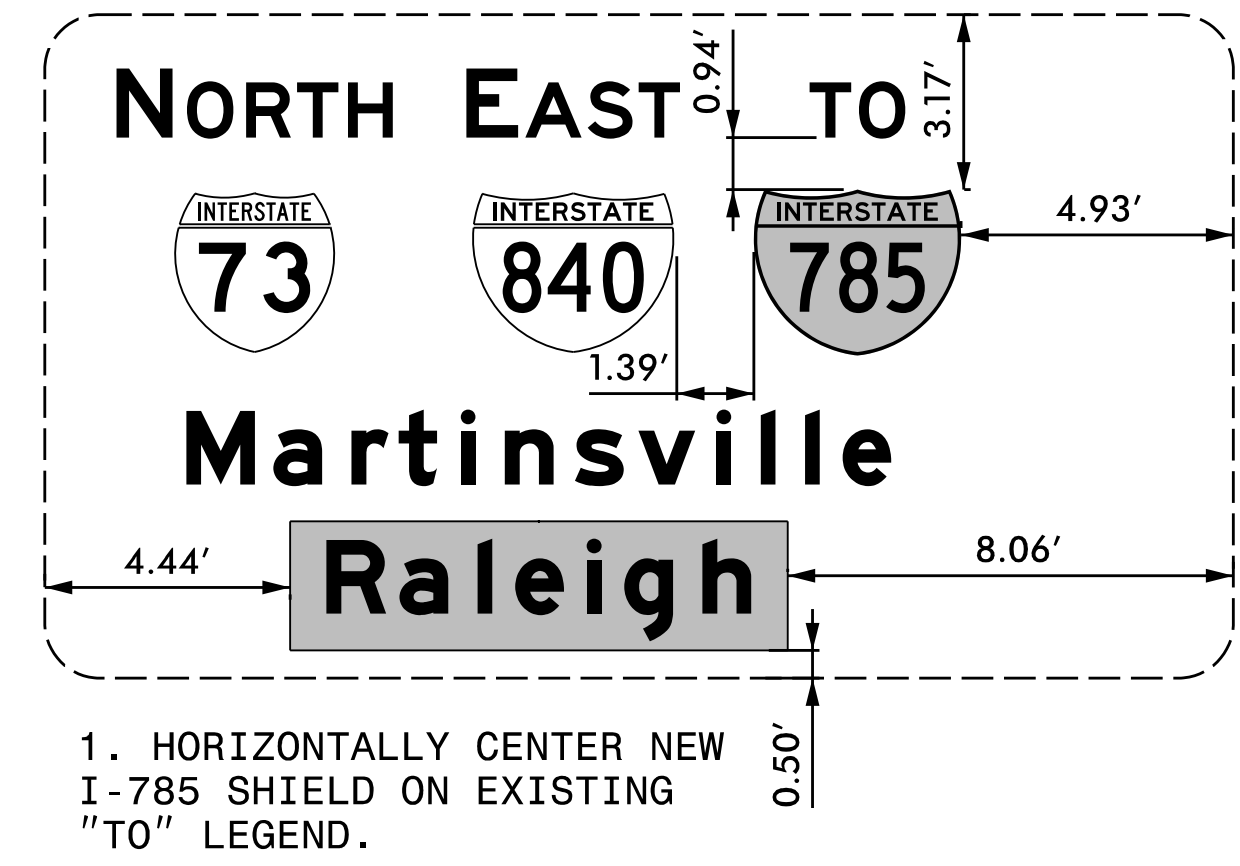

1. HORIZONTALLY CENTER NEW I-785 SHIELD ON EXISTING "TO" LEGEND.
2. VERTICALLY CENTER NEW I-785 SHIELD ON EXISTING I-840 SHIELD.

SIGNS 6004, 6005

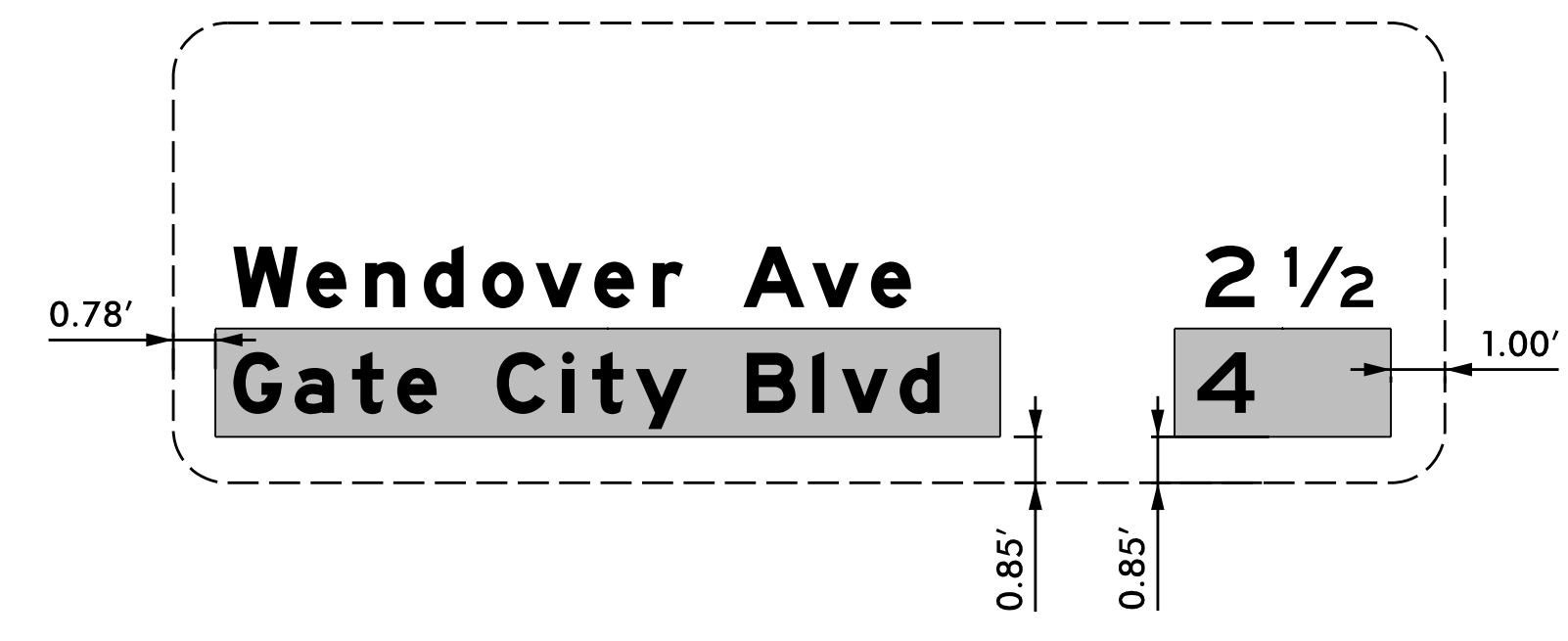

SIGNS 6006, 6007

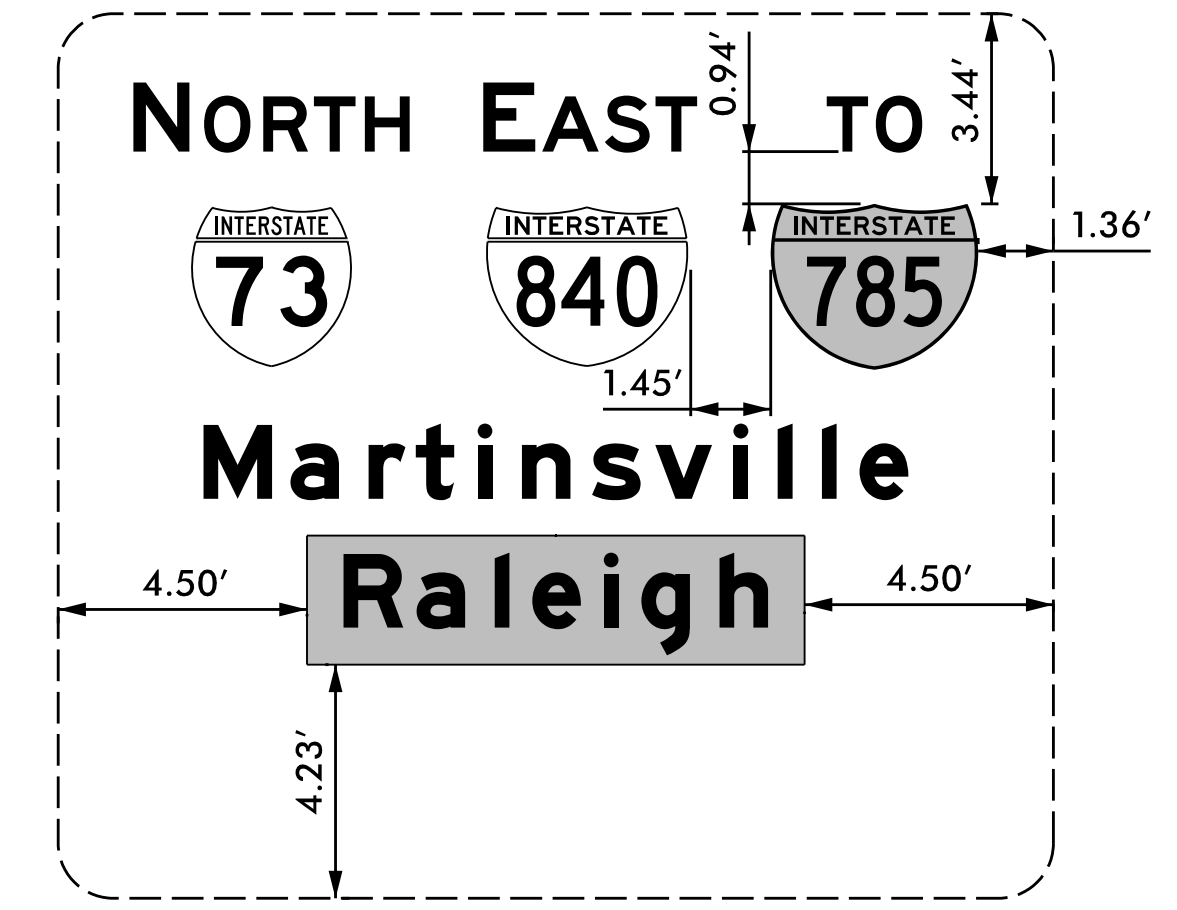

1. HORIZONTALLY CENTER NEW I-785 SHIELD ON EXISTING "TO" LEGEND.
2. VERTICALLY CENTER NEW I-785 SHIELD ON EXISTING I-840 SHIELD.

TIP NO. U-2525C	SHEET NO. SIGN-5A
APPROVED: <i>Charles A. Johnson, III</i> <small>—SRA156504775446—</small>	
DATE: 12/14/2017	
SEAL	
	
DOCUMENT NOT CONSIDERED FINAL UNLESS ALL SIGNATURES COMPLETED	

SIGNS 6008,6009,6010,6011

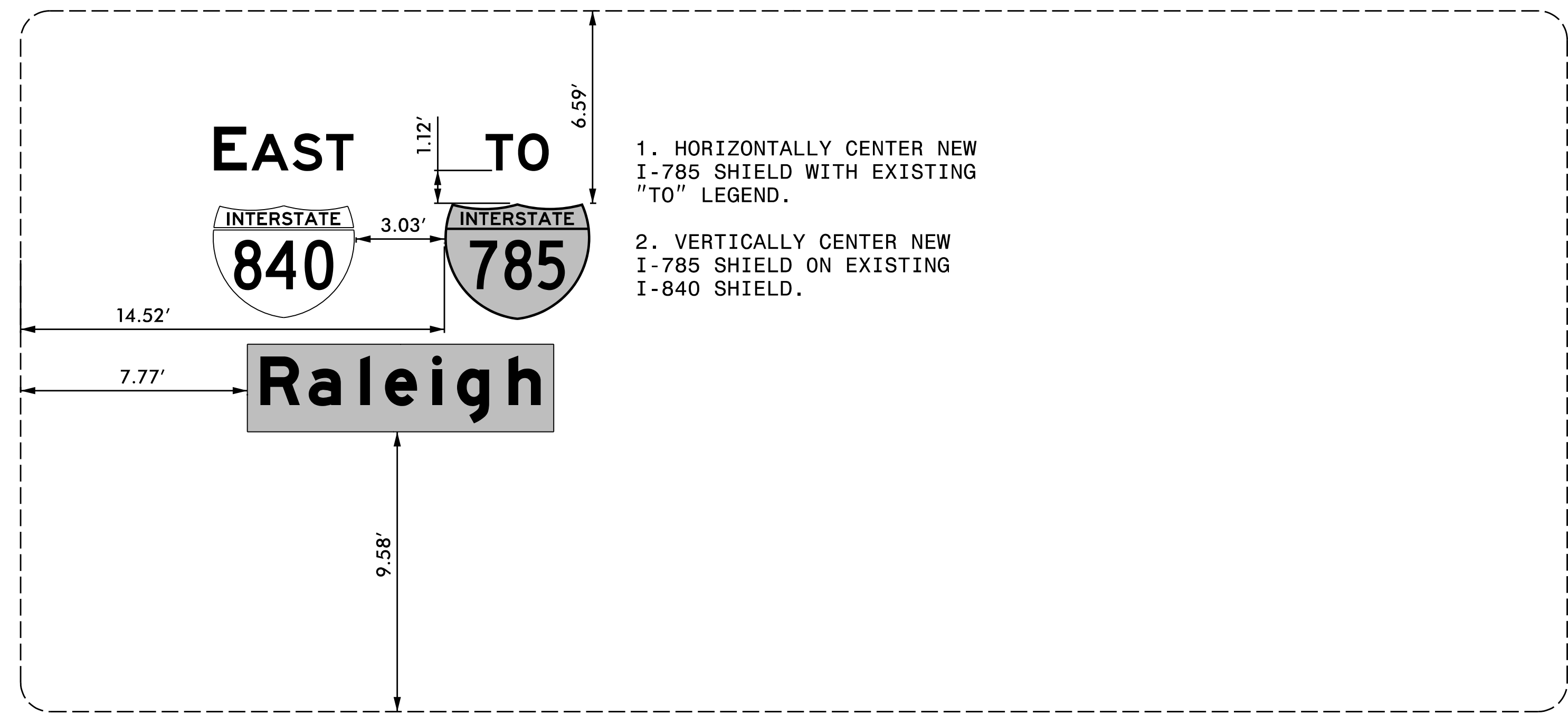

SIGN 6014

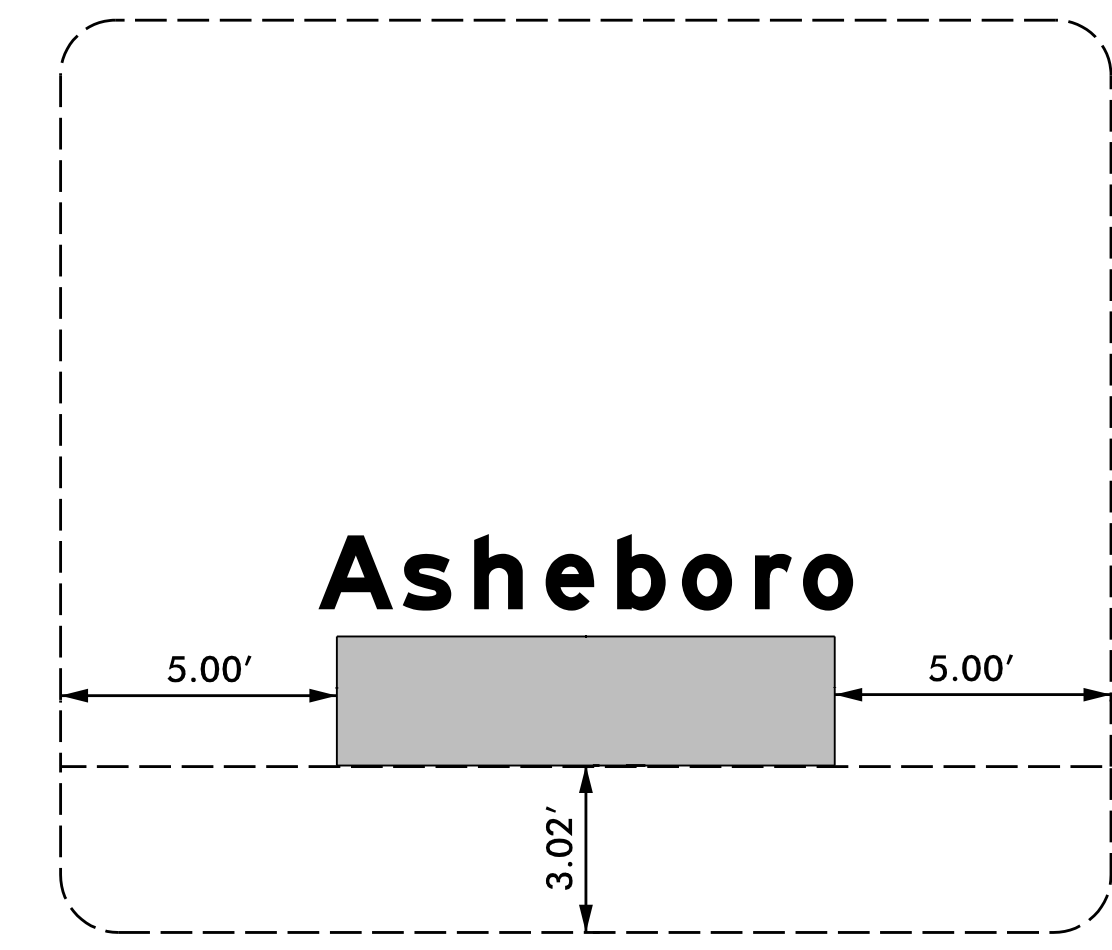

SIGNS 6015,6016

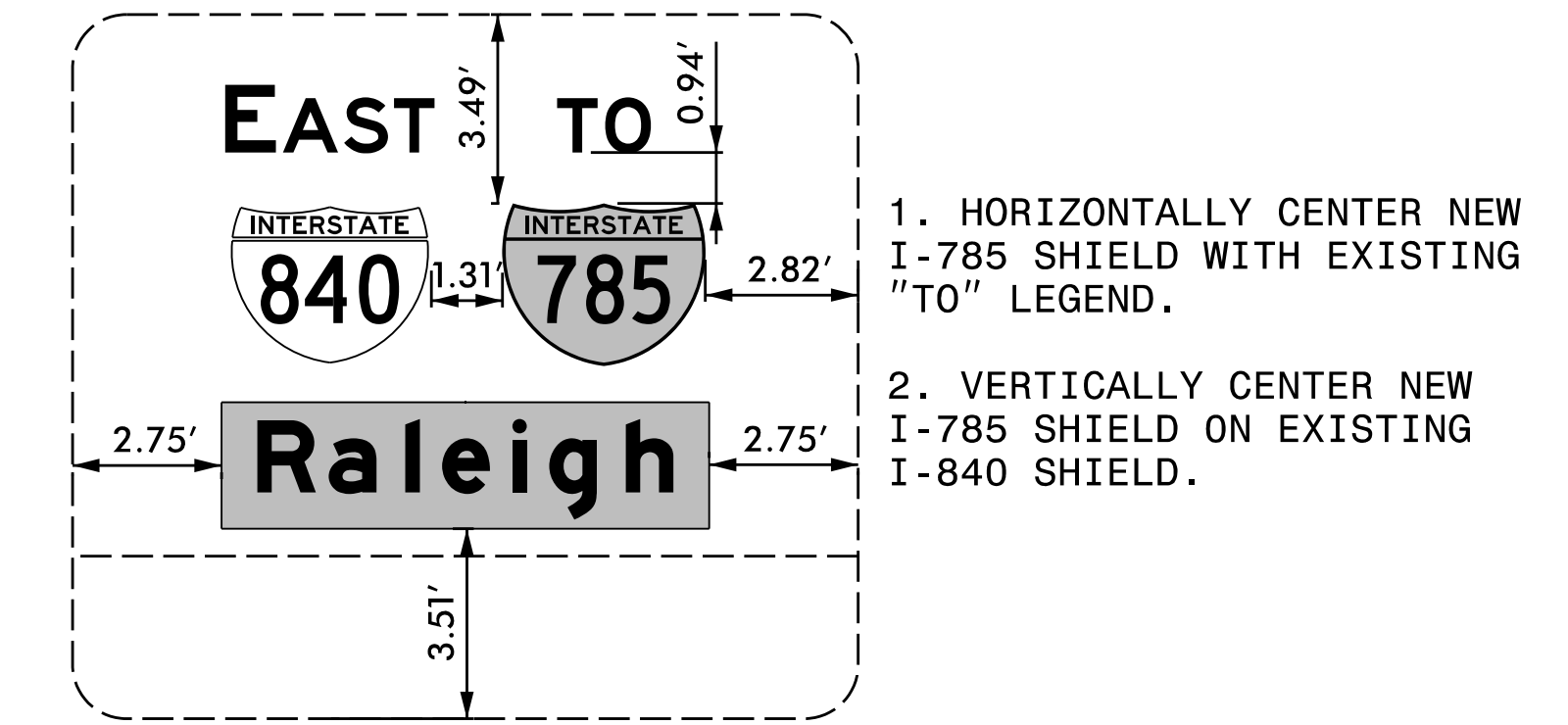

SIGNS 6012,6013

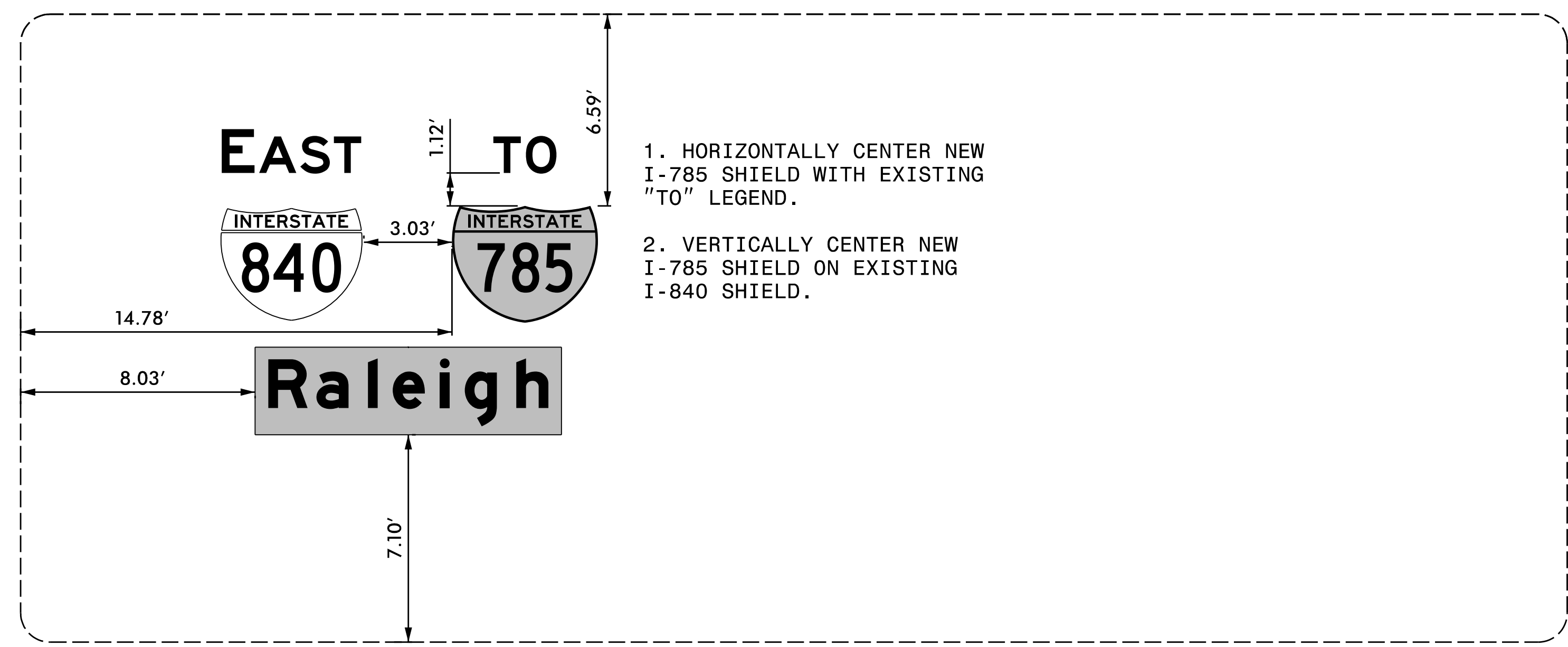

SIGN 6017

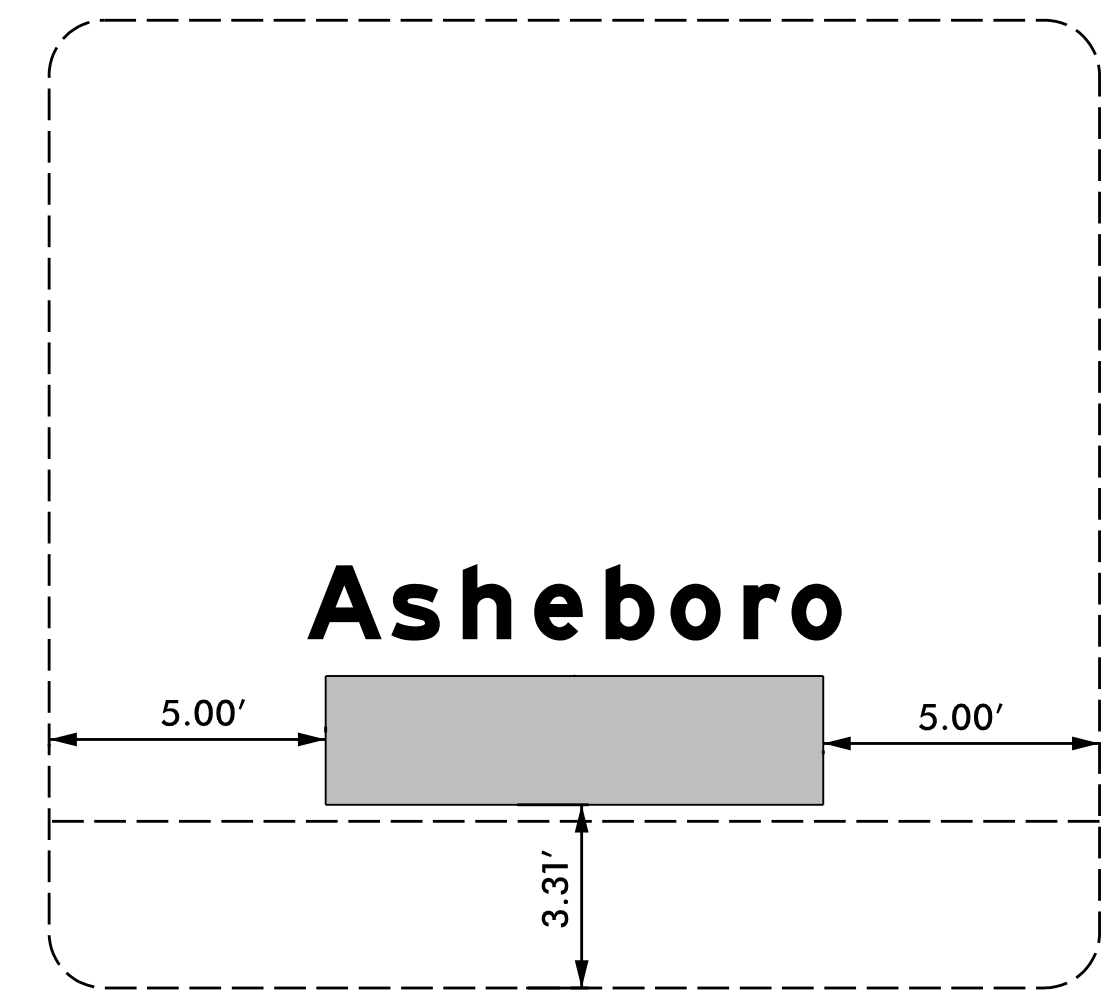



TIP NO. U-2525C	SHEET NO. SIGN-5B
APPROVED: <i>Charles A. Johnson, III</i> <small>58A1562847F5A4E</small>	
DATE: 12/14/2017	
SEAL 	
DOCUMENT NOT CONSIDERED FINAL UNLESS ALL SIGNATURES COMPLETED	

SIGNS 6018, 6019

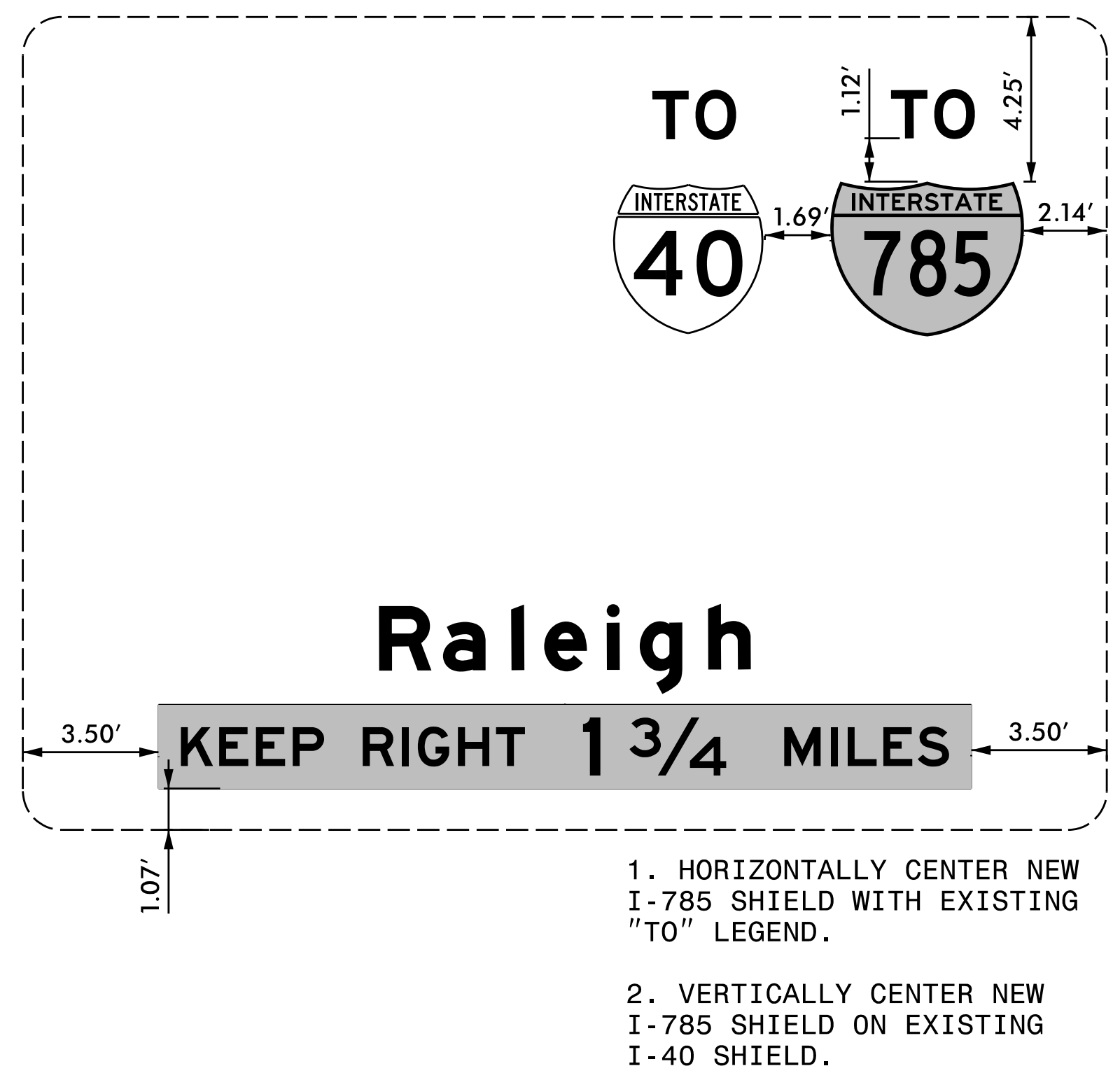

SIGNS 6020, 6021, 6022

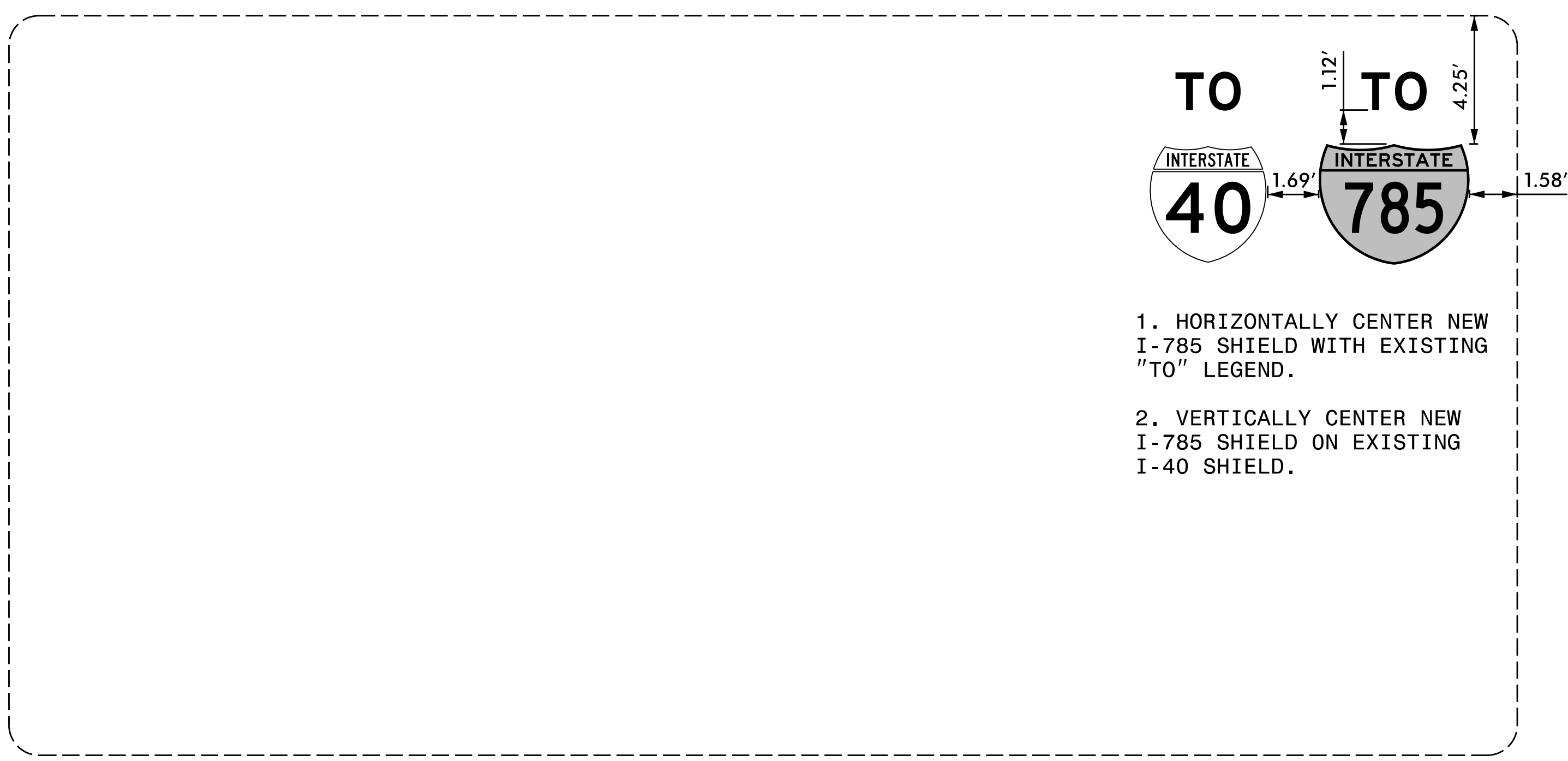

SIGNS 6023, 6024

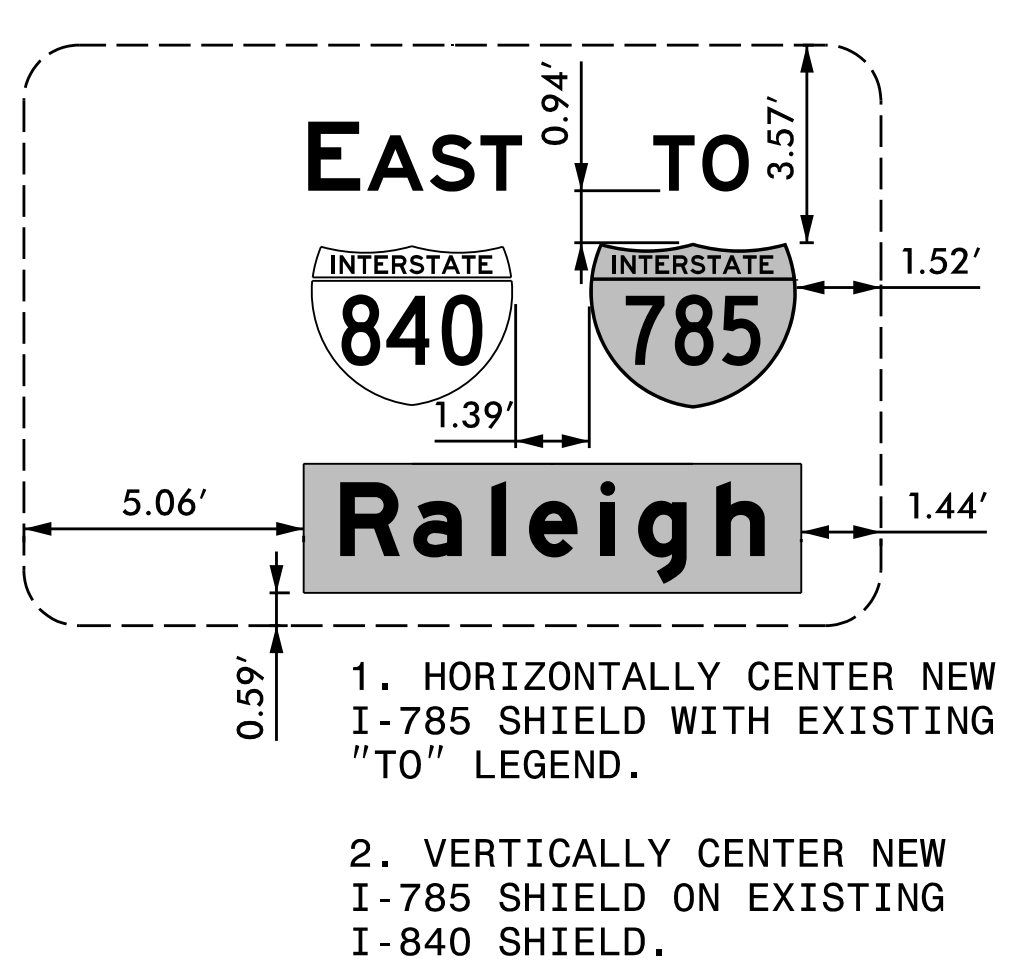

SIGN 6025

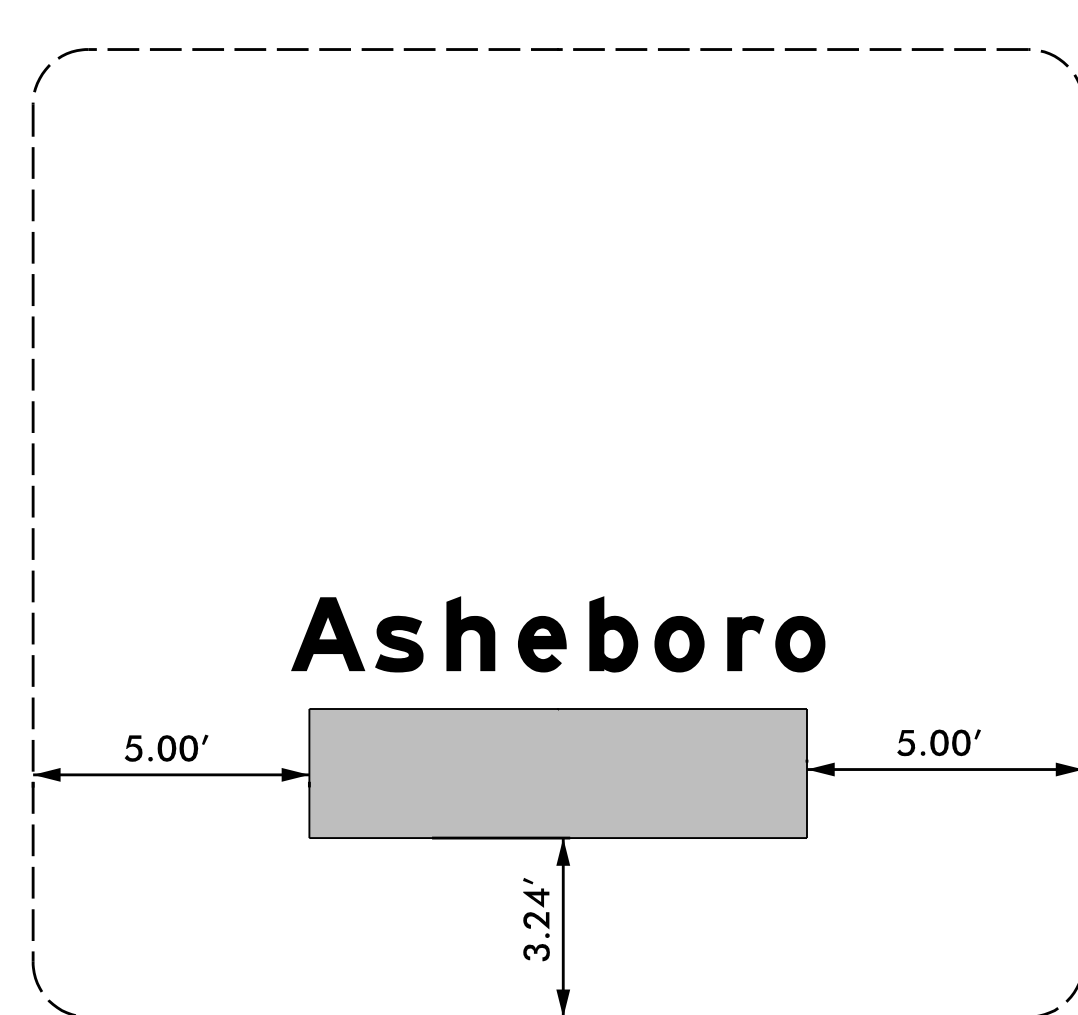

SIGNS 6026, 6027, 6028

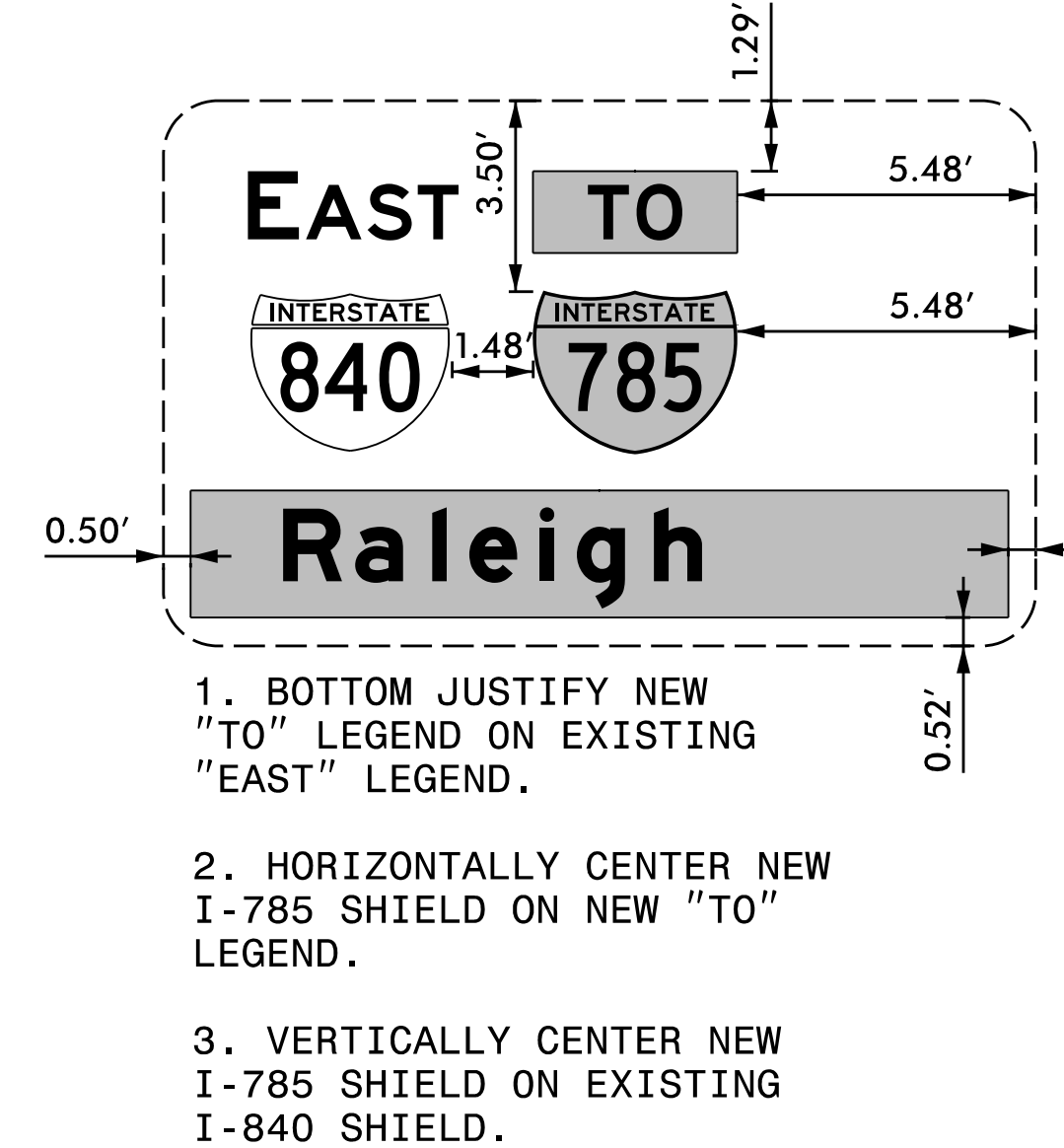

SIGNS 6029, 6030, 6031

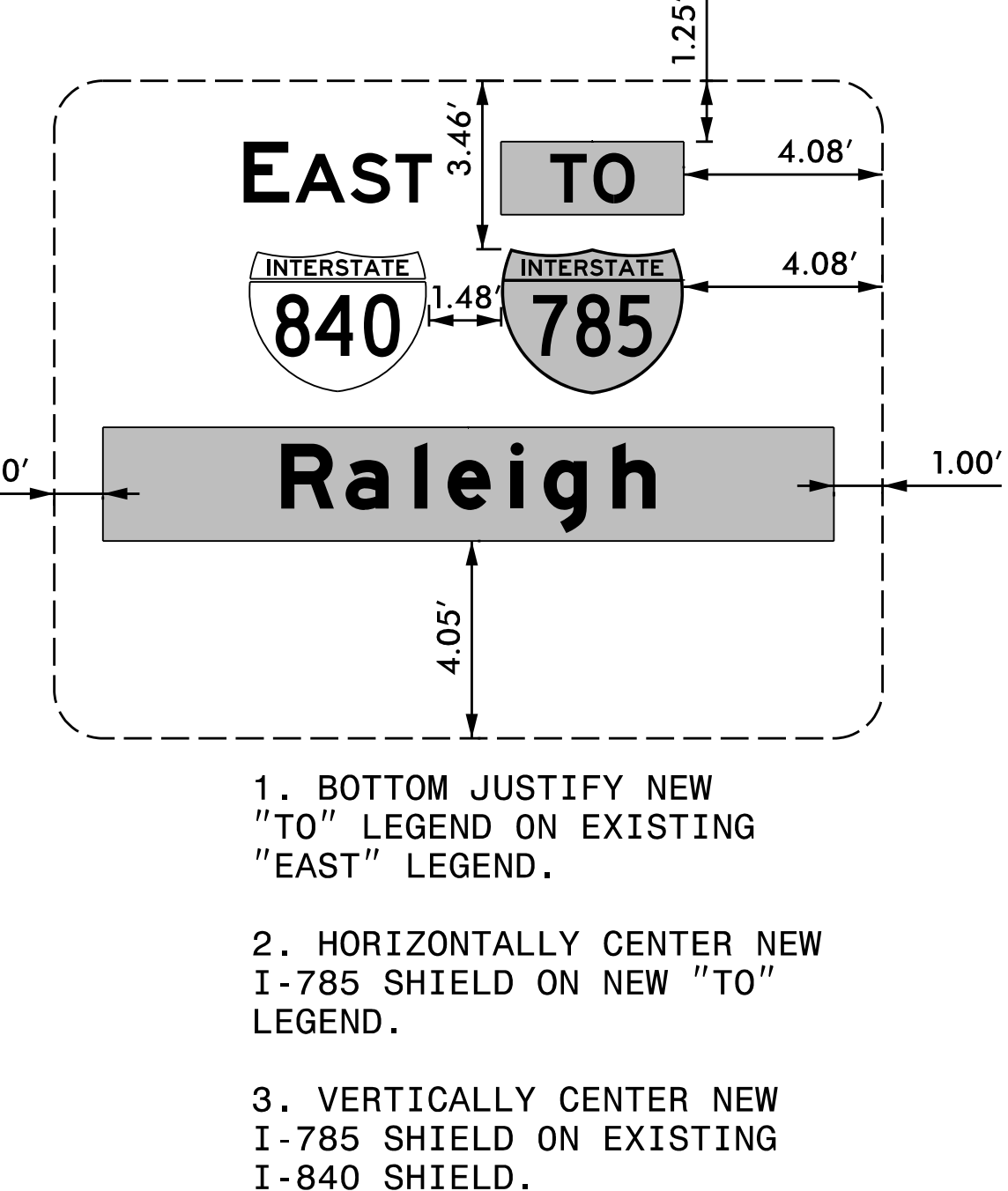

TIP NO. U-2525C	SHEET NO. SIGN-5C
APPROVED: <i>Charles A. Johnson, III</i> <small>SEA1568477544E</small>	
DATE: 12/14/2017	
SEAL 	
DOCUMENT NOT CONSIDERED FINAL UNLESS ALL SIGNATURES COMPLETED	

SIGNS 6032, 6033, 6034, 6035

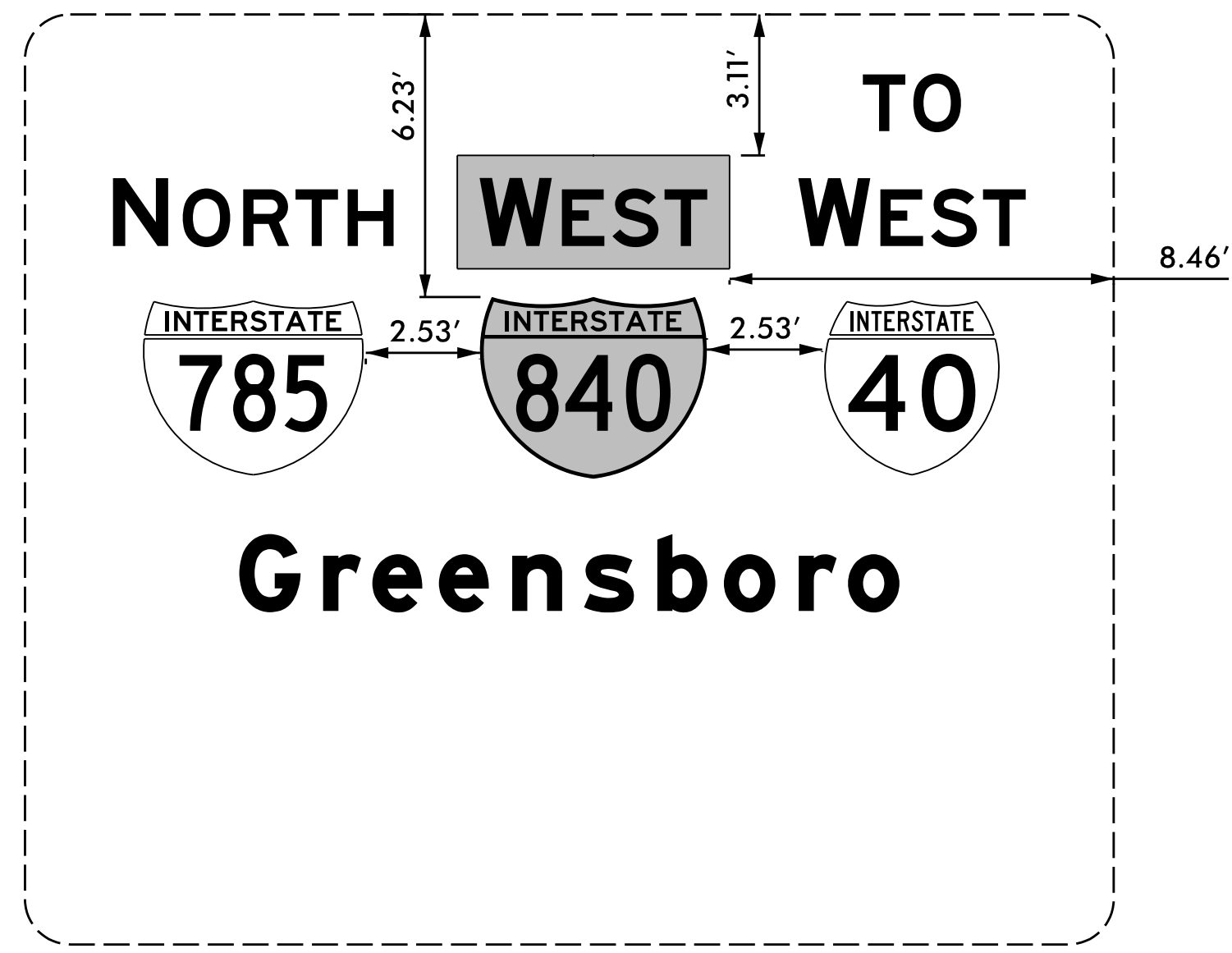

1. BOTTOM JUSTIFY NEW "WEST" LEGEND ON EXISTING "NORTH" LEGEND.
2. HORIZONTALLY CENTER NEW I-840 SHIELD ON NEW "WEST" LEGEND.
3. VERTICALLY CENTER NEW I-840 SHIELD ON EXISTING I-785 SHIELD.

SIGNS 6036, 6037

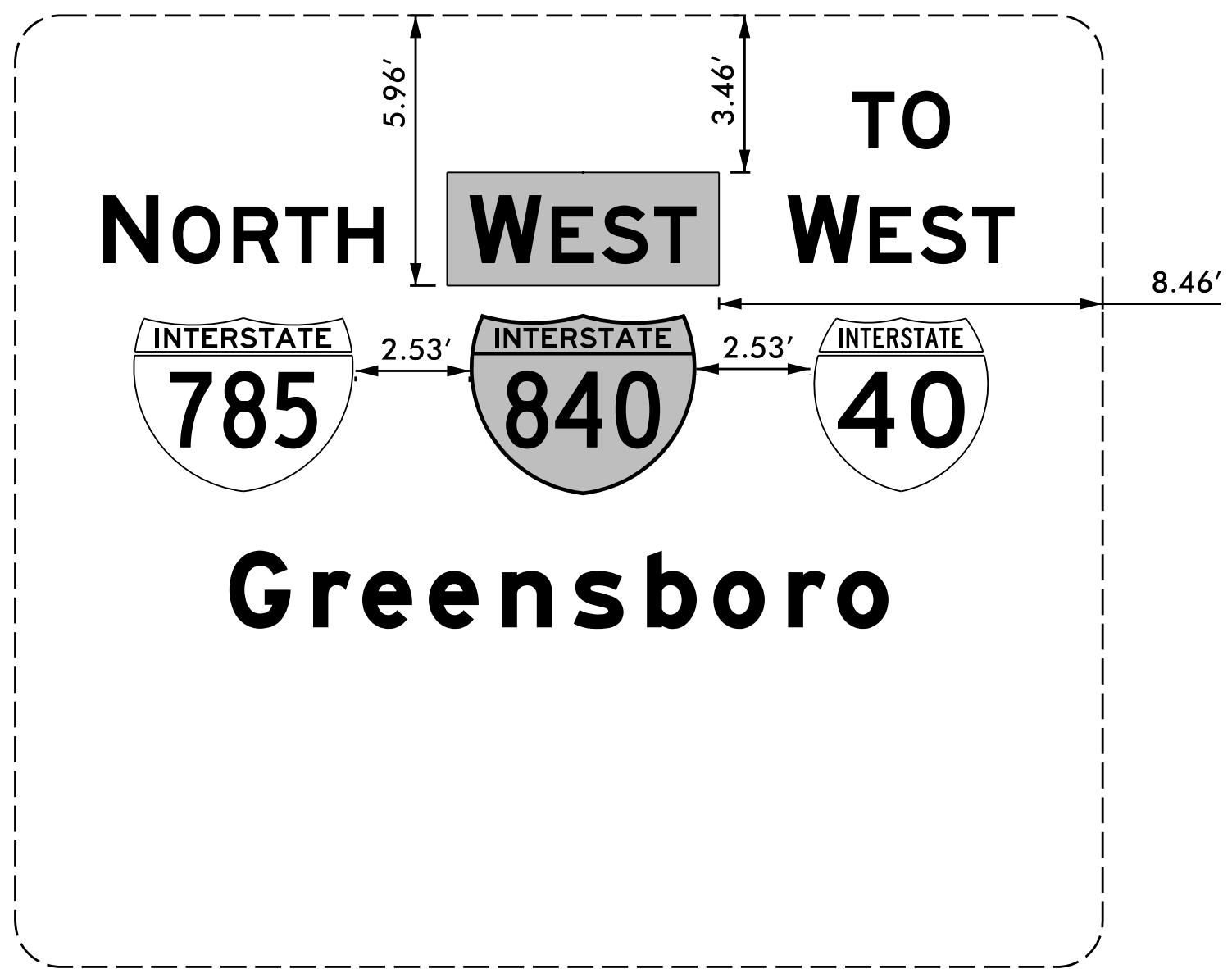

1. BOTTOM JUSTIFY NEW "WEST" LEGEND ON EXISTING "NORTH" LEGEND.
2. HORIZONTALLY CENTER NEW I-840 SHIELD ON NEW "WEST" LEGEND.
3. VERTICALLY CENTER NEW I-840 SHIELD ON EXISTING I-785 SHIELD.

SIGNS 6038, 6039

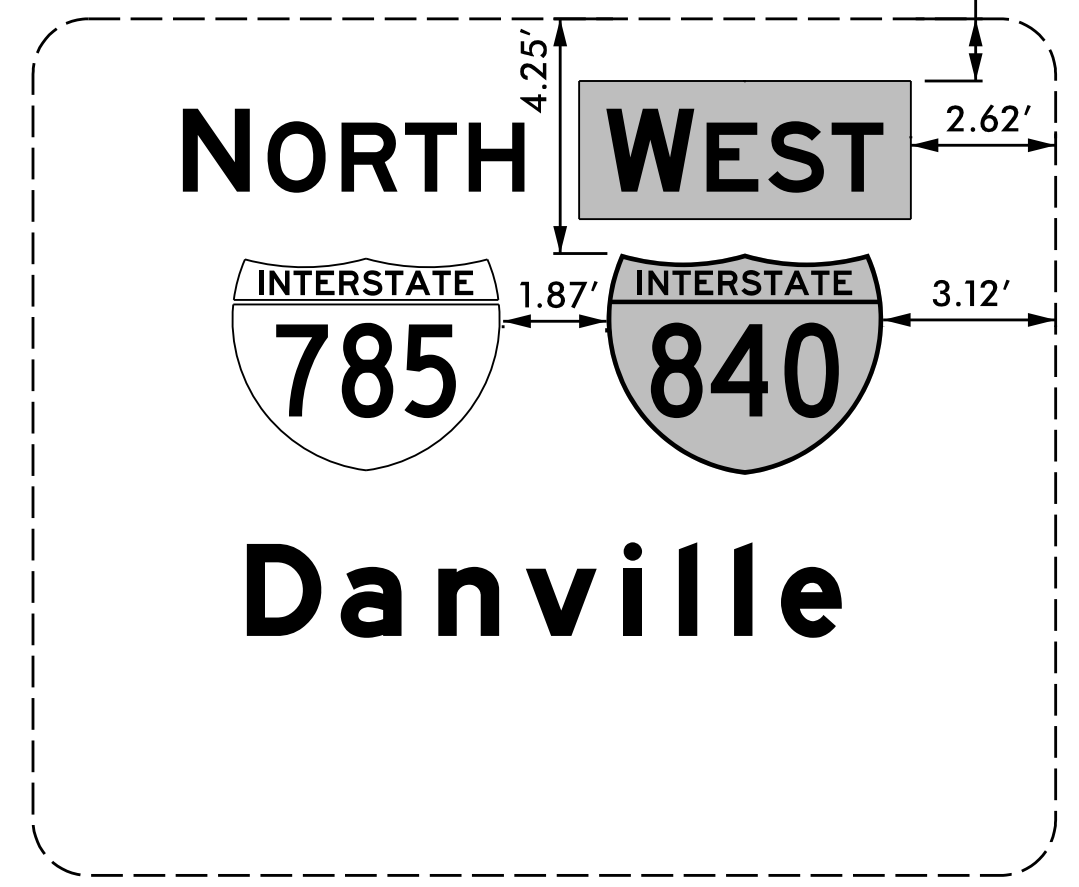

1. BOTTOM JUSTIFY NEW "WEST" LEGEND ON EXISTING "NORTH" LEGEND.
2. HORIZONTALLY CENTER NEW I-840 SHIELD ON NEW "WEST" LEGEND.
3. VERTICALLY CENTER NEW I-840 SHIELD ON EXISTING I-785 SHIELD.

SIGNS 6040, 6041

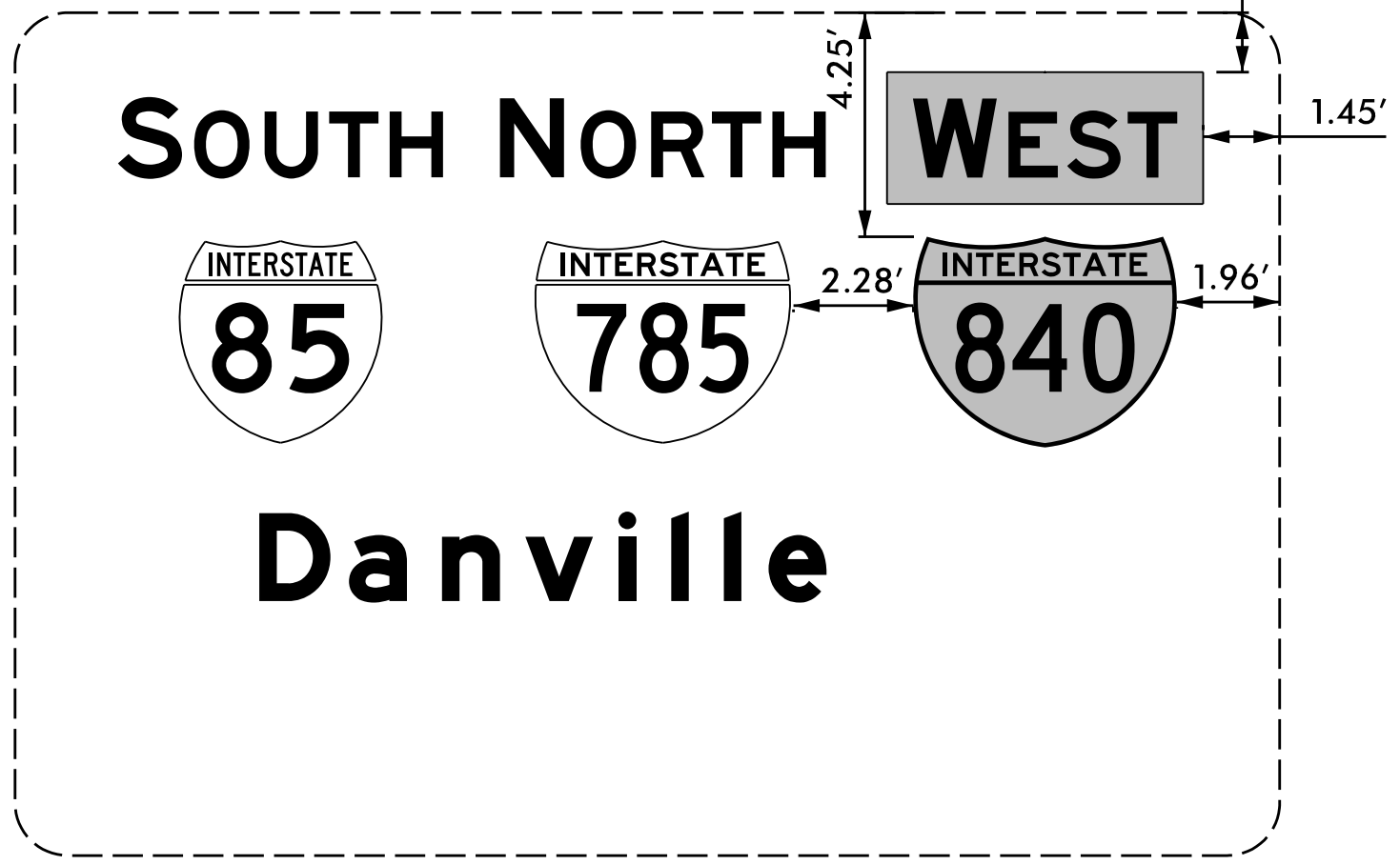

1. BOTTOM JUSTIFY NEW "WEST" LEGEND ON EXISTING "NORTH" LEGEND.
2. HORIZONTALLY CENTER NEW I-840 SHIELD ON NEW "WEST" LEGEND.
3. VERTICALLY CENTER NEW I-840 SHIELD ON EXISTING I-785 SHIELD.

SIGNS 6042, 6043

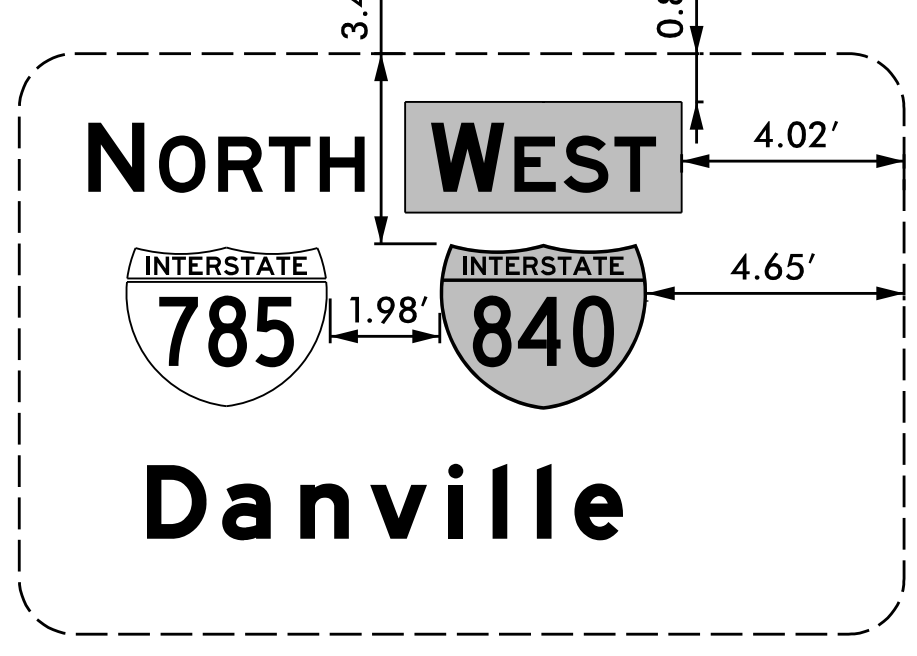

1. BOTTOM JUSTIFY NEW "WEST" LEGEND ON EXISTING "NORTH" LEGEND.
2. HORIZONTALLY CENTER NEW I-840 SHIELD ON NEW "WEST" LEGEND.
3. VERTICALLY CENTER NEW I-840 SHIELD ON EXISTING I-785 SHIELD.

SIGNS 6044, 6045, 6046, 6047

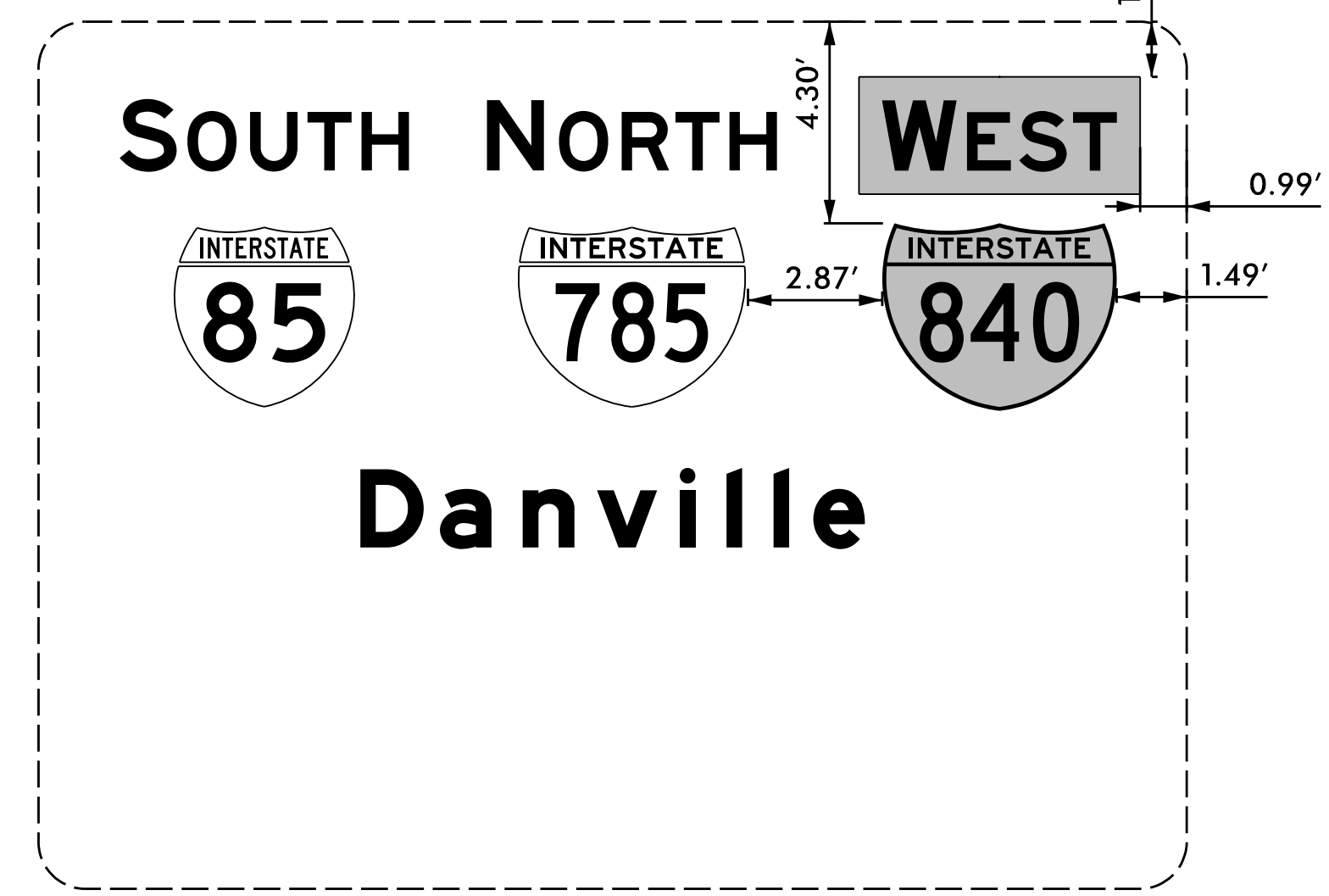

1. BOTTOM JUSTIFY NEW "WEST" LEGEND ON EXISTING "NORTH" LEGEND.
2. HORIZONTALLY CENTER NEW I-840 SHIELD ON NEW "WEST" LEGEND.
3. VERTICALLY CENTER NEW I-840 SHIELD ON EXISTING I-785 SHIELD.

TIP NO. U-2525C	SHEET NO. SIGN-5D
APPROVED: <i>Charles A. Johnson, III</i> <small>DocuSigned by: Charles A. Johnson, III 59A1562B4775A8E</small>	
DATE: 12/14/2017	
SEAL	
	
DOCUMENT NOT CONSIDERED FINAL UNLESS ALL SIGNATURES COMPLETED	

SIGNS 6048, 6049, 6050, 6051, 6052, 6053, 6054, 6055

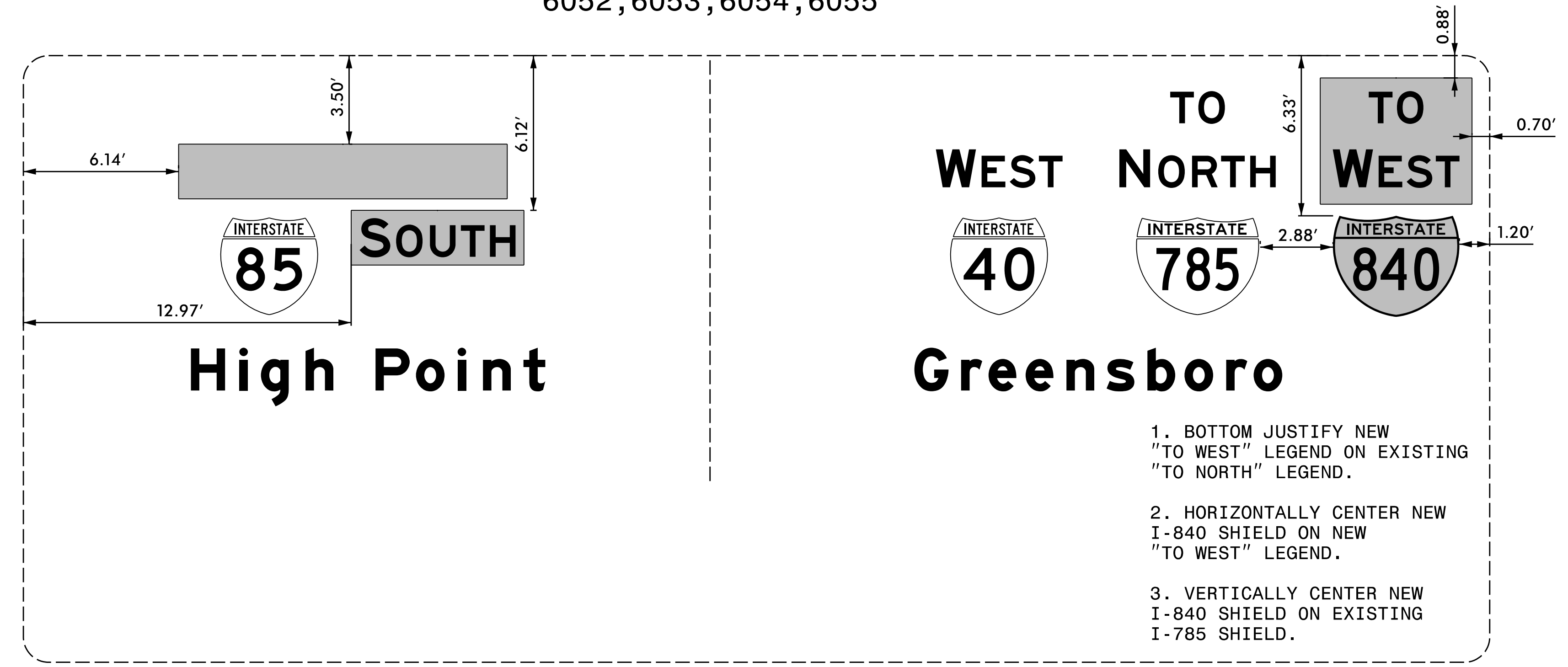

SIGNS 6056, 6057, 6058, 6059

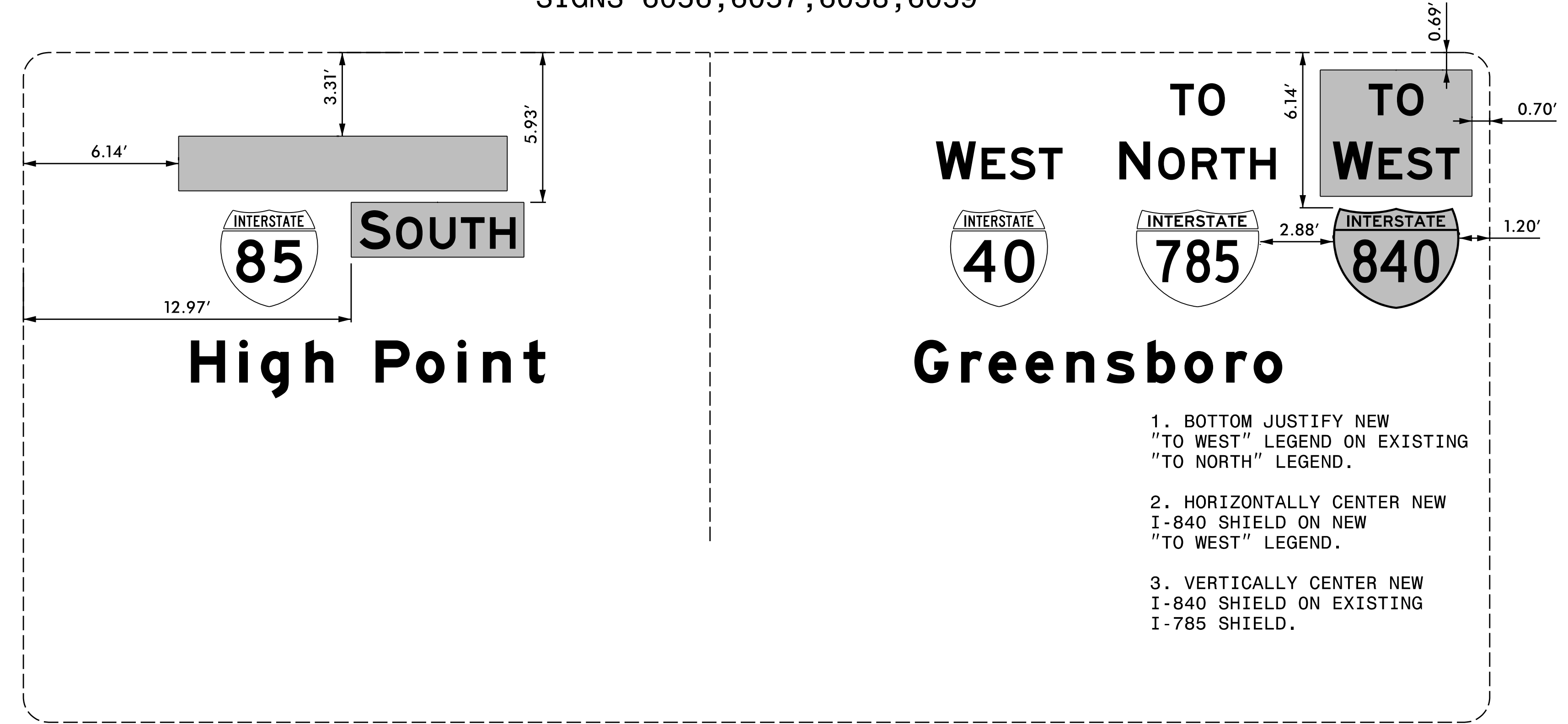

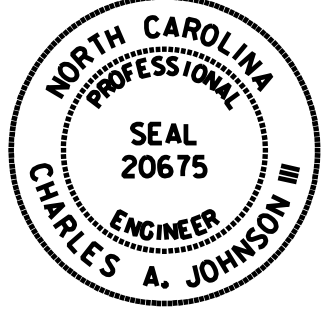

TIP NO. U-2525C	SHEET NO. SIGN-5E
APPROVED: <i>Charles A. Johnson, III</i> <small>59A1562847F544E</small>	
DATE: 12/14/2017	
SEAL 	
DOCUMENT NOT CONSIDERED FINAL UNLESS ALL SIGNATURES COMPLETED	

SIGNS 6060, 6061

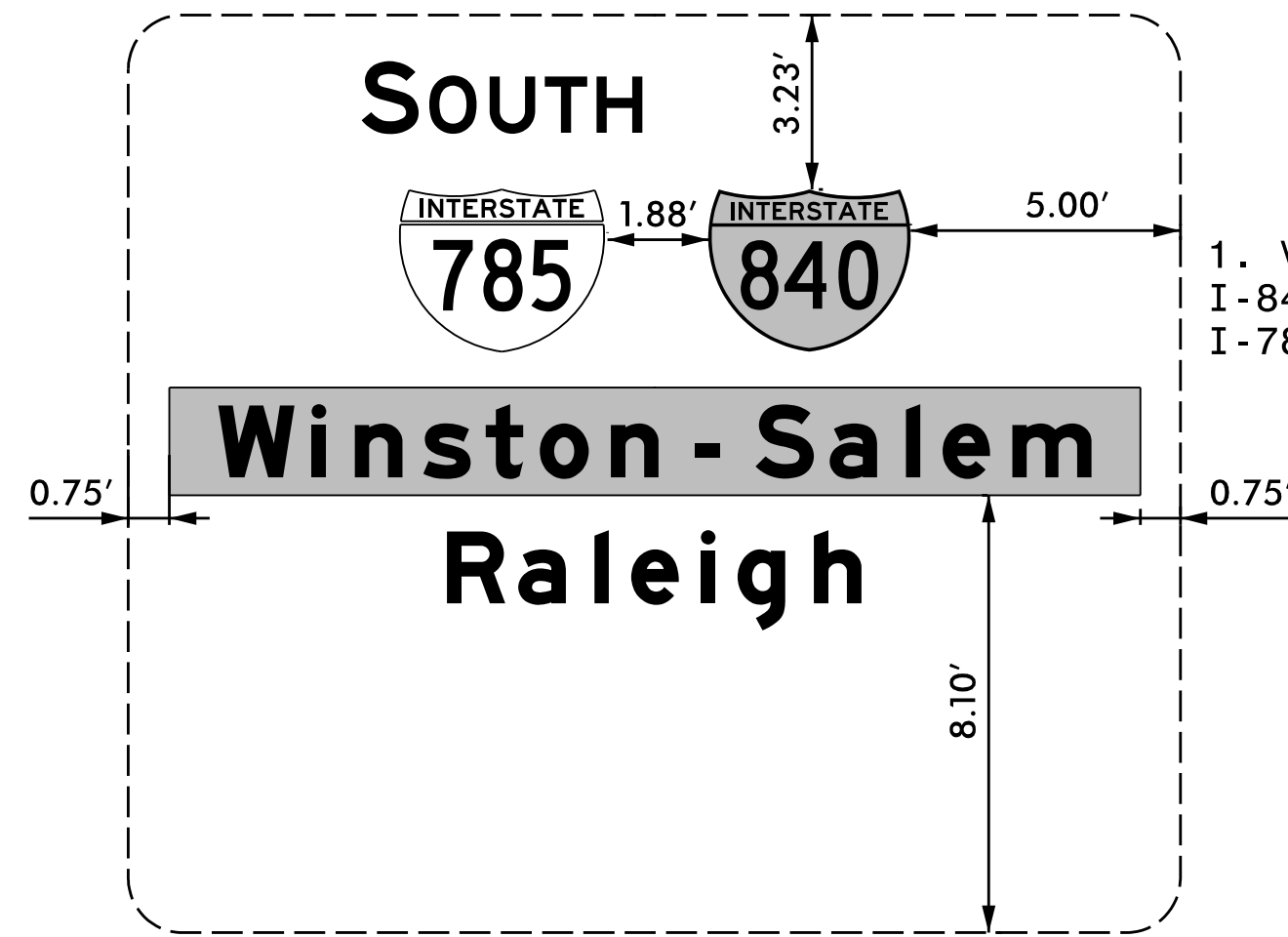

1. VERTICALLY CENTER NEW I-840 SHIELD ON EXISTING I-785 SHIELD.

SIGNS 6062, 6063, 6068, 6069

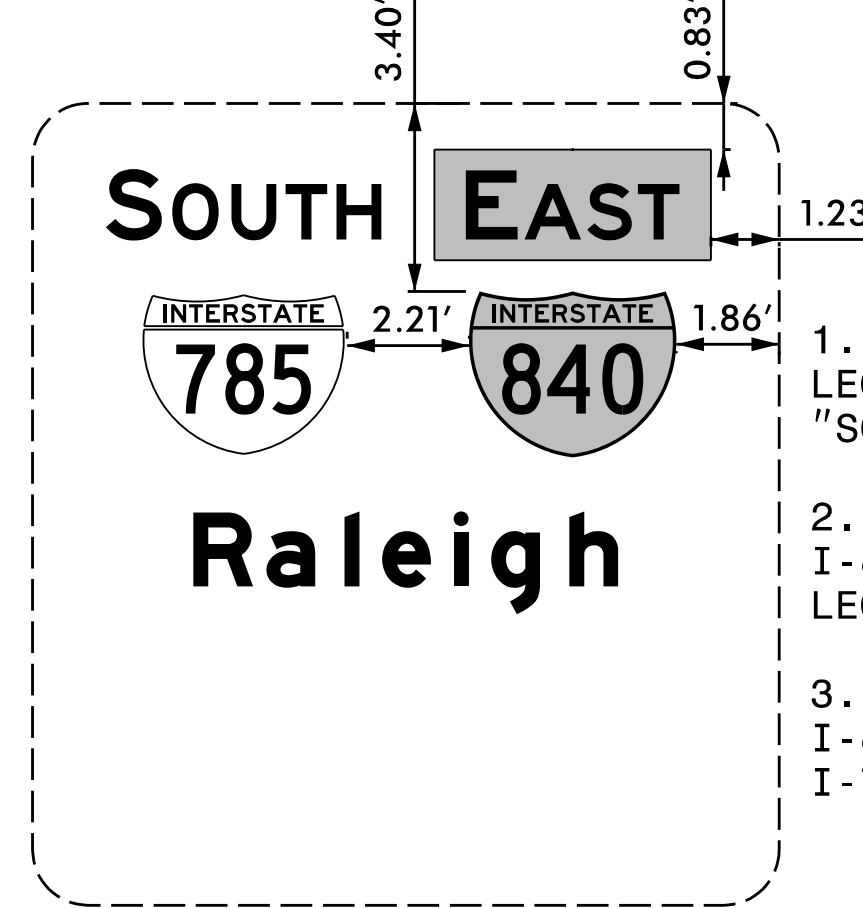

1. BOTTOM JUSTIFY NEW "EAST" LEGEND ON EXISTING "SOUTH" LEGEND.
2. HORIZONTALLY CENTER NEW I-840 SHIELD ON NEW "EAST" LEGEND.
3. VERTICALLY CENTER NEW I-840 SHIELD ON EXISTING I-785 SHIELD.

SIGNS 6064, 6065

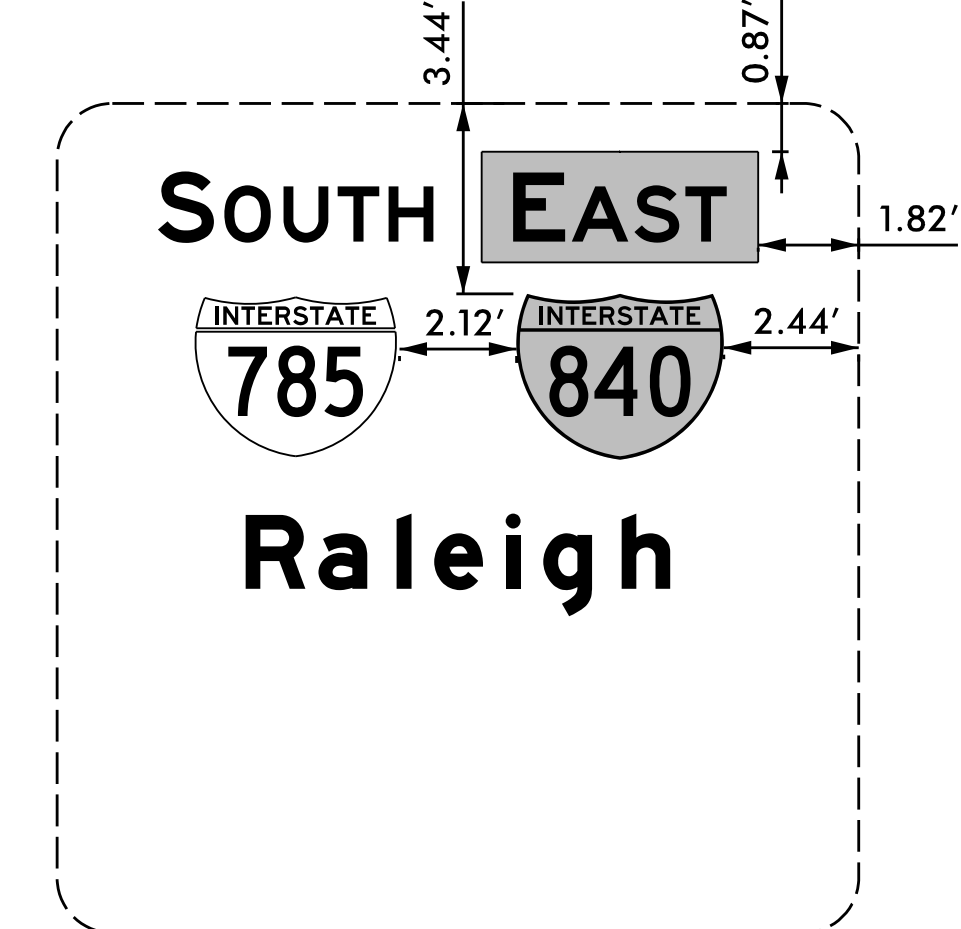

1. BOTTOM JUSTIFY NEW "EAST" LEGEND ON EXISTING "SOUTH" LEGEND.
2. HORIZONTALLY CENTER NEW I-840 SHIELD ON NEW "EAST" LEGEND.
3. VERTICALLY CENTER NEW I-840 SHIELD ON EXISTING I-785 SHIELD.

SIGNS 6066, 6067

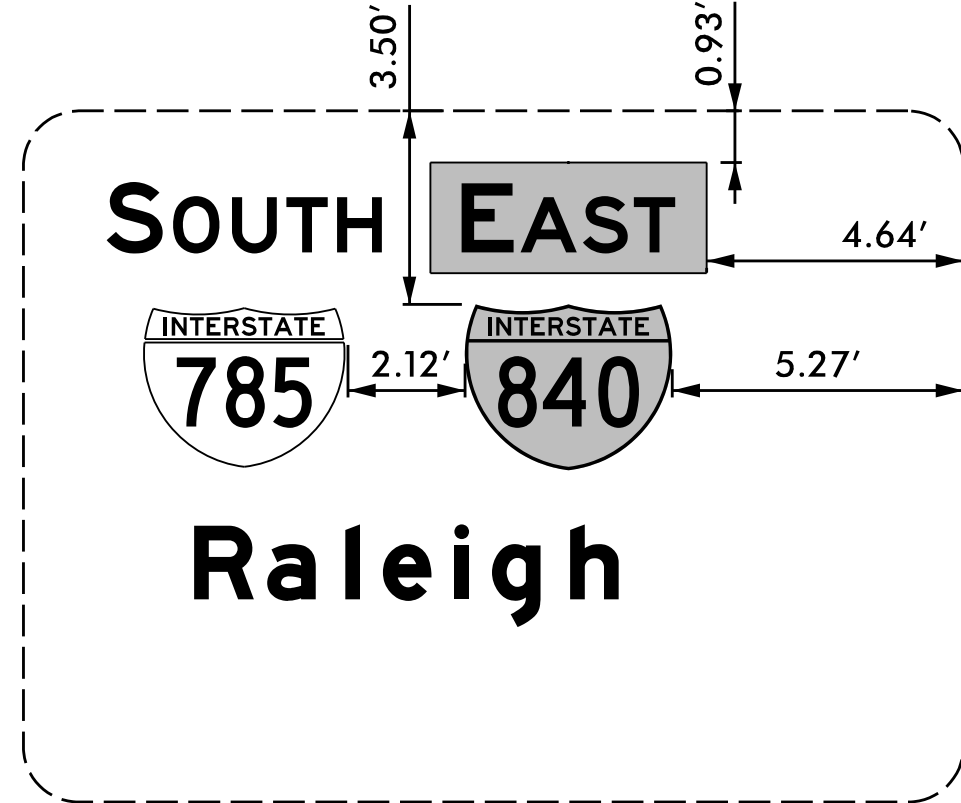

1. BOTTOM JUSTIFY NEW "EAST" LEGEND ON EXISTING "SOUTH" LEGEND.
2. HORIZONTALLY CENTER NEW I-840 SHIELD ON NEW "EAST" LEGEND.
3. VERTICALLY CENTER NEW I-840 SHIELD ON EXISTING I-785 SHIELD.

SIGNS 6070, 6071, 6072, 6073

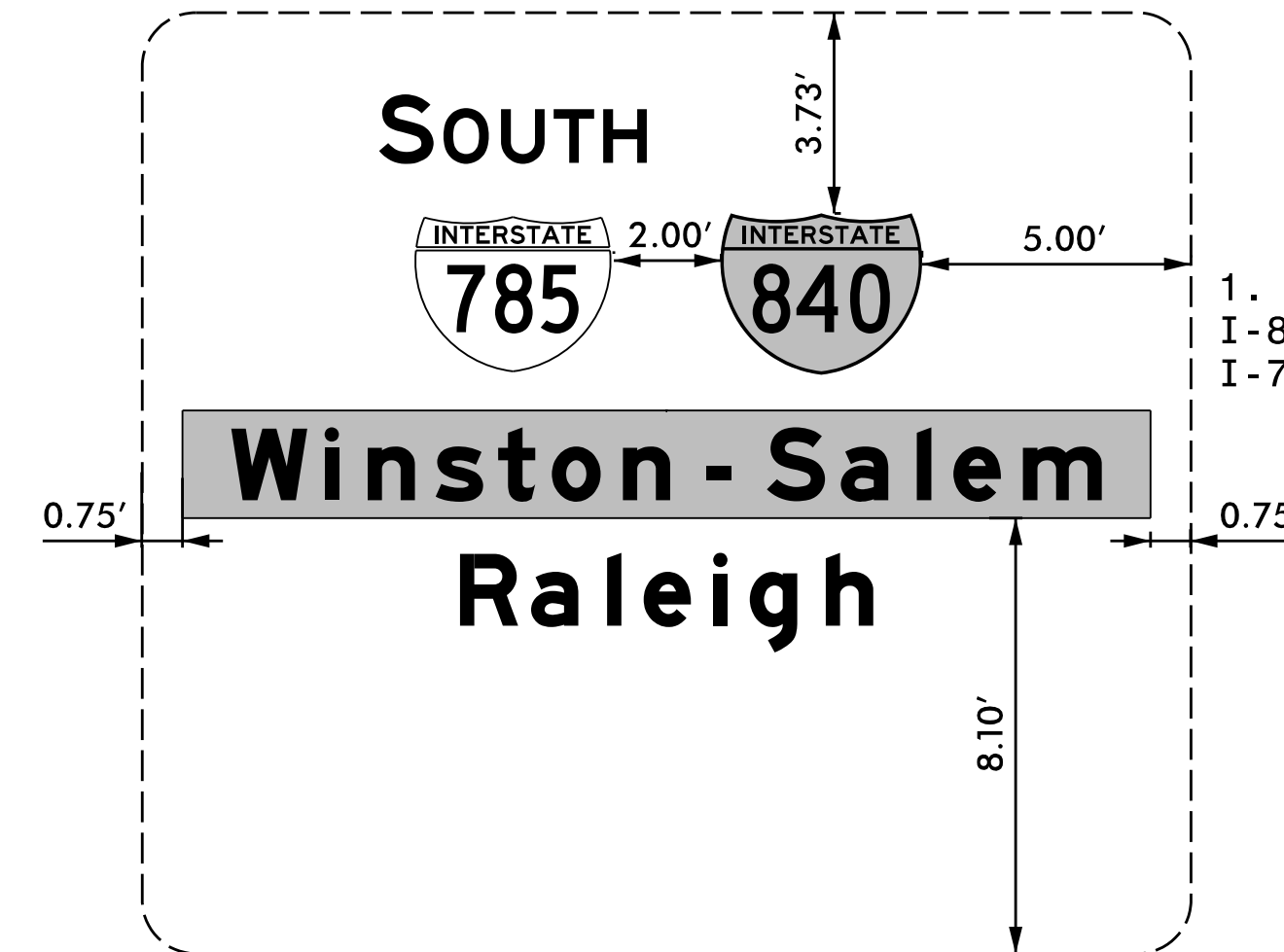

1. VERTICALLY CENTER NEW I-840 SHIELD ON EXISTING I-785 SHIELD.





HNTB NORTH CAROLINA, P.C.  
343 E. Six Forks Road, Suite 200  
Raleigh, North Carolina 27609  
NC License No: C-1554  
(919) 546-8997

**OVERLAY AND SHIELD  
PLACEMENT DETAILS**

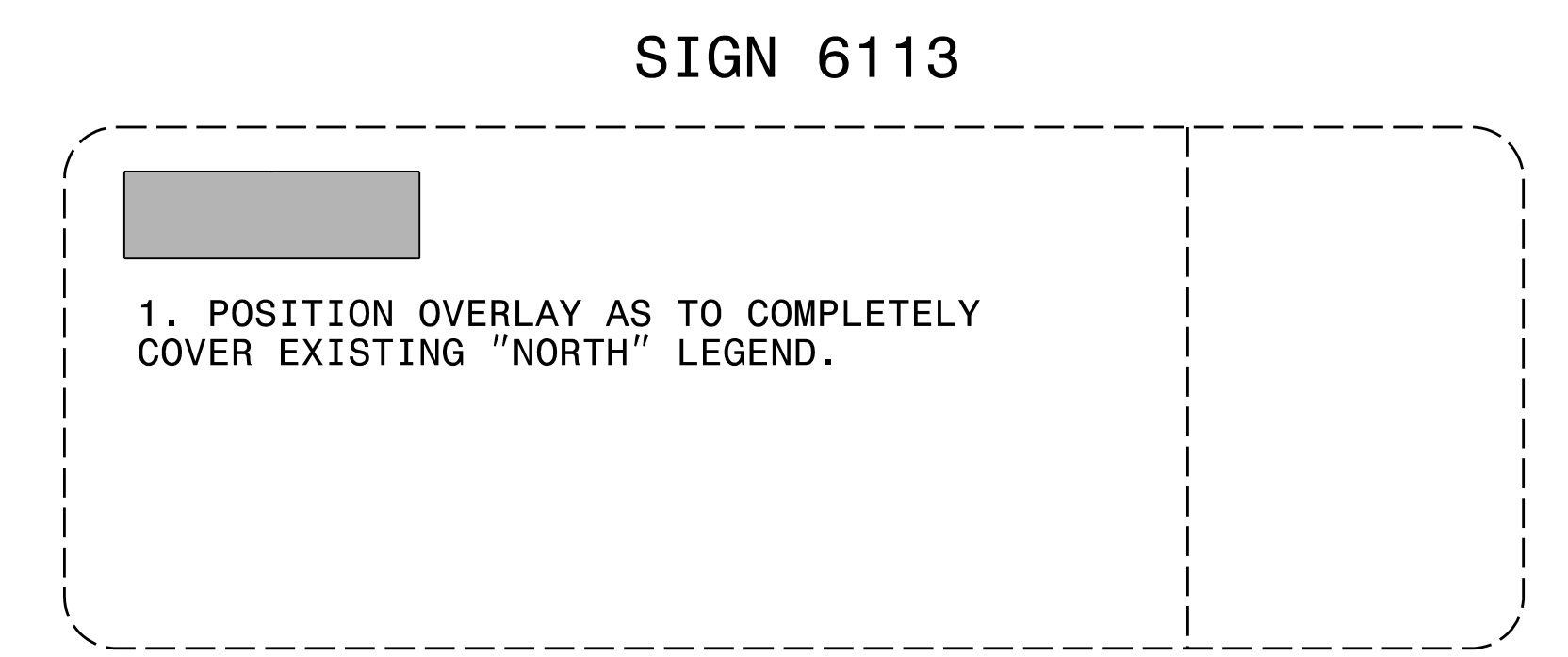
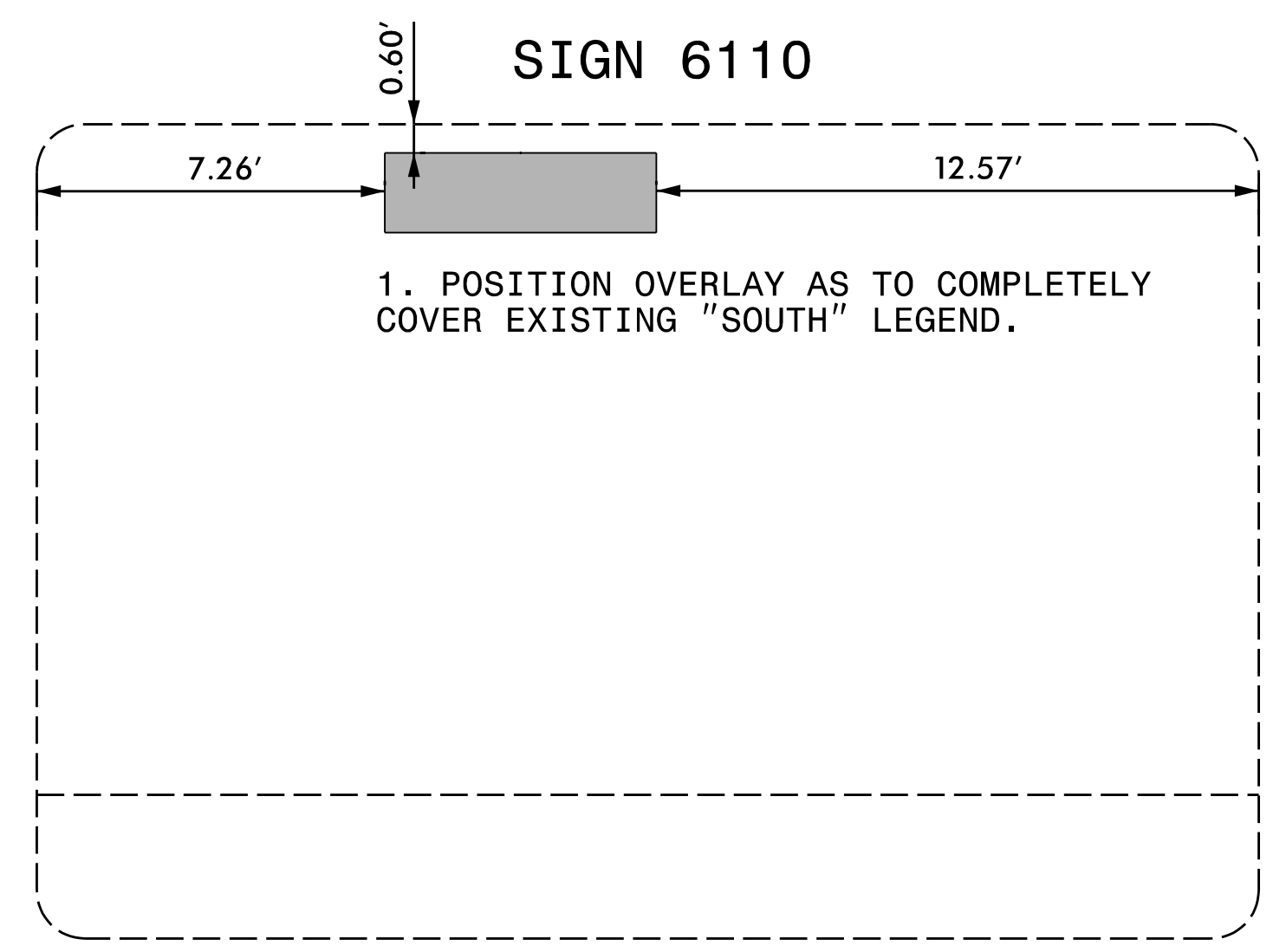
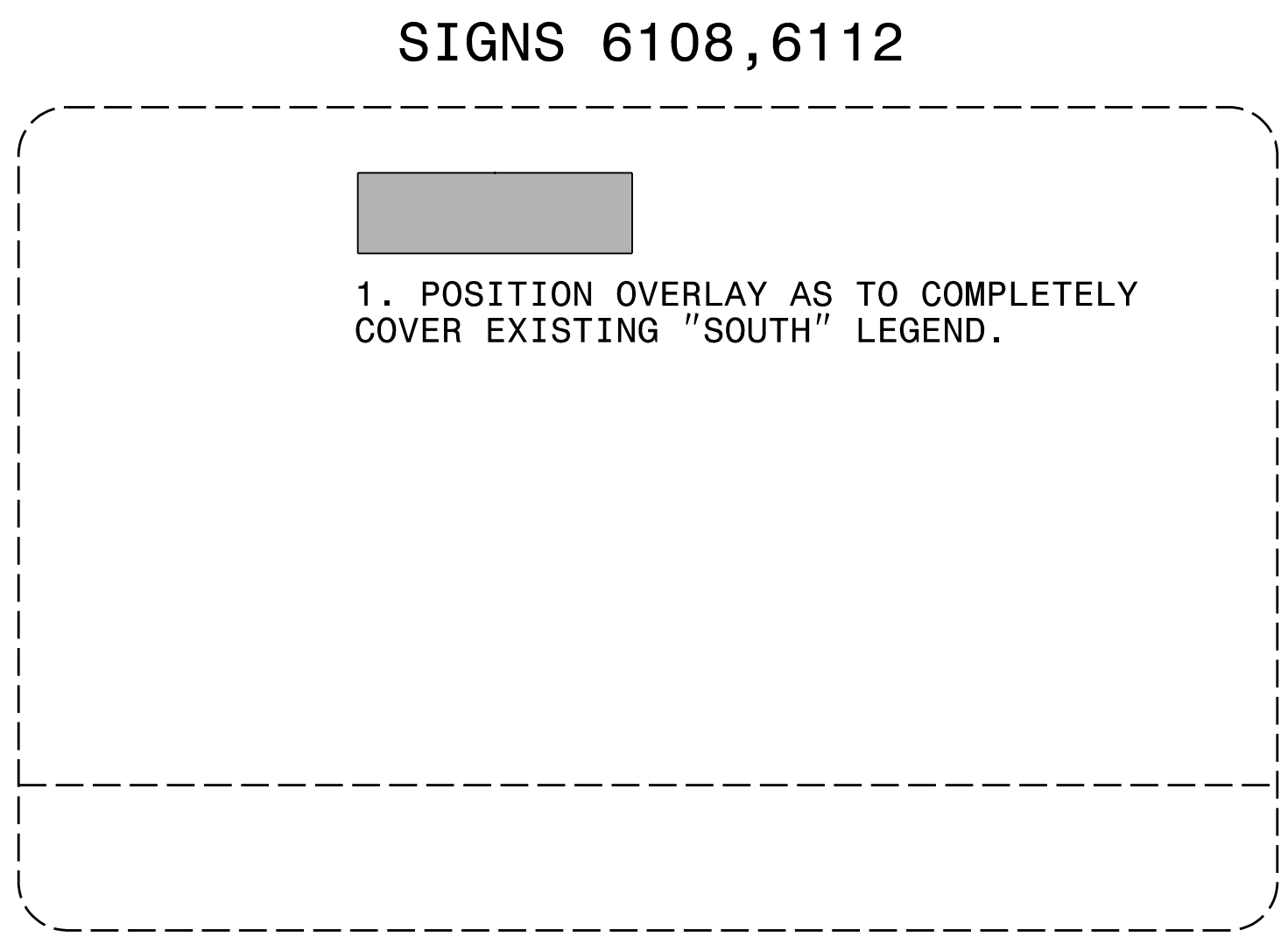
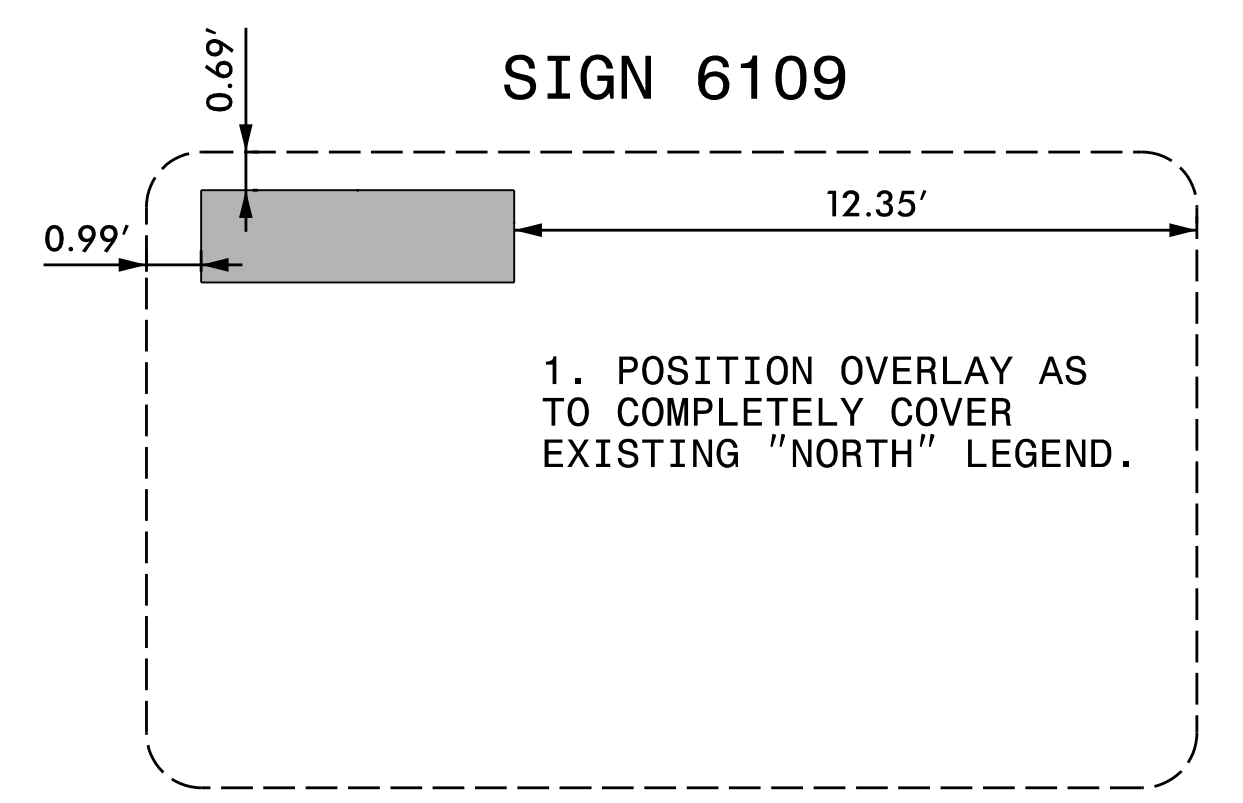
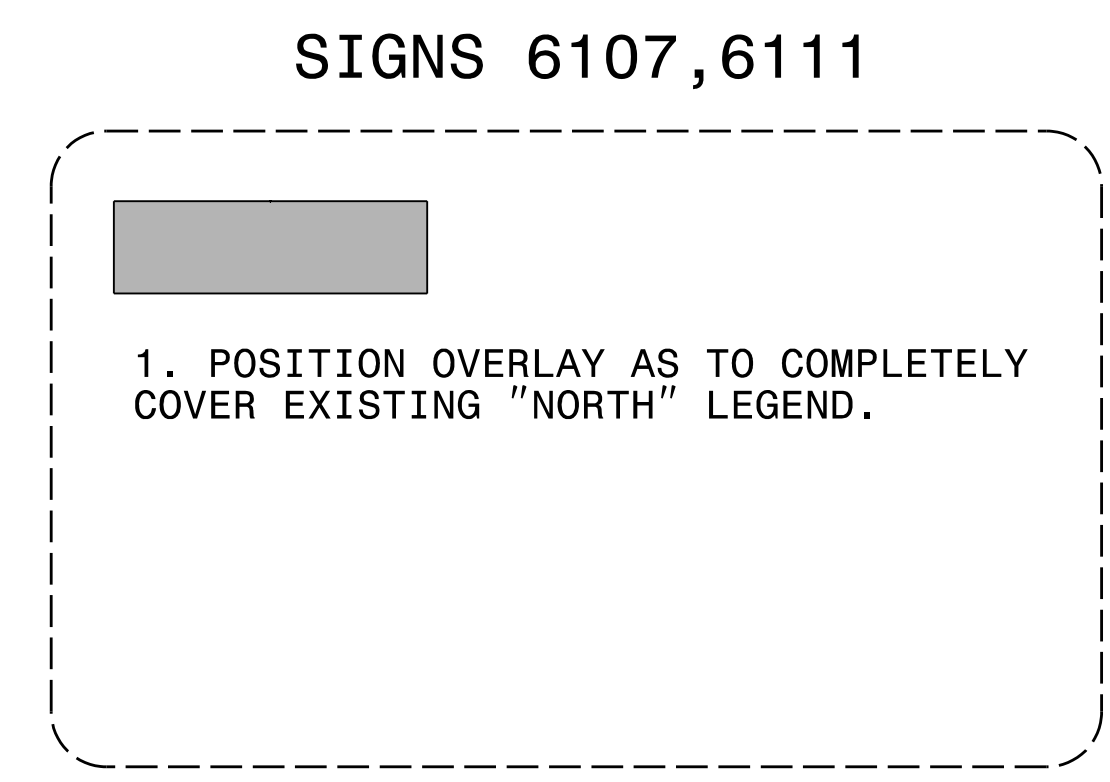
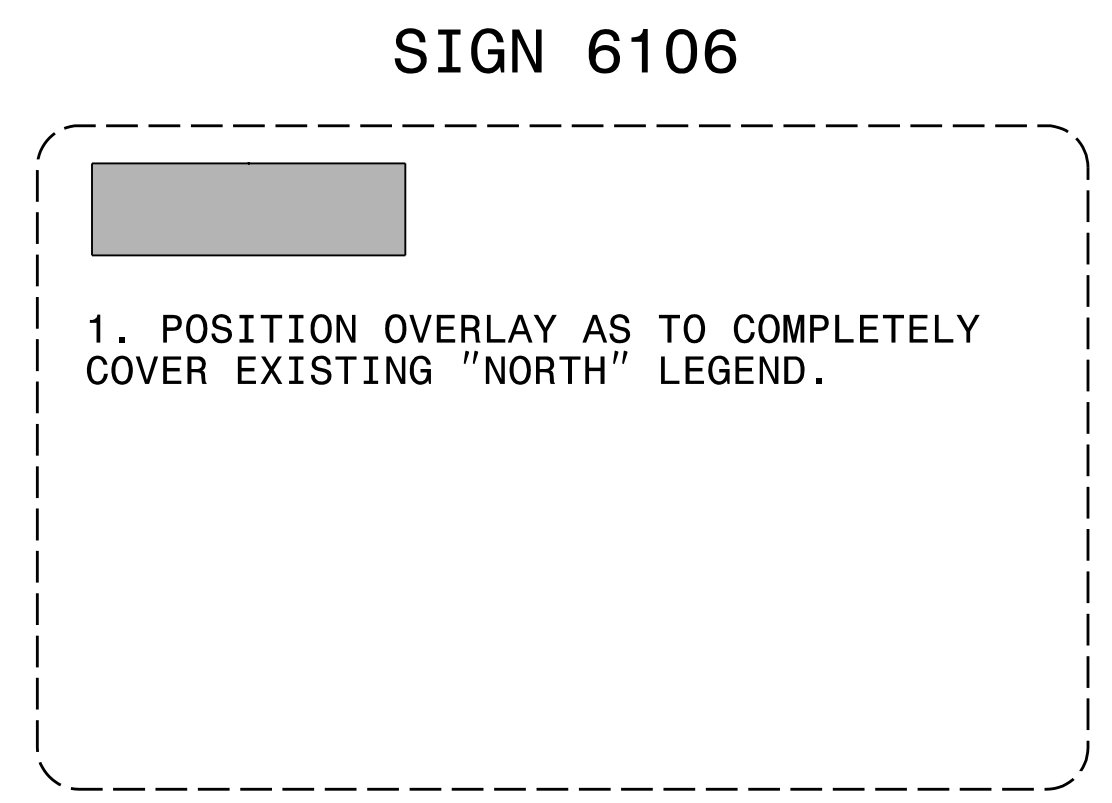
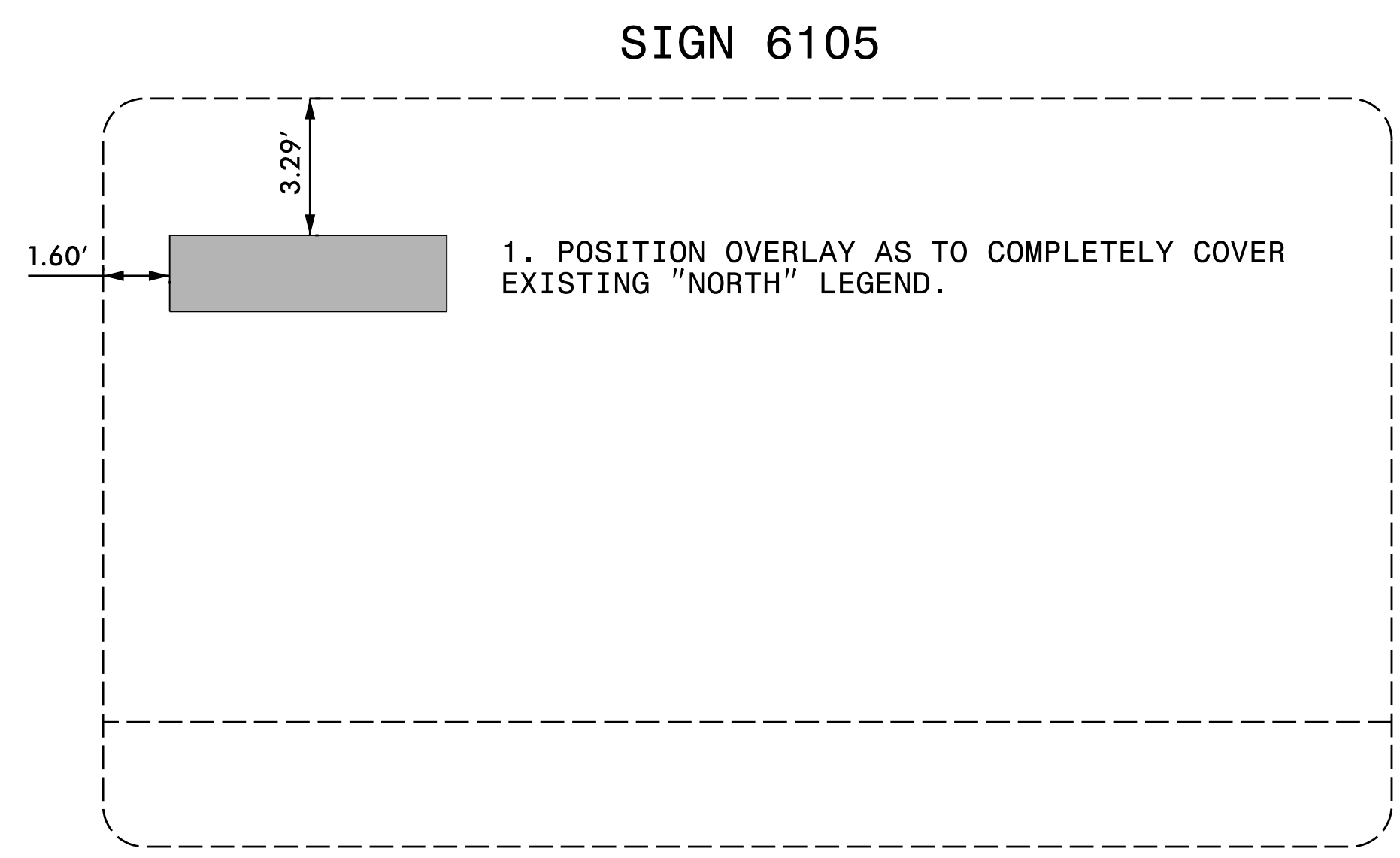
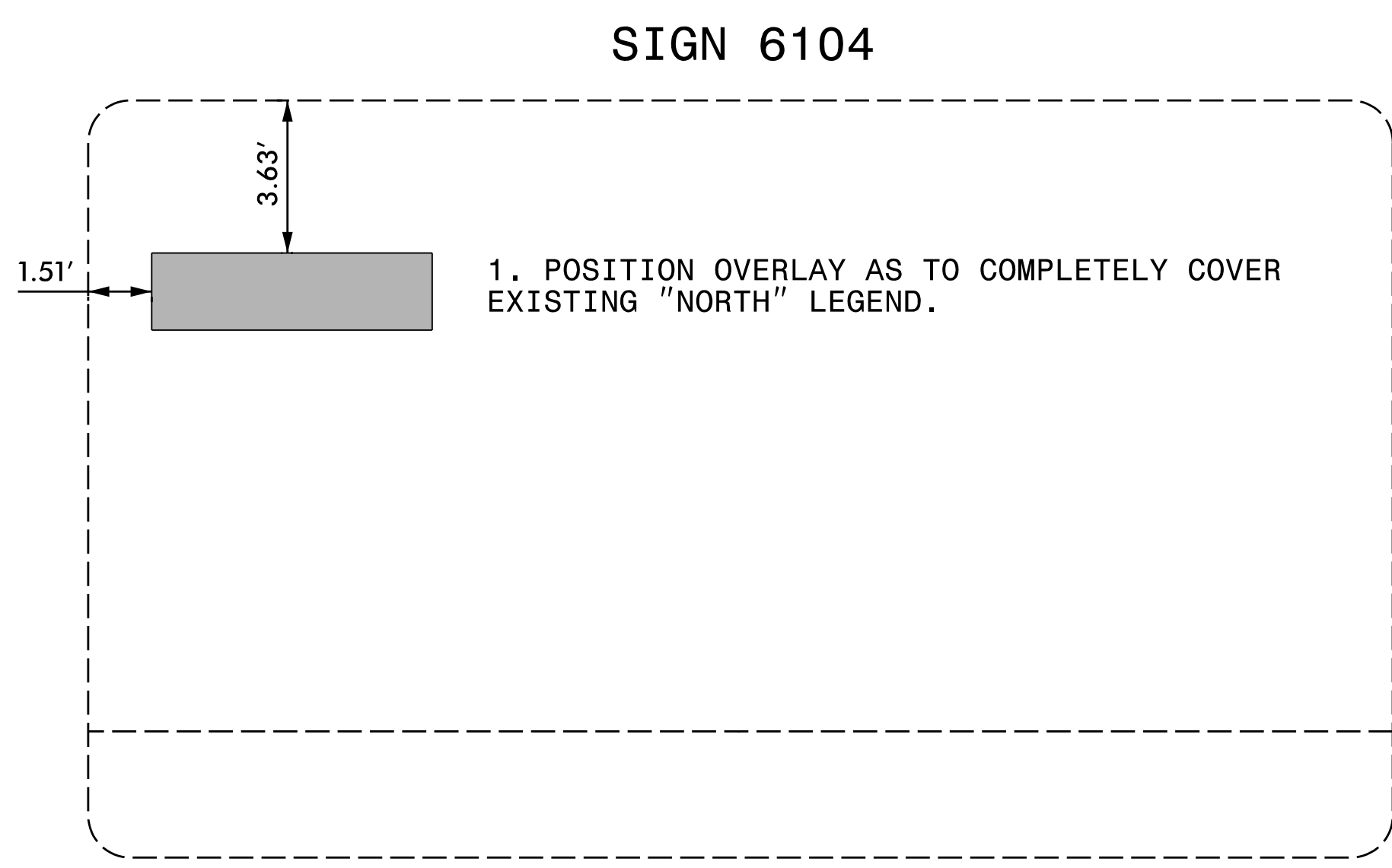
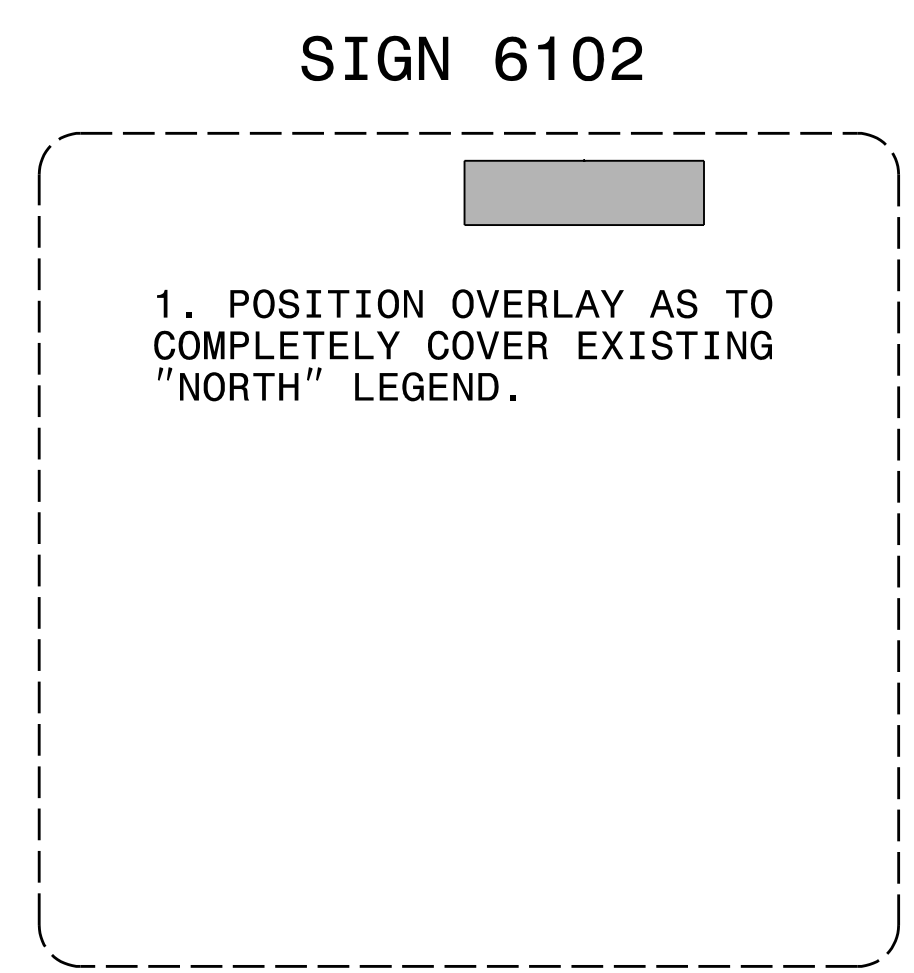
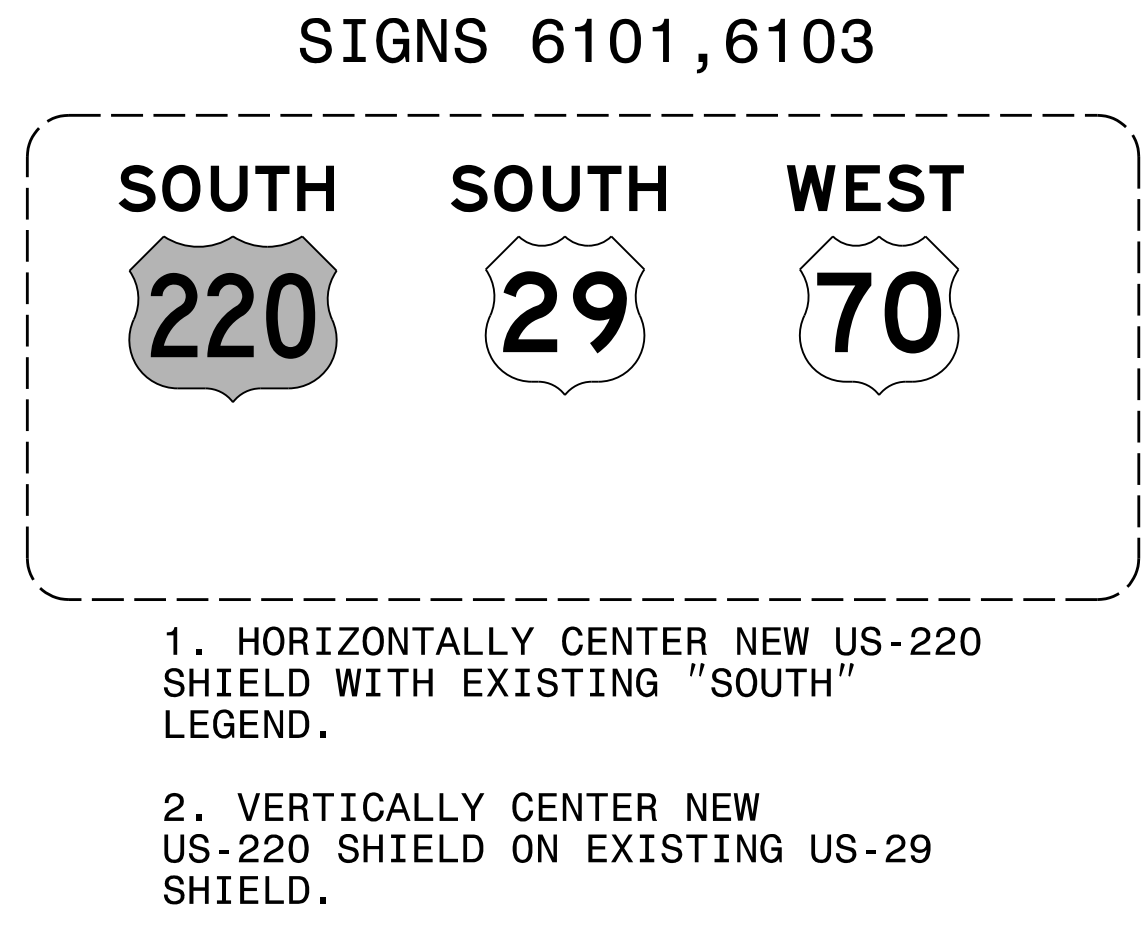

TIP NO. U-2525C	SHEET NO. SIGN-6
APPROVED: <i>Charles A. Johnson, III</i> <small>SEAL 15624775448</small>	
DATE: 12/14/2017	
SEAL 	
DOCUMENT NOT CONSIDERED FINAL UNLESS ALL SIGNATURES COMPLETED	



TIP NO. U-2525C	SHEET NO. SIGN-6A
APPROVED: <u>Charles A. Johnson, III</u> <small>DocuSigned by: Charles A. Johnson, III SPA156284775446</small>	
DATE: 12/14/2017	
SEAL	
	
DOCUMENT NOT CONSIDERED FINAL UNLESS ALL SIGNATURES COMPLETED	

**SIGNS 6114,6123,6125**

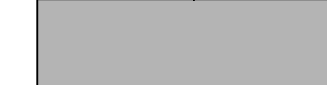

1. POSITION OVERLAY AS TO COMPLETELY COVER EXISTING "NORTH" LEGEND.

**SIGN 6115**



1. POSITION OVERLAY AS TO COMPLETELY COVER EXISTING "NORTH" LEGEND.

**SIGN 6118**



1. POSITION OVERLAY AS TO COMPLETELY COVER EXISTING "SOUTH" LEGEND.

**SIGN 6120**





1. POSITION OVERLAY AS TO COMPLETELY COVER EXISTING "SOUTH" LEGEND.

**SIGNS 6116,6117**



1. POSITION OVERLAY AS TO COMPLETELY COVER EXISTING "SOUTH" LEGEND.

SOUTH WEST

1. HORIZONTALLY CENTER NEW US-70 SHIELD WITH EXISTING "WEST" LEGEND.  
2. VERTICALLY CENTER NEW US-70 SHIELD ON EXISTING US-29 SHIELD.



**SIGN 6121**

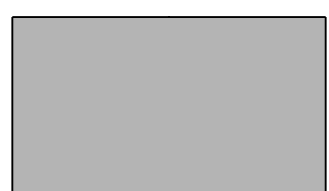

1. POSITION OVERLAY AS TO COMPLETELY COVER EXISTING "TO NORTH" LEGEND.

**SIGN 6122**

TO SOUTH

1. HORIZONTALLY CENTER NEW I-85 SHIELD WITH EXISTING "TO SOUTH" LEGEND.  
2. VERTICALLY CENTER NEW I-85 SHIELD ON EXISTING US-220 SHIELD.

**SIGN 6119**



1. POSITION OVERLAY AS TO COMPLETELY COVER EXISTING "SOUTH" LEGEND.

**SIGNS 6124,6126**



1. POSITION OVERLAY AS TO COMPLETELY COVER EXISTING "SOUTH" LEGEND.

**SIGN 6127**



1. POSITION OVERLAY AS TO COMPLETELY COVER EXISTING "NORTH" LEGEND.

TIP NO. U-2525C	SHEET NO. SIGN-6B
APPROVED: <i>Charles A. Johnson, III</i> <small>59A1562047F544E</small>	
DATE: 12/14/2017	
SEAL 	
DOCUMENT NOT CONSIDERED FINAL UNLESS ALL SIGNATURES COMPLETED	

SIGN 6128

1. POSITION OVERLAY AS TO COMPLETELY COVER EXISTING "SOUTH" LEGEND.

SIGN 6129

1. POSITION OVERLAY AS TO COMPLETELY COVER EXISTING "NORTH" LEGEND.

SIGN 6130

1. POSITION OVERLAY AS TO COMPLETELY COVER EXISTING "SOUTH" LEGEND.

SIGNS 6131, 6133, 6134

1. POSITION OVERLAY AS TO COMPLETELY COVER EXISTING "TO NORTH" LEGEND.

SIGN 6132

1. POSITION OVERLAY AS TO COMPLETELY COVER EXISTING "TO SOUTH" LEGEND.

SIGNS 6135, 6136

1. POSITION OVERLAY AS TO COMPLETELY COVER EXISTING "SOUTH" LEGEND.

SIGNS 6137, 6138, 6139

INTERSTATE 40 EAST  
1. TOP JUSTIFY "EAST" WITH EXISTING I-40 SHIELD.

SIGN 6140

1. POSITION OVERLAY AS TO COMPLETELY COVER EXISTING "NORTH" LEGEND.

SIGN 6141

1. POSITION OVERLAY AS TO COMPLETELY COVER EXISTING "SOUTH" LEGEND.

SIGN 6142

1. POSITION OVERLAY AS TO COMPLETELY COVER EXISTING "TO NORTH" LEGEND.

SIGN 6143

1. POSITION OVERLAY AS TO COMPLETELY COVER EXISTING "SOUTH" LEGEND.

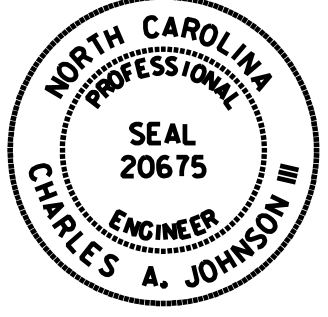

TIP NO. U-2525C	SHEET NO. SIGN-7
Approved by: <u>Charles A. Johnson, III</u> <small>SEA1562475446</small>	
DATE: 12/14/2017	
SEAL 	
DOCUMENT NOT CONSIDERED FINAL UNLESS ALL SIGNATURES COMPLETED	

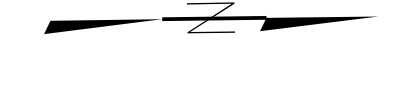
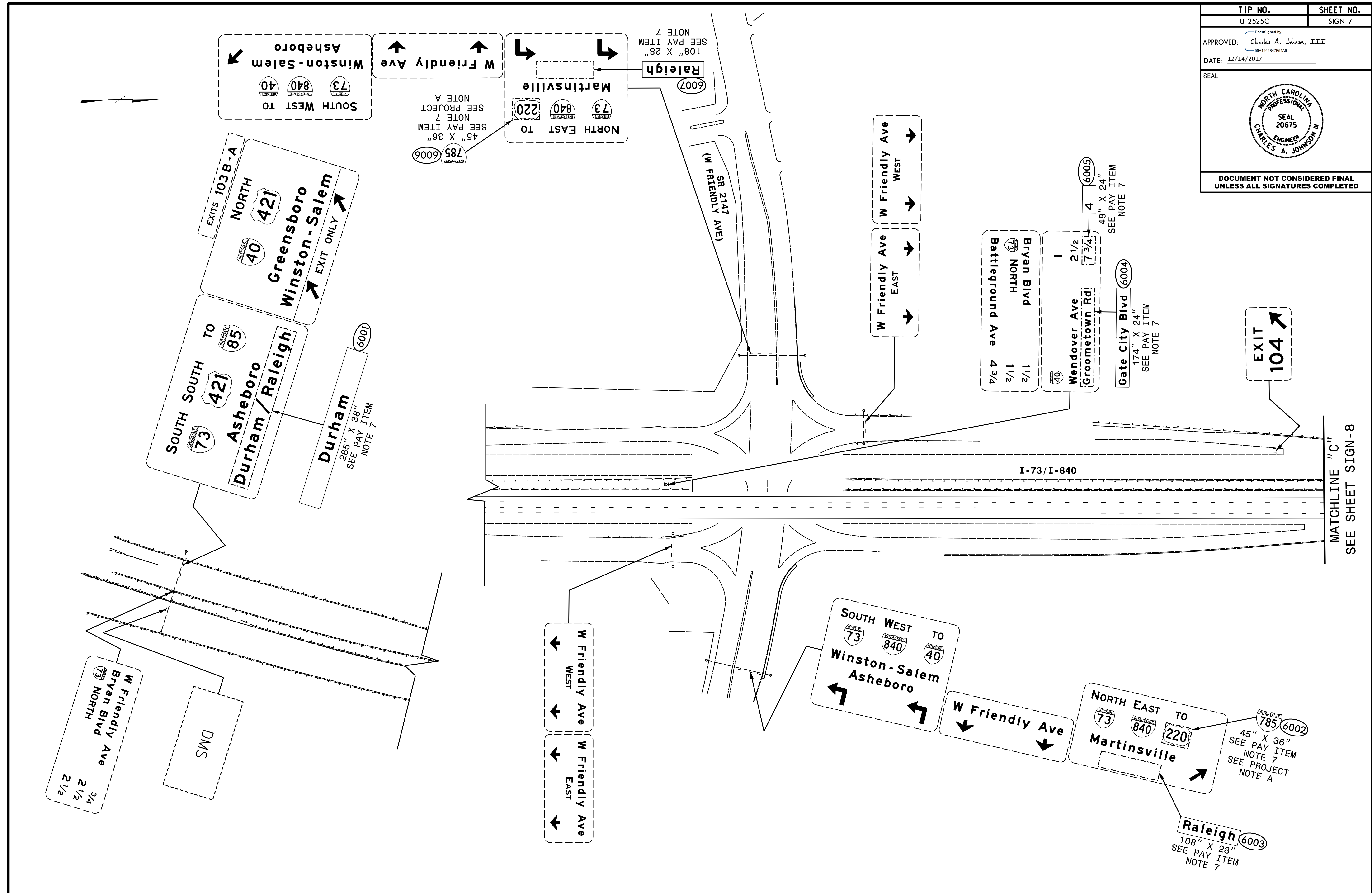

MATCHLINE "C"  
SEE SHEET SIGN-8



HNTB NORTH CAROLINA, P.C.  
 343 E. Six Forks Road, Suite 200  
 Raleigh, North Carolina 27609  
 NC License No: C-1554  
 (919) 546-8997

**EXISTING AND PROPOSED SIGNS**  
**I-73/I-840**



TIP NO. U-2525C	SHEET NO. SIGN-8
APPROVED: <u>Charles A. Johnson, III</u> <small>DocuSigned by: Charles A. Johnson, III 59A1955B47F54A6</small>	
DATE: 12/14/2017	
SEAL	
	
DOCUMENT NOT CONSIDERED FINAL UNLESS ALL SIGNATURES COMPLETED	

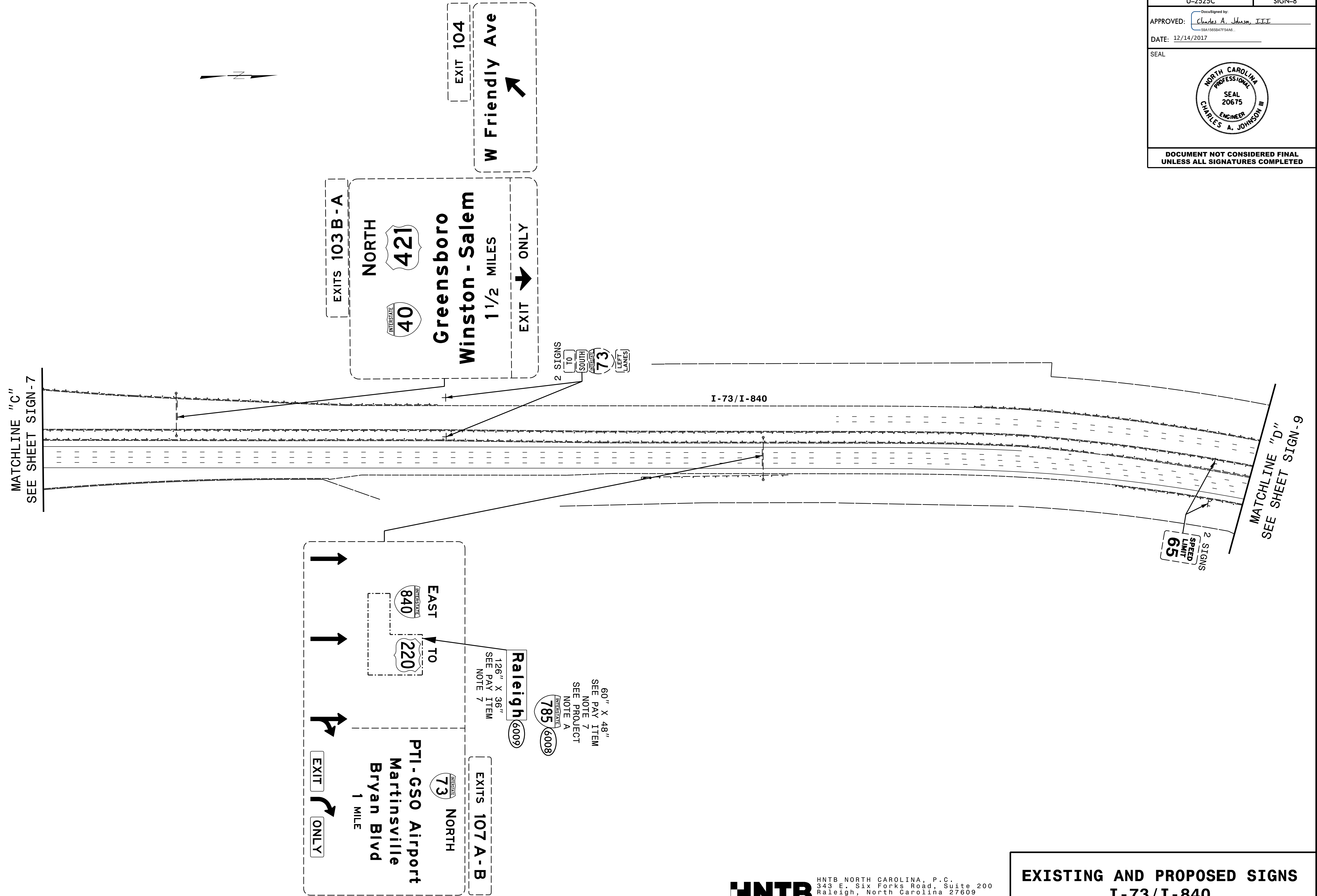

**HNTB** HNTB NORTH CAROLINA, P.C.  
 343 E. Six Forks Road, Suite 200  
 Raleigh, North Carolina 27609  
 NC License No: C-1554  
 (919) 546-8997

**EXISTING AND PROPOSED SIGNS  
I-73/I-840**

TIP NO. U-2525C	SHEET NO. SIGN-9
APPROVED: <i>Charles A. Johnson, III</i> <small>SSA1560847F546</small>	
DATE: 12/14/2017	
SEAL	
	
DOCUMENT NOT CONSIDERED FINAL UNLESS ALL SIGNATURES COMPLETED	

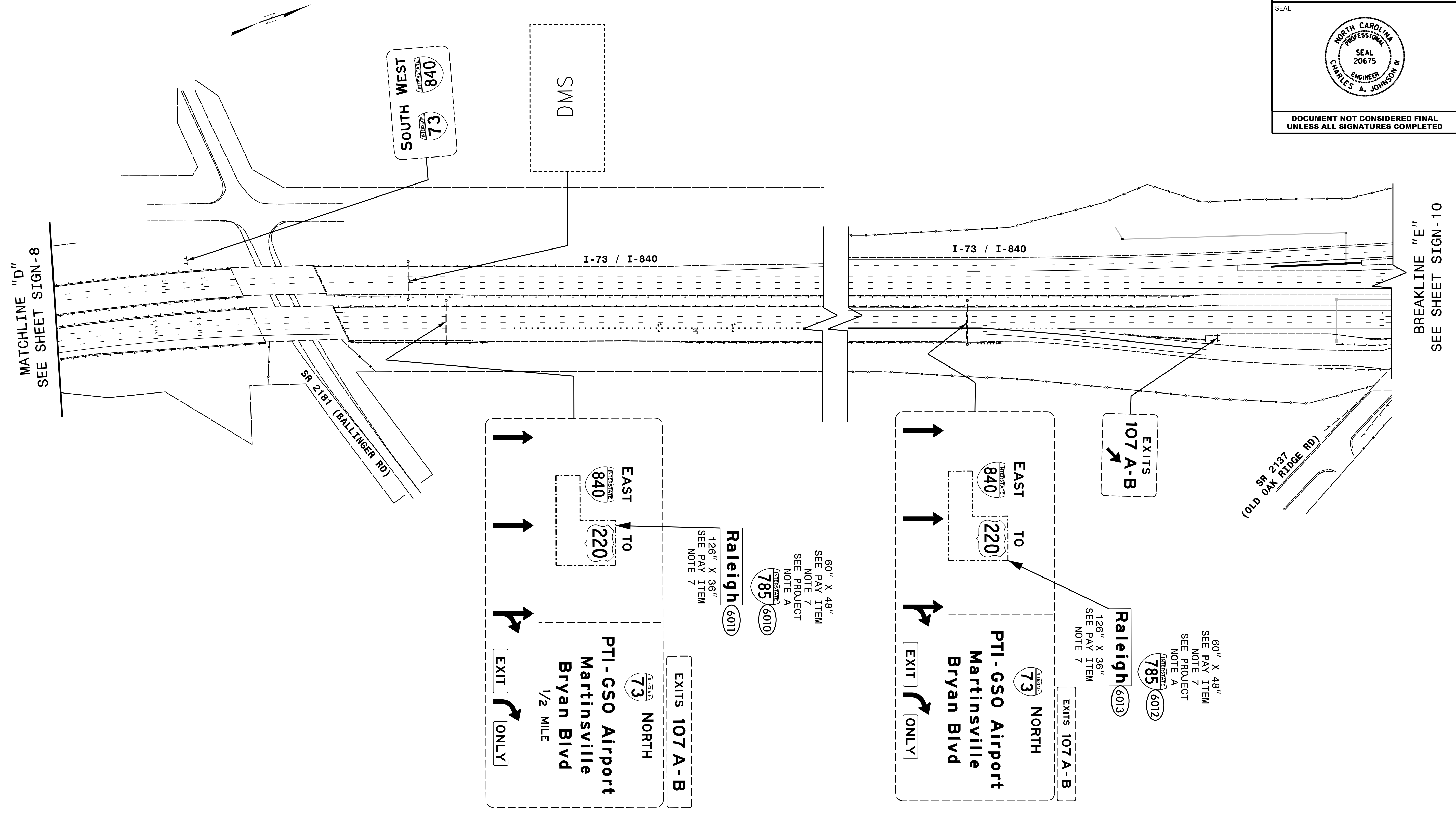

**HNTB**  
 HNTB NORTH CAROLINA, P.C.  
 343 E. Six Forks Road, Suite 200  
 Raleigh, North Carolina 27609  
 NC License No: C-1554  
 (919) 546-8997

**EXISTING AND PROPOSED SIGNS  
I-73/I-840**

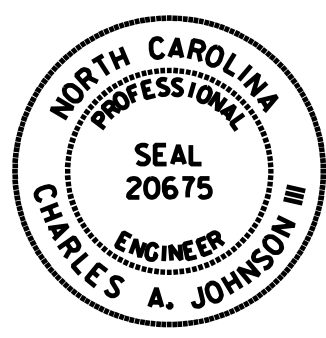

MATCHLINE "G"  
SEE SHEET SIGN-12

TIP NO. U-2525C	SHEET NO. SIGN-10
APPROVED: <i>Charles A. Johnson, III</i> SEALED 15681475448	
DATE: 12/14/2017	
SEAL 	
DOCUMENT NOT CONSIDERED FINAL UNLESS ALL SIGNATURES COMPLETED	

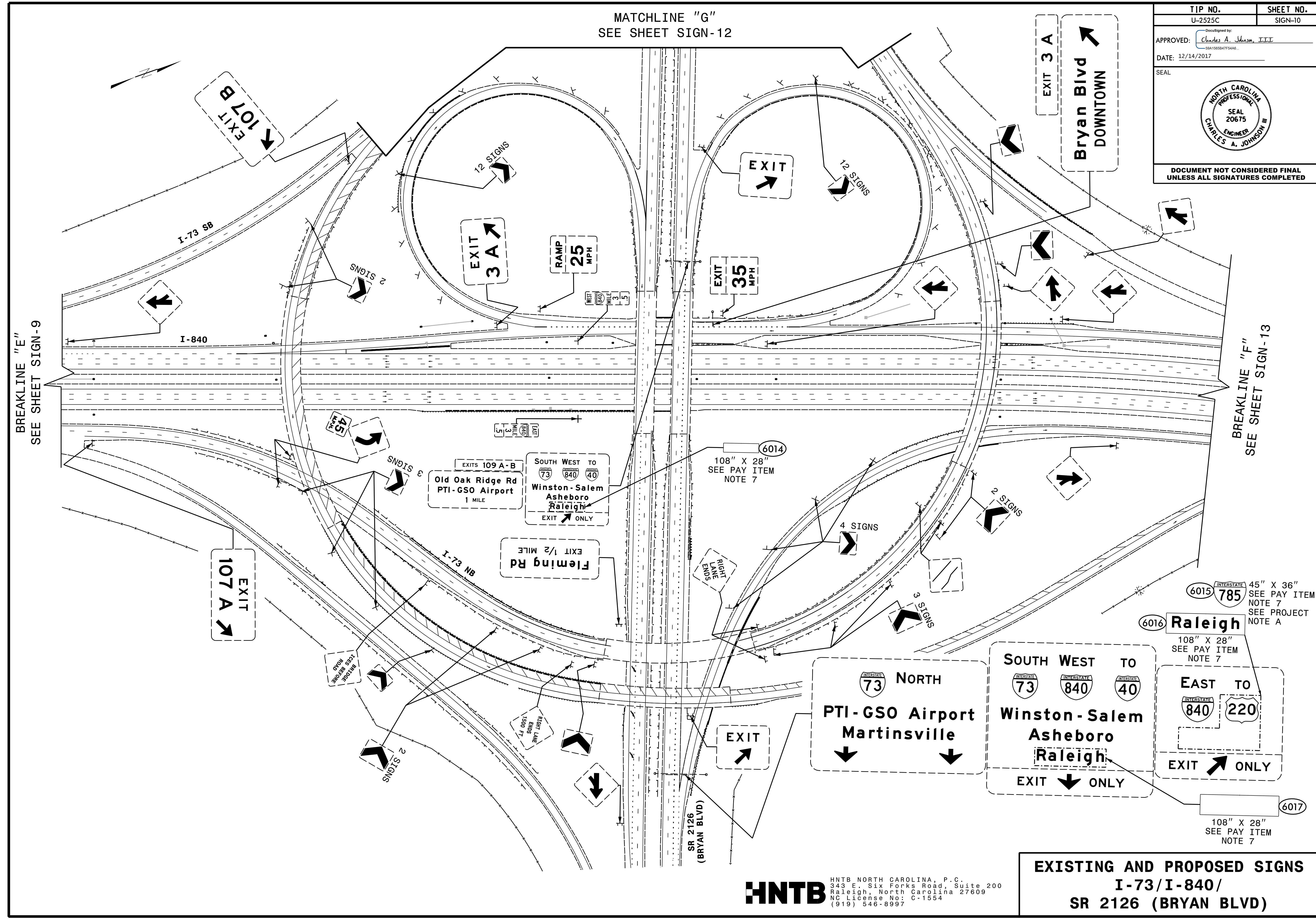

**HNTB**  
 HNTB NORTH CAROLINA, P.C.  
 343 E. Six Forks Road, Suite 200  
 Raleigh, North Carolina 27609  
 NC License No: C-1554  
 (919) 546-8997

**EXISTING AND PROPOSED SIGNS  
 I-73/I-840/  
 SR 2126 (BRYAN BLVD)**



TIP NO. U-2525C	SHEET NO. SIGN-11
APPROVED: <i>Charles A. Johnson, III</i> <small>SSA1568B47F54A6...</small>	
DATE: 12/14/2017	
SEAL	
	
DOCUMENT NOT CONSIDERED FINAL UNLESS ALL SIGNATURES COMPLETED	

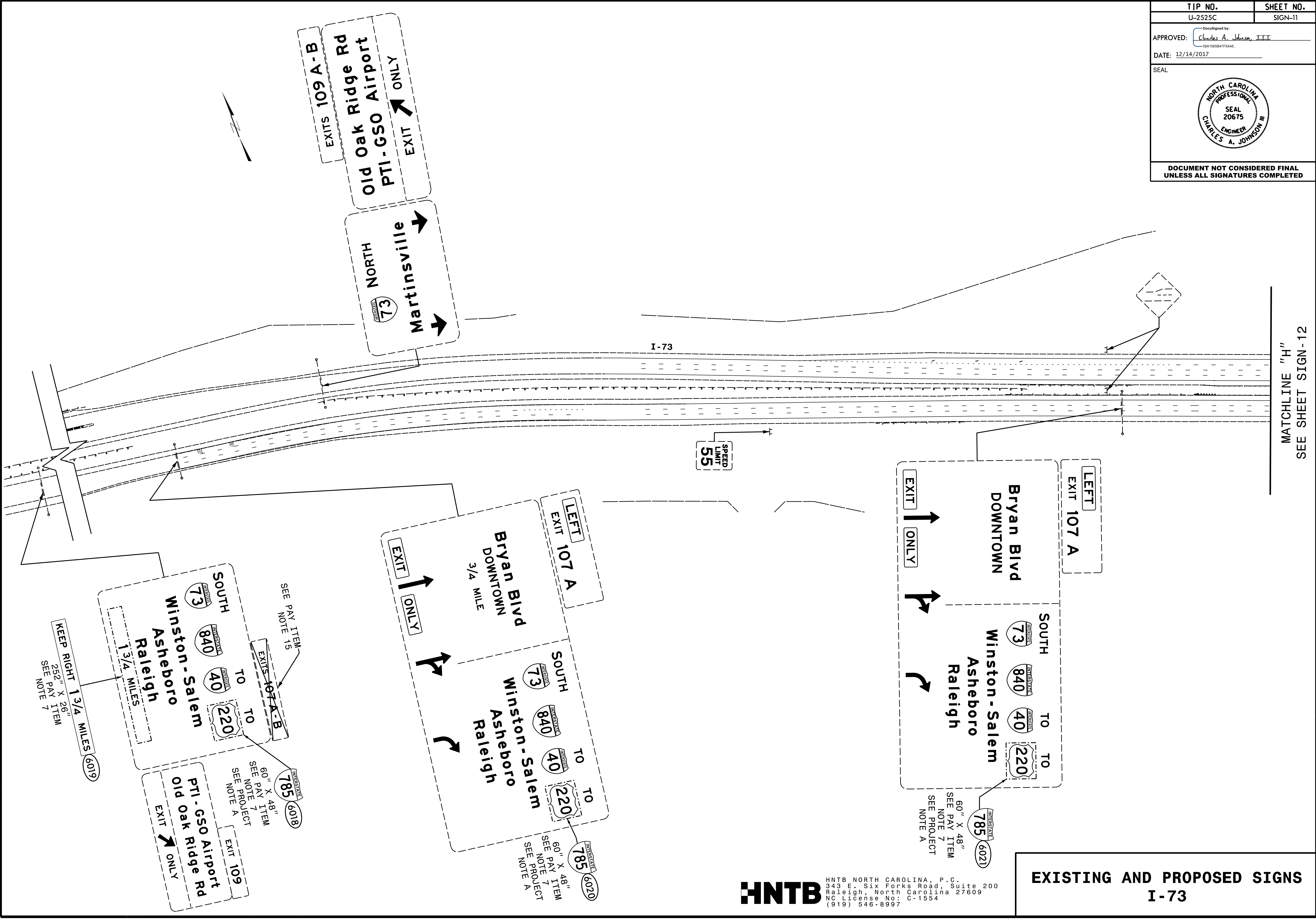

**HNTB** HNTB NORTH CAROLINA, P.C.  
 343 E. Six Forks Road, Suite 200  
 Raleigh, North Carolina 27609  
 No. License No: C-1554  
 (919) 546-8997

**EXISTING AND PROPOSED SIGNS  
I-73**

MATCHLINE "H"  
SEE SHEET SIGN-12



TIP NO. U-2525C	SHEET NO. SIGN-12
APPROVED: <i>Charles A. Johnson, III</i> <small>DocuSigned by: Charles A. Johnson, III 5061592847F5446</small>	
DATE: 12/14/2017	
SEAL	
	
DOCUMENT NOT CONSIDERED FINAL UNLESS ALL SIGNATURES COMPLETED	

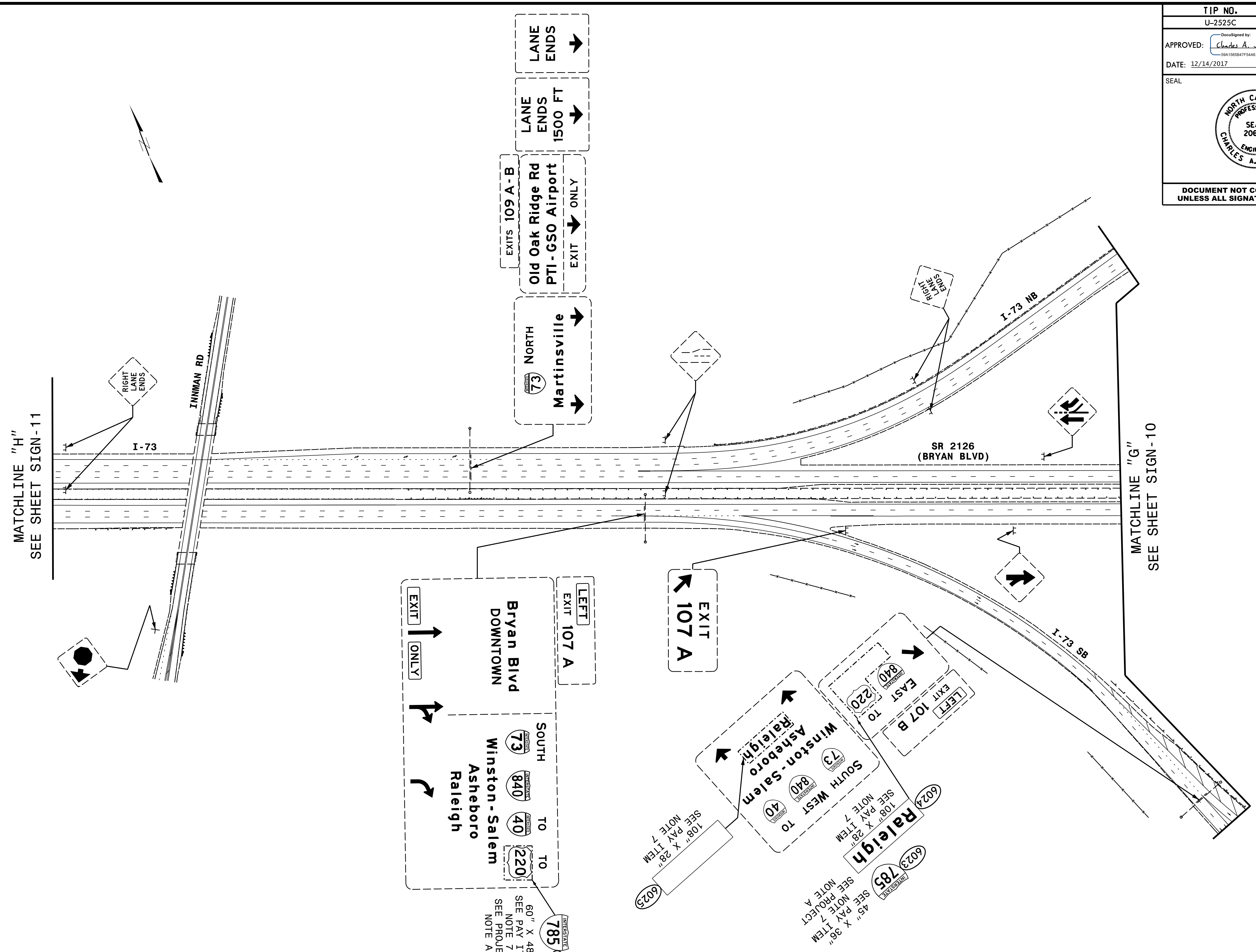

**HNTB** HNTB NORTH CAROLINA, P.C.  
 343 E. Six Forks Road, Suite 200  
 Raleigh, North Carolina 27609  
 NC License No: C-1554  
 (919) 546-8997

**EXISTING AND PROPOSED SIGNS  
 I-73/SR 2126 (BRYAN BLVD)**

TIP NO. U-2525C	SHEET NO. SIGN-13
APPROVED: <i>Charles A. Johnson, III</i> <small>58A1562847F5A4E</small>	
DATE: 12/14/2017	
SEAL	
	
DOCUMENT NOT CONSIDERED FINAL UNLESS ALL SIGNATURES COMPLETED	

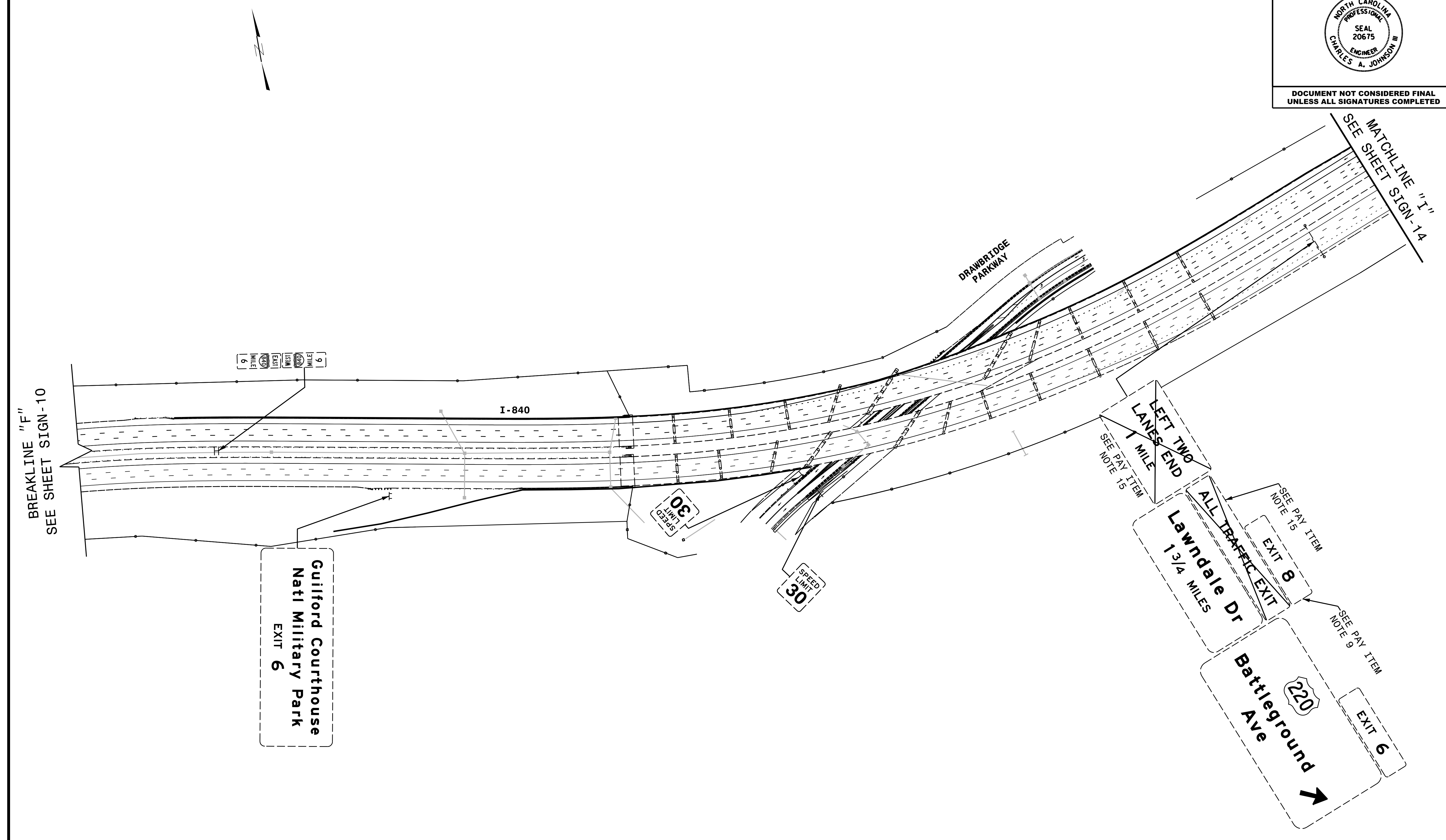

**HNTB** HNTB NORTH CAROLINA, P.C.  
343 E. Six Forks Road, Suite 200  
Raleigh, North Carolina 27609  
NC License No: C-1554  
(919) 546-8997

**EXISTING AND PROPOSED SIGNS  
I-840**

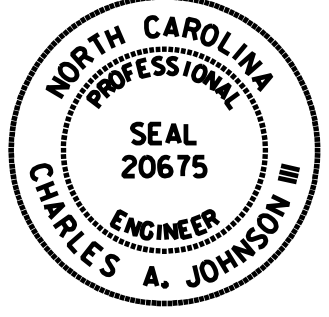

TIP NO. U-2525C	SHEET NO. SIGN-14
APPROVED: <i>Charles A. Johnson, III</i> <small>59A1562847F5A4E</small>	
DATE: 12/14/2017	
SEAL	
	
DOCUMENT NOT CONSIDERED FINAL UNLESS ALL SIGNATURES COMPLETED	

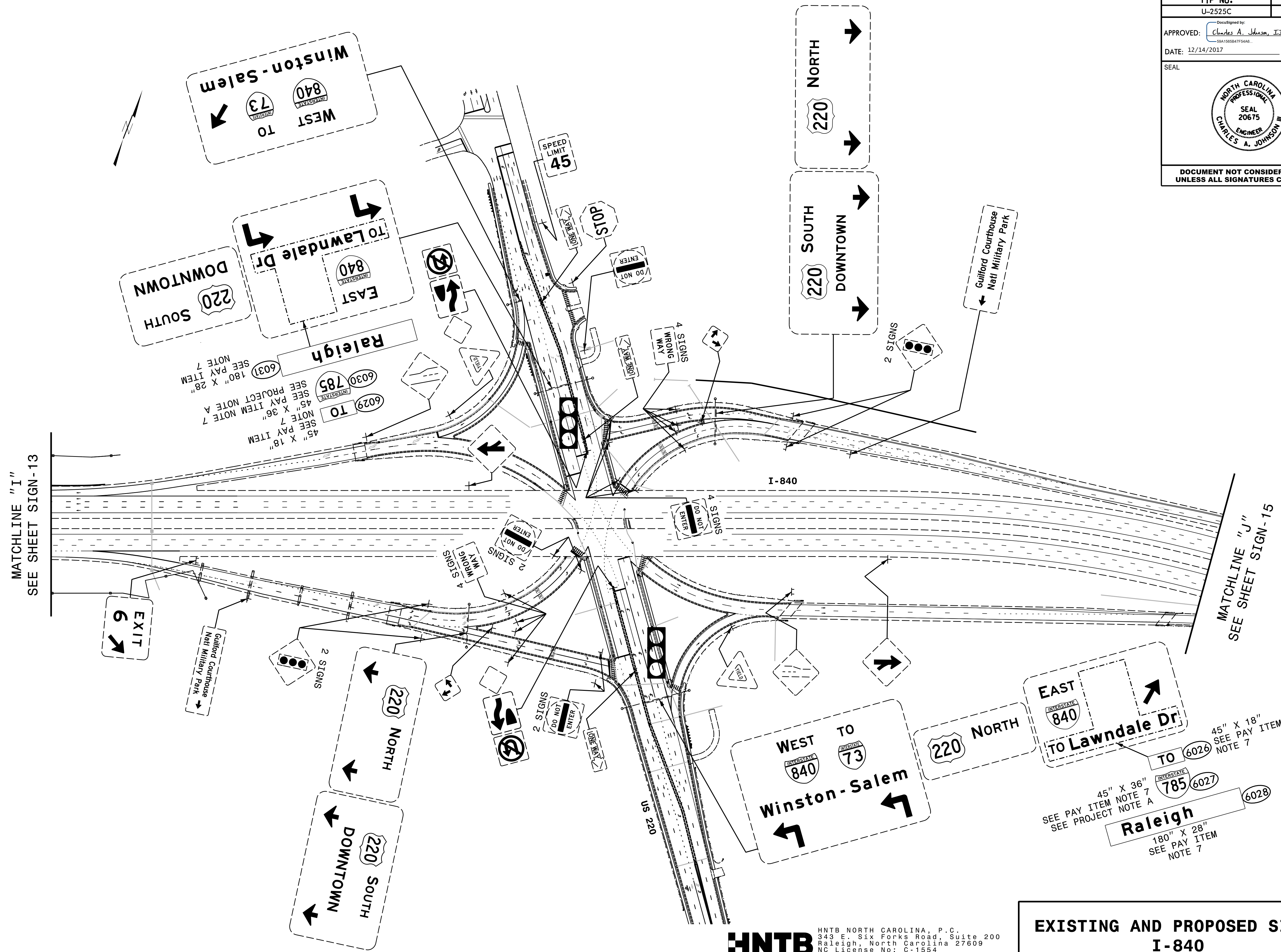

MATCHLINE "I"  
SEE SHEET SIGN-13

MATCHLINE "J"  
SEE SHEET SIGN-15

45" X 18"  
SEE PAY ITEM  
NOTE 7

6029 TO  
SEE PAY ITEM NOTE 7  
NOTE 7  
45" X 36"  
SEE PROJECT NOTE A  
SEE PAY ITEM NOTE 7

6030 785  
SEE PROJECT NOTE A  
SEE PAY ITEM NOTE 7  
NOTE 7  
180" X 28"  
SEE PAY ITEM  
NOTE 7

6031  
SEE PROJECT NOTE A  
SEE PAY ITEM NOTE 7  
NOTE 7  
180" X 28"  
SEE PAY ITEM  
NOTE 7

45" X 18"  
SEE PAY ITEM  
NOTE 7

45" X 36"  
SEE PAY ITEM NOTE 7  
SEE PROJECT NOTE A

6026 TO  
SEE PAY ITEM  
NOTE 7

6027 785  
SEE PROJECT NOTE A

6028 TO  
SEE PAY ITEM  
NOTE 7

180" X 28"  
SEE PAY ITEM  
NOTE 7



TIP NO. U-2525C	SHEET NO. SIGN-15
APPROVED: <i>Charles A. Johnson, III</i> <small>DocuSigned by: 59A1562B47F5A4E</small>	
DATE: 12/14/2017	
SEAL	
	
DOCUMENT NOT CONSIDERED FINAL UNLESS ALL SIGNATURES COMPLETED	

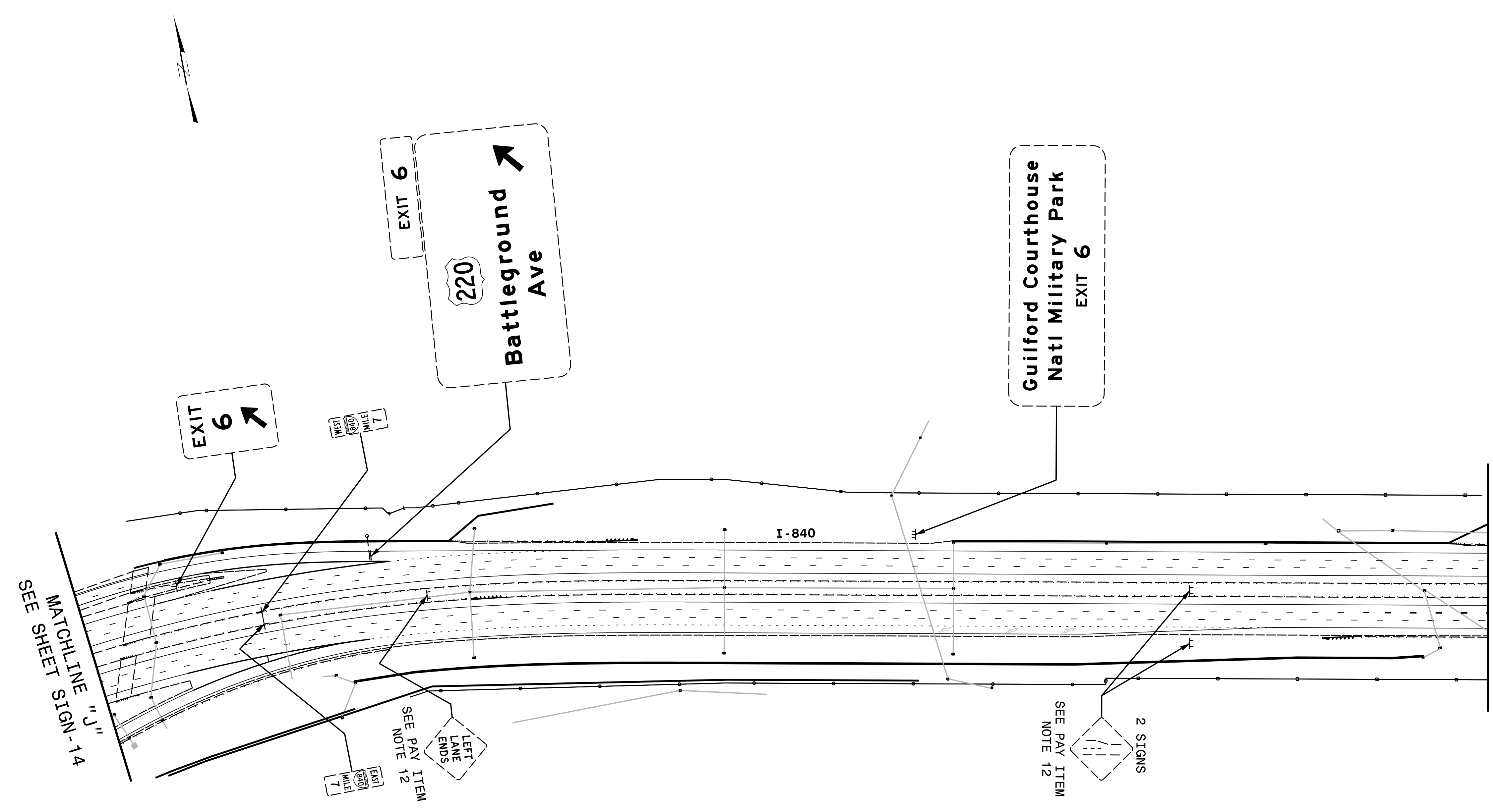

TIP NO. U-2525C	SHEET NO. SIGN-16
APPROVED: <i>Charles A. Johnson, III</i> <small>59A1562847F5A4E</small>	
DATE: 12/14/2017	
SEAL	
	
DOCUMENT NOT CONSIDERED FINAL UNLESS ALL SIGNATURES COMPLETED	

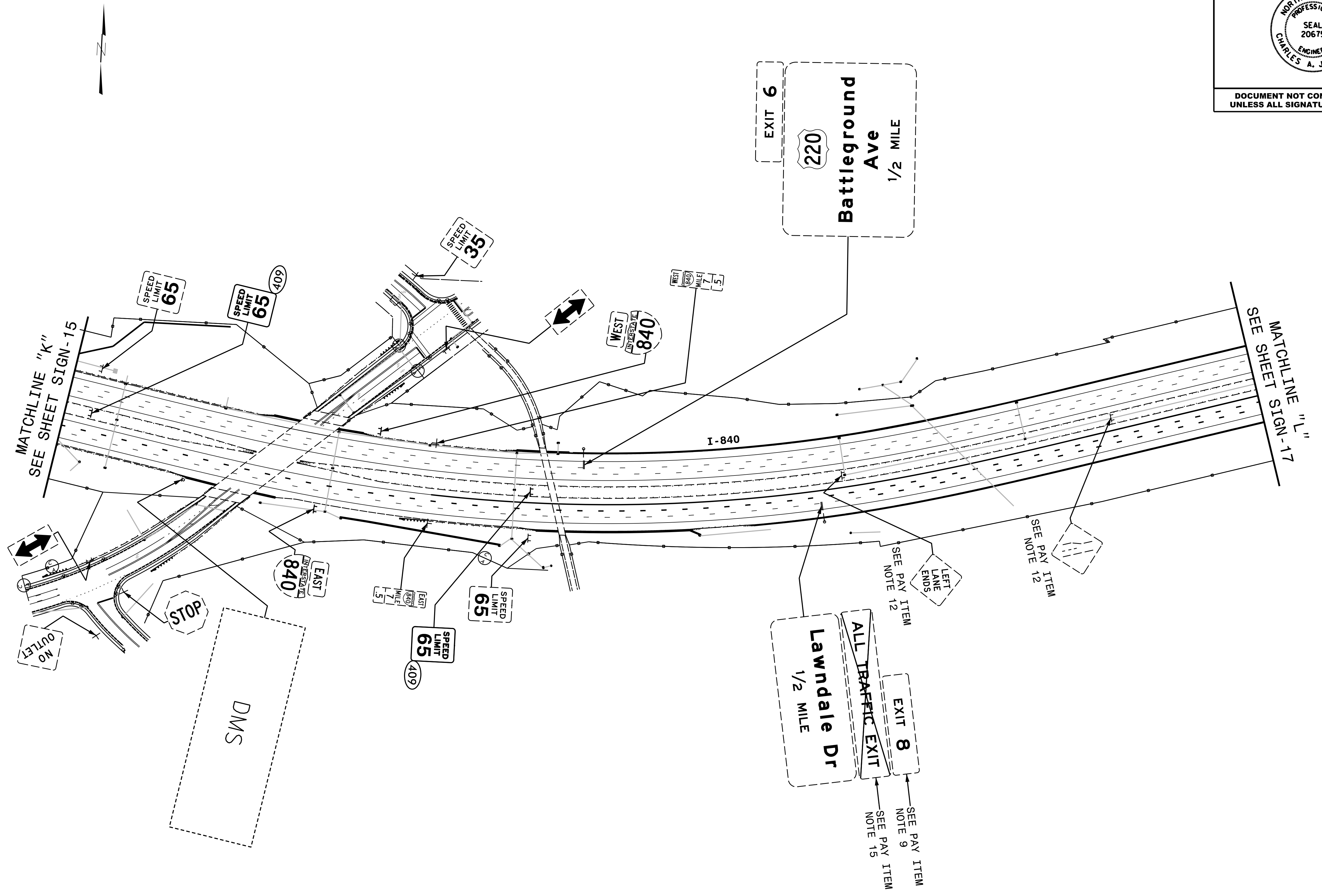

TIP NO. U-2525C	SHEET NO. SIGN-17
APPROVED: <i>Charles A. Johnson, III</i> <small>59A1562847F5A4E</small>	
DATE: 12/14/2017	
SEAL	
	
DOCUMENT NOT CONSIDERED FINAL UNLESS ALL SIGNATURES COMPLETED	

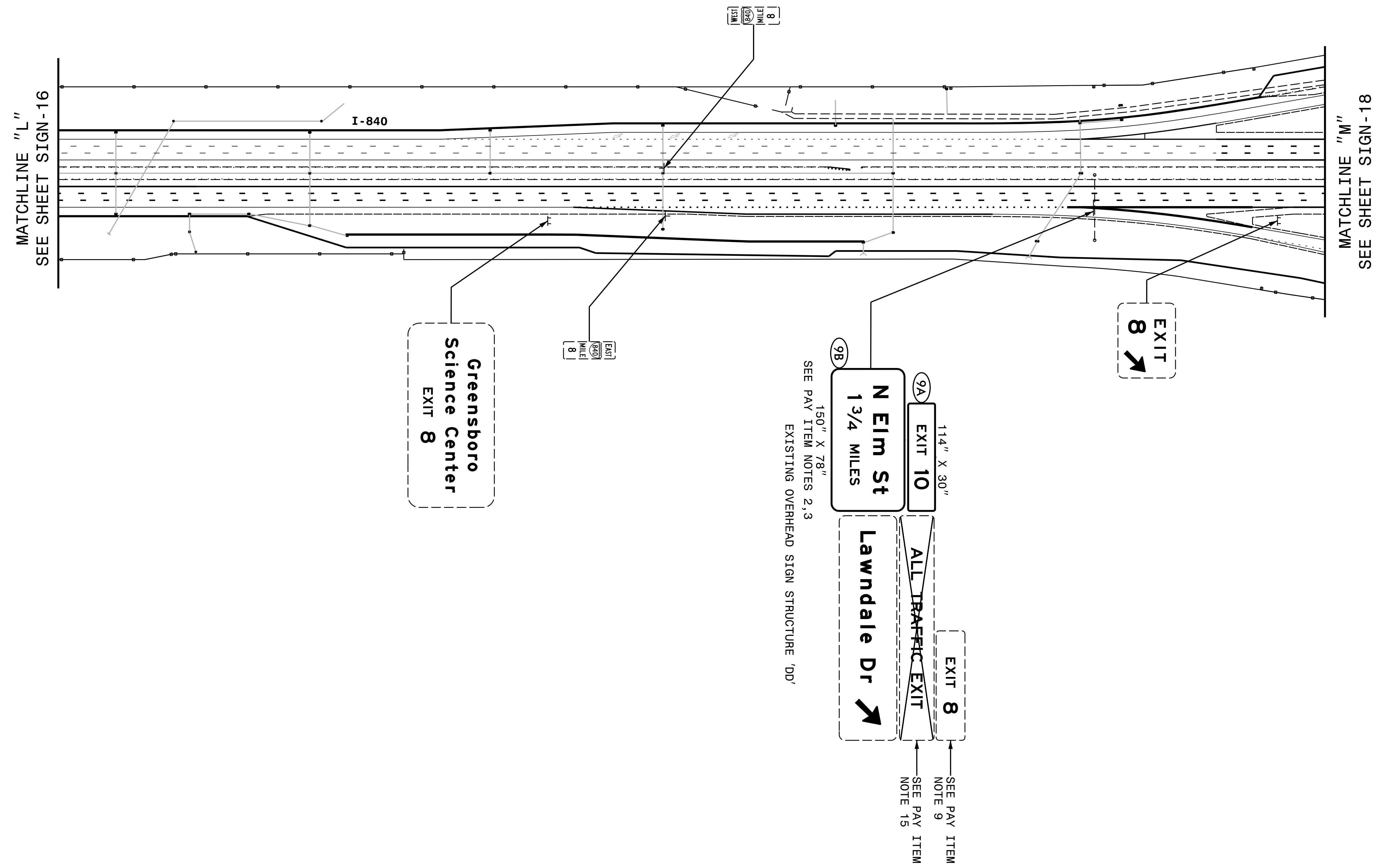



TIP NO. U-2525C	SHEET NO. SIGN-18
APPROVED: <i>Charles A. Johnson, III</i> <small>59A15628475446</small>	
DATE: 12/14/2017	
SEAL	
	
DOCUMENT NOT CONSIDERED FINAL UNLESS ALL SIGNATURES COMPLETED	

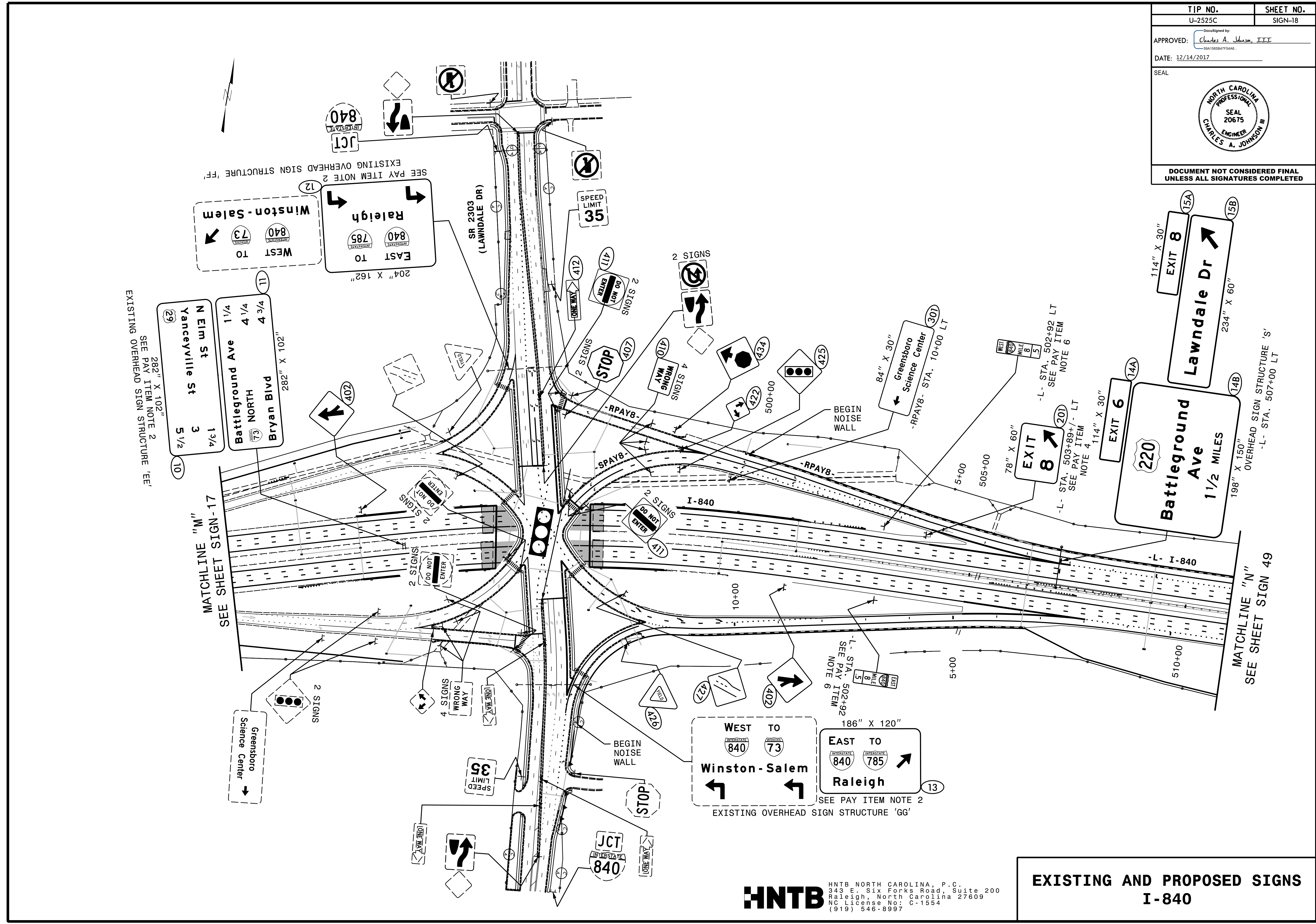

EXISTING OVERHEAD SIGN STRUCTURE 'EE'  
SEE PAY ITEM NOTE 2  
282" X 102"

EXISTING OVERHEAD SIGN STRUCTURE 'FF'  
SEE PAY ITEM NOTE 2  
204" X 162"

MATCHLINE "M"  
SEE SHEET SIGN-17

MATCHLINE "N"  
SEE SHEET SIGN 49

186" X 120"  
WEST TO  
840 73  
Winston-Salem  
EAST TO  
840 785  
Raleigh  
SEE PAY ITEM NOTE 2  
EXISTING OVERHEAD SIGN STRUCTURE 'GG'

**EXISTING AND PROPOSED SIGNS  
I-840**

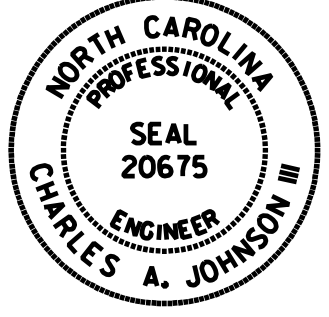

TIP NO. U-2525C	SHEET NO. SIGN-19
APPROVED: <i>Charles A. Johnson, III</i> <small>DocuSigned by: Charles A. Johnson, III SPA1568477544E</small>	
DATE: 12/14/2017	
SEAL	
	
DOCUMENT NOT CONSIDERED FINAL UNLESS ALL SIGNATURES COMPLETED	

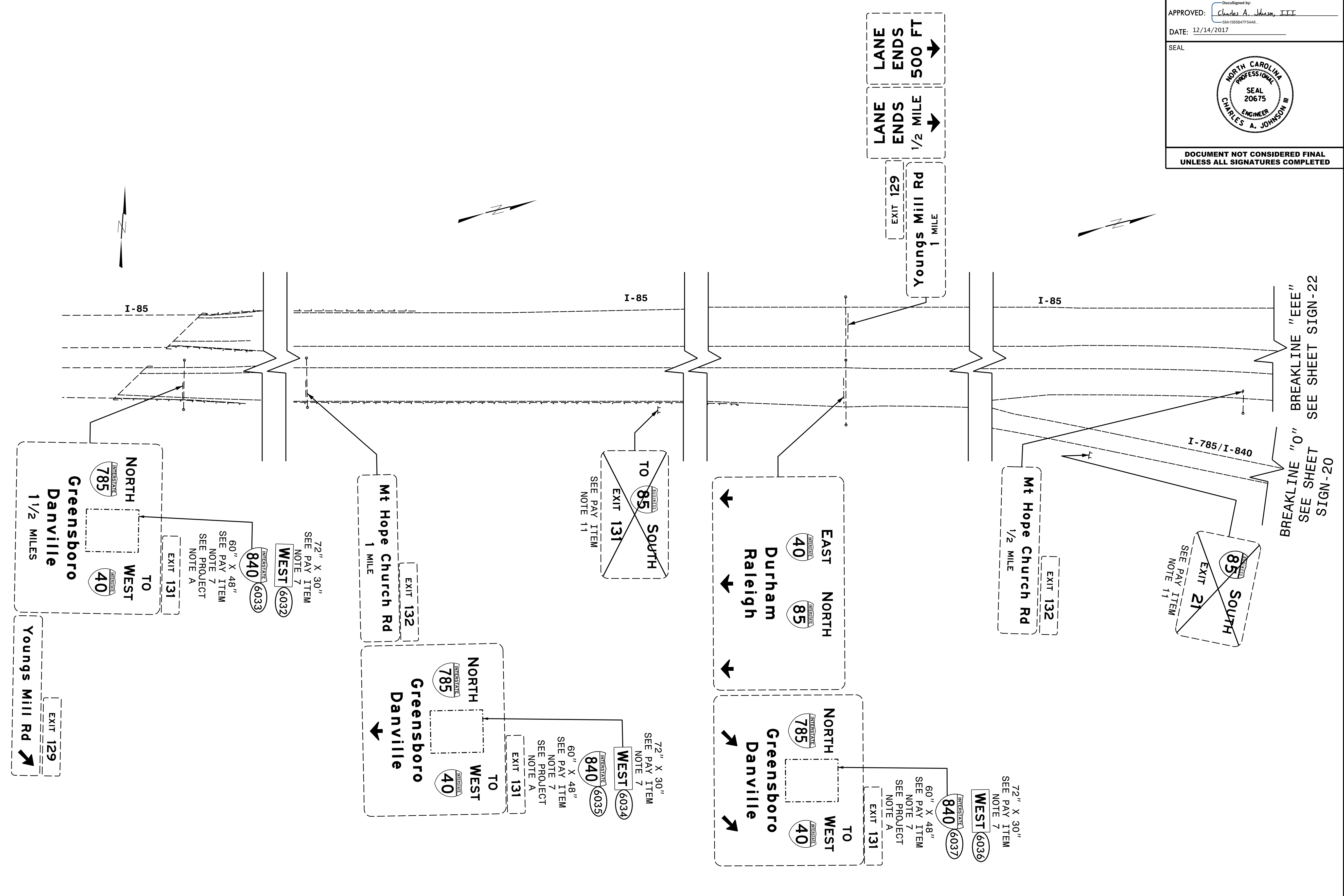

**EXISTING AND PROPOSED SIGNS  
I-85**

TIP NO. U-2525C	SHEET NO. SIGN-20
APPROVED: <i>Charles A. Johnson, III</i> <small>DocuSigned by: Charles A. Johnson, III 59A1562B47F5A4E</small>	
DATE: 12/14/2017	
SEAL 	
DOCUMENT NOT CONSIDERED FINAL UNLESS ALL SIGNATURES COMPLETED	

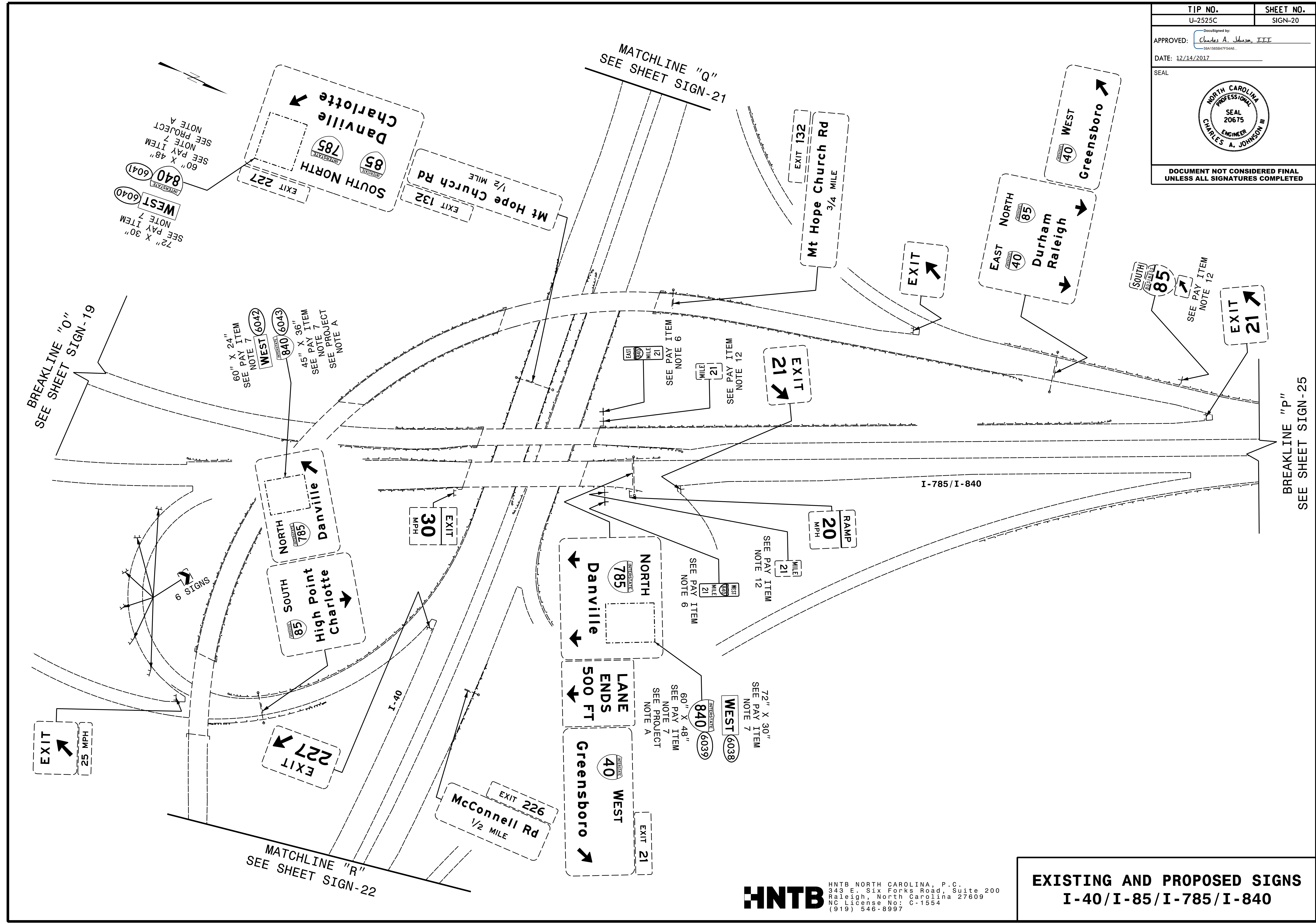

**HNTB**  
 HNTB NORTH CAROLINA, P.C.  
 343 E. Six Forks Road, Suite 200  
 Raleigh, North Carolina 27609  
 NC License No: C-1554  
 (919) 546-8997

**EXISTING AND PROPOSED SIGNS  
 I-40/I-85/I-785/I-840**



TIP NO. U-2525C	SHEET NO. SIGN-21
APPROVED: <i>Charles A. Johnson, III</i> <small>59A1562047F5A4E</small>	
DATE: 12/14/2017	
SEAL	
	
DOCUMENT NOT CONSIDERED FINAL UNLESS ALL SIGNATURES COMPLETED	

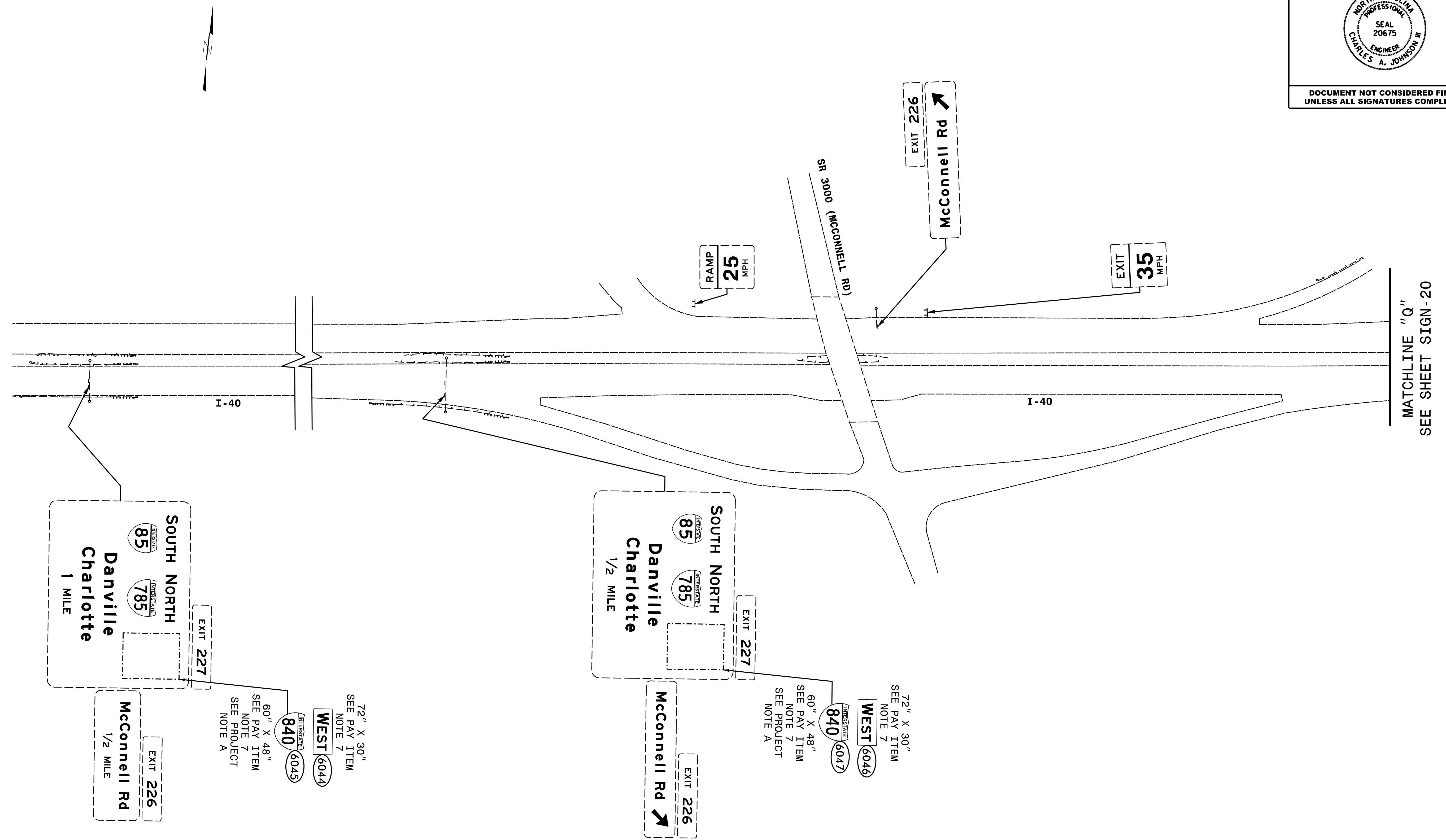

MATCHLINE "Q"  
SEE SHEET SIGN-20

TIP NO. U-2525C	SHEET NO. SIGN-22
APPROVED: <i>Charles A. Johnson, III</i> <small>58A1562847F5A4E</small>	
DATE: 12/14/2017	
SEAL	
	
DOCUMENT NOT CONSIDERED FINAL UNLESS ALL SIGNATURES COMPLETED	

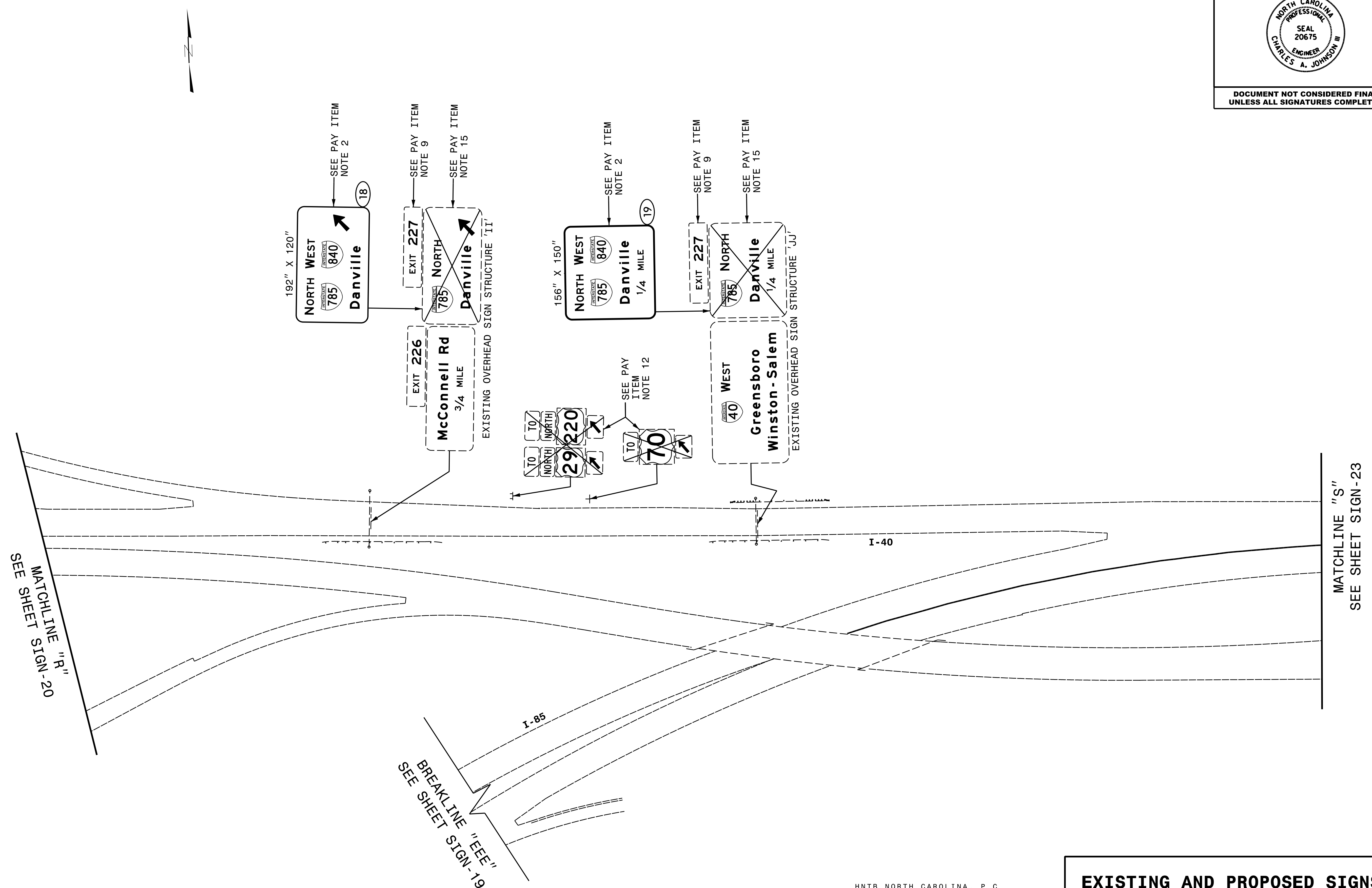

**HNTB** HNTB NORTH CAROLINA, P.C.  
343 E. Six Forks Road, Suite 200  
Raleigh, North Carolina 27609  
NC License No: C-1554  
(919) 546-8997

**EXISTING AND PROPOSED SIGNS  
I-40/I-85**



TIP NO. U-2525C	SHEET NO. SIGN-23
APPROVED: <u>Charles A. Johnson, III</u> <small>59A1562847F5A4E</small>	
DATE: 12/14/2017	
SEAL	
	
DOCUMENT NOT CONSIDERED FINAL UNLESS ALL SIGNATURES COMPLETED	

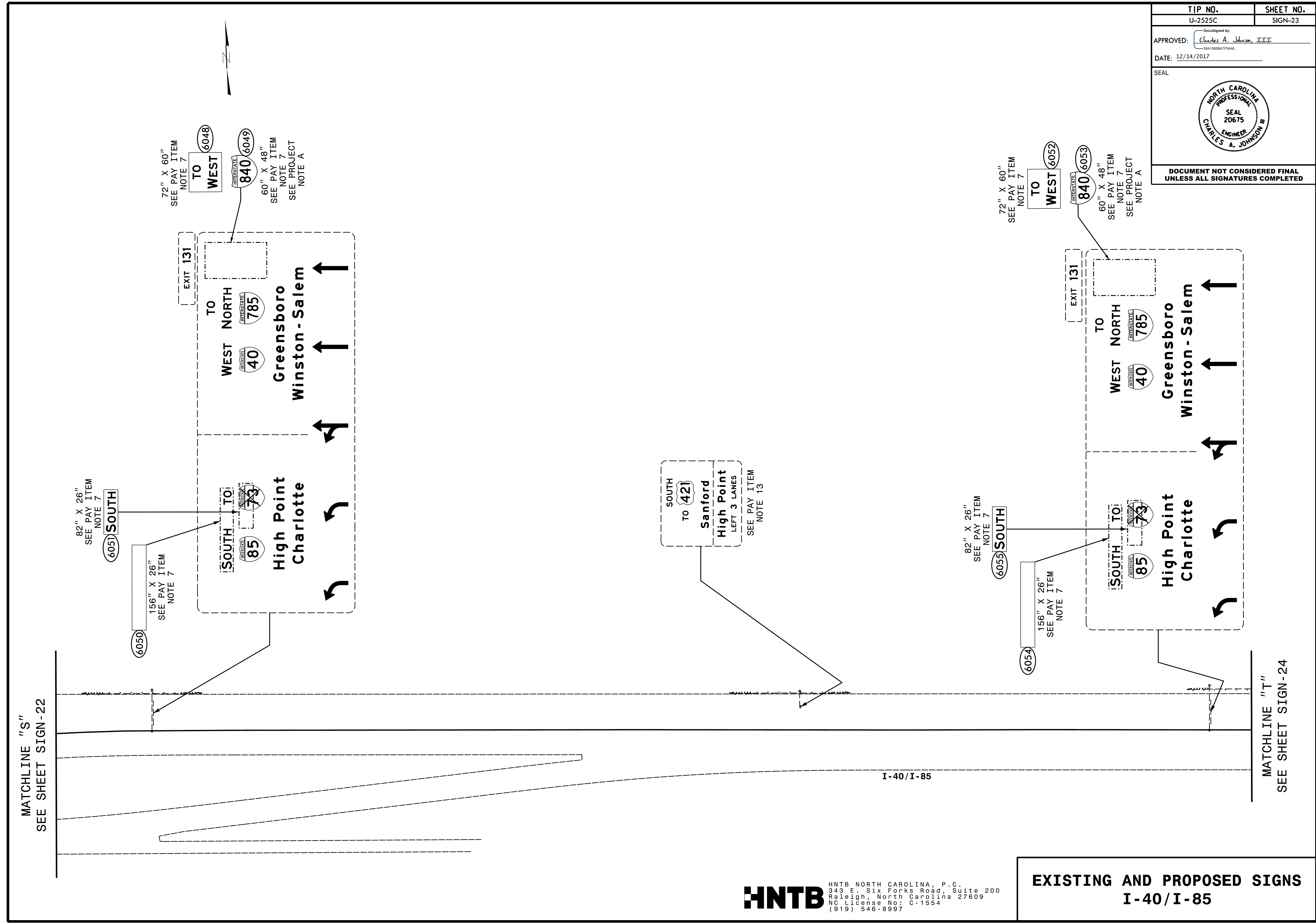

**HNTB**  
 HNTB NORTH CAROLINA, P.C.  
 343 E. Six Forks Road, Suite 200  
 Raleigh, North Carolina 27609  
 NC License No: C-1554  
 (919) 546-8997

**EXISTING AND PROPOSED SIGNS  
 I-40/I-85**

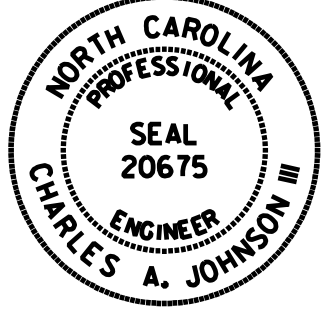
TIP NO. U-2525C	SHEET NO. SIGN-24
APPROVED: <i>Charles A. Johnson, III</i> SSA15010475468	
DATE: 12/15/2017	
SEAL	
	
DOCUMENT NOT CONSIDERED FINAL UNLESS ALL SIGNATURES COMPLETED	

- ITS CONSTRUCTION NOTES**
- 1 INSTALL NEW TRAVEL TIME DMS MODULES
  - 2 INSTALL NEW POLE MOUNTED CABINET

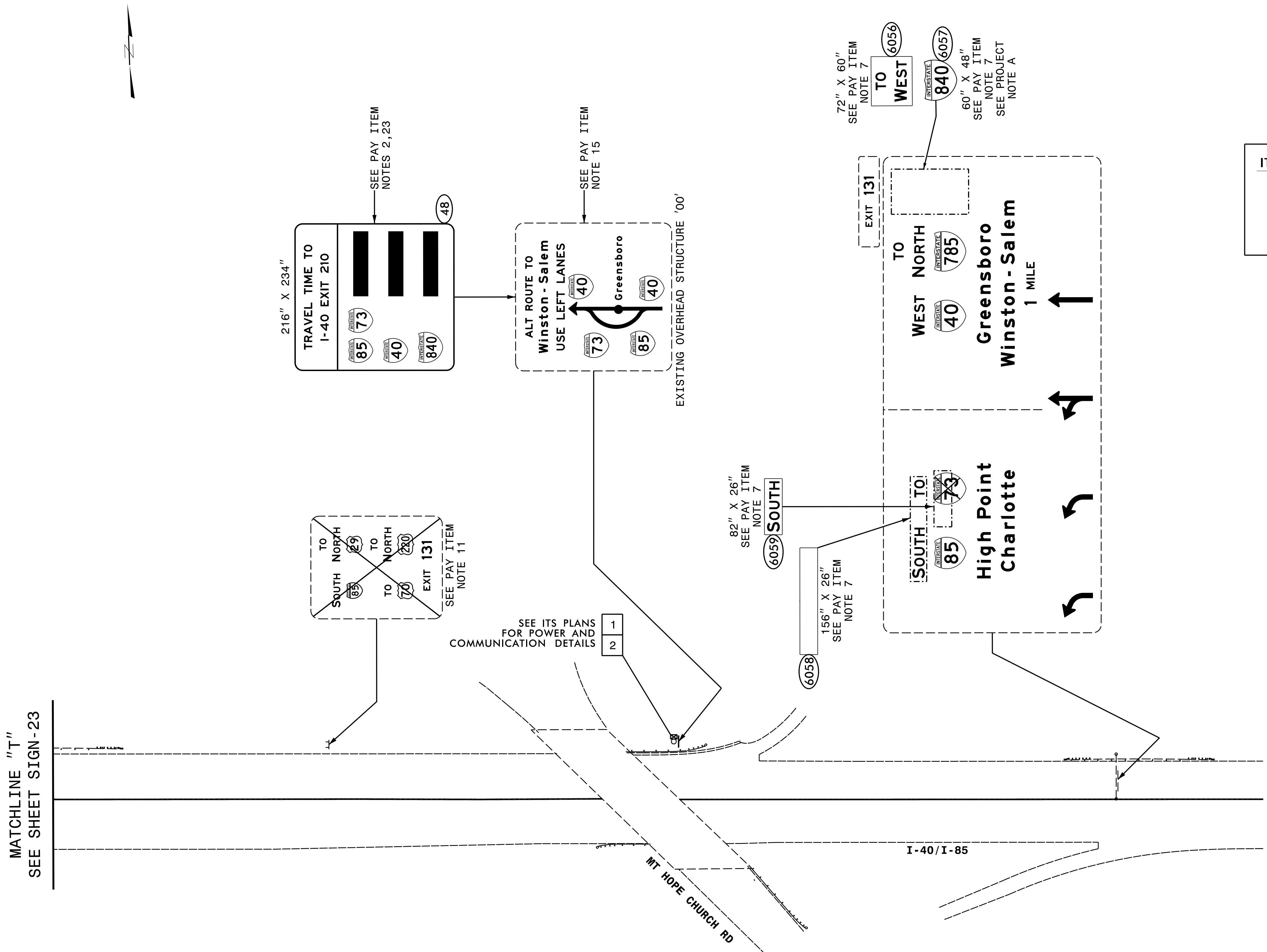



TIP NO. U-2525C	SHEET NO. SIGN-25
APPROVED: <i>Charles A. Johnson, III</i> <small>58A1562847F5A4E</small>	
DATE: 12/14/2017	
SEAL	
	
DOCUMENT NOT CONSIDERED FINAL UNLESS ALL SIGNATURES COMPLETED	

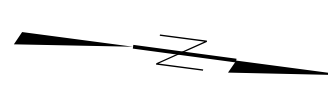
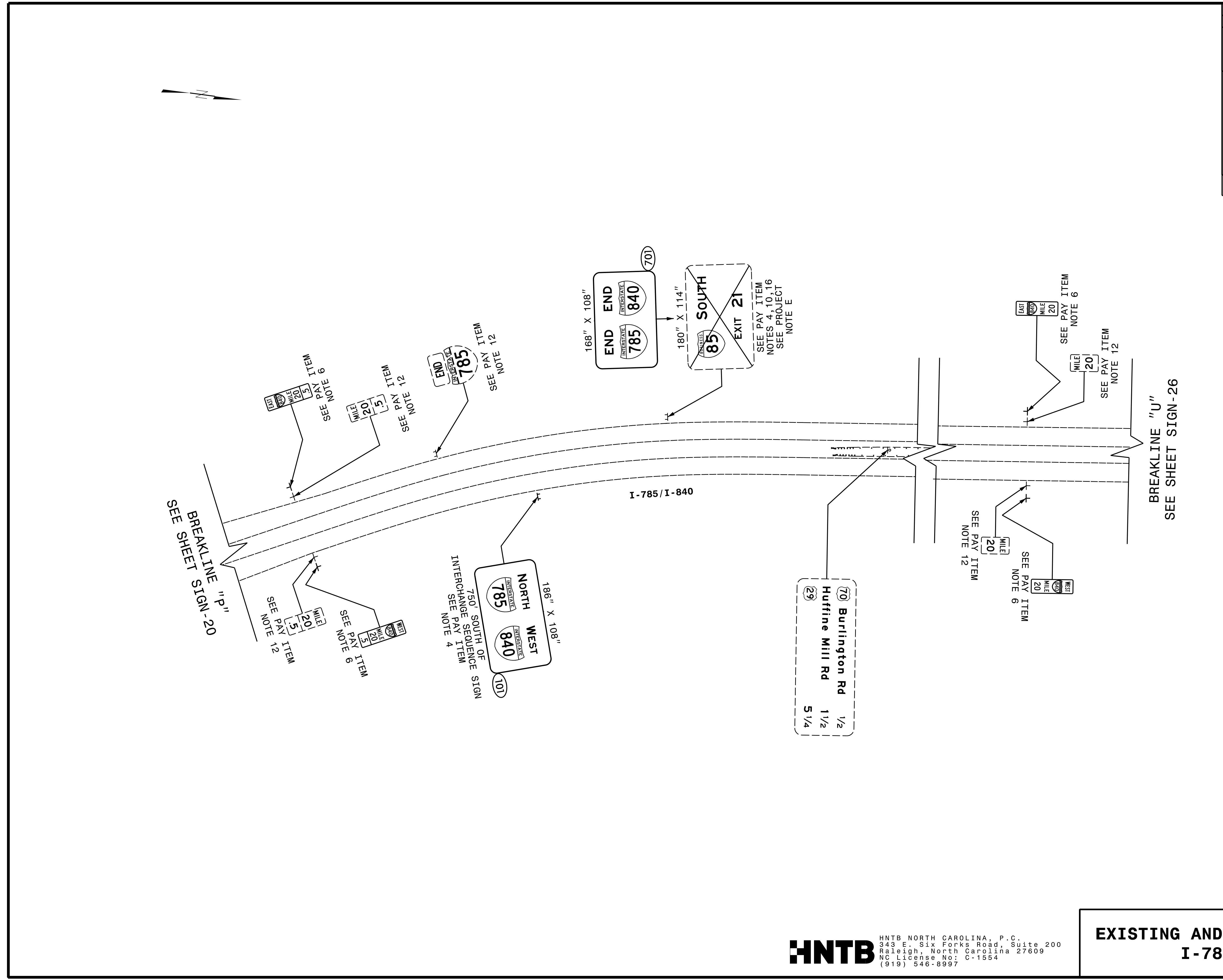

TIP NO. U-2525C	SHEET NO. SIGN-26
APPROVED: <i>Charles A. Johnson, III</i> <small>59A1562847F5A4E</small>	
DATE: 12/14/2017	
SEAL 	
DOCUMENT NOT CONSIDERED FINAL UNLESS ALL SIGNATURES COMPLETED	

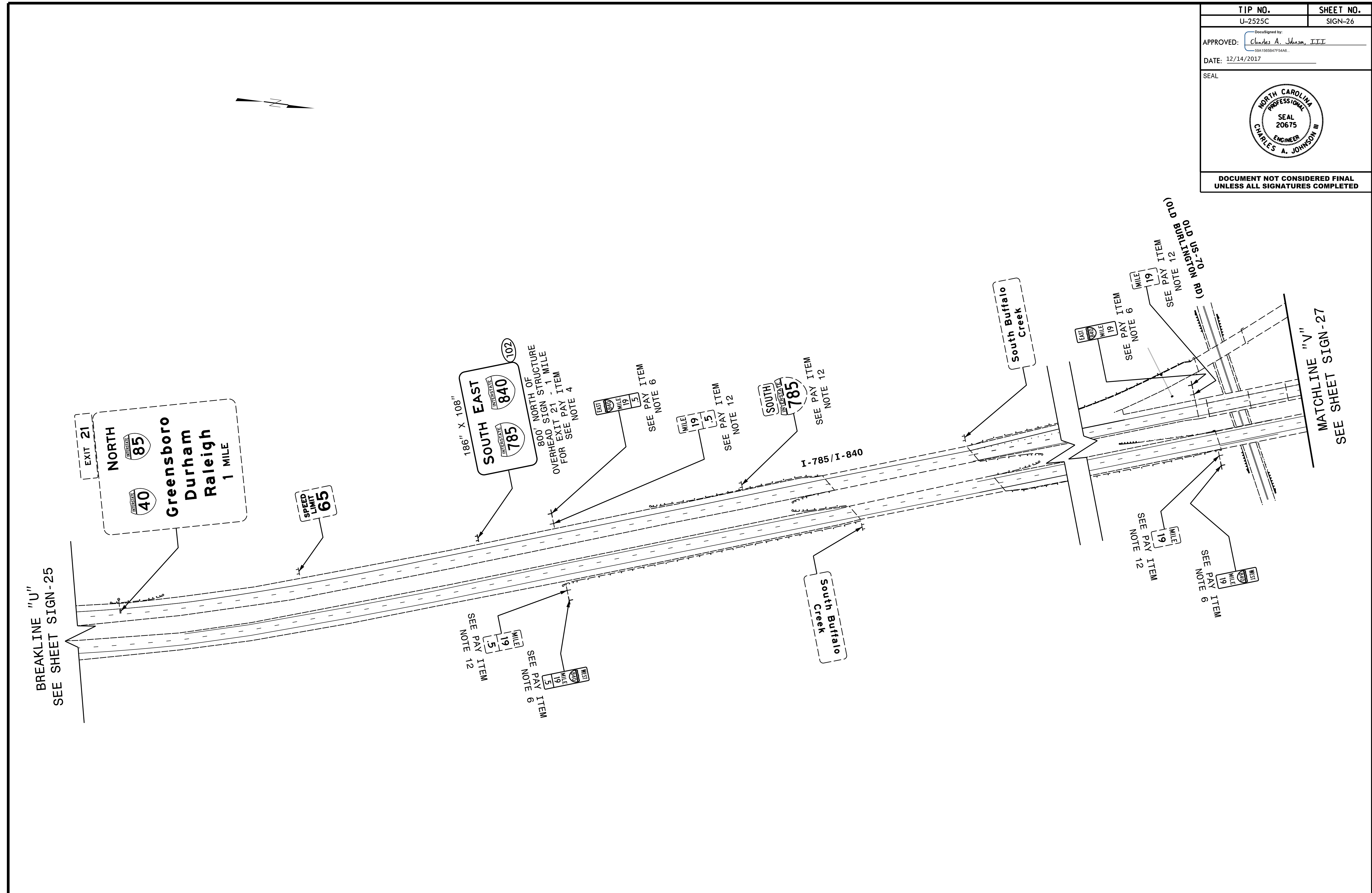

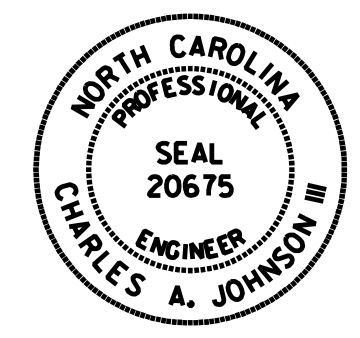

TIP NO. U-2525C	SHEET NO. SIGN-27
APPROVED: <i>Charles A. Johnson, III</i> <small>19A1955B47F5446</small>	
DATE: 12/14/2017	
SEAL	
	
DOCUMENT NOT CONSIDERED FINAL UNLESS ALL SIGNATURES COMPLETED	

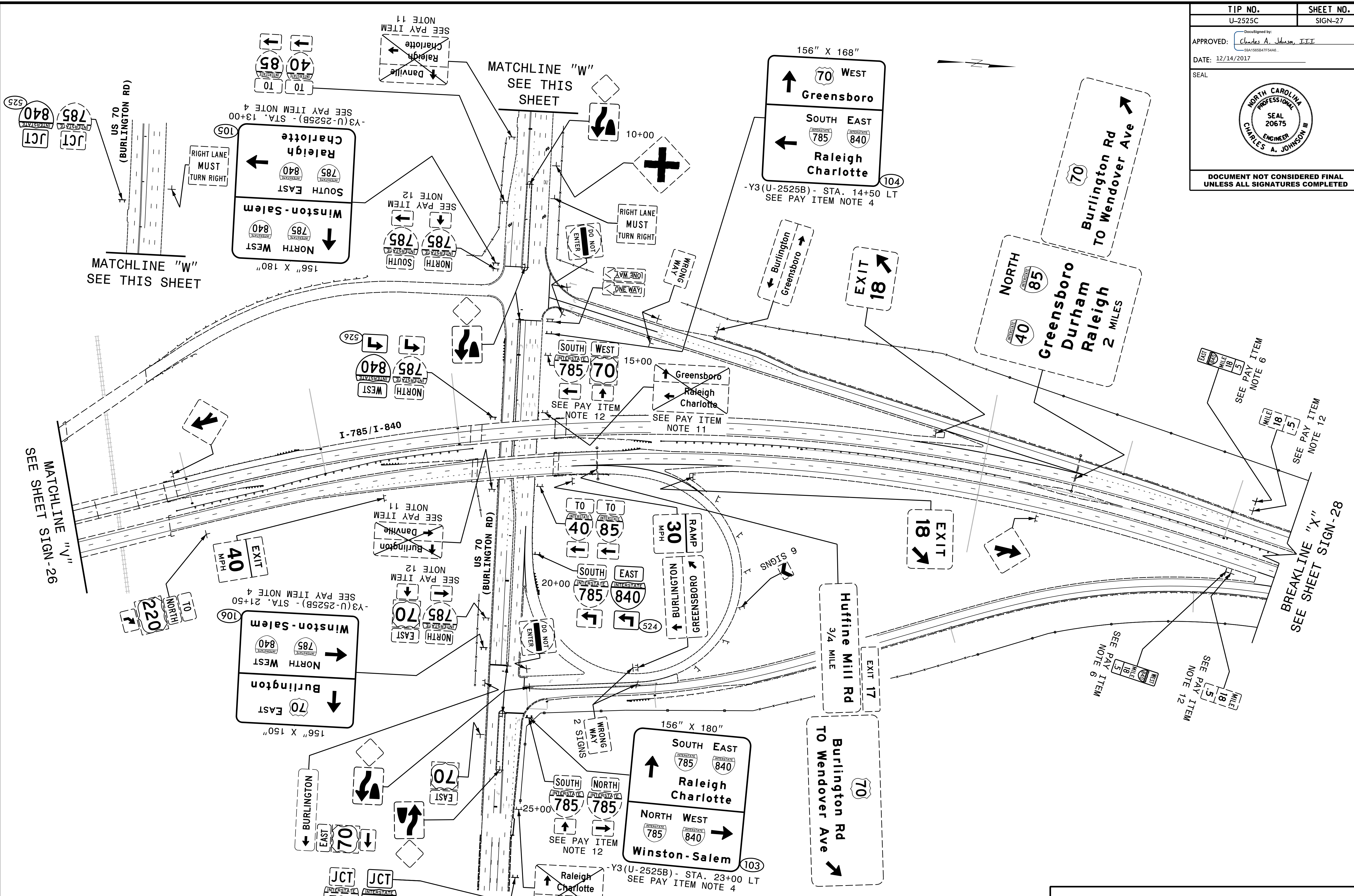

**HNTB**  
 HNTB NORTH CAROLINA, P.C.  
 343 E. Six Forks Road, Suite 200  
 Raleigh, North Carolina 27609  
 NC License No: C-1554  
 (919) 546-8997

**EXISTING AND PROPOSED SIGNS  
 I-785/I-840/US 70**

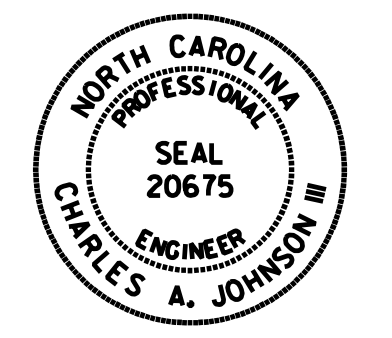

TIP NO. U-2525C	SHEET NO. SIGN-28
APPROVED: <i>Charles A. Johnson, III</i> <small>DocuSigned by: Charles A. Johnson, III 19A1965B47F5446</small>	
DATE: 12/14/2017	
SEAL 	
DOCUMENT NOT CONSIDERED FINAL UNLESS ALL SIGNATURES COMPLETED	

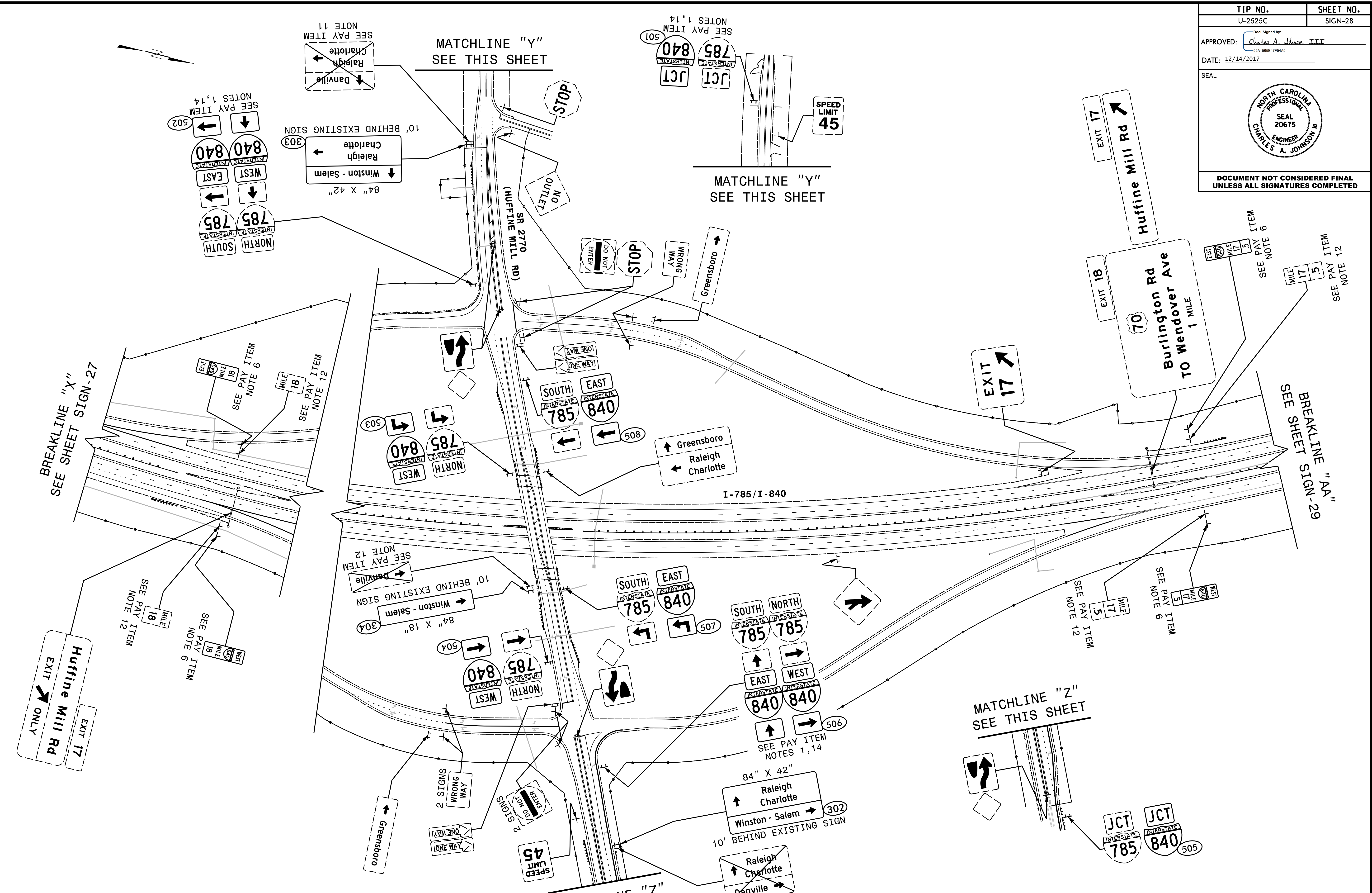

BREAKLINE "X"  
SEE SHEET SIGN-27

BREAKLINE "AA"  
SEE SHEET SIGN-29

MATCHLINE "Z"  
SEE THIS SHEET

MATCHLINE "Y"  
SEE THIS SHEET

MATCHLINE "Y"  
SEE THIS SHEET

MATCHLINE "Z"  
SEE THIS SHEET



HNTB NORTH CAROLINA, P.C.  
343 E. Six Forks Road, Suite 200  
Raleigh, North Carolina 27609  
NC License No: C-1554  
(919) 546-8997

**EXISTING AND PROPOSED SIGNS**  
**I-785/I-840/**  
**SR 2770 (HUFFINE MILL RD)**

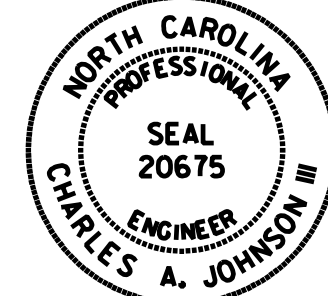

TIP NO. U-2525C	SHEET NO. SIGN-29
APPROVED: <u>Charles A. Johnson, III</u> <small>DocuSigned by: 59A158584755A8E</small>	
DATE: 12/14/2017	
SEAL	
	
DOCUMENT NOT CONSIDERED FINAL UNLESS ALL SIGNATURES COMPLETED	

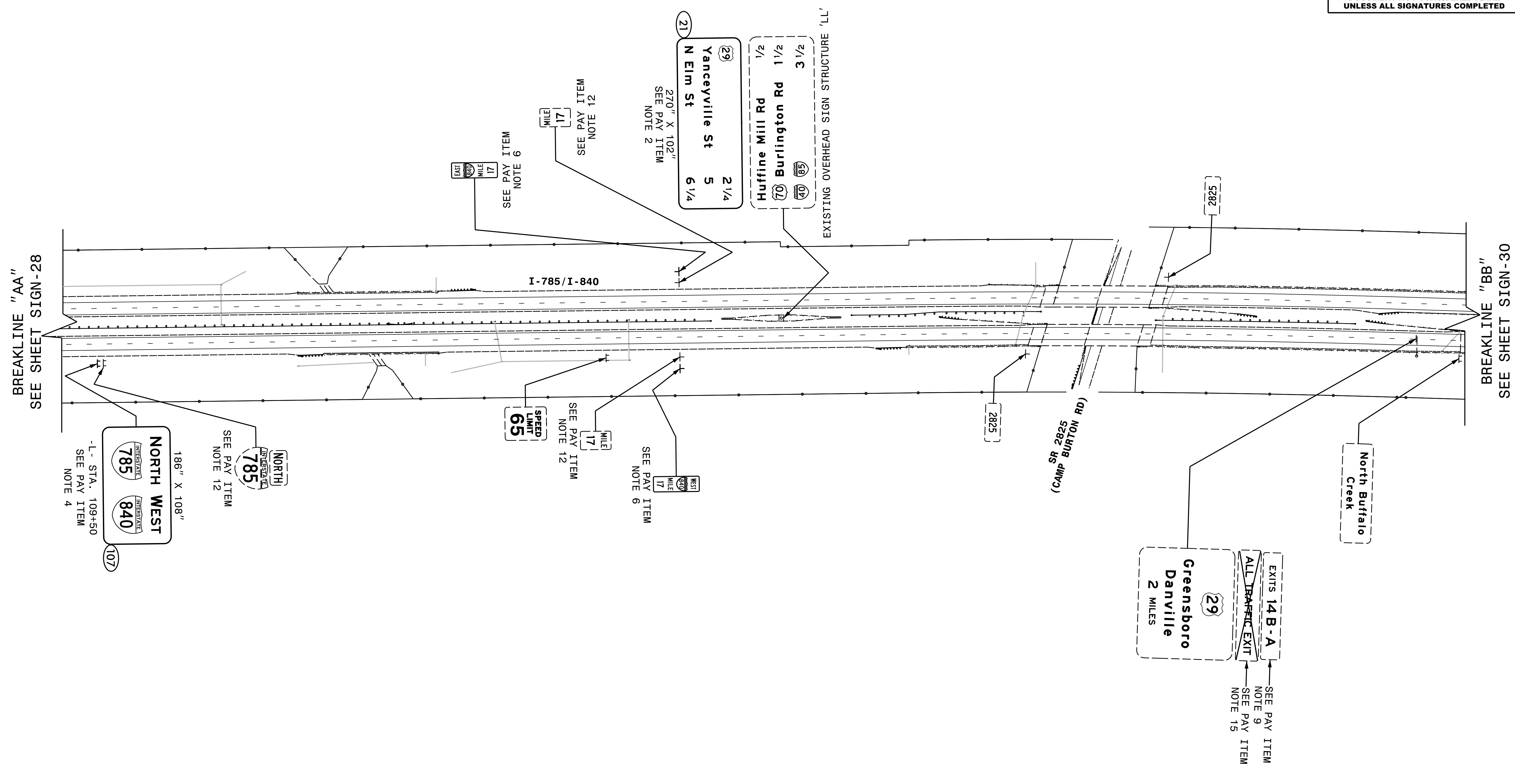

**HNTB** HNTB NORTH CAROLINA, P.C.  
 343 E. Six Forks Road, Suite 200  
 Raleigh, North Carolina 27609  
 NC License No: C-1554  
 (919) 546-8997

**EXISTING AND PROPOSED SIGNS  
I-785/I-840**

TIP NO. U-2525C	SHEET NO. SIGN-30
APPROVED: <i>Charles A. Johnson, III</i> <small>59A1562847F544E</small>	
DATE: 12/14/2017	
SEAL	
	
DOCUMENT NOT CONSIDERED FINAL UNLESS ALL SIGNATURES COMPLETED	

# NO SIGN WORK THIS SHEET

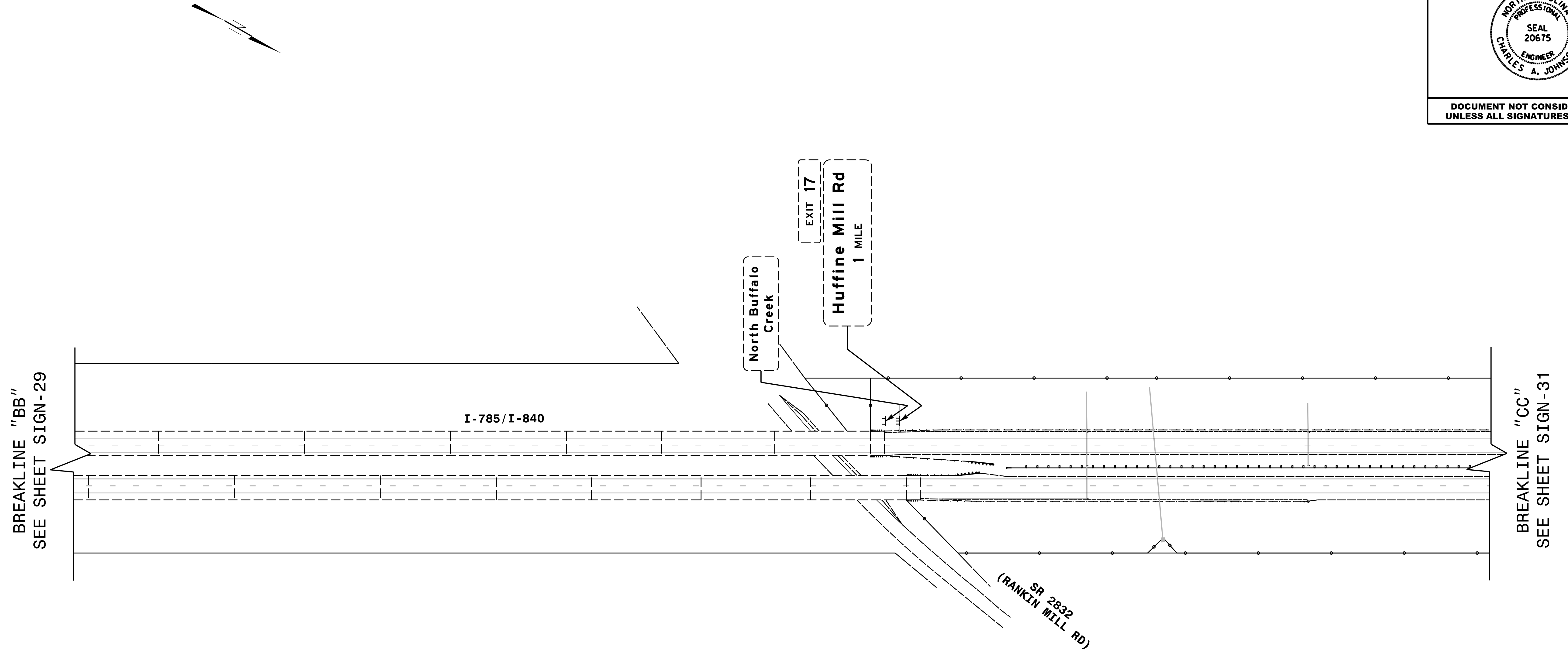

**EXISTING SIGNS**  
**I-785/I-840**



TIP NO. U-2525C	SHEET NO. SIGN-31
APPROVED: <i>Charles A. Johnson, III</i> <small>SSA15628475446</small>	
DATE: 12/14/2017	
SEAL	
	
DOCUMENT NOT CONSIDERED FINAL UNLESS ALL SIGNATURES COMPLETED	

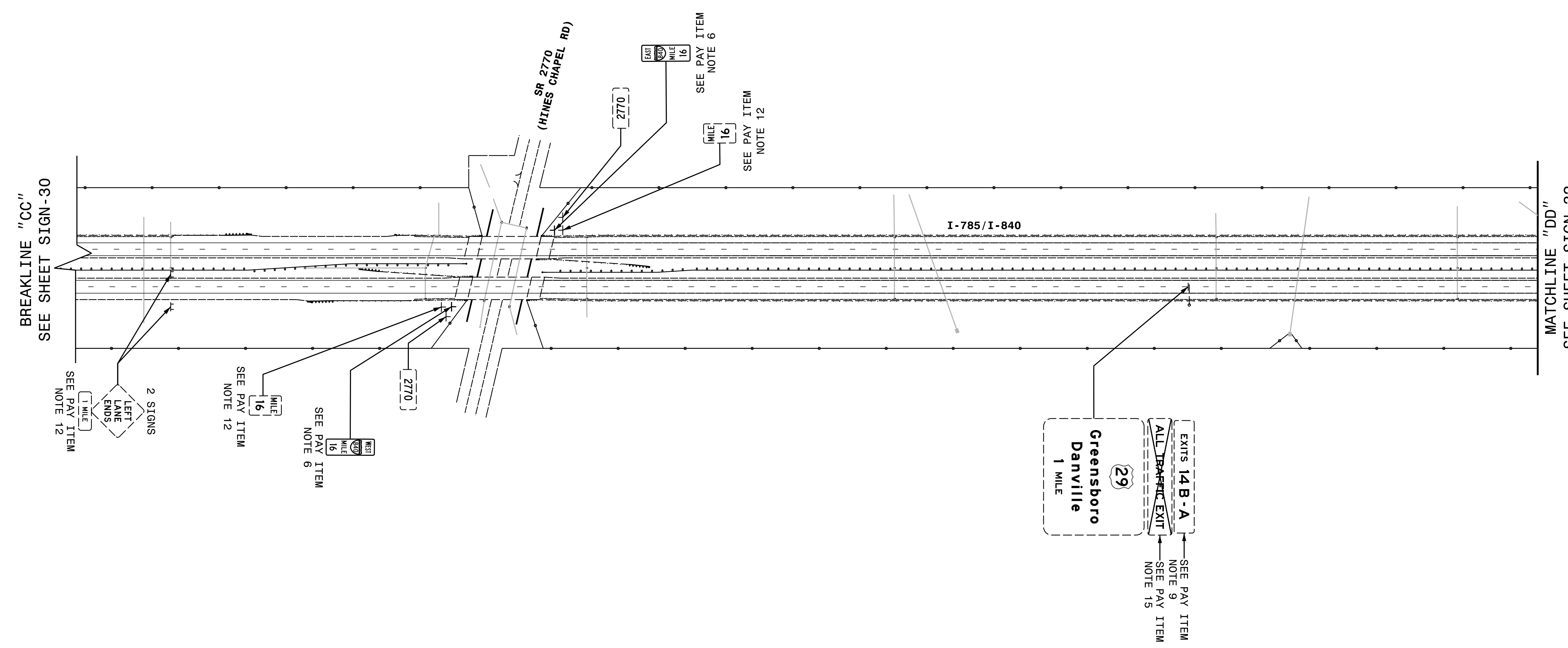

TIP NO. U-2525C	SHEET NO. SIGN-32
APPROVED: <i>Charles A. Johnson, III</i> <small>58A1562847F5A4E</small>	
DATE: 12/14/2017	
SEAL	
	
DOCUMENT NOT CONSIDERED FINAL UNLESS ALL SIGNATURES COMPLETED	

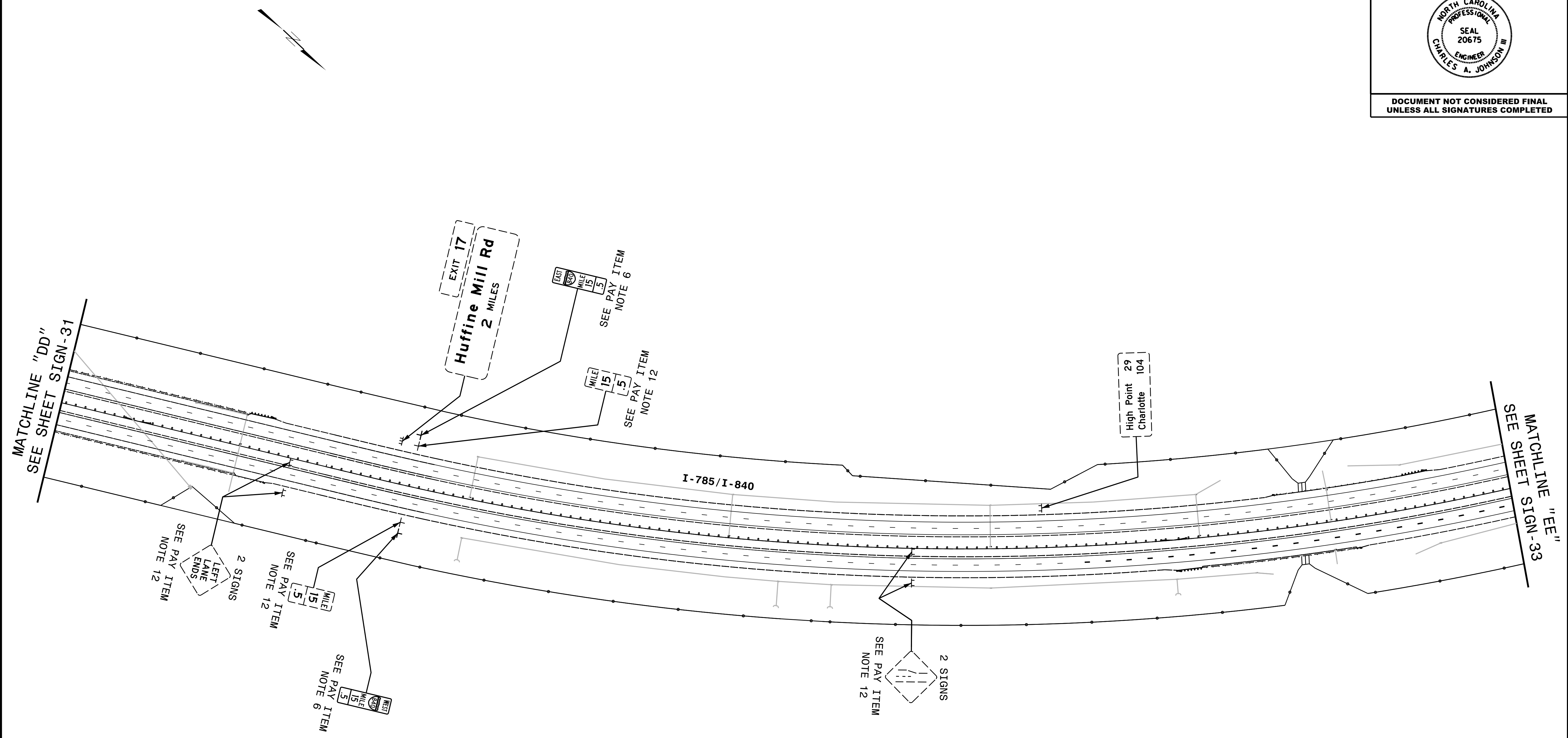

**HNTB** HNTB NORTH CAROLINA, P.C.  
 343 E. Six Forks Road, Suite 200  
 Raleigh, North Carolina 27609  
 NC License No: C-1554  
 (919) 546-8997

**EXISTING AND PROPOSED SIGNS  
I-785/I-840**

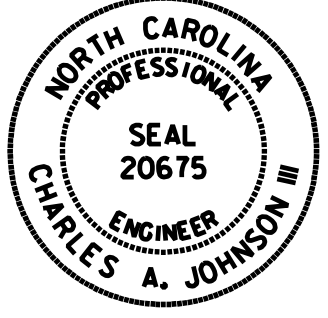
TIP NO. U-2525C	SHEET NO. SIGN-33
APPROVED: <i>Charles A. Johnson, III</i> <small>59A1562847F5A4E</small>	
DATE: 12/14/2017	
SEAL	
	
DOCUMENT NOT CONSIDERED FINAL UNLESS ALL SIGNATURES COMPLETED	

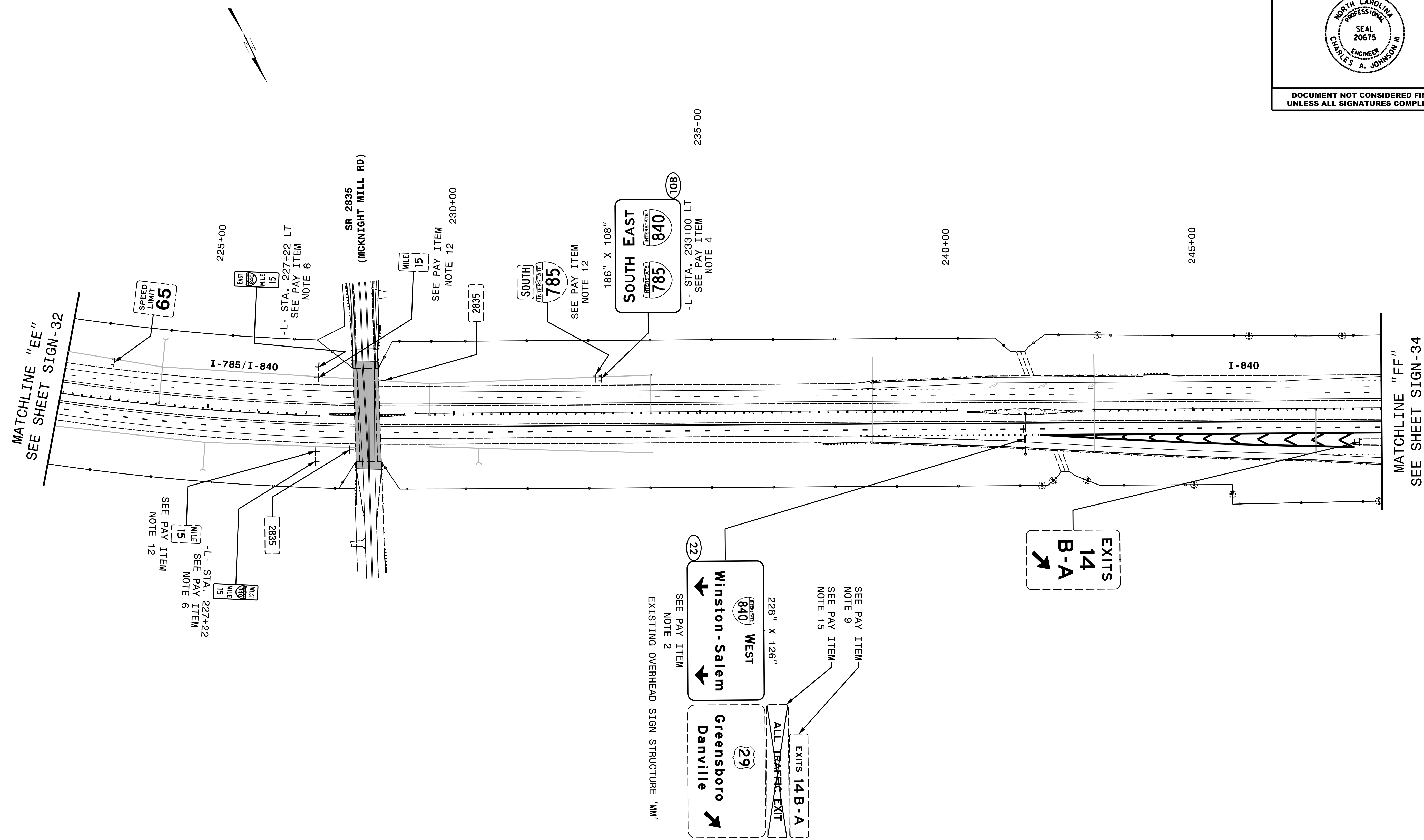



TIP NO. U-2525C	SHEET NO. SIGN-34
APPROVED: <i>Charles A. Johnson, III</i> <small>58A15628475446</small>	
DATE: 12/14/2017	
SEAL 	
DOCUMENT NOT CONSIDERED FINAL UNLESS ALL SIGNATURES COMPLETED	

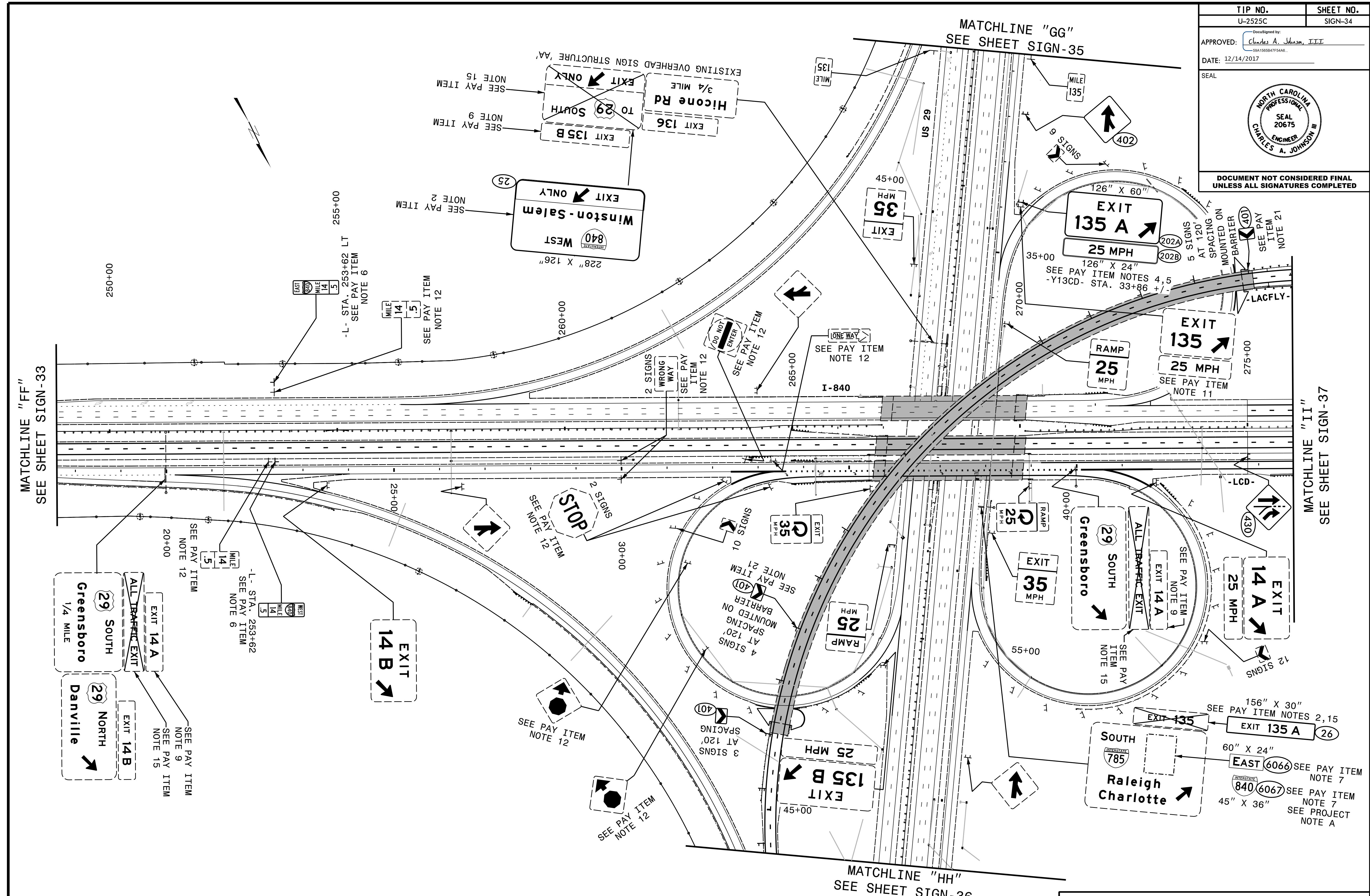

**HNTB**  
 HNTB NORTH CAROLINA, P.C.  
 343 E. Six Forks Road, Suite 200  
 Raleigh, North Carolina 27609  
 NC License No: C-1554  
 (919) 546-8997

**EXISTING AND PROPOSED SIGNS  
I-785/I-840**



TIP NO. U-2525C	SHEET NO. SIGN-35
APPROVED: <i>Charles A. Johnson, III</i> 59A1562847F5A4E	
DATE: 12/14/2017	
SEAL	
	
DOCUMENT NOT CONSIDERED FINAL UNLESS ALL SIGNATURES COMPLETED	

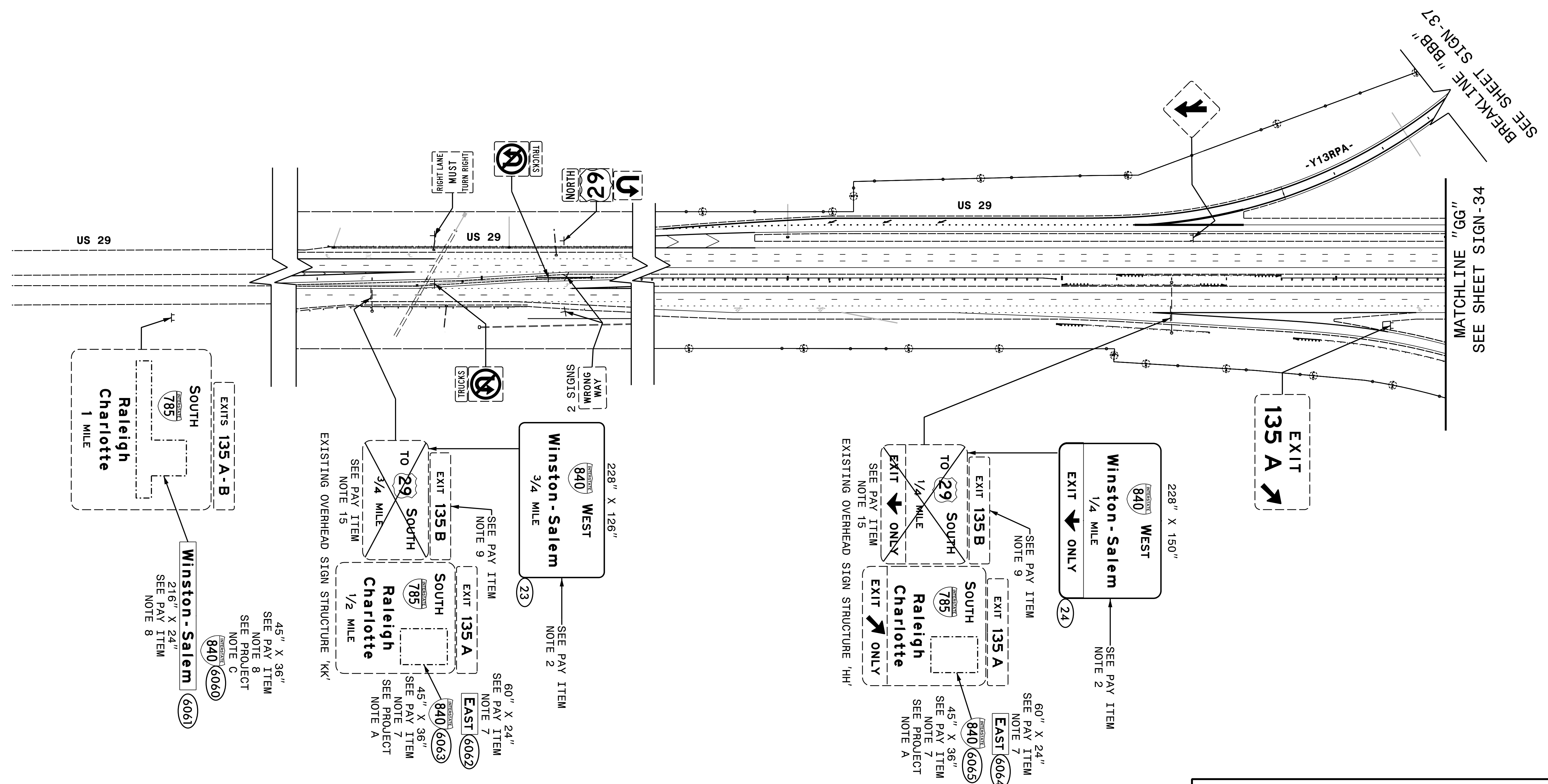

**EXISTING AND PROPOSED SIGNS  
US 29**

**HNTB**

HNTB NORTH CAROLINA, P.C.  
 3045 Six Forks Road, Suite 200  
 Raleigh, North Carolina 27609  
 NC License No. C-1554  
 (919) 546-8997

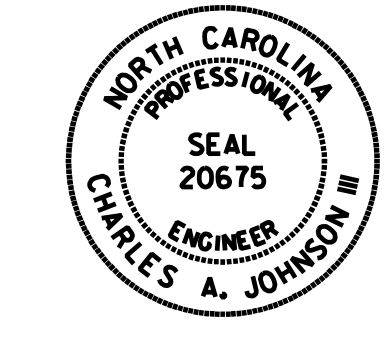
TIP NO. U-2525C	SHEET NO. SIGN-36
APPROVED: <i>Charles A. Johnson, III</i> <small>681565847F54A6...</small>	
DATE: 12/14/2017	
SEAL 	
DOCUMENT NOT CONSIDERED FINAL UNLESS ALL SIGNATURES COMPLETED	

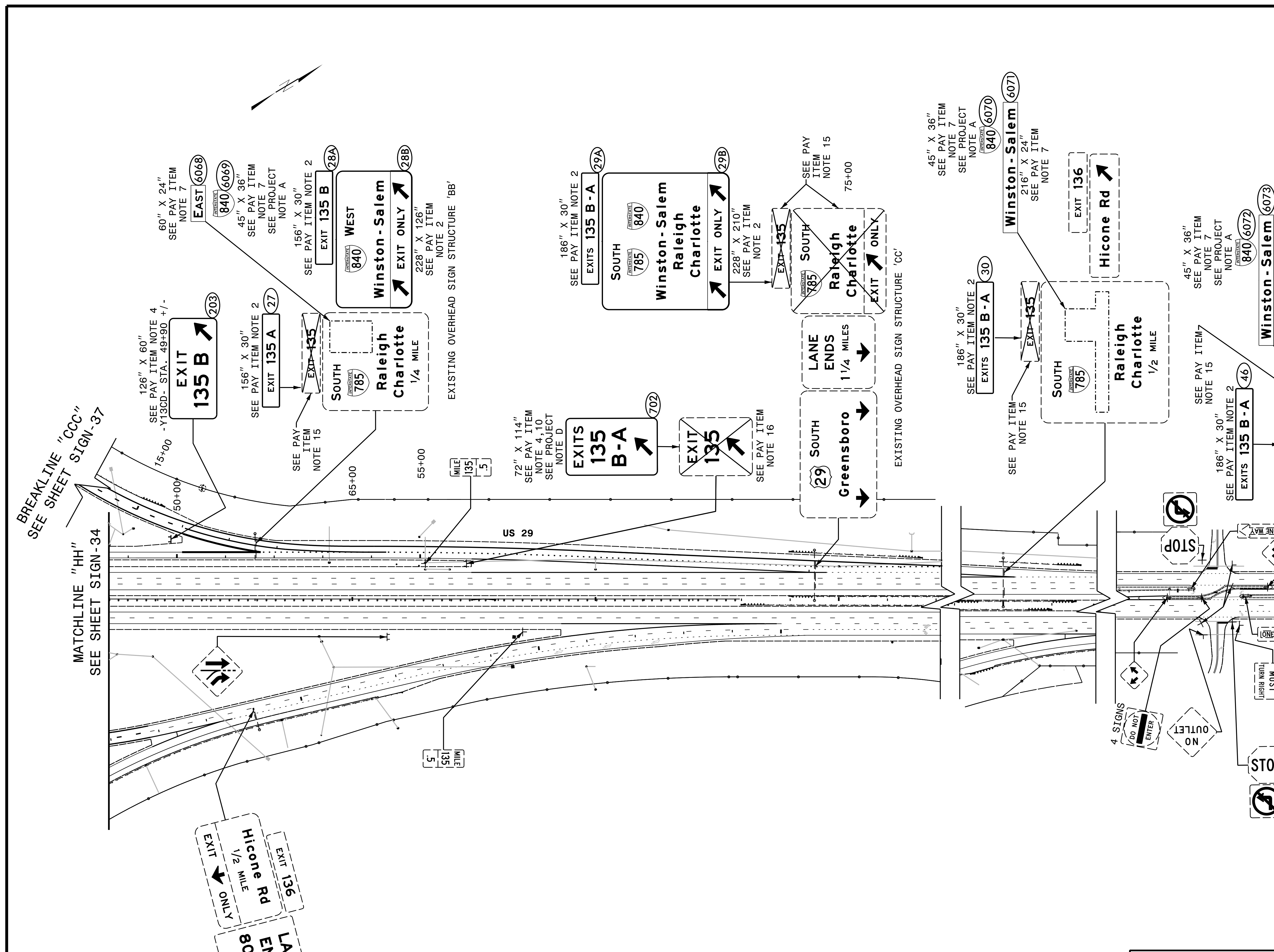

BREAKLINE "CCC"  
SEE SHEET SIGN-37

MATCHLINE "HH"  
SEE SHEET SIGN-34

LANE ENDS 800 FT  
EXIT ONLY  
EXIT 136  
Hicone Rd  
1/2 MILE

**HNTB**  
HNTB NORTH CAROLINA, P.C.  
343 E. Six Forks Road, Suite 200  
Raleigh, North Carolina 27609  
NC License No: C-1554  
(919) 546-8997

**EXISTING AND PROPOSED SIGNS  
US-29**

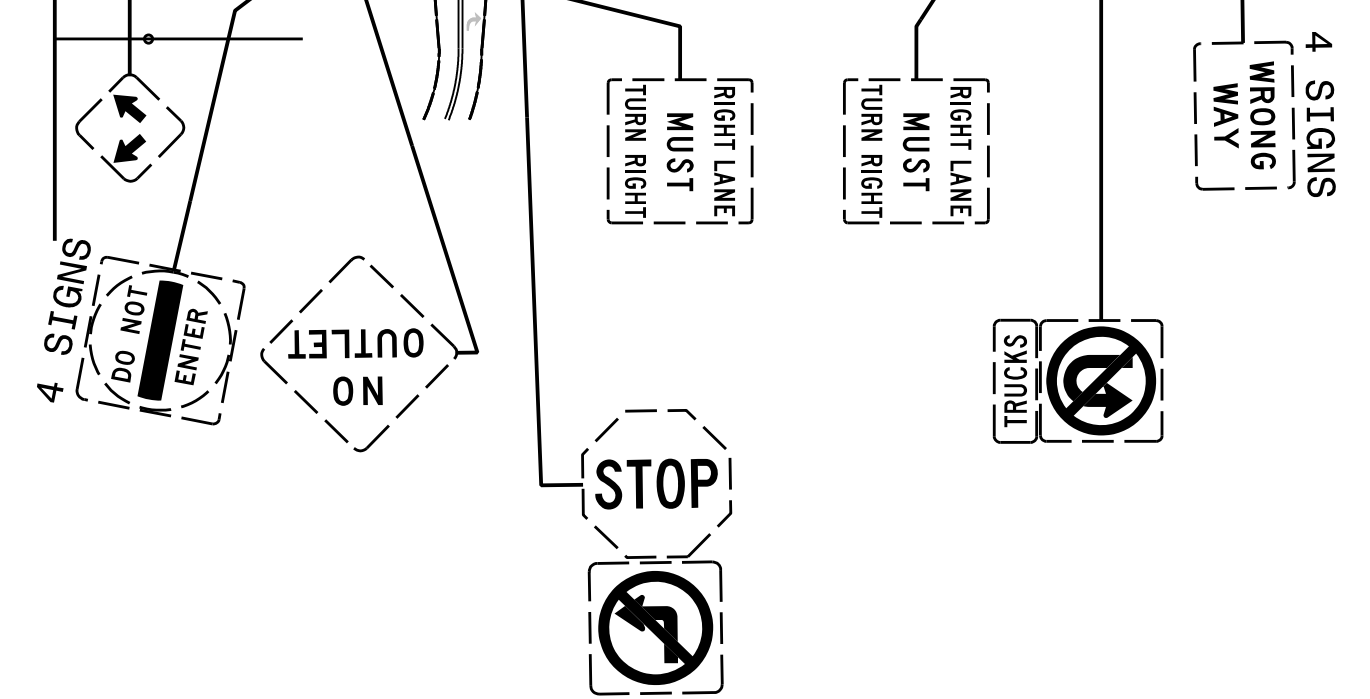

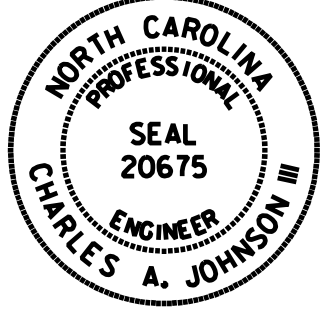

TIP NO. U-2525C	SHEET NO. SIGN-37
APPROVED: <i>Charles A. Johnson, III</i> 59A1562847F5A4E	
DATE: 12/14/2017	
SEAL 	
DOCUMENT NOT CONSIDERED FINAL UNLESS ALL SIGNATURES COMPLETED	

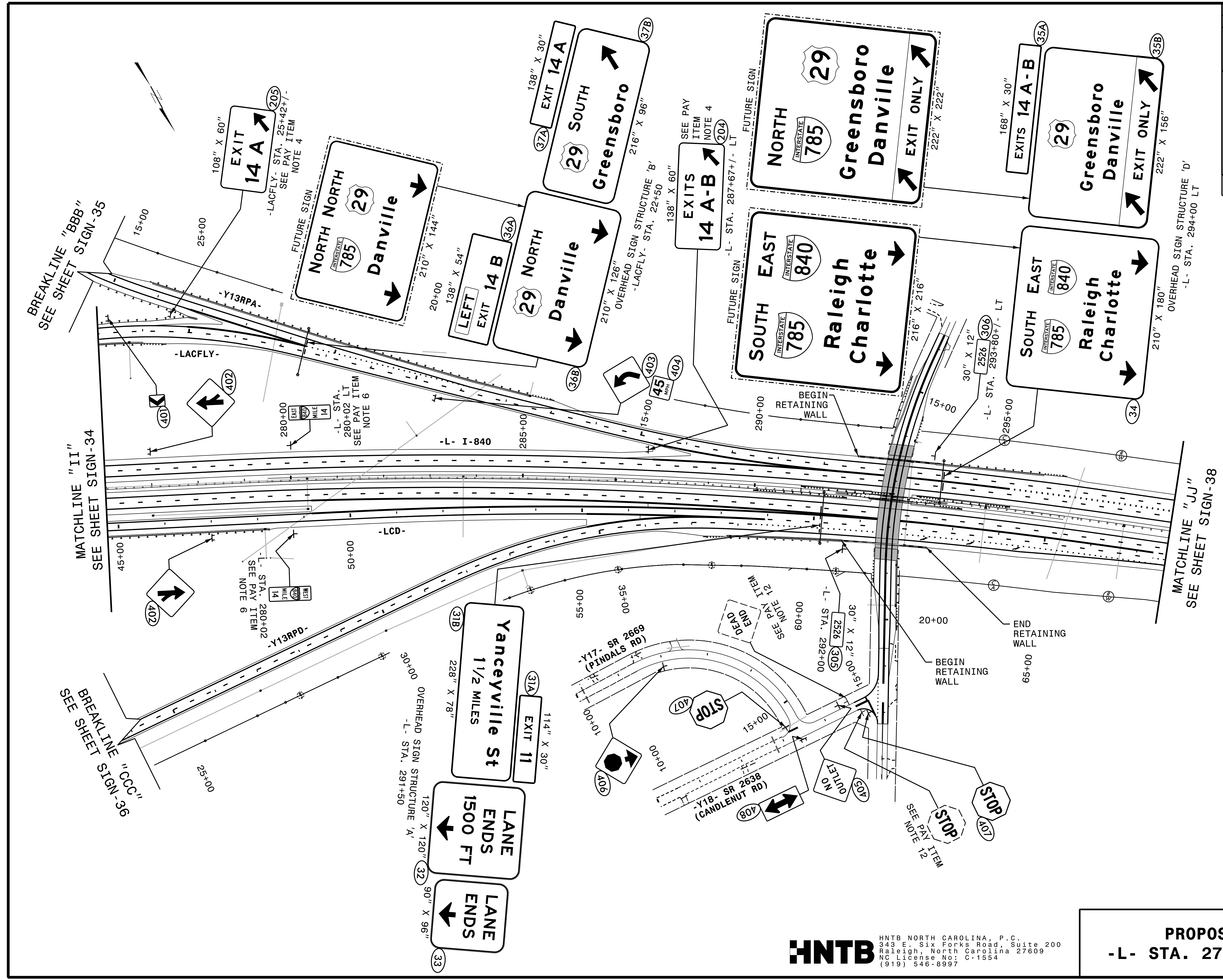

**HNTB**  
 HNTB NORTH CAROLINA, P.C.  
 343 E. Six Forks Road, Suite 200  
 Raleigh, North Carolina 27609  
 NC License No: C-1554  
 (919) 546-8997

**PROPOSED SIGNS**  
**-L- STA. 276+00 TO 299+00**

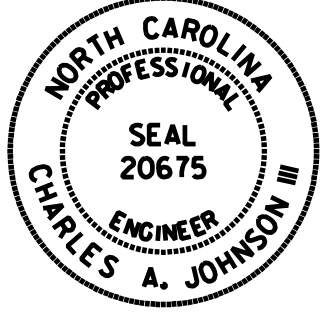

TIP NO. U-2525C	SHEET NO. SIGN-38
APPROVED: <u>Charles A. Johnson, III</u> <small>58A1562847F544E</small>	
DATE: 12/14/2017	
SEAL	
	
DOCUMENT NOT CONSIDERED FINAL UNLESS ALL SIGNATURES COMPLETED	

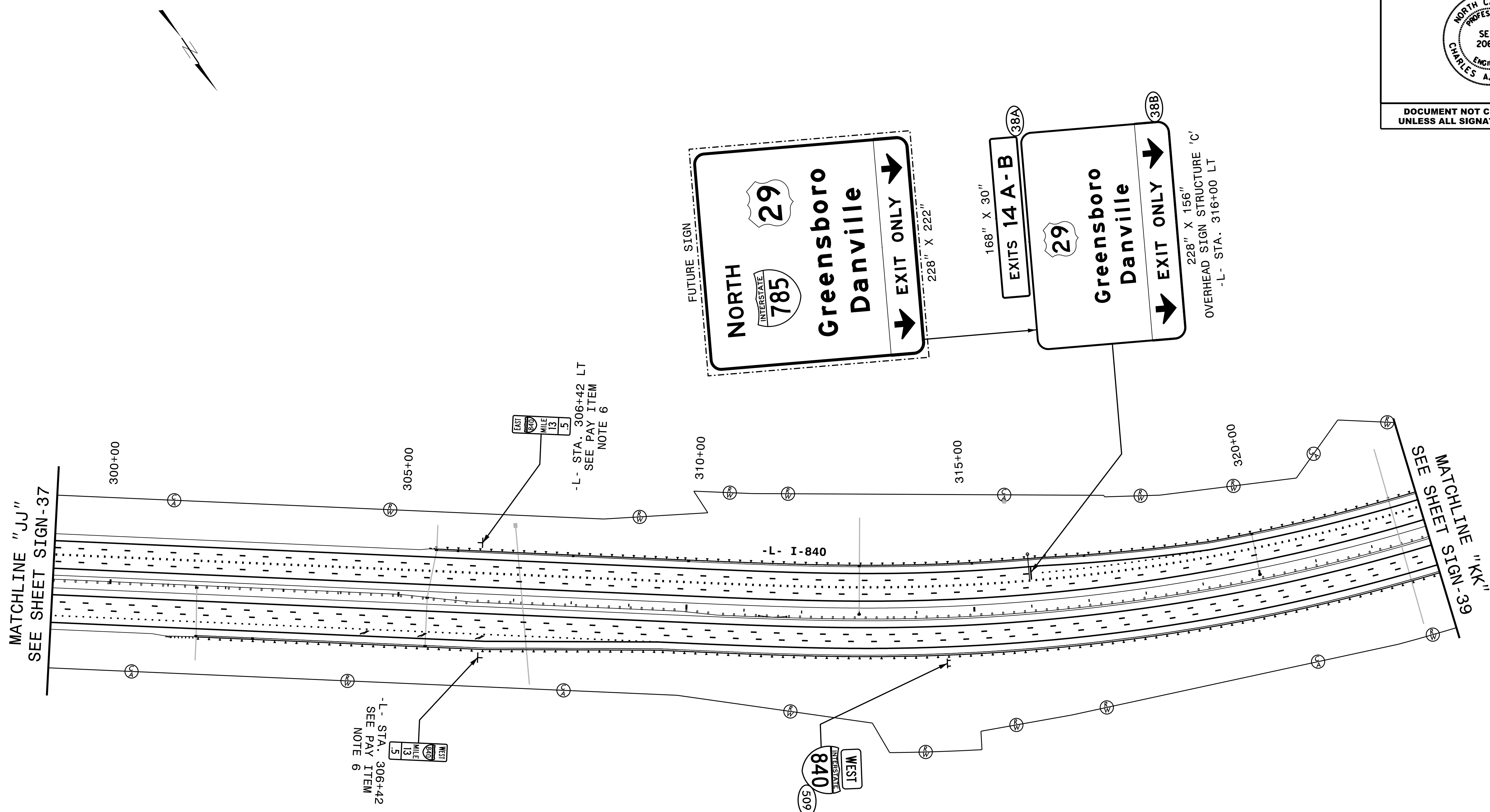

**HNTB** HNTB NORTH CAROLINA, P.C.  
 343 E. Six Forks Road, Suite 200  
 Raleigh, North Carolina 27609  
 NC License No: C-1554  
 (919) 546-8997

**PROPOSED SIGNS**  
**-L- STA. 299+00 TO 323+00**

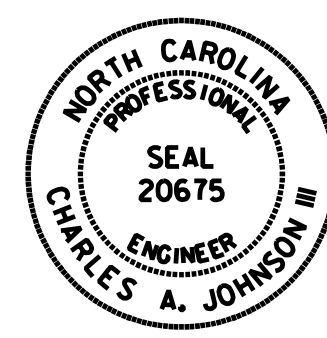

TIP NO. U-2525C	SHEET NO. SIGN-39
APPROVED: <i>Charles A. Johnson, III</i> <small>SEAL 20675 ENGINEER</small>	
DATE: 12/14/2017	
SEAL	
	
DOCUMENT NOT CONSIDERED FINAL UNLESS ALL SIGNATURES COMPLETED	

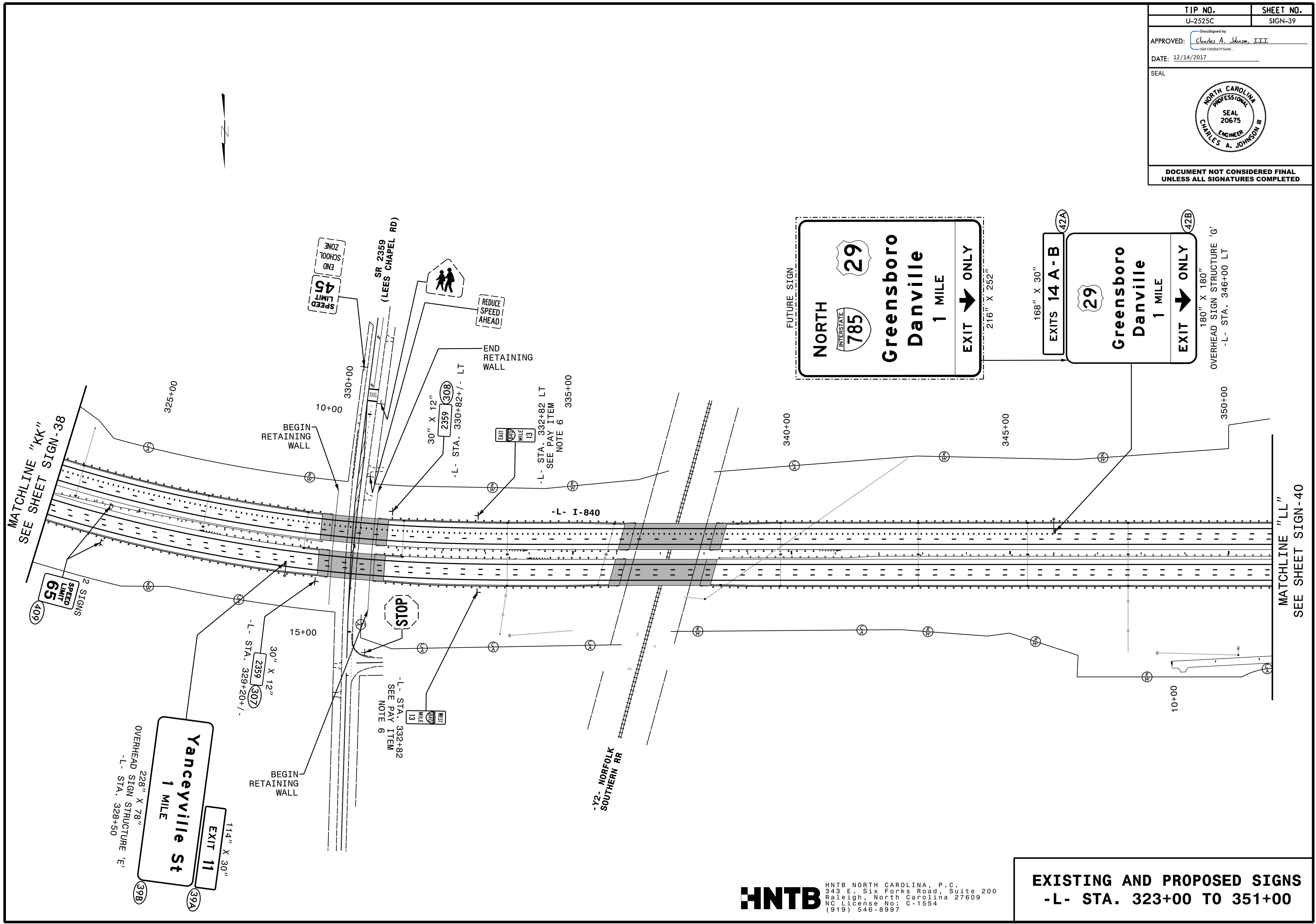

**HNTB** HNTB NORTH CAROLINA, P.C.  
 343 E. Six Forks Road, Suite 200  
 Raleigh, North Carolina 27609  
 NC License No: C-1554  
 (919) 546-8997

**EXISTING AND PROPOSED SIGNS**  
**-L- STA. 323+00 TO 351+00**

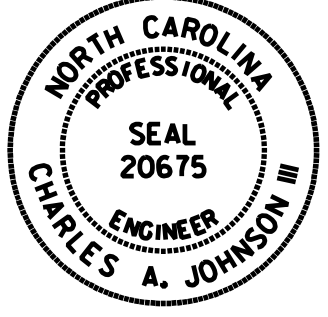
TIP NO. U-2525C	SHEET NO. SIGN-40
APPROVED: <i>Charles A. Johnson, III</i> <small>59A1562847F5A4E</small>	
DATE: 12/14/2017	
SEAL	
	
DOCUMENT NOT CONSIDERED FINAL UNLESS ALL SIGNATURES COMPLETED	

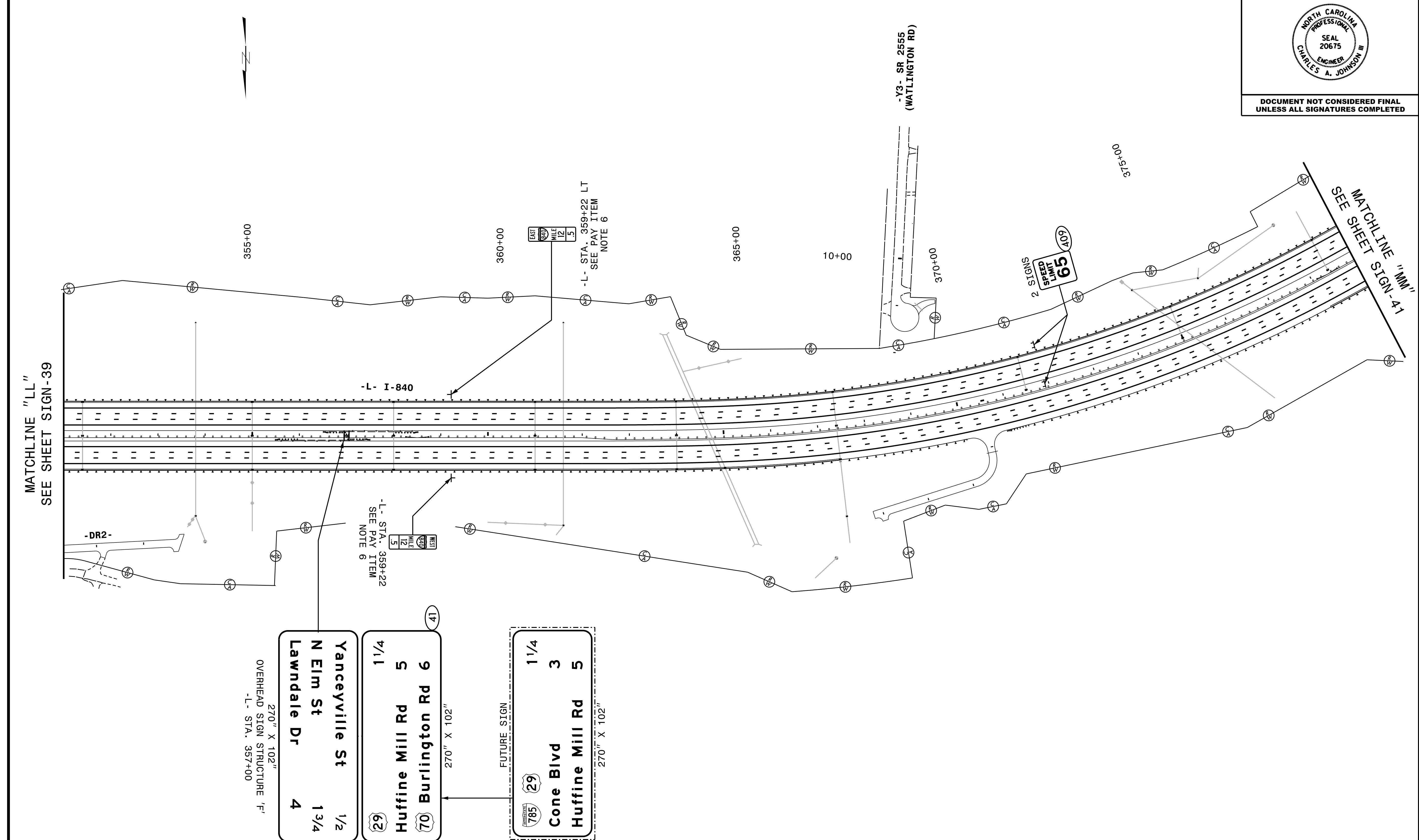

270" X 102"  
OVERHEAD SIGN STRUCTURE 'F'  
-L- STA. 357+00

40	4	1 3/4	1/2
	Lawndale Dr	N Elm St	Yanceyville St

270" X 102"

41	6	5	1 1/4
	Burlington Rd	Huffine Mill Rd	

270" X 102"  
FUTURE SIGN

785	29	5	3	1 1/4
	Cone Blvd	Huffine Mill Rd		

**HNTB** HNTB NORTH CAROLINA, P.C.  
343 E. Six Forks Road, Suite 200  
Raleigh, North Carolina 27609  
NC License No: C-1554  
(919) 546-8997

**PROPOSED SIGNS**  
**-L- STA. 351+00 TO 379+00**

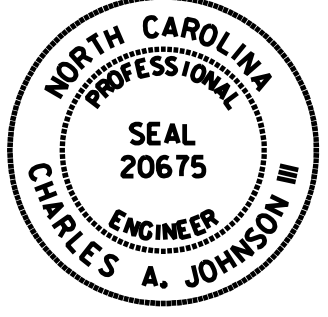

TIP NO. U-2525C	SHEET NO. SIGN-41
APPROVED: <i>Charles A. Johnson, III</i> <small>58A1562847F544E</small>	
DATE: 12/14/2017	
SEAL 	
DOCUMENT NOT CONSIDERED FINAL UNLESS ALL SIGNATURES COMPLETED	

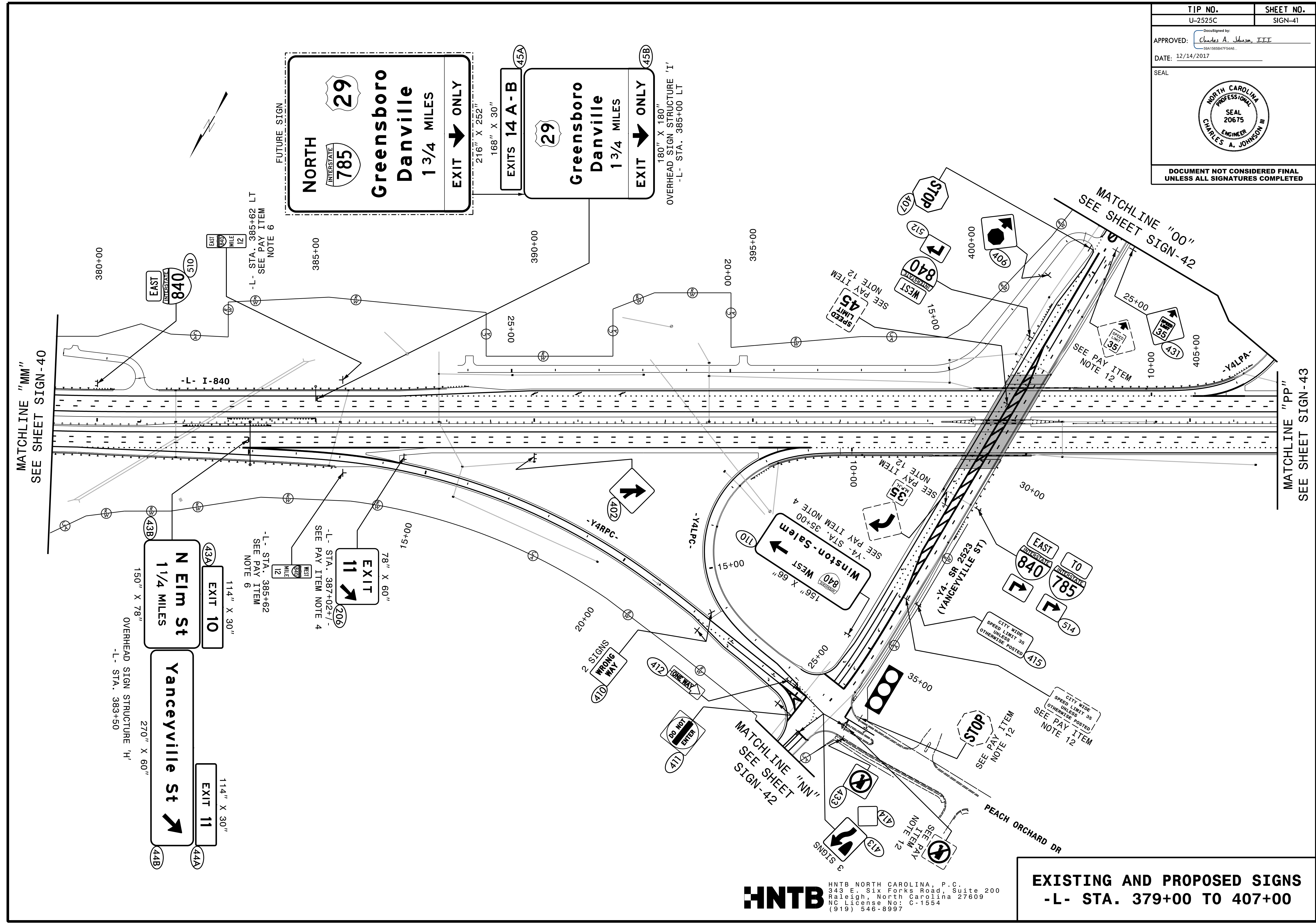

**HNTB**  
 HNTB NORTH CAROLINA, P.C.  
 343 E. Six Forks Road, Suite 200  
 Raleigh, North Carolina 27609  
 NC License No: C-1554  
 (919) 546-8997

**EXISTING AND PROPOSED SIGNS**  
**-L- STA. 379+00 TO 407+00**



TIP NO. U-2525C	SHEET NO. SIGN-42
APPROVED: <i>Charles A. Johnson, III</i> <small>58A1562847F5A4E</small>	
DATE: 12/14/2017	
SEAL	
	
DOCUMENT NOT CONSIDERED FINAL UNLESS ALL SIGNATURES COMPLETED	

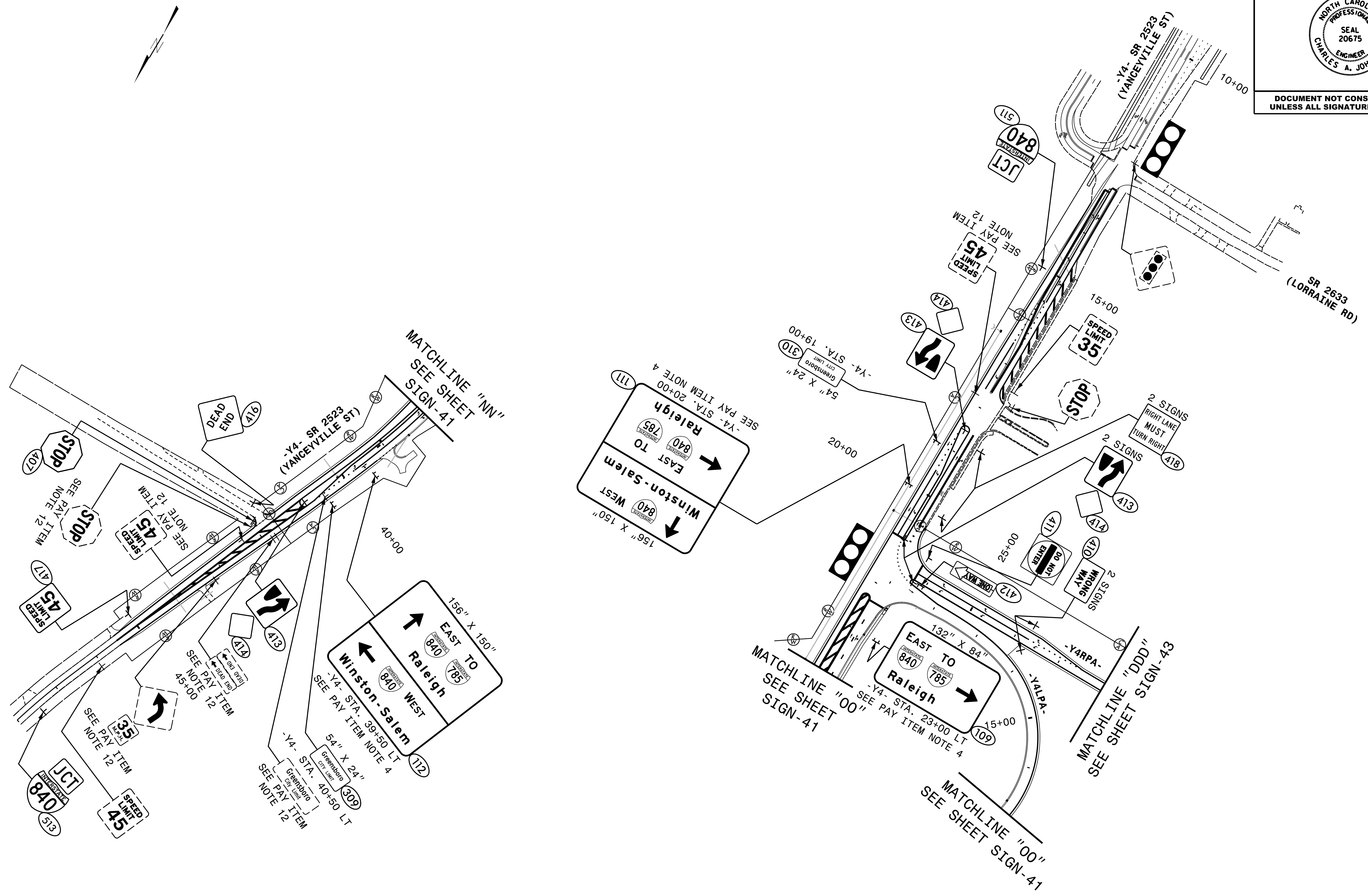

**HNTB** HNTB NORTH CAROLINA, P.C.  
 343 E. Six Forks Road, Suite 200  
 Raleigh, North Carolina 27609  
 NC License No: C-1554  
 (919) 546-8997

**EXISTING AND PROPOSED SIGNS  
 -Y4- STA. 10+00 TO 24+00  
 AND STA. 38+00 TO 48+00**



TIP NO. U-2525C	SHEET NO. SIGN-43
APPROVED: <i>Charles A. Johnson, III</i> <small>59A1562847F5A4E</small>	
DATE: 12/14/2017	
SEAL 	
DOCUMENT NOT CONSIDERED FINAL UNLESS ALL SIGNATURES COMPLETED	

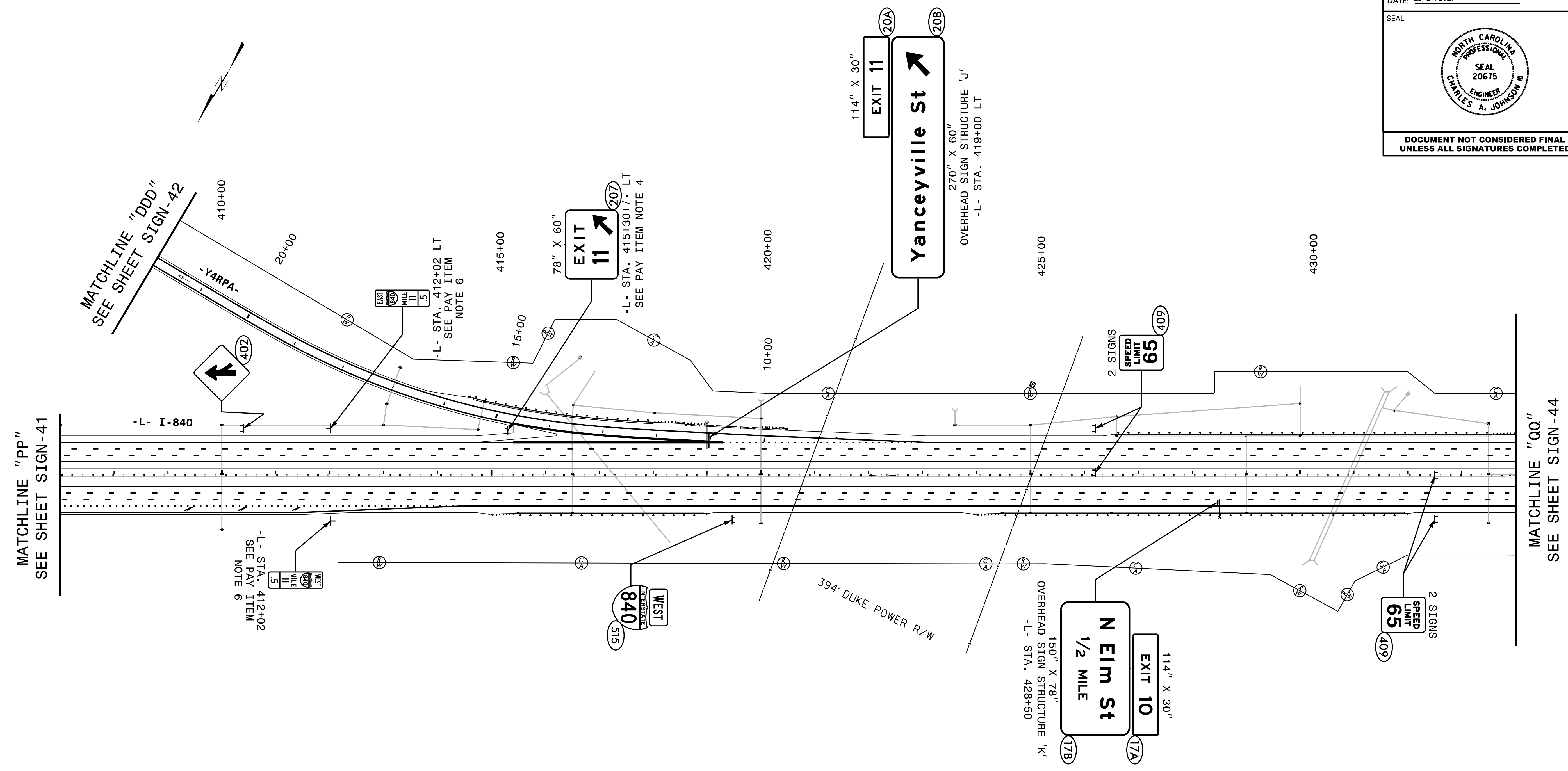

**HNTB** HNTB NORTH CAROLINA, P.C.  
 343 E. Six Forks Road, Suite 200  
 Raleigh, North Carolina 27609  
 NC License No: C-1554  
 (919) 546-8997

**PROPOSED SIGNS**  
**-L- STA. 407+00 TO 434+00**

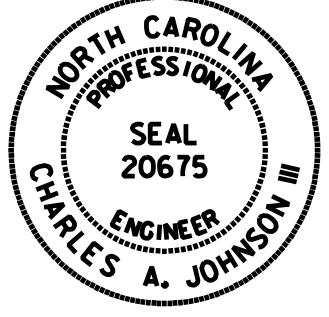
TIP NO. U-2525C	SHEET NO. SIGN-44
APPROVED: <u>Charles A. Johnson, III</u> <small>SEA156584754AA6</small>	
DATE: 12/14/2017	
SEAL	
	
DOCUMENT NOT CONSIDERED FINAL UNLESS ALL SIGNATURES COMPLETED	

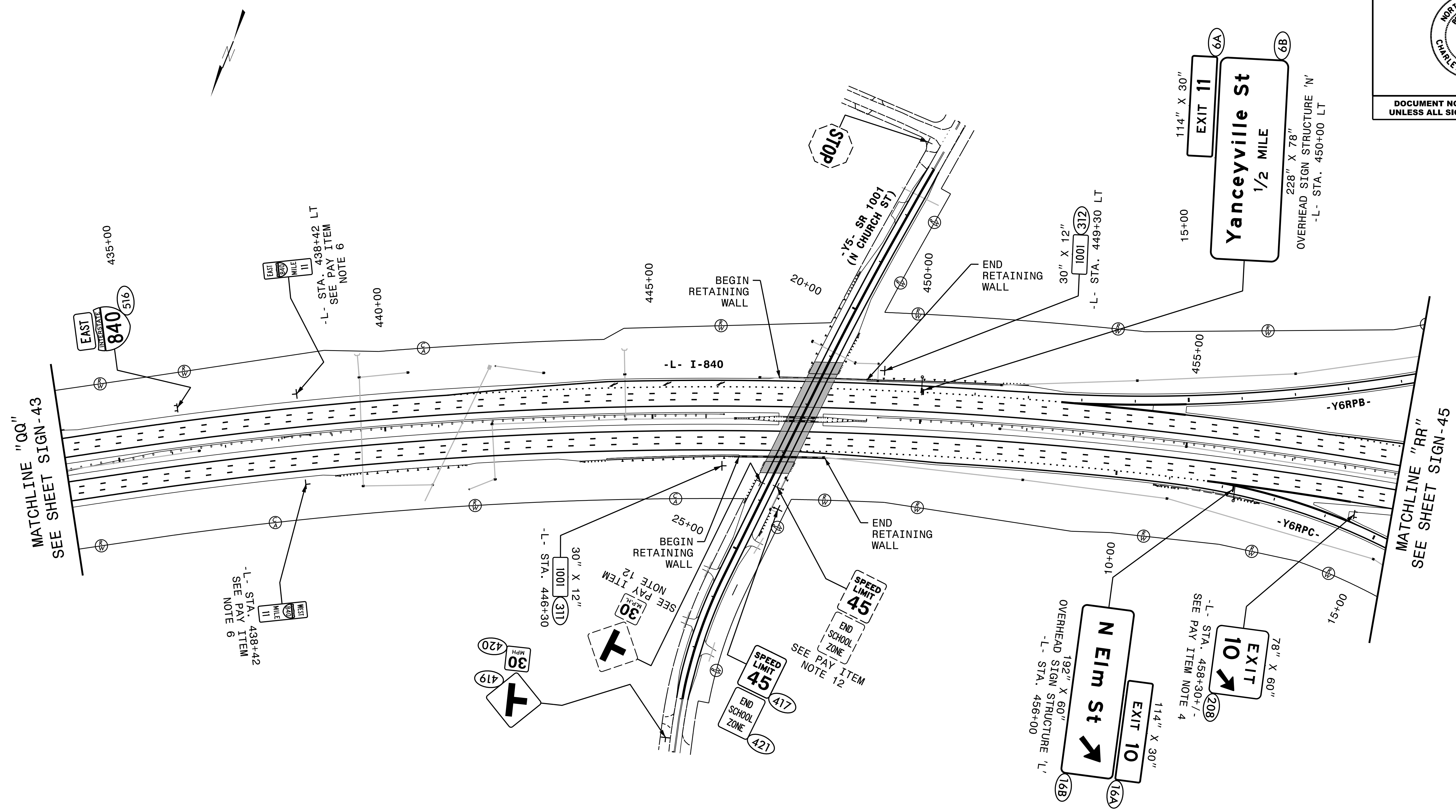

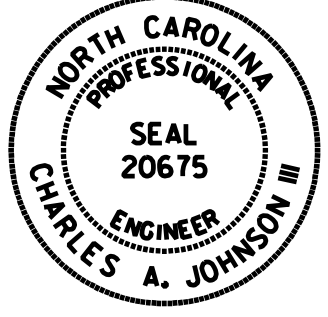

TIP NO. U-2525C	SHEET NO. SIGN-45
APPROVED: <i>Charles A. Johnson, III</i> <small>59A1562847F5A4E</small>	
DATE: 12/14/2017	
SEAL 	
DOCUMENT NOT CONSIDERED FINAL UNLESS ALL SIGNATURES COMPLETED	

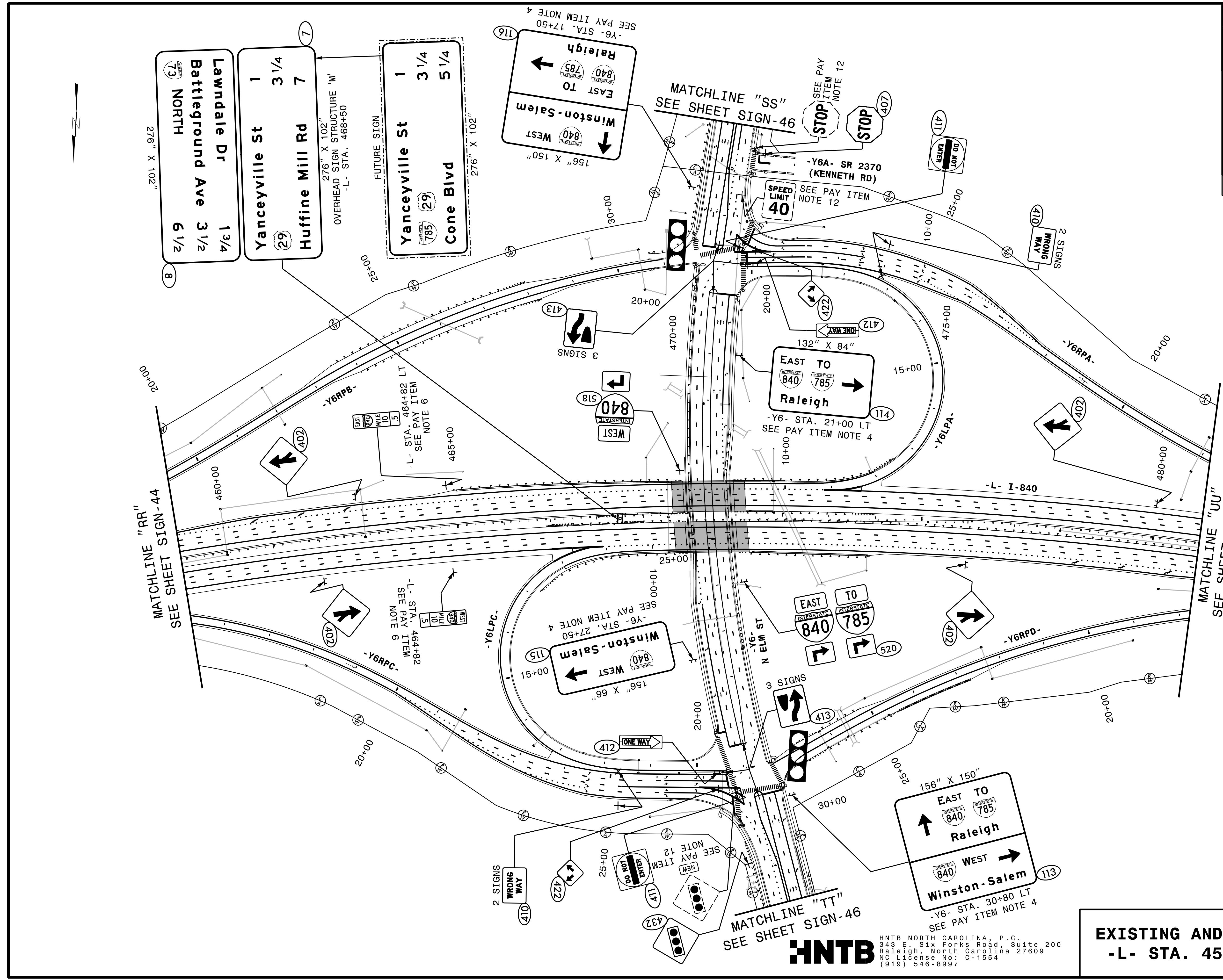

276" X 102"  
OVERHEAD SIGN STRUCTURE 'M'  
-L- STA. 468+50  
FUTURE SIGN

Lawndale Dr	1 3/4
Battleground Ave	3 1/2
NORTH	6 1/2

276" X 102"

Yanceyville St	1	3 1/4	7
Huffine Mill Rd	29	3 1/4	7

276" X 102"

Yanceyville St	1	3 1/4	5 1/4
Cone Blvd	29	3 1/4	5 1/4

**HNTB**  
 HNTB NORTH CAROLINA, P.C.  
 343 E. Six Forks Road, Suite 200  
 Raleigh, North Carolina 27609  
 NC License No: C-1554  
 (919) 546-8997

**EXISTING AND PROPOSED SIGNS**  
**-L- STA. 459+00 TO 481+00**



TIP NO. U-2525C	SHEET NO. SIGN-46
APPROVED: <u>Charles A. Johnson, III</u> <small>59A1562847F5A4E</small>	
DATE: 12/14/2017	
SEAL	
	
DOCUMENT NOT CONSIDERED FINAL UNLESS ALL SIGNATURES COMPLETED	

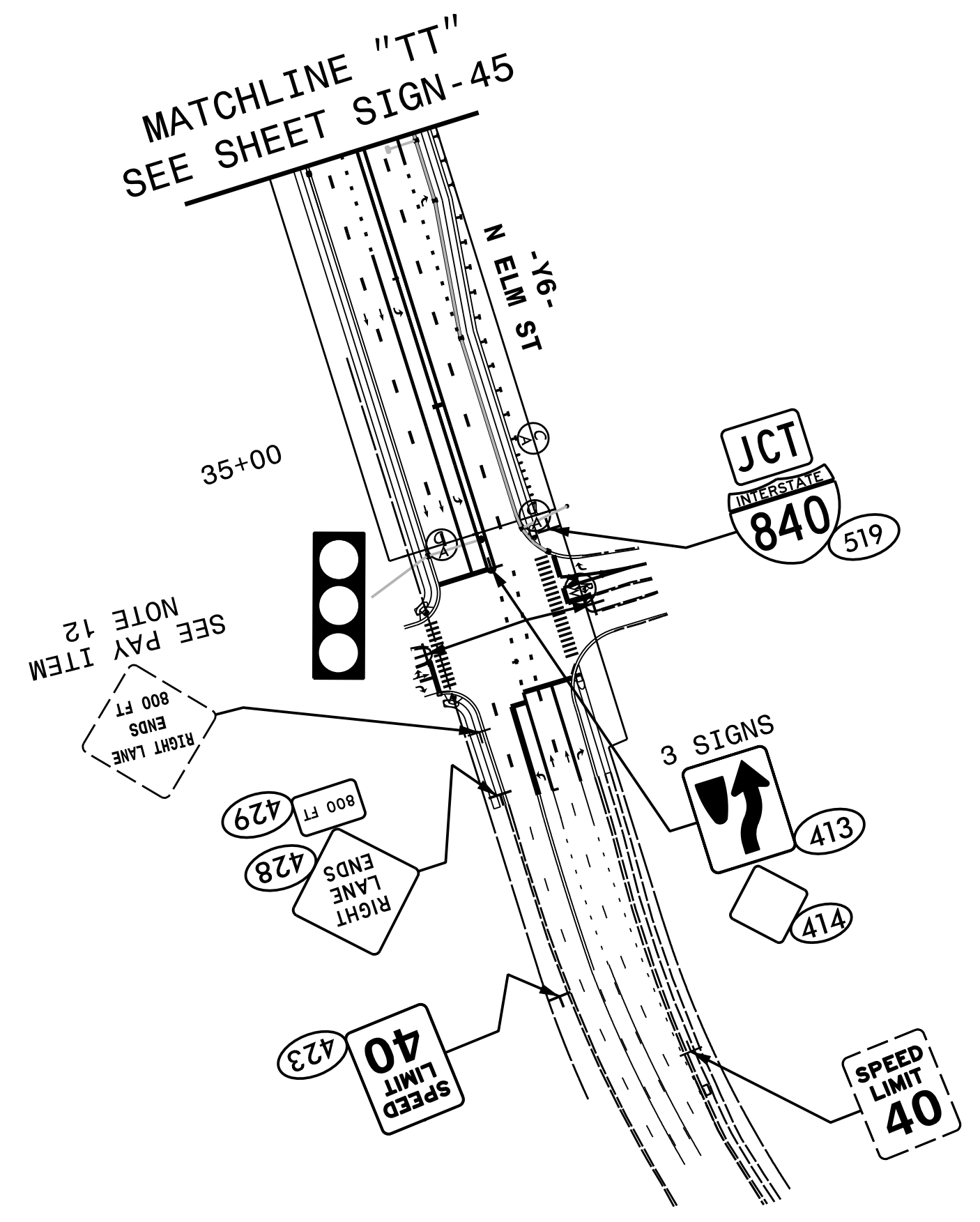
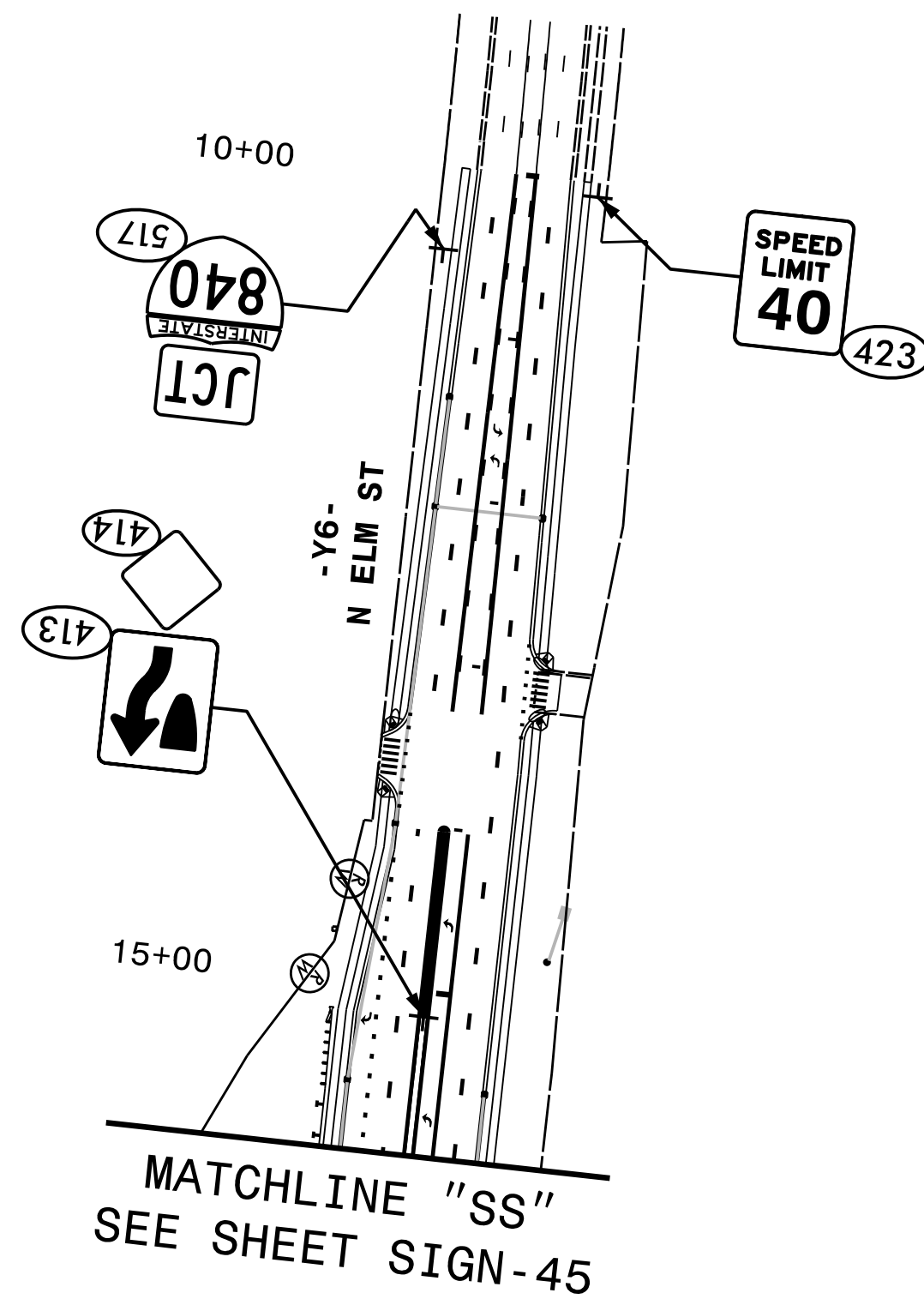

**HNTB** HNTB NORTH CAROLINA, P.C.  
343 E. Six Forks Road, Suite 200  
Raleigh, North Carolina 27609  
NC License No: C-1554  
(919) 546-8997

**EXISTING AND PROPOSED SIGNS  
-Y6- STA. 10+00 TO 16+00  
AND STA. 33+00 TO 38+00**



TIP NO. U-2525C	SHEET NO. SIGN-47
APPROVED: <i>Charles A. Johnson, III</i> <small>59A1562847F544E</small>	
DATE: 12/14/2017	
SEAL	
	
DOCUMENT NOT CONSIDERED FINAL UNLESS ALL SIGNATURES COMPLETED	

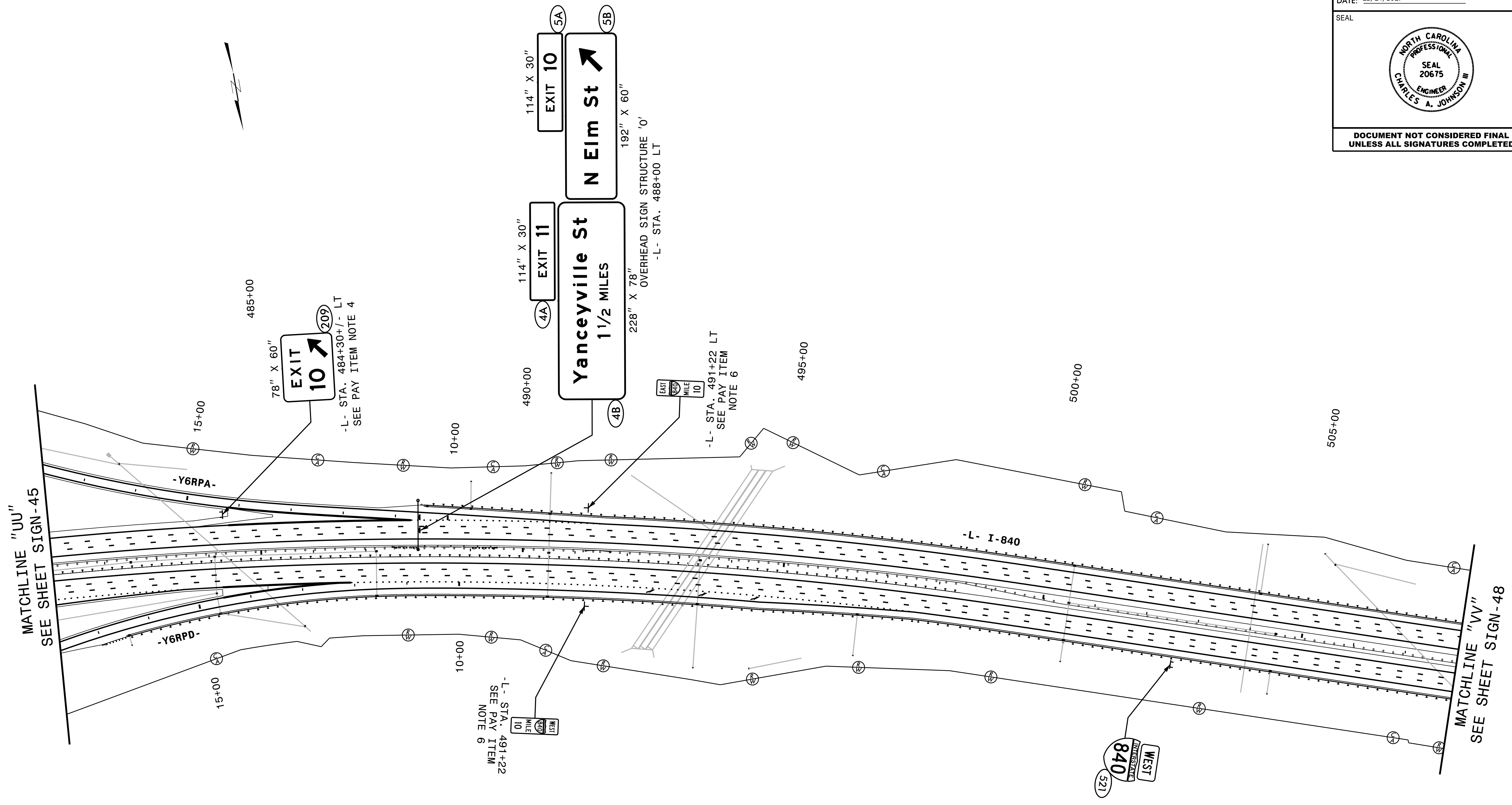

**HNTB** HNTB NORTH CAROLINA, P.C.  
343 E. Six Forks Road, Suite 200  
Raleigh, North Carolina 27609  
NC License No: C-1554  
(919) 546-8997

**PROPOSED SIGNS**  
**-L- STA. 481+00 TO 508+00**

TIP NO. U-2525C	SHEET NO. SIGN-48
APPROVED: <u>Charles A. Johnson, III</u> <small>DocuSigned by: Charles A. Johnson, III SPA15628477544E</small>	
DATE: 12/14/2017	
SEAL	
	
DOCUMENT NOT CONSIDERED FINAL UNLESS ALL SIGNATURES COMPLETED	

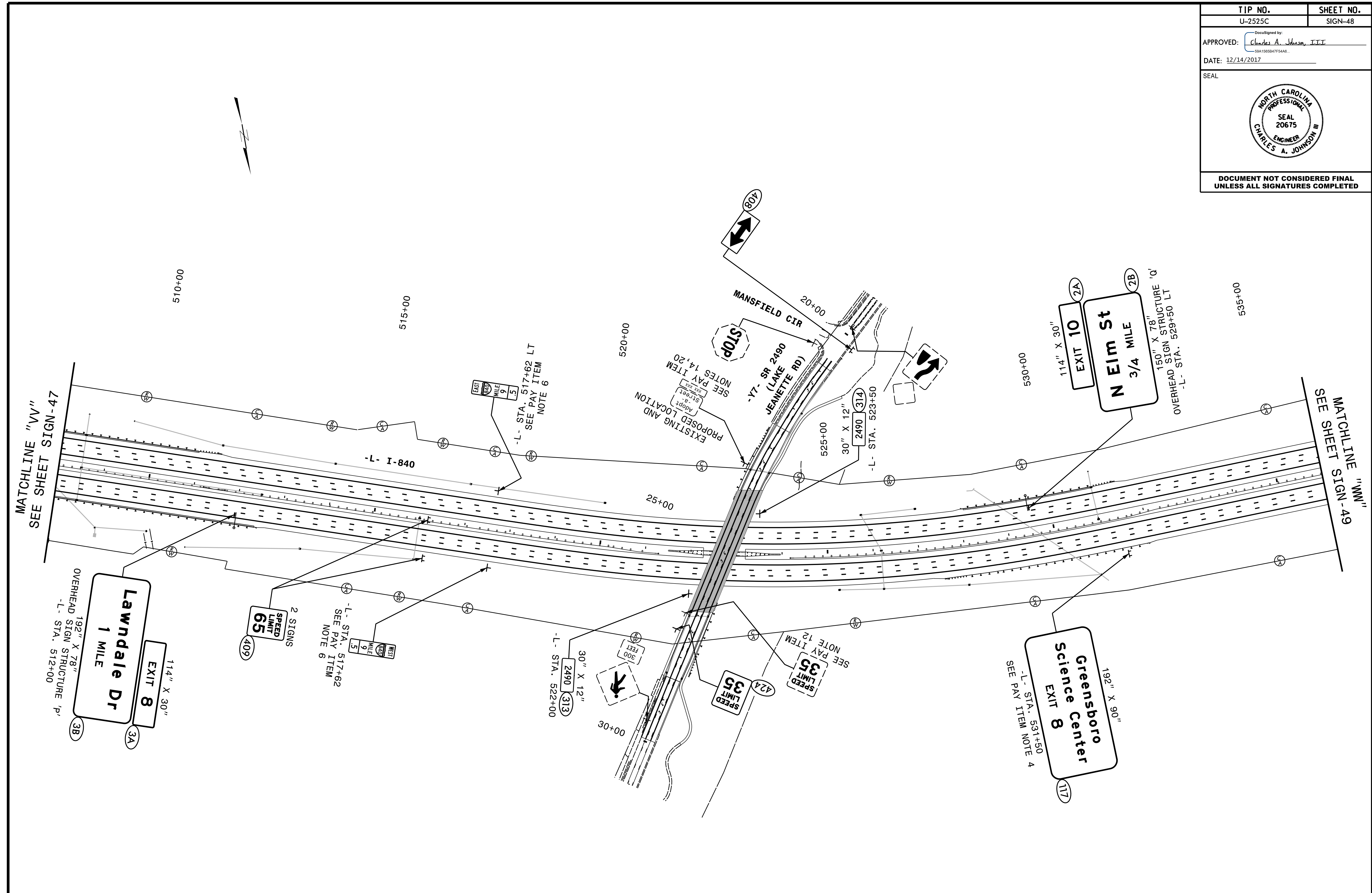

**HNTB** HNTB NORTH CAROLINA, P.C.  
343 E. Six Forks Road, Suite 200  
Raleigh, North Carolina 27609  
NC License No: C-1554  
(919) 546-8997

**EXISTING AND PROPOSED SIGNS  
-L- STA. 508+00 TO 536+00**



TIP NO. U-2525C	SHEET NO. SIGN-49
APPROVED: <i>Charles A. Johnson, III</i> <small>NSA 1558477544E</small>	
DATE: 12/14/2017	
SEAL	
	
DOCUMENT NOT CONSIDERED FINAL UNLESS ALL SIGNATURES COMPLETED	

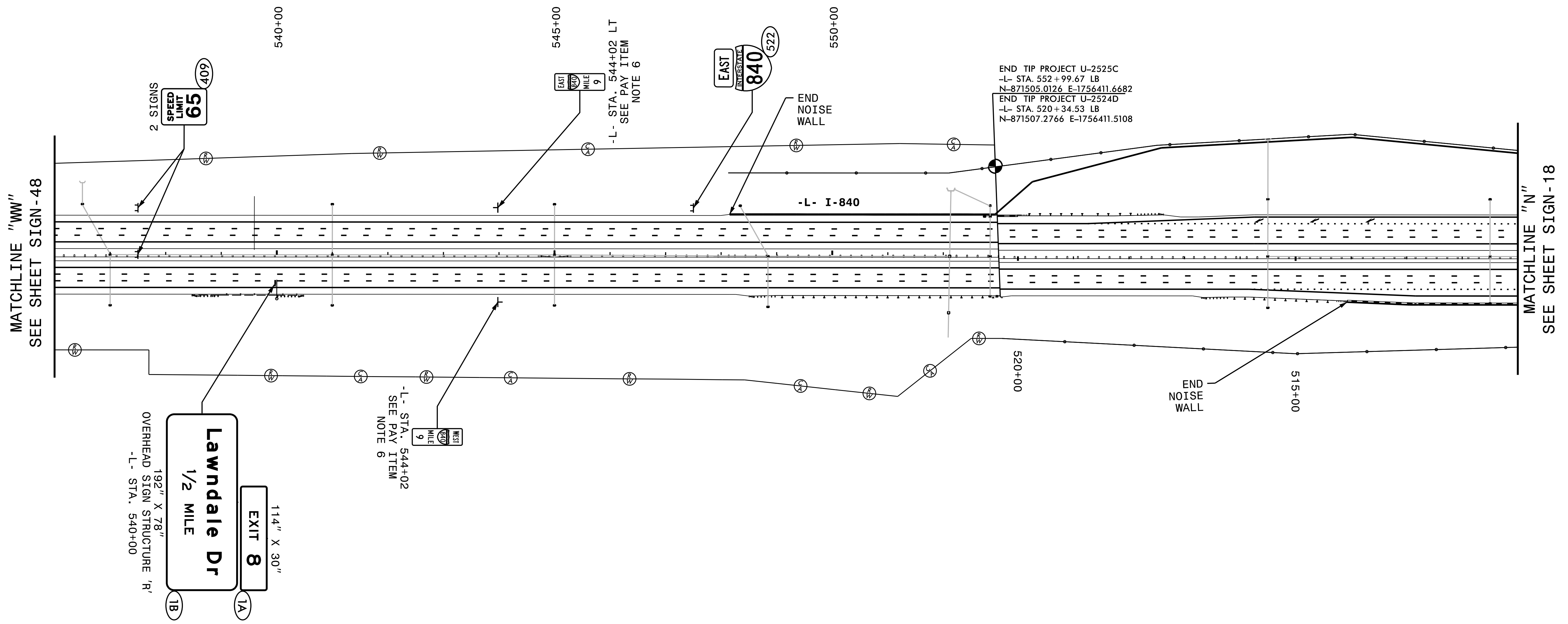

**HNTB** HNTB NORTH CAROLINA, P.C.  
343 E. Six Forks Road, Suite 200  
Raleigh, North Carolina 27609  
NC License No: C-1554  
(919) 546-8997

**PROPOSED SIGNS**  
-L- STA. 536+00 TO 552+99  
AND STA. 520+35 TO 511+00

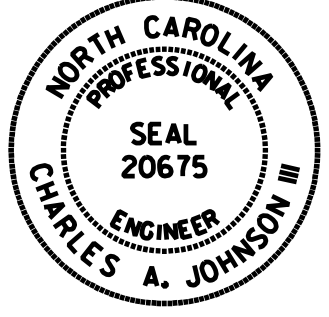
TIP NO. U-2525C	SHEET NO. SIGN-50
APPROVED: <i>Charles A. Johnson, III</i> <small>59A1562847F5A4E</small>	
DATE: 12/14/2017	
SEAL	
	
DOCUMENT NOT CONSIDERED FINAL UNLESS ALL SIGNATURES COMPLETED	

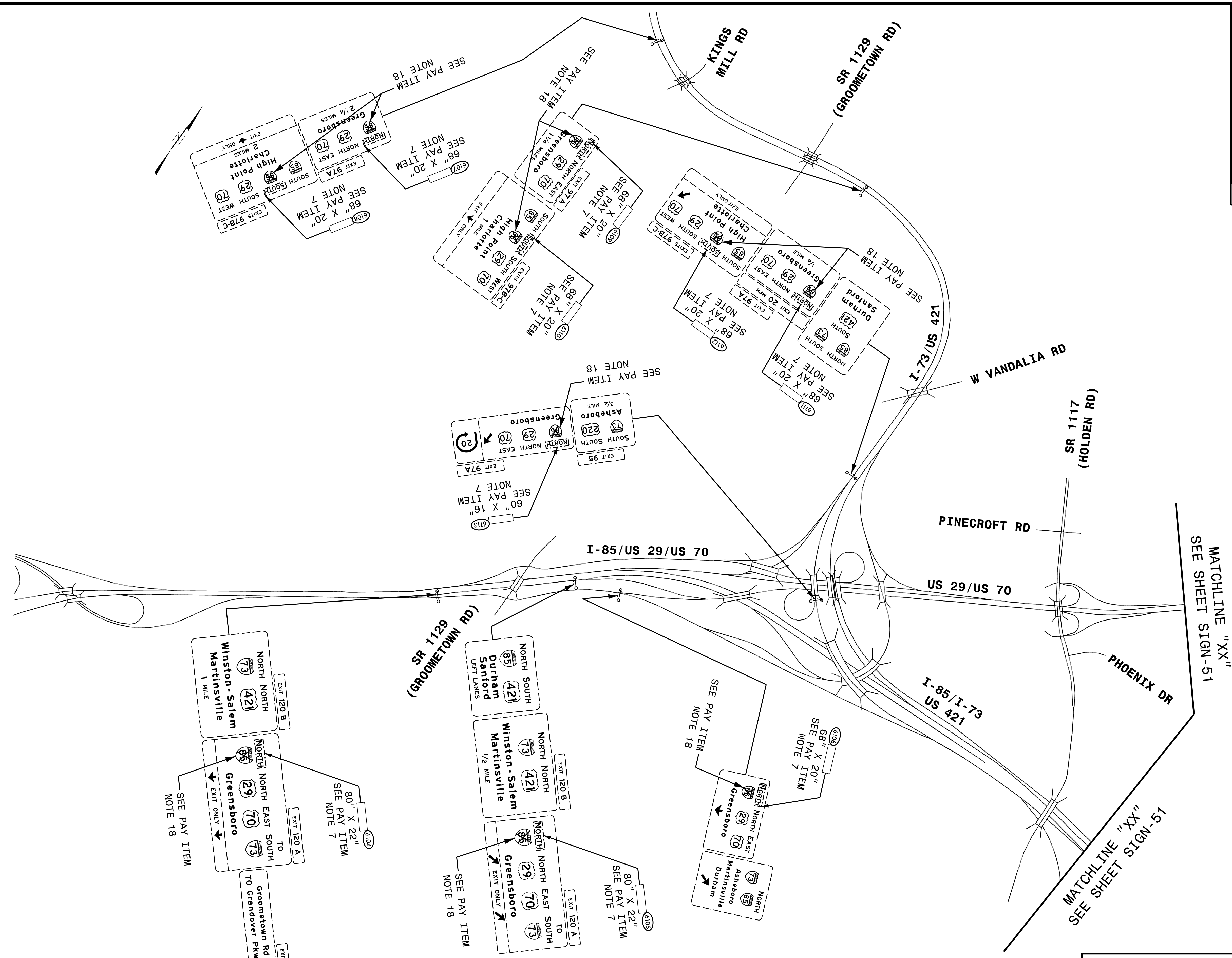

**EXISTING AND PROPOSED SIGNS  
I-85/US 29/US 70/I-73/US 421**

**HNTB**  
 HNTB NORTH CAROLINA, P.C.  
 343 E. Six Forks Road, Suite 200  
 Raleigh, North Carolina 27609  
 NC License No: C-1554  
 (919) 546-8997

MATCHLINE "XX"  
SEE SHEET SIGN-51

MATCHLINE "XX"  
SEE SHEET SIGN-51



TIP NO. U-2525C	SHEET NO. SIGN-51
APPROVED: <i>Charles A. Johnson, III</i> <small>SEA1166047F544E</small>	
DATE: 12/14/2017	
SEAL	
	
DOCUMENT NOT CONSIDERED FINAL UNLESS ALL SIGNATURES COMPLETED	

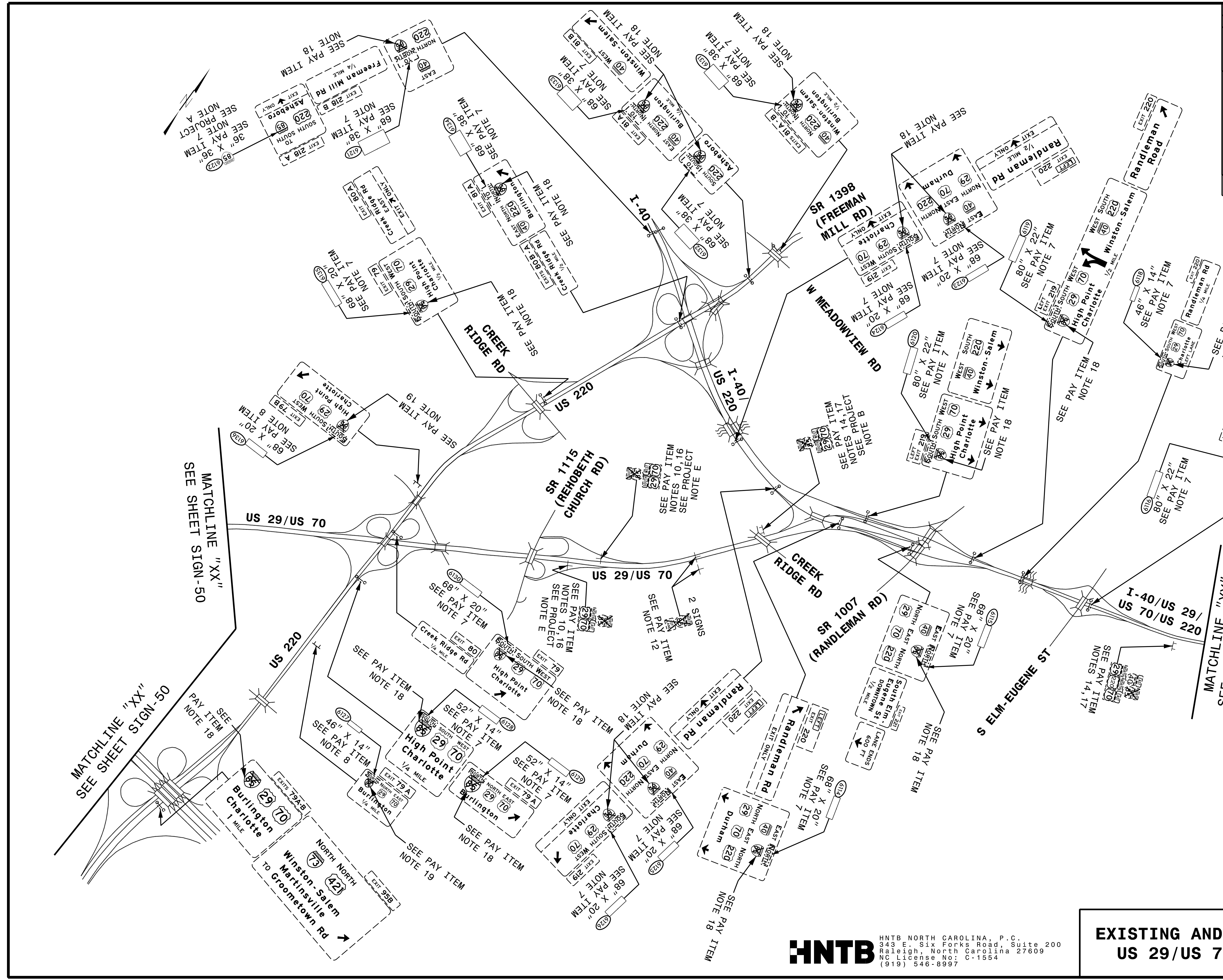

**HNTB**  
 HNTB NORTH CAROLINA, P.C.  
 343 E. Six Forks Road, Suite 200  
 Raleigh, North Carolina 27609  
 NC License No: C-1554  
 (919) 546-8997

**EXISTING AND PROPOSED SIGNS  
 US 29/US 70/I-40/US 220**

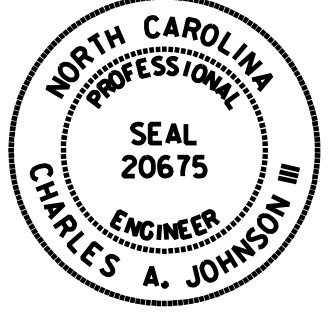

TIP NO. U-2525C	SHEET NO. SIGN-52
APPROVED: <u>Charles A. Johnson, III</u> <small>59A156247F5A4E</small>	
DATE: 12/14/2017	
SEAL	
	
DOCUMENT NOT CONSIDERED FINAL UNLESS ALL SIGNATURES COMPLETED	

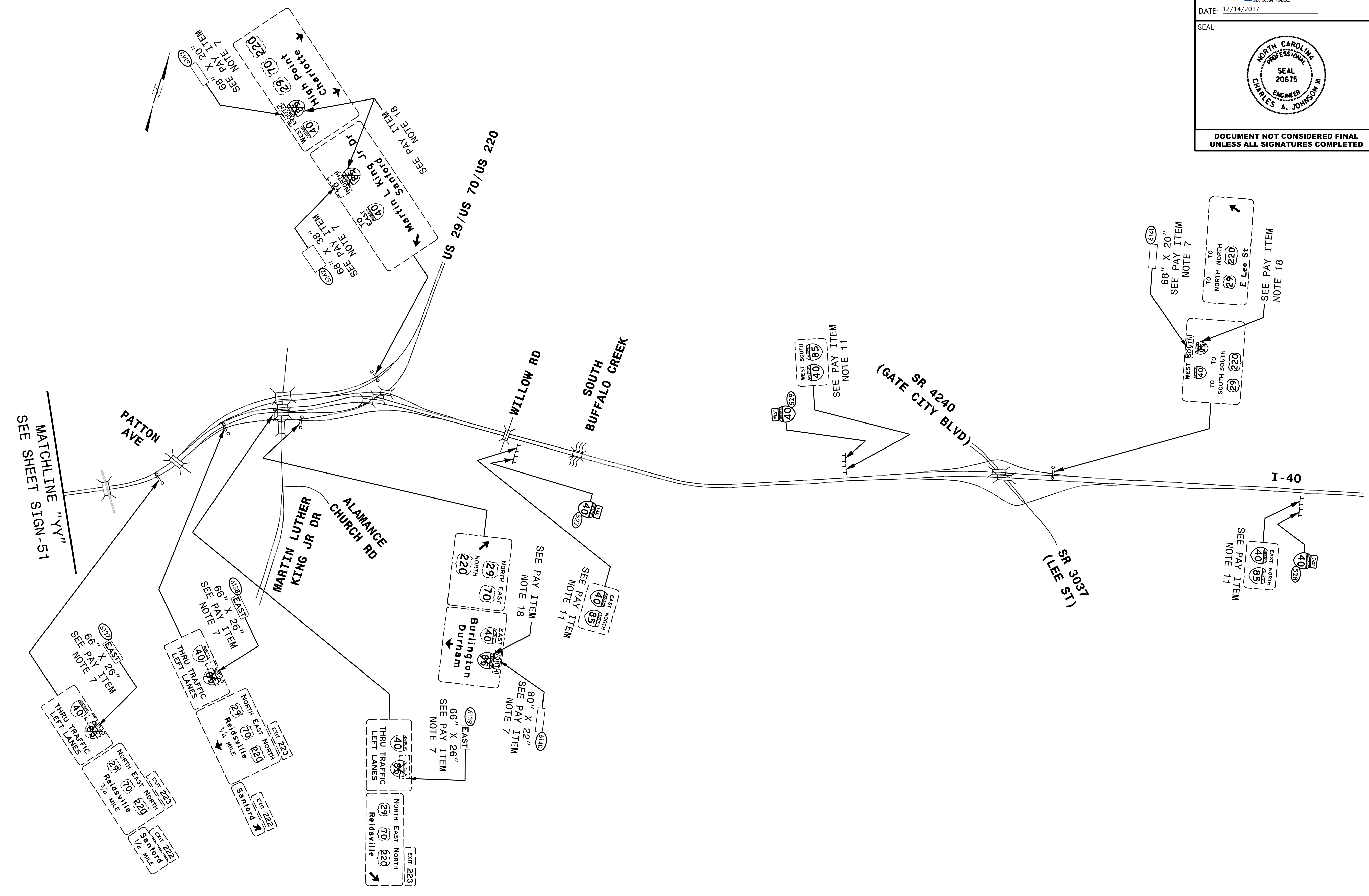

**HNTB** HNTB NORTH CAROLINA, P.C.  
343 E. Six Forks Road, Suite 200  
Raleigh, North Carolina 27609  
NC License No: C-1554  
(919) 546-8997

**EXISTING AND PROPOSED SIGNS  
I-40/US 29/US 70/US 220**



TIP NO. U-2525C	SHEET NO. SIGN-53
APPROVED: <u>Charles A. Johnson, III</u> <small>SEA1565847F54A6</small>	
DATE: 12/14/2017	
SEAL	
	
DOCUMENT NOT CONSIDERED FINAL UNLESS ALL SIGNATURES COMPLETED	

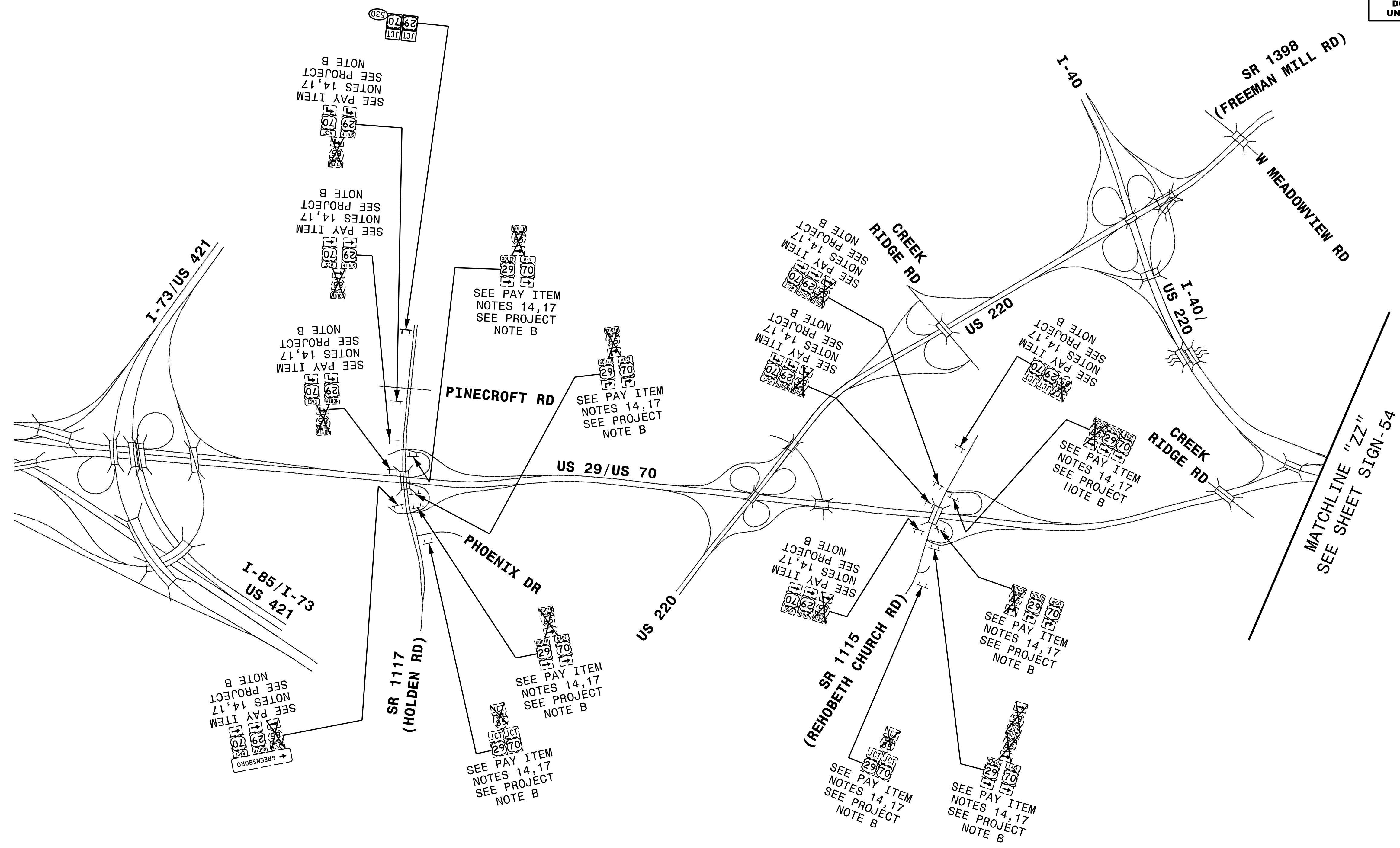

**HNTB**  
 HNTB NORTH CAROLINA, P.C.  
 343 E. Six Forks Road, Suite 200  
 Raleigh, North Carolina 27609  
 NC License No: C-1554  
 (919) 546-8997

**EXISTING AND PROPOSED  
 ROUTE MARKERS  
 US 29/US 70**



TIP NO. U-2525C	SHEET NO. SIGN-54
APPROVED: <u>Charles A. Johnson, III</u> <small>SEA15568477544E</small>	
DATE: 12/14/2017	
SEAL	
	
DOCUMENT NOT CONSIDERED FINAL UNLESS ALL SIGNATURES COMPLETED	

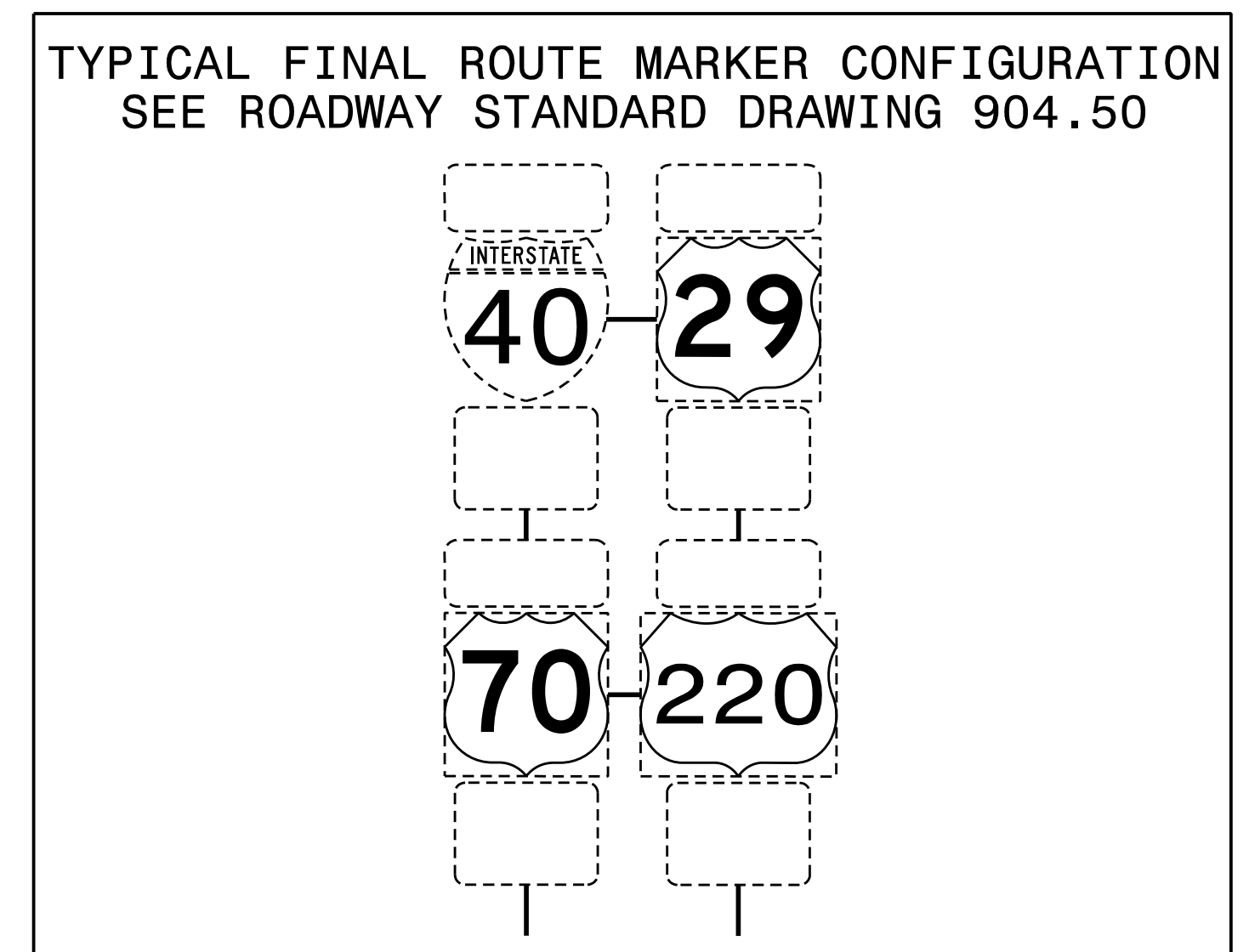
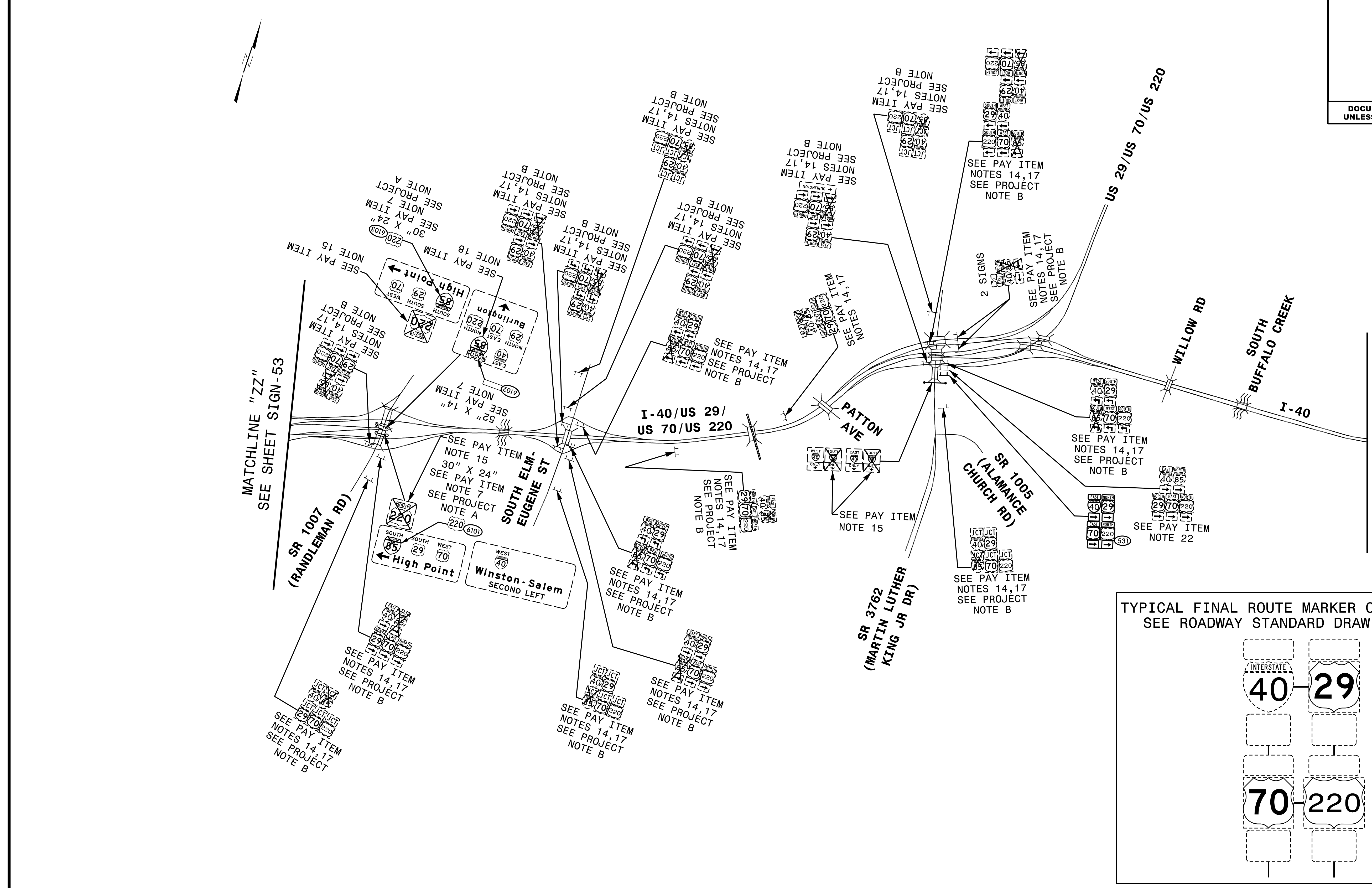

**EXISTING AND PROPOSED SIGNS  
I-40/US 29/US 70/US 220**



TIP NO. U-2525C	SHEET NO. SIGN-55
APPROVED: <u>Charles A. Johnson, III</u> <small>SEA1568477544E</small>	
DATE: 12/14/2017	
SEAL	
	
DOCUMENT NOT CONSIDERED FINAL UNLESS ALL SIGNATURES COMPLETED	

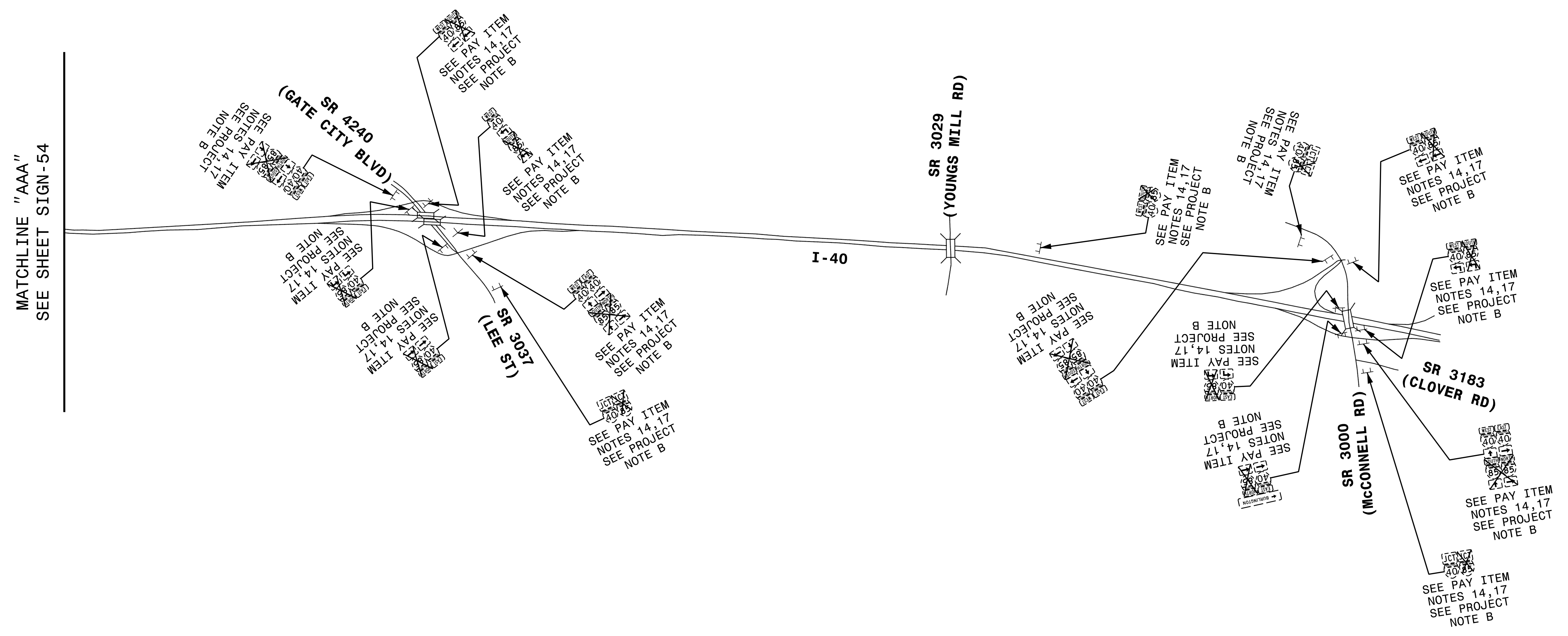

TIP NO. U-2525C	SHEET NO. SIGN-56
APPROVED: <u>Charles A. Johnson, III</u> <small>SSA15010475646</small>	
DATE: 12/15/2017	
SEAL	
	
DOCUMENT NOT CONSIDERED FINAL UNLESS ALL SIGNATURES COMPLETED	

- ITS CONSTRUCTION NOTES**
- 1 INSTALL NEW TRAVEL TIME DMS MODULES
  - 2 INSTALL NEW POLE MOUNTED CABINET

