

**This electronic collection of documents is provided
for the convenience of the user
and is Not a Certified Document –**

**The documents contained herein were originally issued
and sealed by the individuals whose names and license
numbers appear on each page, on the dates appearing
with their signature on that page.**

**This file or an individual page
shall not be considered a certified document.**

TIP NO. U-2525C	SHEET NO. PMP-1
APPROVED: <i>Andrew D. Klinksiek</i> <small>E3078F84598E44B</small>	
DATE: 12/11/2017	
	
DOCUMENT NOT CONSIDERED FINAL UNLESS ALL SIGNATURES COMPLETED	

**STATE OF NORTH CAROLINA
DEPARTMENT OF TRANSPORTATION**

**PAVEMENT MARKING PLAN
GUILFORD COUNTY**

T.I.P.: U-2525C

CONTRACT: C204096

INDEX

SHEET NO.	DESCRIPTION
PMP-1	PAVEMENT MARKING PLAN COVER SHEET
PMP-2	PAVEMENT MARKING SCHEDULE AND LEGEND
PMP-3 THRU PMP-36	PAVEMENT MARKING DETAIL

GENERAL NOTES

- THE FOLLOWING GENERAL NOTES APPLY AT ALL TIMES FOR THE DURATION OF THE CONSTRUCTION PROJECT, EXCEPT WHEN OTHERWISE NOTED IN THE PLAN, OR DIRECTED BY THE ENGINEER.
- A) INSTALL PAVEMENT MARKINGS AND PAVEMENT MARKERS ON THE FINAL SURFACE AS FOLLOWS:
- | ROAD NAME | MARKING | MARKER |
|-----------|------------------------------------|-------------------------|
| -L- I-840 | POLYUREA W/HIGHLY REFLECTIVE MEDIA | SNOWPLOWABLE REFLECTIVE |
| -Y- LINES | POLYUREA W/HIGHLY REFLECTIVE MEDIA | MATCH EXISTING |
| BRIDGES | POLYUREA W/HIGHLY REFLECTIVE MEDIA | RAISED REFLECTIVE |
- B) TIE PROPOSED PAVEMENT MARKING LINES TO EXISTING PAVEMENT MARKING LINES.
- C) REMOVE/REPLACE ANY CONFLICTING/DAMAGED PAVEMENT MARKINGS AND MARKERS.
- D) PASSING ZONES WILL BE DETERMINED IN THE FIELD AND MUST BE APPROVED BY THE ENGINEER.
- E) STOP BAR LOCATION AT NON-SIGNALIZED INTERSECTIONS MAY BE ADJUSTED AS DIRECTED BY THE ENGINEER.
- F) REMOVE ALL RESIDUE AND SURFACE LAITANCE BY ACCEPTABLE METHODS ON CONCRETE BRIDGE DECKS PRIOR TO PLACING (POLYUREA) PAVEMENT MARKING MATERIAL.
- G) UNLESS OTHERWISE SPECIFIED, HEATED-IN-PLACE THERMOPLASTIC MAY BE USED IN LIEU OF EXTRUDED THERMOPLASTIC FOR STOP BARS, SYMBOLS, CHARACTERS AND DIAGONALS. IF HEATED-IN-PLACE IS USED, IT SHALL BE PAID FOR USING THE EXTRUDED THERMOPLASTIC PAY ITEM.
- H) SEE ROADWAY PLANS FOR ALTERNATE CURB RAMP DESIGNS WHEN INDICATED ON PAVEMENT MARKING DETAIL SHEETS.

ROADWAY STANDARD DRAWING

THE FOLLOWING ROADWAY STANDARDS AS APPEAR IN "ROADWAY STANDARD DRAWINGS" - PROJECT SERVICES UNIT - N.C. DEPARTMENT OF TRANSPORTATION - RALEIGH, N.C., DATED JANUARY 2018 ARE APPLICABLE TO THIS PROJECT AND BY REFERENCE HEREBY ARE CONSIDERED A PART OF THESE PLANS:

STD. NO.	TITLE
1205.01	PAVEMENT MARKINGS - LINE TYPES AND OFFSETS
1205.02	PAVEMENT MARKINGS - TWO-LANE AND MULTILANE ROADWAYS
1205.03	PAVEMENT MARKINGS - EXIT AND ENTRANCE RAMP
1205.04	PAVEMENT MARKINGS - INTERSECTIONS
1205.05	PAVEMENT MARKINGS - TURN LANES
1205.06	PAVEMENT MARKINGS - LANE DROPS
1205.07	PAVEMENT MARKINGS - PEDESTRIAN CROSSWALKS
1205.08	PAVEMENT MARKINGS - SYMBOLS AND WORD MESSAGES
1205.09	PAVEMENT MARKINGS - PAINTED ISLANDS
1205.10	PAVEMENT MARKINGS - SCHOOL AREAS
1205.11	PAVEMENT MARKINGS - RAILROAD CROSSINGS
1205.12	PAVEMENT MARKINGS - BRIDGES
1205.13	PAVEMENT MARKINGS - LANE REDUCTIONS
1205.14	PAVEMENT MARKINGS - ROUNDABOUTS
1205.15	PAVEMENT MARKINGS - SUPERSTREETS
1250.01	RAISED PAVEMENT MARKERS - INSTALLATION SPACING
1251.01	RAISED PAVEMENT MARKERS - PERMANENT AND TEMPORARY
1253.01	RAISED PAVEMENT MARKERS - SNOWPLOWABLE
1261.01	GUARDRAIL AND BARRIER DELINEATORS - INSTALLATION SPACING
1261.02	GUARDRAIL AND BARRIER DELINEATORS - TYPES AND MOUNTING
1262.01	GUARDRAIL END DELINEATION
1264.01	OBJECT MARKERS - TYPES
1264.02	OBJECT MARKERS - INSTALLATION
1266.01	RAISED PAVEMENT MARKERS - TUBULAR MARKERS
1267.01	FLEXIBLE DELINEATORS - INSTALLATION
1267.02	FLEXIBLE DELINEATORS - SPACING TABLES
1267.03	FLEXIBLE DELINEATORS - INTERCHANGE PLACEMENT

PLANS REVIEWED BY: N.C.D.O.T. SIGNING AND DELINEATION UNIT

<i>Kelvin Jordan</i>	SIGNING & DELINEATION REGIONAL ENGINEER
<i>Ashley Matthews</i>	SIGNING & DELINEATION PROJECT DESIGN ENGINEER

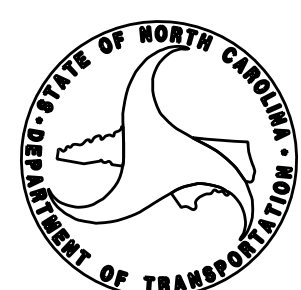

PLAN PREPARED BY: HNTB NORTH CAROLINA, P.C.

<i>A.D. Klinksiek, PE, PTOE</i>	PROJECT ENGINEER
<i>J.A. Wagner, EI</i>	DESIGN ENGINEER

HNTB HNTB NORTH CAROLINA, P.C.
343 E. Six Forks Road, Suite 200
Raleigh, North Carolina 27609
NC License No: C-1554
(919) 546-8997

TIP NO. U-2525C	SHEET NO. PMP-2
APPROVED: <i>Andrew D. Klinvick</i> <small>E3078F8459E44B</small>	
DATE: 12/11/2017	
	
DOCUMENT NOT CONSIDERED FINAL UNLESS ALL SIGNATURES COMPLETED	

FINAL PAVEMENT MARKING SCHEDULE

MATERIAL	SYMBOL	DESCRIPTION
PAVEMENT MARKING		
<u>POLYUREA (4") Highly Reflective Media</u>		
	V8	2 FT.-6 FT./SP WHITE MINISKIP
	V9	2 FT.-6 FT./SP YELLOW MINISKIP
	VA	WHITE EDGELINE
	VB	YELLOW EDGELINE
	VC	10 FT. WHITE SKIP
	VD	3 FT.-9 FT./SP WHITE MINISKIP
	VE	WHITE SOLID LANE LINE
	VF	10 FT. YELLOW SKIP
	VH	YELLOW SINGLE CENTER
	VI	YELLOW DOUBLE CENTER
<u>POLYUREA (6") Highly Reflective Media</u>		
	V6	WHITE EDGELINE
	V7	YELLOW EDGELINE
	V11	2 FT.- 6 FT./SP WHITE MINISKIP
	V16	YELLOW DOUBLE CENTER
	VJ	10 FT. WHITE SKIP
	VK	3 FT.- 9 FT./SP WHITE MINISKIP
	VL	WHITE SOLID LANE LINE
<u>POLYUREA (8") Highly Reflective Media</u>		
	VN	WHITE GORELINE
	VR	WHITE SOLID LANE LINE
	V13	3 FT. - 9 FT./SP WHITE MINISKIP
<u>POLYUREA (12") Highly Reflective Media</u>		
	VS	WHITE GORELINE
	VT	WHITE SOLID LANE LINE
	V14	3 FT. - 9 FT./SP WHITE MINISKIP
<u>THERMOPLASTIC (8", 90 MILS)</u>		
	T0	WHITE DIAGONAL
	TP	YELLOW DIAGONAL
<u>THERMOPLASTIC (12", 90 MILS)</u>		
	TU	WHITE DIAGONAL
	TV	YELLOW DIAGONAL
<u>THERMOPLASTIC (24", 120 MILS)</u>		
	T2	WHITE STOPBAR
	T3	WHITE CROSSWALK LINE



<u>THERMOPLASTIC PAVEMENT MARKING SYMBOLS (90 MILS)</u>	
UA	LEFT TURN ARROW
UB	RIGHT TURN ARROW
UC	STRAIGHT ARROW
UD	COMBO STRAIGHT/LEFT
UE	COMBO STRAIGHT/RIGHT
UP	MERGE ARROW
UQ	RAMP ARROW
YE	ELONGATED STRAIGHT ARROW
<u>THERMOPLASTIC PAVEMENT MARKING CHARACTER (120 MILS)</u>	
UI	ALPHANUMERIC CHAR.
<u>PERMANENT RAISED PAVEMENT MARKERS (NOT SHOWN)</u>	
MA	YELLOW & YELLOW
MB	CRYSTAL & RED
<u>SNOWPLOWABLE PAVEMENT MARKERS (NOT SHOWN)</u>	
ME	YELLOW & YELLOW
MF	CRYSTAL & RED

LEGEND

GENERAL

 DIRECTION OF TRAFFIC FLOW

 NORTH ARROW





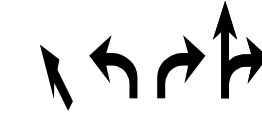

 PROPOSED PVMT.  EXIST. PVMT.

PAVEMENT MARKINGS

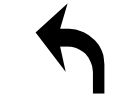
 PAVEMENT MARKING SYMBOLS

 ONLY PAVEMENT MARKING CHARACTERS

PAVEMENT MARKING SYMBOLS

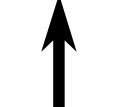
	UA
	UB
	UC
	UD
	UE
ONLY	UI
	UP
	UQ
	YE

11/7/2017 11:45 AM P:\MP\Ustrn\U2525C_PMP_01-02.dgn HNTB

HNTB HNTB NORTH CAROLINA, P.C.
343 E. SIX FORKS ROAD, SUITE 200
RALEIGH, NORTH CAROLINA 27609
NC License No: C-1554
(919) 546-8997

PAVEMENT MARKING SCHEDULE AND LEGEND

TIP NO. U-2525C	SHEET NO. PMP-3
APPROVED: <i>Andrew D. Klincksiek</i> <small>E3078FB498E44B</small>	
DATE: 12/11/2017	
	
DOCUMENT NOT CONSIDERED FINAL UNLESS ALL SIGNATURES COMPLETED	

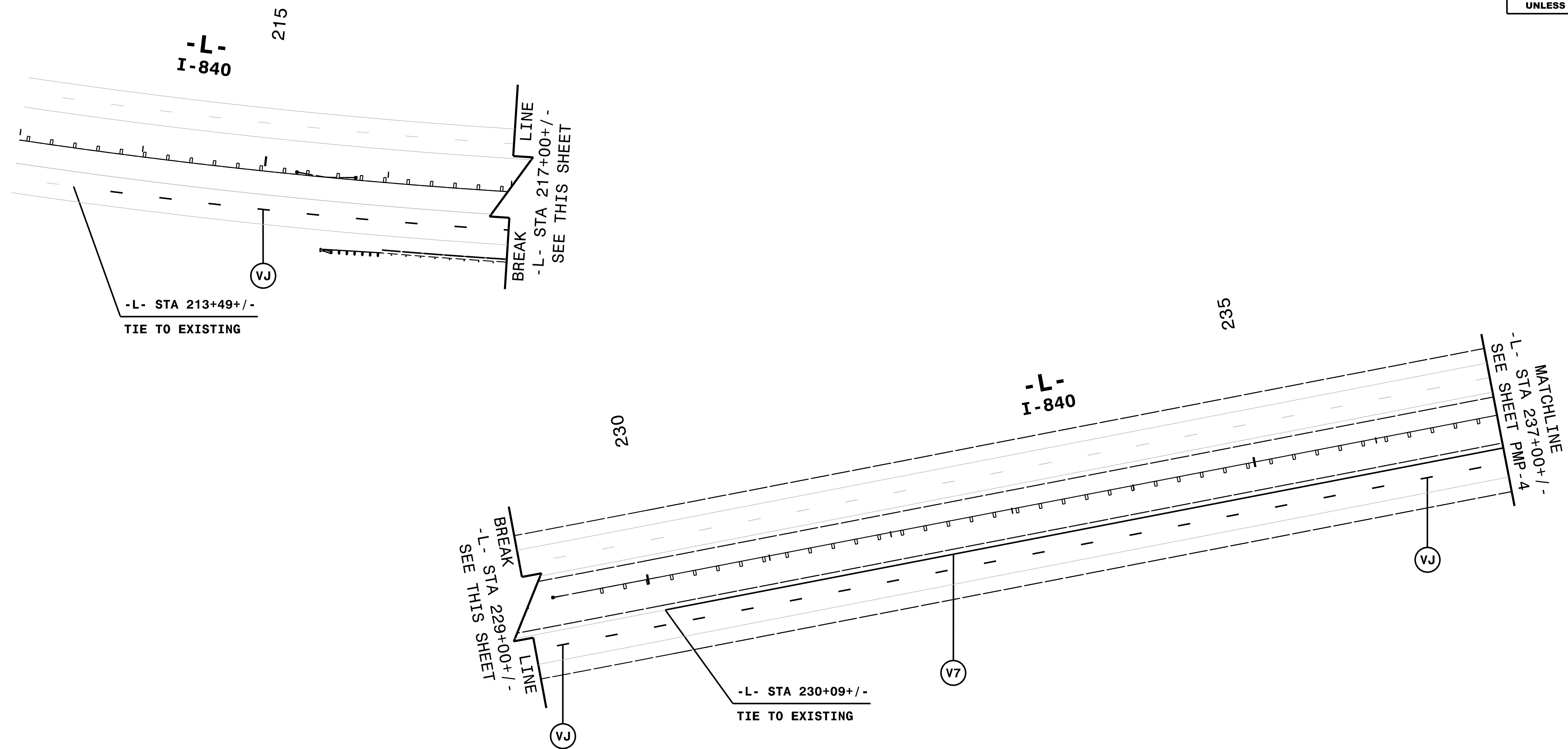
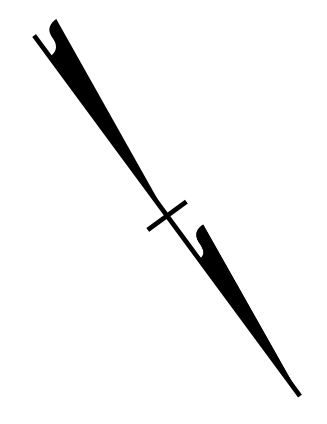

NOTE: ALL LANE WIDTHS ARE 12' UNLESS OTHERWISE SHOWN.
REMOVE CONFLICTING PAVEMENT MARKING.

IV/7/2017
I:\PMP\ustrn\U2525C_PMP_03.dgn
HNTB

HNTB
 HNTB NORTH CAROLINA, P.C.
 343 E. Six Forks Road, Suite 200
 Raleigh, North Carolina 27609
 NC License No: C-1554
 (919) 546-8997

PAVEMENT MARKING DETAIL

TIP NO. U-2525C	SHEET NO. PMP-4
APPROVED: <i>Andrew D. Klincksiek</i> <small>E3078FB498E44B</small>	
DATE: 12/11/2017	
	
DOCUMENT NOT CONSIDERED FINAL UNLESS ALL SIGNATURES COMPLETED	

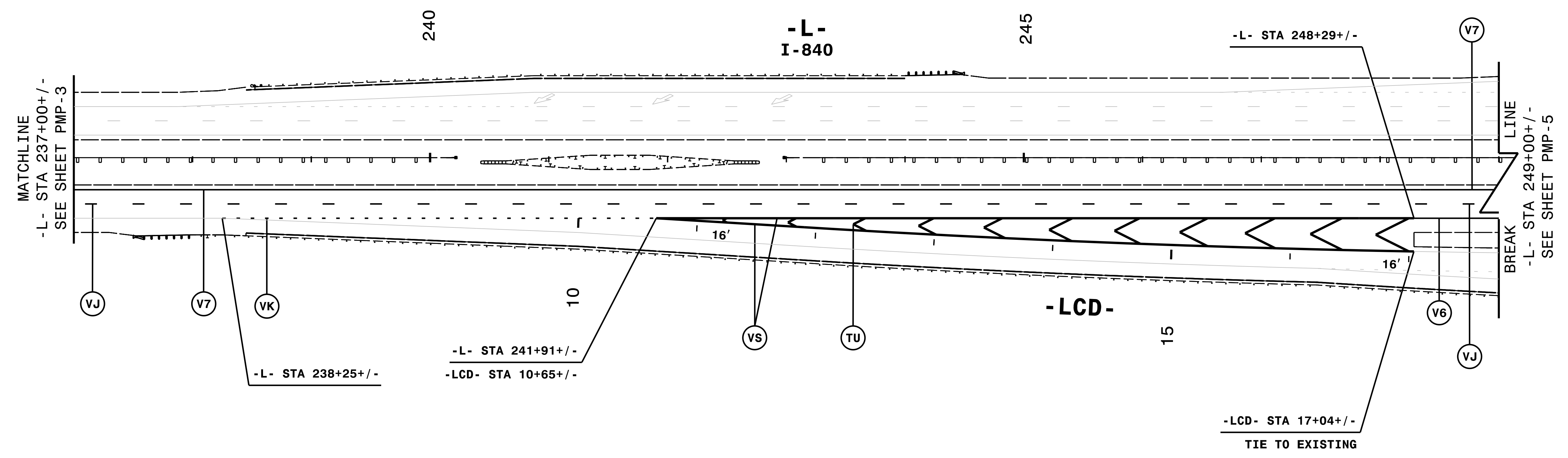

NOTE: ALL LANE WIDTHS ARE 12' UNLESS OTHERWISE SHOWN.

REMOVE CONFLICTING PAVEMENT MARKING.

11/7/2017
 I:\PMP\ustr\U2525C_PMP_04.dgn
 HNTB

HNTB

HNTB NORTH CAROLINA, P.C.
 343 E. SIX FORKS ROAD, SUITE 200
 RALEIGH, NORTH CAROLINA 27609
 NC LICENSE NO: C-1554
 (919) 546-8997

PAVEMENT MARKING DETAIL

TIP NO. U-2525C	SHEET NO. PMP-5
APPROVED: <i>Andrew D. Klincksiek</i> E3078F849E44B	
DATE: 12/11/2017	
	
DOCUMENT NOT CONSIDERED FINAL UNLESS ALL SIGNATURES COMPLETED	

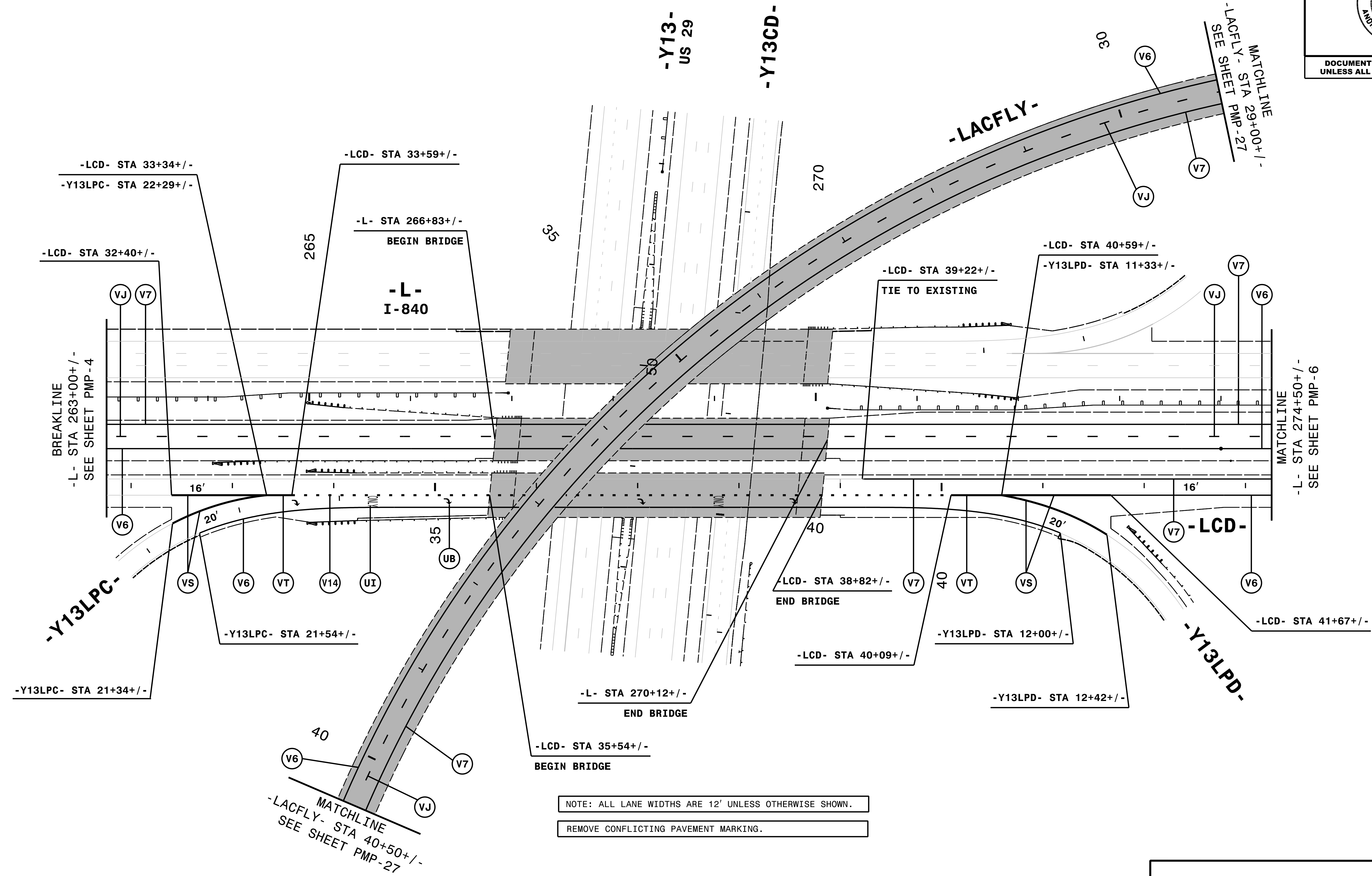

11/7/2017
I:\PMP\ustr\U2525C_PMP_05.dgn
HNTB

HNTB HNTB NORTH CAROLINA, P.C.
343 E. Six Forks Road, Suite 200
Raleigh, North Carolina 27609
NC License No: C-1554
(919) 546-8997

PAVEMENT MARKING DETAIL

TIP NO. U-2525C	SHEET NO. PMP-6
APPROVED: <i>Andrew D. Klincksiek</i> E3078FB49E44B	
DATE: 12/11/2017	
	
DOCUMENT NOT CONSIDERED FINAL UNLESS ALL SIGNATURES COMPLETED	

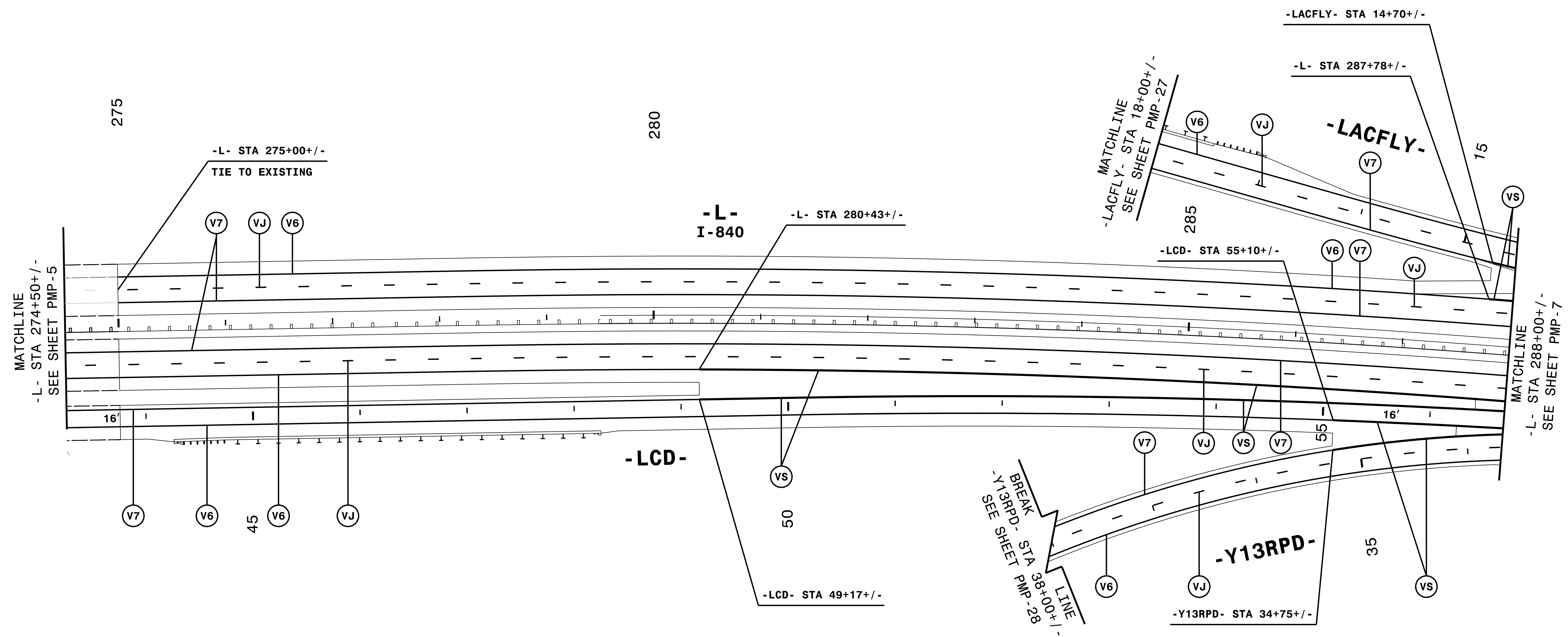

NOTE: ALL LANE WIDTHS ARE 12' UNLESS OTHERWISE SHOWN.
REMOVE CONFLICTING PAVEMENT MARKING.

IV/7/2017
I:\PMP\ustr\U2525C_PMP_06.dgn
HNTB

HNTB
HNTB NORTH CAROLINA, P.C.
343 E. SIX FORKS ROAD, SUITE 200
RALEIGH, NORTH CAROLINA 27609
NC LICENSE NO: C-1554
(919) 546-8997

PAVEMENT MARKING DETAIL

TIP NO. U-2525C	SHEET NO. PMP-7
APPROVED: <i>Andrew D. Klincksiek</i> E3078F849E44B	
DATE: 12/11/2017	
	
DOCUMENT NOT CONSIDERED FINAL UNLESS ALL SIGNATURES COMPLETED	

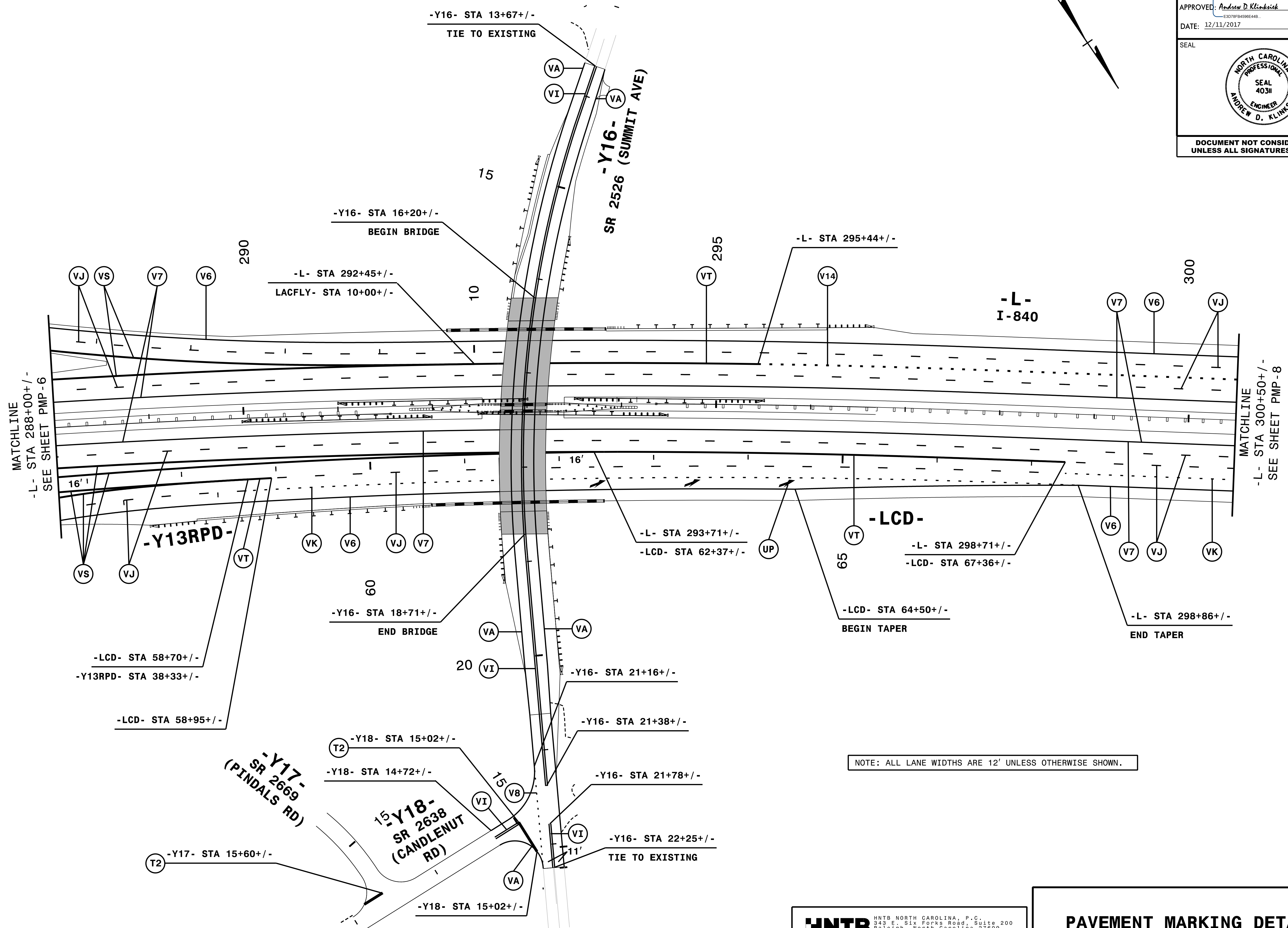

NOTE: ALL LANE WIDTHS ARE 12' UNLESS OTHERWISE SHOWN.

11/7/2017
I:\PMP\ustr\U2525C_PMP_07.dgn
HNTB

HNTB
 HNTB NORTH CAROLINA, P.C.
 343 E. Six Forks Road, Suite 200
 Raleigh, North Carolina 27609
 NC License No: C-1554
 (919) 546-8997

PAVEMENT MARKING DETAIL

TIP NO. U-2525C	SHEET NO. PMP-9
APPROVED: <i>Andrew D. Klinck</i> <small>E3078FB498E44B</small>	
DATE: 12/11/2017	
	
DOCUMENT NOT CONSIDERED FINAL UNLESS ALL SIGNATURES COMPLETED	

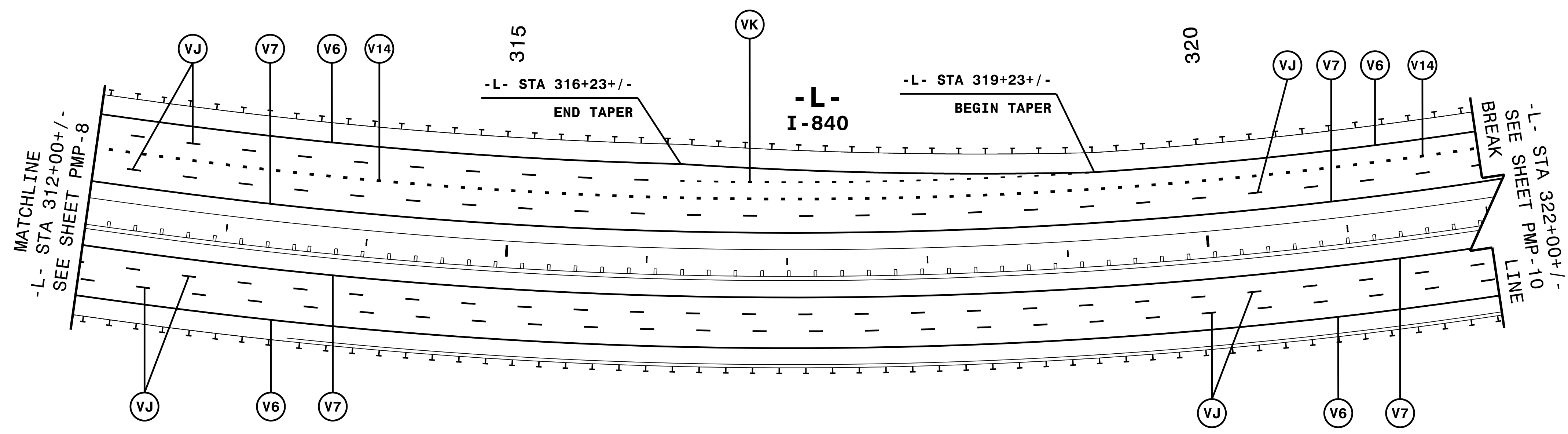
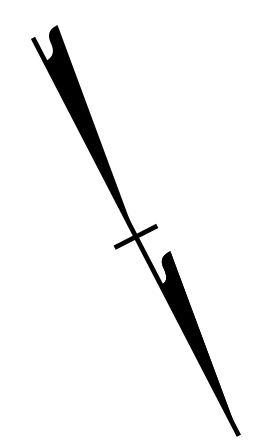

NOTE: ALL LANE WIDTHS ARE 12' UNLESS OTHERWISE SHOWN.

11/7/2017
 I:\PMP\ustrn\U2525C_PMP_09.dgn
 HNTB

HNTB HNTB NORTH CAROLINA, P.C.
 343 E. Six Forks Road, Suite 200
 Raleigh, North Carolina 27609
 NC License No: C-1554
 (919) 546-8997

PAVEMENT MARKING DETAIL

TIP NO. U-2525C	SHEET NO. PMP-10
APPROVED: <i>Andrew D. Klincksiek</i> <small>ES078FB49E44B</small>	
DATE: 12/11/2017	
	
DOCUMENT NOT CONSIDERED FINAL UNLESS ALL SIGNATURES COMPLETED	

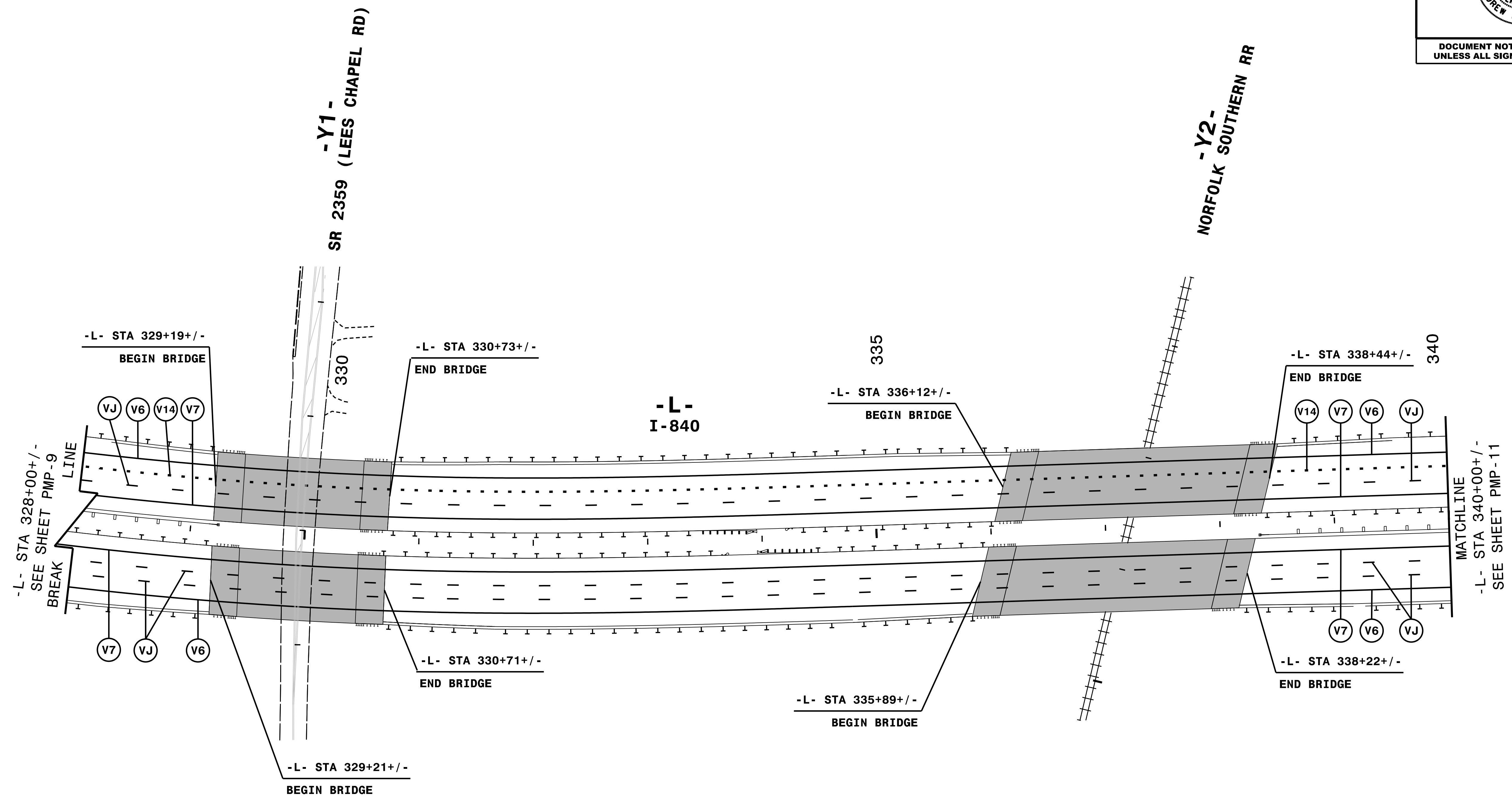

NOTE: ALL LANE WIDTHS ARE 12' UNLESS OTHERWISE SHOWN.

11/7/2017
I:\PMP\ustrn\U2525C_PMP_10.dgn
HNTB

HNTB
 HNTB NORTH CAROLINA, P.C.
 343 E. Six Forks Road, Suite 200
 Raleigh, North Carolina 27609
 NC License No: C-1554
 (919) 546-8997

PAVEMENT MARKING DETAIL

TIP NO. U-2525C	SHEET NO. PMP-11
APPROVED: <i>Andrew D. Klincksiek</i> <small>E3078FB498E44B</small>	
DATE: 12/11/2017	
	
DOCUMENT NOT CONSIDERED FINAL UNLESS ALL SIGNATURES COMPLETED	

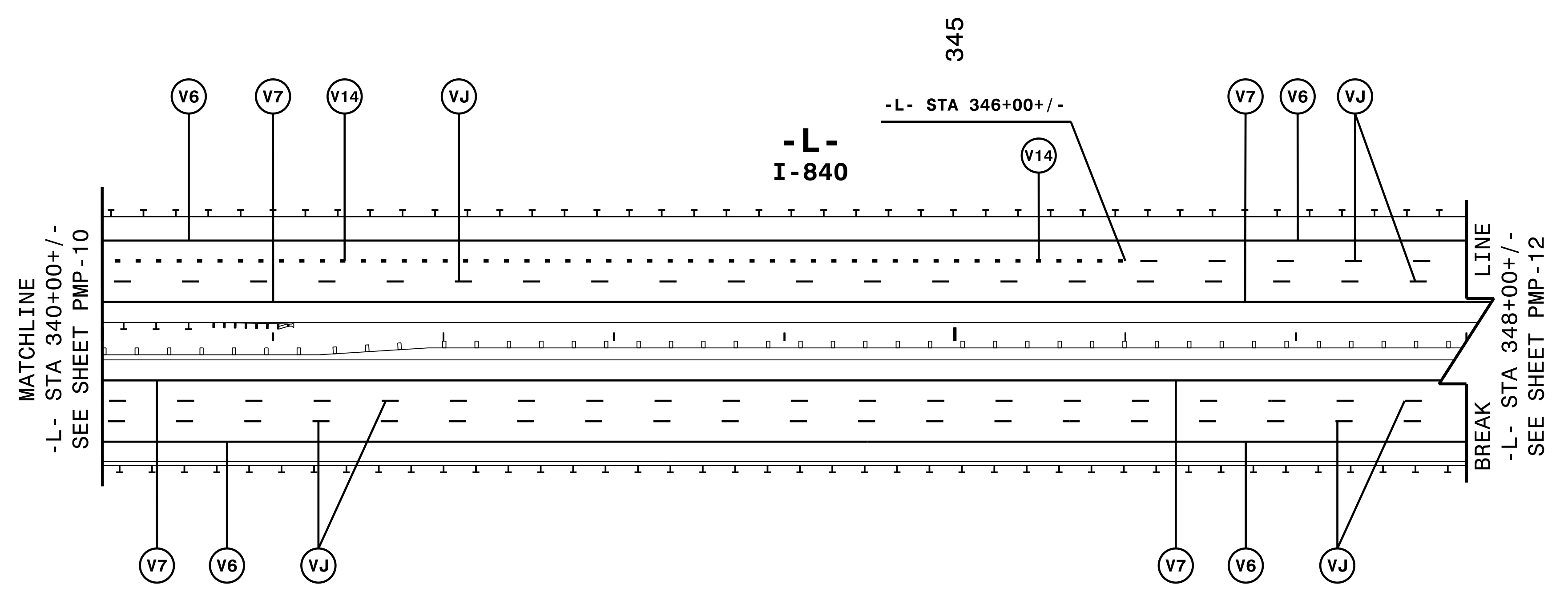

NOTE: ALL LANE WIDTHS ARE 12' UNLESS OTHERWISE SHOWN.

IV/7/2017
I:\PMP\ustrn\U2525C_PMP_11.dgn
HNTB

HNTB HNTB NORTH CAROLINA, P.C.
343 E. SIX FORKS ROAD, SUITE 200
RALEIGH, NORTH CAROLINA 27609
NC LICENSE NO: C-1554
(919) 546-8997

PAVEMENT MARKING DETAIL

TIP NO. U-2525C	SHEET NO. PMP-12
APPROVED: <i>Andrew D. Klinck</i> E3078F8459E44B	
DATE: 12/11/2017	
	
DOCUMENT NOT CONSIDERED FINAL UNLESS ALL SIGNATURES COMPLETED	

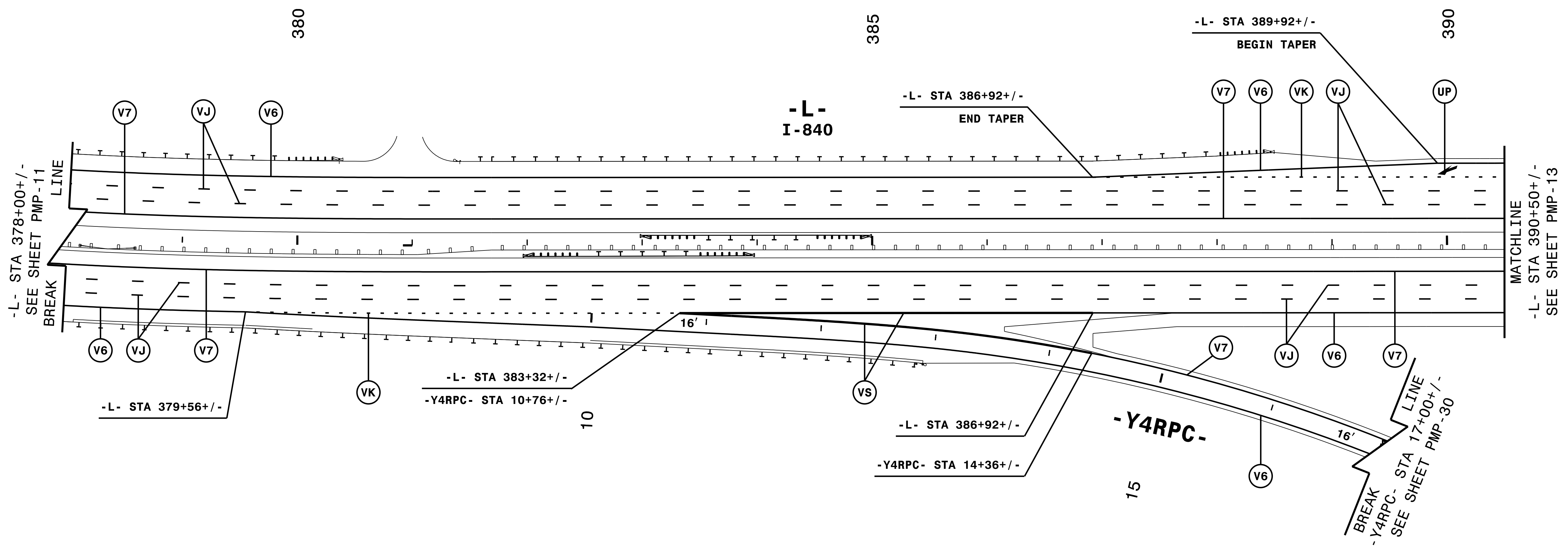

NOTE: ALL LANE WIDTHS ARE 12' UNLESS OTHERWISE SHOWN.

11/7/2017
I:\PMP\ustr\U2525C_PMP_12.dgn
HNTB

HNTB
 HNTB NORTH CAROLINA, P.C.
 343 E. SIX FORKS ROAD, SUITE 200
 RALEIGH, NORTH CAROLINA 27609
 NC LICENSE NO: C-1554
 (919) 546-8997

PAVEMENT MARKING DETAIL

TIP NO. U-2525C	SHEET NO. PMP-14
APPROVED: <i>Andrew D. Klinck</i> <small>E3078F849E44B</small>	
DATE: 12/11/2017	
	
DOCUMENT NOT CONSIDERED FINAL UNLESS ALL SIGNATURES COMPLETED	

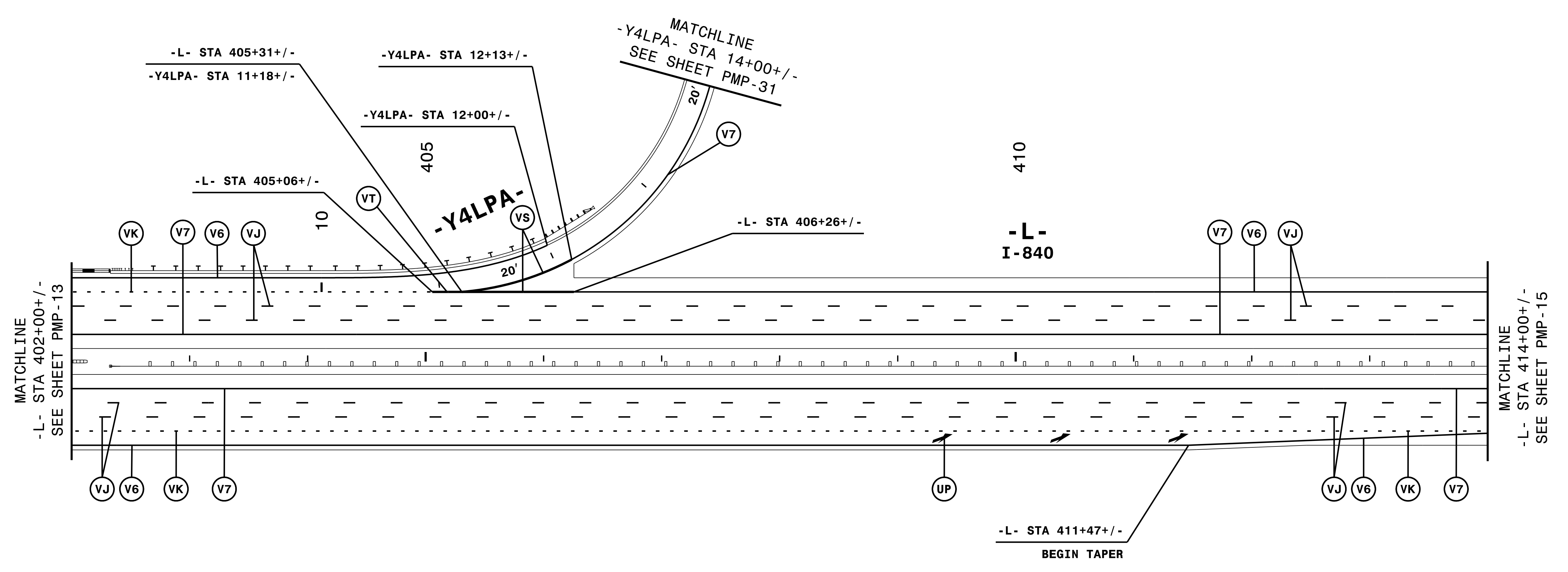

NOTE: ALL LANE WIDTHS ARE 12' UNLESS OTHERWISE SHOWN.

11/7/2017
I:\PMP\ustrn\U2525C_PMP_14.dgn
HNTB

HNTB
 HNTB NORTH CAROLINA, P.C.
 343 E. Six Forks Road, Suite 200
 Raleigh, North Carolina 27609
 NC License No: C-1554
 (919) 546-8997

PAVEMENT MARKING DETAIL

TIP NO. U-2525C	SHEET NO. PMP-15
APPROVED: <i>Andrew D. Klincksiek</i> <small>ES078FB498E44B</small>	
DATE: 12/11/2017	
	
DOCUMENT NOT CONSIDERED FINAL UNLESS ALL SIGNATURES COMPLETED	

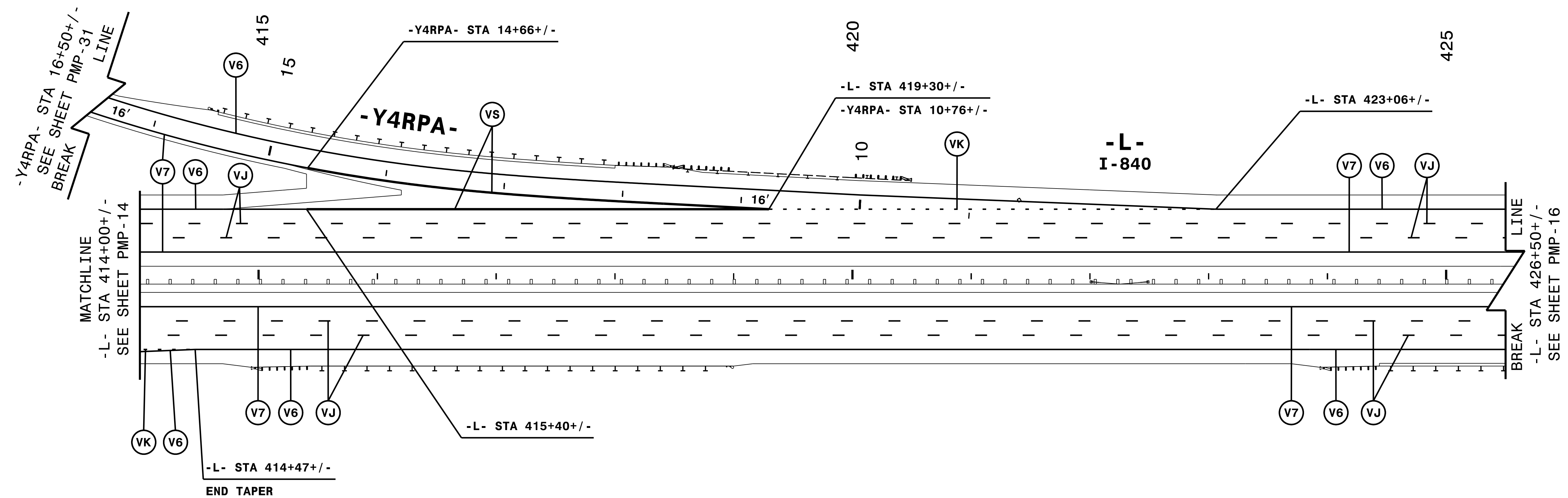

NOTE: ALL LANE WIDTHS ARE 12' UNLESS OTHERWISE SHOWN.

11/7/2017
I:\PMP\ustr\U2525C_PMP_15.dgn
HNTB

HNTB
 HNTB NORTH CAROLINA, P.C.
 343 E. Six Forks Road, Suite 200
 Raleigh, North Carolina 27609
 NC License No: C-1554
 (919) 546-8997

PAVEMENT MARKING DETAIL

TIP NO. U-2525C	SHEET NO. PMP-16
APPROVED: <i>Andrew D. Klincksiek</i> E3078FB49E44B	
DATE: 12/11/2017	
	
DOCUMENT NOT CONSIDERED FINAL UNLESS ALL SIGNATURES COMPLETED	

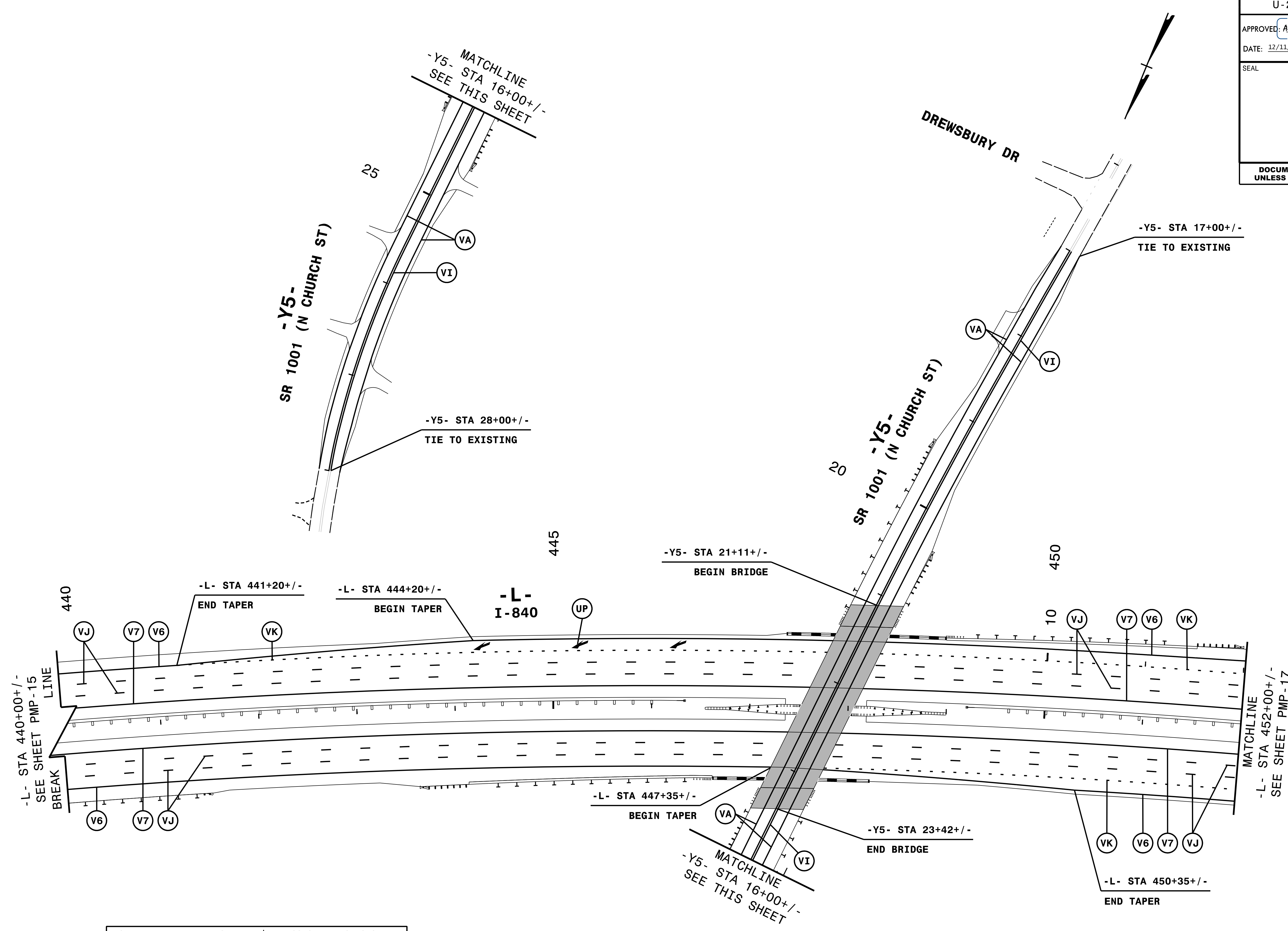

NOTE: ALL LANE WIDTHS ARE 12' UNLESS OTHERWISE SHOWN.

11/7/2017
I:\PMP\ustr\U2525C_PMP_16.dgn
HNTB

HNTB
 HNTB NORTH CAROLINA, P.C.
 343 E. Six Forks Road, Suite 200
 Raleigh, North Carolina 27609
 NC License No: C-1554
 (919) 546-8997

PAVEMENT MARKING DETAIL

TIP NO. U-2525C	SHEET NO. PMP-17
APPROVED: <i>Andrew D. Klincksiek</i> <small>E3078FB49E44B</small>	
DATE: 12/11/2017	
	
DOCUMENT NOT CONSIDERED FINAL UNLESS ALL SIGNATURES COMPLETED	

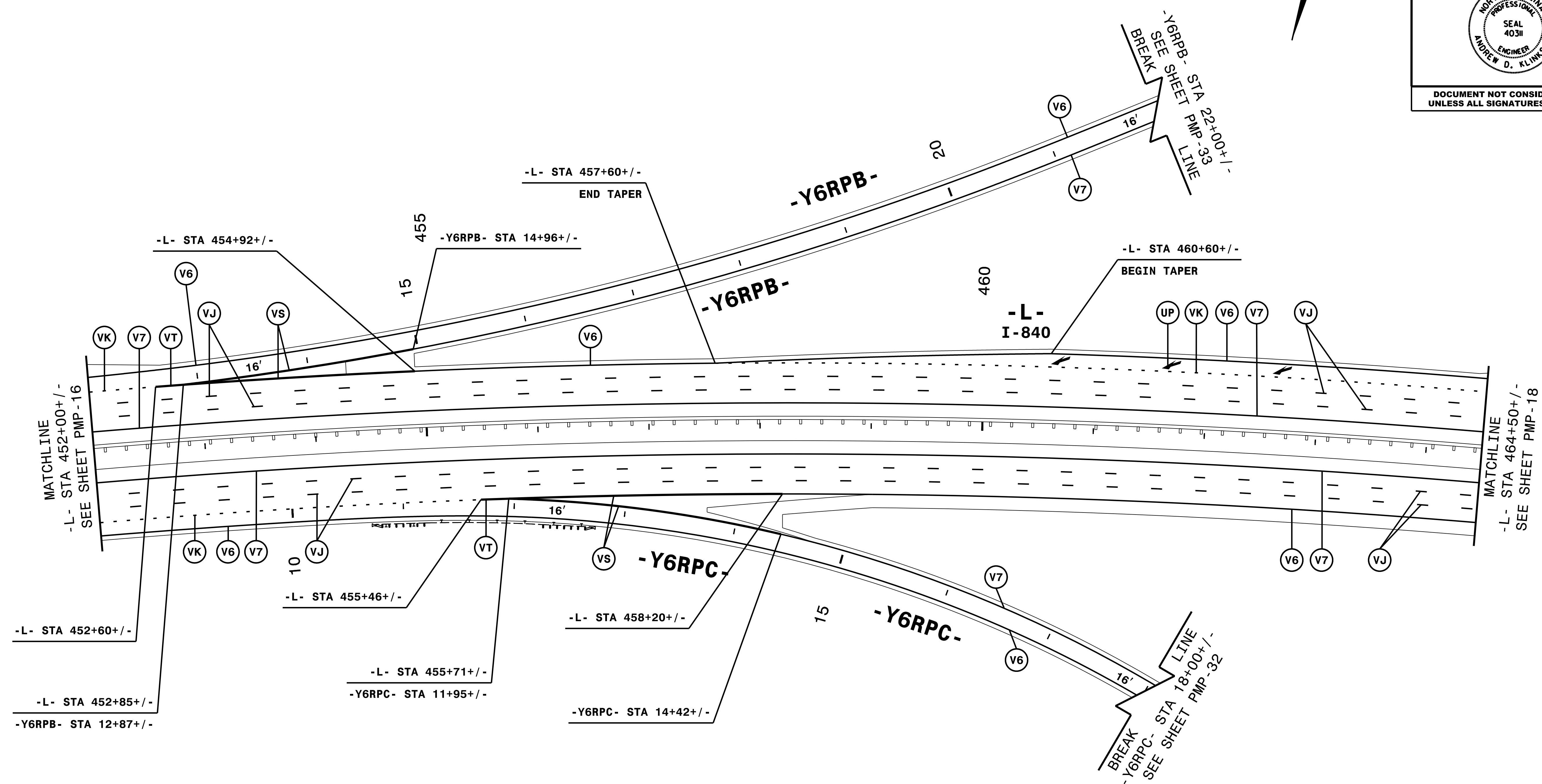

NOTE: ALL LANE WIDTHS ARE 12' UNLESS OTHERWISE SHOWN.

11/7/2017
I:\PMP\ustr\U2525C_PMP_17.dgn
HNTB

HNTB
HNTB NORTH CAROLINA, P.C.
 343 E. Six Forks Road, Suite 200
 Raleigh, North Carolina 27609
 NC License No: C-1554
 (919) 546-8997

PAVEMENT MARKING DETAIL

TIP NO. U-2525C	SHEET NO. PMP-18
APPROVED: <i>Andrew D. Klincksiek</i> E3078F8459E44B	
DATE: 12/11/2017	
	
DOCUMENT NOT CONSIDERED FINAL UNLESS ALL SIGNATURES COMPLETED	

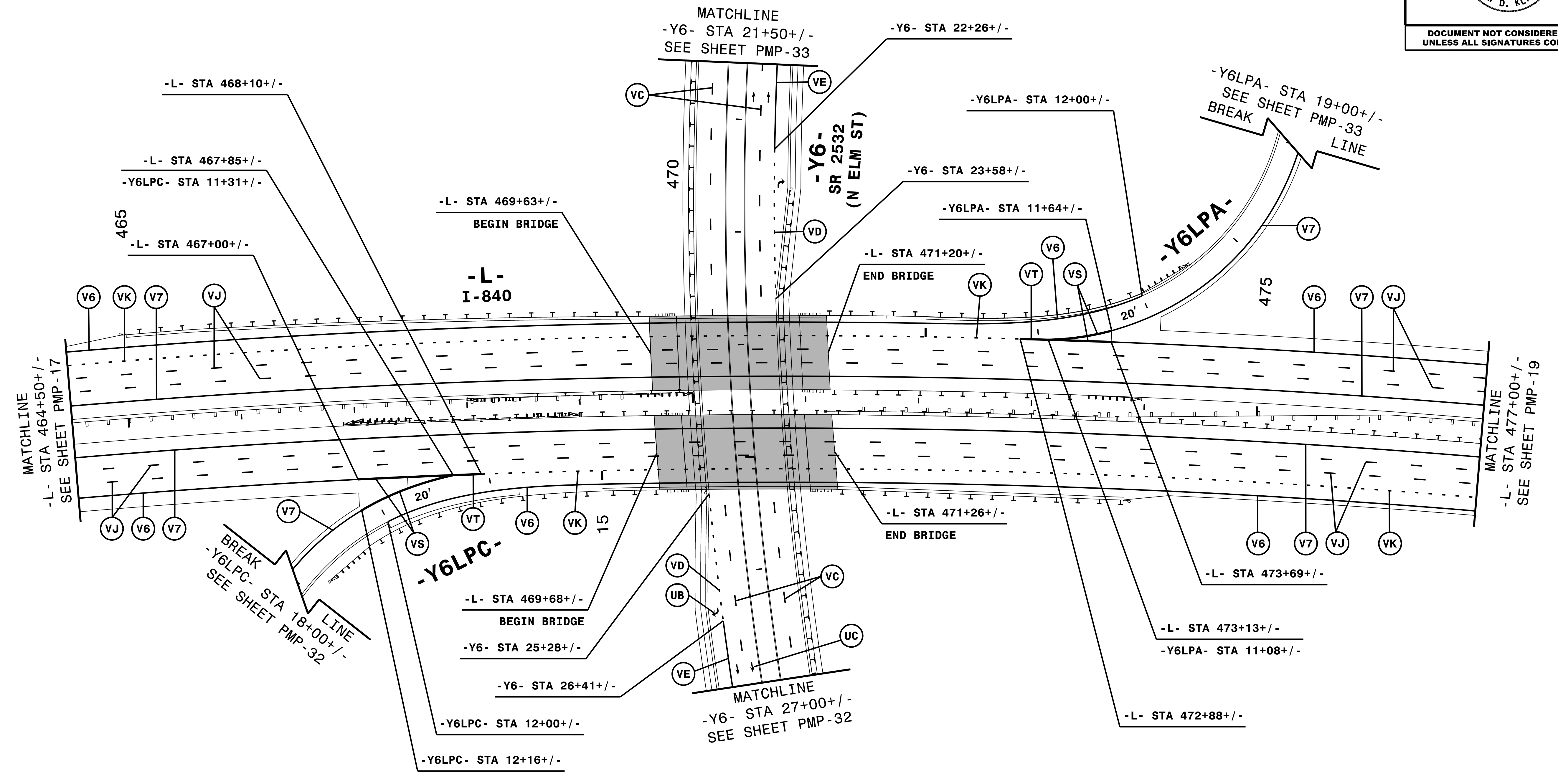

NOTE: ALL LANE WIDTHS ARE 12' UNLESS OTHERWISE SHOWN.

11/7/2017 10:16 AM P:\ustr\U2525C_PMP_18.dgn HNTB

HNTB
 HNTB NORTH CAROLINA, P.C.
 343 E. SIX FORKS ROAD, SUITE 200
 RALEIGH, NORTH CAROLINA 27609
 NC LICENSE NO: C-1554
 (919) 546-8997

PAVEMENT MARKING DETAIL

TIP NO. U-2525C	SHEET NO. PMP-19
APPROVED: <i>Andrew D. Klincksiek</i> <small>E3078FB498E44B</small>	
DATE: 12/11/2017	
	
DOCUMENT NOT CONSIDERED FINAL UNLESS ALL SIGNATURES COMPLETED	

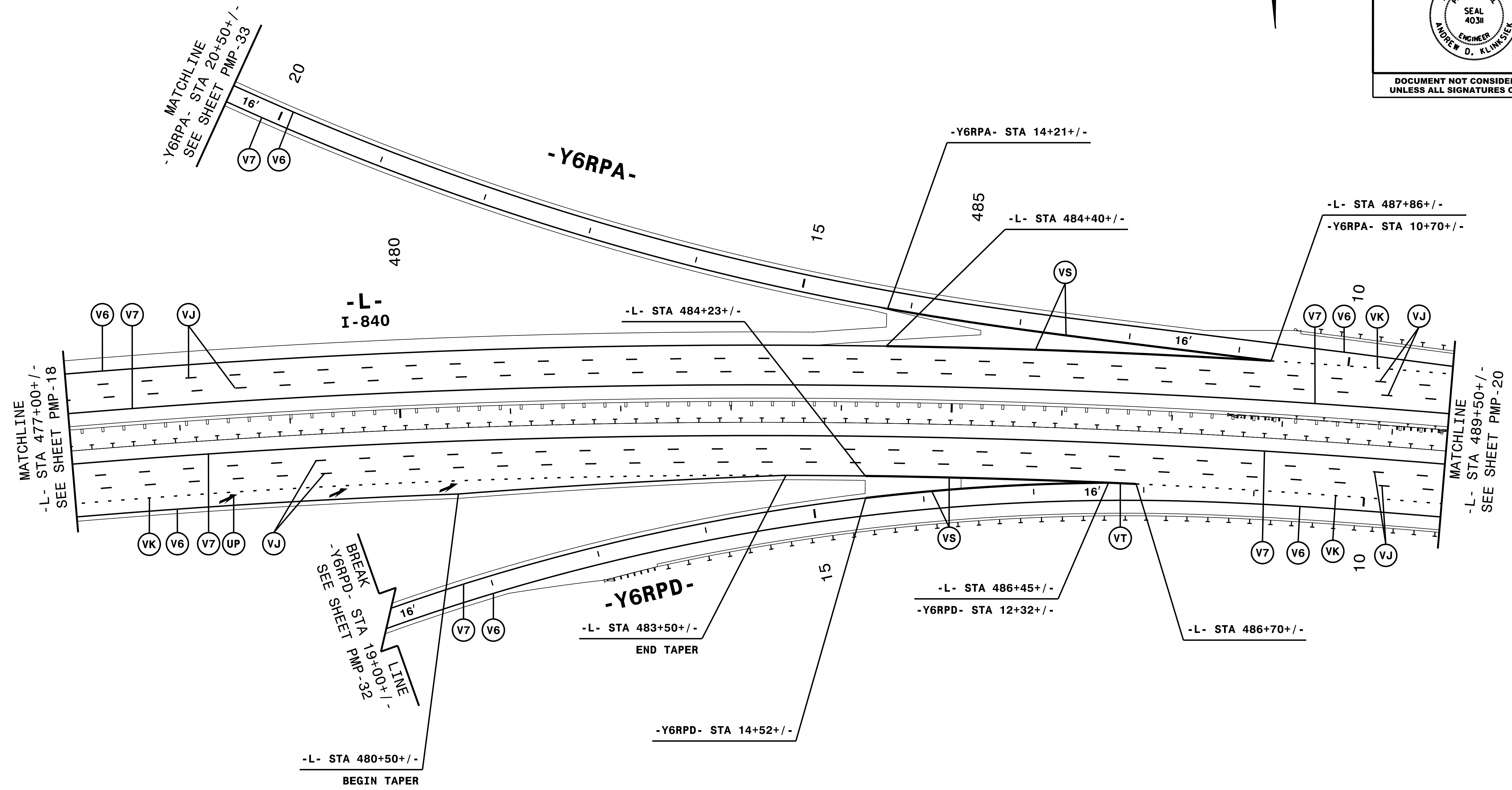

NOTE: ALL LANE WIDTHS ARE 12' UNLESS OTHERWISE SHOWN.

IV/7/2017
I:\PMP\ustrn\U2525C_PMP_19.dgn
HNTB

HNTB HNTB NORTH CAROLINA, P.C.
343 E. Six Forks Road, Suite 200
Raleigh, North Carolina 27609
NC License No: C-1554
(919) 546-8997

PAVEMENT MARKING DETAIL

TIP NO. U-2525C	SHEET NO. PMP-20
APPROVED: <i>Andrew D. Klinck</i> <small>E3078FB49E44B</small>	
DATE: 12/11/2017	
	
DOCUMENT NOT CONSIDERED FINAL UNLESS ALL SIGNATURES COMPLETED	

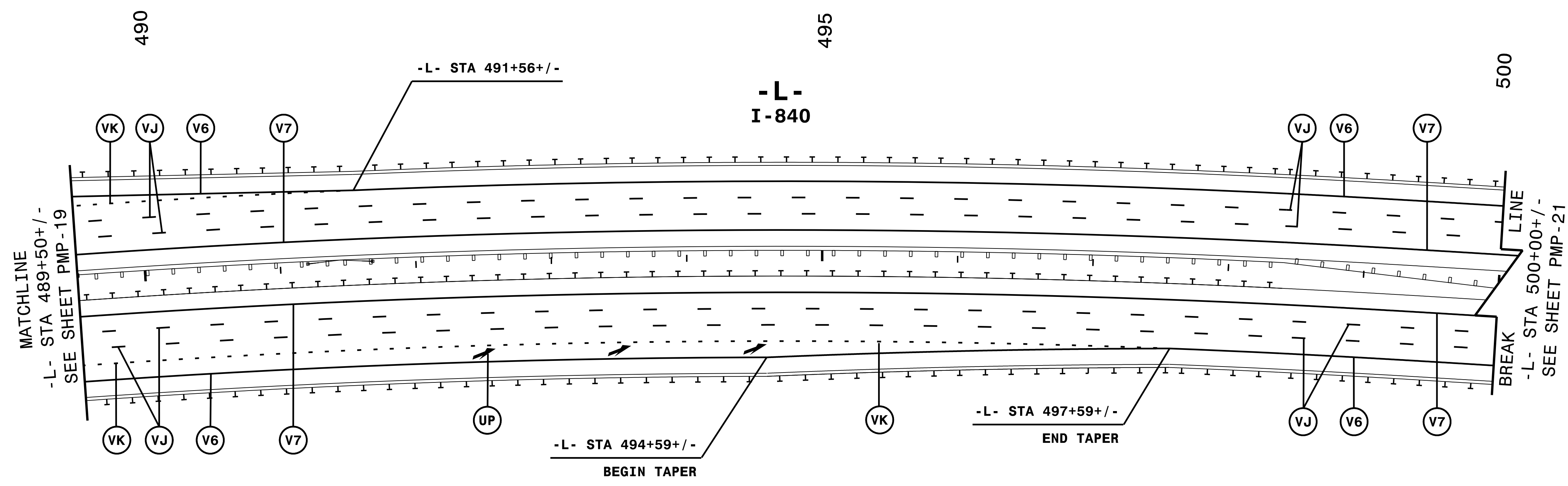

NOTE: ALL LANE WIDTHS ARE 12' UNLESS OTHERWISE SHOWN.

IV/7/2017
I:\PMP\ustrn\U2525C_PMP_20.dgn
HNTB

HNTB HNTB NORTH CAROLINA, P.C.
343 E. Six Forks Road, Suite 200
Raleigh, North Carolina 27609
NC License No: C-1554
(919) 546-8997

PAVEMENT MARKING DETAIL

TIP NO. U-2525C	SHEET NO. PMP-21
APPROVED: <i>Andrew D. Klincksiek</i> <small>E3078F849E44B</small>	
DATE: 12/11/2017	
SEAL	
	
DOCUMENT NOT CONSIDERED FINAL UNLESS ALL SIGNATURES COMPLETED	

END TIP PROJECT U-2525C
 -L- STA. 552+99.67 LB
 N-871505.0126 E-1756411.6682
 END TIP PROJECT U-2524D
 -L- STA. 520+34.53 LB
 N-871507.2766 E-1756411.5108

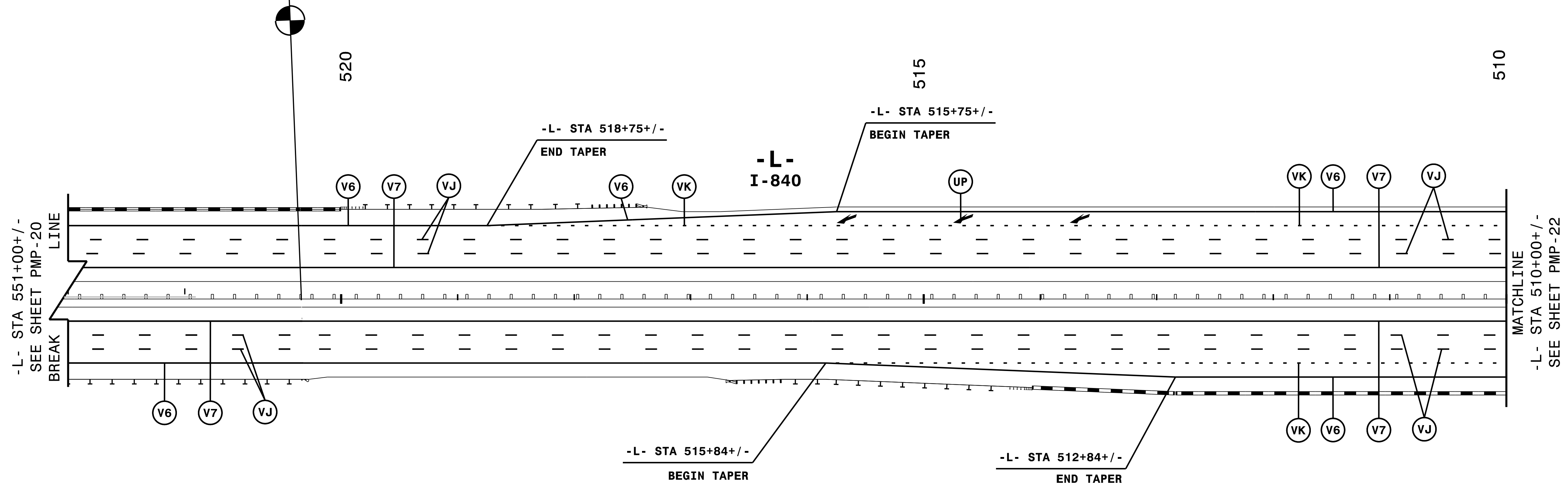

NOTE: ALL LANE WIDTHS ARE 12' UNLESS OTHERWISE SHOWN.

11/7/2017
 IV\FMP\ustr\U2525C_PMP_21.dgn
 HNTB

HNTB
 HNTB NORTH CAROLINA, P.C.
 343 E. SIX FORKS ROAD, SUITE 200
 RALEIGH, NORTH CAROLINA 27609
 NC LICENSE NO: C-1554
 (919) 546-8997

PAVEMENT MARKING DETAIL

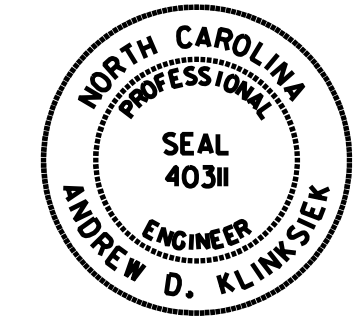
TIP NO. U-2525C	SHEET NO. PMP-22
APPROVED: <i>Andrew D. Klincksiek</i> <small>E3078F849E44B</small>	
DATE: 12/11/2017	
	
DOCUMENT NOT CONSIDERED FINAL UNLESS ALL SIGNATURES COMPLETED	

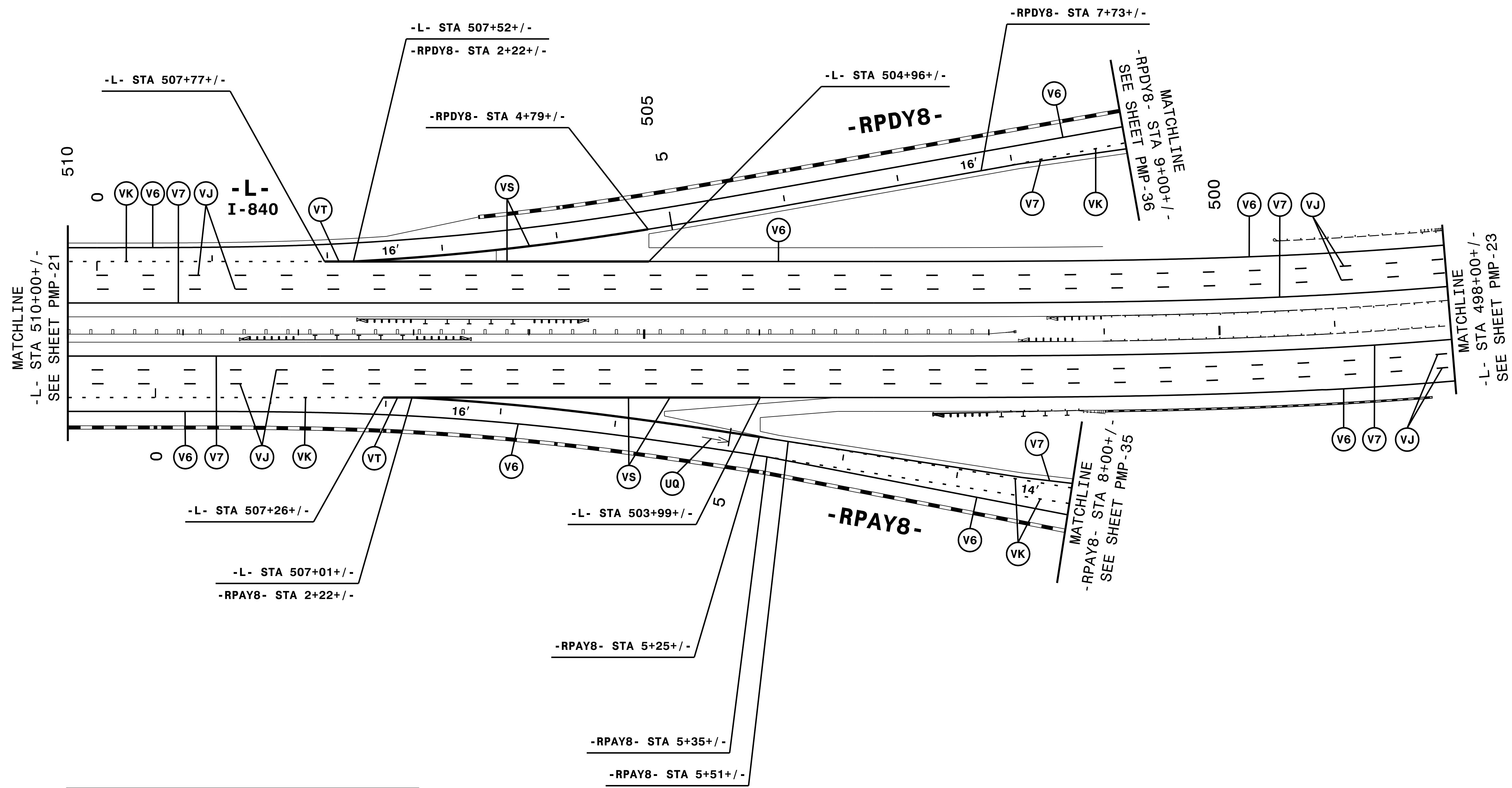

NOTE: ALL LANE WIDTHS ARE 12' UNLESS OTHERWISE SHOWN.

11/7/2017
I:\PMP\ustr\U2525C_PMP_22.dgn
HNTB

HNTB
 HNTB NORTH CAROLINA, P.C.
 343 E. Six Forks Road, Suite 200
 Raleigh, North Carolina 27609
 NC License No: C-1554
 (919) 546-8997

PAVEMENT MARKING DETAIL

TIP NO. U-2525C	SHEET NO. PMP-24
APPROVED: <i>Andrew D. Klinck</i> <small>E3078F849E44B</small>	
DATE: 12/11/2017	
	
DOCUMENT NOT CONSIDERED FINAL UNLESS ALL SIGNATURES COMPLETED	

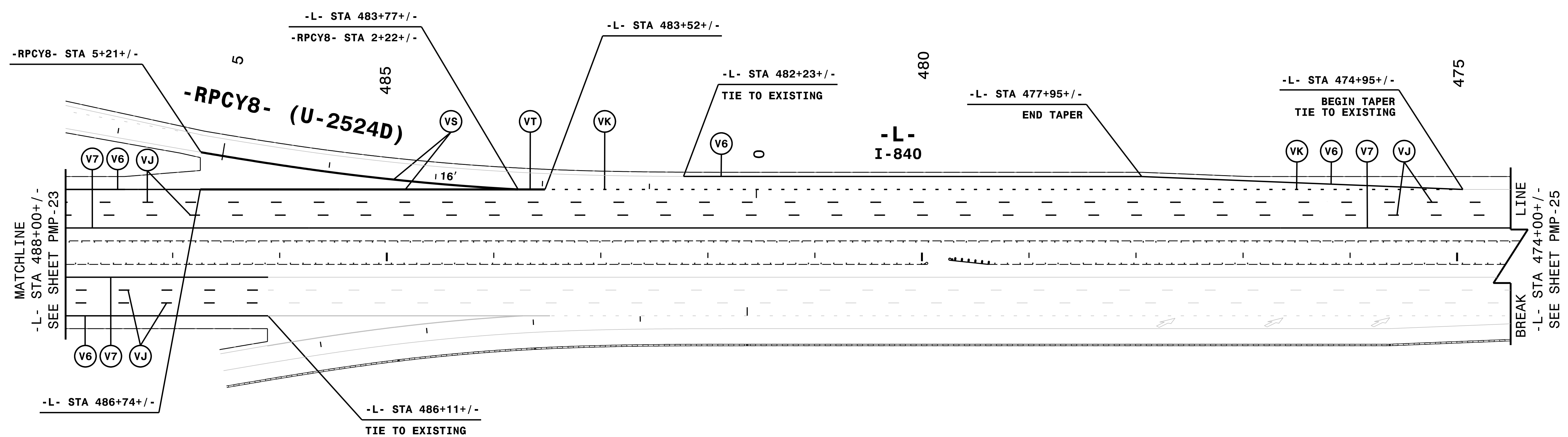

NOTE: ALL LANE WIDTHS ARE 12' UNLESS OTHERWISE SHOWN.
 REMOVE CONFLICTING PAVEMENT MARKING.

IV/7/2017
 I:\PMP\ustrn\U2525C_PMP_24.dgn
 HNTB

HNTB
 HNTB NORTH CAROLINA, P.C.
 343 E. Six Forks Road, Suite 200
 Raleigh, North Carolina 27609
 NC License No: C-1554
 (919) 546-8997

PAVEMENT MARKING DETAIL

TIP NO. U-2525C	SHEET NO. PMP-25
Approved by: <i>Andrew D. Klinck</i> <small>E3078F8498E44B</small> DATE: 12/11/2017	
	
DOCUMENT NOT CONSIDERED FINAL UNLESS ALL SIGNATURES COMPLETED	

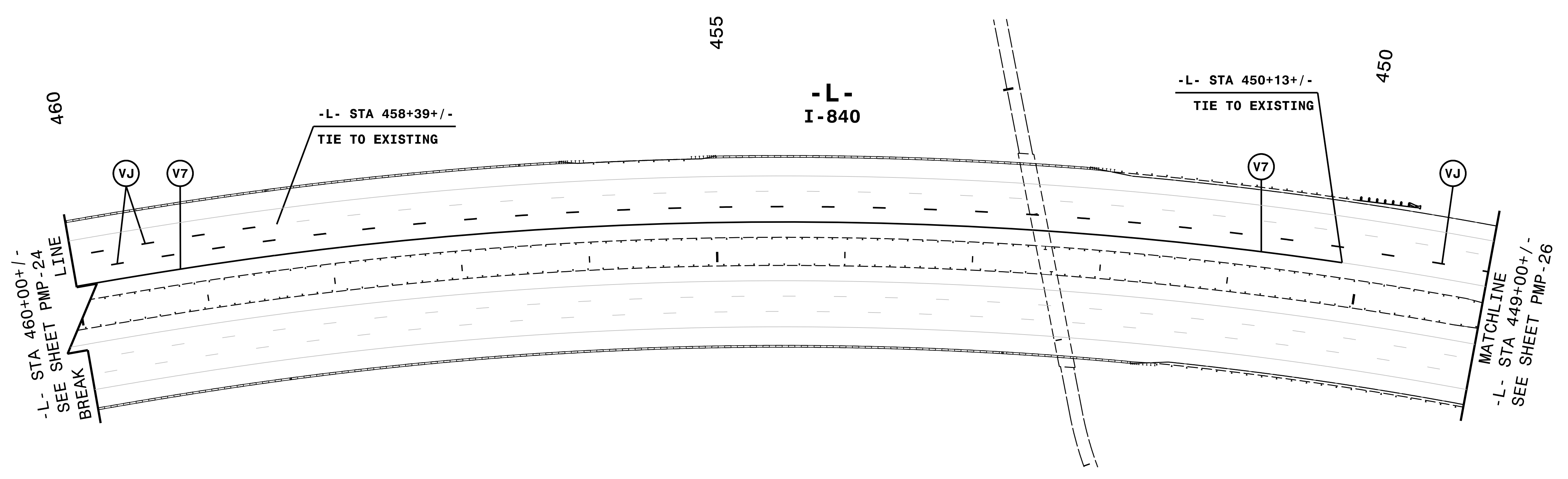

NOTE: ALL LANE WIDTHS ARE 12' UNLESS OTHERWISE SHOWN.
 REMOVE CONFLICTING PAVEMENT MARKING.

IV/7/2017
 I:\PMP\ustrn\U2525C_PMP_25.dgn
 HNTB

HNTB
 HNTB NORTH CAROLINA, P.C.
 343 E. SIX FORKS ROAD, SUITE 200
 RALEIGH, NORTH CAROLINA 27609
 NC LICENSE NO: C-1554
 (919) 546-8997

PAVEMENT MARKING DETAIL

TIP NO. U-2525C	SHEET NO. PMP-26
APPROVED: <i>Andrew D. Klinck</i> <small>E3078FB49E44B</small>	
DATE: 12/11/2017	
SEAL 	
DOCUMENT NOT CONSIDERED FINAL UNLESS ALL SIGNATURES COMPLETED	

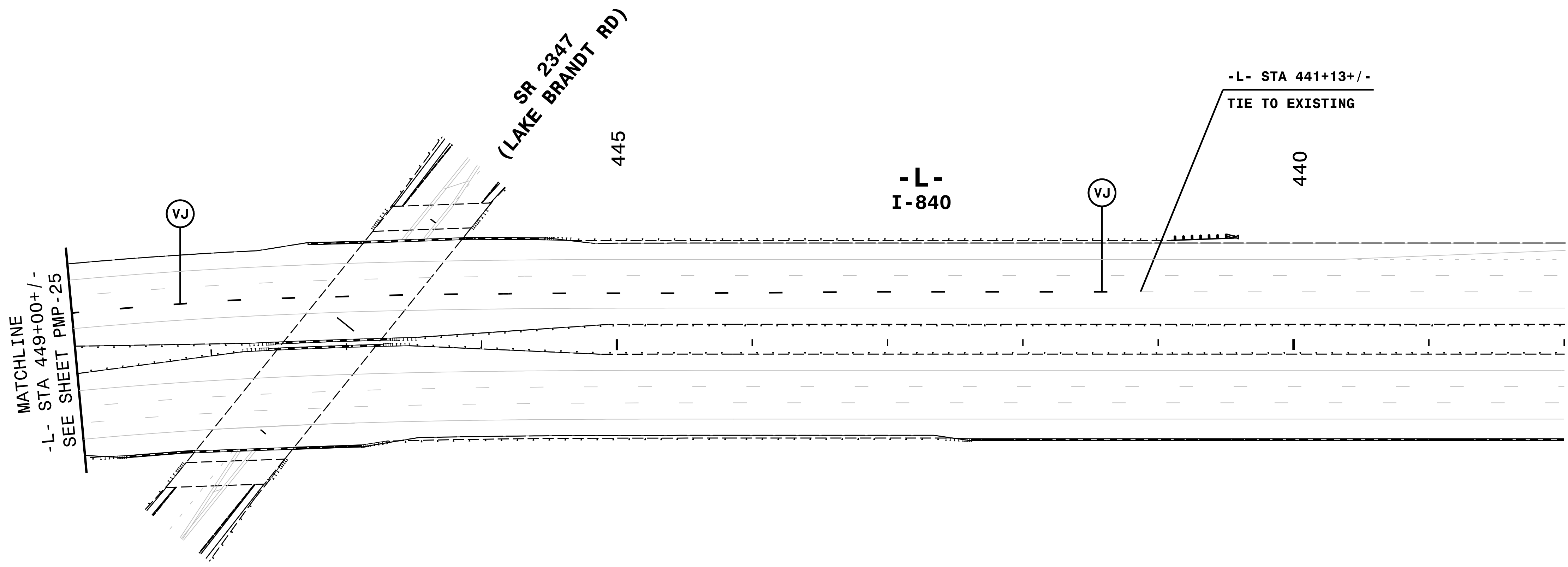
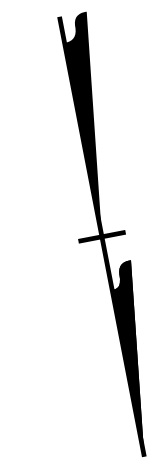

NOTE: ALL LANE WIDTHS ARE 12' UNLESS OTHERWISE SHOWN.

REMOVE CONFLICTING PAVEMENT MARKING.

11/7/2017
I:\PMP\ustr\U2525C_PMP_26.dgn
HNTB

HNTB HNTB NORTH CAROLINA, P.C.
343 E. SIX FORKS ROAD, SUITE 200
RALEIGH, NORTH CAROLINA 27609
NC LICENSE NO: C-1554
(919) 546-8997

PAVEMENT MARKING DETAIL

TIP NO. U-2525C	SHEET NO. PMP-27
APPROVED: <i>Andrew D. Klincksiek</i> <small>E3078FB459E44B</small>	
DATE: 12/11/2017	
SEAL	
	
DOCUMENT NOT CONSIDERED FINAL UNLESS ALL SIGNATURES COMPLETED	

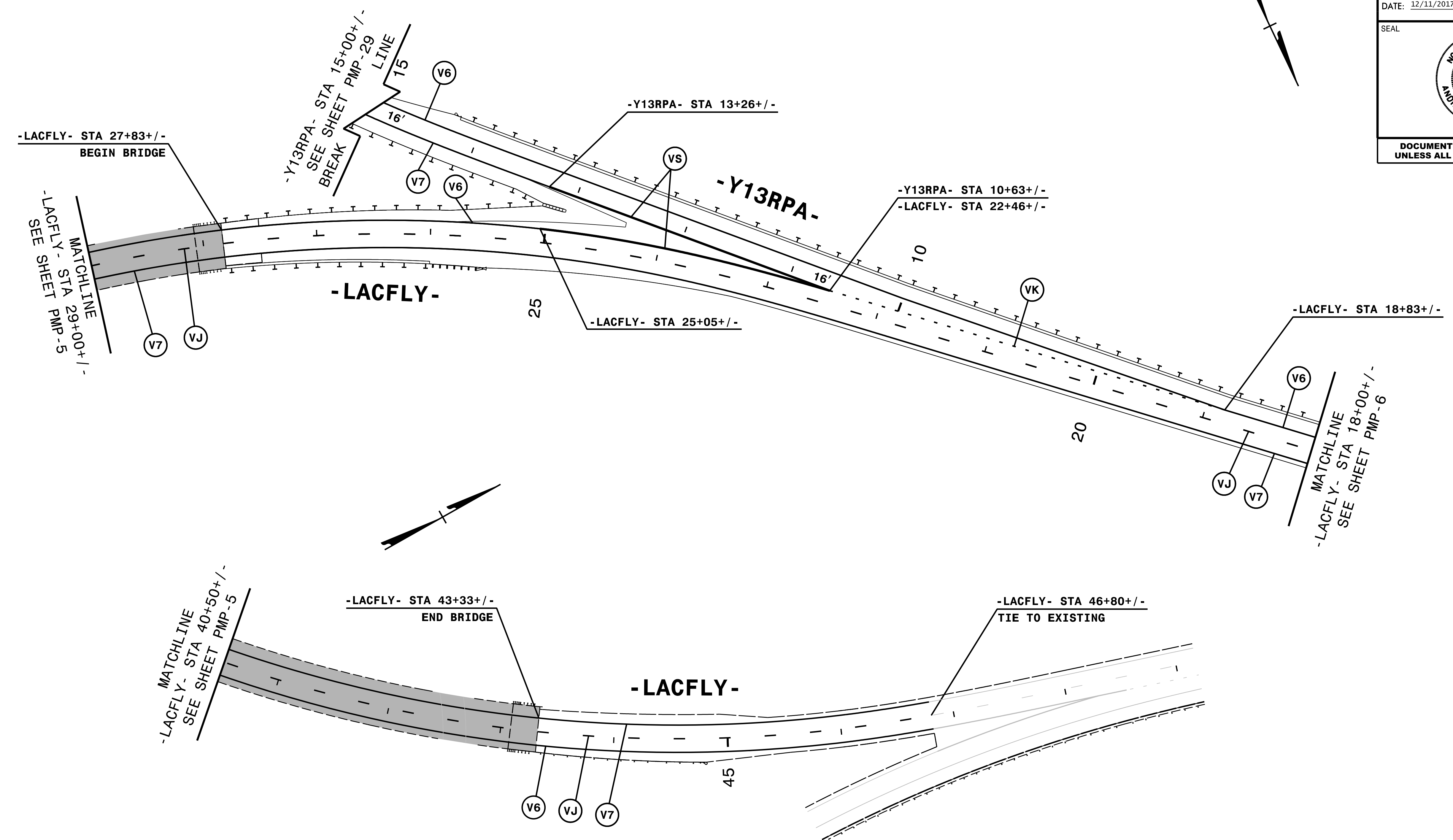

NOTE: ALL LANE WIDTHS ARE 12' UNLESS OTHERWISE SHOWN.

11/7/2017
I:\PMP\ustrn\U2525C_PMP_27.dgn
HNTB

HNTB
 HNTB NORTH CAROLINA, P.C.
 343 E. Six Forks Road, Suite 200
 Raleigh, North Carolina 27609
 NC License No: C-1554
 (919) 546-8997

PAVEMENT MARKING DETAIL

TIP NO. U-2525C	SHEET NO. PMP-28
APPROVED: <i>Andrew D. Klincksiek</i> <small>E3078FB498E44B</small>	
DATE: 12/11/2017	
	
DOCUMENT NOT CONSIDERED FINAL UNLESS ALL SIGNATURES COMPLETED	

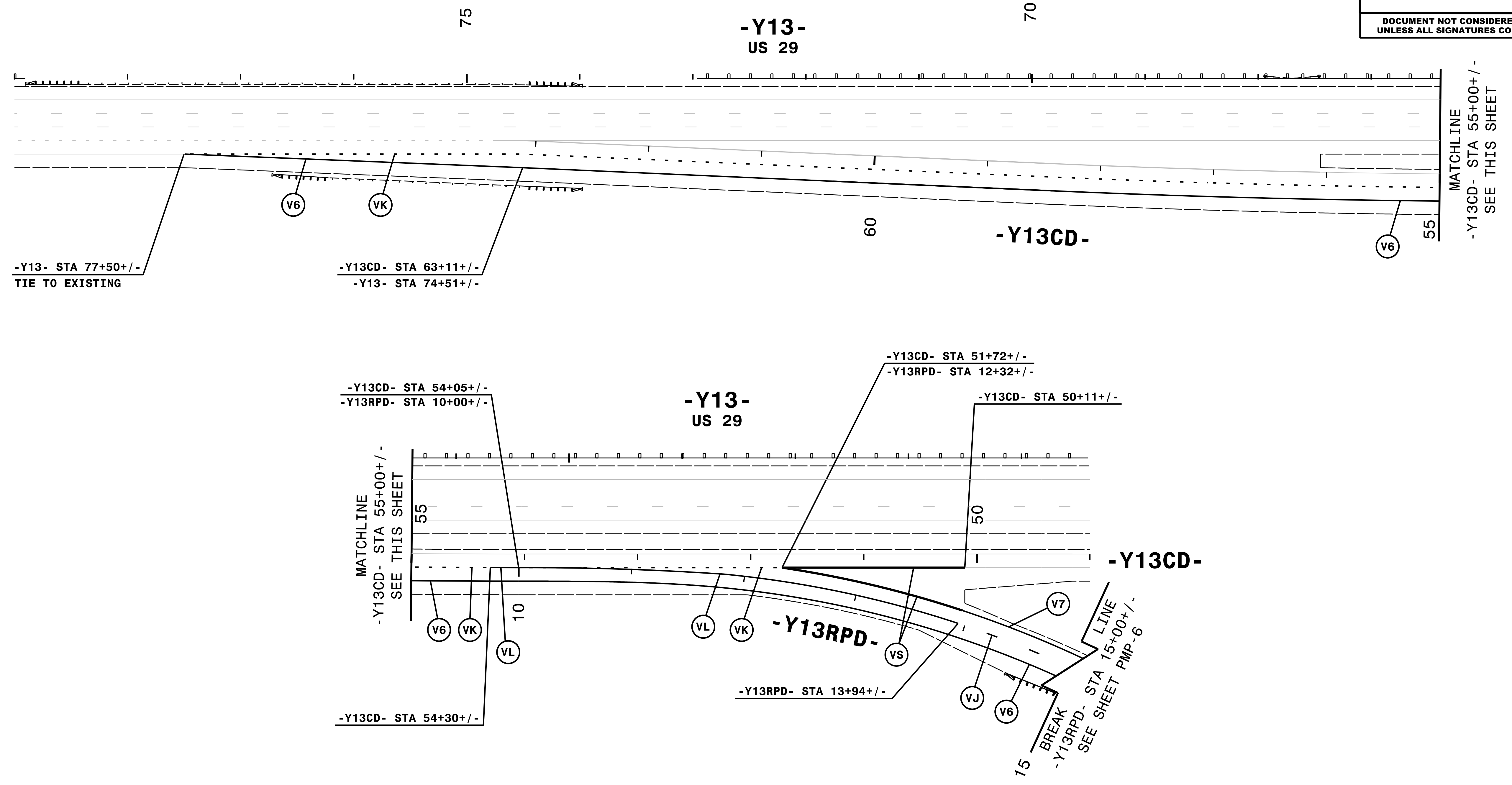
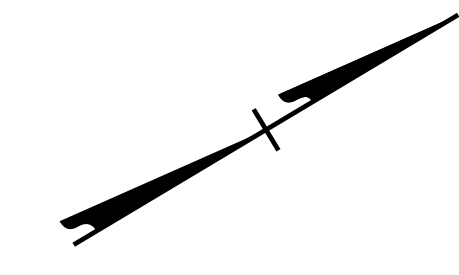

NOTE: ALL LANE WIDTHS ARE 12' UNLESS OTHERWISE SHOWN.

REMOVE CONFLICTING PAVEMENT MARKING.

11/7/2017
I:\PMP\ustr\U2525C_PMP_28.dgn
HNTB

HNTB

HNTB NORTH CAROLINA, P.C.
343 E. Six Forks Road, Suite 200
Raleigh, North Carolina 27609
NC License No: C-1554
(919) 546-8997

PAVEMENT MARKING DETAIL

TIP NO. U-2525C	SHEET NO. PMP-29
APPROVED: <i>Andrew D. Klincksiek</i> <small>E3078FB498E44B</small>	
DATE: 12/11/2017	
	
DOCUMENT NOT CONSIDERED FINAL UNLESS ALL SIGNATURES COMPLETED	

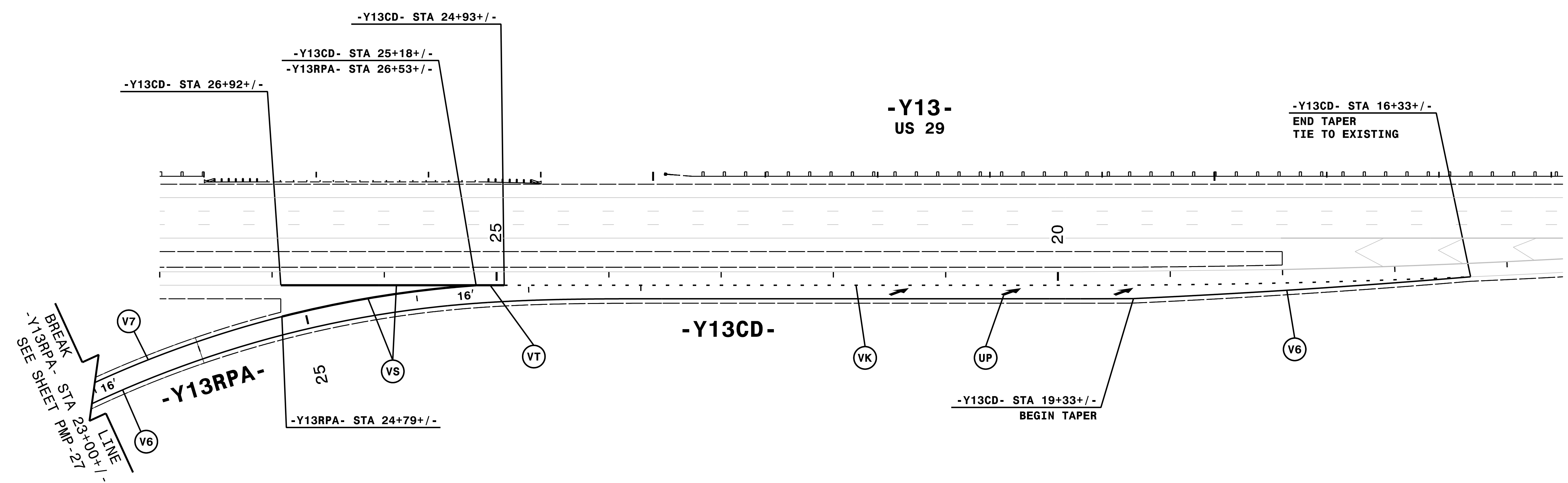
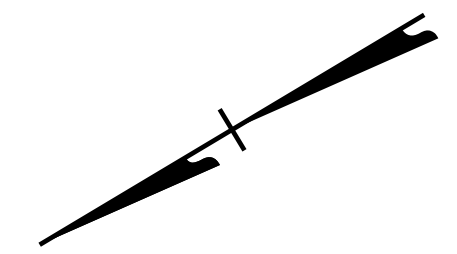

NOTE: ALL LANE WIDTHS ARE 12' UNLESS OTHERWISE SHOWN.
REMOVE CONFLICTING PAVEMENT MARKING.

IV/7/2017
I:\PMP\ustrn\U2525C_PMP_29.dgn
HNTB

HNTB
 HNTB NORTH CAROLINA, P.C.
 343 E. Six Forks Road, Suite 200
 Raleigh, North Carolina 27609
 NC License No: C-1554
 (919) 546-8997

PAVEMENT MARKING DETAIL

TIP NO. U-2525C	SHEET NO. PMP-32
APPROVED: <i>Andrew D. Klink</i> E3078FB4596E44B	
DATE: 12/14/2017	
SEAL 	
DOCUMENT NOT CONSIDERED FINAL UNLESS ALL SIGNATURES COMPLETED	

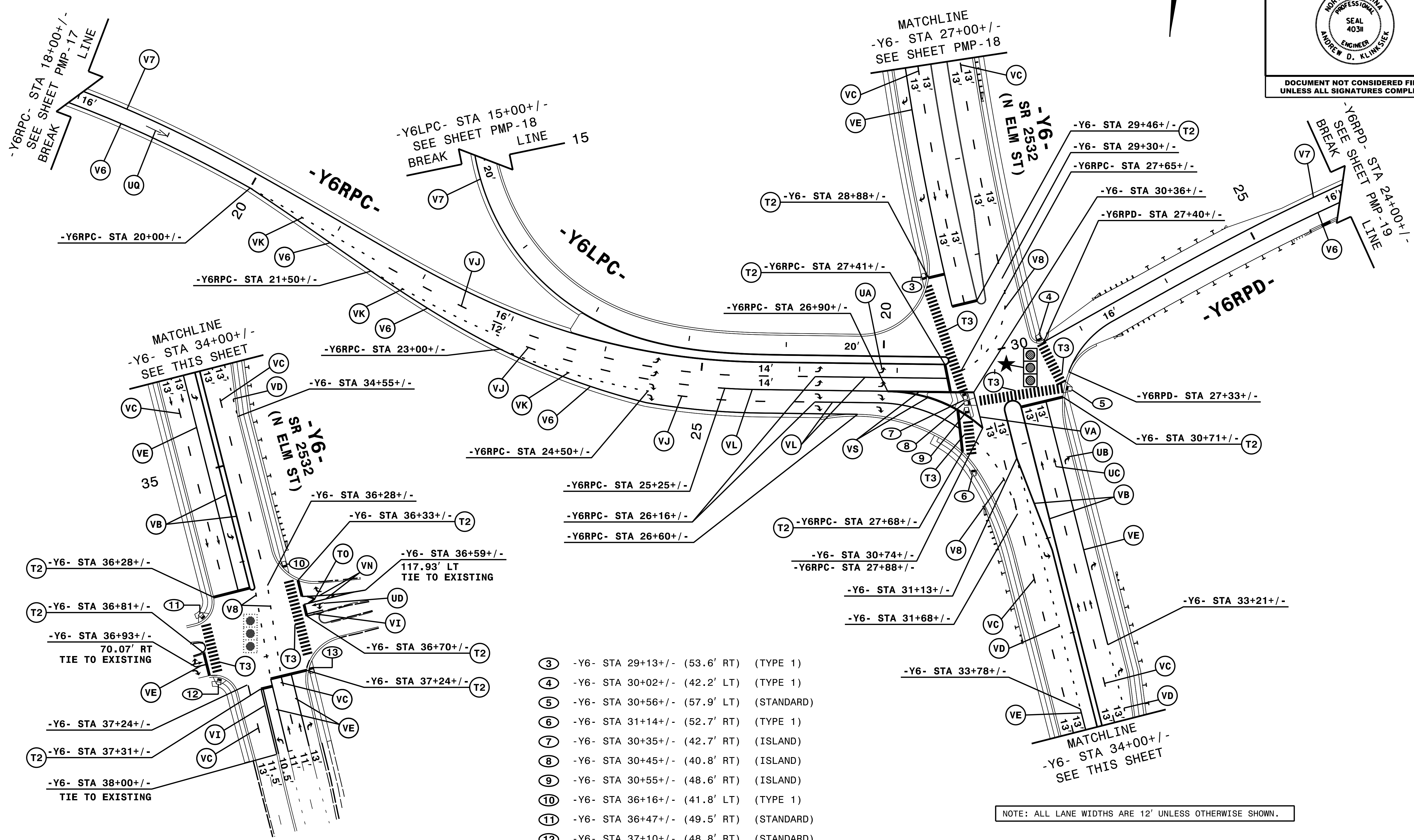

- ③ -Y6- STA 29+13+/- (53.6' RT) (TYPE 1)
- ④ -Y6- STA 30+02+/- (42.2' LT) (TYPE 1)
- ⑤ -Y6- STA 30+56+/- (57.9' LT) (STANDARD)
- ⑥ -Y6- STA 31+14+/- (52.7' RT) (TYPE 1)
- ⑦ -Y6- STA 30+35+/- (42.7' RT) (ISLAND)
- ⑧ -Y6- STA 30+45+/- (40.8' RT) (ISLAND)
- ⑨ -Y6- STA 30+55+/- (48.6' RT) (ISLAND)
- ⑩ -Y6- STA 36+16+/- (41.8' LT) (TYPE 1)
- ⑪ -Y6- STA 36+47+/- (49.5' RT) (STANDARD)
- ⑫ -Y6- STA 37+10+/- (48.8' RT) (STANDARD)
- ⑬ -Y6- STA 37+22+/- (42.3' LT) (TYPE 1)

NOTE: ALL LANE WIDTHS ARE 12' UNLESS OTHERWISE SHOWN.

12/14/2017
Y:\PMP\Ustr\U2525C_PMP_32.dgn
HNTB

HNTB
HNTB NORTH CAROLINA, P.C.
343 E. SIX FORKS ROAD, SUITE 200
RALEIGH, NORTH CAROLINA 27609
NC LICENSE NO: C-1554
(919) 546-8997

PAVEMENT MARKING DETAIL

TIP NO. U-2525C	SHEET NO. PMP-33
APPROVED: <i>Andrew D. Klincksiek</i> E3078FB4598E44B	
DATE: 12/14/2017	
	
DOCUMENT NOT CONSIDERED FINAL UNLESS ALL SIGNATURES COMPLETED	

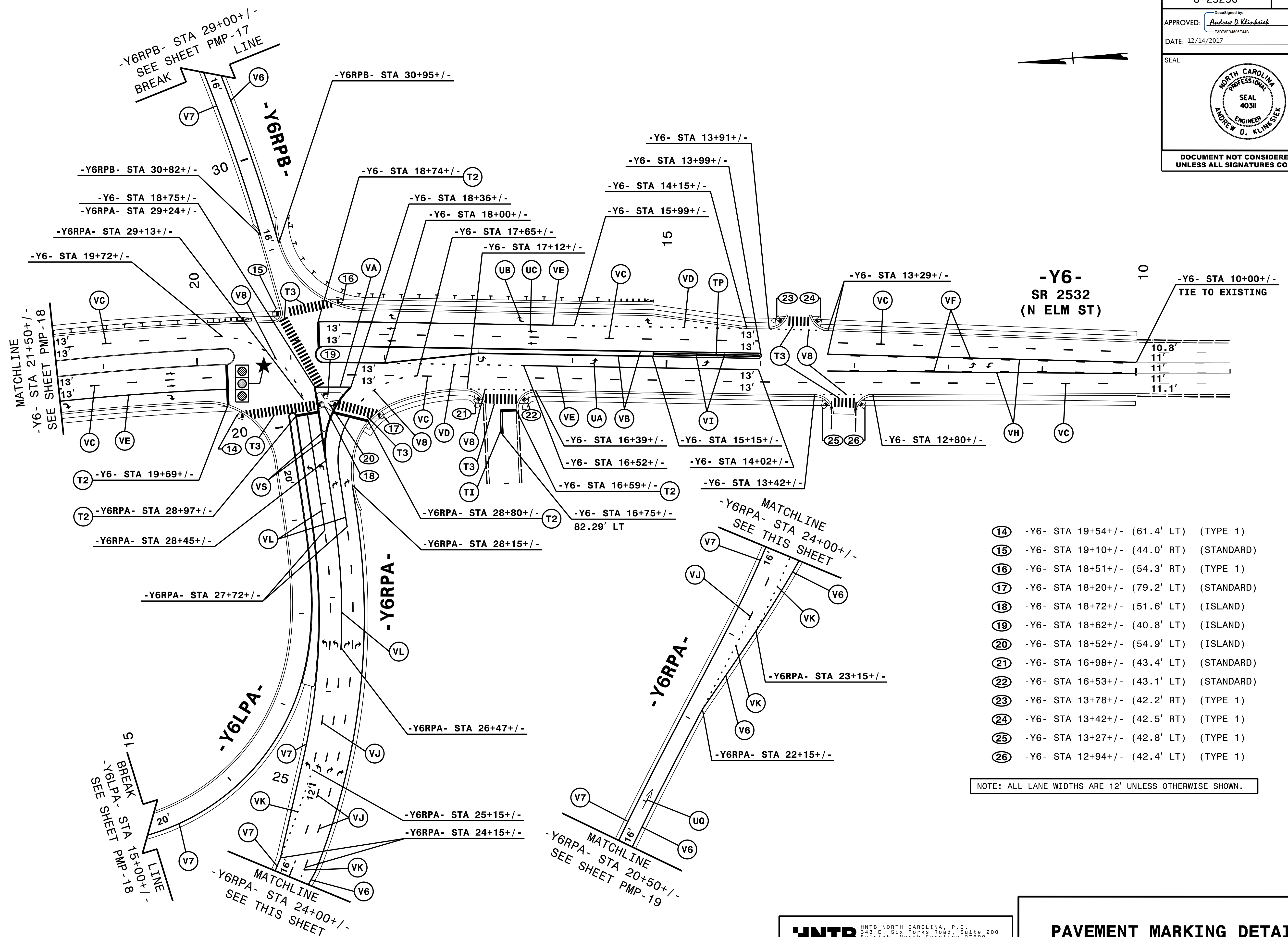

- 14 -Y6- STA 19+54+/- (61.4' LT) (TYPE 1)
- 15 -Y6- STA 19+10+/- (44.0' RT) (STANDARD)
- 16 -Y6- STA 18+51+/- (54.3' RT) (TYPE 1)
- 17 -Y6- STA 18+20+/- (79.2' LT) (STANDARD)
- 18 -Y6- STA 18+72+/- (51.6' LT) (ISLAND)
- 19 -Y6- STA 18+62+/- (40.8' LT) (ISLAND)
- 20 -Y6- STA 18+52+/- (54.9' LT) (ISLAND)
- 21 -Y6- STA 16+98+/- (43.4' LT) (STANDARD)
- 22 -Y6- STA 16+53+/- (43.1' LT) (STANDARD)
- 23 -Y6- STA 13+78+/- (42.2' RT) (TYPE 1)
- 24 -Y6- STA 13+42+/- (42.5' RT) (TYPE 1)
- 25 -Y6- STA 13+27+/- (42.8' LT) (TYPE 1)
- 26 -Y6- STA 12+94+/- (42.4' LT) (TYPE 1)

NOTE: ALL LANE WIDTHS ARE 12' UNLESS OTHERWISE SHOWN.

12/14/2017
PMP\Ustrn\U2525C_PMP_33.dgn
HNTB

HNTB
 HNTB NORTH CAROLINA, P.C.
 343 E. Six Forks Road, Suite 200
 Raleigh, North Carolina 27609
 NC License No: C-1554
 (919) 546-8997

PAVEMENT MARKING DETAIL

TIP NO. U-2525C	SHEET NO. PMP-34
APPROVED: <i>Andrew D. Klincksiek</i> <small>E3078FB498E44B</small>	
DATE: 12/11/2017	
	
DOCUMENT NOT CONSIDERED FINAL UNLESS ALL SIGNATURES COMPLETED	

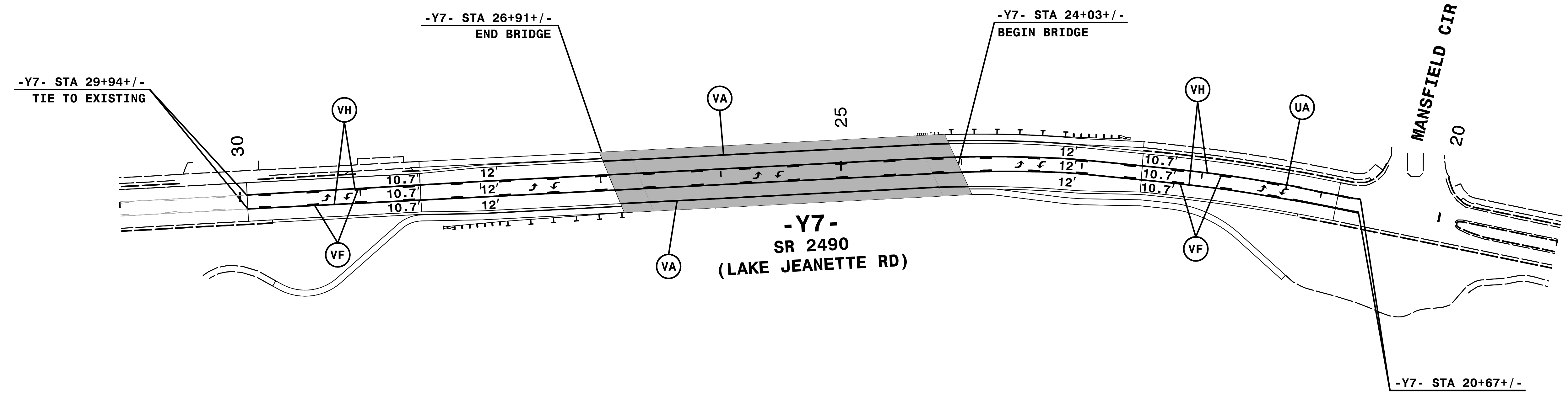
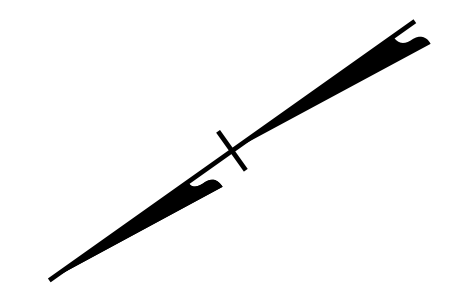

NOTE: ALL LANE WIDTHS ARE 12' UNLESS OTHERWISE SHOWN.

11/7/2017
I:\PMP\ustr\U2525C_PMP_34.dgn
HNTB

HNTB
 HNTB NORTH CAROLINA, P.C.
 343 E. Six Forks Road, Suite 200
 Raleigh, North Carolina 27609
 NC License No: C-1554
 (919) 546-8997

PAVEMENT MARKING DETAIL

TIP NO. U-2525C	SHEET NO. PMP-35
APPROVED: <i>Andrew D. Klincksiek</i> <small>E3078F849E44B</small>	
DATE: 12/11/2017	
SEAL 	
DOCUMENT NOT CONSIDERED FINAL UNLESS ALL SIGNATURES COMPLETED	

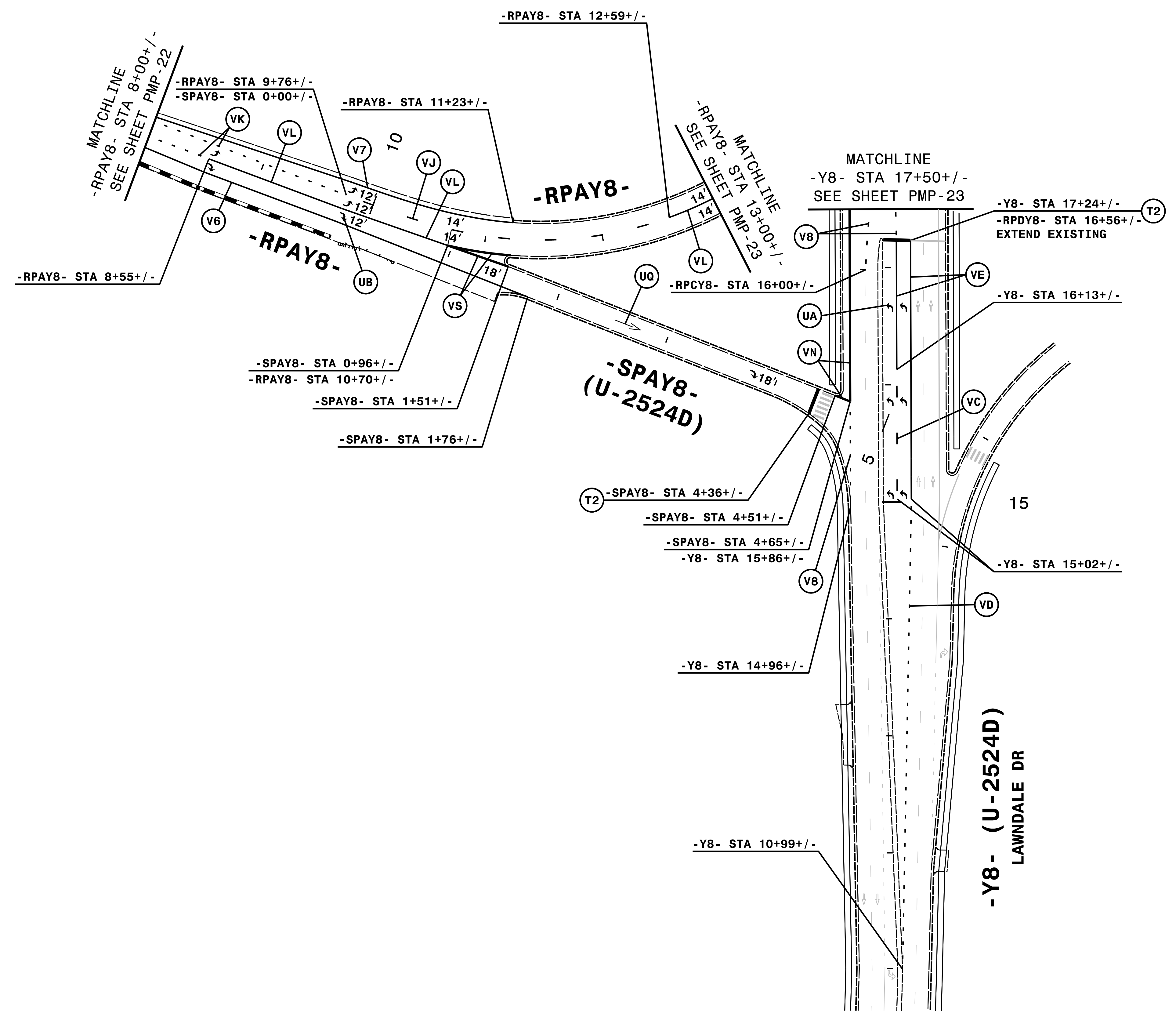

NOTE: ALL LANE WIDTHS ARE 12' UNLESS OTHERWISE SHOWN.

REMOVE CONFLICTING PAVEMENT MARKING.

11/7/2017
I:\PMP\ustr\U2525C_PMP_35.dgn
HNTB

HNTB
HNTB NORTH CAROLINA, P.C.
 343 E. Six Forks Road, Suite 200
 Raleigh, North Carolina 27609
 NC License No: C-1554
 (919) 546-8997

PAVEMENT MARKING DETAIL

