

STATE OF NORTH CAROLINA
DEPARTMENT OF TRANSPORTATION
RALEIGH, N.C.

PROPOSAL

INCLUDES ADDENDUM No. 1 DATED 10-03-2017

DATE AND TIME OF BID OPENING: **OCTOBER 17, 2017 AT 2:00 PM**

CONTRACT ID C203976
WBS 46077.3.1

FEDERAL-AID NO. STATE FUNDED
COUNTY MONTGOMERY, MOORE
T.I.P. NO. B-5362
MILES 0.082
ROUTE NO. NC 73
LOCATION BRIDGE #53 OVER DROWNING CREEK ON NC-73.

TYPE OF WORK GRADING, DRAINAGE, PAVING, AND STRUCTURE.

NOTICE:

ALL BIDDERS SHALL COMPLY WITH ALL APPLICABLE LAWS REGULATING THE PRACTICE OF GENERAL CONTRACTING AS CONTAINED IN CHAPTER 87 OF THE GENERAL STATUTES OF NORTH CAROLINA WHICH REQUIRES THE BIDDER TO BE LICENSED BY THE N.C. LICENSING BOARD FOR CONTRACTORS WHEN BIDDING ON ANY NON-FEDERAL AID PROJECT WHERE THE BID IS \$30,000 OR MORE, EXCEPT FOR CERTAIN SPECIALTY WORK AS DETERMINED BY THE LICENSING BOARD. BIDDERS SHALL ALSO COMPLY WITH ALL OTHER APPLICABLE LAWS REGULATING THE PRACTICES OF ELECTRICAL, PLUMBING, HEATING AND AIR CONDITIONING AND REFRIGERATION CONTRACTING AS CONTAINED IN CHAPTER 87 OF THE GENERAL STATUTES OF NORTH CAROLINA. NOTWITHSTANDING THESE LIMITATIONS ON BIDDING, THE BIDDER WHO IS AWARDED ANY FEDERAL - AID FUNDED PROJECT SHALL COMPLY WITH CHAPTER 87 OF THE GENERAL STATUTES OF NORTH CAROLINA FOR LICENSING REQUIREMENTS WITHIN 60 CALENDAR DAYS OF BID OPENING.

BIDS WILL BE RECEIVED AS SHOWN BELOW:

THIS IS A ROADWAY & STRUCTURE PROPOSAL

5% BID BOND OR BID DEPOSIT REQUIRED

**PROPOSAL FOR THE CONSTRUCTION OF
CONTRACT No. C203976 IN MONTGOMERY AND MOORE COUNTIES, NORTH CAROLINA**

Date _____ 20 _____

**DEPARTMENT OF TRANSPORTATION,
RALEIGH, NORTH CAROLINA**

The Bidder has carefully examined the location of the proposed work to be known as Contract No. C203976 has carefully examined the plans and specifications, which are acknowledged to be part of the proposal, the special provisions, the proposal, the form of contract, and the forms of contract payment bond and contract performance bond; and thoroughly understands the stipulations, requirements and provisions. The undersigned bidder agrees to bound upon his execution of the bid and subsequent award to him by the Board of Transportation in accordance with this proposal to provide the necessary contract payment bond and contract performance bond within fourteen days after the written notice of award is received by him. The undersigned Bidder further agrees to provide all necessary machinery, tools, labor, and other means of construction; and to do all the work and to furnish all materials, except as otherwise noted, necessary to perform and complete the said contract in accordance with *the 2012 Standard Specifications for Roads and Structures* by the dates(s) specified in the Project Special Provisions and in accordance with the requirements of the Engineer, and at the unit or lump sum prices, as the case may be, for the various items given on the sheets contained herein.

The Bidder shall provide and furnish all the materials, machinery, implements, appliances and tools, and perform the work and required labor to construct and complete State Highway Contract No. C203976 in Montgomery and Moore Counties, for the unit or lump sum prices, as the case may be, bid by the Bidder in his bid and according to the proposal, plans, and specifications prepared by said Department, which proposal, plans, and specifications show the details covering this project, and hereby become a part of this contract.

The published volume entitled *North Carolina Department of Transportation, Raleigh, Standard Specifications for Roads and Structures, January 2012* with all amendments and supplements thereto, is by reference incorporated into and made a part of this contract; that, except as herein modified, all the construction and work included in this contract is to be done in accordance with the specifications contained in said volume, and amendments and supplements thereto, under the direction of the Engineer.

If the proposal is accepted and the award is made, the contract is valid only when signed either by the Contract Officer or such other person as may be designated by the Secretary to sign for the Department of Transportation. The conditions and provisions herein cannot be changed except over the signature of the said Contract Officer.

The quantities shown in the itemized proposal for the project are considered to be approximate only and are given as the basis for comparison of bids. The Department of Transportation may increase or decrease the quantity of any item or portion of the work as may be deemed necessary or expedient.

An increase or decrease in the quantity of an item will not be regarded as sufficient ground for an increase or decrease in the unit prices, nor in the time allowed for the completion of the work, except as provided for the contract.

Accompanying this bid is a bid bond secured by a corporate surety, or certified check payable to the order of the Department of Transportation, for five percent of the total bid price, which deposit is to be forfeited as liquidated damages in case this bid is accepted and the Bidder shall fail to provide the required payment and performance bonds with the Department of Transportation, under the condition of this proposal, within 14 calendar days after the written notice of award is received by him, as provided in the *Standard Specifications*; otherwise said deposit will be returned to the Bidder.



State Contract Officer

DocuSigned by:

Ronald E. Davenport, Jr.

F81B6038A47A442...

10/3/2017

TABLE OF CONTENTS

COVER SHEET
PROPOSAL SHEET

PROJECT SPECIAL PROVISIONS

CONTRACT TIME AND LIQUIDATED DAMAGES: G-1
 INTERMEDIATE CONTRACT TIME NUMBER 1 AND LIQUIDATED DAMAGES: G-1
 PERMANENT VEGETATION ESTABLISHMENT:..... G-2
 MAJOR CONTRACT ITEMS: G-2
 SPECIALTY ITEMS:..... G-3
 FUEL PRICE ADJUSTMENT:..... G-3
 SCHEDULE OF ESTIMATED COMPLETION PROGRESS:..... G-4
 MINORITY BUSINESS ENTERPRISE AND WOMEN BUSINESS ENTERPRISE: G-4
 SUBSURFACE INFORMATION:..... G-18
 LOCATING EXISTING UNDERGROUND UTILITIES:..... G-19
 VALUE ENGINEERING PROPOSAL: G-19
 RESOURCE CONSERVATION AND ENV. SUSTAINABLE PRACTICES:..... G-20
 DOMESTIC STEEL: G-21
 MAINTENANCE OF THE PROJECT: G-21
 COOPERATION BETWEEN CONTRACTORS:..... G-22
 TWELVE MONTH GUARANTEE: G-22
 OUTSOURCING OUTSIDE THE USA:..... G-23
 GIFTS FROM VENDORS AND CONTRACTORS: G-23
 LIABILITY INSURANCE:..... G-23
 EROSION AND SEDIMENT CONTROL/STORMWATER CERTIFICATION: G-24
 PROCEDURE FOR MONITORING BORROW PIT DISCHARGE:..... G-29
 EMPLOYMENT:..... G-30
 STATE HIGHWAY ADMINISTRATOR TITLE CHANGE:..... G-31
 SUBLETTING OF CONTRACT: G-31

ROADWAY R-1

STANDARD SPECIAL PROVISIONS

AVAILABILITY FUNDS – TERMINATION OF CONTRACTS SSP-1
 NCDOT GENERAL SEED SPECIFICATION FOR SEED QUALITY SSP-2
 ERRATA..... SSP-5
 PLANT AND PEST QUARANTINES SSP-7
 MINIMUM WAGES SSP-8
 AWARD OF CONTRACT..... SSP-9
 ON-THE-JOB TRAINING SSP-14
 NCDENR NAME CHANGE..... SSP-17

UNIT PROJECT SPECIAL PROVISIONS

GEOTECHNICAL.....GT-0.1
UTILITY BY OTHERS.....UBO-1
EROSION CONTROLEC-1
STRUCTURE / CULVERTS..... ST-1

PERMITSP-1

PROPOSAL ITEM SHEET

ITEM SHEET(S) (TAN SHEETS)

PROJECT SPECIAL PROVISIONS**GENERAL****CONTRACT TIME AND LIQUIDATED DAMAGES:**

(12-20-16)

108

SP1 G07 B

The date of availability for this contract is the date the Contractor begins work but not before **November 27, 2017** or later than **March 15, 2018**, except that work in jurisdictional waters and wetlands shall not begin until a meeting between NCDOT, Regulatory Agencies, and the Contractor is held as stipulated in the permits contained elsewhere in this proposal. This delay in availability has been considered in determining the contract time for this project.

The completion date for this contract is the date that is **One Hundred Eighty (180)** consecutive calendar days after completion of Intermediate Contract Time Number 1.

Except where otherwise provided by the contract, observation periods required by the contract will not be a part of the work to be completed by the completion date and/or intermediate contract times stated in the contract. The acceptable completion of the observation periods that extend beyond the final completion date shall be a part of the work covered by the performance and payment bonds.

The liquidated damages for this contract are **Two Hundred Dollars (\$ 200.00)** per calendar day. These liquidated damages will not be cumulative with any liquidated damages which may become chargeable under Intermediate Contract Time Number 1. At the preconstruction conference the Contractor shall declare his expected date for beginning work. Should the Contractor desire to revise this date after the preconstruction conference, he shall notify the Engineer in writing at least thirty (30) days prior to the revised date.

INTERMEDIATE CONTRACT TIME NUMBER 1 AND LIQUIDATED DAMAGES:

(12-18-07) (Rev. 2-21-12)

108

SP1 G13 B

Except for that work required under the Project Special Provisions entitled *Planting, Reforestation* and/or *Permanent Vegetation Establishment*, included elsewhere in this proposal, the Contractor will be required to complete all work included in this contract and shall place and maintain traffic on same.

The date of availability for this intermediate contract time is the date of availability of the contract.

The completion date for this intermediate contract time is the date which is **One Hundred Fifty (150)** consecutive calendar days after the date of availability.

The liquidated damages for this intermediate contract time are **Four Thousand Dollars (\$ 4,000.00)** per calendar day.

Upon apparent completion of all the work required to be completed by this intermediate date, a final inspection will be held in accordance with Article 105-17 and upon acceptance, the Department will assume responsibility for the maintenance of all work except *Planting, Reforestation* and/or *Permanent Vegetation Establishment*. The Contractor will be responsible for

and shall make corrections of all damages to the completed roadway caused by his planting operations, whether occurring prior to or after placing traffic through the project.

PERMANENT VEGETATION ESTABLISHMENT:

(2-16-12) (Rev. 10-15-13)

104

SP1 G16

Establish a permanent stand of the vegetation mixture shown in the contract. During the period between initial vegetation planting and final project acceptance, perform all work necessary to establish permanent vegetation on all erodible areas within the project limits, as well as, in borrow and waste pits. This work shall include erosion control device maintenance and installation, repair seeding and mulching, supplemental seeding and mulching, mowing, and fertilizer topdressing, as directed. All work shall be performed in accordance with the applicable section of the *2012 Standard Specifications*. All work required for initial vegetation planting shall be performed as a part of the work necessary for the completion and acceptance of the Intermediate Contract Time (ICT). Between the time of ICT and Final Project acceptance, or otherwise referred to as the vegetation establishment period, the Department will be responsible for preparing the required National Pollutant Discharge Elimination System (NPDES) inspection records.

Once the Engineer has determined that the permanent vegetation establishment requirement has been achieved at an 80% vegetation density (the amount of established vegetation per given area to stabilize the soil) and no erodible areas exist within the project limits, the Contractor will be notified to remove the remaining erosion control devices that are no longer needed. The Contractor will be responsible for, and shall correct any areas disturbed by operations performed in permanent vegetation establishment and the removal of temporary erosion control measures, whether occurring prior to or after placing traffic on the project.

Payment for *Response for Erosion Control, Seeding and Mulching, Repair Seeding, Supplemental Seeding, Mowing, Fertilizer Topdressing, Silt Excavation, and Stone for Erosion Control* will be made at contract unit prices for the affected items. Work required that is not represented by contract line items will be paid in accordance with Articles 104-7 or 104-3 of the *2012 Standard Specifications*. No additional compensation will be made for maintenance and removal of temporary erosion control items.

MAJOR CONTRACT ITEMS:

(2-19-02)

104

SP1 G28

The following listed items are the major contract items for this contract (see Article 104-5 of the *2012 Standard Specifications*):

Line #	Description
080 —	3'-0" x 2'-9" Prestressed Concrete Box Beams

SPECIALTY ITEMS:

(7-1-95)(Rev. 1-17-12)

108-6

SP1 G37

Items listed below will be the specialty items for this contract (see Article 108-6 of the 2012 *Standard Specifications*).

Line #	Description
18 - 21	Guardrail
25 - 30	Signing
36 - 37	Long-Life Pavement Markings
38	Permanent Pavement Markers
39 - 63	Erosion Control

FUEL PRICE ADJUSTMENT:

(11-15-05) (Rev. 2-18-14)

109-8

SP1 G43

Revise the 2012 *Standard Specifications* as follows:

Page 1-83, Article 109-8, Fuel Price Adjustments, add the following:

The base index price for DIESEL #2 FUEL is \$ **1.7069** per gallon. Where any of the following are included as pay items in the contract, they will be eligible for fuel price adjustment.

The pay items and the fuel factor used in calculating adjustments to be made will be as follows:

Description	Units	Fuel Usage Factor Diesel
Unclassified Excavation	Gal/CY	0.29
Borrow Excavation	Gal/CY	0.29
Class IV Subgrade Stabilization	Gal/Ton	0.55
Aggregate Base Course	Gal/Ton	0.55
Sub-Ballast	Gal/Ton	0.55
Asphalt Concrete Base Course, Type ____	Gal/Ton	2.90
Asphalt Concrete Intermediate Course, Type ____	Gal/Ton	2.90
Asphalt Concrete Surface Course, Type ____	Gal/Ton	2.90
Open-Graded Asphalt Friction Course	Gal/Ton	2.90
Permeable Asphalt Drainage Course, Type ____	Gal/Ton	2.90
Sand Asphalt Surface Course, Type ____	Gal/Ton	2.90
Aggregate for Cement Treated Base Course	Gal/Ton	0.55
Portland Cement for Cement Treated Base Course	Gal/Ton	0.55
__" Portland Cement Concrete Pavement	Gal/SY	0.245
Concrete Shoulders Adjacent to __" Pavement	Gal/SY	0.245

SCHEDULE OF ESTIMATED COMPLETION PROGRESS:

(7-15-08) (Rev. 5-16-17)

108-2

SP1 G58

The Contractor's attention is directed to the Standard Special Provision entitled *Availability of Funds Termination of Contracts* included elsewhere in this proposal. The Department of Transportation's schedule of estimated completion progress for this project as required by that Standard Special Provision is as follows:

<u>Fiscal Year</u>	<u>Progress (% of Dollar Value)</u>
2018	(7/01/17 - 6/30/18)
	100% of Total Amount Bid

The Contractor shall also furnish his own progress schedule in accordance with Article 108-2 of the *2012 Standard Specifications*. Any acceleration of the progress as shown by the Contractor's progress schedule over the progress as shown above shall be subject to the approval of the Engineer.

MINORITY BUSINESS ENTERPRISE AND WOMEN BUSINESS ENTERPRISE:

(10-16-07)(Rev. 1-17-17)

102-15(J)

SP1 G66

Description

The purpose of this Special Provision is to carry out the North Carolina Department of Transportation's policy of ensuring nondiscrimination in the award and administration of contracts financed in whole or in part with State funds.

Definitions

Additional MBE/WBE Subcontractors - Any MBE/WBE submitted at the time of bid that will not be used to meet either the MBE or WBE goal. No submittal of a Letter of Intent is required, unless the additional participation is used for banking purposes.

Committed MBE/WBE Subcontractor - Any MBE/WBE submitted at the time of bid that is being used to meet either the MBE or WBE goal by submission of a Letter of Intent. Or any MBE or WBE used as a replacement for a previously committed MBE or WBE firm.

Contract Goals Requirement - The approved MBE and WBE participation at time of award, but not greater than the advertised contract goals for each.

Goal Confirmation Letter - Written documentation from the Department to the bidder confirming the Contractor's approved, committed MBE and WBE participation along with a listing of the committed MBE and WBE firms.

Manufacturer - A firm that operates or maintains a factory or establishment that produces on the premises, the materials or supplies obtained by the Contractor.

MBE Goal - A portion of the total contract, expressed as a percentage, that is to be performed by committed MBE subcontractor(s).

Minority Business Enterprise (MBE) - A firm certified as a Disadvantaged Minority-Owned Business Enterprise through the North Carolina Unified Certification Program.

Regular Dealer - A firm that owns, operates, or maintains a store, warehouse, or other establishment in which the materials or supplies required for the performance of the contract are bought, kept in stock, and regularly sold to the public in the usual course of business. A regular dealer engages in, as its principal business and in its own name, the purchase and sale or lease of the products in question. A regular dealer in such bulk items as steel, cement, gravel, stone, and petroleum products need not keep such products in stock, if it owns and operates distribution equipment for the products. Brokers and packagers are not regarded as manufacturers or regular dealers within the meaning of this section.

North Carolina Unified Certification Program (NCUCP) - A program that provides comprehensive services and information to applicants for MBE/WBE certification. The MBE/WBE program follows the same regulations as the federal Disadvantaged Business Enterprise (DBE) program in accordance with 49 CFR Part 26.

United States Department of Transportation (USDOT) - Federal agency responsible for issuing regulations (49 CFR Part 26) and official guidance for the DBE program.

WBE Goal - A portion of the total contract, expressed as a percentage, that is to be performed by committed WBE subcontractor(s).

Women Business Enterprise (WBE) - A firm certified as a Disadvantaged Women-Owned Business Enterprise through the North Carolina Unified Certification Program.

Forms and Websites Referenced in this Provision

Payment Tracking System - On-line system in which the Contractor enters the payments made to MBE and WBE subcontractors who have performed work on the project.
<https://apps.dot.state.nc.us/Vendor/PaymentTracking/>

DBE-IS Subcontractor Payment Information - Form for reporting the payments made to all MBE/WBE firms working on the project. This form is for paper bid projects only.
<https://connect.ncdot.gov/business/Turnpike/Documents/Form%20DBE-IS%20Subcontractor%20Payment%20Information.pdf>

RF-1 MBE/WBE Replacement Request Form - Form for replacing a committed MBE or WBE.
<http://connect.ncdot.gov/projects/construction/Construction%20Forms/DBE%20MBE%20WBE%20Replacement%20Request%20Form.pdf>

SAF Subcontract Approval Form - Form required for approval to sublet the contract.
<http://connect.ncdot.gov/projects/construction/Construction%20Forms/Subcontract%20Approval%20Form%20Rev.%202012.zip>

JC-1 Joint Check Notification Form - Form and procedures for joint check notification. The form acts as a written joint check agreement among the parties providing full and prompt disclosure of the expected use of joint checks.

<http://connect.ncdot.gov/projects/construction/Construction%20Forms/Joint%20Check%20Notification%20Form.pdf>

Letter of Intent - Form signed by the Contractor and the MBE/WBE subcontractor, manufacturer or regular dealer that affirms that a portion of said contract is going to be performed by the signed MBE/WBE for the amount listed at the time of bid.

<http://connect.ncdot.gov/letting/LetCentral/Letter%20of%20Intent%20to%20Perform%20as%20a%20Subcontractor.pdf>

Listing of MBE and WBE Subcontractors Form - Form for entering MBE/WBE subcontractors on a project that will meet this MBE and WBE goals. This form is for paper bids only.

[http://connect.ncdot.gov/municipalities/Bid%20Proposals%20for%20LGA%20Content/09%20MBE-WBE%20Subcontractors%20\(State\).docx](http://connect.ncdot.gov/municipalities/Bid%20Proposals%20for%20LGA%20Content/09%20MBE-WBE%20Subcontractors%20(State).docx)

Subcontractor Quote Comparison Sheet - Spreadsheet for showing all subcontractor quotes in the work areas where MBEs and WBEs quoted on the project. This sheet is submitted with good faith effort packages.

<http://connect.ncdot.gov/business/SmallBusiness/Documents/DBE%20Subcontractor%20Quote%20Comparison%20Example.xls>

MBE and WBE Goal

The following goals for participation by Minority Business Enterprises and Women Business Enterprises are established for this contract:

(A) **Minority Business Enterprises 1.0 %**

- (1) *If the MBE goal is more than zero*, the Contractor shall exercise all necessary and reasonable steps to ensure that MBEs participate in at least the percent of the contract as set forth above as the MBE goal.
- (2) *If the MBE goal is zero*, the Contractor shall make an effort to recruit and use MBEs during the performance of the contract. Any MBE participation obtained shall be reported to the Department.

(B) **Women Business Enterprises 3.0 %**

- (1) *If the WBE goal is more than zero*, the Contractor shall exercise all necessary and reasonable steps to ensure that WBEs participate in at least the percent of the contract as set forth above as the WBE goal.
- (2) *If the WBE goal is zero*, the Contractor shall make an effort to recruit and use WBEs during the performance of the contract. Any WBE participation obtained shall be reported to the Department.

Directory of Transportation Firms (Directory)

Real-time information is available about firms doing business with the Department and firms that are certified through NCUCP in the Directory of Transportation Firms. Only firms identified in the Directory as MBE and WBE certified shall be used to meet the MBE and WBE goals respectively. The Directory can be found at the following link. <https://www.ebs.nc.gov/VendorDirectory/default.html>

The listing of an individual firm in the directory shall not be construed as an endorsement of the firm's capability to perform certain work.

Listing of MBE/WBE Subcontractors

At the time of bid, bidders shall submit all MBE and WBE participation that they anticipate to use during the life of the contract. Only those identified to meet the MBE goal and the WBE goal will be considered committed, even though the listing shall include both committed MBE/WBE subcontractors and additional MBE/WBE subcontractors. Any additional MBE/WBE subcontractor participation above the goal for which letters of intent are received will follow the banking guidelines found elsewhere in this provision. All other additional MBE/WBE subcontractor participation submitted at the time of bid will be used toward the Department's overall race-neutral goals. Only those firms with current MBE and WBE certification at the time of bid opening will be acceptable for listing in the bidder's submittal of MBE and WBE participation. The Contractor shall indicate the following required information:

(A) Electronic Bids

Bidders shall submit a listing of MBE and WBE participation in the appropriate section of Expedite, the bidding software of Bid Express®.

- (1) Submit the names and addresses of MBE and WBE firms identified to participate in the contract. If the bidder uses the updated listing of MBE and WBE firms shown in Expedite, the bidder may use the dropdown menu to access the name and address of the firms.
- (2) Submit the contract line numbers of work to be performed by each MBE and WBE firm. When no figures or firms are entered, the bidder will be considered to have no MBE or WBE participation.
- (3) The bidder shall be responsible for ensuring that the MBE and WBE are certified at the time of bid by checking the Directory of Transportation Firms. If the firm is not certified at the time of the bid-letting, that MBE's or WBE's participation will not count towards achieving either the MBE or WBE goal.

(B) Paper Bids

- (1) *If either the MBE or WBE goal is more than zero,*
 - (a) Bidders, at the time the bid proposal is submitted, shall submit a listing of MBE/WBE participation, including the names and addresses on *Listing of MBE and WBE Subcontractors* contained elsewhere in the contract documents in order for the bid to be considered responsive. Bidders shall indicate the total dollar value of the MBE and WBE participation for the contract.
 - (b) If bidders have no MBE or WBE participation, they shall indicate this on the *Listing of MBE and WBE Subcontractors* by entering the word “None” or the number “0.” This form shall be completed in its entirety. **Blank forms will not be deemed to represent zero participation.** Bids submitted that do not have MBE and WBE participation indicated on the appropriate form will not be read publicly during the opening of bids. The Department will not consider these bids for award and the proposal will be rejected.
 - (c) The bidder shall be responsible for ensuring that the MBE/WBE is certified at the time of bid by checking the Directory of Transportation Firms. If the firm is not certified at the time of the bid-letting, that MBE’s or WBE’s participation will not count towards achieving the corresponding goal.
- (2) *If either the MBE or WBE goal is zero,* entries on the *Listing of MBE and WBE Subcontractors* are not required for the zero goal, however any MBE or WBE participation that is achieved during the project shall be reported in accordance with requirements contained elsewhere in the special provision.

MBE or WBE Prime Contractor

When a certified MBE or WBE firm bids on a contract that contains MBE and WBE goals, the firm is responsible for meeting the goals or making good faith efforts to meet the goals, just like any other bidder. In most cases, a MBE or WBE bidder on a contract will meet one of the goals by virtue of the work it performs on the contract with its own forces. However, all the work that is performed by the MBE or WBE bidder and any other similarly certified subcontractors will count toward the goal. The MBE or WBE bidder shall list itself along with any MBE or WBE subcontractors, if any, in order to receive credit toward the goals.

For example, on a proposed contract, the WBE goal is 10%, and the MBE goal is 8%. A WBE bidder puts in a bid where they will perform 40% of the contract work and have a WBE subcontractor which will perform another 5% of the work. Together the two WBE firms submit on the *Listing of MBE and WBE Subcontractors* a value of 45% of the contract which fulfills the WBE goal. The 8% MBE goal shall be obtained through MBE participation with MBE certified subcontractors or documented through a good faith effort. It should be noted that you cannot combine the two goals to meet an overall value. The two goals shall remain separate.

MBE/WBE prime contractors shall also follow Sections A and B listed under *Listing of MBE and WBE Subcontractor* just as a non-MBE/WBE bidder would.

Written Documentation – Letter of Intent

The bidder shall submit written documentation for each MBE/WBE that will be used to meet the MBE and WBE goals of the contract, indicating the bidder's commitment to use the MBE/WBE in the contract. This documentation shall be submitted on the Department's form titled *Letter of Intent*.

The documentation shall be received in the office of the State Contractor Utilization Engineer or at DBE@ncdot.gov no later than 10:00 a.m. of the sixth calendar day following opening of bids, unless the sixth day falls on an official state holiday. In that situation, it is due in the office of the State Contractor Utilization Engineer no later than 10:00 a.m. on the next official state business day.

If the bidder fails to submit the Letter of Intent from each committed MBE and WBE to be used toward the MBE and WBE goals, or if the form is incomplete (i.e. both signatures are not present), the MBE/WBE participation will not count toward meeting the MBE/WBE goal. If the lack of this participation drops the commitment below either the MBE or WBE goal, the Contractor shall submit evidence of good faith efforts for the goal not met, completed in its entirety, to the State Contractor Utilization Engineer or DBE@ncdot.gov no later than 10:00 a.m. on the eighth calendar day following opening of bids, unless the eighth day falls on an official state holiday. In that situation, it is due in the office of the State Contractor Utilization Engineer no later than 10:00 a.m. on the next official state business day.

Banking MBE/WBE Credit

If the bid of the lowest responsive bidder exceeds \$500,000 and if the committed MBE/WBE participation submitted by Letter of Intent exceeds the algebraic sum of the MBE or WBE goal by \$1,000 or more, the excess will be placed on deposit by the Department for future use by the bidder. Separate accounts will be maintained for MBE and WBE participation and these may accumulate for a period not to exceed 24 months.

When the apparent lowest responsive bidder fails to submit sufficient participation by MBE firms to meet the contract goal, as part of the good faith effort, the Department will consider allowing the bidder to withdraw funds to meet the MBE goal as long as there are adequate funds available from the bidder's MBE bank account.

When the apparent lowest responsive bidder fails to submit sufficient participation by WBE firms to meet the contract goal, as part of the good faith effort, the Department will consider allowing the bidder to withdraw funds to meet the WBE goal as long as there are adequate funds available from the bidder's WBE bank account.

Submission of Good Faith Effort

If the bidder fails to meet or exceed either the MBE or the WBE goal, the apparent lowest responsive bidder shall submit to the Department documentation of adequate good faith efforts made to reach that specific goal(s).

A hard copy and an electronic copy of this information shall be received in the office of the State Contractor Utilization Engineer or at DBE@ncdot.gov no later than 10:00 a.m. on the sixth calendar day following opening of bids unless the sixth day falls on an official state holiday. In that situation, it would be due in the office of the State Contractor Utilization Engineer no later than 10:00 a.m. on the next official state business day. If the contractor cannot send the information electronically, then one complete set and 9 copies of this information shall be received under the same time constraints above.

Note: Where the information submitted includes repetitious solicitation letters, it will be acceptable to submit a representative letter along with a distribution list of the firms that were solicited. Documentation of MBE/WBE quotations shall be a part of the good faith effort submittal. This documentation may include written subcontractor quotations, telephone log notations of verbal quotations, or other types of quotation documentation.

Consideration of Good Faith Effort for Projects with MBE/WBE Goals More Than Zero

Adequate good faith efforts mean that the bidder took all necessary and reasonable steps to achieve the goal which, by their scope, intensity, and appropriateness, could reasonably be expected to obtain sufficient MBE/WBE participation. Adequate good faith efforts also mean that the bidder actively and aggressively sought MBE/WBE participation. Mere *pro forma* efforts are not considered good faith efforts.

The Department will consider the quality, quantity, and intensity of the different kinds of efforts a bidder has made. Listed below are examples of the types of actions a bidder will take in making a good faith effort to meet the goals and are not intended to be exclusive or exhaustive, nor is it intended to be a mandatory checklist.

- (A) Soliciting through all reasonable and available means (e.g. attendance at pre-bid meetings, advertising, written notices, use of verifiable electronic means through the use of the NCDOT Directory of Transportation Firms) the interest of all certified MBEs/WBEs that are also prequalified subcontractors. The bidder must solicit this interest within at least 10 days prior to bid opening to allow the MBEs/WBEs to respond to the solicitation. Solicitation shall provide the opportunity to MBEs/WBEs within the Division and surrounding Divisions where the project is located. The bidder must determine with certainty if the MBEs/WBEs are interested by taking appropriate steps to follow up initial solicitations.

- (B) Selecting portions of the work to be performed by MBEs/WBEs in order to increase the likelihood that the MBE and WBE goals will be achieved.
- (1) Where appropriate, break out contract work items into economically feasible units to facilitate MBE/WBE participation, even when the prime contractor might otherwise prefer to perform these work items with its own forces.
 - (2) Negotiate with subcontractors to assume part of the responsibility to meet the contract MBE/WBE goals when the work to be sublet includes potential for MBE/WBE participation (2nd and 3rd tier subcontractors).
- (C) Providing interested certified MBEs/WBEs that are also prequalified subcontractors with adequate information about the plans, specifications, and requirements of the contract in a timely manner to assist them in responding to a solicitation.
- (D) (1) Negotiating in good faith with interested MBEs/WBEs. It is the bidder's responsibility to make a portion of the work available to MBE/WBE subcontractors and suppliers and to select those portions of the work or material needs consistent with the available MBE/WBE subcontractors and suppliers, so as to facilitate MBE/WBE participation. Evidence of such negotiation includes the names, addresses, and telephone numbers of MBEs/WBEs that were considered; a description of the information provided regarding the plans and specifications for the work selected for subcontracting; and evidence as to why additional agreements could not be reached for MBEs/WBEs to perform the work.
- (2) A bidder using good business judgment would consider a number of factors in negotiating with subcontractors, including MBE/WBE subcontractors, and would take a firm's price and capabilities as well as contract goals into consideration. However, the fact that there may be some additional costs involved in finding and using MBEs/WBEs is not in itself sufficient reason for a bidder's failure to meet the contract MBE or WBE goals, as long as such costs are reasonable. Also, the ability or desire of a prime contractor to perform the work of a contract with its own organization does not relieve the bidder of the responsibility to make good faith efforts. Bidding contractors are not, however, required to accept higher quotes from MBEs/WBEs if the price difference is excessive or unreasonable.
- (E) Not rejecting MBEs/WBEs as being unqualified without sound reasons based on a thorough investigation of their capabilities. The bidder's standing within its industry, membership in specific groups, organizations, or associates and political or social affiliations (for example, union vs. non-union employee status) are not legitimate causes for the rejection or non-solicitation of bids in the bidder's efforts to meet the project goal.
- (F) Making efforts to assist interested MBEs/WBEs in obtaining bonding, lines of credit, or insurance as required by the recipient or bidder.
- (G) Making efforts to assist interested MBEs/WBEs in obtaining necessary equipment, supplies, materials, or related assistance or services.

- (H) Effectively using the services of available minority/women community organizations; minority/women contractors' groups; Federal, State, and local minority/women business assistance offices; and other organizations as allowed on a case-by-case basis to provide assistance in the recruitment and placement of MBEs/WBEs. Contact within 7 days from the bid opening the Business Opportunity and Work Force Development Unit at DBE@ncdot.gov to give notification of the bidder's inability to get MBE or WBE quotes.
- (I) Any other evidence that the bidder submits which shows that the bidder has made reasonable good faith efforts to meet the MBE and WBE goal.

In addition, the Department may take into account the following:

- (1) Whether the bidder's documentation reflects a clear and realistic plan for achieving the MBE and WBE goals.
- (2) The bidders' past performance in meeting the MBE and WBE goals.
- (3) The performance of other bidders in meeting the MBE and WBE goals. For example, when the apparent successful bidder fails to meet the goals, but others meet it, you may reasonably raise the question of whether, with additional reasonable efforts the apparent successful bidder could have met the goals. If the apparent successful bidder fails to meet the MBE and WBE goals, but meets or exceeds the average MBE and WBE participation obtained by other bidders, the Department may view this, in conjunction with other factors, as evidence of the apparent successful bidder having made a good faith effort.

If the Department does not award the contract to the apparent lowest responsive bidder, the Department reserves the right to award the contract to the next lowest responsive bidder that can satisfy to the Department that the MBE and WBE goals can be met or that an adequate good faith effort has been made to meet the MBE and WBE goals.

Non-Good Faith Appeal

The State Contractual Services Engineer will notify the contractor verbally and in writing of non-good faith. A contractor may appeal a determination of non-good faith made by the Goal Compliance Committee. If a contractor wishes to appeal the determination made by the Committee, they shall provide written notification to the State Contractual Services Engineer or at DBE@ncdot.gov. The appeal shall be made within 2 business days of notification of the determination of non-good faith.

Counting MBE/WBE Participation Toward Meeting MBE/WBE Goals

- (A) Participation

The total dollar value of the participation by a committed MBE/WBE will be counted toward the contract goal requirements. The total dollar value of participation by

a committed MBE/WBE will be based upon the value of work actually performed by the MBE/WBE and the actual payments to MBE/WBE firms by the Contractor.

(B) Joint Checks

Prior notification of joint check use shall be required when counting MBE/WBE participation for services or purchases that involves the use of a joint check. Notification shall be through submission of Form JC-1 (*Joint Check Notification Form*) and the use of joint checks shall be in accordance with the Department's Joint Check Procedures.

(C) Subcontracts (Non-Trucking)

A MBE/WBE may enter into subcontracts. Work that a MBE subcontracts to another MBE firm may be counted toward the MBE contract goal requirement. The same holds for work that a WBE subcontracts to another WBE firm. Work that a MBE subcontracts to a non-MBE firm does not count toward the MBE contract goal requirement. Again, the same holds true for the work that a WBE subcontracts to a non-WBE firm. If a MBE or WBE contractor or subcontractor subcontracts a significantly greater portion of the work of the contract than would be expected on the basis of standard industry practices, it shall be presumed that the MBE or WBE is not performing a commercially useful function. The MBE/WBE may present evidence to rebut this presumption to the Department. The Department's decision on the rebuttal of this presumption may be subject to review by the Office of Inspector General, NCDOT.

(D) Joint Venture

When a MBE or WBE performs as a participant in a joint venture, the Contractor may count toward its contract goal requirement a portion of the total value of participation with the MBE or WBE in the joint venture, that portion of the total dollar value being a distinct clearly defined portion of work that the MBE or WBE performs with its forces.

(E) Suppliers

A contractor may count toward its MBE or WBE requirement 60 percent of its expenditures for materials and supplies required to complete the contract and obtained from a MBE or WBE regular dealer and 100 percent of such expenditures from a MBE or WBE manufacturer.

(F) Manufacturers and Regular Dealers

A contractor may count toward its MBE or WBE requirement the following expenditures to MBE/WBE firms that are not manufacturers or regular dealers:

- (1) The fees or commissions charged by a MBE/WBE firm for providing a *bona fide* service, such as professional, technical, consultant, or managerial services, or for providing bonds or insurance specifically required for the performance of a DOT-assisted contract, provided the fees or commissions are determined to be

reasonable and not excessive as compared with fees and commissions customarily allowed for similar services.

- (2) With respect to materials or supplies purchased from a MBE/WBE, which is neither a manufacturer nor a regular dealer, count the entire amount of fees or commissions charged for assistance in the procurement of the materials and supplies, or fees or transportation charges for the delivery of materials or supplies required on a job site (but not the cost of the materials and supplies themselves), provided the fees are determined to be reasonable and not excessive as compared with fees customarily allowed for similar services.

Commercially Useful Function

(A) MBE/WBE Utilization

The Contractor may count toward its contract goal requirement only expenditures to MBEs and WBEs that perform a commercially useful function in the work of a contract. A MBE/WBE performs a commercially useful function when it is responsible for execution of the work of the contract and is carrying out its responsibilities by actually performing, managing, and supervising the work involved. To perform a commercially useful function, the MBE/WBE shall also be responsible with respect to materials and supplies used on the contract, for negotiating price, determining quality and quantity, ordering the material and installing (where applicable) and paying for the material itself. To determine whether a MBE/WBE is performing a commercially useful function, the Department will evaluate the amount of work subcontracted, industry practices, whether the amount the firm is to be paid under the contract is commensurate with the work it is actually performing and the MBE/WBE credit claimed for its performance of the work, and any other relevant factors.

(B) MBE/WBE Utilization in Trucking

The following factors will be used to determine if a MBE or WBE trucking firm is performing a commercially useful function:

- (1) The MBE/WBE shall be responsible for the management and supervision of the entire trucking operation for which it is responsible on a particular contract, and there shall not be a contrived arrangement for the purpose of meeting the MBE or WBE goal.
- (2) The MBE/WBE shall itself own and operate at least one fully licensed, insured, and operational truck used on the contract.
- (3) The MBE/WBE receives credit for the total value of the transportation services it provides on the contract using trucks it owns, insures, and operates using drivers it employs.
- (4) The MBE may subcontract the work to another MBE firm, including an owner-operator who is certified as a MBE. The same holds true that a WBE

may subcontract the work to another WBE firm, including an owner-operator who is certified as a WBE. When this occurs, the MBE or WBE who subcontracts work receives credit for the total value of the transportation services the subcontracted MBE or WBE provides on the contract. It should be noted that every effort shall be made by MBE and WBE contractors to subcontract to the same certification (i.e., MBEs to MBEs and WBEs to WBEs), in order to fulfill the goal requirement. This, however, may not always be possible due to the limitation of firms in the area. If the MBE or WBE firm shows a good faith effort has been made to reach out to similarly certified transportation service providers and there is no interest or availability, and they can get assistance from other certified providers, the Engineer will not hold the prime liable for meeting the goal.

- (5) The MBE/WBE may also subcontract the work to a non-MBE/WBE firm, including from an owner-operator. The MBE/WBE who subcontracts the work to a non-MBE/WBE is entitled to credit for the total value of transportation services provided by the non-MBE/WBE subcontractor not to exceed the value of transportation services provided by MBE/WBE-owned trucks on the contract. Additional participation by non-MBE/WBE subcontractors receives credit only for the fee or commission it receives as a result of the subcontract arrangement. The value of services performed under subcontract agreements between the MBE/WBE and the Contractor will not count towards the MBE/WBE contract requirement.
- (6) A MBE/WBE may lease truck(s) from an established equipment leasing business open to the general public. The lease must indicate that the MBE/WBE has exclusive use of and control over the truck. This requirement does not preclude the leased truck from working for others during the term of the lease with the consent of the MBE/WBE, so long as the lease gives the MBE/WBE absolute priority for use of the leased truck. This type of lease may count toward the MBE/WBE's credit as long as the driver is under the MBE/WBE's payroll.
- (7) Subcontracted/leased trucks shall display clearly on the dashboard the name of the MBE/WBE that they are subcontracted/leased to and their own company name if it is not identified on the truck itself. Magnetic door signs are not permitted.

MBE/WBE Replacement

When a Contractor has relied on a commitment to a MBE or WBE firm (or an approved substitute MBE or WBE firm) to meet all or part of a contract goal requirement, the contractor shall not terminate the MBE/WBE for convenience. This includes, but is not limited to, instances in which the Contractor seeks to perform the work of the terminated subcontractor with another MBE/WBE subcontractor, a non-MBE/WBE subcontractor, or with the Contractor's own forces or those of an affiliate. A MBE/WBE may only be terminated after receiving the Engineer's written approval based upon a finding of good cause for the termination. The prime contractor must give the MBE/WBE firm five (5) calendar days to respond to the prime contractor's notice of termination and advise the prime contractor and the Department of the reasons, if any, why the firm objects to the proposed termination of its subcontract and why the Department should not approve the action.

All requests for replacement of a committed MBE/WBE firm shall be submitted to the Engineer for approval on Form RF-1 (*Replacement Request*). If the Contractor fails to follow this procedure, the Contractor may be disqualified from further bidding for a period of up to 6 months.

The Contractor shall comply with the following for replacement of a committed MBE/WBE:

(A) Performance Related Replacement

When a committed MBE is terminated for good cause as stated above, an additional MBE that was submitted at the time of bid may be used to fulfill the MBE commitment. The same holds true if a committed WBE is terminated for good cause, an additional WBE that was submitted at the time of bid may be used to fulfill the WBE goal. A good faith effort will only be required for removing a committed MBE/WBE if there were no additional MBEs/WBEs submitted at the time of bid to cover the same amount of work as the MBE/WBE that was terminated.

If a replacement MBE/WBE is not found that can perform at least the same amount of work as the terminated MBE/WBE, the Contractor shall submit a good faith effort documenting the steps taken. Such documentation shall include, but not be limited to, the following:

- (1) Copies of written notification to MBEs/WBEs that their interest is solicited in contracting the work defaulted by the previous MBE/WBE or in subcontracting other items of work in the contract.
- (2) Efforts to negotiate with MBEs/WBEs for specific subbids including, at a minimum:
 - (a) The names, addresses, and telephone numbers of MBEs/WBEs who were contacted.
 - (b) A description of the information provided to MBEs/WBEs regarding the plans and specifications for portions of the work to be performed.
- (3) A list of reasons why MBE/WBE quotes were not accepted.
- (4) Efforts made to assist the MBEs/WBEs contacted, if needed, in obtaining bonding or insurance required by the Contractor.

(B) Decertification Replacement

- (1) When a committed MBE/WBE is decertified by the Department after the SAF (*Subcontract Approval Form*) has been received by the Department, the Department will not require the Contractor to solicit replacement MBE/WBE participation equal to the remaining work to be performed by the decertified firm. The participation equal to the remaining work performed by the decertified firm will count toward the contract goal requirement.
- (2) When a committed MBE/WBE is decertified prior to the Department receiving the SAF (*Subcontract Approval Form*) for the named MBE/WBE firm, the Contractor

shall take all necessary and reasonable steps to replace the MBE/WBE subcontractor with another similarly certified MBE/WBE subcontractor to perform at least the same amount of work to meet the MBE/WBE goal requirement. If a MBE/WBE firm is not found to do the same amount of work, a good faith effort must be submitted to NCDOT (see A herein for required documentation).

Changes in the Work

When the Engineer makes changes that result in the reduction or elimination of work to be performed by a committed MBE/WBE, the Contractor will not be required to seek additional participation. When the Engineer makes changes that result in additional work to be performed by a MBE/WBE based upon the Contractor's commitment, the MBE/WBE shall participate in additional work to the same extent as the MBE/WBE participated in the original contract work.

When the Engineer makes changes that result in extra work, which has more than a minimal impact on the contract amount, the Contractor shall seek additional participation by MBEs/WBEs unless otherwise approved by the Engineer.

When the Engineer makes changes that result in an alteration of plans or details of construction, and a portion or all of the work had been expected to be performed by a committed MBE/WBE, the Contractor shall seek participation by MBEs/WBEs unless otherwise approved by the Engineer.

When the Contractor requests changes in the work that result in the reduction or elimination of work that the Contractor committed to be performed by a MBE/WBE, the Contractor shall seek additional participation by MBEs/WBEs equal to the reduced MBE/WBE participation caused by the changes.

Reports and Documentation

A SAF (*Subcontract Approval Form*) shall be submitted for all work which is to be performed by a MBE/WBE subcontractor. The Department reserves the right to require copies of actual subcontract agreements involving MBE/WBE subcontractors.

When using transportation services to meet the contract commitment, the Contractor shall submit a proposed trucking plan in addition to the SAF. The plan shall be submitted prior to beginning construction on the project. The plan shall include the names of all trucking firms proposed for use, their certification type(s), the number of trucks owned by the firm, as well as the individual truck identification numbers, and the line item(s) being performed.

Within 30 calendar days of entering into an agreement with a MBE/WBE for materials, supplies or services, not otherwise documented by the SAF as specified above, the Contractor shall furnish the Engineer a copy of the agreement. The documentation shall also indicate the percentage (60% or 100%) of expenditures claimed for MBE/WBE credit.

Reporting Minority and Women Business Enterprise Participation

The Contractor shall provide the Engineer with an accounting of payments made to all MBE and WBE firms, including material suppliers and contractors at all levels (prime, subcontractor, or second tier subcontractor). This accounting shall be furnished to the Engineer for any given month by the end of the following month. Failure to submit this information accordingly may result in the following action:

- (A) Withholding of money due in the next partial pay estimate; or
- (B) Removal of an approved contractor from the prequalified bidders' list or the removal of other entities from the approved subcontractors list.

While each contractor (prime, subcontractor, 2nd tier subcontractor) is responsible for accurate accounting of payments to MBEs/WBEs, it shall be the prime contractor's responsibility to report all monthly and final payment information in the correct reporting manner.

Failure on the part of the Contractor to submit the required information in the time frame specified may result in the disqualification of that contractor and any affiliate companies from further bidding until the required information is submitted.

Failure on the part of any subcontractor to submit the required information in the time frame specified may result in the disqualification of that contractor and any affiliate companies from being approved for work on future DOT projects until the required information is submitted.

Contractors reporting transportation services provided by non-MBE/WBE lessees shall evaluate the value of services provided during the month of the reporting period only.

At any time, the Engineer can request written verification of subcontractor payments.

The Contractor shall report the accounting of payments through the Department's Payment Tracking System.

Failure to Meet Contract Requirements

Failure to meet contract requirements in accordance with Subarticle 102-15(J) of the *2012 Standard Specifications* may be cause to disqualify the Contractor.

SUBSURFACE INFORMATION:

(7-1-95)

450

SP1 G112 C

Subsurface information is available on the structure portion of this project only.

LOCATING EXISTING UNDERGROUND UTILITIES:

(3-20-12)

105

SP1 G115

Revise the *2012 Standard Specifications* as follows:

Page 1-43, Article 105-8, line 28, after the first sentence, add the following:

Identify excavation locations by means of pre-marking with white paint, flags, or stakes or provide a specific written description of the location in the locate request.

VALUE ENGINEERING PROPOSAL:

(05-19-15)

104

SP01 G116

Revise the *2012 Standard Specifications* as follows:

Page 1-36, Subarticle 104-12(B) Evaluation of Proposals, lines 42-44, replace the fourth sentence of the second paragraph with the following:

Pending execution of a formal supplemental agreement implementing an approved VEP and transferal of final plans (hard copy and electronic) sealed by an engineer licensed in the State of North Carolina incorporating an approved VEP to the Resident Engineer and the State Value Management Engineer, the Contractor shall remain obligated to perform the work in accordance with the terms of the existing contract.

Page 1-37, Subarticle 104-12(D) Preliminary Review, lines 9-12, replace the first sentence of the first paragraph with the following:

Should the Contractor desire a preliminary review of a possible VEP, before expending considerable time and expense in full development, a copy of the Preliminary VEP shall be submitted to the Resident Engineer and the State Value Management Engineer at ValueManagementUnit@ncdot.gov.

Page 1-37, Subarticle 104-12(E) Final Proposal, lines 22-23, replace the first sentence of the first paragraph with the following:

A copy of the Final VEP shall be submitted by the Contractor to the Resident Engineer and the State Value Management Engineer at ValueManagementUnit@ncdot.gov.

Page 1-38, Subarticle 104-12(F) Modifications, lines 2-8, replace the first paragraph with the following:

To facilitate the preparation of revisions to contract drawings, the Contractor may purchase reproducible copies of drawings for his use through the Department's Value Management Unit. The preparation of new design drawings by or for the Contractor shall be coordinated with the appropriate Design Branch through the State Value Management Engineer. The Contractor shall provide, at no charge to the Department, one set of reproducible drawings of the approved design needed to implement the VEP. Drawings (hard copy and electronic) which are sealed by an engineer licensed in the State of North Carolina shall be submitted to the State Value Management Engineer no later than ten (10) business days after acceptance of a VEP unless otherwise permitted.

Page 1-38, Subarticle 104-12(F) Modifications, line 17, add the following at the end of the third paragraph:

Supplemental agreements executed for design-bid-build contracts shall reflect any realized savings in the corresponding line items. Supplemental agreements executed for design-build contracts shall add one line item deducting the full savings from the total contract price and one line item crediting the Contractor with 50% of the total VEP savings.

Page 1-38, Subarticle 104-12(F) Modifications, lines 45-47, replace the eighth paragraph with the following:

Unless and until a supplemental agreement is executed and issued by the Department and final plans (hard copy and electronic) sealed by an engineer licensed in the State of North Carolina incorporating an approved VEP have been provided to the Resident Engineer and the State Value Management Engineer, the Contractor shall remain obligated to perform the work in accordance with the terms of the existing contract.

RESOURCE CONSERVATION AND ENV. SUSTAINABLE PRACTICES:

(5-21-13) (Rev. 5-19-15)

104-13

SP1 G118

In accordance with North Carolina Executive Order 156, NCGS 130A-309.14(3), and NCGS 136-28.8, it is the objective of the Department to aid in the reduction of materials that become a part of our solid waste stream, to divert materials from landfills, to find ways to recycle and reuse materials, to consider and minimize, where economically feasible, the environmental impacts associated with agency land use and acquisition, construction, maintenance and facility management for the benefit of the Citizens of North Carolina.

To achieve the mission of reducing environmental impacts across the state, the Department is committed to supporting the efforts to initiate, develop and use products and construction methods that incorporate the use of recycled, solid waste products and environmentally sustainable practices in accordance with Article 104-13 of the *Standard Specifications*.

Report the quantities of reused or recycled materials either incorporated in the project or diverted from landfills and any practice that minimizes the environmental impact on the project annually on the Project Construction Reuse and Recycling Reporting Form. The Project Construction Reuse and Recycling Reporting Form and a location tool for local recycling facilities are available at:

<http://connect.ncdot.gov/resources/Environmental/Pages/North-Carolina-Recycling-Locations.aspx>.

Submit the Project Construction Reuse and Recycling Reporting Form by August 1 annually to valuemanagementunit@ncdot.gov. For questions regarding the form or reporting, please contact the State Value Management Engineer at 919-707-4810.

DOMESTIC STEEL:

(4-16-13)

106

SP1 G120

Revise the *2012 Standard Specifications* as follows:

Page 1-49, Subarticle 106-1(B) Domestic Steel, lines 2-7, replace the first paragraph with the following:

All steel and iron products that are permanently incorporated into this project shall be produced in the United States except minimal amounts of foreign steel and iron products may be used provided the combined material cost of the items involved does not exceed 0.1% of the total amount bid for the entire project or \$2,500, whichever is greater. If invoices showing the cost of the material are not provided, the amount of the bid item involving the foreign material will be used for calculations. This minimal amount of foreign produced steel and iron products permitted for use is not applicable to high strength fasteners. Domestically produced high strength fasteners are required.

MAINTENANCE OF THE PROJECT:

(11-20-07) (Rev. 1-17-12)

104-10

SP1 G125

Revise the *2012 Standard Specifications* as follows:

Page 1-35, Article 104-10 Maintenance of the Project, line 25, add the following after the first sentence of the first paragraph:

All guardrail/guiderail within the project limits shall be included in this maintenance.

Page 1-35, Article 104-10 Maintenance of the Project, line 30, add the following as the last sentence of the first paragraph:

The Contractor shall perform weekly inspections of guardrail and guiderail and shall report damages to the Engineer on the same day of the weekly inspection. *Where damaged guardrail or guiderail is repaired or replaced as a result of maintaining the project in accordance with this article, such repair or replacement shall be performed within 7 consecutive calendar days of such inspection report.*

Page 1-35, Article 104-10 Maintenance of the Project, lines 42-44, replace the last sentence of the last paragraph with the following:

The Contractor will not be directly compensated for any maintenance operations necessary, except for maintenance of guardrail/guiderail, as this work will be considered incidental to the work covered by the various contract items. The provisions of Article 104-7, Extra Work, and Article 104-8, Compensation and Record Keeping will apply to authorized maintenance of guardrail/guiderail. Performance of weekly inspections of guardrail/guiderail, and the damage reports required as described above, will be considered to be an incidental part of the work being paid for by the various contract items.

COOPERATION BETWEEN CONTRACTORS:

(7-1-95)

105-7

SP1 G133

The Contractor's attention is directed to Article 105-7 of the *2012 Standard Specifications*.

2017CPT.08.25.10631, etc. (C204017) located in Moore County is under construction and will not be completed prior to letting of this project. Various maps of 2017CPT.08.25.10631, etc. are located adjacent to the off-site detour route of this project.

The Contractor on this project shall cooperate with the Contractor working within or adjacent to the limits of this project to the extent that the work can be carried out to the best advantage of all concerned.

TWELVE MONTH GUARANTEE:

(7-15-03)

108

SP1 G145

- (A) The Contractor shall guarantee materials and workmanship against latent and patent defects arising from faulty materials, faulty workmanship or negligence for a period of twelve months following the date of final acceptance of the work for maintenance and shall replace such defective materials and workmanship without cost to the Department. The Contractor will not be responsible for damage due to faulty design, normal wear and tear, for negligence on the part of the Department, and/or for use in excess of the design.
- (B) Where items of equipment or material carry a manufacturer's guarantee for any period in excess of twelve months, then the manufacturer's guarantee shall apply for that particular piece of equipment or material. The Department's first remedy shall be through the manufacturer although the Contractor is responsible for invoking the warranted repair work with the manufacturer. The Contractor's responsibility shall be limited to the term of the manufacturer's guarantee. NCDOT would be afforded the same warranty as provided by the Manufacturer.

This guarantee provision shall be invoked only for major components of work in which the Contractor would be wholly responsible for under the terms of the contract. Examples would include pavement structures, bridge components, and sign structures. This provision will not be used as a mechanism to force the Contractor to return to the project to make repairs or perform additional work that the Department would normally compensate the Contractor for. In addition, routine maintenance activities (i.e. mowing grass, debris removal, ruts in earth shoulders,) are not parts of this guarantee.

Appropriate provisions of the payment and/or performance bonds shall cover this guarantee for the project.

To ensure uniform application statewide the Division Engineer will forward details regarding the circumstances surrounding any proposed guarantee repairs to the Chief Engineer for review and approval prior to the work being performed.

OUTSOURCING OUTSIDE THE USA:

(9-21-04) (Rev. 5-16-06)

SP1 G150

All work on consultant contracts, services contracts, and construction contracts shall be performed in the United States of America. No work shall be outsourced outside of the United States of America.

Outsourcing for the purpose of this provision is defined as the practice of subcontracting labor, work, services, staffing, or personnel to entities located outside of the United States.

The North Carolina Secretary of Transportation shall approve exceptions to this provision in writing.

GIFTS FROM VENDORS AND CONTRACTORS:

(12-15-09)

107-1

SP1 G152

By Executive Order 24, issued by Governor Perdue, and *N.C.G.S. § 133-32*, it is unlawful for any vendor or contractor (i.e. architect, bidder, contractor, construction manager, design professional, engineer, landlord, offeror, seller, subcontractor, supplier, or vendor), to make gifts or to give favors to any State employee of the Governor's Cabinet Agencies (i.e. Administration, Commerce, Correction, Crime Control and Public Safety, Cultural Resources, Environment and Natural Resources, Health and Human Services, Juvenile Justice and Delinquency Prevention, Revenue, Transportation, and the Office of the Governor). This prohibition covers those vendors and contractors who:

- (A) Have a contract with a governmental agency; or
- (B) Have performed under such a contract within the past year; or
- (C) Anticipate bidding on such a contract in the future.

For additional information regarding the specific requirements and exemptions, vendors and contractors are encouraged to review Executive Order 24 and *N.C.G.S. § 133-32*.

Executive Order 24 also encouraged and invited other State Agencies to implement the requirements and prohibitions of the Executive Order to their agencies. Vendors and contractors should contact other State Agencies to determine if those agencies have adopted Executive Order 24.

LIABILITY INSURANCE:

(5-20-14)

SP1 G160

Revise the *2012 Standard Specifications* as follows:

Page 1-60, Article 107-15 LIABILITY INSURANCE, line 16, add the following as the second sentence of the third paragraph:

Prior to beginning services, all contractors shall provide proof of coverage issued by a workers' compensation insurance carrier, or a certificate of compliance issued by the Department of Insurance for self-insured subcontractors, irrespective of whether having regularly in service fewer than three employees.

EROSION AND SEDIMENT CONTROL/STORMWATER CERTIFICATION:

(1-16-07) (Rev 11-22-16)

105-16, 225-2, 16

SP1 G180

General

Schedule and conduct construction activities in a manner that will minimize soil erosion and the resulting sedimentation and turbidity of surface waters. Comply with the requirements herein regardless of whether or not a National Pollution discharge Elimination System (NPDES) permit for the work is required.

Establish a chain of responsibility for operations and subcontractors' operations to ensure that the *Erosion and Sediment Control/Stormwater Pollution Prevention Plan* is implemented and maintained over the life of the contract.

- (A) *Certified Supervisor* - Provide a certified Erosion and Sediment Control/Stormwater Supervisor to manage the Contractor and subcontractor operations, insure compliance with Federal, State and Local ordinances and regulations, and manage the Quality Control Program.
- (B) *Certified Foreman* - Provide a certified, trained foreman for each construction operation that increases the potential for soil erosion or the possible sedimentation and turbidity of surface waters.
- (C) *Certified Installer* - Provide a certified installer to install or direct the installation for erosion or sediment/stormwater control practices.
- (D) *Certified Designer* - Provide a certified designer for the design of the erosion and sediment control/stormwater component of reclamation plans and, if applicable, for the design of the project erosion and sediment control/stormwater plan.

Roles and Responsibilities

- (A) *Certified Erosion and Sediment Control/Stormwater Supervisor* - The Certified Supervisor shall be Level II and responsible for ensuring the erosion and sediment control/stormwater plan is adequately implemented and maintained on the project and for conducting the quality control program. The Certified Supervisor shall be on the project within 24 hours notice from initial exposure of an erodible surface to the project's final acceptance. Perform the following duties:
 - (1) *Manage Operations* - Coordinate and schedule the work of subcontractors so that erosion and sediment control/stormwater measures are fully executed for each operation and in a timely manner over the duration of the contract.
 - (a) Oversee the work of subcontractors so that appropriate erosion and sediment control/stormwater preventive measures are conformed to at each stage of the work.
 - (b) Prepare the required National Pollutant Discharge Elimination System (NPDES) Inspection Record and submit to the Engineer.

- (c) Attend all weekly or monthly construction meetings to discuss the findings of the NPDES inspection and other related issues.
 - (d) Implement the erosion and sediment control/stormwater site plans requested.
 - (e) Provide any needed erosion and sediment control/stormwater practices for the Contractor's temporary work not shown on the plans, such as, but not limited to work platforms, temporary construction, pumping operations, plant and storage yards, and cofferdams.
 - (f) Acquire applicable permits and comply with requirements for borrow pits, dewatering, and any temporary work conducted by the Contractor in jurisdictional areas.
 - (g) Conduct all erosion and sediment control/stormwater work in a timely and workmanlike manner.
 - (h) Fully perform and install erosion and sediment control/stormwater work prior to any suspension of the work.
 - (i) Coordinate with Department, Federal, State and Local Regulatory agencies on resolution of erosion and sediment control/stormwater issues due to the Contractor's operations.
 - (j) Ensure that proper cleanup occurs from vehicle tracking on paved surfaces or any location where sediment leaves the Right-of-Way.
 - (k) Have available a set of erosion and sediment control/stormwater plans that are initialed and include the installation date of Best Management Practices. These practices shall include temporary and permanent groundcover and be properly updated to reflect necessary plan and field changes for use and review by Department personnel as well as regulatory agencies.
- (2) Requirements set forth under the NPDES Permit - The Department's NPDES Stormwater permit (NCS000250) outlines certain objectives and management measures pertaining to construction activities. The permit references *NCG010000, General Permit to Discharge Stormwater* under the NPDES, and states that the Department shall incorporate the applicable requirements into its delegated Erosion and Sediment Control Program for construction activities disturbing one or more acres of land. The Department further incorporates these requirements on all contracted bridge and culvert work at jurisdictional waters, regardless of size. Some of the requirements are, but are not limited to:
- (a) Control project site waste to prevent contamination of surface or ground waters of the state, i.e. from equipment operation/maintenance, construction materials, concrete washout, chemicals, litter, fuels, lubricants, coolants, hydraulic fluids, any other petroleum products, and sanitary waste.
 - (b) Inspect erosion and sediment control/stormwater devices and stormwater discharge outfalls at least once every 7 calendar days and within 24 hours after a rainfall event of 0.5 inch that occurs within a 24 hour period. Additional monitoring may be required at the discretion of Division of Water Resources personnel if the receiving stream is 303(d) listed for turbidity and the project has had documented problems managing turbidity.

- (c) Maintain an onsite rain gauge or use the Department's Multi-Sensor Precipitation Estimate website to maintain a daily record of rainfall amounts and dates.
 - (d) Maintain erosion and sediment control/stormwater inspection records for review by Department and Regulatory personnel upon request.
 - (e) Implement approved reclamation plans on all borrow pits, waste sites and staging areas.
 - (f) Maintain a log of turbidity test results as outlined in the Department's Procedure for Monitoring Borrow Pit Discharge.
 - (g) Provide secondary containment for bulk storage of liquid materials.
 - (h) Provide training for employees concerning general erosion and sediment control/stormwater awareness, the Department's NPDES Stormwater Permit NCS000250 requirements, and the applicable requirements of the *General Permit, NCG010000*.
 - (i) Report violations of the NPDES permit to the Engineer immediately who will notify the Division of Water Quality Regional Office within 24 hours of becoming aware of the violation.
- (3) Quality Control Program - Maintain a quality control program to control erosion, prevent sedimentation and follow provisions/conditions of permits. The quality control program shall:
- (a) Follow permit requirements related to the Contractor and subcontractors' construction activities.
 - (b) Ensure that all operators and subcontractors on site have the proper erosion and sediment control/stormwater certification.
 - (c) Notify the Engineer when the required certified erosion and sediment control/stormwater personnel are not available on the job site when needed.
 - (d) Conduct the inspections required by the NPDES permit.
 - (e) Take corrective actions in the proper timeframe as required by the NPDES permit for problem areas identified during the NPDES inspections.
 - (f) Incorporate erosion control into the work in a timely manner and stabilize disturbed areas with mulch/seed or vegetative cover on a section-by-section basis.
 - (g) Use flocculants approved by state regulatory authorities where appropriate and where required for turbidity and sedimentation reduction.
 - (h) Ensure proper installation and maintenance of temporary erosion and sediment control devices.
 - (i) Remove temporary erosion or sediment control devices when they are no longer necessary as agreed upon by the Engineer.
 - (j) The Contractor's quality control and inspection procedures shall be subject to review by the Engineer. Maintain NPDES inspection records and make records available at all times for verification by the Engineer.
- (B) *Certified Foreman* - At least one Certified Foreman shall be onsite for each type of work listed herein during the respective construction activities to control erosion, prevent sedimentation and follow permit provisions:

- (1) Foreman in charge of grading activities
- (2) Foreman in charge of bridge or culvert construction over jurisdictional areas
- (3) Foreman in charge of utility activities

The Contractor may request to use the same person as the Level II Supervisor and Level II Foreman. This person shall be onsite whenever construction activities as described above are taking place. This request shall be approved by the Engineer prior to work beginning.

The Contractor may request to name a single Level II Foreman to oversee multiple construction activities on small bridge or culvert replacement projects. This request shall be approved by the Engineer prior to work beginning.

- (C) *Certified Installers* - Provide at least one onsite, Level I Certified Installer for each of the following erosion and sediment control/stormwater crew:

- (1) Seeding and Mulching
- (2) Temporary Seeding
- (3) Temporary Mulching
- (4) Sodding
- (5) Silt fence or other perimeter erosion/sediment control device installations
- (6) Erosion control blanket installation
- (7) Hydraulic tackifier installation
- (8) Turbidity curtain installation
- (9) Rock ditch check/sediment dam installation
- (10) Ditch liner/matting installation
- (11) Inlet protection
- (12) Riprap placement
- (13) Stormwater BMP installations (such as but not limited to level spreaders, retention/detention devices)
- (14) Pipe installations within jurisdictional areas

If a Level I *Certified Installer* is not onsite, the Contractor may substitute a Level II Foreman for a Level I Installer, provided the Level II Foreman is not tasked to another crew requiring Level II Foreman oversight.

- (D) *Certified Designer* - Include the certification number of the Level III-B Certified Designer on the erosion and sediment control/stormwater component of all reclamation plans and if applicable, the certification number of the Level III-A Certified Designer on the design of the project erosion and sediment control/stormwater plan.

Preconstruction Meeting

Furnish the names of the *Certified Erosion and Sediment Control/Stormwater Supervisor*, *Certified Foremen*, *Certified Installers* and *Certified Designer* and notify the Engineer of changes in certified personnel over the life of the contract within 2 days of change.

Ethical Responsibility

Any company performing work for the North Carolina Department of Transportation has the ethical responsibility to fully disclose any reprimand or dismissal of an employee resulting from improper testing or falsification of records.

Revocation or Suspension of Certification

Upon recommendation of the Chief Engineer to the certification entity, certification for *Supervisor, Certified Foremen, Certified Installers* and *Certified Designer* may be revoked or suspended with the issuance of an *Immediate Corrective Action (ICA), Notice of Violation (NOV)*, or *Cease and Desist Order* for erosion and sediment control/stormwater related issues.

The Chief Engineer may recommend suspension or permanent revocation of certification due to the following:

- (A) Failure to adequately perform the duties as defined within this certification provision.
- (B) Issuance of an ICA, NOV, or Cease and Desist Order.
- (C) Failure to fully perform environmental commitments as detailed within the permit conditions and specifications.
- (D) Demonstration of erroneous documentation or reporting techniques.
- (E) Cheating or copying another candidate's work on an examination.
- (F) Intentional falsification of records.
- (G) Directing a subordinate under direct or indirect supervision to perform any of the above actions.
- (H) Dismissal from a company for any of the above reasons.
- (I) Suspension or revocation of one's certification by another entity.

Suspension or revocation of a certification will be sent by certified mail to the certificant and the Corporate Head of the company that employs the certificant.

A certificant has the right to appeal any adverse action which results in suspension or permanent revocation of certification by responding, in writing, to the Chief Engineer within 10 calendar days after receiving notice of the proposed adverse action.

Chief Engineer
1536 Mail Service Center
Raleigh, NC 27699-1536

Failure to appeal within 10 calendar days will result in the proposed adverse action becoming effective on the date specified on the certified notice. Failure to appeal within the time specified will result in a waiver of all future appeal rights regarding the adverse action taken. The certificant will not be allowed to perform duties associated with the certification during the appeal process.

The Chief Engineer will hear the appeal and make a decision within 7 days of hearing the appeal. Decision of the Chief Engineer will be final and will be made in writing to the certificant.

If a certification is temporarily suspended, the certificant shall pass any applicable written examination and any proficiency examination, at the conclusion of the specified suspension period, prior to having the certification reinstated.

Measurement and Payment

Certified Erosion and Sediment Control/Stormwater Supervisor, Certified Foremen, Certified Installers and Certified Designer will be incidental to the project for which no direct compensation will be made.

PROCEDURE FOR MONITORING BORROW PIT DISCHARGE:

(2-20-07) (Rev. 3-19-13)

105-16, 230, 801

SP1 G181

Water discharge from borrow pit sites shall not cause surface waters to exceed 50 NTUs (nephelometric turbidity unit) in streams not designated as trout waters and 10 NTUs in streams, lakes or reservoirs designated as trout waters. For lakes and reservoirs not designated as trout waters, the turbidity shall not exceed 25 NTUs. If the turbidity exceeds these levels due to natural background conditions, the existing turbidity level shall not be increased.

If during any operating day, the downstream water quality exceeds the standard, the Contractor shall do all of the following:

- (A) Either cease discharge or modify the discharge volume or turbidity levels to bring the downstream turbidity levels into compliance, or
- (B) Evaluate the upstream conditions to determine if the exceedance of the standard is due to natural background conditions. If the background turbidity measurements exceed the standard, operation of the pit and discharge can continue as long as the stream turbidity levels are not increased due to the discharge.
- (C) Measure and record the turbidity test results (time, date and sampler) at all defined sampling locations 30 minutes after startup and at a minimum, one additional sampling of all sampling locations during that 24-hour period in which the borrow pit is discharging.
- (D) Notify DWQ within 24 hours of any stream turbidity standard exceedances that are not brought into compliance.

During the Environmental Assessment required by Article 230-4 of the *2012 Standard Specifications*, the Contractor shall define the point at which the discharge enters into the State's surface waters and the appropriate sampling locations. Sampling locations shall include points upstream and downstream from the point at which the discharge enters these waters. Upstream sampling location shall be located so that it is not influenced by backwater conditions and represents natural background conditions. Downstream sampling location shall be located at the point where complete mixing of the discharge and receiving water has occurred.

The discharge shall be closely monitored when water from the dewatering activities is introduced into jurisdictional wetlands. Any time visible sedimentation (deposition of sediment) on the wetland surface is observed, the dewatering activity will be suspended until turbidity levels in the stilling basin can be reduced to a level where sediment deposition does not occur. Staining of

wetland surfaces from suspended clay particles, occurring after evaporation or infiltration, does not constitute sedimentation. No activities shall occur in wetlands that adversely affect the functioning of a wetland. Visible sedimentation will be considered an indication of possible adverse impacts on wetland use.

The Engineer will perform independent turbidity tests on a random basis. These results will be maintained in a log within the project records. Records will include, at a minimum, turbidity test results, time, date and name of sampler. Should the Department's test results exceed those of the Contractor's test results, an immediate test shall be performed jointly with the results superseding the previous test results of both the Department and the Contractor.

The Contractor shall use the *NCDOT Turbidity Reduction Options for Borrow Pits Matrix*, available at http://www.ncdot.gov/doh/operations/dp_chief_eng/roadside/fieldops/downloads/Files/TurbidityReductionOptionSheet.pdf to plan, design, construct, and maintain BMPs to address water quality standards. Tier I Methods include stilling basins which are standard compensatory BMPs. Other Tier I methods are noncompensatory and shall be used when needed to meet the stream turbidity standards. Tier II Methods are also noncompensatory and are options that may be needed for protection of rare or unique resources or where special environmental conditions exist at the site which have led to additional requirements being placed in the DWQ's 401 Certifications and approval letters, Isolated Wetland Permits, Riparian Buffer Authorization or a DOT Reclamation Plan's Environmental Assessment for the specific site. Should the Contractor exhaust all Tier I Methods on a site exclusive of rare or unique resources or special environmental conditions, Tier II Methods may be required by regulators on a case by case basis per supplemental agreement.

The Contractor may use cation exchange capacity (CEC) values from proposed site borings to plan and develop the bid for the project. CEC values exceeding 15 milliequivalents per 100 grams of soil may indicate a high potential for turbidity and should be avoided when dewatering into surface water is proposed.

No additional compensation for monitoring borrow pit discharge will be paid.

EMPLOYMENT:

(11-15-11) (Rev. 1-17-12)

108, 102

SP1 G184

Revise the *2012 Standard Specifications* as follows:

Page 1-20, Subarticle 102-15(O), delete and replace with the following:

(O) Failure to restrict a former Department employee as prohibited by Article 108-5.

Page 1-65, Article 108-5 Character of Workmen, Methods, and Equipment, line 32, delete all of line 32, the first sentence of the second paragraph and the first word of the second sentence of the second paragraph.

STATE HIGHWAY ADMINISTRATOR TITLE CHANGE:

(9-18-12)

SP1 G185

Revise the *2012 Standard Specifications* as follows:

Replace all references to “State Highway Administrator” with “Chief Engineer”.

SUBLETTING OF CONTRACT:

(11-18-2014)

108-6

SP1 G186

Revise the *2012 Standard Specifications* as follows:

Page 1-66, Article 108-6 Subletting of Contract, line 37, add the following as the second sentence of the first paragraph:

All requests to sublet work shall be submitted within 30 days of the date of availability or prior to expiration of 20% of the contract time, whichever date is later, unless otherwise approved by the Engineer.

Page 1-67, Article 108-6 Subletting of Contract, line 7, add the following as the second sentence of the fourth paragraph:

Purchasing materials for subcontractors is not included in the percentage of work required to be performed by the Contractor. If the Contractor sublets items of work but elects to purchase material for the subcontractor, the value of the material purchased will be included in the total dollar amount considered to have been sublet.

PROJECT SPECIAL PROVISIONS**ROADWAY****CLEARING AND GRUBBING - METHOD III:**

(4-6-06) (Rev.8-18-15)

200

SP2 R02B

Perform clearing on this project to the limits established by Method “III” shown on Standard Drawing No. 200.03 of the *2012 Roadway Standard Drawings*. Conventional clearing methods may be used except where permit drawings or conditions have been included in the proposal which require certain areas to be cleared by hand methods.

SHOULDER AND FILL SLOPE MATERIAL:

(5-21-02)

235, 560

SP2 R45 A

Description

Perform the required shoulder and slope construction for this project in accordance with the applicable requirements of Section 560 and Section 235 of the *2012 Standard Specifications*.

Measurement and Payment

Where the material has been obtained from an authorized stockpile or from a borrow source and *Borrow Excavation* is not included in the contract, no direct payment will be made for this work, as the cost of this work will be part of the work being paid at the contract lump sum price for *Grading*. If *Borrow Excavation* is included in this contract and the material has been obtained from an authorized stockpile or from a borrow source, measurement and payment will be as provided in Section 230 of the *2012 Standard Specifications* for *Borrow Excavation*.

ROCK AND BROKEN PAVEMENT FILLS:

(2-16-16)

235

SP2 R85

Revise the *2012 Standard Specifications* as follows:

Page 2-22, Article 235-2 MATERIALS, add the following after line 19:

Item	Section
Geotextile for Rock and Broken Pavement Fills, Type 2	1056

Provide Type 2 geotextile for filtration geotextiles. Use rip rap and No. 57 stone from either a quarry or onsite material to fill voids in rock and broken pavement fills. Provide small and large size rip rap with stone sizes that meet Class A and B in accordance with Table 1042-1 and No. 57 stone with a gradation that meets Table 1005-1 or use similar size onsite material approved by the Engineer.

Page 2-23, Subarticle 235-3(B) Embankment Formation, lines 18-19, delete the third sentence in the seventh paragraph.

Page 2-23, Subarticle 235-3(B) Embankment Formation, lines 21-23, replace the eighth paragraph with the following:

Before placing embankment fill material or filtration geotextiles over rock and broken pavement, fill voids in the top of rock and broken pavement fill with rip rap and No. 57 stone. Place and compact larger rip rap first followed by smaller rip rap. Then, fill any remaining voids with No. 57 stone so geotextiles are not torn, ripped or otherwise damaged when installed and covered. Compact rip rap and No. 57 stone with tracked equipment or other approved methods. Install filtration geotextiles on top of rock, broken pavement, rip rap and No. 57 stone in accordance with Article 270-3 before placing remaining embankment fill material.

Remove any rocks, debris or pavement pieces from the roadbed larger than 2" within 12" of the subgrade or finished grade, whichever is lower.

Page 2-24, Article 235-5 MEASUREMENT AND PAYMENT, line 13, add the following to the end of the first paragraph:

Payment for rip rap, No. 57 stone and geotextiles to construct embankments with rock and broken pavement fills will be considered incidental to the work in Sections 225, 226, 230 and 240.

BLASTING:

(2-16-16)

220

SP2 R88B

Revise the *2012 Standard Specifications* as follows:

Page 2-8, Article 220-1 DESCRIPTION, line 22, delete "cushion, ".

Page 2-8, Article 220-1 DESCRIPTION, line 23, add the following after the third sentence:

Unless required otherwise in the contract, design blasts for the vibration and air overpressure limits in this section.

Page 2-9, Subarticle 220-3(A) Vibration and Air Overpressure Limits, line 18, add the following to the end of Subarticle 220-3(A):

Unless required otherwise in the contract or directed, design production and trench blasts in accordance with the following:

- (1) Production Blasting
 - (a) For rock cut slopes steeper than 1.5:1 (H:V) without pre-splitting, do not use production blast holes more than 4" in diameter within 10 ft of finished slope faces or neat lines
 - (b) Do not drill production holes below bottom of adjacent pre-split blast holes
 - (c) Use delay blasting to detonate production blast holes towards a free face
- (2) Trench Blasting
 - (a) Do not use trench blast holes more than 3" in diameter
 - (b) Do not use ANFO or other bulk loaded products
 - (c) Use cartridge explosives or other explosive types designed for trench blasting

- (d) Use charges with a diameter of 1/2" to 3/4" less than the trench blast hole diameter

PIPE INSTALLATION:

(11-20-12) (Rev. 8-18-15)

300

SP3 R01

Revise the *2012 Standard Specifications* as follows:

Page 3-1, Article 300-2, Materials, line 15, in the materials table, replace “Flowable Fill” and “Geotextiles” with the following:

Item	Section
Flowable Fill, Excavatable	1000-6
Grout, Type 2	1003
Geotextiles, Type 4	1056

Page 3-1, Article 300-2, Materials, lines 23-24, replace sentence with the following:

Provide foundation conditioning geotextile and geotextile to wrap pipe joints in accordance with Section 1056 for Type 4 geotextile.

Page 3-3, Subarticle 300-6(A), Rigid Pipe, line 2, in the first paragraph, replace “an approved non-shrink grout.” with “grout.” and line 4, in the second paragraph, replace “filtration geotextile” with “geotextile”.

Page 3-3, Article 300-7, Backfilling, lines 37-38, in the first and second sentences of the fifth paragraph, replace “Excavatable flowable fill” with “Flowable fill”.

BRIDGE APPROACH FILLS:

(10-19-10) (Rev. 1-17-12)

422

SP4 R02

Description

Bridge approach fills include bridge approach fills for sub regional tier bridges and reinforced bridge approach fills. Construct bridge approach fills in accordance with the contract and Standard Drawing No. 422.10 or 422.11 of the *2012 Roadway Standard Drawings*. Define “geosynthetics” as geotextiles or geomembranes.

Materials

Refer to Division 10 of the *2012 Standard Specifications*.

Item	Section
Anchor Pins	1056-2
Geotextiles	1056
Portland Cement Concrete	1000
Select Material	1016
Subsurface Drainage Materials	1044
Wire Staples	1060-8(D)

For bridge approach fills for sub regional tier bridges, provide Type 1 geotextile for filtration geotextiles. For reinforced bridge approach fills, provide Type 5 geotextile for geotextile

reinforcement and Type 1 geotextile and No. 78M stone for drains. Use Class B concrete for concrete pads.

Use Class III or V select material for reinforced bridge approach fills and only Class V select material (standard size No. 78M stone) for bridge approach fills for sub regional tier bridges. Provide PVC pipes, fittings and outlet pipes for subsurface drainage materials. For drains and PVC pipes behind end bents, use pipes with perforations that meet AASHTO M 278.

Use PVC, HDPE or linear low density polyethylene (LLDPE) geomembranes for reinforced bridge approach fills. For PVC geomembranes, provide grade PVC30 geomembranes that meet ASTM D7176. For HDPE and LLDPE geomembranes, use geomembranes with a nominal thickness of at least 30 mils that meet Geosynthetic Research Institute Standard Specifications GM13 or GM17, respectively. Handle and store geomembranes in accordance with Article 1056-2 of the *2012 Standard Specifications*. Provide material certifications for geomembranes in accordance with Article 1056-3 of the *2012 Standard Specifications*.

Construction Methods

Excavate as necessary for bridge approach fills in accordance with the contract. Notify the Engineer when foundation excavation is complete. Do not place geomembranes or filtration geotextiles until excavation dimensions and foundation material are approved. Attach geomembranes and filtration geotextiles to end bent cap back and wing walls with adhesives, tapes or other approved methods. Glue or weld geomembrane seams to prevent leakage.

For reinforced bridge approach fills, place geotextile reinforcement within 3" of locations shown in Standard Drawing No. 422.10 of the *2012 Roadway Standard Drawings* and in slight tension free of kinks, folds, wrinkles or creases. Install geotextile reinforcement with the orientation, dimensions and number of layers shown in Standard Drawing No. 422.10 of the *2012 Roadway Standard Drawings*. Place first layer of geotextile reinforcement directly on geomembranes with no void or material in between. Install geotextile reinforcement with the machine direction (MD) parallel to the roadway centerline. The MD is the direction of the length or long dimension of the geotextile roll. Do not splice or overlap geotextile reinforcement in the MD so seams are perpendicular to the roadway centerline. Wrap geotextile reinforcement at end bent cap back and wing walls as shown in Standard Drawing No. 422.10 of the *2012 Roadway Standard Drawings* and directed by the Engineer. Extend geotextile reinforcement at least 4 ft back behind end bent cap back and wing walls into select material.

Overlap adjacent geotextiles at least 18" with seams oriented parallel to the roadway centerline. Hold geotextiles in place with wire staples or anchor pins as needed. Contact the Engineer when existing or future obstructions such as foundations, pavements, pipes, inlets or utilities will interfere with geosynthetics.

For reinforced bridge approach fills, construct one foot square drains consisting of 4" diameter continuous perforated PVC pipes surrounded by No. 78M stone wrapped in Type 1 geotextiles. Install drains in accordance with Standard Drawing No. 422.10 of the *2012 Roadway Standard Drawings*. For bridge approach fills for sub regional tier bridges, install 4" diameter continuous perforated PVC drain pipes in accordance with Standard Drawing No. 422.11 of the *2012 Roadway Standard Drawings*.

Use solvent cement to connect PVC pipes so joints do not leak. Connect perforated pipes to outlet pipes just behind wing walls. Provide drain pipes and drains with positive drainage towards outlets. Place pipe sleeves in or under wing walls for outlet pipes so positive drainage is maintained. Use sleeves that can withstand wing wall loads.

Place select material in 8" to 10" thick lifts. Use only hand operated compaction equipment to compact select material for bridge approach fills. Compact Class III select material in accordance with Subarticle 235-3(C) of the *2012 Standard Specifications*. Compact No. 78M stone with a vibratory compactor to the satisfaction of the Engineer. Do not displace or damage geosynthetics, drain pipes or drains when placing and compacting select material. End dumping directly on geosynthetics is not permitted. Do not operate heavy equipment on geosynthetics, drain pipes or drains until they are covered with at least 8" of select material. Replace any damaged geosynthetics, drain pipes or drains to the satisfaction of the Engineer.

Cover open ends of outlet pipes with rodent screens as shown in Standard Drawing No. 815.03 of the *2012 Roadway Standard Drawings*. Connect ends of outlet pipes to concrete pads or existing drainage structures as directed by the Engineer. Construct concrete pads with an Ordinary surface finish that meets Subarticle 825-6(B) of the *2012 Standard Specifications*.

Measurement and Payment

Reinforced Bridge Approach Fill, Station ____ will be paid at the contract lump sum price. The contract lump sum price for *Reinforced Bridge Approach Fill, Station ____* will be full compensation for labor, tools, equipment and reinforced bridge approach fill materials, excavating, backfilling, hauling and removing excavated materials, compacting select material, connecting outlet pipes to existing drainage structures and supplying select materials, geosynthetics, drains, pipe sleeves and outlet components and any incidentals necessary to construct all reinforced bridge approach fills at each bridge.

Bridge Approach Fill - Sub Regional Tier, Station ____ will be paid at the contract lump sum price. The contract lump sum price for *Bridge Approach Fill - Sub Regional Tier, Station ____* will be full compensation for labor, tools, equipment and bridge approach fill materials, excavating, backfilling, hauling and removing excavated materials, compacting No. 78M stone, connecting outlet pipes to existing drainage structures and supplying No. 78M stone, filtration geotextiles, drain pipes, pipe sleeves and outlet components and any incidentals necessary to construct all bridge approach fills at each sub regional tier bridge.

Payment will be made under:

Pay Item

Reinforced Bridge Approach Fill, Station ____
 Bridge Approach Fill - Sub Regional Tier, Station ____

Pay Unit

Lump Sum
 Lump Sum

ASPHALT PAVEMENTS - SUPERPAVE:

(6-19-12) (Rev. 8-16-16)

605, 609, 610, 650

SP6 R01

Revise the 2012 *Standard Specifications* as follows:

Page 6-3, Article 605-7, APPLICATION RATES AND TEMPERATURES, replace this article, including Table 605-1, with the following:

Apply tack coat uniformly across the existing surface at target application rates shown in Table 605-1.

Existing Surface	Target Rate (gal/sy)
	Emulsified Asphalt
New Asphalt	0.04 ± 0.01
Oxidized or Milled Asphalt	0.06 ± 0.01
Concrete	0.08 ± 0.01

Apply tack coat at a temperature within the ranges shown in Table 605-2. Tack coat shall not be overheated during storage, transport or at application.

Asphalt Material	Temperature Range
Asphalt Binder, Grade PG 64-22	350 - 400°F
Emulsified Asphalt, Grade RS-1H	130 - 160°F
Emulsified Asphalt, Grade CRS-1	130 - 160°F
Emulsified Asphalt, Grade CRS-1H	130 - 160°F
Emulsified Asphalt, Grade HFMS-1	130 - 160°F
Emulsified Asphalt, Grade CRS-2	130 - 160°F

Page 6-6, Subarticle 607-5(A), Milled Asphalt Pavement, line 25, add the following to the end of the paragraph:

Areas to be paid under these items include mainline, turn lanes, shoulders, and other areas milled in conjunction with the mainline and any additional equipment necessary to remove pavement in the area of manholes, water valves, curb, gutter and other obstructions.

Page 6-6, Subarticle 607-5(C), Incidental Milling, lines 42-48, replace the paragraph with the following:

Incidental Milling to be paid will be the actual number of square yards of surface milled where the Contractor is required to mill butt joints, irregular areas and intersections milled as a separate operation from mainline milling and re-mill areas that are not due to the Contractor's negligence whose length is less than 100 feet. Measurement will be made as provided in Subarticle 607-5(A) for each cut the Contractor is directed to perform. Where the Contractor elects to make multiple cuts to achieve the final depth, no additional measurement will be made. Compensation will be made at the contract unit price per square yard for *Incidental Milling*.

Page 6-7, Article 609-3, FIELD VERIFICATION OF MIXTURE AND JOB MIX FORMULA ADJUSTMENTS, lines 35-37, delete the second sentence of the second paragraph.

Page 6-18, Article 610-1 DESCRIPTION, lines 40-41, delete the last sentence of the last paragraph.

Page 6-19, Subarticle 610-3(A), Mix Design-General, line 5, add the following as the first paragraph:

Warm mix asphalt (WMA) is allowed for use at the Contractor's option in accordance with the NCDOT Approved Products List for WMA Technologies available at:

<https://connect.ncdot.gov/resources/Materials/MaterialsResources/Warm%20Mix%20Asphalt%20Approved%20List.pdf>

Page 6-20, Subarticle 610-3(C), Job Mix Formula (JMF), lines 47-48, replace the last sentence of the third paragraph with the following:

The JMF mix temperature shall be within the ranges shown in Table 610-1 unless otherwise approved.

Page 6-21, Subarticle 610-3(C) Job Mix Formula (JMF), replace Table 610-1 with the following:

TABLE 610-1 MIXING TEMPERATURE AT THE ASPHALT PLANT	
Binder Grade	JMF Mix Temperature
PG 58-28; PG 64-22	250 - 290°F
PG 70-22	275- 305°F
PG 76-22	300- 325°F

Page 6-21, Subarticle 610-3(C) Job Mix Formula (JMF), lines 1-2, in the first sentence of the first paragraph, delete "and compaction". Lines 4-7, delete the second paragraph and replace with the following:

When RAS is used, the JMF mix temperature shall be established at 275°F or higher.

Page 6-22, Article 610-4, WEATHER, TEMPERATURE AND SEASONAL LIMITATIONS FOR PRODUCING AND PLACING ASPHALT MIXTURES, lines 15-17, replace the second sentence of the first paragraph with the following:

Do not place asphalt material when the air or surface temperatures, measured at the location of the paving operation away from artificial heat, do not meet Table 610-5.

Page 6-23, Article 610-4, WEATHER, TEMPERATURE AND SEASONAL LIMITATIONS FOR PRODUCING AND PLACING ASPHALT MIXTURES, replace Table 610-5 with the following:

Asphalt Concrete Mix Type	Minimum Surface and Air Temperature
B25.0B, C	35°F
I19.0B, C, D	35°F
SF9.5A, S9.5B	40°F ^A
S9.5C, S12.5C	45°F ^A
S9.5D, S12.5D	50°F

- A. For the final layer of surface mixes containing recycled asphalt shingles (RAS), the minimum surface and air temperature shall be 50°F.

Page 6-23, Subarticle 610-5(A), General, lines 33-34, replace the last sentence of the third paragraph with the following:

Produce the mixture at the asphalt plant within ± 25 °F of the JMF mix temperature. The temperature of the mixture, when discharged from the mixer, shall not exceed 350°F.

Page 6-26, Article 610-7, HAULING OF ASPHALT MIXTURE, lines 22-23, in the fourth sentence of the first paragraph replace “so as to overlap the top of the truck bed and” with “to”. Line 28, in the last paragraph, replace “+15 °F to -25 °F of the specified JMF temperature.” with “ ± 25 °F of the specified JMF mix temperature.”

Page 6-26, Article 610-8, SPREADING AND FINISHING, line 34, add the following new paragraph:

As referenced in Section 9.6.3 of the *HMA/QMS Manual*, use the automatic screed controls on the paver to control the longitudinal profile. Where approved by the Engineer, the Contractor has the option to use either a fixed or mobile string line.

Page 6-29, Article 610-13, FINAL SURFACE TESTING AND ACCEPTANCE, line 39, add the following after the first sentence in the first paragraph:

Smoothness acceptance testing using the inertial profiler is not required on ramps, loops and turn lanes.

Page 6-30, Subarticle 610-13(A), Option 1 – Inertial Profiler, lines 15-16, replace the fourth sentence of the fourth paragraph with the following:

The interval at which relative profile elevations are reported shall be 2”.

Page 6-30, Subarticle 610-13(A), Option 1 – Inertial Profiler, lines 25-28, replace the ninth paragraph with the following:

Operate the profiler at any speed as per the manufacturer’s recommendations to collect valid data.

Page 6-30, Subarticle 610-13(A), Option 1 – Inertial Profiler, lines 30-31, delete the third sentence of the tenth paragraph.

Page 6-31, Subarticle 610-13(A), Option 1 – Inertial Profiler, lines 11-13, replace the first sentence of the third paragraph with the following:

After testing, transfer the profile data from the profiler portable computer’s hard drive to a write once storage media (Flash drive, USB, DVD-R or CD-R) or electronic media approved by the Engineer.

Page 6-31, Subarticle 610-13(A), Option 1 – Inertial Profiler, lines 17-18, replace the first sentence of the fourth paragraph with the following:

Submit a report with the documentation and electronic data of the evaluation for each section to the Engineer within 10 days after completion of the smoothness testing. The report shall be in the tabular format for each 0.10 segment or a portion thereof with a summary of the MRI values and the localized roughness areas including corresponding project station numbers or acceptable reference points. Calculate the pay adjustments for all segments in accordance with the formulas in Sections (1) and (2) shown below. The Engineer shall review and approval all pay adjustments unless corrective action is required.

Page 6-31, Subarticle 610-13(A)(1), Acceptance for New Construction, lines 36-37, replace the third paragraph with the following:

The price adjustment will apply to each 0.10-mile section or prorated for a portion thereof, based on the Mean Roughness Index (MRI), the average IRI values from both wheel paths.

Page 6-32, Subarticle 610-13(A)(2), Localized Roughness, lines 12-16, replace the first paragraph with the following:

Areas of localized roughness shall be identified through the “Smoothness Assurance Module (SAM)” provided in the ProVAL software. Use the SAM report to optimize repair strategies by analyzing the measurements from profiles collected using inertial profilers. The ride quality threshold for localized roughness shall be 165 in/mile for any sections that are 15 ft. to 100 ft. in length at the continuous short interval of 25 ft. Submit a continuous roughness report to identify each section with project station numbers or reference points outside the threshold and identify all localized roughness, with the signature of the Operator included with the submitted IRI trace and electronic files.

Page 6-32, Subarticle 610-13(A)(2), Localized Roughness, line 21, add the following new paragraph:

If the Engineer does not require corrective action, the pay adjustment for each area of localized roughness shall be based on the following formula:

$$PA = (165 - LR\#) 5$$

Where:

$$PA = \text{Pay Adjustment (dollars)}$$

$$LR\# = \text{The Localized Roughness number determined from SAM report for the ride quality threshold}$$

Page 6-41, Subarticle 650-3(B), Mix Design Criteria, replace Table 650-1 with the following:

TABLE 650-1 OGAFC GRADATION CRITERIA			
<i>Sieve Size (mm)</i>	<i>Type FC-1</i>	<i>Type FC-1 Modified</i>	<i>Type FC-2 Modified</i>
19.0	-	-	100
12.5	100	100	80 - 100
9.50	75 - 100	75 - 100	55 - 80
4.75	25 - 45	25 - 45	15 - 30
2.36	5 - 15	5 - 15	5 - 15
0.075	1.0 - 3.0	1.0 - 3.0	2.0 - 4.0

ASPHALT BINDER CONTENT OF ASPHALT PLANT MIXES:

(11-21-00) (Rev. 7-17-12)

609

SP6 R15

The approximate asphalt binder content of the asphalt concrete plant mixtures used on this project will be as follows:

Asphalt Concrete Base Course	Type B 25.0__	4.4%
Asphalt Concrete Intermediate Course	Type I 19.0__	4.8%
Asphalt Concrete Surface Course	Type S 4.75A	6.8%
Asphalt Concrete Surface Course	Type SA-1	6.8%
Asphalt Concrete Surface Course	Type SF 9.5A	6.7%
Asphalt Concrete Surface Course	Type S 9.5__	6.0%
Asphalt Concrete Surface Course	Type S 12.5__	5.6%

The actual asphalt binder content will be established during construction by the Engineer within the limits established in the *2012 Standard Specifications*.

PRICE ADJUSTMENT - ASPHALT BINDER FOR PLANT MIX:

(11-21-00)

620

SP6 R25

Price adjustments for asphalt binder for plant mix will be made in accordance with Section 620 of the *2012 Standard Specifications*.

The base price index for asphalt binder for plant mix is **\$ 366.00** per ton.

This base price index represents an average of F.O.B. selling prices of asphalt binder at supplier's terminals on **September 1, 2017**.

FINAL SURFACE TESTING NOT REQUIRED:

(5-18-04) (Rev. 2-16-16)

610

SP6 R45

Final surface testing is not required on this project in accordance with Section 610-13, *Final Surface Testing and Acceptance*.

GUARDRAIL END UNITS, TYPE - TL-3:

(4-20-04) (Rev. 7-1-17)

862

SP8 R65

Description

Furnish and install guardrail end units in accordance with the details in the plans, the applicable requirements of Section 862 of the *2012 Standard Specifications*, and at locations shown in the plans.

Materials

Furnish guardrail end units listed on the NCDOT Approved Products List at <https://apps.dot.state.nc.us/vendor/approvedproducts/> or approved equal.

Prior to installation the Contractor shall submit to the Engineer:

- (A) FHWA acceptance letter for each guardrail end unit certifying it meets the requirements of the AASHTO Manual for Assessing Safety Hardware, Test Level 3, in accordance with Article 106-2 of the *2012 Standard Specifications*.
- (B) Certified working drawings and assembling instructions from the manufacturer for each guardrail end unit in accordance with Article 105-2 of the *2012 Standard Specifications*.

No modifications shall be made to the guardrail end unit without the express written permission from the manufacturer. Perform installation in accordance with the details in the plans, and details and assembling instructions furnished by the manufacturer.

Construction Methods

Guardrail end delineation is required on all approach and trailing end sections for both temporary and permanent installations. Guardrail end delineation consists of yellow reflective sheeting applied to the entire end section of the guardrail in accordance with Article 1088-3 of the *2012 Standard Specifications* and is incidental to the cost of the guardrail end unit.

Measurement and Payment

Measurement and payment will be made in accordance with Article 862-6 of the *2012 Standard Specifications*.

Payment will be made under:

Pay Item

Guardrail End Units, Type TL-3

Pay Unit

Each

MATERIALS:

(2-21-12) (Rev. 11-22-16)

1000, 1002, 1005, 1016, 1018, 1024, 1050, 1074, 1078, 1080, 1081, 1086, 1084, 1087, 1092

SP10 R01

Revise the *2012 Standard Specifications* as follows:

Page 10-1, Article 1000-1, DESCRIPTION, lines 9-10, replace the last sentence of the first paragraph with the following:

Type IL, IP, IS or IT blended cement may be used instead of Portland cement.

Page 10-1, Article 1000-1, DESCRIPTION, line 14, add the following:

If any change is made to the mix design, submit a new mix design (with the exception of an approved pozzolan source change).

If any major change is made to the mix design, also submit new test results showing the mix design conforms to the criteria. Define a major change to the mix design as:

- (1) A source change in coarse aggregate, fine aggregate or cement.
- (2) A pozzolan class or type change (e.g. Class F fly ash to Class C fly ash).
- (3) A quantitative change in coarse aggregate (applies to an increase or decrease greater than 5%), fine aggregate (applies to an increase or decrease greater than 5%), water (applies to an increase only), cement (applies to a decrease only), or pozzolan (applies to an increase or decrease greater than 5%).

Use materials which do not produce a mottled appearance through rusting or other staining of the finished concrete surface.

Page 10-1, Article 1000-2, MATERIALS, line 16; Page 10-8, Subarticle 1000-7(A), Materials, line 8; and Page 10-18, Article 1002-2, MATERIALS, line 9, add the following to the table of item references:

Item	Section
Type IL Blended Cement	1024-1

Page 10-1, Subarticle 1000-3(A), Composition and Design, lines 25-27, replace the second paragraph with the following:

Fly ash may be substituted for cement in the mix design up to 30% at a rate of 1.0 lb of fly ash to each pound of cement replaced.

Page 10-2, Subarticle 1000-3(A), Composition and Design, lines 12-21, delete the third paragraph through the sixth paragraph beginning with “If any change is made to the mix design, submit...” through “...(applies to a decrease only).”

Page 10-5, Table 1000-1, REQUIREMENTS FOR CONCRETE, replace with the following:

TABLE 1000-1 REQUIREMENTS FOR CONCRETE											
Class of Concrete	Min. Comp. Strength at 28 days	Maximum Water-Cement Ratio				Consistency Max. Slump		Cement Content			
		Air-Entrained Concrete		Non Air-Entrained Concrete		Vibrated	Non-Vibrated	Vibrated		Non-Vibrated	
		Rounded Aggregate	Angular Aggregate	Rounded Aggregate	Angular Aggregate			Min.	Max.	Min.	Max.
Units	psi					inch	inch	lb/cy	lb/cy	lb/cy	lb/cy
AA	4,500	0.381	0.426	-	-	3.5	-	639	715	-	-
AA Slip Form	4,500	0.381	0.426	-	-	1.5	-	639	715	-	-
Drilled Pier	4,500	-	-	0.450	0.450	-	5-7 dry 7-9 wet	-	-	640	800
A	3,000	0.488	0.532	0.550	0.594	3.5	4	564	-	602	-
B	2,500	0.488	0.567	0.559	0.630	1.5 machine-placed 2.5 hand-placed	4	508	-	545	-
Sand Light-weight	4,500	-	0.420	-	-	4	-	715	-	-	-
Latex Modified	3,000 7 day	0.400	0.400	-	-	6	-	658	-	-	-
Flowable Fill excavatable	150 max. at 56 days	as needed	as needed	as needed	as needed	-	Flow-able	-	-	40	100
Flowable Fill non-excavatable	125	as needed	as needed	as needed	as needed	-	Flow-able	-	-	100	as needed
Pavement	4,500 design, field 650 flexural, design only	0.559	0.559	-	-	1.5 slip form 3.0 hand place	-	526	-	-	-
Precast	See Table 1077-1	as needed	as needed	-	-	6	as needed	as needed	as needed	as needed	as needed
Prestress	per contract	See Table 1078-1	See Table 1078-1	-	-	8	-	564	as needed	-	-

Page 10-6, Subarticle 1000-4(I), Use of Fly Ash, lines 36-2, replace the first paragraph with the following:

Fly ash may be substituted for cement in the mix design up to 30% at a rate of 1.0 lb of fly ash to each pound of cement replaced. Use Table 1000-1 to determine the maximum allowable water-cementitious material (cement + fly ash) ratio for the classes of concrete listed.

Page 10-7, Table 1000-3, MAXIMUM WATER-CEMENTITIOUS MATERIAL RATIO, delete the table.

Page 10-7, Article 1000-5, HIGH EARLY STRENGTH PORTLAND CEMENT CONCRETE, lines 30-31, delete the second sentence of the third paragraph.

Page 10-19, Article 1002-3, SHOTCRETE FOR TEMPORARY SUPPORT OF EXCAVATIONS, line 30, add the following at the end of Section 1002:

(H) Handling and Storing Test Panels

Notify the Area Materials Engineer when preconstruction or production test panels are made within 24 hours of shooting the panels. Field cure and protect test panels from damage in accordance with ASTM C1140 until the Department transports panels to the Materials and Tests Regional Laboratory for coring.

Page 10-23, Table 1005-1, AGGREGATE GRADATION-COARSE AGGREGATE, replace with the following:

TABLE 1005-1 AGGREGATE GRADATION - COARSE AGGREGATE													
Percentage of Total by Weight Passing													
Std. Size #	2"	1 1/2"	1"	3/4"	1/2"	3/8"	#4	#8	#10	#16	#40	#200	Remarks
4	100	90-100	20-55	0-15	-	0-5	-	-	-	-	-	A	Asphalt Plant Mix
467M	100	95-100	-	35-70	-	0-30	0-5	-	-	-	-	A	Asphalt Plant Mix
5	-	100	90-100	20-55	0-10	0-5	-	-	-	-	-	A	AST, Sediment Control Stone
57	-	100	95-100	-	25-60	-	0-10	0-5	-	-	-	A	AST, Structural Concrete, Shoulder Drain Stone, Sediment Control Stone
57M	-	100	95-100	-	25-45	-	0-10	0-5	-	-	-	A	AST, Concrete Pavement
6M	-	-	100	90-100	20-55	0-20	0-8	-	-	-	-	A	AST
67	-	-	100	90-100	-	20-55	0-10	0-5	-	-	-	A	Asphalt Plant Mix, AST, Structural Concrete
78M	-	-	-	100	98-100	75-100	20-45	0-15	-	-	-	A	Asphalt Plant Mix, AST, Structural Concrete, Weep Hole Drains
14M	-	-	-	-	100	98-100	35-70	5-20	-	0-8	-	A	Asphalt Plant Mix, AST, Structural Concrete, Weep Hole Drains
9M	-	-	-	-	100	98-100	85-100	10-40	-	0-10	-	A	AST
ABC	-	100	75-97	-	55-80	-	35-55	-	25-45	-	14-30	4-12 ^B	Aggregate Base Course, Aggregate Stabilization
ABC(M)	-	100	75-100	-	45-79	-	20-40	-	0-25	-	-	0-12 ^B	Maintenance Stabilization
Light-weight ^C	-	-	-	-	100	80-100	5-40	0-20	-	0-10	-	0-2.5	AST

- A. See Subarticle 1005-4(A).
- B. See Subarticle 1005-4(B).
- C. For Lightweight Aggregate used in Structural Concrete, see Subarticle 1014-2(E)(6).

Page 10-39, Article 1016-3, CLASSIFICATIONS, lines 27-32, replace with the following:

Select material is clean, unweathered durable, blasted rock material obtained from an approved source. While no specific gradation is required, the below criteria will be used to evaluate the materials for visual acceptance by the Engineer:

- (A) At least 50% of the rock has a diameter of from 1.5 ft to 3 ft,
- (B) 30% of the rock ranges in size from 2" to 1.5 ft in diameter, and
- (C) Not more than 20% of the rock is less than 2" in diameter. No rippable rock will be permitted.

Page 10-40, Tables 1018-1 and 1018-2, PIEDMONT, WESTERN AND COASTAL AREA CRITERIA FOR ACCEPTANCE OF BORROW MATERIAL, under second column in both tables, replace second row with the following:

Acceptable, but not to be used in the top 3 ft of embankment or backfill

Page 10-46, Article 1024-1, PORTLAND CEMENT, line 33, add the following as the ninth paragraph:

Use Type IL blended cement that meets AASHTO M 240, except that the limestone content is limited to between 5 and 12% by weight and the constituents shall be interground. Class F fly ash can replace a portion of Type IL blended cement and shall be replaced as outlined in Subarticle 1000-4(I) for Portland cement. For mixes that contain cement with alkali content between 0.6% and 1.0% and for mixes that contain a reactive aggregate documented by the Department, use a pozzolan in the amount shown in Table 1024-1.

Page 10-46, Table 1024-1, POZZOLANS FOR USE IN PORTLAND CEMENT CONCRETE, replace with the following:

TABLE 1024-1 POZZOLANS FOR USE IN PORTLAND CEMENT CONCRETE	
Pozzolan	Rate
Class F Fly Ash	20% - 30% by weight of required cement content with 1.0 lb Class F fly ash per lb of cement replaced
Ground Granulated Blast Furnace Slag	35%-50% by weight of required cement content with 1.0 lb slag per lb of cement replaced
Microsilica	4%-8% by weight of required cement content with 1.0 lb microsilica per lb of cement replaced

Page 10-47, Subarticle 1024-3(B), Approved Sources, lines 16-18, replace the second sentence of the second paragraph with the following:

Tests shall be performed by AASHTO's designated National Transportation Product Evaluation Program (NTPEP) laboratory for concrete admixture testing.

Page 10-65, Article 1050-1, GENERAL, line 41, replace the first sentence with the following:

All fencing material and accessories shall meet Section 106.

Page 10-115, Subarticle 1074-7(B), Gray Iron Castings, lines 10-11, replace the first two sentences with the following:

Supply gray iron castings meeting all facets of AASHTO M 306 excluding proof load. Proof load testing will only be required for new casting designs during the design process, and conformance to M306 loading (40,000 lb.) will be required only when noted on the design documents.

Page 10-126, Table 1078-1, REQUIREMENTS FOR CONCRETE, replace with the following:

Property	28 Day Design Compressive Strength 6,000 psi or less	28 Day Design Compressive Strength greater than 6,000 psi
Maximum Water/Cementitious Material Ratio	0.45	0.40
Maximum Slump without HRWR	3.5"	3.5"
Maximum Slump with HRWR	8"	8"
Air Content (upon discharge into forms)	5 + 2%	5 + 2%

Page 10-151, Article 1080-4, INSPECTION AND SAMPLING, lines 18-22, replace (B), (C) and (D) with the following:

- (B) At least 3 panels prepared as specified in 5.5.10 of AASHTO M 300, Bullet Hole Immersion Test.
- (C) At least 3 panels of 4"x6"x1/4" for the Elcometer Adhesion Pull Off Test, ASTM D4541.
- (D) A certified test report from an approved independent testing laboratory for the Salt Fog Resistance Test, Cyclic Weathering Resistance Test, and Bullet Hole Immersion Test as specified in AASHTO M 300.
- (E) A certified test report from an approved independent testing laboratory that the product has been tested for slip coefficient and meets AASHTO M253, Class B.

Page 10-161, Subarticle 1081-1(A), Classifications, lines 29-33, delete first 3 sentences of the description for Type 2 and replace with the following:

Type 2 - A low-modulus, general-purpose adhesive used in epoxy mortar repairs. It may be used to patch spalled, cracked or broken concrete where vibration, shock or expansion and contraction are expected.

Page 10-162, Subarticle 1081-1(A), Classifications, lines 4-7, delete the second and third sentences of the description for Type 3A. **Lines 16-22,** delete Types 6A, 6B and 6C.

Page 10-162, Subarticle 1081-1(B), Requirements, lines 26-30, replace the second paragraph with the following:

For epoxy resin systems used for embedding dowel bars, threaded rods, rebar, anchor bolts and other fixtures in hardened concrete, the manufacturer shall submit test results showing that the bonding system will obtain 125% of the specified required yield strength of the fixture. Furnish certification that, for the particular bolt grade, diameter and embedment depth required, the anchor system will not fail by adhesive failure and that there is no movement of the anchor bolt. For certification and anchorage, use 3,000 psi as the minimum Portland cement concrete compressive strength used in this test. Use adhesives that meet Section 1081.

List the properties of the adhesive on the container and include density, minimum and maximum temperature application, setting time, shelf life, pot life, shear strength and compressive strength.

Page 10-163, Table 1081-1, PROPERTIES OF MIXED EPOXY RESIN SYSTEMS, replace with the following:

TABLE 1081-1 PROPERTIES OF MIXED EPOXY RESIN SYSTEMS							
Property	Type 1	Type 2	Type 3	Type 3A	Type 4A	Type 4B	Type 5
Viscosity-Poises at 77°F ± 2°F	Gel	10-30	25-75	Gel	40-150	40-150	1-6
Spindle No.	-	3	4	--	4	4	2
Speed (RPM)	-	20	20	--	10	10	50
Pot Life (Minutes)	20-50	30-60	20-50	5-50	40-80	40-80	20-60
Minimum Tensile Strength at 7 days (psi)	1,500	2,000	4,000	4,000	1,500	1,500	4,000
Tensile Elongation at 7 days (%)	30 min.	30 min.	2-5	2-5	5-15	5-15	2-5
Min. Compressive Strength of 2" mortar cubes at 24 hours	3,000 (Neat)	4,000-	6,000-	6,000 (Neat)	3,000	3,000	6,000
Min. Compressive Strength of 2" mortar cubes at 7 days	5,000 (Neat)	-	-	-	-	5,000	-
Maximum Water Absorption (%)	1.5	1.0	1.0	1.5	1.0	1.0	1.0
Min. Bond Strength Slant Shear Test at 14 days (psi)	1,500	1,500	2,000	2,000	1,500	1,500	1,500

Page 10-164, Subarticle 1081-1(E), Prequalification, lines 31-33, replace the second sentence of the first paragraph with the following:

Manufacturers choosing to supply material for Department jobs must submit an application through the Value Management Unit with the following information for each type and brand name:

Page 10-164, Subarticle 1081-1(E)(3), line 37, replace with the following:

(3) Type of the material in accordance with Articles 1081-1 and 1081-4,

Page 10-165, Subarticle 1081-1(E)(6), line 1, in the first sentence of the first paragraph replace “AASHTO M 237” with “the specifications”.

Page 10-165, Subarticle 1081-1(E), Prequalification, line 9-10, delete the second sentence of the last paragraph.

Page 10-165, Subarticle 1081-1(F), Acceptance, line 14, in the first sentence of the first paragraph replace “Type 1” with “Type 3”.

Page 10-169, Subarticle 1081-3(G), Anchor Bolt Adhesives, delete this subarticle.

Page 10-170, Article 1081-3, HOT BITUMEN, line 9, add the following at the end of Section 1081:

1081-4 EPOXY RESIN ADHESIVE FOR BONDING TRAFFIC MARKINGS

(A) General

This section covers epoxy resin adhesive for bonding traffic markers to pavement surfaces.

(B) Classification

The types of epoxies and their uses are as shown below:

Type I – Rapid Setting, High Viscosity, Epoxy Adhesive. This type of adhesive provides rapid adherence to traffic markers to the surface of pavement.

Type II – Standard Setting, High Viscosity, Epoxy Adhesive. This type of adhesive is recommended for adherence of traffic markers to pavement surfaces when rapid set is not required.

Type III – Rapid Setting, Low Viscosity, Water Resistant, Epoxy Adhesive. This type of rapid setting adhesive, due to its low viscosity, is appropriate only for use with embedded traffic markers.

Type IV – Standard Set Epoxy for Blade Deflecting-Type Plowable Markers.

(C) Requirements

Epoxies shall conform to the requirements set forth in AASHTO M 237.

(D) Prequalification

Refer to Subarticle 1081-1(E).

(E) Acceptance

Refer to Subarticle 1081-1(F).

Page 10-173, Article 1084-2, STEEL SHEET PILES, lines 37-38, replace first paragraph with the following:

Steel sheet piles detailed for permanent applications shall be hot rolled and meet ASTM A572 or ASTM A690 unless otherwise required by the plans. Steel sheet piles shall be coated as required by the plans. Galvanized sheet piles shall be coated in accordance with Section 1076.

Metallized sheet piles shall be metallized in accordance to the Project Special Provision “Thermal Sprayed Coatings (Metallization)” with an 8 mil, 99.9% aluminum alloy coating and a 0.5 mil seal coating. Any portion of the metallized sheet piling encased in concrete shall receive a barrier coat. The barrier coat shall be an approved waterborne coating with a low-

viscosity which readily absorbs into the pores of the aluminum thermal sprayed coating. The waterborne coating shall be applied at a spreading rate that results in a theoretical 1.5 mil dry film thickness. The manufacturer shall issue a letter of certification that the resin chemistry of the waterborne coating is compatible with the 99.9% aluminum thermal sprayed alloy and suitable for tidal water applications.

Page 10-174, Subarticle 1086-1(B)(1), Epoxy, lines 18-24, replace with the following:

The epoxy shall meet Article 1081-4.

The 2 types of epoxy adhesive which may be used are Type I, Rapid Setting, and Type II, Standard Setting. Use Type II when the pavement temperature is above 60°F or per the manufacturer's recommendations whichever is more stringent. Use Type I when the pavement temperature is between 50°F and 60°F or per the manufacturer's recommendations whichever is more stringent. Epoxy adhesive Type I, Cold Set, may be used to attach temporary pavement markers to the pavement surface when the pavement temperature is between 32°F and 50°F or per the manufacturer's recommendations whichever is more stringent.

Page 10-175, Subarticle 1086-2(E), Epoxy Adhesives, line 27, replace "Section 1081" with "Article 1081-4".

Page 10-177, Subarticle 1086-3(E), Epoxy Adhesives, line 22, replace "Section 1081" with "Article 1081-4".

Page 10-179, Subarticle 1087-4(A), Composition, lines 39-41, replace the third paragraph with the following:

All intermixed and drop-on glass beads shall not contain more than 75 ppm arsenic or 200 ppm lead.

Page 10-180, Subarticle 1087-4(B), Physical Characteristics, line 8, replace the second paragraph with the following:

All intermixed and drop-on glass beads shall comply with NCGS § 136-30.2 and 23 USC § 109(r).

Page 10-181, Subarticle 1087-7(A), Intermixed and Drop-on Glass Beads, line 24, add the following after the first paragraph:

Use X-ray Fluorescence for the normal sampling procedure for intermixed and drop-on beads, without crushing, to check for any levels of arsenic and lead. If any arsenic or lead is detected, the sample shall be crushed and repeat the test using X-ray Fluorescence. If the X-ray Fluorescence test shows more than a LOD of 5 ppm, test the beads using United States Environmental Protection Agency Method 6010B, 6010C or 3052 for no more than 75 ppm arsenic or 200 ppm lead.

SELECT MATERIAL, CLASS III, TYPE 3:

(1-17-12)

1016, 1044

SP10 R05

Revise the *2012 Standard Specifications* as follows:

Page 10-39, Article 1016-3, CLASS III, add the following after line 14:

Type 3 Select Material

Type 3 select material is a natural or manufactured fine aggregate material meeting the following gradation requirements and as described in Sections 1005 and 1006:

Percentage of Total by Weight Passing							
3/8"	#4	#8	#16	#30	#50	#100	#200
100	95-100	65-100	35-95	15-75	5-35	0-25	0-8

Page 10-39, Article 1016-3, CLASS III, line 15, replace “either type” with “Type 1, Type 2 or Type 3”.

Page 10-62, Article 1044-1, line 36, delete the sentence and replace with the following:

Subdrain fine aggregate shall meet Class III select material, Type 1 or Type 3.

Page 10-63, Article 1044-2, line 2, delete the sentence and replace with the following:

Subdrain coarse aggregate shall meet Class V select material.

SHOULDER AND SLOPE BORROW:

(3-19-13)

1019

SP10 R10

Use soil in accordance with Section 1019 of the *2012 Standard Specifications*. Use soil consisting of loose, friable, sandy material with a PI greater than 6 and less than 25 and a pH ranging from 5.5 to 7.0.

Soil with a pH ranging from 4.0 to 5.5 will be accepted without further testing if additional limestone is provided in accordance with the application rates shown in Table 1019-1A. Soil type is identified during the soil analysis. Soils with a pH above 7.0 require acidic amendments to be added. Submit proposed acidic amendments to the Engineer for review and approval. Soils with a pH below 4.0 or that do not meet the PI requirements shall not be used.

pH TEST RESULT	Sandy Soils Additional Rate (lbs. / Acre)	Silt Loam Soils Additional Rate (lbs. / Acre)	Clay Loam Soils Additional Rate (lbs. / Acre)
4.0 - 4.4	1,000	4,000	6,000
4.5 - 4.9	500	3,000	5,000
5.0 - 5.4	NA	2,000	4,000

Note: Limestone application rates shown in this table are in addition to the standard rate of 4000 lbs. / acre required for seeding and mulching.

No direct payment will be made for providing additional lime or acidic amendments for Ph adjustment.

GROUT PRODUCTION AND DELIVERY:

(3-17-15)

1003

SP10 R20

Revise the *2012 Standard Specifications* as follows:

Replace Section 1003 with the following:

**SECTION 1003
GROUT PRODUCTION AND DELIVERY**

1003-1 DESCRIPTION

This section addresses cement grout to be used for structures, foundations, retaining walls, concrete barriers, embankments, pavements and other applications in accordance with the contract. Produce non-metallic grout composed of Portland cement and water and at the Contractor's option or as required, aggregate and pozzolans. Include chemical admixtures as required or needed. Provide sand cement or neat cement grout as required. Define "sand cement grout" as grout with only fine aggregate and "neat cement grout" as grout without aggregate.

The types of grout with their typical uses are as shown below:

Type 1 – A cement grout with only a 3-day strength requirement and a fluid consistency that is typically used for filling subsurface voids.

Type 2 – A nonshrink grout with strength, height change and flow conforming to ASTM C1107 that is typically used for foundations, ground anchors and soil nails.

Type 3 – A nonshrink grout with high early strength and freeze-thaw durability requirements that is typically used in pile blockouts, grout pockets, shear keys, dowel holes and recesses for concrete barriers and structures.

Type 4 – A neat cement grout with low strength, a fluid consistency and high fly ash content that is typically used for slab jacking.

Type 5 – A low slump, low mobility sand cement grout with minimal strength that is typically used for compaction grouting.

1003-2 MATERIALS

Refer to Division 10.

Item	Section
Chemical Admixtures	1024-3
Fine Aggregate	1014-1
Fly Ash	1024-5
Ground Granulated Blast Furnace Slag	1024-6
Portland Cement	1024-1
Silica Fume	1024-7
Water	1024-4

Do not use grout that contains soluble chlorides or more than 1% soluble sulfate. At the Contractor's option, use an approved packaged grout instead of the materials above except for water. Use packaged grouts that are on the NCDOT Approved Products List.

Use admixtures for grout that are on the NCDOT Approved Products List or other admixtures in accordance with Subarticle 1024-3(E) except do not use concrete additives or unclassified or other admixtures in Type 4 or 5 grout. Use Class F fly ash for Type 4 grout and Type II Portland cement for Type 5 grout.

Use well graded rounded aggregate with a gradation, liquid limit (LL) and plasticity index (PI) that meet Table 1003-1 for Type 5 grout. Fly ash may be substituted for a portion of the fines in the aggregate. Do not use any other pozzolans in Type 5 grout.

Gradation		Maximum Liquid Limit	Maximum Plasticity Index
Sieve Designation per AASHTO M 92	Percentage Passing (% by weight)		
3/8"	100	N/A	N/A
No. 4	70 – 95		
No. 8	50 – 90		
No. 16	30 – 80		
No. 30	25 – 70		
No. 50	20 – 50		
No. 100	15 – 40		
No. 200	10 – 30	25	10

1003-3 COMPOSITION AND DESIGN

When using an approved packaged grout, a grout mix design submittal is not required. Otherwise, submit proposed grout mix designs for each grout mix to be used in the work. Mixes for all grout shall be designed by a Certified Concrete Mix Design Technician or an Engineer licensed by the State of North Carolina. Mix proportions shall be determined by a testing laboratory approved by the Department. Base grout mix designs on laboratory trial batches that meet Table 1003-2 and this section. With permission, the Contractor may use a quantity of chemical admixture within the range shown on the current list of approved admixtures maintained by the Materials and Tests Unit.

Submit grout mix designs in terms of saturated surface dry weights on Materials and Tests Form 312U at least 35 days before proposed use. Adjust batch proportions to compensate for surface moisture contained in the aggregates at the time of batching. Changes in the saturated surface dry mix proportions will not be permitted unless revised grout mix designs have been submitted to the Engineer and approved.

Accompany Materials and Tests Form 312U with a listing of laboratory test results of compressive strength, density and flow or slump and if applicable, aggregate gradation,

durability and height change. List the compressive strength of at least three 2" cubes at the age of 3 and 28 days.

The Engineer will review the grout mix design for compliance with the contract and notify the Contractor as to its acceptability. Do not use a grout mix until written notice has been received. Acceptance of the grout mix design or use of approved packaged grouts does not relieve the Contractor of his responsibility to furnish a product that meets the contract. Upon written request from the Contractor, a grout mix design accepted and used satisfactorily on any Department project may be accepted for use on other projects.

Perform laboratory tests in accordance with the following test procedures:

Property	Test Method
Aggregate Gradation ^A	AASHTO T 27
Compressive Strength	AASHTO T 106
Density (Unit Weight)	AASHTO T 121, AASHTO T 133 ^B , ANSI/API RP ^C 13B-1 ^B (Section 4, Mud Balance)
Durability	AASHTO T 161 ^D
Flow	ASTM C939 (Flow Cone)
Height Change	ASTM C1090 ^E
Slump	AASHTO T 119

- A.** Applicable to grout with aggregate.
- B.** Applicable to Neat Cement Grout.
- C.** American National Standards Institute/American Petroleum Institute Recommended Practice.
- D.** Procedure A (Rapid Freezing and Thawing in Water) required.
- E.** Moist room storage required.

1003-4 GROUT REQUIREMENTS

Provide grout types in accordance with the contract. Use grouts with properties that meet Table 1003-2. The compressive strength of the grout will be considered the average compressive strength test results of three 2" cubes at each age. Make cubes that meet AASHTO T 106 from the grout delivered for the work or mixed on-site. Make cubes at such frequencies as the Engineer may determine and cure them in accordance with AASHTO T 106.

Type of Grout	Minimum Compressive Strength at		Height Change at 28 days	Flow ^A /Slump ^B	Minimum Durability Factor
	3 days	28 days			
1	3,000 psi	–	–	10 – 30 sec	–
2	Table 1 ^C			Fluid Consistency ^C	–
3	5,000 psi	–	0 – 0.2%	Per Accepted Grout Mix Design/ Approved Packaged Grout	80
4 ^D	600 psi	1,500 psi	–	10 – 26 sec	–
5	–	500 psi	–	1 – 3"	–

A. Applicable to Type 1 through 4 grouts.

B. Applicable to Type 5 grout.

C. ASTM C1107.

D. Use Type 4 grout with proportions by volume of 1 part cement and 3 parts fly ash.

1003-5 TEMPERATURE REQUIREMENTS

When using an approved packaged grout, follow the manufacturer's instructions for grout and air temperature at the time of placement. Otherwise, the grout temperature at the time of placement shall be not less than 50°F nor more than 90°F. Do not place grout when the air temperature measured at the location of the grouting operation in the shade away from artificial heat is below 40°F.

1003-6 ELAPSED TIME FOR PLACING GROUT

Agitate grout continuously before placement. Regulate the delivery so the maximum interval between the placing of batches at the work site does not exceed 20 minutes. Place grout before exceeding the times in Table 1003-3. Measure the elapsed time as the time between adding the mixing water to the grout mix and placing the grout.

Air or Grout Temperature, Whichever is Higher	Maximum Elapsed Time	
	No Retarding Admixture Used	Retarding Admixture Used
90°F or above	30 minutes	1 hr. 15 minutes
80°F through 89°F	45 minutes	1 hr. 30 minutes
79°F or below	60 minutes	1 hr. 45 minutes

1003-7 MIXING AND DELIVERY

Use grout free of any lumps and undispersed cement. When using an approved packaged grout, mix grout in accordance with the manufacturer's instructions. Otherwise, comply with Articles 1000-8 through 1000-12 to the extent applicable for grout instead of concrete.

GEOSYNTHETICS:

(2-16-16)

1056

SP10 R25

Revise the *2012 Standard Specifications* as follows:

Replace Section 1056 with the following:

**SECTION 1056
GEOSYNTHETICS****1056-1 DESCRIPTION**

Provide geosynthetics for subsurface drainage, separation, stabilization, reinforcement, erosion control, filtration and other applications in accordance with the contract. Use geotextiles, geocomposite drains and geocells that are on the NCDOT Approved Products List. Prefabricated geocomposite drains include sheet, strip and vertical drains (PVDs), i.e., "wick drains" consisting of a geotextile attached to and/or encapsulating a plastic drainage core. Geocells are comprised of ultrasonically welded polymer strips that when expanded form a 3D honeycomb grid that is typically filled with material to support vegetation.

If necessary or required, hold geotextiles and sheet drains in place with new wire staples, i.e., "sod staples" that meet Subarticle 1060-8(D) or new anchor pins. Use steel anchor pins with a diameter of at least 3/16" and a length of at least 18" and with a point at one end and a head at the other end that will retain a steel washer with an outside diameter of at least 1.5".

1056-2 HANDLING AND STORING

Load, transport, unload and store geosynthetics so geosynthetics are kept clean and free of damage. Label, ship and store geosynthetics in accordance with Section 7 of AASHTO M 288. Geosynthetics with defects, flaws, deterioration or damage will be rejected. Do not unwrap geosynthetics until just before installation. Do not leave geosynthetics exposed for more than 7 days before covering except for geosynthetics for temporary wall faces and erosion control.

1056-3 CERTIFICATIONS

Provide Type 1, Type 2 or Type 4 material certifications in accordance with Article 106-3 for geosynthetics. Define "minimum average roll value" (MARV) in accordance with ASTM D4439. Provide certifications with MARV for geosynthetic properties as required. Test geosynthetics using laboratories accredited by the Geosynthetic Accreditation Institute (GAI) to perform the required test methods. Sample geosynthetics in accordance with ASTM D4354.

1056-4 GEOTEXTILES

When required, sew geotextiles together in accordance with Article X1.1.4 of AASHTO M 288. Provide sewn seams with seam strengths meeting the required strengths for the geotextile type and class specified.

Provide geotextile types and classes in accordance with the contract. Geotextiles will be identified by the product name printed directly on the geotextile. When geotextiles are not marked with a product name or marked with only a manufacturing plant identification code, geotextiles will be identified by product labels attached to the geotextile wrapping. When identification is based on labels instead of markings, unwrap geotextiles just before use in the presence of the Engineer to confirm that the product labels on both ends of the outside of the geotextile outer wrapping match the labels affixed to both ends of the inside of the geotextile roll core. Partial geotextile rolls without the product name printed on the geotextile or product labels affixed to the geotextile roll core may not be used.

Use woven or nonwoven geotextiles with properties that meet Table 1056-1. Define “machine direction” (MD) and “cross-machine direction” (CD) in accordance with ASTM D4439.

TABLE 1056-1 GEOTEXTILE REQUIREMENTS						
Property	Requirement					Test Method
	Type 1	Type 2	Type 3^A	Type 4	Type 5^B	
<i>Typical Application</i>	<i>Shoulder Drains</i>	<i>Under Rip Rap</i>	<i>Silt Fence Fabric</i>	<i>Soil Stabilization</i>	<i>Temporary Walls</i>	
Elongation (MD & CD)	≥ 50%	≥ 50%	≤ 25%	< 50%	< 50%	ASTM D4632
Grab Strength (MD & CD)	Table 1 ^D , Class 3	Table 1 ^D , Class 1	100 lb ^C	Table 1 ^D , Class 3	–	ASTM D4632
Tear Strength (MD & CD)			–			ASTM D4533
Puncture Strength			–			ASTM D6241
Ultimate Tensile Strength (MD & CD)	–	–	–	–	2,400 lb/ft ^C (unless required otherwise in the contract)	ASTM D4595
Permittivity	Table 2 ^D , 15% to 50% <i>in Situ</i> Soil Passing 0.075 mm	Table 6 ^D , 15% to 50% <i>in Situ</i> Soil Passing 0.075mm	Table 7 ^D	Table 5 ^D	0.20 sec ^{-1.C}	ASTM D4491
Apparent Opening Size					0.60 mm ^E	ASTM D4751
UV Stability (Retained Strength)					70% ^C (after 500 hr of exposure)	ASTM D4355

- A. Minimum roll width of 36" required.
 B. Minimum roll width of 13 ft required.
 C. MARV per Article 1056-3.
 D. AASHTO M 288.
 E. Maximum average roll value.

1056-5 GEOCOMPOSITE DRAINS

Provide geocomposite drain types in accordance with the contract and with properties that meet Table 1056-2.

Property	Requirement			Test Method
	Sheet Drain	Strip Drain	Wick Drain	
Width	≥ 12" (unless required otherwise in the contract)	12" ±1/4"	4" ±1/4"	N/A
In-Plane Flow Rate ^A (with gradient of 1.0 and 24-hour seating period)	6 gpm/ft @ applied normal compressive stress of 10 psi	15 gpm/ft @ applied normal compressive stress of 7.26 psi	1.5 gpm ^B @ applied normal compressive stress of 40 psi	ASTM D4716

A. MARV per Article 1056-3.

B. Per 4" drain width.

For sheet and strip drains, use accessories (e.g., pipe outlets, connectors, fittings, etc.) recommended by the Drain Manufacturer. Provide sheet and strip drains with Type 1 geotextiles heat bonded or glued to HDPE, polypropylene or high impact polystyrene drainage cores that meet Table 1056-3.

Property	Requirement (MARV)		Test Method
	Sheet Drain	Strip Drain	
Thickness	1/4"	1"	ASTM D1777 or D5199
Compressive Strength	40 psi	30 psi	ASTM D6364

For wick drains with a geotextile wrapped around a corrugated drainage core and seamed to itself, use drainage cores with an ultimate tensile strength of at least 225 lb per 4" width in accordance with ASTM D4595 and geotextiles with properties that meet Table 1056-4.

Property	Requirement	Test Method
Elongation	≥ 50%	ASTM D4632
Grab Strength	Table 1 ^A , Class 3	ASTM D4632
Tear Strength		ASTM D4533
Puncture Strength		ASTM D6241
Permittivity	0.7 sec ⁻¹ . ^B	ASTM D4491
Apparent Opening Size (AOS)	Table 2 ^A ,	ASTM D4751
UV Stability (Retained Strength)	> 50% <i>in Situ</i> Soil Passing 0.075 mm	ASTM D4355

A. AASHTO M 288.

B. MARV per Article 1056-3.

For wick drains with a geotextile fused to both faces of a corrugated drainage core along the peaks of the corrugations, use wick drains with an ultimate tensile strength of at least 1,650 lb/ft in accordance with ASTM D4595 and geotextiles with a permittivity, AOS and UV stability that meet Table 1056-4.

1056-6 GEOCELLS

Geocells will be identified by product labels attached to the geocell wrapping. Unwrap geocells just before use in the presence of the Engineer. Previously opened geocell products will be rejected.

Manufacture geocells from virgin polyethylene resin with no more than 10% rework, also called “regrind”, materials. Use geocells made from textured and perforated HDPE strips with an open area of 10% to 20% and properties that meet Table 1056-5.

Property	Minimum Requirement	Test Method
Cell Depth	4"	N/A
Sheet Thickness	50 mil -5%, +10%	ASTM D5199
Density	58.4 lb/cf	ASTM D1505
Carbon Black Content	1.5%	ASTM D1603 or D4218
ESCR ^A	5000 hr	ASTM D1693
Coefficient of Direct Sliding (with material that meets AASHTO M 145 for soil classification A-2)	0.85	ASTM D5321
Short-Term Seam (Peel) Strength (for 4" seam)	320 lb	USACE ^C Technical Report GL-86-19, Appendix A
Long-Term Seam (Hang) Strength ^B (for 4" seam)	160 lb	

A. Environmental Stress Crack Resistance.

B. Minimum test period of 168 hr with a temperature change from 74°F to 130°F in 1-hour cycles.

C. US Army Corps of Engineers.

Provide geocell accessories (e.g., stakes, pins, clips, staples, rings, tendons, anchors, deadmen, etc.) recommended by the Geocell Manufacturer.

TRUCK MOUNTED CHANGEABLE MESSAGE SIGNS:

(8-21-12)

1101.02

SP11 R10

Revise the 2012 Roadway Standard Drawings as follows:

Drawing No. 1101.02, Sheet 12, TEMPORARY LANE CLOSURES, replace General Note #11 with the following:

11- TRUCK MOUNTED CHANGEABLE MESSAGE SIGNS (TMCMS) USED ON SHADOW VEHICLES FOR “IN LANE” ACTIVITIES SHALL BE A MINIMUM OF 43" X 73". THE DISPLAY PANEL SHALL HAVE FULL MATRIX CAPABILITY WITH THE CAPABILITY

TO PROVIDE 2 MESSAGE LINES WITH 7 CHARACTERS PER LINE WITH A MINIMUM CHARACTER HEIGHT OF 18". FOR ADDITIONAL MESSAGING, CONTACT THE WORK ZONE TRAFFIC CONTROL SECTION.

12- TMCMS USED FOR ADVANCED WARNING ON VEHICLES LOCATED ON THE SHOULDER MAY BE SMALLER THAN 43" X 73". THE DISPLAY PANEL SHALL HAVE THE CAPABILITY TO PROVIDE 2 MESSAGE LINES WITH 7 CHARACTERS PER LINE WITH A MINIMUM CHARACTER HEIGHT OF 18". FOR ADDITIONAL MESSAGING, CONTACT THE WORK ZONE TRAFFIC CONTROL SECTION.

Drawing No. 1101.02, Sheet 13, TEMPORARY LANE CLOSURES, replace General Note #12 with the following:

12- TRUCK MOUNTED CHANGEABLE MESSAGE SIGNS (TMCMS) USED ON SHADOW VEHICLES FOR "IN LANE" ACTIVITIES SHALL BE A MINIMUM OF 43" X 73". THE DISPLAY PANEL SHALL HAVE FULL MATRIX CAPABILITY WITH THE CAPABILITY TO PROVIDE 2 MESSAGE LINES WITH 7 CHARACTERS PER LINE WITH A MINIMUM CHARACTER HEIGHT OF 18". FOR ADDITIONAL MESSAGING, CONTACT THE WORK ZONE TRAFFIC CONTROL SECTION.

13- TMCMS USED FOR ADVANCED WARNING ON VEHICLES LOCATED ON THE SHOULDER MAY BE SMALLER THAN 43" X 73". THE DISPLAY PANEL SHALL HAVE THE CAPABILITY TO PROVIDE 2 MESSAGE LINES WITH 7 CHARACTERS PER LINE WITH A MINIMUM CHARACTER HEIGHT OF 18". FOR ADDITIONAL MESSAGING, CONTACT THE WORK ZONE TRAFFIC CONTROL SECTION.

STANDARD SPECIAL PROVISION
AVAILABILITY OF FUNDS – TERMINATION OF CONTRACTS

(5-20-08)

Z-2

General Statute 143C-6-11. (h) Highway Appropriation is hereby incorporated verbatim in this contract as follows:

(h) Amounts Encumbered. – Transportation project appropriations may be encumbered in the amount of allotments made to the Department of Transportation by the Director for the estimated payments for transportation project contract work to be performed in the appropriation fiscal year. The allotments shall be multiyear allotments and shall be based on estimated revenues and shall be subject to the maximum contract authority contained in *General Statute 143C-6-11(c)*. Payment for transportation project work performed pursuant to contract in any fiscal year other than the current fiscal year is subject to appropriations by the General Assembly. Transportation project contracts shall contain a schedule of estimated completion progress, and any acceleration of this progress shall be subject to the approval of the Department of Transportation provided funds are available. The State reserves the right to terminate or suspend any transportation project contract, and any transportation project contract shall be so terminated or suspended if funds will not be available for payment of the work to be performed during that fiscal year pursuant to the contract. In the event of termination of any contract, the contractor shall be given a written notice of termination at least 60 days before completion of scheduled work for which funds are available. In the event of termination, the contractor shall be paid for the work already performed in accordance with the contract specifications.

Payment will be made on any contract terminated pursuant to the special provision in accordance with Subarticle 108-13(E) of the *2012 Standard Specifications*.

STANDARD SPECIAL PROVISION
NCDOT GENERAL SEED SPECIFICATION FOR SEED QUALITY

(5-17-11)

Z-3

Seed shall be sampled and tested by the North Carolina Department of Agriculture and Consumer Services, Seed Testing Laboratory. When said samples are collected, the vendor shall supply an independent laboratory report for each lot to be tested. Results from seed so sampled shall be final. Seed not meeting the specifications shall be rejected by the Department of Transportation and shall not be delivered to North Carolina Department of Transportation warehouses. If seed has been delivered it shall be available for pickup and replacement at the supplier's expense.

Any re-labeling required by the North Carolina Department of Agriculture and Consumer Services, Seed Testing Laboratory, that would cause the label to reflect as otherwise specified herein shall be rejected by the North Carolina Department of Transportation.

Seed shall be free from seeds of the noxious weeds Johnsongrass, Balloonvine, Jimsonweed, Witchweed, Itchgrass, Serrated Tussock, Showy Crotalaria, Smooth Crotalaria, Sicklepod, Sandbur, Wild Onion, and Wild Garlic. Seed shall not be labeled with the above weed species on the seed analysis label. Tolerances as applied by the Association of Official Seed Analysts will NOT be allowed for the above noxious weeds except for Wild Onion and Wild Garlic.

Tolerances established by the Association of Official Seed Analysts will generally be recognized. However, for the purpose of figuring pure live seed, the found pure seed and found germination percentages as reported by the North Carolina Department of Agriculture and Consumer Services, Seed Testing Laboratory will be used. Allowances, as established by the NCDOT, will be recognized for minimum pure live seed as listed on the following pages.

The specifications for restricted noxious weed seed refers to the number per pound as follows:

<u>Restricted Noxious Weed</u>	<u>Limitations per Lb. Of Seed</u>	<u>Restricted Noxious Weed</u>	<u>Limitations per Lb. of Seed</u>
Blessed Thistle	4 seeds	Cornflower (Ragged Robin)	27 seeds
Cocklebur	4 seeds	Texas Panicum	27 seeds
Spurred Anoda	4 seeds	Bracted Plantain	54 seeds
Velvetleaf	4 seeds	Buckhorn Plantain	54 seeds
Morning-glory	8 seeds	Broadleaf Dock	54 seeds
Corn Cockle	10 seeds	Curly Dock	54 seeds
Wild Radish	12 seeds	Dodder	54 seeds
Purple Nutsedge	27 seeds	Giant Foxtail	54 seeds
Yellow Nutsedge	27 seeds	Horsenettle	54 seeds
Canada Thistle	27 seeds	Quackgrass	54 seeds
Field Bindweed	27 seeds	Wild Mustard	54 seeds
Hedge Bindweed	27 seeds		

Seed of Pensacola Bahiagrass shall not contain more than 7% inert matter, Kentucky Bluegrass, Centipede and Fine or Hard Fescue shall not contain more than 5% inert matter whereas a maximum of 2% inert matter will be allowed on all other kinds of seed. In addition, all seed shall

not contain more than 2% other crop seed nor more than 1% total weed seed. The germination rate as tested by the North Carolina Department of Agriculture shall not fall below 70%, which includes both dormant and hard seed. Seed shall be labeled with not more than 7%, 5% or 2% inert matter (according to above specifications), 2% other crop seed and 1% total weed seed.

Exceptions may be made for minimum pure live seed allowances when cases of seed variety shortages are verified. Pure live seed percentages will be applied in a verified shortage situation. Those purchase orders of deficient seed lots will be credited with the percentage that the seed is deficient.

FURTHER SPECIFICATIONS FOR EACH SEED GROUP ARE GIVEN BELOW:

Minimum 85% pure live seed; maximum 1% total weed seed; maximum 2% total other crop seed; maximum 144 restricted noxious weed seed per pound. Seed less than 83% pure live seed will not be approved.

Sericea Lespedeza
Oats (seeds)

Minimum 80% pure live seed; maximum 1% total weed seed; maximum 2% total other crop; maximum 144 restricted noxious weed seed per pound. Seed less than 78% pure live seed will not be approved.

Tall Fescue (all approved varieties)	Bermudagrass
Kobe Lespedeza	Browntop Millet
Korean Lespedeza	German Millet – Strain R
Weeping Lovegrass	Clover – Red/White/Crimson
Carpetgrass	

Minimum 78% pure live seed; maximum 1% total weed seed; maximum 2% total other crop seed; maximum 144 restricted noxious weed seed per pound. Seed less than 76% pure live seed will not be approved.

Common or Sweet Sundangrass

Minimum 76% pure live seed; maximum 1% total weed seed; maximum 2% total other crop seed; maximum 144 restricted noxious weed seed per pound. Seed less than 74% pure live seed will not be approved.

Rye (grain; all varieties)
Kentucky Bluegrass (all approved varieties)
Hard Fescue (all approved varieties)
Shrub (bicolor) Lespedeza

Minimum 70% pure live seed; maximum 1% total weed seed; maximum 2% total other crop seed; maximum 144 noxious weed seed per pound. Seed less than 70% pure live seed will not be approved.

Centipedegrass	Japanese Millet
Crownvetch	Reed Canary Grass
Pensacola Bahiagrass	Zoysia
Creeping Red Fescue	

Minimum 70% pure live seed; maximum 1% total weed seed; maximum 2% total other crop seed; maximum 5% inert matter; maximum 144 restricted noxious weed seed per pound.

Barnyard Grass
Big Bluestem
Little Bluestem
Bristly Locust
Birdsfoot Trefoil
Indiangrass
Orchardgrass
Switchgrass
Yellow Blossom Sweet Clover

STANDARD SPECIAL PROVISION**ERRATA**

(1-17-12) (Rev. 04-21-15)

Z-4

Revise the *2012 Standard Specifications* as follows:

Division 2

Page 2-7, line 31, Article 215-2 Construction Methods, replace “Article 107-26” with “Article 107-25”.

Page 2-17, Article 226-3, Measurement and Payment, line 2, delete “pipe culverts,”.

Page 2-20, Subarticle 230-4(B), Contractor Furnished Sources, change references as follows:
Line 1, replace “(4) Buffer Zone” with “(c) Buffer Zone”; **Line 12**, replace “(5) Evaluation for Potential Wetlands and Endangered Species” with “(d) Evaluation for Potential Wetlands and Endangered Species”; and **Line 33**, replace “(6) Approval” with “(4) Approval”.

Division 3

Page 3-1, after line 15, Article 300-2 Materials, replace “1032-9(F)” with “1032-6(F)”.

Division 4

Page 4-77, line 27, Subarticle 452-3(C) Concrete Coping, replace “sheet pile” with “reinforcement”.

Division 6

Page 6-7, line 31, Article 609-3 Field Verification of Mixture and Job Mix Formula Adjustments, replace “30” with “45”.

Page 6-10, line 42, Subarticle 609-6(C)(2), replace “Subarticle 609-6(E)” with “Subarticle 609-6(D)”.

Page 6-11, Table 609-1 Control Limits, replace “Max. Spec. Limit” for the Target Source of $P_{0.075}/P_{be}$ Ratio with “1.0”.

Page 6-40, Article 650-2 Materials, replace “Subarticle 1012-1(F)” with “Subarticle 1012-1(E)”

Division 7

Page 7-1, Article 700-3, CONCRETE HAULING EQUIPMENT, line 33, replace “competition” with “completion”.

Division 8

Page 8-23, line 10, Article 838-2 Materials, replace “Portland Cement Concrete, Class B” with “Portland Cement Concrete, Class A”.

Division 10

Page 10-166, Article 1081-3 Hot Bitumen, replace “Table 1081-16” with “Table 1081-2”, replace “Table 1081-17” with “Table 1081-3”, and replace “Table 1081-18” with “Table 1081-4”.

Division 12

Page 12-7, Table 1205-3, add “FOR THERMOPLASTIC” to the end of the title.

Page 12-8, Subarticle 1205-5(B), line 13, replace “Table 1205-2” with “Table 1205-4”.

Page 12-8, Table 1205-4 and 1205-5, replace “THERMOPLASTIC” in the title of these tables with “POLYUREA”.

Page 12-9, Subarticle 1205-6(B), line 21, replace “Table 1205-4” with “Table 1205-6”.

Page 12-11, Subarticle 1205-8(C), line 25, replace “Table 1205-5” with “Table 1205-7”.

Division 15

Page 15-4, Subarticle 1505-3(F) Backfilling, line 26, replace “Subarticle 235-4(C)” with “Subarticle 235-3(C)”.

Page 15-6, Subarticle 1510-3(B), after line 21, replace the allowable leakage formula with the following: $W=LD\sqrt{P} \div 148,000$

Page 15-6, Subarticle 1510-3(B), line 32, delete “may be performed concurrently or” and replace with “shall be performed”.

Page 15-17, Subarticle 1540-3(E), line 27, delete “Type 1”.

Division 17

Page 17-26, line 42, Subarticle 1731-3(D) Termination and Splicing within Interconnect Center, delete this subarticle.

Revise the *2012 Roadway Standard Drawings* as follows:

1633.01 Sheet 1 of 1, English Standard Drawing for Matting Installation, replace “1633.01” with “1631.01”.

STANDARD SPECIAL PROVISION**PLANT AND PEST QUARANTINES****(Imported Fire Ant, Gypsy Moth, Witchweed, Emerald Ash Borer, And Other Noxious Weeds)**

(3-18-03) (Rev. 12-20-16)

Z-04a

Within Quarantined Area

This project may be within a county regulated for plant and/or pests. If the project or any part of the Contractor's operations is located within a quarantined area, thoroughly clean all equipment prior to moving out of the quarantined area. Comply with federal/state regulations by obtaining a certificate or limited permit for any regulated article moving from the quarantined area.

Originating in a Quarantined County

Obtain a certificate or limited permit issued by the N.C. Department of Agriculture/United States Department of Agriculture. Have the certificate or limited permit accompany the article when it arrives at the project site.

Contact

Contact the N.C. Department of Agriculture/United States Department of Agriculture at 1-800-206-9333, 919-707-3730, or <http://www.ncagr.gov/plantindustry/> to determine those specific project sites located in the quarantined area or for any regulated article used on this project originating in a quarantined county.

Regulated Articles Include

1. Soil, sand, gravel, compost, peat, humus, muck, and decomposed manure, separately or with other articles. This includes movement of articles listed above that may be associated with cut/waste, ditch pulling, and shoulder cutting.
2. Plants with roots including grass sod.
3. Plant crowns and roots.
4. Bulbs, corms, rhizomes, and tubers of ornamental plants.
5. Hay, straw, fodder, and plant litter of any kind.
6. Clearing and grubbing debris.
7. Used agricultural cultivating and harvesting equipment.
8. Used earth-moving equipment.
9. Any other products, articles, or means of conveyance, of any character, if determined by an inspector to present a hazard of spreading imported fire ant, gypsy moth, witchweed, emerald ash borer, or other noxious weeds.

STANDARD SPECIAL PROVISION

MINIMUM WAGES

(7-21-09)

Z-5

FEDERAL: The Fair Labor Standards Act provides that with certain exceptions every employer shall pay wages at the rate of not less than SEVEN DOLLARS AND TWENTY FIVE CENTS (\$7.25) per hour.

STATE: The North Carolina Minimum Wage Act provides that every employer shall pay to each of his employees, wages at a rate of not less than SEVEN DOLLARS AND TWENTY FIVE CENTS (\$7.25) per hour.

The minimum wage paid to all skilled labor employed on this contract shall be SEVEN DOLLARS AND TWENTY FIVE CENTS (\$7.25) per hour.

The minimum wage paid to all intermediate labor employed on this contract shall be SEVEN DOLLARS AND TWENTY FIVE CENTS (\$7.25) per hour.

The minimum wage paid to all unskilled labor on this contract shall be SEVEN DOLLARS AND TWENTY FIVE CENTS (\$7.25) per hour.

This determination of the intent of the application of this act to the contract on this project is the responsibility of the Contractor.

The Contractor shall have no claim against the Department of Transportation for any changes in the minimum wage laws, Federal or State. It is the responsibility of the Contractor to keep fully informed of all Federal and State Laws affecting his contract.

STANDARD SPECIAL PROVISION**AWARD OF CONTRACT**

(6-28-77)(Rev 2/16/2016)

Z-6

“The North Carolina Department of Transportation, in accordance with the provisions of *Title VI of the Civil Rights Act of 1964* (78 Stat. 252) and the Regulations of the Department of Transportation (*49 C.F.R., Part 21*), issued pursuant to such act, hereby notifies all bidders that it will affirmatively insure that the contract entered into pursuant to this advertisement will be awarded to the lowest responsible bidder without discrimination on the ground of race, color, or national origin”.

TITLE VI AND NONDISCRIMINATION**I. Title VI Assurance**

During the performance of this contract, the contractor, for itself, its assignees and successors in interest (hereinafter referred to as the "contractor") agrees as follows:

(1) Compliance with Regulations: The contractor shall comply with the Regulation relative to nondiscrimination in Federally-assisted programs of the Department of Transportation (hereinafter, "DOT") Title 49, Code of Federal Regulations, Part 21, as they may be amended from time to time, (hereinafter referred to as the Regulations), which are herein incorporated by reference and made a part of this contract.

(2) Nondiscrimination: The Contractor, with regard to the work performed by it during the contract, shall not discriminate on the grounds of race, color, or national origin in the selection and retention of subcontractors, including procurements of materials and leases of equipment. The contractor shall not participate either directly or indirectly in the discrimination prohibited by section 21.5 of the Regulations, including employment practices when the contract covers a program set forth in Appendix B of the Regulations.

(3) Solicitations for Subcontractors, Including Procurements of Materials and Equipment: In all solicitations either by competitive bidding or negotiation made by the contractor for work to be performed under a subcontract, including procurements of materials or leases of equipment, each potential subcontractor or supplier shall be notified by the contractor of the contractor's obligations under this contract and the Regulations relative to nondiscrimination on the grounds of race, color, or national origin.

(4) Information and Reports: The contractor shall provide all information and reports required by the Regulations or directives issued pursuant thereto, and shall permit access to its books, records, accounts, other sources of information, and its facilities as may be determined by the North Carolina Department of Transportation (NCDOT) or the Federal Highway Administration (FHWA) to be pertinent to ascertain compliance with such Regulations, orders and instructions. Where any information required of a contractor is in the exclusive possession of another who fails or refuses to furnish this information the contractor shall so certify to the NCDOT, or the FHWA as appropriate, and shall set forth what efforts it has made to obtain the information.

(5) Sanctions for Noncompliance: In the event of the contractor's noncompliance with the nondiscrimination provisions of this contract, the NCDOT shall impose such contract sanctions as it or the FHWA may determine to be appropriate, including, but not limited to:

(a) Withholding of payments to the contractor under the contract until the contractor complies, and/or

(b) Cancellation, termination or suspension of the contract, in whole or in part.

(6) Incorporation of Provisions: The contractor shall include the provisions of paragraphs (1) through (6) in every subcontract, including procurements of materials and leases of equipment, unless exempt by the Regulations, or directives issued pursuant thereto.

The contractor shall take such action with respect to any subcontractor procurement as the NCDOT or the FHWA may direct as a means of enforcing such provisions including sanctions for noncompliance: provided, however, that, in the event a contractor becomes involved in, or is threatened with, litigation with a subcontractor or supplier as a result of such direction, the contractor may request the NCDOT to enter into such litigation to protect the interests of the NCDOT, and, in addition, the contractor may request the United States to enter into such litigation to protect the interests of the United States.

II. Title VI Nondiscrimination Program

Title VI of the 1964 Civil Rights Act, 42 U.S.C. 2000d, provides that: "No person in the United States shall, on the grounds of race, color, or national origin, be excluded from participation in, be denied the benefits of, or be subjected to discrimination under any program or activity receiving Federal financial assistance." The broader application of nondiscrimination law is found in other statutes, executive orders, and regulations (see Section III, Pertinent Nondiscrimination Authorities), which provide additional protections based on age, sex, disability and religion. In addition, the 1987 Civil Rights Restoration Act extends nondiscrimination coverage to all programs and activities of federal-aid recipients and contractors, including those that are not federally-funded.

Nondiscrimination Assurance

The North Carolina Department of Transportation (NCDOT) hereby gives assurance that no person shall on the ground of race, color, national origin, sex, age, and disability, be excluded from participation in, be denied the benefits of, or be otherwise subjected to discrimination under any program or activity conducted by the recipient, as provided by Title VI of the Civil Rights Act of 1964, the Civil Rights Restoration Act of 1987, and any other related Civil Rights authorities, whether those programs and activities are federally funded or not.

Obligation

During the performance of this contract, the Contractor and its subcontractors are responsible for complying with NCDOT's Title VI Program. The Contractor must ensure that NCDOT's Notice of Nondiscrimination is posted in conspicuous locations accessible to all employees and subcontractors on the jobsite, along with the Contractor's own Equal Employment Opportunity (EEO) Policy Statement. The Contractor shall physically incorporate this "**TITLE VI AND NONDISCRIMINATION**" language, in its entirety, into all its subcontracts on federally-assisted and state-funded NCDOT-owned projects, and ensure its inclusion by subcontractors into all subsequent lower tier subcontracts. The Contractor and its subcontractors shall also physically incorporate the **FHWA-1273**, in its entirety, into all subcontracts and subsequent lower tier subcontracts on Federal-aid highway construction contracts only. The Contractor is also responsible for making its subcontractors aware of NCDOT's Discrimination Complaints Process, as follows:

FILING OF COMPLAINTS

1. **Applicability** – These complaint procedures apply to the beneficiaries of the NCDOT’s programs, activities, and services, including, but not limited to, members of the public, contractors, subcontractors, consultants, and other sub-recipients of federal and state funds.
2. **Eligibility** – Any person or class of persons who believes he/she has been subjected to discrimination or retaliation prohibited by any of the Civil Rights authorities, based upon race, color, sex, age, national origin, or disability, may file a written complaint with NCDOT's Civil Rights office. The law prohibits intimidation or retaliation of any sort. The complaint may be filed by the affected individual or a representative, and must be in writing.
3. **Time Limits and Filing Options** – A complaint must be filed no later than 180 calendar days after the following:
 - The date of the alleged act of discrimination; or
 - The date when the person(s) became aware of the alleged discrimination; or
 - Where there has been a continuing course of conduct, the date on which that conduct was discontinued or the latest instance of the conduct.

Title VI and other discrimination complaints may be submitted to the following entities:

- **North Carolina Department of Transportation**, Office of Equal Opportunity & Workforce Services (EOWS), External Civil Rights Section, 1511 Mail Service Center, Raleigh, NC 27699-1511; 919-508-1808 or toll free 800-522-0453
- **US Department of Transportation**, Departmental Office of Civil Rights, External Civil Rights Programs Division, 1200 New Jersey Avenue, SE, Washington, DC 20590; 202-366-4070
 - Federal Highway Administration**, North Carolina Division Office, 310 New Bern Avenue, Suite 410, Raleigh, NC 27601, 919-747-7010
 - Federal Highway Administration**, Office of Civil Rights, 1200 New Jersey Avenue, SE, 8th Floor, E81-314, Washington, DC 20590, 202-366-0693 / 366-0752
 - Federal Transit Administration**, Office of Civil Rights, ATTN: Title VI Program Coordinator, East Bldg. 5th Floor – TCR, 1200 New Jersey Avenue, SE, Washington, DC 20590
 - Federal Aviation Administration**, Office of Civil Rights, 800 Independence Avenue, SW, Washington, DC 20591, 202-267-3258
- **US Department of Justice**, Special Litigation Section, Civil Rights Division, 950 Pennsylvania Avenue, NW, Washington, DC 20530, 202-514-6255 or toll free 877-218-5228

4. **Format for Complaints** – Complaints must be in **writing** and **signed** by the complainant(s) or a representative and include the complainant’s name, address, and telephone number. Complaints received by fax or e-mail will be acknowledged and processed. Allegations received by telephone will be reduced to writing and provided to the complainant for confirmation or revision before processing. Complaints will be accepted in other languages including Braille.
5. **Discrimination Complaint Form** – Contact NCDOT EOWS at the phone number above to receive a full copy of the Discrimination Complaint Form and procedures.
6. **Complaint Basis** – Allegations must be based on issues involving race, color, national origin, sex, age, or disability. The term “basis” refers to the complainant’s membership in a protected group category. Contact this office to receive a Discrimination Complaint Form.

Protected Categories	Definition	Examples	Applicable Statutes and Regulations	
			FHWA	FTA
Race	An individual belonging to one of the accepted racial groups; or the perception, based usually on physical characteristics that a person is a member of a racial group	Black/African American, Hispanic/Latino, Asian, American Indian/Alaska Native, Native Hawaiian/Pacific Islander, White	Title VI of the Civil Rights Act of 1964; 49 CFR Part 21; 23 CFR 200	Title VI of the Civil Rights Act of 1964; 49 CFR Part 21; Circular 4702.1B
Color	Color of skin, including shade of skin within a racial group	Black, White, brown, yellow, etc.		
National Origin	Place of birth. Citizenship is not a factor. Discrimination based on language or a person's accent is also covered.	Mexican, Cuban, Japanese, Vietnamese, Chinese		
Sex	Gender	Women and Men	1973 Federal-Aid Highway Act	Title IX of the Education Amendments of 1972
Age	Persons of any age	21 year old person	Age Discrimination Act of 1975	
Disability	Physical or mental impairment, permanent or temporary, or perceived.	Blind, alcoholic, paraplegic, epileptic, diabetic, arthritic	Section 504 of the Rehabilitation Act of 1973; Americans with Disabilities Act of 1990	

III. Pertinent Nondiscrimination Authorities

During the performance of this contract, the contractor, for itself, its assignees, and successors in interest agrees to comply with the following non-discrimination statutes and authorities, including, but not limited to:

- Title VI of the Civil Rights Act of 1964 (42 U.S.C. § 2000d *et seq.*, 78 stat. 252), (prohibits discrimination on the basis of race, color, national origin); and 49 CFR Part 21.
- The Uniform Relocation Assistance and Real Property Acquisition Policies Act of 1970, (42 U.S.C. § 4601), (prohibits unfair treatment of persons displaced or whose property has been acquired because of Federal or Federal-aid programs and projects);
- Federal-Aid Highway Act of 1973, (23 U.S.C. § 324 *et seq.*), (prohibits discrimination on the basis of sex);
- Section 504 of the Rehabilitation Act of 1973, (29 U.S.C. § 794 *et seq.*), as amended, (prohibits discrimination on the basis of disability); and 49 CFR Part 27;
- The Age Discrimination Act of 1975, as amended, (42 U.S.C. § 6101 *et seq.*), (prohibits discrimination on the basis of age);
- Airport and Airway Improvement Act of 1982, (49 USC § 471, Section 47123), as amended, (prohibits discrimination based on race, creed, color, national origin, or sex);
- The Civil Rights Restoration Act of 1987, (PL 100-209), (Broadened the scope, coverage and applicability of Title VI of the Civil Rights Act of 1964, The Age Discrimination Act of 1975 and Section 504 of the Rehabilitation Act of 1973, by expanding the definition of the terms

“programs or activities” to include all of the programs or activities of the Federal-aid recipients, sub-recipients and contractors, whether such programs or activities are Federally funded or not);

- Titles II and III of the Americans with Disabilities Act, which prohibit discrimination on the basis of disability in the operation of public entities, public and private transportation systems, places of public accommodation, and certain testing entities (42 U.S.C. §§ 12131 – 12189) as implemented by Department of Transportation regulations at 49 C.F.R. parts 37 and 38;
- The Federal Aviation Administration’s Non-discrimination statute (49 U.S.C. § 47123) (prohibits discrimination on the basis of race, color, national origin, and sex);
- Executive Order 12898, Federal Actions to Address Environmental Justice in Minority Populations and Low-Income Populations, which ensures discrimination against minority populations by discouraging programs, policies, and activities with disproportionately high and adverse human health or environmental effects on minority and low-income populations;
- Executive Order 13166, Improving Access to Services for Persons with Limited English Proficiency, and resulting agency guidance, national origin discrimination includes discrimination because of limited English proficiency (LEP). To ensure compliance with Title VI, you must take reasonable steps to ensure that LEP persons have meaningful access to your programs (70 Fed. Reg. at 74087 to 74100);
- Title IX of the Education Amendments of 1972, as amended, which prohibits you from discriminating because of sex in education programs or activities (20 U.S.C. 1681 et seq).
- Title VII of the Civil Rights Act of 1964 (42 U.S.C. § 2000e *et seq.*, Pub. L. 88-352), (prohibits employment discrimination on the basis of race, color, religion, sex, or national origin);
- 49 CFR Part 26, regulation to ensure nondiscrimination in the award and administration of DOT-assisted contracts in the Department's highway, transit, and airport financial assistance programs, as regards the use of Disadvantaged Business Enterprises (DBEs);
- Form FHWA-1273, “Required Contract Provisions,” a collection of contract provisions and proposal notices that are generally applicable to *all Federal-aid construction projects* and must be made a part of, and physically incorporated into, *all federally-assisted contracts*, as well as appropriate subcontracts and purchase orders, particularly Sections II (Nondiscrimination) and III (Nonsegregated Facilities).

STANDARD SPECIAL PROVISION**ON-THE-JOB TRAINING**

(10-16-07) (Rev. 4-21-15)

Z-10

Description

The North Carolina Department of Transportation will administer a custom version of the Federal On-the-Job Training (OJT) Program, commonly referred to as the Alternate OJT Program. All contractors (existing and newcomers) will be automatically placed in the Alternate Program. Standard OJT requirements typically associated with individual projects will no longer be applied at the project level. Instead, these requirements will be applicable on an annual basis for each contractor administered by the OJT Program Manager.

On the Job Training shall meet the requirements of 23 CFR 230.107 (b), 23 USC – Section 140, this provision and the On-the-Job Training Program Manual.

The Alternate OJT Program will allow a contractor to train employees on Federal, State and privately funded projects located in North Carolina. However, priority shall be given to training employees on NCDOT Federal-Aid funded projects.

Minorities and Women

Developing, training and upgrading of minorities and women toward journeyman level status is a primary objective of this special training provision. Accordingly, the Contractor shall make every effort to enroll minority and women as trainees to the extent that such persons are available within a reasonable area of recruitment. This training commitment is not intended, and shall not be used, to discriminate against any applicant for training, whether a member of a minority group or not.

Assigning Training Goals

The Department, through the OJT Program Manager, will assign training goals for a calendar year based on the contractors' past three years' activity and the contractors' anticipated upcoming year's activity with the Department. At the beginning of each year, all contractors eligible will be contacted by the Department to determine the number of trainees that will be assigned for the upcoming calendar year. At that time the Contractor shall enter into an agreement with the Department to provide a self-imposed on-the-job training program for the calendar year. This agreement will include a specific number of annual training goals agreed to by both parties. The number of training assignments may range from 1 to 15 per contractor per calendar year. The Contractor shall sign an agreement to fulfill their annual goal for the year.\

Training Classifications

The Contractor shall provide on-the-job training aimed at developing full journeyman level workers in the construction craft/operator positions. Preference shall be given to providing training in the following skilled work classifications:

Equipment Operators	Office Engineers
Truck Drivers	Estimators
Carpenters	Iron / Reinforcing Steel Workers
Concrete Finishers	Mechanics
Pipe Layers	Welders

The Department has established common training classifications and their respective training requirements that may be used by the contractors. However, the classifications established are not all-inclusive. Where the training is oriented toward construction applications, training will be allowed in lower-level management positions such as office engineers and estimators. Contractors shall submit new classifications for specific job functions that their employees are performing. The Department will review and recommend for acceptance to FHWA the new classifications proposed by contractors, if applicable. New classifications shall meet the following requirements:

Proposed training classifications are reasonable and realistic based on the job skill classification needs, and

The number of training hours specified in the training classification is consistent with common practices and provides enough time for the trainee to obtain journeyman level status.

The Contractor may allow trainees to be trained by a subcontractor provided that the Contractor retains primary responsibility for meeting the training and this provision is made applicable to the subcontract. However, only the Contractor will receive credit towards the annual goal for the trainee.

Where feasible, 25 percent of apprentices or trainees in each occupation shall be in their first year of apprenticeship or training. The number of trainees shall be distributed among the work classifications on the basis of the contractor's needs and the availability of journeymen in the various classifications within a reasonable area of recruitment.

No employee shall be employed as a trainee in any classification in which they have successfully completed a training course leading to journeyman level status or in which they have been employed as a journeyman.

Records and Reports

The Contractor shall maintain enrollment, monthly and completion reports documenting company compliance under these contract documents. These documents and any other information as requested shall be submitted to the OJT Program Manager.

Upon completion and graduation of the program, the Contractor shall provide each trainee with a certification Certificate showing the type and length of training satisfactorily completed.

Trainee Interviews

All trainees enrolled in the program will receive an initial and Trainee/Post graduate interview conducted by the OJT program staff.

Trainee Wages

Contractors shall compensate trainees on a graduating pay scale based upon a percentage of the prevailing minimum journeyman wages (Davis-Bacon Act). Minimum pay shall be as follows:

60 percent	of the journeyman wage for the first half of the training period
75 percent	of the journeyman wage for the third quarter of the training period
90 percent	of the journeyman wage for the last quarter of the training period

In no instance shall a trainee be paid less than the local minimum wage. The Contractor shall adhere to the minimum hourly wage rate that will satisfy both the NC Department of Labor (NCDOL) and the Department.

Achieving or Failing to Meet Training Goals

The Contractor will be credited for each trainee employed by him on the contract work who is currently enrolled or becomes enrolled in an approved program and who receives training for at least 50 percent of the specific program requirement. Trainees will be allowed to be transferred between projects if required by the Contractor's scheduled workload to meet training goals.

If a contractor fails to attain their training assignments for the calendar year, they may be taken off the NCDOT's Bidders List.

Measurement and Payment

No compensation will be made for providing required training in accordance with these contract documents.

STANDARD SPECIAL PROVISION

NAME CHANGE FOR NCDENR

(1-19-16)

Z-11

Description

Wherever in the 2012 Standard Specifications, Project Special Provisions, Standard Special Provisions, Permits or Plans that reference is made to “NCDENR” or “North Carolina Department of Environment and Natural Resources”, replace with “NCDEQ” or “North Carolina Department of Environmental Quality” respectively, as the case may be.

B-5362

GT-0.1

Montgomery/Moore County

PROJECT SPECIAL PROVISIONS

GEOTECHNICAL

PILES (LRFD) - (5/16/2017)

GT-1.1 - GT-1.3

DocuSigned by:

Geotechnical Engineering Unit

E06538624A11498...

8/3/2017

PILES**(5-16-17)**

Revise the *2012 Standard Specifications* as follows:

Page 4-70, Article 450-2, Materials, line 2, in the materials table, replace “Neat Cement Grout, Nonshrink” with “Neat Cement Grout, Type 1”.

Page 4-70, Article 450-2, Materials, line 8, in the last sentence of the second paragraph, replace “approved by the Materials and Tests Unit.” with “that are on the NCDOT Approved Products List.”

Page 4-71, Subarticle 450-3(D), Driven Piles, line 10, add the following after the first sentence of the third paragraph.

Use AASHTO driving stress limits for severe corrosive environments when calcium nitrite corrosion inhibitor is required for prestressed concrete piles.

Page 4-72, Subarticle 450-3(D)(3), Required Driving Resistance, lines 26-30, replace first paragraph with the following:

The Engineer will determine if the proposed pile driving methods and equipment are acceptable and provide the blows/ft and equivalent set for the required driving resistance noted in the plans, i.e., “pile driving criteria” except for structures with pile driving analyzer (PDA) testing. For structures with PDA testing, provide pile driving criteria for any bents and end bents with piles in accordance with Subarticle 450-3(F)(4).

Page 4-73, Subarticle 450-3(E)(1), Pile Excavation, lines 19-20, in the third sentence of the second paragraph, replace “use smooth or corrugated clean watertight steel casings” with “use smooth non-corrugated clean watertight steel casings”.

Page 4-73, Subarticle 450-3(F), Pile Driving Analyzer, lines 45-48, replace third paragraph with the following:

The Engineer will complete the review of the proposed pile driving methods and equipment within 7 days of receiving PDA reports and pile driving criteria. Do not place concrete for caps or footings on piles until PDA reports and pile driving criteria have been accepted.

Page 4-75, Subarticle 450-3(F), Pile Driving Analyzer, line 21, add the following to the end of Article 450-3:

(4) Pile Driving Criteria

Analyze pile driving with the GRL Wave Equation Analysis Program (GRLWEAP) manufactured by Pile Dynamics, Inc. Use the same PDA Consultant that provides PDA reports to perform GRLWEAP analyses and develop pile driving criteria. Provide driving criteria sealed by an engineer approved as a Project Engineer (key person) for the

same PDA Consultant.

Analyze pile driving so driving stresses, energy transfer, ram stroke and blows/ft from PDA testing and resistances from CAPWAP analyses correlate to GRLWEAP models. Provide pile driving criteria for each combination of required driving resistance and pile length installed for all pile types and sizes. Submit 2 copies of pile driving criteria with PDA reports. Include the following for driving criteria:

- (a) Project information in accordance with Subarticle 450-3(F)(3)(a)
- (b) Table showing blows/ft and equivalent set vs. either stroke for multiple strokes in increments of 6" or bounce chamber pressure for multiple pressures in increments of 1 psi
- (c) Maximum stroke or blows/ft or pile cushion requirements to prevent overstressing piles as needed
- (d) GRLWEAP software version information
- (e) PDF copy of all pile driving criteria and executable GRLWEAP input and output files

Page 4-75, Article 450-4, Measurement and Payment, line 24, add the following after the first paragraph:

Pile Driving Equipment Setup for ____ Prestressed Concrete Piles, Pile Driving Equipment Setup for ____ Steel Piles and Pile Driving Equipment Setup for ____ Galvanized Steel Piles will be measured and paid in units of each. Setting up equipment to drive piles will be measured as one per pile. No payment will be made for pile driving equipment setup for installed piles that are not driven. The contract unit price for *Pile Driving Equipment Setup for ____ Prestressed Concrete Piles, Pile Driving Equipment Setup for ____ Steel Piles and Pile Driving Equipment Setup for ____ Galvanized Steel Piles* will be full compensation for mobilizing and demobilizing pile driving equipment, personnel, supplies and incidentals, setting up and breaking down pile driving equipment, e.g., pile hammer, crane, template, etc. and submitting the proposed pile driving methods and equipment.

Page 4-75, Article 450-4, Measurement and Payment, line 31, in the fifth sentence of the second paragraph, replace "driving piles" with "furnishing and installing piles except for the items paid for separately in this article"

Page 4-76, Article 450-4, Measurement and Payment, lines 27-29, replace third sentence of the sixth paragraph with the following:

The contract unit price for *PDA Testing* will be full compensation for performing PDA testing the first time a pile is tested, performing CAPWAP analysis on data collected during initial drive, restrikes and redrives, providing PDA reports, performing GRLWEAP analysis and developing and providing pile driving criteria.

Page 4-76, Article 450-4, Measurement and Payment, line 33, add the following after the list headings:

Pay Item

Pile Driving Equipment Setup for ____ Prestressed Concrete Piles
Pile Driving Equipment Setup for ____ Steel Piles
Pile Driving Equipment Setup for ____ Galvanized Steel Piles

Pay Unit

Each
Each
Each

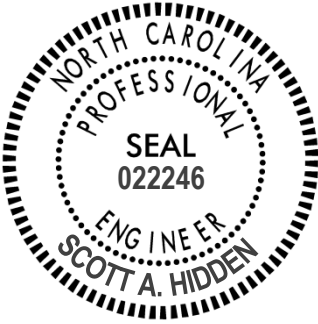

DocuSigned by:
Scott A. Hidden
F760CAEB96FC4D3...

8/3/2017

PROJECT SPECIAL PROVISIONS

Utilities by Others

 <p>WETHERILL ENGINEERING</p> <p><i>WE Design Your Tomorrow . .</i></p>	<p>1223 Jones Franklin Road Raleigh, NC 27606 Phone: 919.851.8077 Fax: 919.851.8107 wei@wetherilleng.com</p>
---	---

General:

- A) Broadplex -Communications**
Jeff Matthews, 828-433-4506
jeff.matthews@broadplex.com
- B) Duke Energy (Power Distribution)**
Matt Wynne, 919-654-6660
matthew.wynne@duke-energy.com
- C) Pee Dee EMC (Power Distribution)**
Matt Wynne, 919-654-6660
matthew.wynne@duke-energy.com

The conflicting facilities of these concerns will be adjusted prior to the date of availability, unless otherwise noted and are therefore listed in these special provisions for the benefit of the Contractor. All utility work listed herein will be done by the utility owners. All utilities are shown on the plans from the best available information.

The Contractor's attention is directed to Article 105-8 of the 2012 Standard Specifications.

Utilities Requiring Adjustment:

Utility relocations are shown on the Utilities by Others Plans.

- A) Broadplex -Communications**
 - 1) Broadplex will relocate their facilities by the date of availability.
 - 2) Contact person for Broadplex: Jeff Matthews at 828-433-4506.
- B) Duke Energy (Power Distribution)**
 - 1) Duke Energy will relocate their facilities by the date of availability.
 - 2) Contact person for Duke Energy: Matt Wynne at 919-654-6660.
- C) Pee Dee EMC (Power Distribution)**
 - 1) Pee Dee EMC will complete the temporary relocation of their facilities by the date of availability. The contractor shall notify Pee Dee EMC when the

PROJECT SPECIAL PROVISIONS

Utilities by Others

project is complete and they are clear to restore their facilities to the original location.

- 2) Contact person for Duke Energy: Matt Wynne at 919-654-6660.

**Project Special Provisions
Erosion Control**

STABILIZATION REQUIREMENTS:

(3-11-2016)

Stabilization for this project shall comply with the time frame guidelines as specified by the NCG-010000 general construction permit effective August 1, 2016 issued by the North Carolina Department of Environment and Natural Resources Division of Water Quality. Temporary or permanent ground cover stabilization shall occur within 7 calendar days from the last land-disturbing activity, with the following exceptions in which temporary or permanent ground cover shall be provided in 14 calendar days from the last land-disturbing activity:

- Slopes between 2:1 and 3:1, with a slope length of 10 ft. or less
- Slopes 3:1 or flatter, with a slope of length of 50 ft. or less
- Slopes 4:1 or flatter

The stabilization timeframe for High Quality Water (HQW) Zones shall be 7 calendar days with no exceptions for slope grades or lengths. High Quality Water Zones (HQW) Zones are defined by North Carolina Administrative Code 15A NCAC 04A.0105 (25). Temporary and permanent ground cover stabilization shall be achieved in accordance with the provisions in this contract and as directed.

SEEDING AND MULCHING:

(East)

The kinds of seed and fertilizer, and the rates of application of seed, fertilizer, and limestone, shall be as stated below. During periods of overlapping dates, the kind of seed to be used shall be determined. All rates are in pounds per acre.

All Roadway Areas

March 1 - August 31		September 1 - February 28	
50#	Tall Fescue	50#	Tall Fescue
10#	Centipede	10#	Centipede
25#	Bermudagrass (hulled)	35#	Bermudagrass (unhulled)
500#	Fertilizer	500#	Fertilizer
4000#	Limestone	4000#	Limestone

Waste and Borrow Locations

March 1 – August 31		September 1 - February 28	
75#	Tall Fescue	75#	Tall Fescue
25#	Bermudagrass (hulled)	35#	Bermudagrass (unhulled)
500#	Fertilizer	500#	Fertilizer
4000#	Limestone	4000#	Limestone

Note: 50# of Bahiagrass may be substituted for either Centipede or Bermudagrass only upon Engineer's request.

Approved Tall Fescue Cultivars

06 Dust	Escalade	Justice	Serengeti
2 nd Millennium	Essential	Kalahari	Shelby
3 rd Millennium	Evergreen 2	Kitty Hawk 2000	Sheridan
Apache III	Falcon IV	Legitimate	Signia
Avenger	Falcon NG	Lexington	Silver Hawk
Barlexas	Falcon V	LSD	Sliverstar
Barlexas II	Faith	Magellan	Shenandoah Elite
Bar Fa	Fat Cat	Matador	Sidewinder
Barrera	Festnova	Millennium SRP	Skyline
Barrington	Fidelity	Monet	Solara
Barrobusto	Finelawn Elite	Mustang 4	Southern Choice II
Barvado	Finelawn Xpress	Ninja 2	Speedway
Biltmore	Finesse II	Ol' Glory	Spyder LS
Bingo	Firebird	Olympic Gold	Sunset Gold
Bizem	Firecracker LS	Padre	Taccoa
Blackwatch	Firenza	Patagonia	Tanzania
Blade Runner II	Five Point	Pedigree	Trio
Bonsai	Focus	Picasso	Tahoe II
Braveheart	Forte	Piedmont	Talladega
Bravo	Garrison	Plantation	Tarheel
Bullseye	Gazelle II	Proseeds 5301	Terrano
Cannavaro	Gold Medallion	Prospect	Titan ltd
Catalyst	Grande 3	Pure Gold	Titanium LS
Cayenne	Greenbrooks	Quest	Tracer
Cessane Rz	Greenkeeper	Raptor II	Traverse SRP
Chipper	Gremlin	Rebel Exeda	Tulsa Time
Cochise IV	Greystone	Rebel Sentry	Turbo
Constitution	Guardian 21	Rebel IV	Turbo RZ
Corgi	Guardian 41	Regiment II	Tuxedo RZ
Corona	Hemi	Regenerate	Ultimate
Coyote	Honky Tonk	Rendition	Venture
Darlington	Hot Rod	Rhambler 2 SRP	Umbrella
Davinci	Hunter	Rembrandt	Van Gogh
Desire	Inferno	Reunion	Watchdog
Dominion	Innovator	Riverside	Wolfpack II
Dynamic	Integrity	RNP	Xtremegreen
Dynasty	Jaguar 3	Rocket	
Endeavor	Jamboree	Scorpion	

On cut and fill slopes 2:1 or steeper Centipede shall be applied at the rate of 5 pounds per acre and add 20# of Sericea Lespedeza from January 1 - December 31.

Fertilizer shall be 10-20-20 analysis. A different analysis of fertilizer may be used provided the 1-2-2 ratio is maintained and the rate of application adjusted to provide the same amount of plant food as a 10-20-20 analysis and as directed.

Native Grass Seeding And Mulching

(West)

Native Grass Seeding and Mulching shall be performed on the disturbed areas of wetlands and riparian areas, and adjacent to Stream Relocation and/or trout stream construction within a 50 foot zone on both sides of the stream or depression, measured from top of stream bank or center of depression. The stream bank of the stream relocation shall be seeded by a method that does not alter the typical cross section of the stream bank. Native Grass Seeding and Mulching shall also be performed in the permanent soil reinforcement mat section of preformed scour holes, and in other areas as directed.

The kinds of seed and fertilizer, and the rates of application of seed, fertilizer, and limestone, shall be as stated below. During periods of overlapping dates, the kind of seed to be used shall be determined. All rates are in pounds per acre.

August 1 - June 1

- 18# Creeping Red Fescue
- 8# Big Bluestem
- 6# Indiangrass
- 4# Switchgrass
- 35# Rye Grain
- 500# Fertilizer
- 4000# Limestone

May 1 – September 1

- 18# Creeping Red Fescue
- 8# Big Bluestem
- 6# Indiangrass
- 4# Switchgrass
- 25# German or Browntop Millet
- 500# Fertilizer
- 4000# Limestone

Approved Creeping Red Fescue Cultivars:

Aberdeen

Boreal

Epic

Cindy Lou

Fertilizer shall be 10-20-20 analysis. A different analysis of fertilizer may be used provided the 1-2-2 ratio is maintained and the rate of application adjusted to provide the same amount of plant food as a 10-20-20 analysis and as directed.

Native Grass Seeding and Mulching shall be performed in accordance with Section 1660 of the *Standard Specifications* and vegetative cover sufficient to restrain erosion shall be installed immediately following grade establishment.

Measurement and Payment

Native Grass *Seeding and Mulching* will be measured and paid for in accordance with Article 1660-8 of the *Standard Specifications*.

All areas seeded and mulched shall be tacked with asphalt. Crimping of straw in lieu of asphalt tack shall not be allowed on this project.

CRIMPING STRAW MULCH:

Crimping shall be required on this project adjacent to any section of roadway where traffic is to be maintained or allowed during construction. In areas within six feet of the edge of pavement, straw is to be applied and then crimped. After the crimping operation is complete, an additional application of straw shall be applied and immediately tacked with a sufficient amount of undiluted emulsified asphalt.

Straw mulch shall be of sufficient length and quality to withstand the crimping operation.

Crimping equipment including power source shall be subject to the approval of the Engineer providing that maximum spacing of crimper blades shall not exceed 8".

TEMPORARY SEEDING:

Fertilizer shall be the same analysis as specified for *Seeding and Mulching* and applied at the rate of 400 pounds and seeded at the rate of 50 pounds per acre. Sweet Sudan Grass, German Millet or Browntop Millet shall be used in summer months and Rye Grain during the remainder of the year. The Engineer will determine the exact dates for using each kind of seed.

FERTILIZER TOPDRESSING:

Fertilizer used for topdressing on all roadway areas except slopes 2:1 and steeper shall be 10-20-20 grade and shall be applied at the rate of 500 pounds per acre. A different analysis of fertilizer may be used provided the 1-2-2 ratio is maintained and the rate of application adjusted to provide the same amount of plant food as 10-20-20 analysis and as directed.

Fertilizer used for topdressing on slopes 2:1 and steeper and waste and borrow areas shall be 16-8-8 grade and shall be applied at the rate of 500 pounds per acre. A different analysis of fertilizer may be used provided the 2-1-1 ratio is maintained and the rate of application adjusted to provide the same amount of plant food as 16-8-8 analysis and as directed.

SUPPLEMENTAL SEEDING:

The kinds of seed and proportions shall be the same as specified for *Seeding and Mulching*, with the exception that no centipede seed will be used in the seed mix for supplemental seeding. The rate of application for supplemental seeding may vary from 25# to 75# per acre. The actual rate per acre will be determined prior to the time of topdressing and the Contractor will be notified in writing of the rate per acre, total quantity needed, and areas on which to apply the supplemental seed. Minimum tillage equipment, consisting of a sod seeder shall be used for incorporating seed into the soil as to prevent disturbance of existing vegetation. A clodbuster (ball and chain) may be used where degree of slope prevents the use of a sod seeder.

MOWING:

The minimum mowing height on this project shall be 4 inches.

RESPONSE FOR EROSION CONTROL:**Description**

Furnish the labor, materials, tools and equipment necessary to move personnel, equipment, and supplies to the project necessary for the pursuit of any or all of the following work as shown herein, by an approved subcontractor.

Section	Erosion Control Item	Unit
1605	Temporary Silt Fence	LF
1606	Special Sediment Control Fence	LF/TON
1615	Temporary Mulching	ACR
1620	Seed - Temporary Seeding	LB
1620	Fertilizer - Temporary Seeding	TN
1631	Matting for Erosion Control	SY
SP	Coir Fiber Mat	SY
1640	Coir Fiber Baffles	LF
SP	Permanent Soil Reinforcement Mat	SY
1660	Seeding and Mulching	ACR
1661	Seed - Repair Seeding	LB
1661	Fertilizer - Repair Seeding	TON
1662	Seed - Supplemental Seeding	LB
1665	Fertilizer Topdressing	TON
SP	Safety/Highly Visible Fencing	LF
SP	Response for Erosion Control	EA

Construction Methods

Provide an approved subcontractor who performs an erosion control action as described in the NPDES Inspection Form SPPP30. Each erosion control action may include one or more of the above work items.

Measurement and Payment

Response for Erosion Control will be measured and paid for by counting the actual number of times the subcontractor moves onto the project, including borrow and waste sites, and satisfactorily completes an erosion control action described in Form 1675. The provisions of Article 104-5 of the *Standard Specifications* will not apply to this item of work.

Payment will be made under:

Pay Item	Pay Unit
Response for Erosion Control	Each

HIGH QUALITY WATERS:

Description

Drowning Creek has been identified as high quality waters. This designation requires special procedures to be used for clearing and grubbing, temporary stream crossings, and grading operations within the High Quality Water Zone and as designated by the Engineer. The High Quality Water Zones are identified on the plans as Environmentally Sensitive Areas. This also requires special procedures to be used for seeding and mulching and staged seeding.

The High Quality Water Zone/Environmentally Sensitive Area shall be defined as a 50-foot buffer zone on both sides of the stream measured from top of streambank.

Construction Methods

(A) Clearing and Grubbing

In areas identified as High Quality Water Zones/Environmentally Sensitive Areas, the Contractor may perform clearing operations, but not grubbing operations until immediately prior to beginning grading operations as described in Article 200-1 of the *Standard Specifications*. Only clearing operations (not grubbing) shall be allowed in this buffer zone until immediately prior to beginning grading operations. Erosion control devices shall be installed immediately following the clearing operation.

(B) Grading

Once grading operations begin in identified High Quality Water Zones/ Environmentally Sensitive Areas, work shall progress in a continuous manner until complete. All construction within these areas shall progress in a continuous manner such that each phase is complete and areas are permanently stabilized prior to beginning of next phase. Failure on the part of the Contractor to complete any phase of construction in a continuous manner in High Quality Water Zones/ Environmentally Sensitive Areas will be just cause for the Engineer to direct the suspension of work in accordance with Article 108-7 of the *Standard Specifications*.

(C) Temporary Stream Crossings

Any crossing of streams within the limits of this project shall be accomplished in accordance with the requirements of Subarticle 107-12 of the *Standard Specifications*.

(D) Seeding and Mulching

Seeding and mulching shall be performed in accordance with Section 1660 of the *Standard Specifications* and vegetative cover sufficient to restrain erosion shall be installed immediately following grade establishment.

Seeding and mulching shall be performed on the areas disturbed by construction immediately following final grade establishment. No appreciable time shall lapse into the contract time without stabilization of slopes, ditches and other areas within the High Quality Water Zones/Environmentally Sensitive Areas.

(E) Stage Seeding

The work covered by this section shall consist of the establishment of a vegetative cover on cut and fill slopes as grading progresses. Seeding and mulching shall be done in stages on cut and fill slopes that are greater than 20 feet in height measured along the slope, or greater than 2 acres in area. Each stage shall not exceed the limits stated above.

Additional payments will not be made for the requirements of this section, as the cost for this work shall be included in the contract unit prices for the work involved.

MINIMIZE REMOVAL OF VEGETATION:

The Contractor shall minimize removal of vegetation within project limits to the maximum extent practicable. Vegetation along stream banks and adjacent to other jurisdictional resources outside the construction limits shall only be removed upon approval of Engineer. No additional payment will be made for this minimization work.

STOCKPILE AREAS:

The Contractor shall install and maintain erosion control devices sufficient to contain sediment around any erodible material stockpile areas as directed.

ACCESS AND HAUL ROADS:

At the end of each working day, the Contractor shall install or re-establish temporary diversions or earth berms across access/haul roads to direct runoff into sediment devices. Silt fence sections that are temporarily removed shall be reinstalled across access/haul roads at the end of each working day.

WASTE AND BORROW SOURCES:

Payment for temporary erosion control measures, except those made necessary by the Contractor's own negligence or for his own convenience, will be paid for at the appropriate contract unit price for the devices or measures utilized in borrow sources and waste areas.

No additional payment will be made for erosion control devices or permanent seeding and mulching in any commercial borrow or waste pit. All erosion and sediment control practices that may be required on a commercial borrow or waste site will be done at the Contractor's expense.

All offsite Staging Areas, Borrow and Waste sites shall be in accordance with "Borrow and Waste Site Reclamation Procedures for Contracted Projects" located at:

http://www.ncdot.gov/doh/operations/dp_chief_eng/roadside/fieldops/downloads/Files/ContractedReclamationProcedures.pdf

All forms and documents referenced in the "Borrow and Waste Site Reclamation Procedures for Contracted Projects" shall be included with the reclamation plans for offsite staging areas, and borrow and waste sites.

SAFETY FENCE AND JURISDICTIONAL FLAGGING:**Description**

Safety Fence shall consist of furnishing materials, installing and maintaining polyethylene or polypropylene fence along the outside riparian buffer, wetland, or water boundary, or other boundaries located within the construction corridor to mark the areas that have been approved to infringe within the buffer, wetland, endangered vegetation, culturally sensitive areas or water. The fence shall be installed prior to any land disturbing activities.

Interior boundaries for jurisdictional areas noted above shall be delineated by stakes and highly visible flagging.

Jurisdictional boundaries at staging areas, waste sites, or borrow pits, whether considered outside or interior boundaries shall be delineated by stakes and highly visible flagging.

Materials**(A) Safety Fencing**

Polyethylene or polypropylene fence shall be a highly visible preconstructed safety fence approved by the Engineer. The fence material shall have an ultraviolet coating.

Either wood posts or steel posts may be used. Wood posts shall be hardwood with a wedge or pencil tip at one end, and shall be at least 5 ft. in length with a minimum nominal 2" x 2" cross

section. Steel posts shall be at least 5 ft. in length, and have a minimum weight of 0.85 lb/ft of length.

(B) Boundary Flagging

Wooden stakes shall be 4 feet in length with a minimum nominal 3/4" x 1-3/4" cross section. The flagging shall be at least 1" in width. The flagging material shall be vinyl and shall be orange in color and highly visible.

Construction Methods

No additional clearing and grubbing is anticipated for the installation of this fence. The fence shall be erected to conform to the general contour of the ground.

(A) Safety Fencing

Posts shall be set at a maximum spacing of 10 ft., maintained in a vertical position and hand set or set with a post driver. Posts shall be installed a minimum of 2 ft. into the ground. If hand set, all backfill material shall be thoroughly tamped. Wood posts may be sharpened to a dull point if power driven. Posts damaged by power driving shall be removed and replaced prior to final acceptance. The tops of all wood posts shall be cut at a 30-degree angle. The wood posts may, at the option of the Contractor, be cut at this angle either before or after the posts are erected.

The fence geotextile shall be attached to the wood posts with one 2" galvanized wire staple across each cable or to the steel posts with wire or other acceptable means.

Place construction stakes to establish the location of the safety fence in accordance with Article 105-9 or Article 801-1 of the *Standard Specifications*. No direct pay will be made for the staking of the safety fence. All stakeouts for safety fence shall be considered incidental to the work being paid for as "Construction Surveying", except that where there is no pay item for construction surveying, all safety fence stakeout will be performed by state forces.

The Contractor shall be required to maintain the safety fence in a satisfactory condition for the duration of the project as determined by the Engineer.

(B) Boundary Flagging

Boundary flagging delineation of interior boundaries shall consist of wooden stakes on 25 feet maximum intervals with highly visible orange flagging attached. Stakes shall be installed a minimum of 6" into the ground. Interior boundaries may be staked on a tangent that runs parallel to buffer but must not encroach on the buffer at any location. Interior boundaries of hand clearing shall be identified with a different colored flagging to distinguish it from mechanized clearing.

Boundary flagging delineation of interior boundaries will be placed in accordance with Article 105-9 or Article 801-1 of the *Standard Specifications*. No direct pay will be made for delineation of the interior boundaries. This delineation will be considered incidental to the work being paid

for as *Construction Surveying*, except that where there is no pay item or construction surveying the cost of boundary flagging delineation shall be included in the unit prices bid for the various items in the contract. Installation for delineation of all jurisdictional boundaries at staging areas, waste sites, or borrow pits shall consist of wooden stakes on 25 feet maximum intervals with highly visible orange flagging attached. Stakes shall be installed a minimum of 6" into the ground. Additional flagging may be placed on overhanging vegetation to enhance visibility but does not substitute for installation of stakes.

Installation of boundary flagging for delineation of all jurisdictional boundaries at staging areas, waste sites, or borrow pits shall be performed in accordance with Subarticle 230-4(B)(5) or Subarticle 802-2(F) of the *Standard Specifications*. No direct pay will be made for this delineation, as the cost of same shall be included in the unit prices bid for the various items in the contract.

The Contractor shall be required to maintain alternative stakes and highly visible flagging in a satisfactory condition for the duration of the project as determined by the Engineer.

Measurement and Payment

Safety Fence will be measured and paid as the actual number of linear feet of polyethylene or polypropylene fence installed in place and accepted. Such payment will be full compensation including but not limited to furnishing and installing fence geotextile with necessary posts and post bracing, staples, tie wires, tools, equipment and incidentals necessary to complete this work.

Payment will be made under:

Pay Item
Safety Fence

Pay Unit
Linear Foot

IMPERVIOUS DIKE:

Description

This work consists of furnishing, installing, maintaining, and removing an *Impervious Dike* for the purpose of diverting normal stream flow around the construction site. The Contractor shall construct an impervious dike in such a manner approved by the Engineer. The impervious dike shall not permit seepage of water into the construction site or contribute to siltation of the stream. The impervious dike shall be constructed of an acceptable material in the locations noted on the plans or as directed.

Materials

Acceptable materials shall include but not be limited to sheet piles, sandbags, and/or the placement of an acceptable size stone lined with polypropylene or other impervious geotextile.

Earth material shall not be used to construct an impervious dike when it is in direct contact with the stream unless vegetation can be established before contact with the stream takes place.

Measurement and Payment

Impervious Dike will be measured and paid as the actual number of linear feet of impervious dike(s) constructed, measured in place from end to end of each separate installation that has been completed and accepted. Such price and payment will be full compensation for all work including but not limited to furnishing materials, construction, maintenance, and removal of the impervious dike.

Payment will be made under:

Pay Item	Pay Unit
Impervious Dike	Linear Foot

COIR FIBER MAT:**Description**

Furnish material, install and maintain coir fiber mat in locations shown on the plans or in locations as directed. Work includes providing all materials, excavating and backfilling, and placing and securing coir fiber mat with stakes, steel reinforcement bars or staples as directed.

Materials

Item	Section
Coir Fiber Mat	1060-14

Anchors: Stakes, reinforcement bars, or staples shall be used as anchors.

Wooden Stakes:

Provide hardwood stakes 12"- 24" long with a 2" x 2" nominal square cross section. One end of the stake must be sharpened or beveled to facilitate driving through the coir fiber mat and down into the underlying soil. The other end of the stake needs to have a 1"- 2" long head at the top with a 1"- 2" notch following to catch and secure the coir fiber mat.

Steel Reinforcement Bars:

Provide uncoated #10 steel reinforcement bars 24" nominal length. The bars shall have a 4" diameter bend at one end with a 4" straight section at the tip to catch and secure the coir fiber mat.

Staples:

Provide staples made of 0.125" diameter new steel wire formed into a *u* shape not less than 12" in length with a throat of 1" in width.

Construction Methods

Place the coir fiber mat immediately upon final grading. Provide a smooth soil surface free from stones, clods, or debris that will prevent the contact of the mat with the soil. Unroll the mat and apply without stretching such that it will lie smoothly but loosely on the soil surface.

For stream relocation applications, take care to preserve the required line, grade, and cross section of the area covered. Bury the top slope end of each piece of mat in a narrow trench at least 6 in. deep and tamp firmly. Where one roll of matting ends and a second roll begins, overlap the end of the upper roll over the buried end of the second roll so there is a 6 in. overlap. Construct check trenches at least 12 in. deep every 50 ft. longitudinally along the edges of the mat or as directed. Fold over and bury mat to the full depth of the trench, close and tamp firmly. Overlap mat at least 6 in. where 2 or more widths of mat are installed side by side.

Place anchors across the mat at the ends approximately 1 ft. apart. Place anchors along the outer edges and down the center of the mat 3 ft. apart.

Adjustments in the trenching or anchoring requirements to fit individual site conditions may be required.

Measurement and Payment

Coir Fiber Mat will be measured and paid for as the actual number of square yards measured along the surface of the ground over which coir fiber mat is installed and accepted.

No measurement will be made for anchor items.

Payment will be made under:

Pay Item	Pay Unit
Coir Fiber Mat	Square Yard

FLOATING TURBIDITY CURTAIN:

Description

This work consists of furnishing a *Floating Turbidity Curtain* to deter silt suspension and movement of silt particles during construction. The floating turbidity curtain shall be constructed at locations as directed.

Materials

The curtain material shall be made of a tightly woven nylon, plastic or other non-deteriorating material meeting the following specifications:

Property	Value
Grab tensile strength	*md-370 lbs *cd-250 lbs
Mullen burst strength	480 psi
Trapezoid tear strength	*md-100 lbs *cd-60 lbs
Apparent opening size	70 US standard sieve
Percent open area	4% permittivity 0.28 sec-1

*md - machine direction

*cd - cross machine direction

In the event that more than one width of fabric is required, a 6" overlap of the material shall also be required.

The curtain material shall be supported by a flotation material having over 29 lbs/ft buoyancy. The floating curtain shall have a 5/16" galvanized chain as ballast and dual 5/16" galvanized wire ropes with a heavy vinyl coating as load lines.

Construction Methods

The Contractor shall maintain the *Floating Turbidity Curtain* in a satisfactory condition until its removal is requested by the Engineer. The curtain shall extend to the bottom of the jurisdictional resource. Anchor the curtain according to manufacturer recommendations.

Measurement and Payment

Floating Turbidity Curtain will be measured and paid for as the actual number of square yards of curtain furnished as specified and accepted. Such price and payment will be full compensation for the work as described in this section including but not limited to furnishing all materials, tools, equipment, and all incidentals necessary to complete the work.

Payment will be made under:

Pay Item	Pay Unit
Floating Turbidity Curtain	Square Yard

CONCRETE WASHOUT STRUCTURE:

(12-01-15)

Description

Concrete washout structures are enclosures above or below grade to contain concrete waste water and associated concrete mix from washing out ready-mix trucks, drums, pumps, or other equipment. Concrete washouts must collect and retain all the concrete washout water and solids, so that this material does not migrate to surface waters or into the ground water. These enclosures are not intended for concrete waste not associated with wash out operations.

The concrete washout structure may include constructed devices above or below ground and or commercially available devices designed specifically to capture concrete waste water.

Materials

Item	Section
Temporary Silt Fence	1605

Safety Fence shall meet the specifications as provided elsewhere in this contract.

Geomembrane basin liner shall meet the following minimum physical properties for low permeability; it shall consist of a polypropylene or polyethylene 10 mil thick geomembrane. If the minimum setback dimensions can be achieved the liner is not required. (5 feet above groundwater, 50 feet from top of bank of perennial stream, other surface water body, or wetland.)

Construction Methods

Build an enclosed earthen berm or excavate to form an enclosure in accordance with the details and as directed.

Install temporary silt fence around the perimeter of the enclosure in accordance with the details and as directed if structure is not located in an area where existing erosion and sedimentation control devices are capable to containing any loss of sediment.

Post a sign with the words "Concrete Washout" in close proximity of the concrete washout area, so it is clearly visible to site personnel.

The construction details for the above grade and below grade concrete washout structures can be found on the following web page link:

http://www.ncdot.gov/doh/operations/dp_chief_eng/roadside/soil_water/details/

[Alternate details for accommodating concrete washout may be submitted for review and approval.](#)

[The alternate details shall include the method used to retain and dispose of the concrete waste water within the project limits and in accordance with the minimum setback requirements.](#) (5 feet above groundwater, 50 feet from top of bank of perennial stream, other surface water body, or wetland.)

Maintenance and Removal

Maintain the concrete washout structure(s) to provide adequate holding capacity plus a minimum freeboard of 12 inches. Remove and dispose of hardened concrete and return the structure to a functional condition after reaching 75% capacity.

Inspect concrete washout structures for damage and maintain for effectiveness.

Remove the concrete washout structures and sign upon project completion. Grade the earth material to match the existing contours and permanently seed and mulch area.

Measurement and Payment

Concrete Washout Structure will be paid for per each enclosure installed in accordance with the details. If alternate details are approved then those details will also be paid for per each approved and installed device.

Temporary Silt Fence will be measured and paid for in accordance with Article 1605-5 of the *Standard Specifications*.

No measurement will be made for other items or for over excavation or stockpiling.

Payment will be made under:

Pay Item	Pay Unit
Concrete Washout Structure	Each

ST-1

Project B-5362

Montgomery County

Project Special Provisions Structure

Table of Contents

		Page #
Concrete Wearing Surface	(9-30-11) -----	ST-2
Falsework and Formwork	(4-5-12) -----	ST-3
Submittal of Working Drawings	(6-28-17) -----	ST-9
Crane Safety	(8-15-05) -----	ST-16
Grout for Structures	(9-30-11) -----	ST-16
Asbestos Assessment for Bridge Demolition And Renovation Activities	(12-30-15) -----	ST-18

For Piles, see Geotechnical Special Provisions

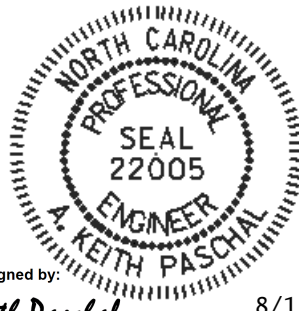

DocuSigned by:

A. Keith Paschal

8/1/2017

F8B6AD6DB2FC48F...

PROJECT SPECIAL PROVISIONS
STRUCTURE

CONCRETE WEARING SURFACE**(9-30-11)****1.0 GENERAL**

This Special Provision governs materials, forming, and all other related work in the construction of a reinforced concrete wearing surface in accordance with applicable parts of the Standard Specifications, the details shown on the plans, and as outlined in these Special Provisions.

2.0 MATERIALS

Unless otherwise noted on the plans, use class AA concrete and a coarse aggregate gradation of 78M. The Class AA concrete shall contain fly ash or ground granulated blast furnace slag at the substitution rate specified in Article 1024-1 and in accordance with Articles 1024-5 and 1024-6 of the Standard Specifications. Place the wearing surface according to the grades, thicknesses and cross sections shown on the plans.

3.0 PREPARATION OF SURFACE

Prepare all surfaces to be overlaid using the equipment specified herein and prior to placing the epoxy coated reinforcing steel. Additionally, clean the surface within 48 hours prior to placing the overlay unless otherwise approved.

Thoroughly soak the cleaned surface for at least 12 hours prior to placing the concrete wearing surface. While soaking the surface, cover it with a layer of white opaque polyethylene film that is at least 4 mils thick. Immediately prior to placing the concrete wearing surface, remove standing water from the surface.

4.0 EQUIPMENT

Prior to beginning any work, obtain approval for all equipment to be used for deck preparation, placing, finishing, and curing the concrete wearing surface.

For surface preparation, use sandblasting or pressure washing equipment capable of removing all foreign matter. If using high pressure water blast, a minimum nozzle pressure of 3000 psi is required.

5.0 PLACING AND FINISHING

Follow the placing, finishing, and curing requirements of Article 420-14 (A) and (B). Construction Joints other than those shown on the plans are not permitted.

6.0 LIMITATIONS OF OPERATIONS

The requirements of Article 420-20 will apply to placing vehicles and construction equipment on the finished concrete wearing surface.
Use insulation that meets the requirements of Article 420-7(C), and if required, place it on the concrete wearing surface as soon as the initial set permits.

7.0 METHOD OF MEASUREMENT

The quantity of concrete wearing surface to be paid for is the actual number of square feet of concrete wearing surface as provided on the plans.

8.0 BASIS OF PAYMENT

The quantity for which payment is made will be that quantity shown in square feet on the plans. Where the plans have been revised, the quantity to be paid for will be the quantity shown on the revised plans.

The unit bid per square foot will be full compensation for all work covered by this Special Provision and applicable parts of the Standard Specifications, but not limited to furnishing and placing concrete, epoxy coated reinforcing steel, joint filler and sealer, deck drains, bridge scuppers, and any other material; erecting and removing all forms, curing concrete, protecting concrete in wind, rain, low humidity, high temperatures or other unfavorable weather.

Payment will be made under:
Concrete Wearing Surface..... Square Foot

FALSEWORK AND FORMWORK (4-5-12)

1.0 DESCRIPTION

Use this Special Provision as a guide to develop temporary works submittals required by the Standard Specifications or other provisions; no additional submittals are required herein. Such temporary works include, but are not limited to, falsework and formwork.

Falsework is any temporary construction used to support the permanent structure until it becomes self-supporting. Formwork is the temporary structure or mold used to retain plastic or fluid concrete in its designated shape until it hardens. Access scaffolding is a temporary structure that functions as a work platform that supports construction personnel, materials, and tools, but is not intended to support the structure. Scaffolding systems that are used to temporarily support permanent structures (as opposed to functioning as work platforms) are considered to be falsework under the definitions given. Shoring is a component of falsework such as horizontal, vertical, or inclined support members. Where the term “temporary works” is used, it includes all of the temporary facilities used in bridge construction that do not become part of the permanent structure.

Design and construct safe and adequate temporary works that will support all loads imposed and provide the necessary rigidity to achieve the lines and grades shown on the plans in the final structure.

2.0 MATERIALS

Select materials suitable for temporary works; however, select materials that also ensure the safety and quality required by the design assumptions. The Engineer has authority to reject material on the basis of its condition, inappropriate use, safety, or nonconformance with the plans. Clearly identify allowable loads or stresses for all materials or manufactured devices on the plans. Revise the plan and notify the Engineer if any change to materials or material strengths is required.

3.0 DESIGN REQUIREMENTS

A. Working Drawings

Provide working drawings for items as specified in the contract, or as required by the Engineer, with design calculations and supporting data in sufficient detail to permit a structural and safety review of the proposed design of the temporary work.

On the drawings, show all information necessary to allow the design of any component to be checked independently as determined by the Engineer.

When concrete placement is involved, include data such as the drawings of proposed sequence, rate of placement, direction of placement, and location of all construction joints. Submit the number of copies as called for by the contract.

When required, have the drawings and calculations prepared under the guidance of, and sealed by, a North Carolina Registered Professional Engineer who is knowledgeable in temporary works design.

If requested by the Engineer, submit with the working drawings manufacturer's catalog data listing the weight of all construction equipment that will be supported on the temporary work. Show anticipated total settlements and/or deflections of falsework and forms on the working drawings. Include falsework footing settlements, joint take-up, and deflection of beams or girders.

As an option for the Contractor, overhang falsework hangers may be uniformly spaced, at a maximum of 36 inches, provided the following conditions are met:

Member Type (PCG)	Member Depth, (inches)	Max. Overhang Width, (inches)	Max. Slab Edge Thickness, (inches)	Max. Screenshot Wheel Weight, (lbs.)	Bracket Min. Vertical Leg Extension, (inches)
II	36	39	14	2000	26
III	45	42	14	2000	35
IV	54	45	14	2000	44

ST-5

Project B-5362

Montgomery County

MBT	63	51	12	2000	50
MBT	72	55	12	1700	48

Overhang width is measured from the centerline of the girder to the edge of the deck slab.

For Type II, III & IV prestressed concrete girders (PCG), 45-degree cast-in-place half hangers and rods must have a minimum safe working load of 6,000 lbs.

For MBT prestressed concrete girders, 45-degree angle holes for falsework hanger rods shall be cast through the girder top flange and located, measuring along the top of the member, 1'-2 1/2" from the edge of the top flange. Hanger hardware and rods must have a minimum safe working load of 6,000 lbs.

The overhang bracket provided for the diagonal leg shall have a minimum safe working load of 3,750 lbs. The vertical leg of the bracket shall extend to the point that the heel bears on the girder bottom flange, no closer than 4 inches from the bottom of the member. However, for 72-inch members, the heel of the bracket shall bear on the web, near the bottom flange transition.

Provide adequate overhang falsework and determine the appropriate adjustments for deck geometry, equipment, casting procedures and casting conditions.

If the optional overhang falsework spacing is used, indicate this on the falsework submittal and advise the girder producer of the proposed details. Failure to notify the Engineer of hanger type and hanger spacing on prestressed concrete girder casting drawings may delay the approval of those drawings.

Falsework hangers that support concentrated loads and are installed at the edge of thin top flange concrete girders (such as bulb tee girders) shall be spaced so as not to exceed 75% of the manufacturer's stated safe working load. Use of dual leg hangers (such as Meadow Burke HF-42 and HF-43) are not allowed on concrete girders with thin top flanges. Design the falsework and forms supporting deck slabs and overhangs on girder bridges so that there will be no differential settlement between the girders and the deck forms during placement of deck concrete.

When staged construction of the bridge deck is required, detail falsework and forms for screed and fluid concrete loads to be independent of any previous deck pour components when the mid-span girder deflection due to deck weight is greater than 3/4".

Note on the working drawings any anchorages, connectors, inserts, steel sleeves or other such devices used as part of the falsework or formwork that remains in the permanent structure. If the plan notes indicate that the structure contains the necessary corrosion protection required for a Corrosive Site, epoxy coat, galvanize or metalize these devices. Electroplating will not be allowed. Any coating required by the Engineer will be considered incidental to the various pay items requiring temporary works.

Design falsework and formwork requiring submittals in accordance with the 1995 AASHTO *Guide Design Specifications for Bridge Temporary Works* except as noted herein.

1. Wind Loads

Table 2.2 of Article 2.2.5.1 is modified to include wind velocities up to 110 mph. In addition, Table 2.2A is included to provide the maximum wind speeds by county in North Carolina.

Table 2.2 - Wind Pressure Values

Height Zone feet above ground	Pressure, lb/ft ² for Indicated Wind Velocity, mph				
	70	80	90	100	110
0 to 30	15	20	25	30	35
30 to 50	20	25	30	35	40
50 to 100	25	30	35	40	45
over 100	30	35	40	45	50

2. Time of Removal

The following requirements replace those of Article 3.4.8.2.

Do not remove forms until the concrete has attained strengths required in Article 420-16 of the Standard Specifications and these Special Provisions.

Do not remove forms until the concrete has sufficient strength to prevent damage to the surface.

Table 2.2A - Steady State Maximum Wind Speeds by Counties in North Carolina

COUNTY	25 YR (mph)	COUNTY	25 YR (mph)	COUNTY	25 YR (mph)
Alamance	70	Franklin	70	Pamlico	100
Alexander	70	Gaston	70	Pasquotank	100
Alleghany	70	Gates	90	Pender	100
Anson	70	Graham	80	Perquimans	100
Ashe	70	Granville	70	Person	70
Avery	70	Greene	80	Pitt	90
Beaufort	100	Guilford	70	Polk	80
Bertie	90	Halifax	80	Randolph	70
Bladen	90	Harnett	70	Richmond	70
Brunswick	100	Haywood	80	Robeson	80
Buncombe	80	Henderson	80	Rockingham	70
Burke	70	Hertford	90	Rowan	70
Cabarrus	70	Hoke	70	Rutherford	70
Caldwell	70	Hyde	110	Sampson	90
Camden	100	Iredell	70	Scotland	70
Carteret	110	Jackson	80	Stanley	70
Caswell	70	Johnston	80	Stokes	70
Catawba	70	Jones	100	Surry	70
Cherokee	80	Lee	70	Swain	80
Chatham	70	Lenoir	90	Transylvania	80
Chowan	90	Lincoln	70	Tyrell	100
Clay	80	Macon	80	Union	70
Cleveland	70	Madison	80	Vance	70
Columbus	90	Martin	90	Wake	70
Craven	100	McDowell	70	Warren	70
Cumberland	80	Mecklenburg	70	Washington	100
Currituck	100	Mitchell	70	Watauga	70
Dare	110	Montgomery	70	Wayne	80
Davidson	70	Moore	70	Wilkes	70
Davie	70	Nash	80	Wilson	80
Duplin	90	New Hanover	100	Yadkin	70
Durham	70	Northampton	80	Yancey	70
Edgecombe	80	Onslow	100		
Forsyth	70	Orange	70		

B. Review and Approval

The Engineer is responsible for the review and approval of temporary works' drawings.

Submit the working drawings sufficiently in advance of proposed use to allow for their review, revision (if needed), and approval without delay to the work.

The time period for review of the working drawings does not begin until complete drawings and design calculations, when required, are received by the Engineer.

Do not start construction of any temporary work for which working drawings are required until the drawings have been approved. Such approval does not relieve the Contractor of the responsibility for the accuracy and adequacy of the working drawings.

4.0 CONSTRUCTION REQUIREMENTS

All requirements of Section 420 of the Standard Specifications apply.

Construct temporary works in conformance with the approved working drawings. Ensure that the quality of materials and workmanship employed is consistent with that assumed in the design of the temporary works. Do not weld falsework members to any portion of the permanent structure unless approved. Show any welding to the permanent structure on the approved construction drawings.

Provide tell-tales attached to the forms and extending to the ground, or other means, for accurate measurement of falsework settlement. Make sure that the anticipated compressive settlement and/or deflection of falsework does not exceed 1 inch. For cast-in-place concrete structures, make sure that the calculated deflection of falsework flexural members does not exceed 1/240 of their span regardless of whether or not the deflection is compensated by camber strips.

A. Maintenance and Inspection

Inspect and maintain the temporary work in an acceptable condition throughout the period of its use. Certify that the manufactured devices have been maintained in a condition to allow them to safely carry their rated loads. Clearly mark each piece so that its capacity can be readily determined at the job site.

Perform an in-depth inspection of an applicable portion(s) of the temporary works, in the presence of the Engineer, not more than 24 hours prior to the beginning of each concrete placement. Inspect other temporary works at least once a month to ensure that they are functioning properly. Have a North Carolina Registered Professional Engineer inspect the cofferdams, shoring, sheathing, support of excavation structures, and support systems for load tests prior to loading.

B. Foundations

Determine the safe bearing capacity of the foundation material on which the supports for temporary works rest. If required by the Engineer, conduct load tests to verify proposed bearing capacity values that are marginal or in other high-risk situations.

The use of the foundation support values shown on the contract plans of the permanent structure is permitted if the foundations are on the same level and on the same soil as those of the permanent structure.

Allow for adequate site drainage or soil protection to prevent soil saturation and washout of the soil supporting the temporary works supports.

If piles are used, the estimation of capacities and later confirmation during construction using standard procedures based on the driving characteristics of the pile is permitted. If preferred, use load tests to confirm the estimated capacities; or, if required by the Engineer conduct load tests to verify bearing capacity values that are marginal or in other high risk situations.

The Engineer reviews and approves the proposed pile and soil bearing capacities.

5.0 REMOVAL

Unless otherwise permitted, remove and keep all temporary works upon completion of the work. Do not disturb or otherwise damage the finished work.

Remove temporary works in conformance with the contract documents. Remove them in such a manner as to permit the structure to uniformly and gradually take the stresses due to its own weight.

6.0 METHOD OF MEASUREMENT

Unless otherwise specified, temporary works will not be directly measured.

7.0 BASIS OF PAYMENT

Payment at the contract unit prices for the various pay items requiring temporary works will be full compensation for the above falsework and formwork.

SUBMITTAL OF WORKING DRAWINGS

(6-28-17)

1.0 GENERAL

Submit working drawings in accordance with Article 105-2 of the *Standard Specifications* and this provision. For this provision, “submittals” refers to only those listed in this provision. The list of submittals contained herein does not represent a list of required

submittals for the project. Submittals are only necessary for those items as required by the contract. Make submittals that are not specifically noted in this provision directly to the Engineer. Either the Structures Management Unit or the Geotechnical Engineering Unit or both units will jointly review submittals.

If a submittal contains variations from plan details or specifications or significantly affects project cost, field construction or operations, discuss the submittal with and submit all copies to the Engineer. State the reason for the proposed variation in the submittal. To minimize review time, make sure all submittals are complete when initially submitted. Provide a contact name and information with each submittal. Direct any questions regarding submittal requirements to the Engineer, Structures Management Unit contacts or the Geotechnical Engineering Unit contacts noted below.

In order to facilitate in-plant inspection by NCDOT and approval of working drawings, provide the name, address and telephone number of the facility where fabrication will actually be done if different than shown on the title block of the submitted working drawings. This includes, but is not limited to, precast concrete items, prestressed concrete items and fabricated steel or aluminum items.

2.0 ADDRESSES AND CONTACTS

For submittals to the Structures Management Unit, use the following addresses:

Via US mail:

Mr. B. C. Hanks, P. E.
State Structures Engineer
North Carolina Department
of Transportation
Structures Management Unit
1581 Mail Service Center
Raleigh, NC 27699-1581

Attention: Mr. J. L. Bolden, P. E.

Via other delivery service:

Mr. B. C. Hanks, P. E.
State Structures Engineer
North Carolina Department
of Transportation
Structures Management Unit
1000 Birch Ridge Drive
Raleigh, NC 27610

Attention: Mr. J. L. Bolden, P. E.

Submittals may also be made via email.

Send submittals to:

jlbolden@ncdot.gov (James Bolden)

Send an additional e-copy of the submittal to the following address:

eomile@ncdot.gov (Emmanuel Omile)

mrorie@ncdot.gov (Madonna Rorie)

For submittals to the Geotechnical Engineering Unit, use the following addresses:

For projects in Divisions 1-7, use the following Eastern Regional Office address:

Via US mail:

Via other delivery service:

ST-11

Project B-5362

Montgomery County

Mr. Chris Kreider, P. E.
Eastern Regional Geotechnical
Manager
North Carolina Department
of Transportation
Geotechnical Engineering Unit
Eastern Regional Office
1570 Mail Service Center
Raleigh, NC 27699-1570

Mr. Chris Kreider, P. E.
Eastern Regional Geotechnical
Manager
North Carolina Department
of Transportation
Geotechnical Engineering Unit
Eastern Regional Office
3301 Jones Sausage Road, Suite 100
Garner, NC 27529

Via Email: EastGeotechnicalSubmittal@ncdot.gov

For projects in Divisions 8-14, use the following Western Regional Office address:

Via US mail or other delivery service:

Mr. Eric Williams, P. E.
Western Regional Geotechnical
Manager
North Carolina Department
of Transportation
Geotechnical Engineering Unit
Western Regional Office
5253 Z Max Boulevard
Harrisburg, NC 28075

Via Email: WestGeotechnicalSubmittal@ncdot.gov

The status of the review of structure-related submittals sent to the Structures Management Unit can be viewed from the Unit's website, via the "Drawing Submittal Status" link.

The status of the review of geotechnical-related submittals sent to the Geotechnical Engineering Unit can be viewed from the Unit's website, via the "Geotechnical Construction Submittals" link.

Direct any questions concerning submittal review status, review comments or drawing markups to the following contacts:

Primary Structures Contact:

James Bolden (919) 707 – 6408
(919) 250 – 4082 facsimile
jlbolden@ncdot.gov

Secondary Structures Contacts:

Emmanuel Omile (919) 707 – 6451
Madonna Rorie (919) 707 – 6508

Eastern Regional Geotechnical Contact (Divisions 1-7):

Chris Kreider (919) 662 – 4710
ckreider@ncdot.gov

ST-12

Project B-5362

Montgomery County

Western Regional Geotechnical Contact (Divisions 8-14):

Eric Williams (704) 455 – 8902
ewilliams3@ncdot.gov

3.0 SUBMITTAL COPIES

Furnish one complete copy of each submittal, including all attachments, to the Engineer. At the same time, submit the number of hard copies shown below of the same complete submittal directly to the Structures Management Unit and/or the Geotechnical Engineering Unit.

The first table below covers “Structure Submittals”. The Engineer will receive review comments and drawing markups for these submittals from the Structures Management Unit. The second table in this section covers “Geotechnical Submittals”. The Engineer will receive review comments and drawing markups for these submittals from the Geotechnical Engineering Unit.

Unless otherwise required, submit one set of supporting calculations to either the Structures Management Unit or the Geotechnical Engineering Unit unless both units require submittal copies in which case submit a set of supporting calculations to each unit. Provide additional copies of any submittal as directed.

STRUCTURE SUBMITTALS

Submittal	Copies Required by Structures Management Unit	Copies Required by Geotechnical Engineering Unit	Contract Reference Requiring Submittal ¹
Arch Culvert Falsework	5	0	Plan Note, SN Sheet & “Falsework and Formwork”
Box Culvert Falsework ⁷	5	0	Plan Note, SN Sheet & “Falsework and Formwork”
Cofferdams	6	2	Article 410-4
Foam Joint Seals ⁶	9	0	“Foam Joint Seals”
Expansion Joint Seals (hold down plate type with base angle)	9	0	“Expansion Joint Seals”
Expansion Joint Seals (modular)	2, then 9	0	“Modular Expansion Joint Seals”

ST-13

Project B-5362

Montgomery County

Expansion Joint Seals (strip seals)	9	0	“Strip Seals”
Falsework & Forms ² (substructure)	8	0	Article 420-3 & “Falsework and Formwork”
Falsework & Forms (superstructure)	8	0	Article 420-3 & “Falsework and Formwork”
Girder Erection over Railroad	5	0	Railroad Provisions
Maintenance and Protection of Traffic Beneath Proposed Structure	8	0	“Maintenance and Protection of Traffic Beneath Proposed Structure at Station ____”
Metal Bridge Railing	8	0	Plan Note
Metal Stay-in-Place Forms	8	0	Article 420-3
Metalwork for Elastomeric Bearings ^{4,5}	7	0	Article 1072-8
Miscellaneous Metalwork ^{4,5}	7	0	Article 1072-8
Disc Bearings ⁴	8	0	“Disc Bearings”
Overhead and Digital Message Signs (DMS) (metalwork and foundations)	13	0	Applicable Provisions
Placement of Equipment on Structures (cranes, etc.)	7	0	Article 420-20
Precast Concrete Box Culverts	2, then 1 reproducible	0	“Optional Precast Reinforced Concrete Box Culvert at Station ____”
Prestressed Concrete Cored Slab (detensioning sequences) ³	6	0	Article 1078-11
Prestressed Concrete Deck Panels	6 and 1 reproducible	0	Article 420-3
Prestressed Concrete Girder (strand elongation and detensioning sequences)	6	0	Articles 1078-8 and 1078- 11
Removal of Existing Structure over Railroad	5	0	Railroad Provisions

ST-14

Project B-5362

Montgomery County

Revised Bridge Deck Plans (adaptation to prestressed deck panels)	2, then 1 reproducible	0	Article 420-3
Revised Bridge Deck Plans (adaptation to modular expansion joint seals)	2, then 1 reproducible	0	“Modular Expansion Joint Seals”
Sound Barrier Wall (precast items)	10	0	Article 1077-2 & “Sound Barrier Wall”
Sound Barrier Wall Steel Fabrication Plans ⁵	7	0	Article 1072-8 & “Sound Barrier Wall”
Structural Steel ⁴	2, then 7	0	Article 1072-8
Temporary Detour Structures	10	2	Article 400-3 & “Construction, Maintenance and Removal of Temporary Structure at Station _____”
TFE Expansion Bearings ⁴	8	0	Article 1072-8

FOOTNOTES

1. References are provided to help locate the part of the contract where the submittals are required. References in quotes refer to the provision by that name. Articles refer to the *Standard Specifications*.
2. Submittals for these items are necessary only when required by a note on plans.
3. Submittals for these items may not be required. A list of pre-approved sequences is available from the producer or the Materials & Tests Unit.
4. The fabricator may submit these items directly to the Structures Management Unit.
5. The two sets of preliminary submittals required by Article 1072-8 of the *Standard Specifications* are not required for these items.
6. Submittals for Fabrication Drawings are not required. Submittals for Catalogue Cuts of Proposed Material are required. See Section 5.A of the referenced provision.
7. Submittals are necessary only when the top slab thickness is 18” or greater.

GEOTECHNICAL SUBMITTALS

Submittal	Copies Required by Geotechnical	Copies Required by Structures	Contract Reference Requiring Submittal ¹
------------------	--	--	--

ST-15

Project B-5362

Montgomery County

	Engineering Unit	Management Unit	
Drilled Pier Construction Plans ²	1	0	Subarticle 411-3(A)
Crosshole Sonic Logging (CSL) Reports ²	1	0	Subarticle 411-5(A)(2)
Pile Driving Equipment Data Forms ^{2,3}	1	0	Subarticle 450-3(D)(2)
Pile Driving Analyzer (PDA) Reports ²	1	0	Subarticle 450-3(F)(3)
Retaining Walls ⁴	1 drawings, 1 calculations	2 drawings	Applicable Provisions
Temporary Shoring ⁴	1 drawings, 1 calculations	2 drawings	“Temporary Shoring” & “Temporary Soil Nail Walls”

FOOTNOTES

1. References are provided to help locate the part of the contract where the submittals are required. References in quotes refer to the provision by that name. Subarticles refer to the *Standard Specifications*.
2. Submit one hard copy of submittal to the Engineer. Submit a second copy of submittal electronically (PDF via email), US mail or other delivery service to the appropriate Geotechnical Engineering Unit regional office. Electronic submission is preferred.
3. The Pile Driving Equipment Data Form is available from:
https://connect.ncdot.gov/resources/Geological/Pages/Geotech_Forms_Details.aspx
See second page of form for submittal instructions.
4. Electronic copy of submittal is required. See referenced provision.

CRANE SAFETY

(8-15-05)

Comply with the manufacturer specifications and limitations applicable to the operation of any and all cranes and derricks. Prime contractors, sub-contractors, and fully operated rental companies shall comply with the current Occupational Safety and Health Administration regulations (OSHA).

Submit all items listed below to the Engineer prior to beginning crane operations involving critical lifts. A critical lift is defined as any lift that exceeds 75 percent of the manufacturer's crane chart capacity for the radius at which the load will be lifted or requires the use of more than one crane. Changes in personnel or equipment must be reported to the Engineer and all applicable items listed below must be updated and submitted prior to continuing with crane operations.

CRANE SAFETY SUBMITTAL LIST

Competent Person: Provide the name and qualifications of the "Competent Person" responsible for crane safety and lifting operations. The named competent person will have the responsibility and authority to stop any work activity due to safety concerns.

Riggers: Provide the qualifications and experience of the persons responsible for rigging operations. Qualifications and experience should include, but not be limited to, weight calculations, center of gravity determinations, selection and inspection of sling and rigging equipment, and safe rigging practices.

Crane Inspections: Inspection records for all cranes shall be current and readily accessible for review upon request.

Certifications: By July 1, 2006, crane operators performing critical lifts shall be certified by NC CCO (National Commission for the Certification of Crane Operators), or satisfactorily complete the Carolinas AGC's Professional Crane Operator's Proficiency Program. Other approved nationally accredited programs will be considered upon request. All crane operators shall also have a current CDL medical card. Submit a list of anticipated critical lifts and corresponding crane operator(s). Include current certification for the type of crane operated (small hydraulic, large hydraulic, small lattice, large lattice) and medical evaluations for each operator.

GROUT FOR STRUCTURES

(9-30-11)

1.0 DESCRIPTION

This special provision addresses grout for use in pile blockouts, grout pockets, shear keys, dowel holes and recesses for structures. This provision does not apply to grout placed in post-tensioning ducts for bridge beams, girders, or decks. Mix and place grout in accordance with the manufacturer's recommendations, the applicable sections of the Standard Specifications and this provision.

2.0 MATERIAL REQUIREMENTS

Use a Department approved pre-packaged, non-shrink, non-metallic grout. Contact the Materials and Tests Unit for a list of approved pre-packaged grouts and consult the manufacturer to determine if the pre-packaged grout selected is suitable for the required application.

When using an approved pre-packaged grout, a grout mix design submittal is not required.

The grout shall be free of soluble chlorides and contain less than one percent soluble sulfate. Supply water in compliance with Article 1024-4 of the Standard Specifications.

Aggregate may be added to the mix only where recommended or permitted by the manufacturer and Engineer. The quantity and gradation of the aggregate shall be in accordance with the manufacturer's recommendations.

Admixtures, if approved by the Department, shall be used in accordance with the manufacturer's recommendations. The manufacture date shall be clearly stamped on each container. Admixtures with an expired shelf life shall not be used.

The Engineer reserves the right to reject material based on unsatisfactory performance.

Initial setting time shall not be less than 10 minutes when tested in accordance with ASTM C266.

Test the expansion and shrinkage of the grout in accordance with ASTM C1090. The grout shall expand no more than 0.2% and shall exhibit no shrinkage. Furnish a Type 4 material certification showing results of tests conducted to determine the properties listed in the Standard Specifications and to assure the material is non-shrink.

Unless required elsewhere in the contract the compressive strength at 3 days shall be at least 5000 psi. Compressive strength in the laboratory shall be determined in accordance with ASTM C109 except the test mix shall contain only water and the dry manufactured material. Compressive strength in the field will be determined by molding and testing 4" x 8" cylinders in accordance with AASHTO T22. Construction loading and traffic loading shall not be allowed until the 3 day compressive strength is achieved.

When tested in accordance with ASTM C666, Procedure A, the durability factor of the grout shall not be less than 80.

3.0 SAMPLING AND PLACEMENT

Place and maintain components in final position until grout placement is complete and accepted. Concrete surfaces to receive grout shall be free of defective concrete, laitance, oil, grease and other foreign matter. Saturate concrete surfaces with clean water and remove excess water prior to placing grout.

ST-18

Project B-5362

Montgomery County

Do not place grout if the grout temperature is less than 50°F or more than 90°F or if the air temperature measured at the location of the grouting operation in the shade away from artificial heat is below 45°F.

Provide grout at a rate that permits proper handling, placing and finishing in accordance with the manufacturer's recommendations unless directed otherwise by the Engineer. Use grout free of any lumps and undispersed cement. Agitate grout continuously before placement.

Control grout delivery so the interval between placing batches in the same component does not exceed 20 minutes.

The Engineer will determine the locations to sample grout and the number and type of samples collected for field and laboratory testing. The compressive strength of the grout will be considered the average compressive strength test results of 3 cube or 2 cylinder specimens at 28 days.

4.0 BASIS OF PAYMENT

No separate payment will be made for "Grout for Structures". The cost of the material, equipment, labor, placement, and any incidentals necessary to complete the work shall be considered incidental to the structure item requiring grout.

ASBESTOS ASSESSMENT FOR BRIDGE DEMOLITION AND RENOVATION ACTIVITIES

(12-30-15)

1.0 INSPECTION FOR ASBESTOS CONTAINING MATERIAL

Prior to conducting bridge demolition or renovation activities, the Contractor shall thoroughly inspect the bridge or affected components for the presence of asbestos containing material (ACM) using a firm prequalified by NCDOT to perform asbestos surveys. The inspection must be performed by a N.C. accredited asbestos inspector with experience inspecting bridges or other industrial structures. The N.C. accredited asbestos inspector must conduct a thorough inspection, identifying all asbestos-containing material as required by the Environmental Protection Agency National Emission Standards for Hazardous Air Pollutants (NESHAP) Code of Federal Regulations (CFR) 40 CFR, Part 61, Subpart M.

The Contractor shall submit an inspection report to the Engineer, which at a minimum must include information required in 40 CFR 763.85 (a)(4) vi)(A)-(E), as well as a project location map, photos of existing structure, the date of inspection and the name, N.C. accreditation number, and signature of the N.C. accredited asbestos inspector who performed the inspection and completed the report. The cover sheet of the report shall include project identification information. Place the following notes on the cover sheet of the report and check the appropriate box:

ACM was found

ACM was not found

2.0 REMOVAL AND DISPOSAL OF ASBESTOS CONTAINING MATERIAL

If ACM is found, notify the Engineer. Compensation for removal and disposal of ACM is considered extra work in accordance with Article 104-7 of the Standard Specifications.

An Asbestos Removal Permit must be obtained from the Health Hazards Control Unit (HHCU) of the N.C. Department of Health & Human Services, Division of Public Health, if more than 35 cubic feet, 160 square feet, or 260 linear feet of regulated ACM (RACM) is to be removed from a structure and this work must be completed by a contractor prequalified by NCDOT to perform asbestos abatement. RACM is defined in 40 CFR, Part 61, Subpart M. Note: 40 CFR 763.85 (a)(4) vi)(D) defines ACM as surfacing, TSI and Miscellaneous which does not meet the NESHAP RACM.

3.0 DEMOLITION NOTIFICATION

Even if no ACM is found (or if quantities are less than those required for a permit), a Demolition Notification (DHHS-3768) must be submitted to the HHCU. Notifications and Asbestos Permit applications require an original signature and must be submitted to the HHCU 10 working days prior to beginning demolition activities. The 10 working day period starts based on the post-marked date or date of hand delivery. Demolition that does not begin as originally notified requires submission of a separate revision form HHCU 3768-R to HHCU. Reference the North Carolina Administrative Code, Chapter 10A, Subchapter 41C, Article .0605 for directives on revision submissions.

Contact Information

Health Hazards Control Unit (HHCU)
N.C. Department of Health and Human Services
1912 Mail Service Center
Raleigh, NC 27699-1912
Telephone: (919) 707-5950
Fax: (919) 870-4808

4.0 SPECIAL CONSIDERATIONS

Buncombe, Forsyth, and Mecklenburg counties also have asbestos permitting and NESHAP requirements must be followed. For projects involving permitted RACM removals, both the applicable county and the state (HHCU) must be notified.

For demolitions with no RACM, only the local environmental agencies must be notified. Contact information is as follows:

Buncombe County

WNC Regional Air Pollution Control Agency
49 Mt. Carmel Road
Asheville, NC 28806
(828) 250-6777

Forsyth County
Environmental Affairs Department
537 N. Spruce Street
Winston-Salem, NC 27101
(336) 703-2440

Mecklenburg County
Land Use and Environmental Services Agency
Mecklenburg Air Quality
700 N. Tryon Street
Charlotte, NC 28202
(704) 336-5430

5.0 ADDITIONAL INFORMATION

Additional information may be found on N.C. asbestos rules, regulations, procedures and N.C. accredited inspectors, as well as associated forms for demolition notifications and asbestos permit applications at the N.C. Asbestos Hazard Management Program website:

www.epi.state.nc.us/epi/asbestos/ahmp.html

6.0 BASIS OF PAYMENT

Payment for the work required in this provision will be at the lump sum contract unit price for “Asbestos Assessment”. Such payment will be full compensation for all asbestos inspections, reports, permitting and notifications.

PROJECT SPECIAL PROVISION

(10-18-95) (Rev. 3-21-17)

Z-1

PERMITS

The Contractor's attention is directed to the following permits, which have been issued to the Department of Transportation by the authority granting the permit.

<u>PERMIT</u>	<u>AUTHORITY GRANTING THE PERMIT</u>
Dredge and Fill and/or Work in Navigable Waters (404)	U. S. Army Corps of Engineers
Water Quality (401)	Division of Environmental Management, DEQ State of North Carolina

The Contractor shall comply with all applicable permit conditions during construction of this project. Those conditions marked by * are the responsibility of the Department and the Contractor has no responsibility in accomplishing those conditions.

Agents of the permitting authority will periodically inspect the project for adherence to the permits.

The Contractor's attention is also directed to Articles 107-10 and 107-13 of the *2012 Standard Specifications* and the following:

Should the Contractor propose to utilize construction methods (such as temporary structures or fill in waters and/or wetlands for haul roads, work platforms, cofferdams, etc.) not specifically identified in the permit (individual, general, or nationwide) authorizing the project it shall be the Contractor's responsibility to coordinate with the Engineer to determine what, if any, additional permit action is required. The Contractor shall also be responsible for initiating the request for the authorization of such construction method by the permitting agency. The request shall be submitted through the Engineer. The Contractor shall not utilize the construction method until it is approved by the permitting agency. The request normally takes approximately 60 days to process; however, no extensions of time or additional compensation will be granted for delays resulting from the Contractor's request for approval of construction methods not specifically identified in the permit.

Where construction moratoriums are contained in a permit condition which restricts the Contractor's activities to certain times of the year, those moratoriums will apply only to the portions of the work taking place in the restricted waters, wetlands or buffer zones, provided that activities outside those areas is done in such a manner as to not affect the restricted waters, wetlands or buffer zones.

DocuSigned by:

 68A7405FFA5F48E...

U.S. ARMY CORPS OF ENGINEERS
WILMINGTON DISTRICT

Action Id. SAW-2012-02004 County: Moore U.S.G.S. Quad: Norman

GENERAL PERMIT (REGIONAL AND NATIONWIDE) VERIFICATION

Permittee: NC DOT
Jason Dilday
Address: 1598 Mail Service Center
Raleigh, North Carolina 27699-1598

Telephone Number: 919 707-6111

Size (acres) 0.8 (approximately) Nearest Town Jackson Springs
Nearest Waterway Drowning Creek River Basin Lower Pee Dee
USGS HUC 03040203 Coordinates Latitude: 35.187698
Longitude: -79.648612

Location description: The site is located along NC 73 over Drowning Creek at NCDOT Bridge #53 in Moore/Montgomery Counties, North Carolina. The site is approximately 0.6 miles northeast of the Pooles Mill Road, NC 73 intersection. This project is identified as TIP B-5362.

Description of projects area and activity: This authorization is for the permanent and temporary discharge of clean fill material associated with an existing bridge replacement project. Permanent impacts include the placement of fill within 0.05 acre of wetland for bridge construction, and within 70 linear feet (0.03 acre) of Downing Creek (backwater pool) for bridge construction. Temporary impacts are within 5 linear feet of jurisdictional stream and 0.03 acre of wetland for construction/dewatering.

Applicable Law: Section 404 (Clean Water Act, 33 USC 1344)
 Sections 10 (Rivers and Harbors Act, 33 USC 403)

Authorization: Regional General Permit Number or Nationwide Permit Number: NWP 3 Maintenance.
SEE ATTACHED RGP or NWP GENERAL, REGIONAL AND SPECIAL CONDITIONS

Special Conditions:

1. This USACE permit does not authorize you to take a threatened or endangered species, in particular, the Northern Long-eared Bat (NLEB) (Myotis septentrionalis). In order to legally take a listed species, you must have separate authorization under the Endangered Species Act (ESA) (e.g., a Biological Opinion (BO) under the ESA, Section 7, with "incidental take" provisions with which you must comply). The U.S. Fish and Wildlife Service's (USFWS's) Programmatic BO titled "Northern Long-eared Bat (NLEB) Programmatic Biological Opinion for North Carolina Department of Transportation (NCDOT) Activities in Eastern North Carolina (Divisions 1-8)," dated March 25, 2015, and adopted on April 10, 2015, contains mandatory terms and conditions to implement the reasonable and prudent measures that are associated with "incidental take" that are specified in the BO. Your authorization under this USACE permit is conditioned upon your compliance with all the mandatory terms and conditions (incorporated by reference into this permit) associated with incidental take of the BO. Failure to comply with the terms and conditions associated with incidental take of the BO, where a take of the listed species occurs, would constitute an unauthorized take, and would also constitute non-compliance with your USACE permit. The USFWS is the appropriate authority to determine compliance with the terms and conditions of its BO and with the ESA.

Your work is authorized by the above referenced permit provided it is accomplished in strict accordance with the attached conditions and your submitted application and attached information dated 05/18/2017. Any violation of the attached conditions or deviation from your submitted plans may subject the permittee to a stop work order, a restoration order, a Class I administrative penalty, and/or appropriate legal action.

This verification will remain valid until the expiration date identified below unless the nationwide authorization is modified, suspended or revoked. If, prior to the expiration date identified below, the nationwide permit authorization is reissued and/or modified, this verification will remain valid until the expiration date identified below, provided it complies with all requirements of the modified nationwide permit. If the nationwide permit authorization expires or is suspended, revoked, or is modified, such that the activity would no longer comply with the terms and conditions of the nationwide permit, activities which have commenced (i.e., are under construction) or are under contract to commence in reliance upon the nationwide permit, will remain authorized provided the

P-3

activity is completed within twelve months of the date of the nationwide permit's expiration, modification or revocation, unless discretionary authority has been exercised on a case-by-case basis to modify, suspend or revoke the authorization.

Activities subject to Section 404 (as indicated above) may also require an individual Section 401 Water Quality Certification. You should contact the NC Division of Water Resources (telephone 919-807-6300) to determine Section 401 requirements.

For activities occurring within the twenty coastal counties subject to regulation under the Coastal Area Management Act (CAMA), prior to beginning work you must contact the N.C. Division of Coastal Management in Elizabeth City, NC, at (252) 264-3901.

This Department of the Army verification does not relieve the permittee of the responsibility to obtain any other required Federal, State or local approvals/permits.

If there are any questions regarding this verification, any of the conditions of the Permit, or the Corps of Engineers regulatory program, please contact **Andrew Williams at (919) 554-4884 or Andrew.E.Williams2@usace.army.mil.**

Corps Regulatory Official: Andrew Williams Digitally signed by WILLIAMS,ANDREW.E.1244561655
DN: c=US, o=U.S. Government, ou=DoD,
ou=PKI, ou=USA,
cn=WILLIAMS,ANDREW.E.1244561655
Date: 2017.06.30 15:10:15 -0400 Date: **June 30, 2017**
Expiration Date of Verification: **03/18/2022**

The Wilmington District is committed to providing the highest level of support to the public. To help us ensure we continue to do so, please complete our Customer Satisfaction Survey, located online at http://corpsmapu.usace.army.mil/cm_apex/f?p=136:4:0.

Copy furnished (via email):

April R. Norton
Environmental Senior Specialist
Division of Water Resources
North Carolina Department of Environmental Quality
Winston-Salem Regional Office
450 W. Hanes Mill Road, Suite 300
Winston-Salem, North Carolina 27105

P-4

Action ID Number: SAW-2012-02004

County: Moore

Permittee: NC DOT
Jason Dilday

Project Name: NCDOT/B 5362/BR 53/NC 73/Div 8

Date Verification Issued: June 30, 2017

Project Manager: Andrew Williams

Upon completion of the activity authorized by this permit and any mitigation required by the permit, sign this certification and return it to the following address:

US ARMY CORPS OF ENGINEERS
WILMINGTON DISTRICT
Attn: Andrew Williams
3331 Heritage Trade Drive, Suite 105
Wake Forest, North Carolina 27587

Please note that your permitted activity is subject to a compliance inspection by a U. S. Army Corps of Engineers representative. Failure to comply with any terms or conditions of this authorization may result in the Corps suspending, modifying or revoking the authorization and/or issuing a Class I administrative penalty, or initiating other appropriate legal action.

I hereby certify that the work authorized by the above referenced permit has been completed in accordance with the terms and condition of the said permit, and required mitigation was completed in accordance with the permit conditions.

Signature of Permittee

Date

**NATIONWIDE PERMIT 3
DEPARTMENT OF THE ARMY
CORPS OF ENGINEERS
FINAL NOTICE OF ISSUANCE AND MODIFICATION OF NATIONWIDE PERMITS
FEDERAL REGISTER
AUTHORIZED MARCH 19, 2017**

Maintenance. (a) The repair, rehabilitation, or replacement of any previously authorized, currently serviceable structure, or fill, or of any currently serviceable structure or fill authorized by 33 CFR 330.3, provided that the structure or fill is not to be put to uses differing from those uses specified or contemplated for it in the original permit or the most recently authorized modification. Minor deviations in the structure's configuration or filled area, including those due to changes in materials, construction techniques, requirements of other regulatory agencies, or current construction codes or safety standards that are necessary to make the repair, rehabilitation, or replacement are authorized. Any stream channel modification is limited to the minimum necessary for the repair, rehabilitation, or replacement of the structure or fill; such modifications, including the removal of material from the stream channel, must be immediately adjacent to the project or within the boundaries of the structure or fill. This NWP also authorizes the repair, rehabilitation, or replacement of those structures or fills destroyed or damaged by storms, floods, fire or other discrete events, provided the repair, rehabilitation, or replacement is commenced, or is under contract to commence, within two years of the date of their destruction or damage. In cases of catastrophic events, such as hurricanes or tornadoes, this two-year limit may be waived by the district engineer, provided the permittee can demonstrate funding, contract, or other similar delays.

(b) This NWP also authorizes the removal of accumulated sediments and debris in the vicinity of existing structures (e.g., bridges, culverted road crossings, water intake structures, etc.) and/or the placement of new or additional riprap to protect the structure. The removal of sediment is limited to the minimum necessary to restore the waterway in the vicinity of the structure to the approximate dimensions that existed when the structure was built, but cannot extend farther than 200 feet in any direction from the structure. This 200 foot limit does not apply to maintenance dredging to remove accumulated sediments blocking or restricting outfall and intake structures or to maintenance dredging to remove accumulated sediments from canals associated with outfall and intake structures. All dredged or excavated materials must be deposited and retained in an area that has no waters of the United States unless otherwise specifically approved by the district engineer under separate authorization. The placement of new or additional riprap must be the minimum necessary to protect the structure or to ensure the safety of the structure. Any bank stabilization measures not directly associated with the structure will require a separate authorization from the district engineer.

(c) This NWP also authorizes temporary structures, fills, and work necessary to conduct the maintenance activity. Appropriate measures must be taken to maintain normal downstream flows and minimize flooding to the maximum extent practicable, when temporary structures, work, and discharges, including cofferdams, are necessary for construction activities, access fills, or dewatering of construction sites. Temporary fills must consist of materials, and be placed in a manner, that will not be eroded by expected high flows. Temporary fills must be removed in their entirety and the affected areas returned to pre-construction elevations. The areas affected by temporary fills must be revegetated, as appropriate.

(d) This NWP does not authorize maintenance dredging for the primary purpose of navigation. This NWP does not authorize beach restoration. This NWP does not authorize new stream channelization or stream relocation projects.

Notification: For activities authorized by paragraph (b) of this NWP, the permittee must submit a pre-construction notification to the district engineer prior to commencing the activity (see general condition 31). The pre-construction notification must include information regarding the original design capacities and configurations of the outfalls, intakes, small impoundments, and canals. (Sections 10 and 404)

Note: This NWP authorizes the repair, rehabilitation, or replacement of any previously authorized structure or fill that does not qualify for the Clean Water Act Section 404(f) exemption for maintenance.

NATIONWIDE PERMIT 12
DEPARTMENT OF THE ARMY
CORPS OF ENGINEERS
FINAL NOTICE OF ISSUANCE AND MODIFICATION OF NATIONWIDE PERMITS
FEDERAL REGISTER
AUTHORIZED MARCH 19, 2017

Utility Line Activities. Activities required for the construction, maintenance, repair, and removal of utility lines and associated facilities in waters of the United States, provided the activity does not result in the loss of greater than 1/2-acre of waters of the United States for each single and complete project.

Utility lines: This NWP authorizes the construction, maintenance, or repair of utility lines, including outfall and intake structures, and the associated excavation, backfill, or bedding for the utility lines, in all waters of the United States, provided there is no change in pre-construction contours. A “utility line” is defined as any pipe or pipeline for the transportation of any gaseous, liquid, liquescent, or slurry substance, for any purpose, and any cable, line, or wire for the transmission for any purpose of electrical energy, telephone, and telegraph messages, and radio and television communication. The term “utility line” does not include activities that drain a water of the United States, such as drainage tile or french drains, but it does apply to pipes conveying drainage from another area.

Material resulting from trench excavation may be temporarily sidecast into waters of the United States for no more than three months, provided the material is not placed in such a manner that it is dispersed by currents or other forces. The district engineer may extend the period of temporary side casting for no more than a total of 180 days, where appropriate. In wetlands, the top 6 to 12 inches of the trench should normally be backfilled with topsoil from the trench. The trench cannot be constructed or backfilled in such a manner as to drain waters of the United States (e.g., backfilling with extensive gravel layers, creating a french drain effect). Any exposed slopes and stream banks must be stabilized immediately upon completion of the utility line crossing of each waterbody.

Utility line substations: This NWP authorizes the construction, maintenance, or expansion of substation facilities associated with a power line or utility line in non-tidal waters of the United States, provided the activity, in combination with all other activities included in one single and complete project, does not result in the loss of greater than 1/2-acre of waters of the United States. This NWP does not authorize discharges into non-tidal wetlands adjacent to tidal waters of the United States to construct, maintain, or expand substation facilities.

Foundations for overhead utility line towers, poles, and anchors: This NWP authorizes the construction or maintenance of foundations for overhead utility line towers, poles, and anchors in all waters of the United States, provided the foundations are the minimum size necessary and separate footings for each tower leg (rather than a larger single pad) are used where feasible.

Access roads: This NWP authorizes the construction of access roads for the construction and maintenance of utility lines, including overhead power lines and utility line substations, in non-tidal waters of the United States, provided the activity, in combination with all other activities included in one single and complete project, does not cause the loss of greater than 1/2-acre of non-tidal waters of the United States. This NWP does not authorize discharges into non-tidal wetlands adjacent to tidal waters for access roads. Access roads must be the minimum width necessary (see Note 2, below). Access roads must be constructed so that the length of the road minimizes any adverse effects on waters of the United States and must be as near as possible to pre-construction contours and elevations (e.g., at grade corduroy roads or geotextile/gravel roads).

Access roads constructed above pre-construction contours and elevations in waters of the United States must be properly bridged or culverted to maintain surface flows.

This NWP may authorize utility lines in or affecting navigable waters of the United States even if there is no associated discharge of dredged or fill material (See 33 CFR Part 322). Overhead utility lines constructed over section 10 waters and utility lines that are routed in or under section 10 waters without a discharge of dredged or fill material require a section 10 permit.

This NWP also authorizes temporary structures, fills, and work necessary to conduct the utility line activity. Appropriate measures must be taken to maintain normal downstream flows and minimize flooding to the maximum extent practicable, when temporary structures, work, and discharges, including cofferdams, are necessary for construction activities, access fills, or dewatering of construction sites. Temporary fills must consist of materials, and be placed in a manner, that will not be eroded by expected high flows. Temporary fills must be removed in their entirety and the affected areas returned to pre-construction elevations. The areas affected by temporary fills must be revegetated, as appropriate.

Notification: The permittee must submit a pre-construction notification to the district engineer prior to commencing the activity if any of the following criteria are met: (1) the activity involves mechanized land clearing in a forested wetland for the utility line right-of-way; (2) a section 10 permit is required; (3) the utility line in waters of the United States, excluding overhead lines, exceeds 500 feet; (4) the utility line is placed within a jurisdictional area (i.e., water of the United States), and it runs parallel to or along a stream bed that is within that jurisdictional area; (5) discharges that result in the loss of greater than 1/10-acre of waters of the United States; (6) permanent access roads are constructed above grade in waters of the United States for a distance of more than 500 feet; or (7) permanent access roads are constructed in waters of the United States with impervious materials. (See general condition 31.) (Sections 10 and 404)

Note 1: Where the proposed utility line is constructed or installed in navigable waters of the United States (i.e., section 10 waters) within the coastal United States, the Great Lakes, and United States territories, copies of the pre-construction notification and NWP verification will be sent by the Corps to the National Oceanic and Atmospheric Administration (NOAA), National Ocean Service (NOS), for charting the utility line to protect navigation.

Note 2: Access roads used for both construction and maintenance may be authorized, provided they meet the terms and conditions of this NWP. Access roads used solely for construction of the utility line must be removed upon completion of the work, in accordance with the requirements for temporary fills.

Note 3: Pipes or pipelines used to transport gaseous, liquid, liquescent, or slurry substances over navigable waters of the United States are considered to be bridges, not utility lines, and may require a permit from the U.S. Coast Guard pursuant to Section 9 of the Rivers and Harbors Act of 1899. However, any discharges of dredged or fill material into waters of the United States associated with such pipelines will require a section 404 permit (see NWP 15).

Note 4: For overhead utility lines authorized by this NWP, a copy of the PCN and NWP verification will be provided to the Department of Defense Siting Clearinghouse, which will evaluate potential effects on military activities.

The following list of General Conditions has been adapted for work in North Carolina for NCDOT projects. Information related to USACE notification requirements has been removed. Therefore, numbering and lettering below may not be consecutive. Please refer to <http://saw-reg.usace.army.mil/NWP2017/2017NWP12.pdf> for the complete reference.

4.0 Additional Regional Conditions for Specific Nationwide Permits

4.1 NWP #12 - Utility Line Activities

4.1.1. Pipeline/utility line construction through jurisdictional waters and wetlands will be accomplished utilizing directional drilling/boring methods to the maximum extent practicable.

4.1.2. Temporary discharge of excavated or fill material into wetlands and waters of the United States will be for the absolute minimum period of time necessary to accomplish the work. Temporary discharges will be fully contained with appropriate erosion control or containment methods or otherwise such fills will consist of non-erodible materials.

4.1.3. The work area authorized by this permit, including temporary and/or permanent fills, will be minimized to the greatest extent practicable. Justification for work corridors exceeding forty (40) feet in width is required and will be based on pipeline diameter and length, size of equipment required to construct the utility line, and other construction information deemed necessary to support the request. The applicant is required to provide this information to the Corps with the initial notification package.

4.1.9. For the purposes of this NWP, any permanently maintained corridor along the utility ROW within forested wetlands shall be considered a permanent impact and a compensatory mitigation plan will be required for all such impacts associated with the requested activity.

4.1.10. Use of rip-rap or any other engineered structures to stabilize a stream bed should be avoided to the maximum extent practicable. If riprap stabilization is needed, it should be placed only on the stream banks, or, if it is necessary to be placed in the stream bed, the finished top elevation of the riprap should not exceed that of the original stream bed.

4.1.11. When directional boring or horizontal directional drilling (HDD) under waters of the U.S., including wetlands, permittees shall closely monitor the project for hydraulic fracturing or “fracking.” Any discharge from hydraulic fracturing or “fracking” into waters of the U.S., including wetlands, shall be reported to the appropriate Corps Regulatory Field Office within 48 hours. Restoration and/or mitigation may be required as a result from any unintended discharges.

NATIONWIDE PERMIT GENERAL CONDITIONS

The following General Conditions must be followed in order for any authorization by a NWP to be valid:

1. Navigation. (a) No activity may cause more than a minimal adverse effect on navigation.
(b) Any safety lights and signals prescribed by the U.S. Coast Guard, through regulations or otherwise, must be installed and maintained at the permittee's expense on authorized facilities in navigable waters of the United States.
(c) The permittee understands and agrees that, if future operations by the United States require the removal, relocation, or other alteration, of the structure or work herein authorized, or if, in the opinion of the Secretary of the Army or his authorized representative, said structure or work shall cause unreasonable obstruction to the free navigation of the navigable waters, the permittee will be required, upon due notice from the Corps of Engineers, to remove, relocate, or alter the structural work or obstructions caused thereby, without expense to the United States. No claim shall be made against the United States on account of any such removal or alteration.
2. Aquatic Life Movements. No activity may substantially disrupt the necessary life cycle movements of those species of aquatic life indigenous to the waterbody, including those species that normally migrate through the area, unless the activity's primary purpose is to impound water. All permanent and temporary crossings of waterbodies shall be suitably culverted, bridged, or otherwise designed and constructed to maintain low flows to sustain the movement of those aquatic species. If a bottomless culvert cannot be used, then the crossing should be designed and constructed to minimize adverse effects to aquatic life movements.
3. Spawning Areas. Activities in spawning areas during spawning seasons must be avoided to the maximum extent practicable. Activities that result in the physical destruction (e.g., through excavation, fill, or downstream smothering by substantial turbidity) of an important spawning area are not authorized.
4. Migratory Bird Breeding Areas. Activities in waters of the United States that serve as breeding areas for migratory birds must be avoided to the maximum extent practicable.
6. Suitable Material. No activity may use unsuitable material (e.g., trash, debris, car bodies, asphalt, etc.). Material used for construction or discharged must be free from toxic pollutants in toxic amounts (see section 307 of the Clean Water Act).
7. Water Supply Intakes. No activity may occur in the proximity of a public water supply intake, except where the activity is for the repair or improvement of public water supply intake structures or adjacent bank stabilization.
8. Adverse Effects From Impoundments. If the activity creates an impoundment of water, adverse effects to the aquatic system due to accelerating the passage of water, and/or restricting its flow must be minimized to the maximum extent practicable.

P-10

9. Management of Water Flows. To the maximum extent practicable, the pre- construction course, condition, capacity, and location of open waters must be maintained for each activity, including stream channelization, storm water management activities, and temporary and permanent road crossings, except as provided below. The activity must be constructed to withstand expected high flows. The activity must not restrict or impede the passage of normal or high flows, unless the primary purpose of the activity is to impound water or manage high flows. The activity may alter the pre-construction course, condition, capacity, and location of open waters if it benefits the aquatic environment (e.g., stream restoration or relocation activities).

10. Fills Within 100-Year Floodplains. The activity must comply with applicable FEMA-approved state or local floodplain management requirements.

11. Equipment. Heavy equipment working in wetlands or mudflats must be placed on mats, or other measures must be taken to minimize soil disturbance.

12. Soil Erosion and Sediment Controls. Appropriate soil erosion and sediment controls must be used and maintained in effective operating condition during construction, and all exposed soil and other fills, as well as any work below the ordinary high water mark or high tide line, must be permanently stabilized at the earliest practicable date. Permittees are encouraged to perform work within waters of the United States during periods of low-flow or no-flow, or during low tides.

13. Removal of Temporary Fills. Temporary fills must be removed in their entirety and the affected areas returned to pre-construction elevations. The affected areas must be revegetated, as appropriate.

14. Proper Maintenance. Any authorized structure or fill shall be properly maintained, including maintenance to ensure public safety and compliance with applicable NWP general conditions, as well as any activity-specific conditions added by the district engineer to an NWP authorization.

19. Migratory Birds and Bald and Golden Eagles. The permittee is responsible for ensuring their action complies with the Migratory Bird Treaty Act and the Bald and Golden Eagle Protection Act. The permittee is responsible for contacting appropriate local office of the U.S. Fish and Wildlife Service to determine applicable measures to reduce impacts to migratory birds or eagles, including whether “incidental take” permits are necessary and available under the Migratory Bird Treaty Act or Bald and Golden Eagle Protection Act for a particular activity.

21. Discovery of Previously Unknown Remains and Artifacts. If you discover any previously unknown historic, cultural or archeological remains and artifacts while accomplishing the activity authorized by this permit, you must immediately notify the district engineer of what you have found, and to the maximum extent practicable, avoid construction activities that may affect the remains and artifacts until the required coordination has been completed. The district engineer will initiate the Federal, Tribal, and state coordination required to determine if the items or remains warrant a recovery effort or if the site is eligible for listing in the National Register of Historic Places.

30. Compliance Certification. Each permittee who receives an NWP verification letter from the Corps must provide a signed certification documenting completion of the authorized activity and implementation of any required compensatory mitigation. The success of any required permittee-responsible mitigation, including the achievement of ecological performance standards, will be

addressed separately by the district engineer. The Corps will provide the permittee the certification document with the NWP verification letter. The certification document will include:

(a) A statement that the authorized activity was done in accordance with the NWP authorization, including any general, regional, or activity-specific conditions;

(b) A statement that the implementation of any required compensatory mitigation was completed in accordance with the permit conditions. If credits from a mitigation bank or in-lieu fee program are used to satisfy the compensatory mitigation requirements, the certification must include the documentation required by 33 CFR 332.3(l)(3) to confirm that the permittee secured the appropriate number and resource type of credits; and

(c) The signature of the permittee certifying the completion of the activity and mitigation. The completed certification document must be submitted to the district engineer within 30 days of completion of the authorized activity or the implementation of any required compensatory mitigation, whichever occurs later.

FINAL REGIONAL CONDITIONS 2017

Final 2017 Regional Conditions for Nationwide Permits (NWP) in the Wilmington District

1.0 Excluded Waters

The Corps has identified waters that will be excluded from the use of all NWP's during certain timeframes. These waters are:

1.1 Anadromous Fish Spawning Areas

Waters of the United States identified by either the North Carolina Division of Marine Fisheries (NCDMF) or the North Carolina Wildlife Resources Commission (NCWRC) as anadromous fish spawning areas are excluded during the period between February 15 and June 30, without prior written approval from the Corps and either NCDMF or NCWRC.

1.2 Trout Waters Moratorium

Waters of the United States in the designated trout watersheds of North Carolina are excluded during the period between October 15 and April 15 without prior written approval from the NCWRC, or from the Eastern Band of Cherokee Indians (EBCI) Fisheries and Wildlife Management (FWM) office if the project is located on EBCI trust land. (See Section 2.7 for information on the designated trout watersheds).

1.3 Sturgeon Spawning Areas as Designated by the National Marine Fisheries Service (NMFS)

Waters of the United States designated as sturgeon spawning areas are excluded during the period between February 1 and June 30, without prior written approval from the NMFS.

3.0 List of Corps Regional Conditions for All Nationwide Permits

The following conditions apply to all Nationwide Permits in the Wilmington District:

3.1 Limitation of Loss of Stream Bed

NWPs may not be used for activities that may result in the loss or degradation of more than 300 total linear feet of stream bed, unless the District Engineer has waived the 300 linear foot limit for ephemeral and intermittent streams on a case-by-case basis and has determined that the proposed activity will result in minimal individual and cumulative adverse impacts to the aquatic environment. Waivers for the loss of ephemeral and intermittent streams must be in writing and documented by appropriate/accepted stream quality assessments*. This waiver only applies to the 300 linear feet threshold for NWPs.

This Regional Condition does not apply to NWP 23 (Approved Categorical Exclusions).

*NOTE: Permittees should utilize the most current methodology prescribed by Wilmington District to assess stream function and quality. Information can be found at:

https://ribits.usace.army.mil/ribits_apex/f?p=107:27:0::NO

3.2 Mitigation for Loss of Stream Bed

For any NWP that results in a loss of more than 150 linear feet of stream, the permittee shall provide a mitigation proposal to compensate for more than minimal individual and cumulative adverse impacts to the aquatic environment. For stream losses of 150 linear feet or less that require a PCN, the District Engineer may determine, on a case-by-case basis, that compensatory mitigation is required to ensure that the activity results in minimal adverse effect on the aquatic environment.

3.3 Pre-construction Notification for Loss of Streambed Exceeding 150 Feet

Prior to use of any NWP for any activity which impacts more than 150 total linear feet of perennial stream, intermittent or ephemeral stream, the permittee shall submit a PCN to the District Engineer prior to commencing the activity (see General Condition 32). This applies to NWPs that do not have specific notification requirements. If a NWP has specific notification requirements, the requirements of the NWP should be followed.

3.4 Restriction on Use of Live Concrete

For all NWPs which allow the use of concrete as a building material, live or fresh concrete, including bags of uncured concrete, may not come into contact with the water in or entering into waters of the United States. Water inside coffer dams or casings that has been in contact with wet concrete shall only be returned to waters of the United States after the concrete is set and cured and when it no longer poses a threat to aquatic organisms.

3.5 Requirements for Using Riprap for Bank Stabilization

For all NWPs that allow for the use of riprap material for bank stabilization, the following measures shall be applied:

3.5.1. Where bank stabilization is conducted as part of an activity, natural design, bioengineering and/or geoen지니어ing methods that incorporate natural durable materials, native seed mixes, and native plants and shrubs are to be utilized to the maximum extent practicable.

3.5.2. Filter cloth must be placed underneath the riprap as an additional requirement of its use in North Carolina waters. The placement of filter fabric is not required if the riprap will be pushed or “keyed” into the bank of the waterbody. A waiver from the specifications in this Regional Condition may be requested in writing. The waiver will only be issued if it can be demonstrated that the impacts of complying with this Regional Condition would result in greater adverse impacts to the aquatic environment.

3.5.3. The placement of riprap shall be limited to the areas depicted on submitted work plan drawings.

3.5.4. The riprap material shall be clean and free from loose dirt or any pollutant except in trace quantities that would not have an adverse environmental effect.

3.5.5. It shall be of a size sufficient to prevent its movement from the authorized alignment by natural forces under normal conditions.

3.5.6. The riprap material shall consist of clean rock or masonry material such as, but not limited to, granite, marl, or broken concrete.

3.6 Requirements for Culvert Placement

3.6.1 For all NWP's that involve the construction/installation of culverts, measures will be included in the construction/installation that will promote the safe passage of fish and other aquatic organisms. The dimension, pattern, and profile of the stream above and below a pipe or culvert should not be modified by altering the width or depth of the stream profile in connection with the construction activity. The width, height, and gradient of a proposed culvert should be sufficient to pass the average historical low flow and spring flow without adversely altering flow velocity. Spring flow is the seasonal sustained high flow that typically occurs in the spring. Spring flows should be determined from gage data, if available. In the absence of such data, bank-full flow can be used as a comparable indicator.

In Public Trust Areas of Environmental Concern (AEC) and/or the Estuarine Waters AEC as designated by the Coastal Area Management Act (CAMA): All pipes/culverts must be sufficiently sized to allow for the burial of the bottom of the culvert at least one foot below normal bed elevation.

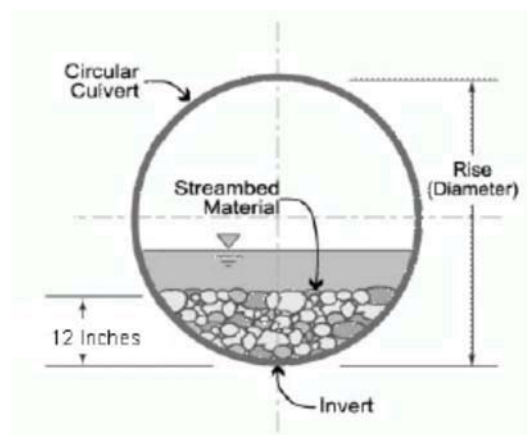

In all other areas: Culverts greater than 48 inches in diameter will be buried at least one foot below the bed of the stream. Culverts 48 inches in diameter or less shall be buried to maintain aquatic passage and to maintain passage during drought or low flow conditions, and every effort shall be made to maintain the existing channel slope.

Culverts must be designed and constructed in a manner that minimizes destabilization and head cutting. Destabilizing the channel and head cutting upstream should be considered and appropriate actions incorporated in the design and placement of the culvert.

A waiver from the depth specifications in this condition may be requested, in writing, by the permittee and issued by the Corp; this request must be specific as to the reasons(s) for the request. The waiver will be issued if it can be demonstrated that the proposed design would result in less impacts to the aquatic environment.

All counties: Culverts placed within riparian and/or riverine wetlands must be installed in a manner that does not restrict the flow and circulation patterns of waters of the United States.

Culverts placed across wetland fills purely for the purposes of equalizing surface water do not have to be buried, but the culverts must be of adequate size and/or number to ensure unrestricted transmission of water.

3.6.2 Bank-full flows (or less) shall be accommodated through maintenance of the existing bank- full channel cross sectional area. Additional culverts or culvert barrels at such crossings shall be allowed only to receive bank-full flows.

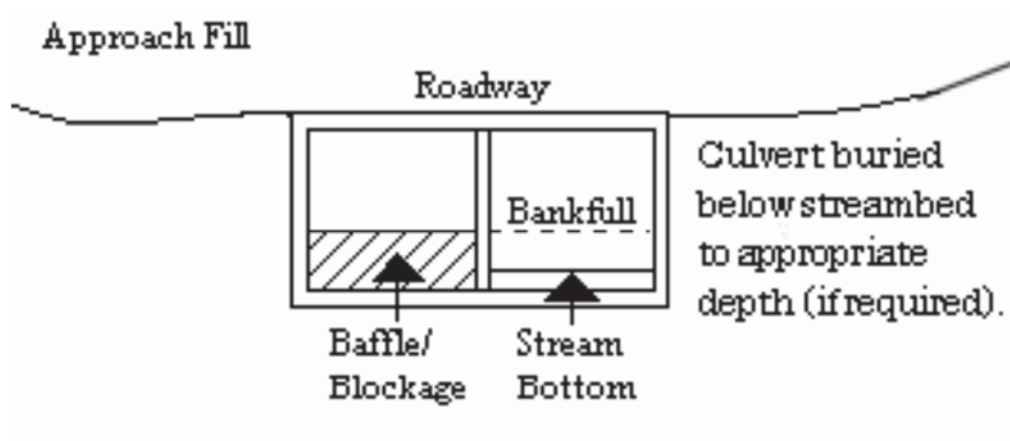

3.6.3 Where adjacent floodplain is available, flows exceeding bank-full should be accommodated by installing culverts at the floodplain elevation. Additional culverts or culvert barrels at such crossings should not be buried, or if buried, must have sills at the inlets to ensure that they only receive flows exceeding bank-full.

3.6.4 Excavation of existing stream channels shall be limited to the minimum necessary to construct or install the proposed culvert. The final width of the impacted stream at the culvert inlet and outlet should be no greater than the original stream width. A waiver from this condition may be requested in writing; this request must be specific as to the reason(s) for the request. The waiver will be issued if the proposed design would result in less impacts to the aquatic environment and/or if it can be demonstrated that it is not practicable to restore the final width of the impacted stream at the culvert inlet and outlet to the width of the original stream channel.

3.6.5 The width of the culvert shall be comparable to the width of the stream channel. If the width of the culvert is wider than the stream channel, the culvert shall include baffles, benches and/or sills to maintain the width of the stream channel. A waiver from this condition may be requested in writing; this request must be specific as to the reason(s) for the request. The waiver will be issued if it can be demonstrated that it is not practicable or necessary to include baffles, benches or sills and the design would result in less impacts to the aquatic environment.

3.7 Notification to NCDEQ Shellfish Sanitation Section

Permittees shall notify the NCDEQ Shellfish Sanitation Section prior to dredging in or removing sediment from an area closed to shell fishing where the effluent may be released to an area open for shell fishing or swimming in order to avoid contamination from the disposal area and cause a temporary shellfish closure to be made. Such notification shall also be provided to the appropriate Corps Regulatory Field Office. Any disposal of sand to the ocean beach should occur between November 1 and April 30 when recreational usage is low. Only clean sand should be used and no dredged sand from closed shell fishing areas may be used. If beach disposal were to occur at times other than stated above or if sand from a closed shell fishing area is to be used, a swimming advisory shall be posted, and a press release shall be issued by the permittee.

3.8 Submerged Aquatic Vegetation

Impacts to Submerged Aquatic Vegetation (SAV) are not authorized by any NWP, except NWP 48, unless EFH Consultation has been completed pursuant to the Magnuson-Stevens Fisheries Conservation and Management Act (Magnuson-Stevens Act). Permittees shall submit a PCN (See NWP General Condition 32) to the District Engineer prior to commencing the activity if the project would affect SAV. The permittee may not begin work until notified by the Corps that the requirements of the Magnuson-Stevens Act have been satisfied and that the activity is authorized.

3.9 Sedimentation and Erosion Control Structures and Measures

All PCNs will identify and describe sedimentation and erosion control structures and measures proposed for placement in waters of the United States. The structures and measures should be depicted on maps, surveys or drawings showing location and impacts to jurisdictional wetlands and streams.

3.10 Restoration of Temporary Impacts to Stream Beds

Upon completion of work that involves temporary stream impacts, streambeds are to be restored to pre-project elevations and widths using natural streambed material such that the impacted stream reach mimics the adjacent upstream and downstream reach. The impacted area shall be backfilled with natural streambed material to a depth of at least 12 inches or to the bottom depth of the impacted area if shallower than 12 inches. An engineered in-stream structure or material can be used to provide protection of a buried structure if it provides benefits to the aquatic environment and can be accomplished by a natural streambed design. A permittee may request a waiver of this condition if it is determined a buried structure needs significant physical protection beyond those provided in this condition. This condition does not apply to NWP 27 – Aquatic Habitat Restoration, Enhancement, and Establishment Activities.

3.11 Restoration of Temporary Impacts to Stream Banks

Upon completion of work involving temporary stream bank impacts, stream banks are to be restored to pre-project grade and contours or beneficial grade and contours if the original bank slope is steep and unstable. Natural durable materials, native seed mixes, and native plants and shrubs are to be utilized in the restoration. Natural designs which use bioengineered and/or geo-engineered methods are to be applied. An engineered structure or material can be used to provide protection of a buried structure if it provides benefits to the stream bank environment, provided it is not in excess of the minimum amount needed for protection and does not exceed an average of one cubic yard per running foot placed along the bank below the plane of the ordinary high water mark. A permittee may request a waiver of this condition if it is determined a buried structure needs significant physical protection beyond those provided in this condition. This condition does not apply to NWP 27 – Aquatic Habitat Restoration, Enhancement, and Establishment Activities.

4.0 Additional Regional Conditions for Specific Nationwide Permits

4.1 NWP #3 – Maintenance

4.1.1 In designated trout watersheds, a PCN is not required for impacts to a maximum of 75 linear feet (150 linear feet for temporary dewatering) of streams and waterbodies when conducting maintenance activities. Minor deviations in an existing structure's configuration, temporary structures and temporary fills are authorized as part of the maintenance activity. In designated trout watersheds, the permittee shall submit a PCN (see Regional Condition 2.7 and General Condition 32) to the District Engineer prior to commencing the activity if; 1) impacts (other than temporary dewatering to work in dry conditions) to streams or waterbodies exceed 75 linear feet; 2) temporary impacts to streams or waterbodies associated with dewatering to work in dry conditions exceeds 150 linear feet; 3) the project will involve impacts to wetlands; 4) the project involves the replacement of a bridge or spanning structure with a culvert or non-spanning structure in waters of the United States; or 5) the activity will be constructed during the trout waters moratorium (October 15 through April 15).

4.1.2 The permittee shall submit a PCN (see NWP General Condition 32) to the District Engineer prior to commencing the activity if the activity involves repair, rehabilitation or replacement of impounding structures or parts of impounding structures or fills.

4.0 Additional Regional Conditions for Specific Nationwide Permits

4.1 NWP #12 - Utility Line Activities

4.1.1 Pipeline/utility line construction through jurisdictional waters and wetlands will be accomplished utilizing directional drilling/boring methods to the maximum extent practicable.

4.1.2 Temporary discharge of excavated or fill material into wetlands and waters of the United States will be for the absolute minimum period of time necessary to accomplish the work. Temporary discharges will be fully contained with appropriate erosion control or containment methods or otherwise such fills will consist of non-erodible materials.

4.1.3 The work area authorized by this permit, including temporary and/or permanent fills, will be minimized to the greatest extent practicable. Justification for work corridors exceeding forty (40) feet in width is required and will be based on pipeline diameter and length, size of equipment required to construct the utility line, and other construction information deemed necessary to support the request. The permittee is required to provide this information to the Corps with the initial notification package.

4.1.4 Excavated materials shall be returned to the excavated areas and any remaining materials shall be disposed of in uplands, unless the Corps authorizes disposal in waters of the United States.

4.1.5 In areas where a sub-aqueous utility line is to cross a federally-maintained channel, (i.e., the Atlantic Intracoastal Waterway [AIWW]), the line will be buried at least six (6) feet below the allowable overdepth of the authorized channel, including all side slopes. For areas outside federally-maintained channels, sub-aqueous lines must be installed at a minimum depth of two (2) feet below the substrate when such lines might interfere with navigation.

4.1.6 The minimum clearance*(see NOTE in 4.1.7) for aerial communication lines, or any lines not transmitting electrical power, will be ten (10) feet above the clearance required for nearby stationary bridges as established by the U.S. Coast Guard. In the event the U.S. Coast Guard has not established a bridge clearance, minimum vertical clearances for power and aerial lines will not be less than required by Section 23, Rule 232, of the latest revision of the National Electrical Safety Code (ANSI C2). Clearances will not be less than shown in Table 232-1, Item 7, ANSI C2.

4.1.7 The minimum clearance* for an aerial line, transmitting electrical power, is based on the low point of the line under conditions that produce the greatest sag, taking into consideration temperature, load, wind, length or span and the type of supports. The minimum clearance for an aerial electrical power transmission line crossing navigable waters of the United States, where there is an established bridge clearance established by the U.S. Coast Guard, shall be governed by the system voltage, as indicated below:

Nominal System	Minimum Clearance
Voltage, kilovolt	Above Bridge Clearance (As Established by the U.S. Coast Guard)

115 and below	20 feet
138	22
161	24
230	26
350	30
500	35
700	42
750 to 765	45

NOTE: Minimum clearance is the distance measured between the lowest point of a stationary bridge, including any infrastructure attached to underside of the bridge, and the Mean High Water (MHW) of the navigable waters of the United States beneath the bridge.

4.1.8 On navigable waters of the United States, including all federal navigation projects, where there is no bridge for reference for minimum clearance, the proposed project will need to be reviewed by the Corps in order to determine the minimum clearance between the line and MHW necessary to protect navigational interests.

4.1.9 A plan to restore and re-vegetate wetland areas cleared for construction must be submitted with the required PCN. Cleared wetland areas shall be re-vegetated to the maximum extent practicable with native species of canopy, shrub, and herbaceous species. Fescue grass shall not be used.

4.1.10 Any permanently maintained corridor along the utility right of way within forested wetlands shall be considered a permanent impact. A compensatory mitigation plan will be required for all such impacts associated with the requested activity if the activity requires PCN and the cumulative total of permanent forested wetland impacts exceeds 1/10-acre, unless the District Engineer determines in writing that either some other form of mitigation would be more environmentally appropriate or the adverse effects of the proposed activity are minimal.

For permanent forested wetland impacts of 1/10-acre or less, the District Engineer may determine, on a case-by-case basis, that compensatory mitigation is required to ensure that the activity results in minimal adverse effects on the aquatic environment.

4.1.11 Use of rip-rap or any other engineered structures to stabilize a stream bed should be avoided to the maximum extent practicable. If riprap stabilization is needed, it should be placed only on the stream banks, or, if it is necessary to be placed in the stream bed, the finished top elevation of the riprap should not exceed that of the original stream bed.

4.1.12 When directional boring or horizontal directional drilling (HDD) under waters of the United States, including wetlands, permittees shall closely monitor the project for hydraulic fracturing or “fracking.” Any discharge from hydraulic fracturing or “fracking” into waters of the United States, including wetlands, shall be reported to the appropriate Corps Regulatory Field Office within 48 hours. Restoration and/or compensatory mitigation may be required as a result of any unintended discharges.

4.1.13 For purposes of this NWP, the term utility line does not include pipes or culverts associated with driveways, roadways, lots, etc.

4.1.14 The permittee shall submit a PCN to the District Engineer prior to commencing the activity if the activity will involve the discharge of dredged or fill material into more than 1/10-acre of wetlands or 150 linear feet of stream channel for the construction of temporary access fills and/or temporary road crossings. The PCN must include a restoration plan that thoroughly describes how all temporary fills will be removed, describes how pre-project conditions will be restored, and includes a timetable for all restoration activities.



ROY COOPER
Governor

MICHAEL S. REGAN
Secretary

S. JAY ZIMMERMAN
Director

May 25, 2017
Montgomery/Moore Counties
NCDWR Project No. 20170621
Bridge 53 on NC 73
TIP No. B-5362

APPROVAL of 401 WATER QUALITY CERTIFICATION with ADDITIONAL CONDITIONS

Mr. Philip Harris, P.E.
Natural Environment Unit
1598 Mail Service Center
Raleigh, NC 27699

Dear Mr. Harris:

You have our approval, in accordance with the conditions listed below, for the following impacts for replacing Bridge 5361 with a new bridge over Drowning Creek on NC 73 in Montgomery/Moore Counties:

Wetland Impacts in the Lumber Basin (Riparian)

Site	Fill (ac)	Fill (temporary) (ac)	Excavation (ac)	Mechanized Clearing (ac)	Hand Clearing (ac)	Total Wetland Impact (ac)
1	-	-	-	0.03	-	<0.03
1	0.05	-	-	-	-	<0.05
Totals	0.05	-	-	0.03	-	<0.08

Total Wetland Impact for Project: <0.08 acres.

Stream Impacts in the Lumber Basin

Site	Temporary Fill in Perennial Stream (linear ft)	Riprap in Perennial Stream (linear ft)	Permanent Fill in Intermittent Stream (linear ft)	Temporary Fill in Intermittent Stream (linear ft)	Total Stream Impact (linear ft)	Stream Impacts Requiring Mitigation (linear ft)
1	5	70	-	-	0	-
Totals	5	70	-	-	0	-

Total Stream Impact for Project: 75 linear feet.



The project shall be constructed in accordance with your application dated received May 17, 2017. After reviewing your application, we have decided that these impacts are covered by General Water Quality Certification Numbers 4085 and 4086. This certification corresponds to Nationwide Permits 3 and 12 issued by the Corps of Engineers. You should acquire any other federal, state or local permits before you proceed with your project including (but not limited to) Sediment and Erosion Control, Non-Discharge and Water Supply Watershed regulations. This approval will expire with the accompanying 404 permit.

This approval is valid solely for the purpose and design described in your application (unless modified below). Should your project change, you must notify the NCDWR and submit a new application. If the property is sold, the new owner must be given a copy of this Certification and approval letter, and is thereby responsible for complying with all the conditions. If total wetland fills for this project (now or in the future) exceed one acre, or of total impacts to streams (now or in the future) exceed 300 linear feet, compensatory mitigation may be required as described in 15A NCAC 2H .0506 (h) (6) and (7). For this approval to remain valid, you must adhere to the conditions listed in the attached certification(s) and any additional conditions listed below.

Condition(s) of Certification

Project Specific Conditions:

1. As a condition of this 401 Water Quality Certification, the bridge demolition and construction must be accomplished in strict compliance with the most recent version of NCDOT's Best Management Practices for Construction and Maintenance Activities. [15A NCAC 02H .0507(d)(2) and 15A NCAC 02H .0506(b)(5)]
2. A turbidity curtain will be installed in the stream if driving or drilling activities occur within the stream channel, on the stream bank, or within 5 feet of the top of bank. This condition can be waived with prior approval from the NCDWR. [15A NCAC 02H .0506(b)(3)]
3. For projects impacting waters classified by the NC Environmental Management Commission as Water Supply II (WS II) High Quality Waters (HQW), stormwater shall be directed to vegetated buffer areas, grass-lined ditches or other means appropriate to the site for the purpose of pre-treating storm water runoff prior to discharging directly into streams. Mowing of existing vegetated buffers is strongly discouraged. [15A NCAC 02B.0224 and 0225]
4. The Permittee shall use Design Standards in Sensitive Watersheds (15A NCAC 4B.0124[a]-[e]) in areas draining to WSII HQW waters. However, due to the size of the project, the NCDOT shall not be required to meet 15A NCAC 4B .0124(a) regarding the maximum amount of uncovered acres.
5. NCDOT shall comply with the NCS00250 issued to the NCDOT, including the applicable requirements of the NCG01000. Please note the extra protections for the sensitive watersheds.
6. Tall fescue shall not be used in the establishment of temporary or permanent groundcover within riparian areas. For the establishment of permanent herbaceous cover, erosion control matting shall be used in conjunction with an appropriate native seed mix on disturbed soils within the riparian area and on disturbed steep slopes with the following exception. Erosion control matting is not necessary if the area is contained by perimeter erosion control devices such as silt fence, temporary sediment ditches, basins, etc. Matting should be secured in place with staples, stakes, or wherever possible, live stakes of native trees. Erosion control matting placed in riparian areas shall not contain a nylon mesh grid, which can impinge and entrap small animals. For the establishment of temporary groundcover within riparian areas, hydroseeding along with wood or cellulose based hydro mulch applied from a fertilizer- and limestone-free tank is allowable at the appropriate rate in conjunction with the erosion control measures. Discharging hydroseed mixtures and wood or

cellulose mulch into surface waters is prohibited. Riparian areas are defined as a distance 25 feet landward from top of stream bank. [15A NCAC 02B.0224 and 0225]

7. The post-construction removal of any temporary bridge structures must return the project site to its preconstruction contours and elevations. The impacted areas shall be revegetated with appropriate native species. [15A NCAC 02H .0506(b)(2)]
8. No drill slurry or water that has been in contact with uncured concrete shall be allowed to enter surface waters. This water shall be captured, treated, and disposed of properly. [15A NCAC 02H .0506(b)(3)]

General Conditions:

1. If concrete is used during construction, a dry work area shall be maintained to prevent direct contact between curing concrete and stream water. Water that inadvertently contacts uncured concrete shall not be discharged to surface waters due to the potential for elevated pH and possible aquatic life and fish kills. [15A NCAC 02B.0200]
2. During the construction of the project, no staging of equipment of any kind is permitted in waters of the U.S., or protected riparian buffers. [15A NCAC 02H.0506(b)(2)]
3. The dimension, pattern and profile of the stream above and below the crossing shall not be modified. Disturbed floodplains and streams shall be restored to natural geomorphic conditions. [15A NCAC 02H.0506(b)(2)]
4. The use of rip-rap above the Normal High Water Mark shall be minimized. Any rip-rap placed for stream stabilization shall be placed in stream channels in such a manner that it does not impede aquatic life passage. [15A NCAC 02H.0506(b)(2)]
- * 5. The Permittee shall ensure that the final design drawings adhere to the permit and to the permit drawings submitted for approval. [15A NCAC 02H .0507(c) and 15A NCAC 02H .0506 (b)(2) and (c)(2)]
6. All work in or adjacent to stream waters shall be conducted in a dry work area. Approved BMP measures from the most current version of NCDOT Construction and Maintenance Activities manual such as sandbags, rock berms, cofferdams and other diversion structures shall be used to prevent excavation in flowing water. [15A NCAC 02H.0506(b)(3) and (c)(3)]
7. Heavy equipment shall be operated from the banks rather than in the stream channel to minimize sedimentation and reduce the introduction of other pollutants into the stream. [15A NCAC 02H.0506(b)(3)]
8. All mechanized equipment operated near surface waters must be regularly inspected and maintained to prevent contamination of stream waters from fuels, lubricants, hydraulic fluids, or other toxic materials. [15A NCAC 02H.0506(b)(3)]
9. No rock, sand or other materials shall be dredged from the stream channel except where authorized by this certification. [15A NCAC 02H.0506(b)(3)]
10. Discharging hydroseed mixtures and washing out hydroseeders and other equipment in or adjacent to surface waters is prohibited. [15A NCAC 02H.0506(b)(3)]
11. The Permittee and its authorized agents shall conduct its activities in a manner consistent with State water quality standards (including any requirements resulting from compliance with §303(d) of the Clean Water Act) and any other appropriate requirements of State and Federal law. If the NCDWR

determines that such standards or laws are not being met (including the failure to sustain a designated or achieved use) or that State or federal law is being violated, or that further conditions are necessary to assure compliance, the NCDWR may reevaluate and modify this certification. [15A NCAC 02B.0200]

12. All fill slopes located in jurisdictional wetlands shall be placed at slopes no flatter than 3:1, unless otherwise authorized by this certification. [15A NCAC 02H.0506(b)(2)]
13. A copy of this Water Quality Certification shall be maintained on the construction site always. In addition, the Water Quality Certification and all subsequent modifications, if any, shall be maintained with the Division Engineer and the on-site project manager. [15A NCAC 02H .0507(c) and 15A NCAC 02H .0506 (b)(2) and (c)(2)]
14. The outside buffer, wetland or water boundary located within the construction corridor approved by this authorization shall be clearly marked by highly visible fencing prior to any land disturbing activities. Impacts to areas within the fencing are prohibited unless otherwise authorized by this certification. [15A NCAC 02H.0501 and .0502]
15. The issuance of this certification does not exempt the Permittee from complying with all statutes, rules, regulations, or ordinances that may be imposed by other government agencies (i.e. local, state, and federal) having jurisdiction, including but not limited to applicable buffer rules, stormwater management rules, soil erosion and sedimentation control requirements, etc.
16. The Permittee shall report any violations of this certification to the Division of Water Resources within 24 hours of discovery. [15A NCAC 02B.0506(b)(2)]
- *17. Upon completion of the project (including any impacts at associated borrow or waste sites), the NCDOT Division Engineer (or appointee) shall complete and return the enclosed "Certification of Completion Form" to notify the NCDWR when all work included in the 401 Certification has been completed. [15A NCAC 02H.0502(f)]
18. Native riparian vegetation must be reestablished in the riparian areas within the construction limits of the project by the end of the growing season following completion of construction. [15A NCAC 02B.0267(10)]
19. There shall be no excavation from, or waste disposal into, jurisdictional wetlands or waters associated with this permit without appropriate modification. Should waste or borrow sites, or access roads to waste or borrow sites, be located in wetlands or streams, compensatory mitigation will be required since that is a direct impact from road construction activities. [15A NCAC 02H.0506(b)(3) and (c)(3)]
20. Erosion and sediment control practices must be in full compliance with all specifications governing the proper design, installation and operation and maintenance of such Best Management Practices to protect surface waters standards [15A NCAC 02H.0506(b)(3) and (c)(3)]:
 - a. The erosion and sediment control measures for the project must be designed, installed, operated, and maintained in accordance with the most recent version of the *North Carolina Sediment and Erosion Control Planning and Design Manual*.
 - b. The design, installation, operation, and maintenance of the sediment and erosion control measures must be such that they equal, or exceed, the requirements specified in the most recent version of the *North Carolina Sediment and Erosion Control Manual*. The devices shall be maintained on all construction sites, borrow sites, and waste pile (spoil) projects, including contractor-owned or leased borrow pits associated with the project.

- c. For borrow pit sites, the erosion and sediment control measures must be designed, installed, operated, and maintained in accordance with the most recent version of the *North Carolina Surface Mining Manual*.
 - d. The reclamation measures and implementation must comply with the reclamation in accordance with the requirements of the Sedimentation Pollution Control Act.
21. Sediment and erosion control measures shall not be placed in wetlands or waters unless otherwise approved by this Certification. [15A NCAC 02H.0506(b)(3) and (c)(3)]

If you wish to contest any statement in the attached Certification you must file a petition for an administrative hearing. You may obtain the petition form from the office of Administrative hearings. You must file the petition with the office of Administrative Hearings within sixty (60) days of receipt of this notice. A petition is considered filed when it is received in the office of Administrative Hearings during normal office hours. The Office of Administrative Hearings accepts filings Monday through Friday between the hours of 8:00am and 5:00pm, except for official state holidays. The original and one (1) copy of the petition must be filed with the Office of Administrative Hearings.

The petition may be faxed-provided the original and one copy of the document is received by the Office of Administrative Hearings within five (5) business days following the faxed transmission.

The mailing address for the Office of Administrative Hearings is:

Office of Administrative Hearings
6714 Mail Service Center
Raleigh, NC 27699-6714
Telephone: (919) 431-3000, Facsimile: (919) 431-3100

A copy of the petition must also be served on DEQ as follows:

Mr. Bill Lane, General Counsel
Department of Environmental Quality
1601 Mail Service Center

This letter completes the review of the Division of Water Resources under Section 401 of the Clean Water Act. If you have any questions, please contact April Norton at (919)707-9111 or April.Norton@ncdent.gov.

Sincerely,



S. Jay Zimmerman, Director
Division of Water Resources

Electronic copy only distribution:

Andrew Williams, US Army Corps of Engineers, Raleigh Field Office
Chris Rivenbark, NCDOT-Natural Environment Section
Art King, Division 8 Environmental Officer
Travis Wilson, NC Wildlife Resources Commission
File Copy

STATE OF NORTH CAROLINA
DEPARTMENT OF ENVIRONMENTAL QUALITY
DIVISION OF WATER RESOURCES

WATER QUALITY GENERAL CERTIFICATION NO. 4085

GENERAL CERTIFICATION FOR PROJECTS ELIGIBLE FOR US ARMY CORPS OF ENGINEERS

- NATIONWIDE PERMIT 3 (MAINTENANCE),
- NATIONWIDE PERMIT 4 (FISH AND WILDLIFE HARVESTING, ENHANCEMENT, AND ATTRACTION DEVICES AND ACTIVITIES),
- NATIONWIDE PERMIT 5 (SCIENTIFIC MEASUREMENT DEVICES),
- NATIONWIDE PERMIT 6 (SURVEY ACTIVITIES),
- NATIONWIDE PERMIT 7 (OUTFALL STRUCTURES AND ASSOCIATED INTAKE STRUCTURES),
- NATIONWIDE PERMIT 19 (MINOR DREDGING),
- NATIONWIDE PERMIT 20 (RESPONSE OPERATIONS FOR OIL OR HAZARDOUS SUBSTANCES),
- NATIONWIDE PERMIT 22 (REMOVAL OF VESSELS),
- NATIONWIDE PERMIT 25 (STRUCTURAL DISCHARGES),
- NATIONWIDE PERMIT 30 (MOIST SOIL MANAGEMENT FOR WILDLIFE),
- NATIONWIDE PERMIT 32 (COMPLETED ENFORCEMENT ACTIONS),
- NATIONWIDE PERMIT 36 (BOAT RAMPS),
- REGIONAL GENERAL PERMIT 197800056 (PIERS, DOCKS AND BOATHOUSES), AND
- REGIONAL GENERAL PERMIT 197800125 (BOAT RAMPS)

Water Quality Certification Number 4085 is issued in conformity with the requirements of Section 401, Public Laws 92-500 and 95-217 of the United States and subject to the North Carolina Regulations in 15A NCAC 02H .0500 and 15A NCAC 02B .0200 for the discharge of fill material to surface waters and wetland areas as described in 33 CFR 330 Appendix A (B) (3, 4, 5, 6, 7, 19, 20, 22, 25, 30, 32, and 36) of the US Army Corps of Engineers regulations and Regional General Permits 197800056 and 197800125.

The State of North Carolina certifies that the specified category of activity will not violate applicable portions of Sections 301, 302, 303, 306 and 307 of the Public Laws 92-500 and 95-217 if conducted in accordance with the conditions hereinafter set forth.

Effective date: March 19, 2017

Signed this day March 3, 2017

By



for S. Jay Zimmerman, P.G.
Director

P-27
GC4085

Activities meeting any one (1) of the following thresholds or circumstances require written approval for a 401 Water Quality Certification from the Division of Water Resources (DWR):

- a) If any of the conditions of this Certification (listed below) cannot be met; or
- b) Total additional permanent impacts to streams (including stream relocations or restorations) greater than 40 linear feet at an existing stream impact location; or
- c) Total temporary and permanent impacts to wetlands equal to or greater than one-tenth (1/10) of an acre; or
- d) Any dewatering activity related to dam maintenance or removal; or
- e) Any impacts to streams from excavation or dredging, except for projects qualifying for a Nationwide Permit 19; or
- f) Any impacts to waters, or to wetlands adjacent to waters, designated as: ORW (including SAV), HQW (including PNA), SA, WS-I, WS-II, Trout, or North Carolina or National Wild and Scenic River, except for projects qualifying for a Nationwide Permit 3; or
- g) Any impacts to coastal wetlands [15A NCAC 07H .0205], or Unique Wetlands (UWL); or
- h) Any impact associated with a Notice of Violation or an enforcement action for violation(s) of NC Wetland Rules (15A NCAC 02H .0500), NC Isolated Wetland Rules (15A NCAC 02H .1300), NC Surface Water or Wetland Standards (15A NCAC 02B .0200), or State Regulated Riparian Buffer Rules (15A NCAC 02B .0200); or
- i) Any impacts to subject water bodies and/or state regulated riparian buffers along subject water bodies in the Neuse, Tar-Pamlico, or Catawba River Basins or in the Randleman Lake, Jordan Lake or Goose Creek Watersheds (or any other basin or watershed with State Regulated Riparian Area Protection Rules [Buffer Rules] in effect at the time of application) *unless*:
 - i) The activities are listed as "EXEMPT" from these rules; or
 - ii) A Buffer Authorization Certificate is issued by the NC Division of Coastal Management (DCM); or
 - iii) A Buffer Authorization Certificate or a Minor Variance is issued by a delegated or designated local government implementing a state riparian buffer program pursuant to 143-215.23.

Activities included in this General Certification that do not meet one of the thresholds listed above do not require written approval.

I. ACTIVITY SPECIFIC CONDITIONS:

1. For the North Carolina Department of Transportation, compliance with the NCDOT's individual NPDES permit NCS000250 shall serve to satisfy this condition. For all other projects that disturb one acre or more of land (including a project that disturbs less than one acre of land that is part of a larger common plan of development or sale); have permanent wetland, stream, or open water impacts; and are proposing new built-upon area shall comply with the following requirements: [15A NCAC 02H .0506(b)(5) and (c)(5)]

P-28
GC4085

- a. Stormwater management shall be provided throughout the entire project area in accordance with 15A NCAC 02H .1003. For the purposes of 15A NCAC 02H .1003(2)(a), density thresholds shall be determined in accordance with 15A NCAC 02H .1017.
- b. Projects that have vested rights, exemptions, or grandfathering from state or locally-implemented stormwater programs do not satisfy this condition. Projects that satisfy state or locally-implemented stormwater programs through use of community in-lieu programs do not satisfy this condition.
- c. Projects that require written authorization from DWR shall submit the following with their application for review and approval:
 - i. For projects that have a stormwater management plan (SMP) reviewed under a state stormwater program¹ or a state-approved local government stormwater program² shall submit plans that show the location and approximate size of all proposed stormwater measures;
 - ii. All other low density projects not covered above shall submit a completed low density supplement form with all required items; and
 - iii. All other high density projects not covered above shall submit a completed SMP, including all appropriate stormwater control measure (SCM) supplemental forms and associated items, that complies with the high density development requirements of 15A NCAC 02H .1003.
- d. Projects that do not require written approval from DWR shall obtain approval of the SMP, when required, before any impacts authorized by this Certification occur.
- e. SMPs approved by DWR may be phased on a case-by-case basis. SMPs for each future phase must be approved before construction of that phase is commenced. Approved SMPs may not be modified without prior written authorization from DWR.

II. GENERAL CONDITIONS:

- 1. When written authorization is required, the plans and specifications for the project are incorporated into the authorization by reference and are an enforceable part of the Certification. Any modifications to the project require notification to DWR and may require an application submittal to DWR with the appropriate fee. [15A NCAC 02H .0501 and .0502]
- 2. No waste, spoil, solids, or fill of any kind shall occur in wetlands or waters beyond the footprint of the impacts (including temporary impacts) as authorized in the written approval from DWR; or beyond the thresholds established for use of this Certification without written authorization. [15A NCAC 02H .0501 and .0502]

¹ e.g. Coastal Counties, HQW, ORW, or state-implemented Phase II NPDES

² e.g. Delegated Phase II NPDES, Water Supply Watershed, Nutrient-Sensitive Waters, or Universal Stormwater Management Program

P-29
GC4085

No removal of vegetation or other impacts of any kind shall occur to state regulated riparian buffers beyond the footprint of impacts approved in a Buffer Authorization or Variance or as listed as an exempt activity in the applicable riparian buffer rules. [15A NCAC 02B .0200]

3. In accordance with 15A NCAC 02H .0506(h), compensatory mitigation may be required for losses of greater than 150 linear feet of streams and/or greater than one (1) acre of wetlands. Impacts to isolated and other non-404 jurisdictional wetlands shall not be combined with 404 jurisdictional wetlands for the purpose of determining when impact thresholds trigger a mitigation requirement. For linear publicly owned and maintained transportation projects that are not determined to be part of a larger common plan of development by the US Army Corps of Engineers, compensatory mitigation may be required for losses of greater than 150 linear feet per stream.

Compensatory stream and/or wetland mitigation shall be proposed and completed in compliance with G.S. 143-214.11. For applicants proposing to conduct mitigation within a project site, a complete mitigation proposal developed in accordance with the most recent guidance issued by the US Army Corps of Engineers Wilmington District shall be submitted for review and approval with the application for impacts.

4. All activities shall be in compliance with any applicable State Regulated Riparian Buffer Rules in Chapter 2 of Title 15A.
5. When applicable, all construction activities shall be performed and maintained in full compliance with G.S. Chapter 113A Article 4 (Sediment and Pollution Control Act of 1973). Regardless of applicability of the Sediment and Pollution Control Act, all projects shall incorporate appropriate Best Management Practices for the control of sediment and erosion so that no violations of state water quality standards, statutes, or rules occur. [15A NCAC 02H .0506 (b)(3) and (c)(3) and 15A NCAC 02B .0200]

Design, installation, operation, and maintenance of all sediment and erosion control measures shall be equal to or exceed the requirements specified in the most recent version of the *North Carolina Sediment and Erosion Control Manual*, or for linear transportation projects, the *NCDOT Sediment and Erosion Control Manual*.

All devices shall be maintained on all construction sites, borrow sites, and waste pile (spoil) sites, including contractor-owned or leased borrow pits associated with the project. Sufficient materials required for stabilization and/or repair of erosion control measures and stormwater routing and treatment shall be on site at all times.

For borrow pit sites, the erosion and sediment control measures shall be designed, installed, operated, and maintained in accordance with the most recent version of the *North Carolina Surface Mining Manual*. Reclamation measures and implementation shall comply with the reclamation in accordance with the requirements of the Sedimentation Pollution Control Act and the Mining Act of 1971.

P-30
GC4085

If the project occurs in waters or watersheds classified as Primary Nursery Areas (PNAs), SA, WS-I, WS-II, High Quality Waters (HQW), or Outstanding Resource Waters (ORW), then the sedimentation and erosion control designs shall comply with the requirements set forth in 15A NCAC 04B .0124, *Design Standards in Sensitive Watersheds*.

6. Sediment and erosion control measures shall not be placed in wetlands or waters except within the footprint of temporary or permanent impacts authorized under this Certification. Exceptions to this condition require application to and written approval from DWR. [15A NCAC 02H .0501 and .0502]
7. Erosion control matting that incorporates plastic mesh and/or plastic twine shall not be used along streambanks or within wetlands. Exceptions to this condition require application to and written approval from DWR. [15A NCAC 02B .0201]
8. An NPDES Construction Stormwater Permit (NCG010000) is required for construction projects that disturb one (1) or more acres of land. The NCG010000 Permit allows stormwater to be discharged during land disturbing construction activities as stipulated in the conditions of the permit. If the project is covered by this permit, full compliance with permit conditions including the erosion & sedimentation control plan, inspections and maintenance, self-monitoring, record keeping and reporting requirements is required. [15A NCAC 02H .0506(b)(5) and (c)(5)]

The North Carolina Department of Transportation (NCDOT) shall be required to be in full compliance with the conditions related to construction activities within the most recent version of their individual NPDES (NCS000250) stormwater permit. [15A NCAC 02H .0506(b)(5) and (c)(5)]

9. All work in or adjacent to streams shall be conducted so that the flowing stream does not come in contact with the disturbed area. Approved best management practices from the most current version of the *NC Sediment and Erosion Control Manual*, or the *NC DOT Construction and Maintenance Activities Manual*, such as sandbags, rock berms, cofferdams, and other diversion structures shall be used to minimize excavation in flowing water. Exceptions to this condition require application to and written approval from DWR. [15A NCAC 02H .0506(b)(3) and (c)(3)]
10. If activities must occur during periods of high biological activity (e.g. sea turtle nesting, fish spawning, or bird nesting), then biological monitoring may be required at the request of other state or federal agencies and coordinated with these activities. [15A NCAC 02H .0506 (b)(2) and 15A NCAC 04B .0125]

All moratoriums on construction activities established by the NC Wildlife Resources Commission (WRC), US Fish and Wildlife Service (USFWS), NC Division of Marine Fisheries (DMF), or National Marine Fisheries Service (NMFS) shall be implemented. Exceptions to this condition require written approval by the resource agency responsible for the given moratorium. A copy of the approval from the resource agency shall be forwarded to DWR.

P-31 GC4085

Work within a designated trout watershed of North Carolina (as identified by the Wilmington District of the US Army Corps of Engineers), or identified state or federal endangered or threatened species habitat, shall be coordinated with the appropriate WRC, USFWS, NMFS, and/or DMF personnel.

11. Culverts shall be designed and installed in such a manner that the original stream profiles are not altered and allow for aquatic life movement during low flows. The dimension, pattern, and profile of the stream above and below a pipe or culvert shall not be modified by widening the stream channel or by reducing the depth of the stream in connection with the construction activity. The width, height, and gradient of a proposed culvert shall be such as to pass the average historical low flow and spring flow without adversely altering flow velocity. [15A NCAC 02H .0506(b)(2) and (c)(2)]

Placement of culverts and other structures in streams shall be below the elevation of the streambed by one foot for all culverts with a diameter greater than 48 inches, and 20% of the culvert diameter for culverts having a diameter less than or equal to 48 inches, to allow low flow passage of water and aquatic life.

If multiple pipes or barrels are required, they shall be designed to mimic the existing stream cross section as closely as possible, including pipes or barrels at flood plain elevation and/or sills where appropriate. Widening the stream channel shall be avoided.

When topographic constraints indicate culvert slopes of greater than 5%, culvert burial is not required, provided that all alternative options for flattening the slope have been investigated and aquatic life movement/connectivity has been provided when possible (e.g. rock ladders, cross vanes, etc.). Notification, including supporting documentation to include a location map of the culvert, culvert profile drawings, and slope calculations, shall be provided to DWR 60 calendar days prior to the installation of the culvert.

When bedrock is present in culvert locations, culvert burial is not required provided that there is sufficient documentation of the presence of bedrock. Notification, including supporting documentation such as a location map of the culvert, geotechnical reports, photographs, etc. shall be provided to DWR a minimum of 60 calendar days prior to the installation of the culvert. If bedrock is discovered during construction, then DWR shall be notified by phone or email within 24 hours of discovery.

If other site-specific topographic constraints preclude the ability to bury the culverts as described above and/or it can be demonstrated that burying the culvert would result in destabilization of the channel, then exceptions to this condition require application to and written approval from DWR.

Installation of culverts in wetlands shall ensure continuity of water movement and be designed to adequately accommodate high water or flood conditions. When roadways, causeways, or other fill projects are constructed across FEMA-designated floodways or wetlands, openings such as culverts or bridges shall be provided to maintain the natural hydrology of the system as well as prevent constriction of the floodway that may result in destabilization of streams or wetlands.

The establishment of native woody vegetation and other soft stream bank stabilization techniques shall be used where practicable instead of rip-rap or other bank hardening methods.

12. Bridge deck drains shall not discharge directly into the stream. Stormwater shall be directed across the bridge and pre-treated through site-appropriate means to the maximum extent practicable (e.g. grassed swales, pre-formed scour holes, vegetated buffers, etc.) before entering the stream. Exceptions to this condition require application to and written approval from DWR. [15A NCAC 02H .0506(b)(5)]
13. Application of fertilizer to establish planted/seeded vegetation within disturbed riparian areas and/or wetlands shall be conducted at agronomic rates and shall comply with all other Federal, State and Local regulations. Fertilizer application shall be accomplished in a manner that minimizes the risk of contact between the fertilizer and surface waters. [15A NCAC 02B .0200 and 15A NCAC 02B .0231]
14. If concrete is used during construction, then all necessary measures shall be taken to prevent direct contact between uncured or curing concrete and waters of the state. Water that inadvertently contacts uncured concrete shall not be discharged to waters of the state. [15A NCAC 02B .0200]
15. All proposed and approved temporary fill and culverts shall be removed and the impacted area shall be returned to natural conditions within 60 calendar days after the temporary impact is no longer necessary. The impacted areas shall be restored to original grade, including each stream's original cross sectional dimensions, planform pattern, and longitudinal bed profile. For projects that receive written approval, no temporary impacts are allowed beyond those included in the application and authorization. All temporarily impacted sites shall be restored and stabilized with native vegetation. [15A NCAC 02H .0506(b)(2) and (c)(2)]
16. All proposed and approved temporary pipes/culverts/rip-rap pads etc. in streams shall be installed as outlined in the most recent edition of the *North Carolina Sediment and Erosion Control Planning and Design Manual* or the *North Carolina Surface Mining Manual* or the *North Carolina Department of Transportation Best Management Practices for Construction and Maintenance Activities* so as not to restrict stream flow or cause dis-equilibrium during use of this Certification. [15A NCAC 02H .0506(b)(2) and (c)(2)]

P-33
GC4085

17. Any rip-rap required for proper culvert placement, stream stabilization, or restoration of temporarily disturbed areas shall be restricted to the area directly impacted by the approved construction activity. All rip-rap shall be placed such that the original stream elevation and streambank contours are restored and maintained. Placement of rip-rap or other approved materials shall not result in de-stabilization of the stream bed or banks upstream or downstream of the area or in a manner that precludes aquatic life passage. [15A NCAC 02H .0506(b)(2)]
18. Any rip-rap used for stream or shoreline stabilization shall be of a size and density to prevent movement by wave, current action, or stream flows and shall consist of clean rock or masonry material free of debris or toxic pollutants. Rip-rap shall not be installed in the streambed except in specific areas required for velocity control and to ensure structural integrity of bank stabilization measures. [15A NCAC 02H .0506(b)(2)]
19. Applications for rip-rap groins proposed in accordance with 15A NCAC 07H .1401 (NC Division of Coastal Management General Permit for construction of Wooden and Rip-rap Groins in Estuarine and Public Trust Waters) shall meet all the specific conditions for design and construction specified in 15A NCAC 07H .1405.
20. All mechanized equipment operated near surface waters should be inspected and maintained regularly to prevent contamination of surface waters from fuels, lubricants, hydraulic fluids, or other toxic materials. Construction shall be staged in order to minimize the exposure of equipment to surface waters to the maximum extent practicable. Fueling, lubrication and general equipment maintenance should not take place within 50 feet of a waterbody or wetlands to prevent contamination by fuels and oils. [15A NCAC 02H .0506 (b)(3) and (c)(3) and 15A NCAC 02B .0211 (12)]
21. Heavy equipment working in wetlands shall be placed on mats or other measures shall be taken to minimize soil disturbance. [15A NCAC 02H .0506 (b)(3) and (c)(3)]
22. In accordance with 143-215.85(b), the applicant shall report any petroleum spill of 25 gallons or more; any spill regardless of amount that causes a sheen on surface waters; any petroleum spill regardless of amount occurring within 100 feet of surface waters; and any petroleum spill less than 25 gallons that cannot be cleaned up within 24 hours.
23. If an environmental document is required under the State Environmental Policy Act (SEPA), then this General Certification is not valid until a Finding of No Significant Impact (FONSI) or Record of Decision (ROD) is issued by the State Clearinghouse. If an environmental document is required under the National Environmental Policy Act (NEPA), then this General Certification is not valid until a Categorical Exclusion, the Final Environmental Assessment, or Final Environmental Impact Statement is published by the lead agency. [15A NCAC 01C .0107(a)]
24. This General Certification does not relieve the applicant of the responsibility to obtain all other required Federal, State, or Local approvals before proceeding with the project,

including those required by, but not limited to, Sediment and Erosion Control, Non-Discharge, Water Supply Watershed, and Trout Buffer regulations.

25. The applicant and their authorized agents shall conduct all activities in a manner consistent with State water quality standards (including any requirements resulting from compliance with §303(d) of the Clean Water Act), and any other appropriate requirements of State and Federal Law. If DWR determines that such standards or laws are not being met, including failure to sustain a designated or achieved use, or that State or Federal law is being violated, or that further conditions are necessary to assure compliance, then DWR may revoke or modify a written authorization associated with this General Water Quality Certification. [15A NCAC 02H .0507(d)]
26. When written authorization is required for use of this Certification, upon completion of all permitted impacts included within the approval and any subsequent modifications, the applicant shall be required to return a certificate of completion (available on the DWR website <https://edocs.deq.nc.gov/Forms/Certificate-of-Completion>). [15A NCAC 02H .0502(f)]
27. Additional site-specific conditions, including monitoring and/or modeling requirements, may be added to the written approval letter for projects proposed under this Water Quality Certification in order to ensure compliance with all applicable water quality and effluent standards. [15A NCAC 02H .0507(c)]
28. If the property or project is sold or transferred, the new Permittee shall be given a copy of this Certification (and written authorization if applicable) and is responsible for complying with all conditions. [15A NCAC 02H .0501 and .0502]

III. GENERAL CERTIFICATION ADMINISTRATION:

1. In accordance with North Carolina General Statute 143-215.3D(e), written approval for a 401 Water Quality General Certification must include the appropriate fee. An applicant for a CAMA permit under Article 7 of Chapter 113A of the General Statutes for which a Water Quality Certification is required shall only make one payment to satisfy both agencies; the fee shall be as established by the Secretary in accordance with 143-215.3D(e)(7).
2. This Certification neither grants nor affirms any property right, license, or privilege in any waters, or any right of use in any waters. This Certification does not authorize any person to interfere with the riparian rights, littoral rights, or water use rights of any other person and this Certification does not create any prescriptive right or any right of priority regarding any usage of water. This Certification shall not be interposed as a defense in any action respecting the determination of riparian or littoral rights or other rights to water use. No consumptive user is deemed by virtue of this Certification to possess any prescriptive or other right of priority with respect to any other consumptive user regardless of the quantity of the withdrawal or the date on which the withdrawal was initiated or expanded.

P-35
GC4085

3. This Certification grants permission to the Director, an authorized representative of the Director, or DWR staff, upon the presentation of proper credentials, to enter the property during normal business hours. [15A NCAC 02H .0502(e)]
4. This General Certification shall expire on the same day as the expiration date of the corresponding Nationwide Permit and/or Regional General Permit. The conditions in effect on the date of issuance of Certification for a specific project shall remain in effect for the life of the project, regardless of the expiration date of this Certification. This General Certification is rescinded when the US Army Corps of Engineers reauthorizes any of the corresponding Nationwide Permits and/or Regional General Permits or when deemed appropriate by the Director of the Division of Water Resources.
5. Non-compliance with or violation of the conditions herein set forth by a specific project may result in revocation of this General Certification for the project and may also result in criminal and/or civil penalties.
6. The Director of the North Carolina Division of Water Resources may require submission of a formal application for Individual Certification for any project in this category of activity if it is determined that the project is likely to have a significant adverse effect upon water quality, including state or federally listed endangered or threatened aquatic species, or degrade the waters so that existing uses of the waters or downstream waters are precluded.
7. Public hearings may be held prior to a Certification decision if deemed in the public's best interest by the Director of the North Carolina Division of Water Resources.

History Note: Water Quality Certification (WQC) Number 4085 issued March 3, 2017 replaces WQC 3883 issued March 19, 2012; WQC Number 3687 issued November 1, 2007; WQC Number 3624 issued March 19, 2007; WQC Number 3494 issued December 31, 2004; and WQC Number 3376 issued March 18, 2002.

STATE OF NORTH CAROLINA
DEPARTMENT OF ENVIRONMENTAL QUALITY
DIVISION OF WATER RESOURCES

WATER QUALITY GENERAL CERTIFICATION NO. 4086

GENERAL CERTIFICATION FOR PROJECTS ELIGIBLE FOR US ARMY CORPS OF ENGINEERS

- NATIONWIDE PERMIT 12 (UTILITY LINE ACTIVITIES)

Water Quality Certification Number 4086 is issued in conformity with the requirements of Section 401, Public Laws 92-500 and 95-217 of the United States and subject to the North Carolina Regulations in 15A NCAC 02H .0500 and 15A NCAC 02B .0200 for the discharge of fill material to surface waters and wetland areas as described in 33 CFR 330 Appendix A (B) (12) of the US Army Corps of Engineers regulations.

The State of North Carolina certifies that the specified category of activity will not violate applicable portions of Sections 301, 302, 303, 306 and 307 of the Public Laws 92-500 and 95-217 if conducted in accordance with the conditions hereinafter set forth.

Effective date: March 19, 2017

Signed this day March 3, 2017

By

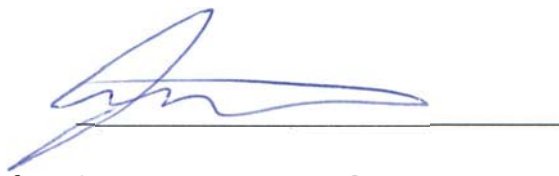

for S. Jay Zimmerman, P.G.
Director

P-37
GC4086

Activities meeting any one (1) of the following thresholds or circumstances require written approval for a 401 Water Quality Certification from the Division of Water Resources (DWR):

- a) If any of the Conditions of this Certification (listed below) cannot be met; or
- b) Any permanent fill into or modification of wetlands and/or waters; or
- c) Total temporary impacts to streams greater than 500 feet; or
- d) Any stream relocation or stream restoration; or
- e) Any impacts to waters, or to wetlands adjacent to waters, designated as: ORW (including SAV), HQW (including PNA), SA, WS-I, WS-II, Trout, or North Carolina or National Wild and Scenic River; or
- f) Any impacts to coastal wetlands [15A NCAC 07H .0205], or Unique Wetlands (UWL); or
- g) Any impact associated with a Notice of Violation or an enforcement action for violation(s) of NC Wetland Rules (15A NCAC 02H .0500), NC Isolated Wetland Rules (15A NCAC 02H .1300), NC Surface Water or Wetland Standards (15A NCAC 02B .0200), or State Regulated Riparian Buffer Rules (15A NCAC 02B .0200); or
- h) Any impacts to subject water bodies and/or state regulated riparian buffers along subject water bodies in the Neuse, Tar-Pamlico, or Catawba River Basins or in the Randleman Lake, Jordan Lake or Goose Creek Watersheds (or any other basin or watershed with State Regulated Riparian Area Protection Rules [Buffer Rules] in effect at the time of application) *unless*:
 - i) The activities are listed as "EXEMPT" from these rules; or
 - ii) A Buffer Authorization Certificate is issued by the NC Division of Coastal Management (DCM); or
 - iii) A Buffer Authorization Certificate or a Minor Variance is issued by a delegated or designated local government implementing a state riparian buffer program pursuant to 143-215.23.

Activities included in this General Certification that do not meet one of the thresholds listed above do not require written approval.

I. ACTIVITY SPECIFIC CONDITIONS:

- 1. All sewer lines shall be designed, constructed and maintained in accordance with Title 15A NCAC Chapter 02T.
- 2. Any utility construction corridor that is parallel to a stream or open water shall not be closer than 10 feet to the top of bank or ordinary high water mark. Exceptions to this condition require application to and written approval from DWR. [15A NCAC 02H .0506 (b)(4) and (c)(4)]
- 3. Utility lines shall cross all stream channels at a near-perpendicular direction (i.e., between 75 degrees and 105 degrees to the stream bank). Exceptions to this condition require application to and written approval from DWR. [15A NCAC 02H .0506 (b)(2) and (c)(2)]

P-38
GC4086

4. Construction corridors in wetlands and across stream channels shall be minimized to the maximum extent practicable and shall not exceed 50 feet wide for gas utility lines and 40 feet wide for all other utility lines. Exceptions to this condition require application to and written approval from DWR. [15A NCAC 02H .0506 (b)(2) and (c)(2)]

For construction corridors in wetlands and across stream channels, stumps shall be grubbed only as needed to install the utility and remaining stumps shall be cut off at grade level. The general stripping of topsoil within wetlands along the construction corridor is not permitted.

5. Permanent maintained access corridors in wetlands and across stream channels shall be restricted to the minimum width practicable and shall not exceed 30 feet wide for gas utility lines and 20 feet wide for all other utility lines except at manhole locations. 15-foot by 15-foot perpendicular vehicle turnarounds shall be allowed in access corridors but must be spaced at least 500 feet apart. Exceptions to this condition require application to and written approval from DWR. [15A NCAC 02H .0506 (b)(2) and (c)(2)]
6. For all utility lines constructed within wetlands, an anti-seep collar shall be placed at the downstream (utility line gradient) wetland boundary and every 150 feet up the gradient until the utility exits the wetland. Anti-seep collars may be constructed with class B concrete, compacted clay, PVC pipe, or metal collars. Wetland crossings that are directionally drilled, and perpendicular wetland crossings that are open cut and less than 150 feet long do not require anti-seep collars. The compacted clay shall have a specific infiltration of 1×10^{-5} cm/sec or less. A section and plan view diagram is attached for the anti-seep collars. [15A NCAC 02H .0506 (b)(4) and (c)(4)]

The following specifications shall apply to class B concrete:

- a. Minimum cement content, sacks per cubic yard with rounded course aggregate 5.0
 - b. Minimum cement content, sacks per cubic yard with angular course aggregate 5.5
 - c. Maximum water-cement ratio gallons per sack 6.8
 - d. Slump range 2" to 4"
 - e. Minimum strength - 28 day psi 2,500
7. The applicant shall have a specific plan for restoring wetland contours. Any excess material will be removed to a high ground disposal area. [15A NCAC 02H .0506 (b)(2) and (c)(2)]

The mixing of topsoil and subsoils within the wetlands along utility corridors shall be minimized to the greatest extent practical. During excavation, the soils shall be placed on fabric to minimize impacts whenever possible. Topsoil excavated from utility trenches will be piled separately from subsoils and will be backfilled into the trench only after the subsoils have been placed and compacted.

P-39
GC4086

8. For the North Carolina Department of Transportation, compliance with the NCDOT's individual NPDES permit NCS000250 shall serve to satisfy this condition. For all other utility line and associated facilities projects that disturb one acre or more of land (including a project that disturbs less than one acre of land that is part of a larger common plan of development or sale); have permanent wetland, stream, or open water impacts; and are proposing new built-upon area shall comply with the following requirements: [15A NCAC 02H .0506(b)(5) and (c)(5)]
- a. Stormwater management shall be provided throughout the entire project area in accordance with 15A NCAC 02H .1003. For the purposes of 15A NCAC 02H .1003(2)(a), density thresholds shall be determined in accordance with 15A NCAC 02H .1017.
 - b. Projects that have vested rights, exemptions, or grandfathering from state or locally-implemented stormwater programs do not satisfy this condition. Projects that satisfy state or locally-implemented stormwater programs through use of community in-lieu programs do not satisfy this condition.
 - c. Projects that require written authorization from DWR shall submit the following with their application for review and approval:
 - i. For projects that have a stormwater management plan (SMP) reviewed under a state stormwater program¹ or a state-approved local government stormwater program² shall submit plans that show the location and approximate size of all proposed stormwater measures;
 - ii. All other low density projects not covered above shall submit a completed low density supplement form with all required items; and
 - iii. All other high density projects not covered above shall submit a completed SMP, including all appropriate stormwater control measure (SCM) supplemental forms and associated items, that complies with the high density development requirements of 15A NCAC 02H .1003.
 - d. Projects that do not require written approval from DWR shall obtain approval of the SMP, when required, before any impacts authorized by this Certification occur.
 - e. SMPs approved by DWR may be phased on a case-by-case basis. SMPs for each future phase must be approved before construction of that phase commences. Approved SMPs may not be modified without prior written authorization from DWR.

¹ e.g. Coastal Counties, HQW, ORW, or state-implemented Phase II NPDES

² e.g. Delegated Phase II NPDES, Water Supply Watershed, Nutrient-Sensitive Waters, or Universal Stormwater Management Program

P-40
GC4086

II. GENERAL CONDITIONS:

1. When written authorization is required, the plans and specifications for the project are incorporated into the authorization by reference and are an enforceable part of the Certification. Any modifications to the project require notification to DWR and may require an application submittal to DWR with the appropriate fee. [15A NCAC 02H .0501 and .0502]
2. No waste, spoil, solids, or fill of any kind shall occur in wetlands or waters beyond the footprint of the impacts (including temporary impacts) as authorized in the written approval from DWR; or beyond the thresholds established for use of this Certification without written authorization. [15A NCAC 02H .0501 and .0502]

No removal of vegetation or other impacts of any kind shall occur to state regulated riparian buffers beyond the footprint of impacts approved in a Buffer Authorization or Variance or as listed as an exempt activity in the applicable riparian buffer rules. [15A NCAC 02B .0200]

3. In accordance with 15A NCAC 02H .0506(h), compensatory mitigation may be required for losses of greater than 150 linear feet of streams and/or greater than one (1) acre of wetlands. Impacts to isolated and other non-404 jurisdictional wetlands shall not be combined with 404 jurisdictional wetlands for the purpose of determining when impact thresholds trigger a mitigation requirement. For linear publicly owned and maintained transportation projects that are not determined to be part of a larger common plan of development by the US Army Corps of Engineers, compensatory mitigation may be required for losses of greater than 150 linear feet per stream.

Compensatory stream and/or wetland mitigation shall be proposed and completed in compliance with G.S. 143-214.11. For applicants proposing to conduct mitigation within a project site, a complete mitigation proposal developed in accordance with the most recent guidance issued by the US Army Corps of Engineers Wilmington District shall be submitted for review and approval with the application for impacts.

4. All activities shall be in compliance with any applicable State Regulated Riparian Buffer Rules in Chapter 2 of Title 15A.
5. When applicable, all construction activities shall be performed and maintained in full compliance with G.S. Chapter 113A Article 4 (Sediment and Pollution Control Act of 1973). Regardless of applicability of the Sediment and Pollution Control Act, all projects shall incorporate appropriate Best Management Practices for the control of sediment and erosion so that no violations of state water quality standards, statutes, or rules occur. [15A NCAC 02H .0506 (b)(3) and (c)(3) and 15A NCAC 02B .0200]

Design, installation, operation, and maintenance of all sediment and erosion control measures shall be equal to or exceed the requirements specified in the most recent version of the *North Carolina Sediment and Erosion Control Manual*, or for linear transportation projects, the *NCDOT Sediment and Erosion Control Manual*.

P-41 GC4086

All devices shall be maintained on all construction sites, borrow sites, and waste pile (spoil) sites, including contractor-owned or leased borrow pits associated with the project. Sufficient materials required for stabilization and/or repair of erosion control measures and stormwater routing and treatment shall be on site at all times.

For borrow pit sites, the erosion and sediment control measures shall be designed, installed, operated, and maintained in accordance with the most recent version of the *North Carolina Surface Mining Manual*. Reclamation measures and implementation shall comply with the reclamation in accordance with the requirements of the Sedimentation Pollution Control Act and the Mining Act of 1971.

If the project occurs in waters or watersheds classified as Primary Nursery Areas (PNAs), SA, WS-I, WS-II, High Quality Waters (HQW), or Outstanding Resource Waters (ORW), then the sedimentation and erosion control designs shall comply with the requirements set forth in 15A NCAC 04B .0124, *Design Standards in Sensitive Watersheds*.

6. Sediment and erosion control measures shall not be placed in wetlands or waters except within the footprint of temporary or permanent impacts authorized under this Certification. Exceptions to this condition require application to and written approval from DWR. [15A NCAC 02H .0501 and .0502]
7. Erosion control matting that incorporates plastic mesh and/or plastic twine shall not be used along streambanks or within wetlands. Exceptions to this condition require application to and written approval from DWR. [15A NCAC 02B .0201]
8. An NPDES Construction Stormwater Permit (NCG010000) is required for construction projects that disturb one (1) or more acres of land. The NCG010000 Permit allows stormwater to be discharged during land disturbing construction activities as stipulated in the conditions of the permit. If the project is covered by this permit, full compliance with permit conditions including the erosion & sedimentation control plan, inspections and maintenance, self-monitoring, record keeping and reporting requirements is required. [15A NCAC 02H .0506(b)(5) and (c)(5)]

The North Carolina Department of Transportation (NCDOT) shall be required to be in full compliance with the conditions related to construction activities within the most recent version of their individual NPDES (NCS000250) stormwater permit. [15A NCAC 02H .0506(b)(5) and (c)(5)]

9. All work in or adjacent to streams shall be conducted so that the flowing stream does not come in contact with the disturbed area. Approved best management practices from the most current version of the *NC Sediment and Erosion Control Manual*, or the *NC DOT Construction and Maintenance Activities Manual*, such as sandbags, rock berms, cofferdams, and other diversion structures shall be used to minimize excavation in flowing water. Exceptions to this condition require application to and written approval from DWR. [15A NCAC 02H .0506(b)(3) and (c)(3)]

10. If activities must occur during periods of high biological activity (e.g. sea turtle nesting, fish spawning, or bird nesting), then biological monitoring may be required at the request of other state or federal agencies and coordinated with these activities. [15A NCAC 02H .0506 (b)(2) and 15A NCAC 04B .0125]

All moratoriums on construction activities established by the NC Wildlife Resources Commission (WRC), US Fish and Wildlife Service (USFWS), NC Division of Marine Fisheries (DMF), or National Marine Fisheries Service (NMFS) shall be implemented. Exceptions to this condition require written approval by the resource agency responsible for the given moratorium. A copy of the approval from the resource agency shall be forwarded to DWR.

Work within a designated trout watershed of North Carolina (as identified by the Wilmington District of the US Army Corps of Engineers), or identified state or federal endangered or threatened species habitat, shall be coordinated with the appropriate WRC, USFWS, NMFS, and/or DMF personnel.

11. Culverts shall be designed and installed in such a manner that the original stream profiles are not altered and allow for aquatic life movement during low flows. The dimension, pattern, and profile of the stream above and below a pipe or culvert shall not be modified by widening the stream channel or by reducing the depth of the stream in connection with the construction activity. The width, height, and gradient of a proposed culvert shall be such as to pass the average historical low flow and spring flow without adversely altering flow velocity. [15A NCAC 02H .0506(b)(2) and (c)(2)]

Placement of culverts and other structures in streams shall be below the elevation of the streambed by one foot for all culverts with a diameter greater than 48 inches, and 20% of the culvert diameter for culverts having a diameter less than or equal to 48 inches, to allow low flow passage of water and aquatic life.

If multiple pipes or barrels are required, they shall be designed to mimic the existing stream cross section as closely as possible including pipes or barrels at flood plain elevation and/or sills where appropriate. Widening the stream channel shall be avoided.

When topographic constraints indicate culvert slopes of greater than 5%, culvert burial is not required, provided that all alternative options for flattening the slope have been investigated and aquatic life movement/connectivity has been provided when possible (e.g. rock ladders, cross vanes, etc.). Notification, including supporting documentation to include a location map of the culvert, culvert profile drawings, and slope calculations, shall be provided to DWR 60 calendar days prior to the installation of the culvert.

When bedrock is present in culvert locations, culvert burial is not required provided that there is sufficient documentation of the presence of bedrock. Notification, including supporting documentation such as a location map of the culvert, geotechnical reports, photographs, etc. shall be provided to DWR a minimum of 60 calendar days prior to the installation of the culvert. If bedrock is discovered during construction, then DWR shall be notified by phone or email within 24 hours of discovery.

P-43 GC4086

If other site-specific topographic constraints preclude the ability to bury the culverts as described above and/or it can be demonstrated that burying the culvert would result in destabilization of the channel, then exceptions to this condition require application to and written approval from DWR.

Installation of culverts in wetlands shall ensure continuity of water movement and be designed to adequately accommodate high water or flood conditions. When roadways, causeways, or other fill projects are constructed across FEMA-designated floodways or wetlands, openings such as culverts or bridges shall be provided to maintain the natural hydrology of the system as well as prevent constriction of the floodway that may result in destabilization of streams or wetlands.

The establishment of native woody vegetation and other soft stream bank stabilization techniques shall be used where practicable instead of rip-rap or other bank hardening methods.

12. Bridge deck drains shall not discharge directly into the stream. Stormwater shall be directed across the bridge and pre-treated through site-appropriate means to the maximum extent practicable (e.g. grassed swales, pre-formed scour holes, vegetated buffers, etc.) before entering the stream. Exceptions to this condition require application to and written approval from DWR. [15A NCAC 02H .0506(b)(5)]
13. Application of fertilizer to establish planted/seeded vegetation within disturbed riparian areas and/or wetlands shall be conducted at agronomic rates and shall comply with all other Federal, State and Local regulations. Fertilizer application shall be accomplished in a manner that minimizes the risk of contact between the fertilizer and surface waters. [15A NCAC 02B .0200 and 15A NCAC 02B .0231]
14. If concrete is used during construction, then all necessary measures shall be taken to prevent direct contact between uncured or curing concrete and waters of the state. Water that inadvertently contacts uncured concrete shall not be discharged to waters of the state. [15A NCAC 02B .0200]
15. All proposed and approved temporary fill and culverts shall be removed and the impacted area shall be returned to natural conditions within 60 calendar days after the temporary impact is no longer necessary. The impacted areas shall be restored to original grade, including each stream's original cross sectional dimensions, planform pattern, and longitudinal bed profile. For projects that receive written approval, no temporary impacts are allowed beyond those included in the application and authorization. All temporarily impacted sites shall be restored and stabilized with native vegetation. [15A NCAC 02H .0506(b)(2) and (c)(2)]

P-44
GC4086

16. All proposed and approved temporary pipes/culverts/rip-rap pads etc. in streams shall be installed as outlined in the most recent edition of the *North Carolina Sediment and Erosion Control Planning and Design Manual* or the *North Carolina Surface Mining Manual* or the *North Carolina Department of Transportation Best Management Practices for Construction and Maintenance Activities* so as not to restrict stream flow or cause dis-equilibrium during use of this Certification. [15A NCAC 02H .0506(b)(2) and (c)(2)]
17. Any rip-rap required for proper culvert placement, stream stabilization, or restoration of temporarily disturbed areas shall be restricted to the area directly impacted by the approved construction activity. All rip-rap shall be placed such that the original stream elevation and streambank contours are restored and maintained. Placement of rip-rap or other approved materials shall not result in de-stabilization of the stream bed or banks upstream or downstream of the area or in a manner that precludes aquatic life passage. [15A NCAC 02H .0506(b)(2)]
18. Any rip-rap used for stream or shoreline stabilization shall be of a size and density to prevent movement by wave, current action, or stream flows and shall consist of clean rock or masonry material free of debris or toxic pollutants. Rip-rap shall not be installed in the streambed except in specific areas required for velocity control and to ensure structural integrity of bank stabilization measures. [15A NCAC 02H .0506(b)(2)]
19. Applications for rip-rap groins proposed in accordance with 15A NCAC 07H .1401 (NC Division of Coastal Management General Permit for construction of Wooden and Rip-rap Groins in Estuarine and Public Trust Waters) shall meet all the specific conditions for design and construction specified in 15A NCAC 07H .1405.
20. All mechanized equipment operated near surface waters shall be inspected and maintained regularly to prevent contamination of stream waters from fuels, lubricants, hydraulic fluids, or other toxic materials. Construction shall be staged in order to minimize the exposure of equipment to surface waters to the maximum extent practicable. Fueling, lubrication and general equipment maintenance shall not take place within 50 feet of a waterbody or wetlands to prevent contamination by fuels and oils. [15A NCAC 02H .0506(b)(3) and (c)(3) and 15A NCAC 02B .0211 (12)]
21. Heavy equipment working in wetlands shall be placed on mats or other measures shall be taken to minimize soil disturbance. [15A NCAC 02H .0506(b)(3) and (c)(3)]
22. In accordance with 143-215.85(b), the applicant shall report any petroleum spill of 25 gallons or more; any spill regardless of amount that causes a sheen on surface waters; any petroleum spill regardless of amount occurring within 100 feet of surface waters; and any petroleum spill less than 25 gallons that cannot be cleaned up within 24 hours.

P-45
GC4086

23. If an environmental document is required under the State Environmental Policy Act (SEPA), then this General Certification is not valid until a Finding of No Significant Impact (FONSI) or Record of Decision (ROD) is issued by the State Clearinghouse. If an environmental document is required under the National Environmental Policy Act (NEPA), then this General Certification is not valid until a Categorical Exclusion, the Final Environmental Assessment, or Final Environmental Impact Statement is published by the lead agency. [15A NCAC 01C .0107(a)]
24. This General Certification does not relieve the applicant of the responsibility to obtain all other required Federal, State, or Local approvals before proceeding with the project, including those required by, but not limited to, Sediment and Erosion Control, Non-Discharge, Water Supply Watershed, and Trout Buffer regulations.
25. The applicant and their authorized agents shall conduct all activities in a manner consistent with State water quality standards (including any requirements resulting from compliance with §303(d) of the Clean Water Act), and any other appropriate requirements of State and Federal Law. If DWR determines that such standards or laws are not being met, including failure to sustain a designated or achieved use, or that State or Federal law is being violated, or that further conditions are necessary to assure compliance, then DWR may revoke or modify a written authorization associated with this General Water Quality Certification. [15A NCAC 02H .0507(d)]
26. When written authorization is required for use of this Certification, upon completion of all permitted impacts included within the approval and any subsequent modifications, the applicant shall be required to return a certificate of completion (available on the DWR website: <https://edocs.deq.nc.gov/Forms/Certificate-of-Completion>). [15A NCAC 02H .0502(f)]
27. Additional site-specific conditions, including monitoring and/or modeling requirements, may be added to the written approval letter for projects proposed under this Water Quality Certification in order to ensure compliance with all applicable water quality and effluent standards. [15A NCAC 02H .0507(c)]
28. If the property or project is sold or transferred, the new Permittee shall be given a copy of this Certification (and written authorization if applicable) and is responsible for complying with all conditions. [15A NCAC 02H .0501 and .0502]

III. GENERAL CERTIFICATION ADMINISTRATION:

1. In accordance with North Carolina General Statute 143-215.3D(e), written approval for a 401 Water Quality General Certification must include the appropriate fee. An applicant for a CAMA permit under Article 7 of Chapter 113A of the General Statutes for which a Water Quality Certification is required shall only make one payment to satisfy both agencies; the fee shall be as established by the Secretary in accordance with 143-215.3D(e)(7).

P-46
GC4086

2. This Certification neither grants nor affirms any property right, license, or privilege in any waters, or any right of use in any waters. This Certification does not authorize any person to interfere with the riparian rights, littoral rights, or water use rights of any other person and this Certification does not create any prescriptive right or any right of priority regarding any usage of water. This Certification shall not be interposed as a defense in any action respecting the determination of riparian or littoral rights or other rights to water use. No consumptive user is deemed by virtue of this Certification to possess any prescriptive or other right of priority with respect to any other consumptive user regardless of the quantity of the withdrawal or the date on which the withdrawal was initiated or expanded.
3. This Certification grants permission to the Director, an authorized representative of the Director, or DWR staff, upon the presentation of proper credentials, to enter the property during normal business hours. [15A NCAC 02H .0502(e)]
4. This General Certification shall expire on the same day as the expiration date of the corresponding Nationwide Permit and/or Regional General Permit. The conditions in effect on the date of issuance of Certification for a specific project shall remain in effect for the life of the project, regardless of the expiration date of this Certification. This General Certification is rescinded when the US Army Corps of Engineers reauthorizes any of the corresponding Nationwide Permits and/or Regional General Permits or when deemed appropriate by the Director of the Division of Water Resources.
5. Non-compliance with or violation of the conditions herein set forth by a specific project may result in revocation of this General Certification for the project and may also result in criminal and/or civil penalties.
6. The Director of the North Carolina Division of Water Resources may require submission of a formal application for Individual Certification for any project in this category of activity if it is determined that the project is likely to have a significant adverse effect upon water quality, including state or federally listed endangered or threatened aquatic species, or degrade the waters so that existing uses of the water or downstream waters are precluded.
7. Public hearings may be held prior to a Certification decision if deemed in the public's best interest by the Director of the North Carolina Division of Water Resources.

History Note: Water Quality Certification (WQC) Number 4806 issued March 3, 2017 replaces WQC 3884 issued March 19, 2012; WQC Number 3819 issued March 19, 2010; WQC Number 3699 issued November 1, 2007; WQC Number 3625 issued March 19, 2007; WQC Number 3374 issued March 18, 2002; WQC Number 3288 issued June 1, 2000; WQC Number 3101 issued February 11, 1997; WQC Number 3022 issued September 6, 1995, WQC Number 2664 issued January 21, 1992.

ANTI-SEEP COLLAR

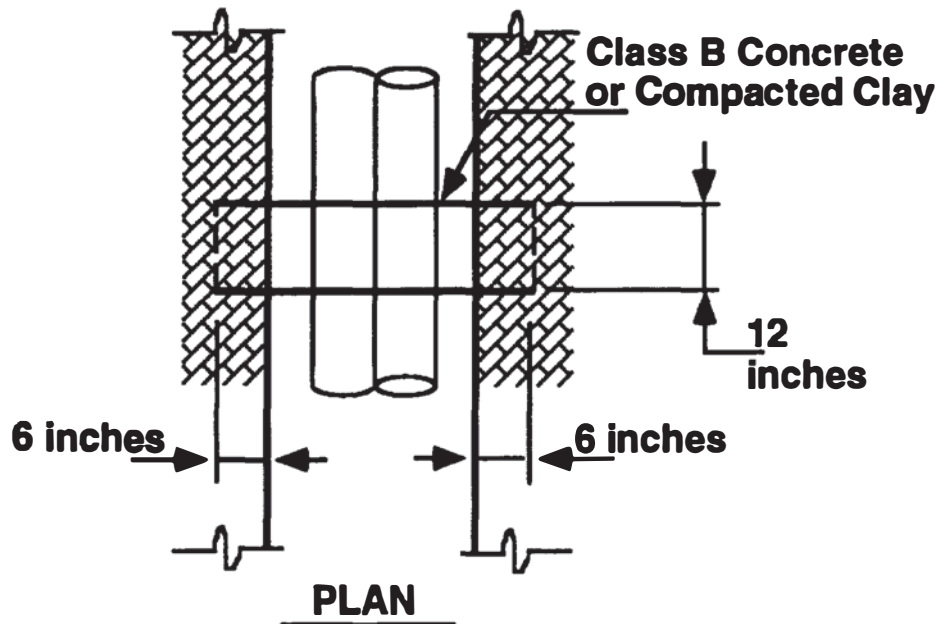
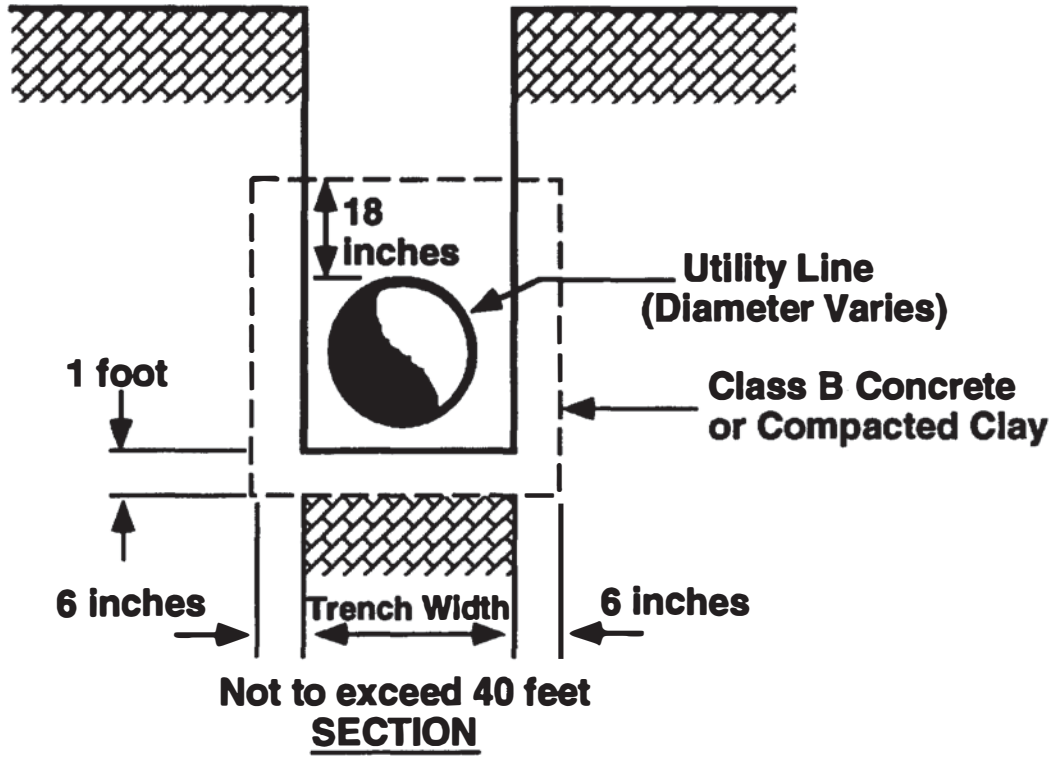

PROJECT REFERENCE NO.	B-5562	SHEET NO.	4
ROADWAY DESIGN ENGINEER	RW SHEET NO.	HYDRAULICS ENGINEER	

DOCUMENT NOT CONSIDERED FINAL UNLESS ALL SIGNATURES COMPLETED

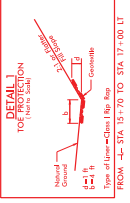

MAD 83/NA 2011

SITE 1

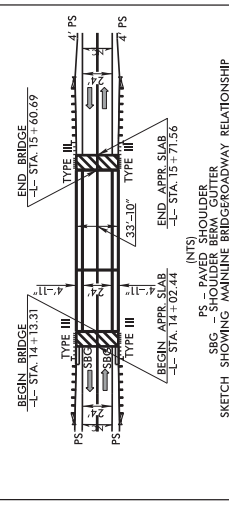

(NTS)
PS = PAVED SHOULDER
SRC = SHOULDER CURB
SKETCH SHOWING MAINLINE BRIDGE/ROADWAY RELATIONSHIP

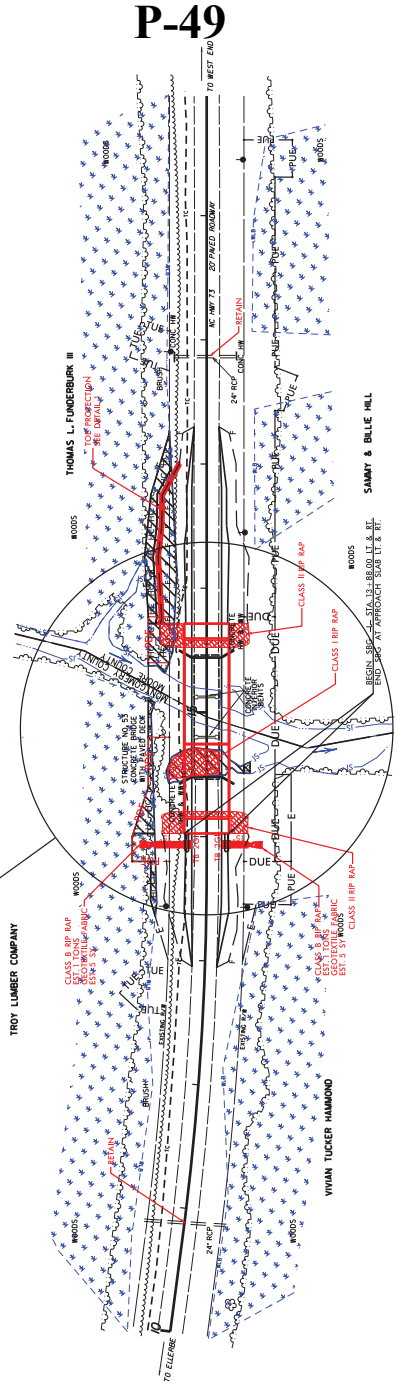

- MECHANIZED CLEARING
- HAND CLEARING
- FILL IN WETLANDS
- SURFACE WATER IMPACTS
- TEMPORARY SURFACE WATER IMPACTS

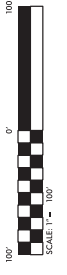

PERMIT DRAWING
SHEET 2 OF 7

SEE SHEET 5 FOR -L- PROFILE
SEE SHEET 5-1 THRU 5-3 FOR STRUCTURE PLANS

PROJECT REFERENCE NO.	B-5562	SHEET NO.	4
ROADWAY DESIGN ENGINEER		HYDRAULICS ENGINEER	

DOCUMENT NOT CONSIDERED FINAL
UNLESS ALL SIGNATURES COMPLETED

P-50

PERMIT DRAWING
SHEET 3 OF 7

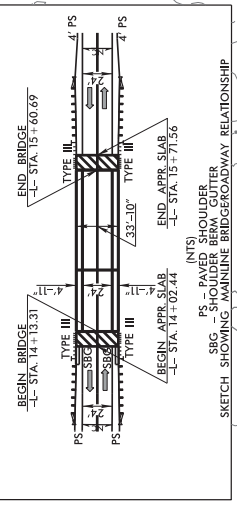

SITE 1

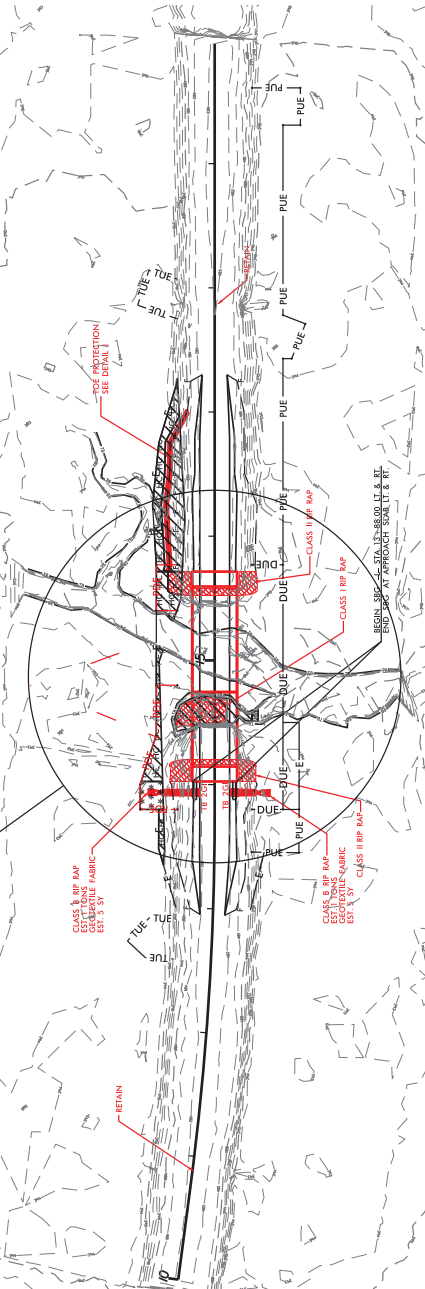

- HC HC HAND CLEARING
- ***** MECHANIZED CLEARING
- F F FILL IN WETLANDS
- S S SURFACE WATER IMPACTS
- TS TS TEMPORARY SURFACE WATER IMPACTS

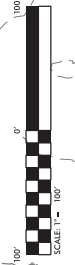

SEE SHEET 5 FOR L- PROFILE
SEE SHEET 5-1 THRU 5-3 FOR STRUCTURE PLANS

B/17/99

REVISIONS

15/06/2017
K:\Projects\15062017\15062017\Environment\Drawings\15062017\15062017.mxd
15062017.dwg
15062017.dwg
15062017.dwg

PROJECT REFERENCE NO.	SHEET NO.
RAW SHEET NO.	04
ROADWAY DESIGN ENGINEER	HYDRAULICS ENGINEER
INCOMPLETE PLANS DO NOT USE FOR ACQUISITION	
DOCUMENT NOT CONSIDERED FINAL UNLESS ALL SIGNATURES COMPLETED	

SITE 1 ENLARGEMENT

P-51

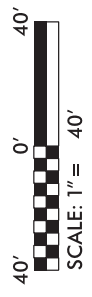
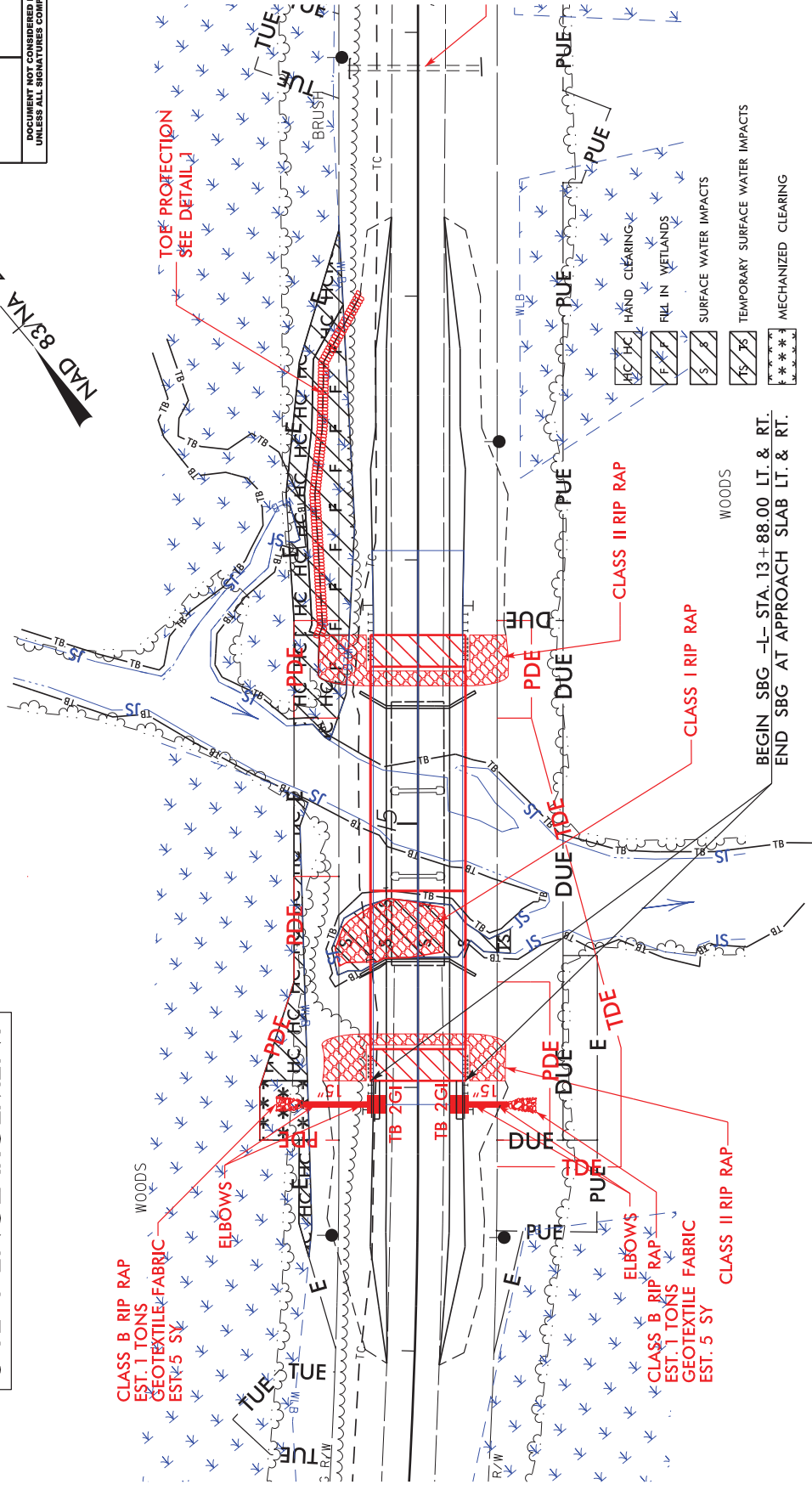
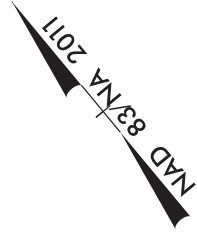

PERMIT DRAWING
SHEET 4 OF 7

B/17/99

REVISIONS

17/02/07
 P:\Hydraulics\Permitts_Environmental\Drawings\B3562_Trd_gm_mwl_perldtd.dgn
 17/02/07 11:53:53 AM

PERMIT DRAWING
 SHEET 5 OF 7

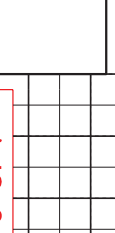

BRIDGE HYDRAULIC DATA

DESIGN DISCHARGE = 1200 CFS
 DESIGN VELOCITY = 3.00 FT/S
 DESIGN HW ELEVATION = 356.40 FT
 BASE DISCHARGE = 1200 CFS
 BASE FREQ. = 180 YRS
 BASE HW ELEVATION = 356.51 FT
 OVERTOPPING DISCHARGE = 16000 CFS
 OVERTOPPING FREQ. = 500 YRS
 OVERTOPPING ELEVATION = 402.17 FT

DATE OF SURVEY = 8/29/18
 W.S. ELEVATION AT DATE OF SURVEY = 391.2 FT

OVERTOPPING ELEVATION EQUALS NORMAL CROWN AT SAG LOCATION STATION 14+00.00 -L-

PI = 13+25.00 EL = 403.30' VC = 60' K = 132 IDS > 55 MPH
 PI = 16+05.00 EL = 403.20' VC = 76' K = 114 IDS > 55 MPH
 PI = 17+00.00 EL = 402.87' VC = 60' K = 125 IDS > 55 MPH
 END GRADE -L- STA 17+30.00 EL = 402.55'

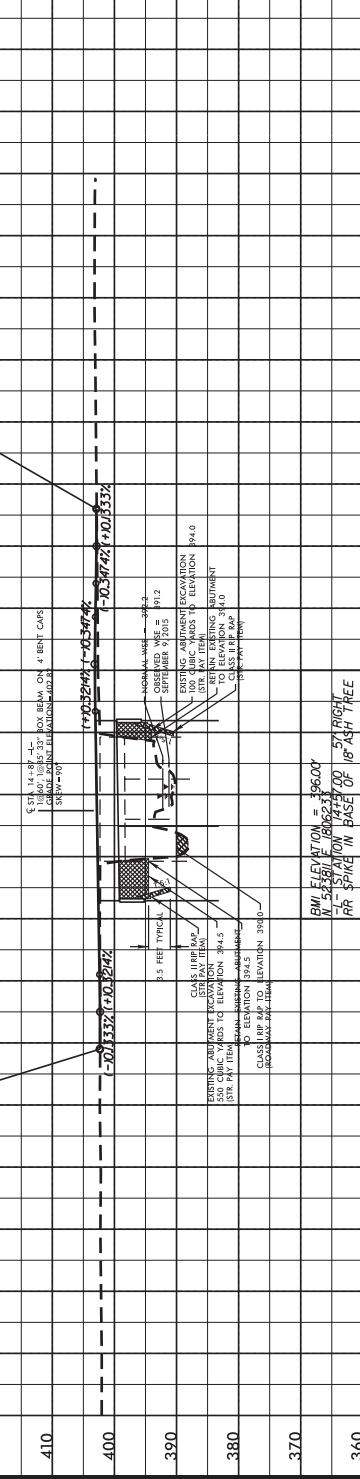

BMI ELEVATION = 396.00
 N. SIDE OF BRIDGE
 57' RIGHT
 18" ASH TREE
 IN BASE OF TREE

**BRIDGE PROFILE
 SITE 1**

P-52

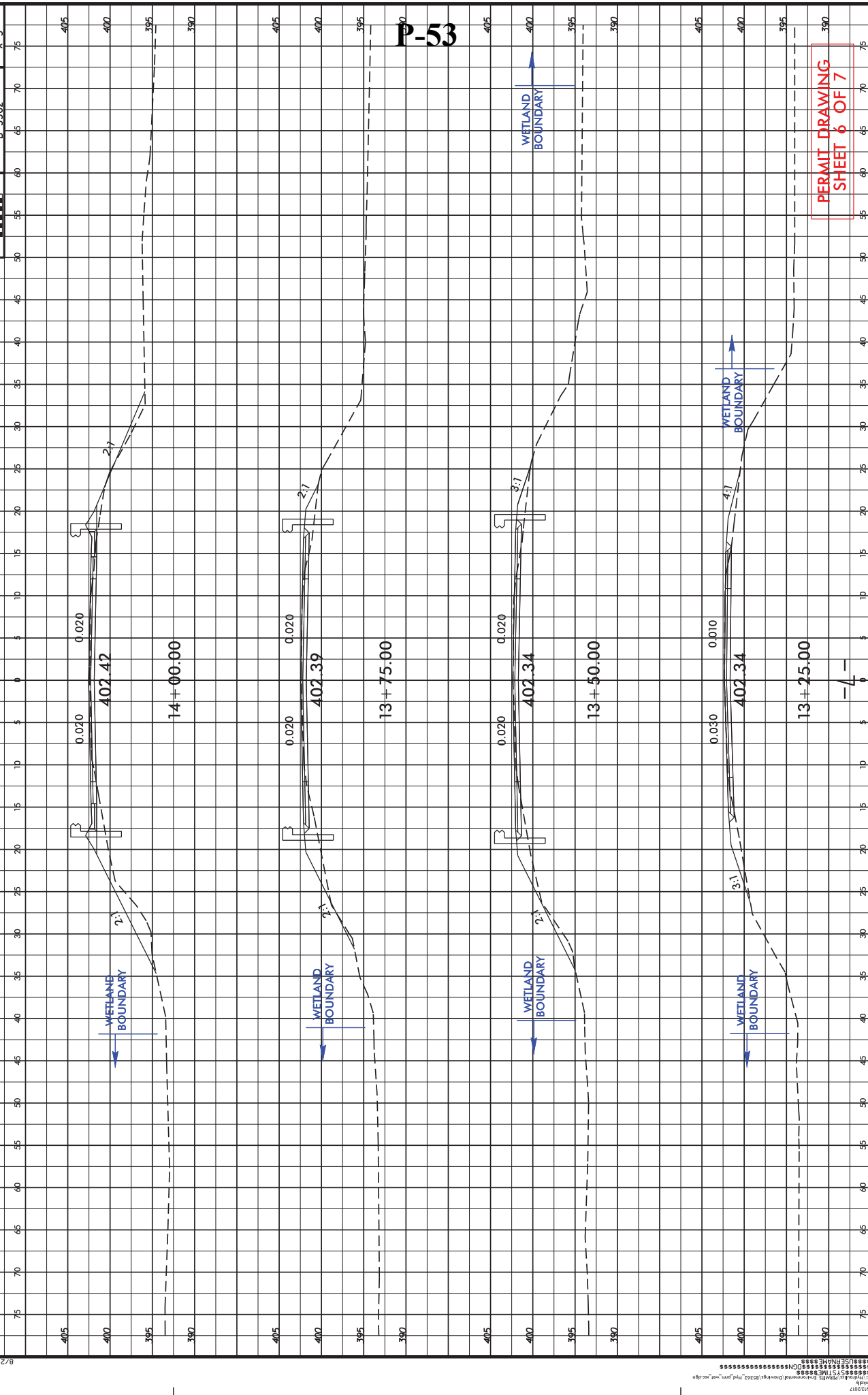

P-53

PERMIT DRAWING
SHEET 6 OF 7

STATE OF NORTH CAROLINA
DIVISION OF HIGHWAYS

**UTILITY PERMIT DRAWINGS
MONTGOMERY / MOORE COUNTIES**

LOCATION: BRIDGE NO. 53 OVER DROWNING CREEK ON NC 73

WETLAND IMPACTS

T.I.P. NO.
B-5362

SHEET NO.
UE-1

PERMIT DRAWING
SHEET 1 OF 3
UTILITIES



P-55

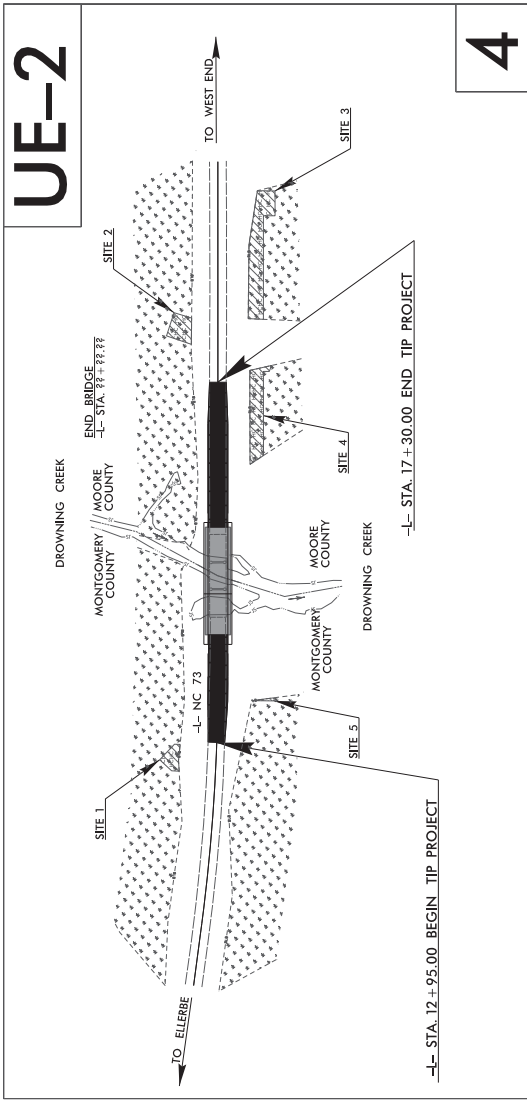
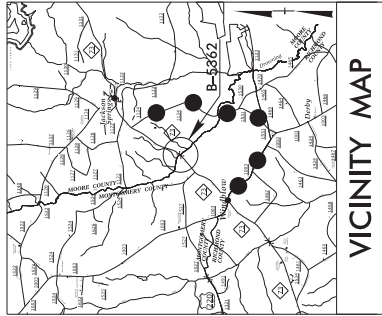

TIP PROJECT: B-5362

PREPARED IN THE OFFICE OF:
W. E. FERTILL
ENGINEERS
 1223 Jones Franklin Road
 Raleigh, N.C. 27605
 Phone: 919 851 8077
 Fax: 919 851 8107

**TRANSPORTATION PLANNING/DESIGN - BRIDGE/STRUCTURE DESIGN
 CIVIL/SITE DESIGN - GS/GPS - CONSTRUCTION OBSERVATION**

John D. Schirmer, PLS PROJECT UTILITY COORDINATOR

**DIVISION OF HIGHWAYS
 UTILITIES UNIT
 601 EAST 7TH STREET
 RALEIGH, NC 27602-1555
 PHONE: 919/797-2547
 FAX: 919/797-2544/43**

**UTILITIES REGIONAL ENGINEER
 UTILITIES PROJECT ENGINEER
 UTILITIES AREA COORDINATOR
 UTILITIES COORDINATOR**

**Danna Jackson
 Don Proyer
 Ed Reams
 Tange Sampson**

UTILITY OWNERS WITH CONFLICTS

(A) TELEPHONE - BROADPLEX
 (B) POWER DISTRIBUTION - DUKE ENERGY
 (C) POWER DISTRIBUTION - PEE DEE EMC

INDEX OF SHEETS

SHEET NO.	DESCRIPTION:
UE-1	TITLE SHEET
UE-2	UBO PLAN SHEETS

GRAPHIC SCALES

50 25 0 50 100
 PLANS

50 25 0 50 100
 PROFILE (HORIZONTAL)

10 5 0 10 20
 PROFILE (VERTICAL)

UTILITY WETLAND IMPACTS

PERMIT DRAWING
SHEET 2 OF 3
UTILITIES



MAD 83/NA 2011

P-56

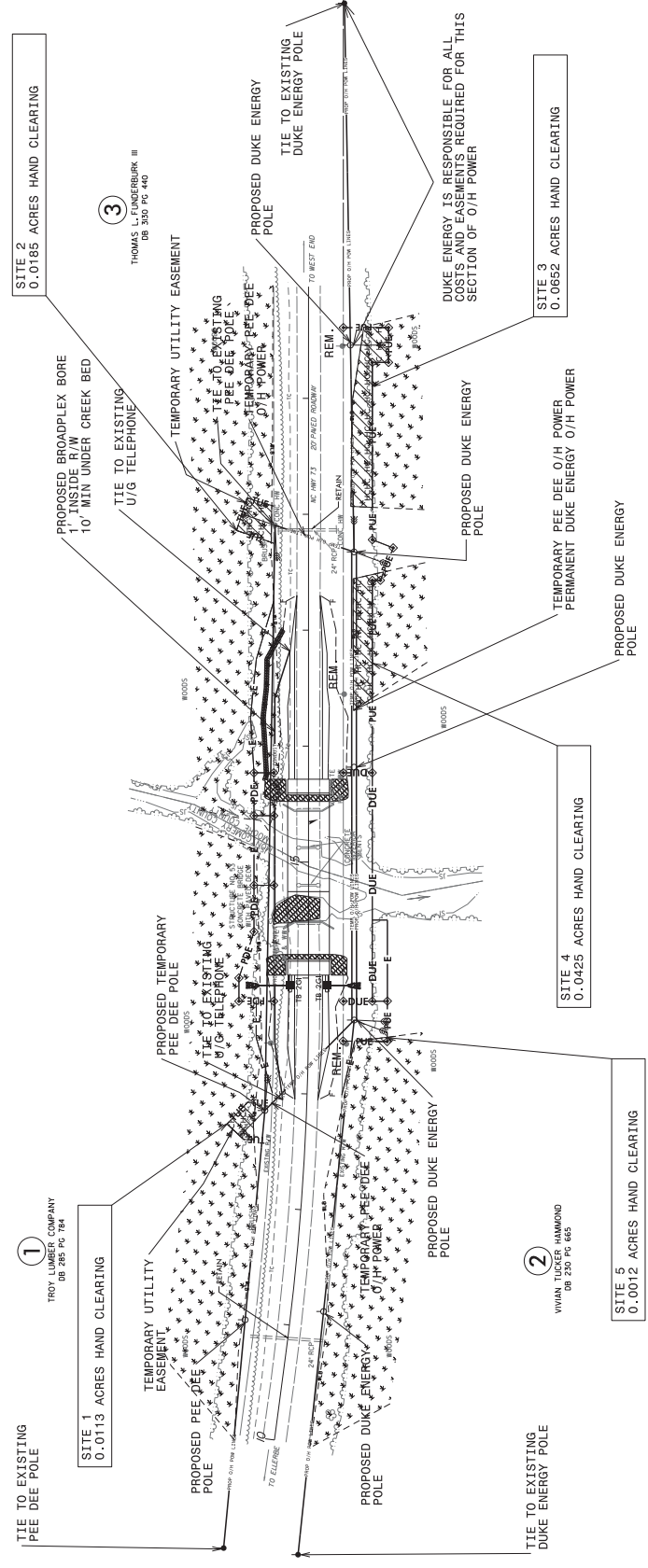

SAWYER & DALE HILL
DB 250 PG 615
④

DUKE ENERGY IS RESPONSIBLE FOR ALL COSTS AND EASEMENTS REQUIRED FOR THIS SECTION OF O/H POWER

SITE 2
0.0185 ACRES HAND CLEARING

SITE 3
0.0652 ACRES HAND CLEARING

①
TROY LUMBER COMPANY
DB 285 PG 784

SITE 1
0.0113 ACRES HAND CLEARING

②
VIVIAN TUCKER HAMMOND
DB 250 PG 605

SITE 5
0.0012 ACRES HAND CLEARING

SITE 4
0.0425 ACRES HAND CLEARING

③
THOMAS L. WEAVER
DB 330 PG 440

PROPOSED BROADPLEX BORE
W/ 10' MIN UNDER CREEK BED

TIE TO EXISTING
U/G TELEPHONE

TEMPORARY UTILITY EASEMENT

TIE TO EXISTING
PEE DEE POLE
TEMPORARY PEE DEE
O/H POWER

PROPOSED DUKÉ ENERGY
POLE
TIE TO EXISTING
DUKE ENERGY POLE

PROPOSED DUKÉ ENERGY
POLE

TEMPORARY PEE DEE O/H POWER
PERMANENT DUKÉ ENERGY O/H POWER

PROPOSED DUKÉ ENERGY
POLE

PROPOSED TEMPORARY
PEE DEE POLE
TIE TO EXISTING
U/G TELEPHONE

TIE TO EXISTING
PEE DEE POLE

PROPOSED DUKÉ ENERGY
POLE

PROPOSED DUKÉ ENERGY
POLE

TEMPORARY PEE DEE
O/H POWER

TIE TO EXISTING
DUKE ENERGY POLE

County : Montgomery, Moore

Line #	Item Number	Sec #	Description	Quantity	Unit Cost	Amount
ROADWAY ITEMS						
0001	0000100000-N	800	MOBILIZATION	Lump Sum	L.S.	
0002	0029000000-N	SP	REINFORCED BRIDGE APPROACH FILL, STATION ***** (14+87.00)	Lump Sum	L.S.	
0003	0043000000-N	226	GRADING	Lump Sum	L.S.	
0004	0050000000-E	226	SUPPLEMENTARY CLEARING & GRUB- BING	1 ACR		
0005	0057000000-E	226	UNDERCUT EXCAVATION	200 CY		
0006	0195000000-E	265	SELECT GRANULAR MATERIAL	200 CY		
0007	0196000000-E	270	GEOTEXTILE FOR SOIL STABILIZA- TION	200 SY		
0008	0318000000-E	300	FOUNDATION CONDITIONING MATE- RIAL, MINOR STRUCTURES	10 TON		
0009	0320000000-E	300	FOUNDATION CONDITIONING GEO- TEXTILE	20 SY		
0010	0335200000-E	305	15" DRAINAGE PIPE	48 LF		
0011	0335850000-E	305	*** DRAINAGE PIPE ELBOWS (15")	4 EA		
0012	1489000000-E	610	ASPHALT CONC BASE COURSE, TYPE B25.0B	240 TON		
0013	1519000000-E	610	ASPHALT CONC SURFACE COURSE, TYPE S9.5B	160 TON		
0014	1575000000-E	620	ASPHALT BINDER FOR PLANT MIX	25 TON		
0015	2286000000-N	840	MASONRY DRAINAGE STRUCTURES	2 EA		
0016	2367000000-N	840	FRAME WITH TWO GRATES, STD 840.29	2 EA		
0017	2556000000-E	846	SHOULDER BERM GUTTER	35 LF		
0018	3030000000-E	862	STEEL BM GUARDRAIL	50 LF		

County : Montgomery, Moore

Line #	Item Number	Sec #	Description	Quantity	Unit Cost	Amount
0019	3150000000-N	862	ADDITIONAL GUARDRAIL POSTS	5	EA	
0020	3287000000-N	SP	GUARDRAIL END UNITS, TYPE TL-3	4	EA	
0021	3317000000-N	862	GUARDRAIL ANCHOR UNITS, TYPE B-77	4	EA	
0022	3628000000-E	876	RIP RAP, CLASS I	60	TON	
0023	3649000000-E	876	RIP RAP, CLASS B	2	TON	
0024	3656000000-E	876	GEOTEXTILE FOR DRAINAGE	685	SY	
0025	4025000000-E	901	CONTRACTOR FURNISHED, TYPE *** SIGN (D)	96.6	SF	
0026	4072000000-E	903	SUPPORTS, 3-LB STEEL U-CHANNEL	181	LF	
0027	4096000000-N	904	SIGN ERECTION, TYPE D	6	EA	
0028	4116100000-N	904	SIGN ERECTION, RELOCATE, TYPE **** (GROUND MOUNTED) (E)	1	EA	
0029	4155000000-N	907	DISPOSAL OF SIGN SYSTEM, U- CHANNEL	8	EA	
0030	4192000000-N	907	DISPOSAL OF SUPPORT, U-CHANNEL	1	EA	
0031	4400000000-E	1110	WORK ZONE SIGNS (STATIONARY)	976	SF	
0032	4410000000-E	1110	WORK ZONE SIGNS (BARRICADE MOUNTED)	194	SF	
0033	4420000000-N	1120	PORTABLE CHANGEABLE MESSAGE SIGN	3	EA	
0034	4430000000-N	1130	DRUMS	15	EA	
0035	4445000000-E	1145	BARRICADES (TYPE III)	144	LF	
0036	4685000000-E	1205	THERMOPLASTIC PAVEMENT MARKING LINES (4", 90 MILS)	870	LF	

County : Montgomery, Moore

Line #	Item Number	Sec #	Description	Quantity	Unit Cost	Amount
0037	4686000000-E	1205	THERMOPLASTIC PAVEMENT MARKING LINES (4", 120 MILS)	870	LF	
0038	4900000000-N	1251	PERMANENT RAISED PAVEMENT MARKERS	6	EA	
0039	6000000000-E	1605	TEMPORARY SILT FENCE	1,500	LF	
0040	6006000000-E	1610	STONE FOR EROSION CONTROL, CLASS A	150	TON	
0041	6009000000-E	1610	STONE FOR EROSION CONTROL, CLASS B	5	TON	
0042	6012000000-E	1610	SEDIMENT CONTROL STONE	105	TON	
0043	6015000000-E	1615	TEMPORARY MULCHING	0.4	ACR	
0044	6018000000-E	1620	SEED FOR TEMPORARY SEEDING	100	LB	
0045	6021000000-E	1620	FERTILIZER FOR TEMPORARY SEEDING	0.5	TON	
0046	6024000000-E	1622	TEMPORARY SLOPE DRAINS	200	LF	
0047	6029000000-E	SP	SAFETY FENCE	600	LF	
0048	6030000000-E	1630	SILT EXCAVATION	10	CY	
0049	6036000000-E	1631	MATTING FOR EROSION CONTROL	1,000	SY	
0050	6037000000-E	SP	COIR FIBER MAT	250	SY	
0051	6042000000-E	1632	1/4" HARDWARE CLOTH	285	LF	
0052	6048000000-E	SP	FLOATING TURBIDITY CURTAIN	15	SY	
0053	6070000000-N	1639	SPECIAL STILLING BASINS	2	EA	
0054	6084000000-E	1660	SEEDING & MULCHING	0.4	ACR	
0055	6087000000-E	1660	MOWING	0.2	ACR	

County : Montgomery, Moore

Line #	Item Number	Sec #	Description	Quantity	Unit Cost	Amount
0056	6090000000-E	1661	SEED FOR REPAIR SEEDING	50 LB		
0057	6093000000-E	1661	FERTILIZER FOR REPAIR SEEDING	0.25 TON		
0058	6096000000-E	1662	SEED FOR SUPPLEMENTAL SEEDING	50 LB		
0059	6108000000-E	1665	FERTILIZER TOPDRESSING	0.25 TON		
0060	6111000000-E	SP	IMPERVIOUS DIKE	25 LF		
0061	6114500000-N	1667	SPECIALIZED HAND MOWING	10 MHR		
0062	6117000000-N	SP	RESPONSE FOR EROSION CONTROL	15 EA		
0063	6132000000-N	SP	GENERIC EROSION CONTROL ITEM CONCRETE WASHOUT STRUCTURE	2 EA		

STRUCTURE ITEMS

0064	8035000000-N	402	REMOVAL OF EXISTING STRUCTURE AT STATION ***** (14+87.00 -L-)	Lump Sum	L.S.	
0065	8121000000-N	412	UNCLASSIFIED STRUCTURE EXCAVA- TION AT STATION ***** (14+87.00 -L-)	Lump Sum	L.S.	
0066	8156000000-E	SP	CONCRETE WEARING SURFACE	4,765 SF		
0067	8161000000-E	420	GROOVING BRIDGE FLOORS	5,144 SF		
0068	8182000000-E	420	CLASS A CONCRETE (BRIDGE)	67.5 CY		
0069	8210000000-N	422	BRIDGE APPROACH SLABS, STATION ***** (14+87.00 -L-)	Lump Sum	L.S.	
0070	8217000000-E	425	REINFORCING STEEL (BRIDGE)	10,458 LB		
0071	8328200000-E	SP	PILE DRIVING EQUIPMENT SETUP FOR *** STEEL PILES (HP 12 X 53)	14 EA		

County : Montgomery, Moore

Line #	Item Number	Sec #	Description	Quantity	Unit Cost	Amount
0072	8328400000-E	SP	PILE DRIVING EQUIPMENT SETUP FOR *** GALVANIZED STEEL PILES (HP 14 X 73)	8	EA	
0073	8364000000-E	450	HP12X53 STEEL PILES	245	LF	
0074	8384200000-E	450	HP14X73 GALVANIZED STEEL PILES	240	LF	
0075	8503000000-E	460	CONCRETE BARRIER RAIL	290	LF	
0076	8590000000-E	876	RIP RAP, CLASS ** (I)	90	TON	
0077	8608000000-E	876	RIP RAP CLASS II (2'-0" THICK)	180	TON	
0078	8622000000-E	876	GEOTEXTILE FOR DRAINAGE	305	SY	
0079	8657000000-N	430	ELASTOMERIC BEARINGS	Lump Sum	L.S.	
0080	8753100000-E	430	3'-0" X 2'-9" PRESTRESSED CONC BOX BEAMS	1,740	LF	
0081	8860000000-N	SP	GENERIC STRUCTURE ITEM ASBESTOS ASSESSMENT	Lump Sum	L.S.	

1530/Oct02/Q33259.1/D400929650000/E81

Total Amount Of Bid For Entire Project :