

DocuSigned by:  
George Karageorge  
SEAL 042065  
ENGINEER  
GEORGE M. KARAGEORGE  
7/12/2017

**Michael Baker**  
INTERNATIONAL

DOCUMENT NOT CONSIDERED FINAL  
UNLESS ALL SIGNATURES COMPLETED

401 QUANTITY: 24

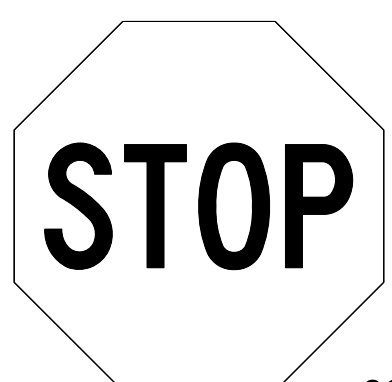

R1-1  
36" X 36"

ONE "U" POST PER SIGN

402 QUANTITY: 2

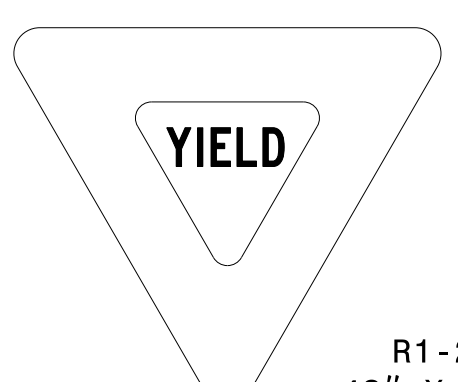

R1-2  
48" X 48"

TWO "U" POSTS PER SIGN

403 QUANTITY: 17

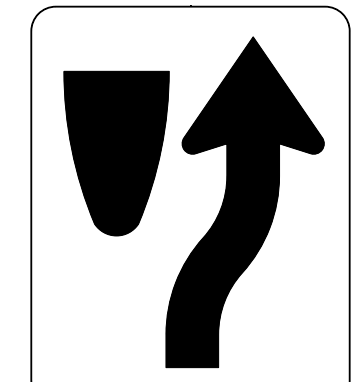

R4-7  
24" X 30"

ONE "U" POST PER SIGN

404 QUANTITY: 17

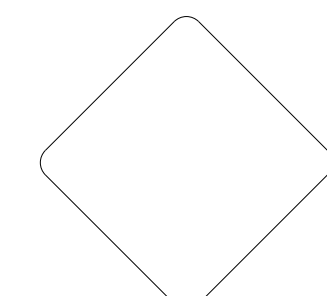

OM1-3  
18" X 18"

MOUNT BELOW SIGN 403  
IN 17 INSTALLATIONS

405 QUANTITY: 7



R2-1  
30" X 36"

ONE "U" POST PER SIGN

406 QUANTITY: 1



R2-1  
30" X 36"

ONE "U" POST PER SIGN

407 QUANTITY: 5



R6-1L  
54" X 18"

TWO "U" POSTS PER SIGN

408 QUANTITY: 21



R6-1R  
36" X 12"

MOUNT ABOVE SIGN 401  
IN 21 INSTALLATIONS

409 QUANTITY: 2



R6-1L  
36" X 12"

MOUNT ABOVE SIGN 401  
IN 2 INSTALLATIONS

410 QUANTITY: 17



R6-1R  
54" X 18"

TWO "U" POSTS PER SIGN

411 QUANTITY: 2

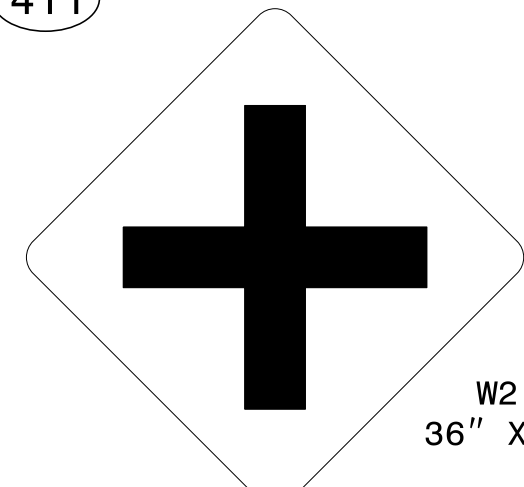

W2-1  
36" X 36"

ONE "U" POST PER SIGN

412 QUANTITY: 2

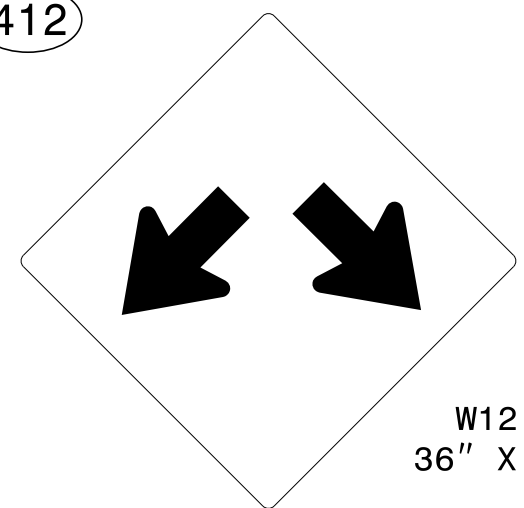

W12-1  
36" X 36"

ONE "U" POST PER SIGN

413 QUANTITY: 2

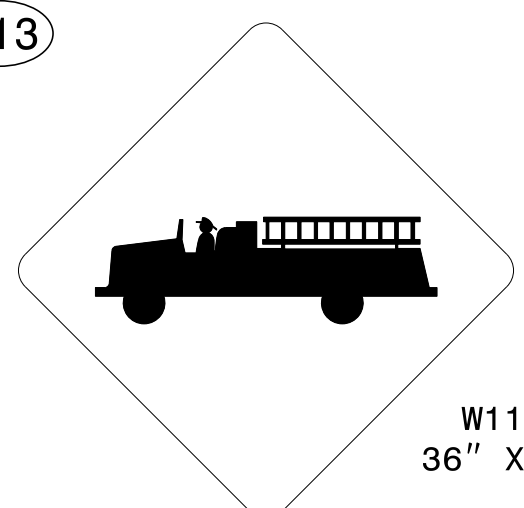

W11-8  
36" X 36"

ONE "U" POST PER SIGN

414 QUANTITY: 2



W11-12P  
36" X 30"

MOUNT BELOW SIGN 413  
IN 2 INSTALLATIONS

415 QUANTITY: 2



R5-1  
36" X 36"

ONE "U" POST PER SIGN

416 QUANTITY: 1

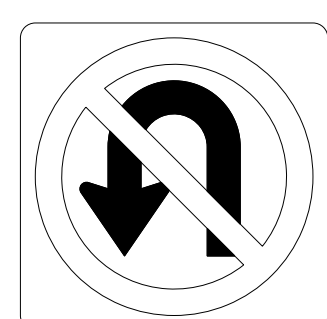

R3-4  
24" X 24"

MOUNT BELOW SIGN 415  
IN 1 INSTALLATION

417 QUANTITY: 1

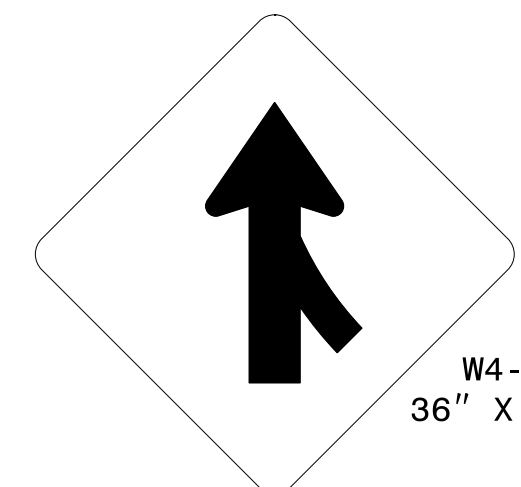

W4-1  
36" X 36"

ONE "U" POST PER SIGN

418 QUANTITY: 2



S1-1  
36" X 36"

ONE "U" POST PER SIGN

419 QUANTITY: 1



W16-9P  
24" X 12"

MOUNT BELOW SIGN 418  
IN 1 INSTALLATION

420 QUANTITY: 1

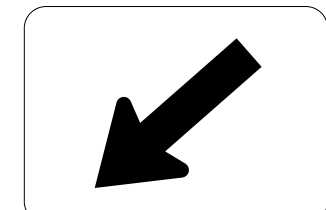

W16-7P  
24" X 12"

MOUNT BELOW SIGN 418  
IN 1 INSTALLATION

421 QUANTITY: 1



R5-2a  
18" X 24"

ONE "U" POST PER SIGN

**TYPE 'E' SIGNS**