

**This electronic collection of documents is provided
for the convenience of the user
and is Not a Certified Document –**

**The documents contained herein were originally issued
and sealed by the individuals whose names and license
numbers appear on each page, on the dates appearing
with their signature on that page.**

**This file or an individual page
shall not be considered a certified document.**

STATE OF NORTH CAROLINA DIVISION OF HIGHWAYS

Approximate quantities only. Unclassified excavation, borrow excavation, shoulder borrow, fine grading, clearing and grubbing and removal of existing pavement will be paid for at the lump sum price for "Grading".

NOTE: EMBANKMENT COLUMN DOES NOT INCLUDE BACKFILL FOR UNDERCUT

CROSS-SECTION SUMMARY

Station -DETEB- (Based off of -L-)	Uncl. Exc. (cu. yd.)	Embt (cu. yd.)
12+50.00	9	0
13+00.00	23	0
13+50.00	24	0
14+00.00	22	0
14+50.00	25	0
15+00.00	28	0
15+50.00	32	0
16+00.00	36	0
16+50.00	35	206
17+00.00	32	789
17+50.00	31	1013
18+00.00	33	531
18+50.00	80	101
19+00.00	453	0
19+50.00	763	0
20+00.00	840	1
20+50.00	972	3
21+00.00	1010	3
21+50.00	976	1
22+00.00	884	0
22+50.00	414	23
23+00.00	0	587
23+50.00	0	1702
24+00.00	0	2540
24+50.00	0	2942
25+00.00	0	3168

Station -DETEB- (Based off of -L-)	Uncl. Exc. (cu. yd.)	Embt (cu. yd.)
27+00.00	0	0
27+50.00	284	39
28+00.00	790	0
28+50.00	1096	0
29+00.00	1264	0
29+50.00	1381	0
30+00.00	1357	0
30+50.00	1159	0
31+00.00	850	0
31+50.00	559	1
32+00.00	338	21
32+50.00	119	94
33+00.00	0	144
33+50.00	0	122
34+00.00	3	83
34+50.00	12	43
35+00.00	19	15
35+50.00	62	3
36+00.00	133	2
36+50.00	99	2
37+00.00	33	0
37+50.00	30	0
38+00.00	27	0
38+50.00	24	0
39+00.00	21	0
39+50.00	19	0
40+00.00	19	0
40+50.00	9	0

Station -DE IWB- (Based off of -L-)	Uncl. Exc. (cu. yd.)	Embt (cu. yd.)
11+50.00	0	0
12+00.00	24	0
12+50.00	24	0
13+00.00	23	0
13+50.00	22	0
14+00.00	22	0
14+50.00	24	0
15+00.00	29	0
15+50.00	37	0
16+00.00	46	1
16+50.00	58	2
17+00.00	56	1
17+50.00	41	0
18+00.00	31	0
18+50.00	24	0
19+00.00	21	0
19+50.00	21	0
20+00.00	22	0
20+50.00	21	0
21+00.00	19	0
21+50.00	18	0
22+00.00	8	0

Station -DE IWB- (Based off of -L-)	Uncl. Exc. (cu. yd.)	Embt (cu. yd.)
30+50.00	8	0
31+00.00	18	0
31+50.00	19	0
32+00.00	21	0
32+50.00	24	0
33+00.00	28	0
33+50.00	31	0
34+00.00	32	0
34+50.00	36	0
35+00.00	44	0
35+50.00	50	0
36+00.00	55	0
36+50.00	55	0
37+00.00	45	0
37+50.00	34	0
38+00.00	29	0
38+50.00	26	0
39+00.00	24	0
39+50.00	24	0
40+00.00	23	0
40+50.00	22	0
41+00.00	21	0
41+50.00	21	0

Station -LWBL-	Uncl. Exc. (cu. yd.)	Embt (cu. yd.)
15+50.00	0	0
16+00.00	103	1
16+50.00	87	15
17+00.00	73	29
17+50.00	65	29
18+00.00	58	25
18+50.00	56	46
19+00.00	44	53
19+50.00	78	33
20+00.00	144	35
20+50.00	202	47
21+00.00	239	65
21+50.00	214	81
22+00.00	161	96
22+50.00	95	109
23+00.00	28	226
23+50.00	0	431
24+00.00	0	700
24+50.00	0	1131
25+00.00	0	1305

Station -LWBL-	Uncl. Exc. (cu. yd.)	Embt (cu. yd.)
26+50.00	0	0
27+00.00	69	143
27+50.00	143	29
28+00.00	131	31
28+50.00	111	28
29+00.00	94	23
29+50.00	64	23
30+00.00	40	25
30+50.00	34	26
31+00.00	45	22
31+50.00	46	19
32+00.00	40	19
32+50.00	40	22
33+00.00	45	19
33+50.00	79	12
34+00.00	114	11
34+50.00	132	14
35+00.00	156	15
35+50.00	130	27
36+00.00	93	32
36+50.00	69	41

Station -LEBL-	Uncl. Exc. (cu. yd.)	Embt (cu. yd.)
15+50.00	0	0
16+00.00	82	85
16+50.00	63	56
17+00.00	49	16
17+50.00	40	33
18+00.00	37	43
18+50.00	33	48
19+00.00	28	51
19+50.00	22	49
20+00.00	18	50
20+50.00	15	59
21+00.00	13	76
21+50.00	6	94
22+00.00	3	99
22+50.00	5	104
23+00.00	3	123
23+50.00	1	143
24+00.00	0	148
24+50.00	0	146
25+00.00	0	135

Station -LEBL-	Uncl. Exc. (cu. yd.)	Embt (cu. yd.)
26+50.00	0	0
27+00.00	5	419
27+50.00	17	35
28+00.00	21	34
28+50.00	19	29
29+00.00	22	20
29+50.00	23	15
30+00.00	23	11
30+50.00	25	16
31+00.00	29	24
31+50.00	37	30
32+00.00	52	32
32+50.00	67	32
33+00.00	74	33
33+50.00	75	34
34+00.00	70	35
34+50.00	64	31
35+00.00	66	19
35+50.00	68	7
36+00.00	64	3
36+50.00	42	40

Station -DETEB- (Based off of -L-)	Uncl. Exc. (cu. yd.)	Embt (cu. yd.)
16+50.00	34	0
17+00.00	165	0
17+50.00	301	0
18+00.00	221	0
18+50.00	60	4
19+00.00	16	106
19+50.00	11	132
20+00.00	11	88
20+50.00	18	138
21+00.00	28	182
21+50.00	39	187
22+00.00	60	244
22+50.00	106	159
23+00.00	496	0
23+50.00	1190	0
24+00.00	1569	2
24+50.00	1634	58
25+00.00	1675	79

Station -DETEB- (Based off of -L-)	Uncl. Exc. (cu. yd.)	Embt (cu. yd.)
26+50.00	0	0
27+00.00	67	0
27+50.00	106	126
28+00.00	75	326
28+50.00	70	431
29+00.00	69	482
29+50.00	70	506
30+00.00	70	491
30+50.00	71	426
31+00.00	73	316
31+50.00	69	213
32+00.00	68	174
32+50.00	90	87
33+00.00	106	0
33+50.00	108	0
34+00.00	102	0
34+50.00	81	0
35+00.00	101	0
35+50.00	186	0
36+00.00	241	0
36+50.00	323	0

8/23/99

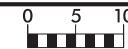

PROJ. REFERENCE NO.
B-4447

SHEET NO.
X-1

150 140 130 120 110 100 90 80 70 60 50 40 30 20 10 0 10 20 30 40 50 60 70 80 90 100 110 120 130 140 150

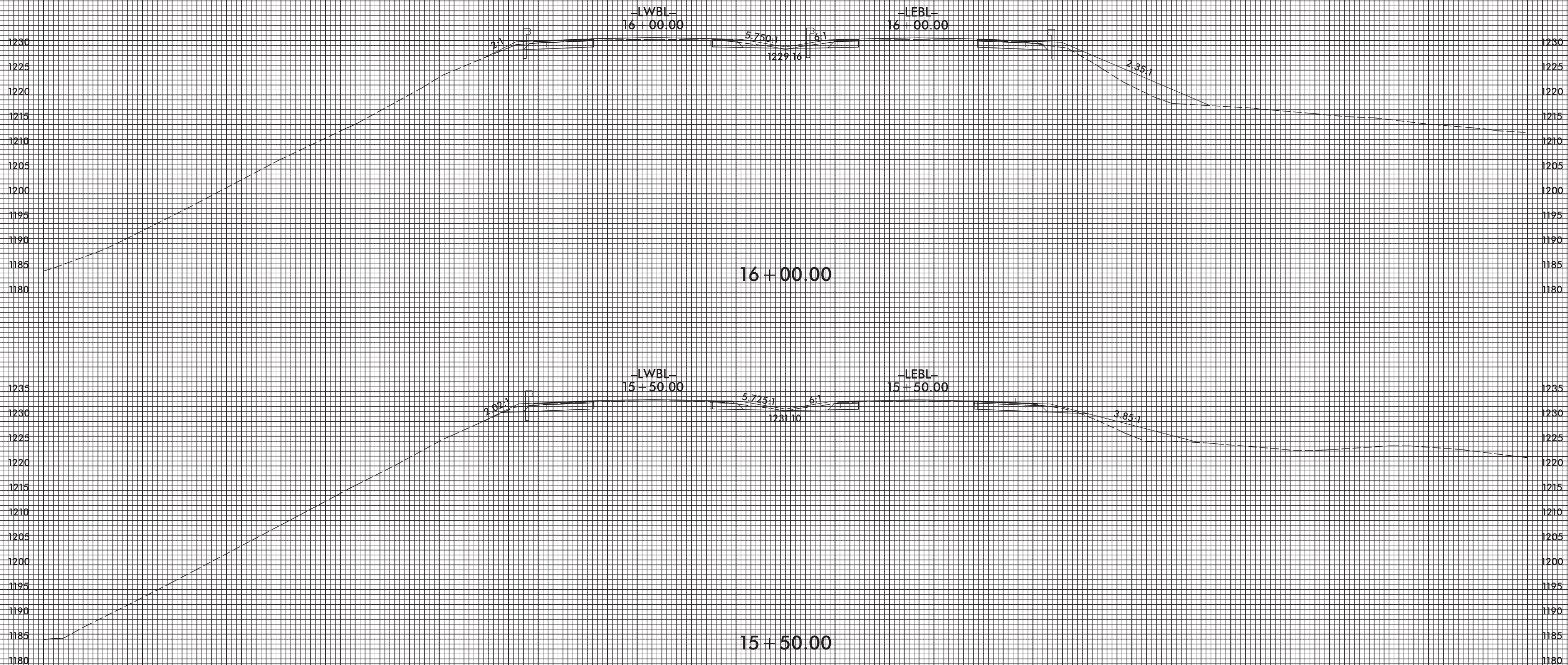

5/10/2017 13:58:56 B4447_Rdy_xpl_L.dgn

150 140 130 120 110 100 90 80 70 60 50 40 30 20 10 0 10 20 30 40 50 60 70 80 90 100 110 120 130 140 150

8/23/99



PROJ. REFERENCE NO.
B-4447

SHEET NO.
X-2

150 140 130 120 110 100 90 80 70 60 50 40 30 20 10 0 10 20 30 40 50 60 70 80 90 100 110 120 130 140 150

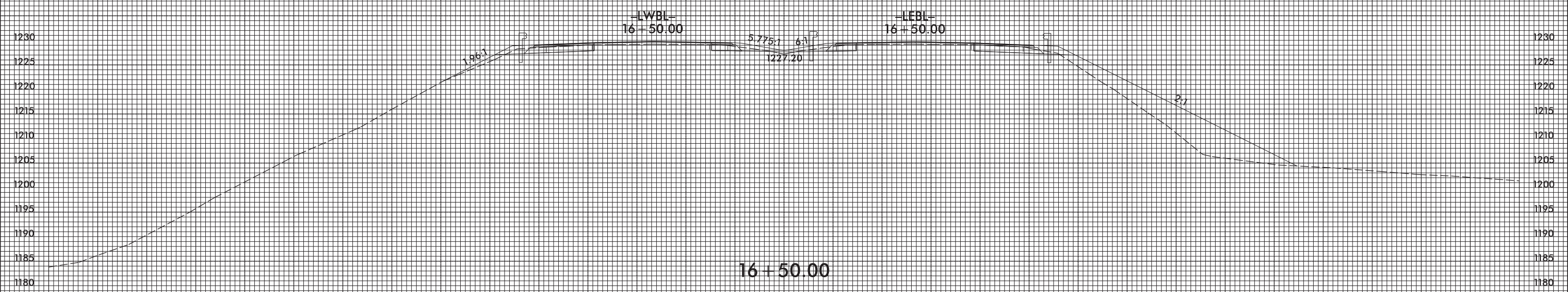
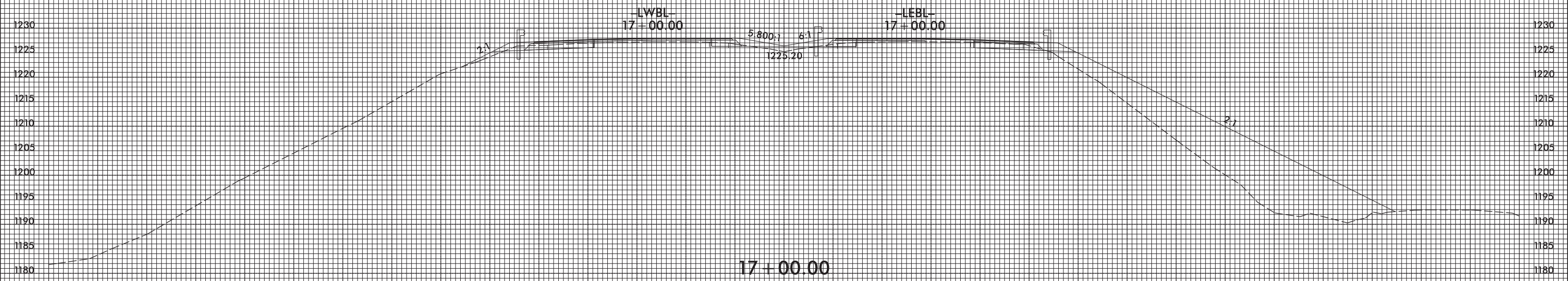

5/10/2017 13:55:56 B4447_Rdy_xpl_L.dgn USER: KES



8/23/99

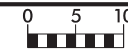

PROJ. REFERENCE NO.
B-4447

SHEET NO.
X-3

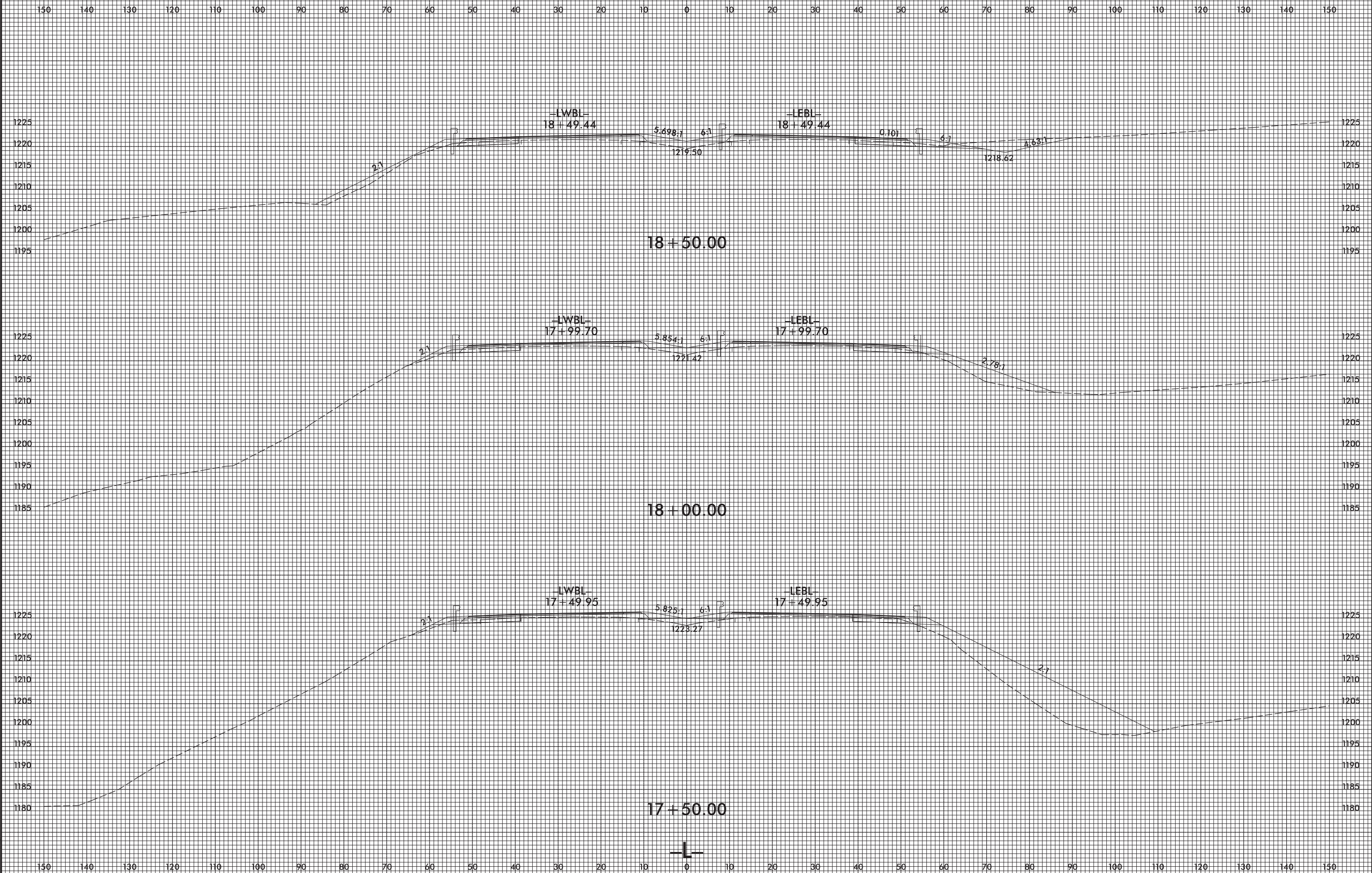

5/10/2017
I:\S:\B4447_Rdy_xpl_L.dgn
USER: KES

8/23/99

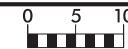

PROJ. REFERENCE NO.
B-4447

SHEET NO.
X-4

150 140 130 120 110 100 90 80 70 60 50 40 30 20 10 0 10 20 30 40 50 60 70 80 90 100 110 120 130 140 150

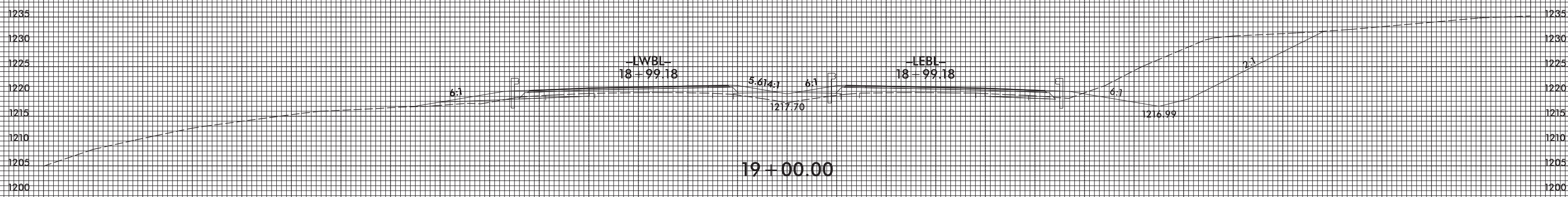
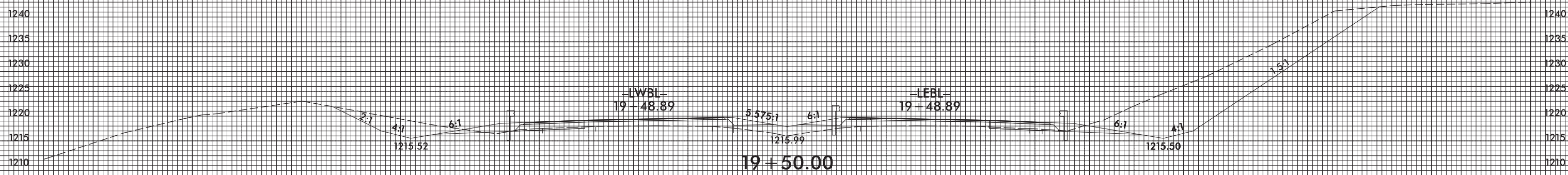
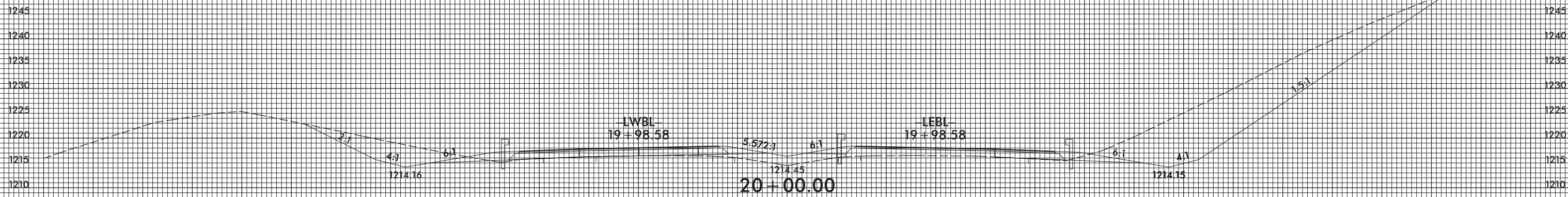

150 140 130 120 110 100 90 80 70 60 50 40 30 20 10 0 10 20 30 40 50 60 70 80 90 100 110 120 130 140 150

5/10/2017
I:\S:\B4447_Rdy_xpl_L.dgn
USER: RDS

8/23/99

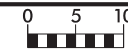

PROJ. REFERENCE NO.
B-4447

SHEET NO.
X-5

150 140 130 120 110 100 90 80 70 60 50 40 30 20 10 0 10 20 30 40 50 60 70 80 90 100 110 120 130 140 150

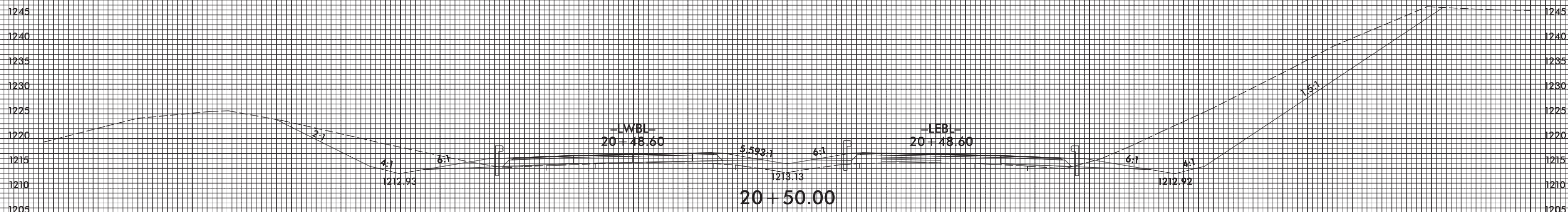
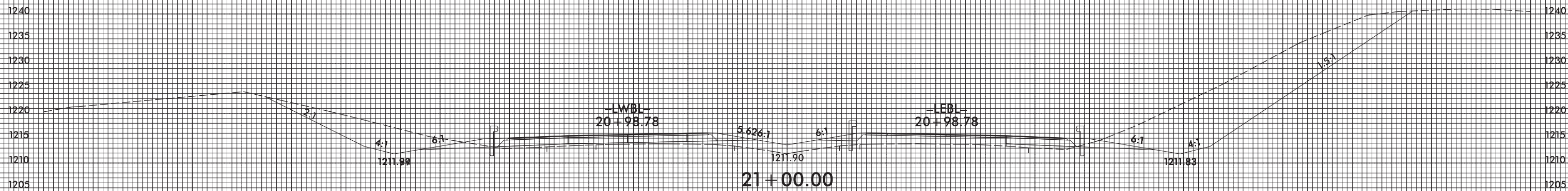
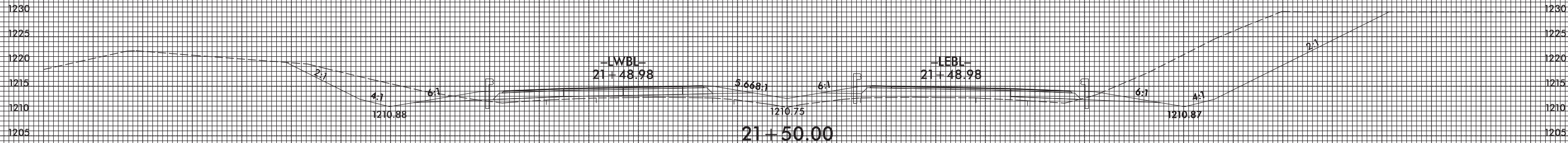

150 140 130 120 110 100 90 80 70 60 50 40 30 20 10 0 10 20 30 40 50 60 70 80 90 100 110 120 130 140 150

5/10/2017 13:58:56 B4447_Rdy_xpl_L.dgn

8/23/99

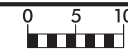

PROJ. REFERENCE NO.
B-4447

SHEET NO.
X-6

150 140 130 120 110 100 90 80 70 60 50 40 30 20 10 0 10 20 30 40 50 60 70 80 90 100 110 120 130 140 150

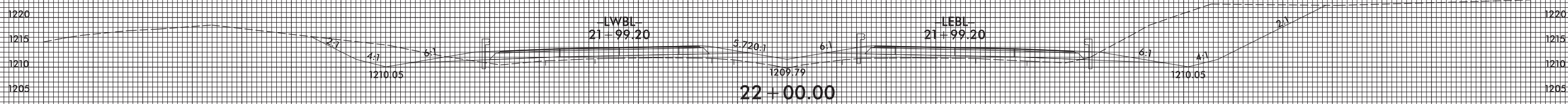
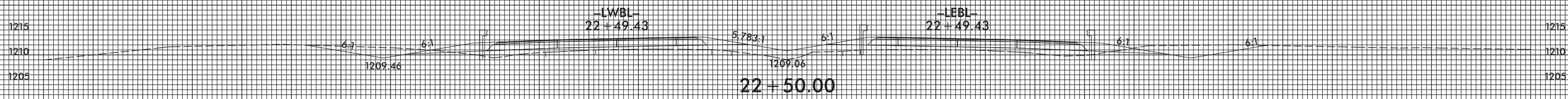
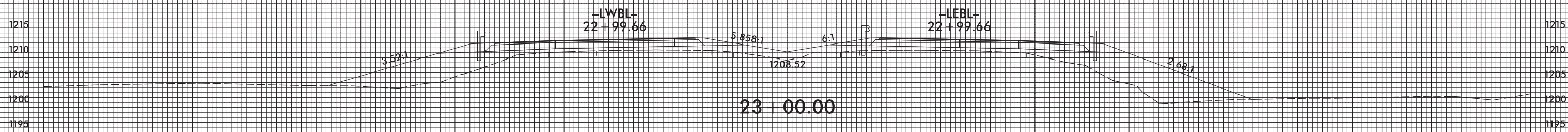
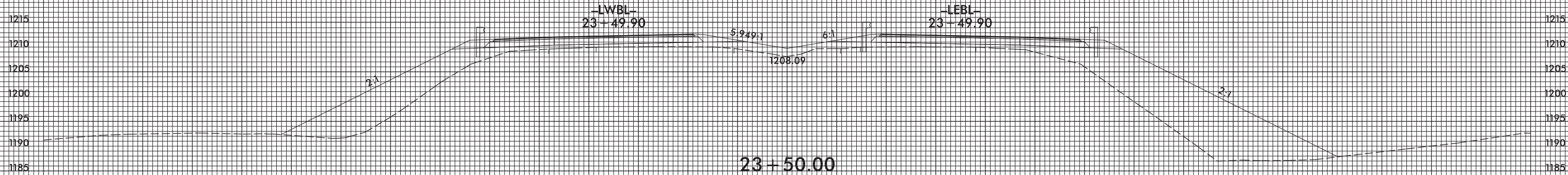

150 140 130 120 110 100 90 80 70 60 50 40 30 20 10 0 10 20 30 40 50 60 70 80 90 100 110 120 130 140 150

5/10/2017
I:\S:\B4447_Rdy_xpl_L.dgn
USER: KES

8/23/99

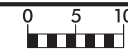

PROJ. REFERENCE NO.
B-4447

SHEET NO.
X-7

150 140 130 120 110 100 90 80 70 60 50 40 30 20 10 0 10 20 30 40 50 60 70 80 90 100 110 120 130 140 150

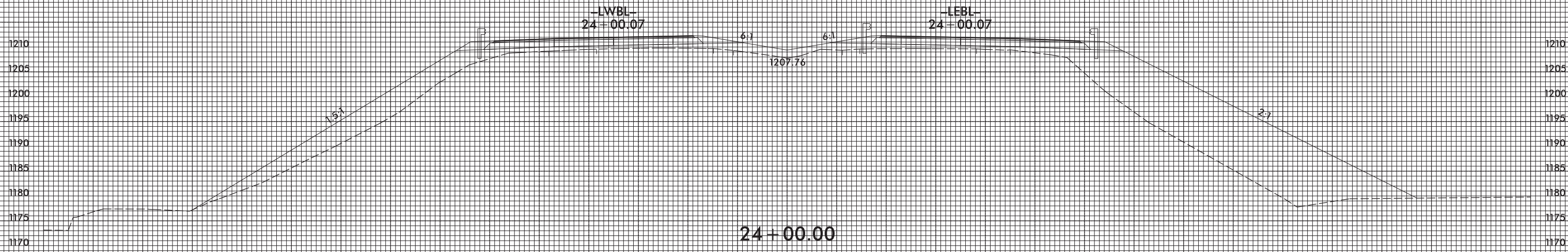
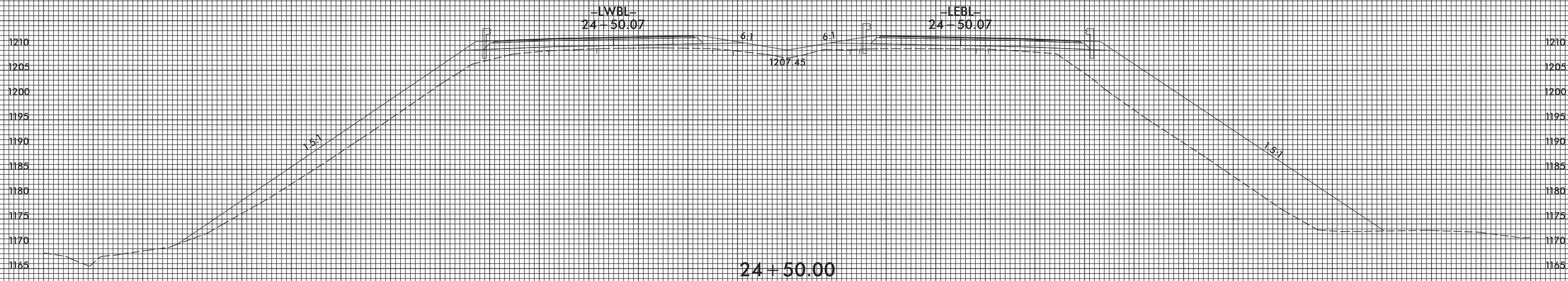

150 140 130 120 110 100 90 80 70 60 50 40 30 20 10 0 10 20 30 40 50 60 70 80 90 100 110 120 130 140 150

5/10/2017 13:58:56 B4447_Rdy_xpl_L.dgn

USER: KES

8/23/99

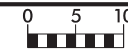

PROJ. REFERENCE NO.
B-4447

SHEET NO.
X-8

150 140 130 120 110 100 90 80 70 60 50 40 30 20 10 0 10 20 30 40 50 60 70 80 90 100 110 120 130 140 150

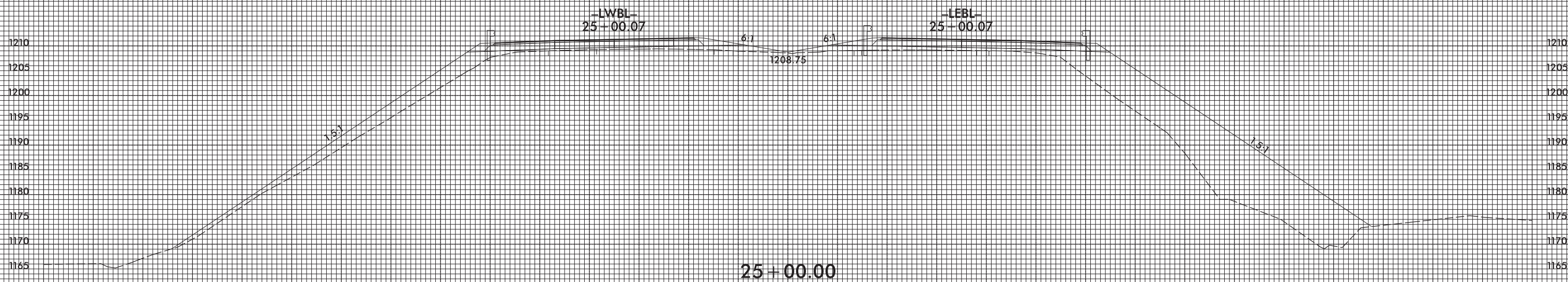
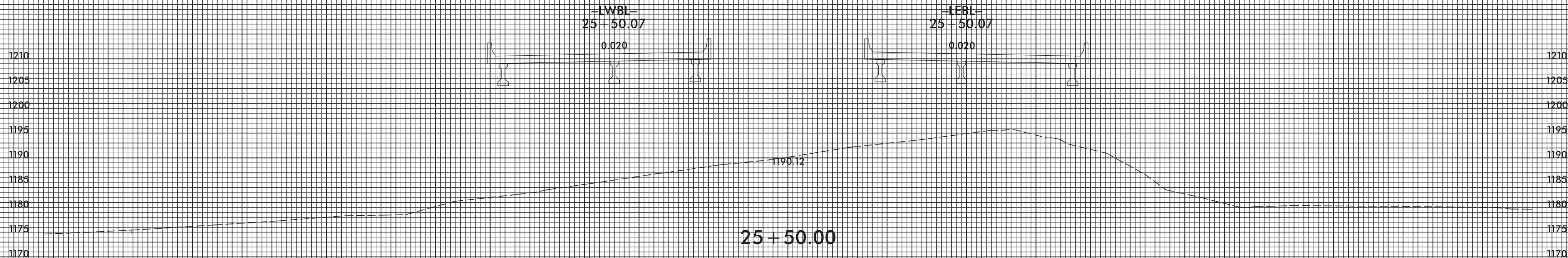
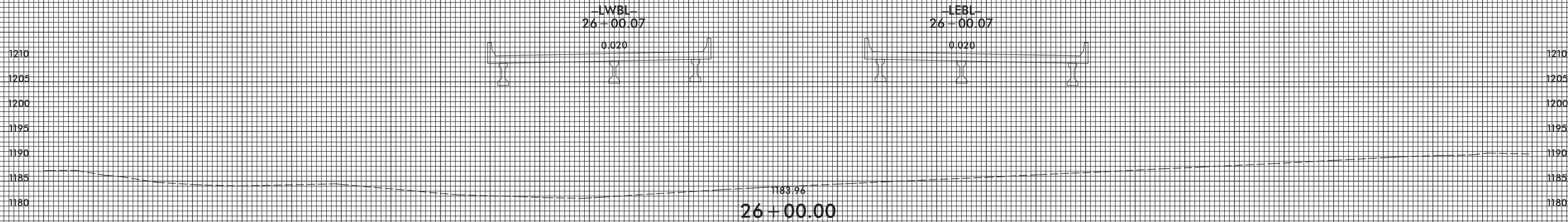

150 140 130 120 110 100 90 80 70 60 50 40 30 20 10 0 10 20 30 40 50 60 70 80 90 100 110 120 130 140 150

5/10/2017
I:\S:\B4447_Rdy_xpl_L.dgn
USER: KES

8/23/99



PROJ. REFERENCE NO.
B-4447

SHEET NO.
X-9

150 140 130 120 110 100 90 80 70 60 50 40 30 20 10 0 10 20 30 40 50 60 70 80 90 100 110 120 130 140 150

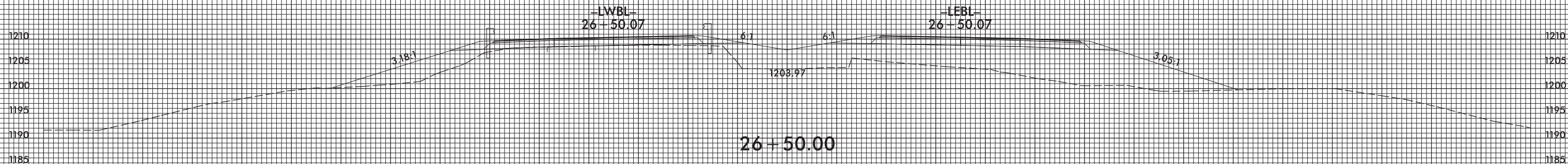
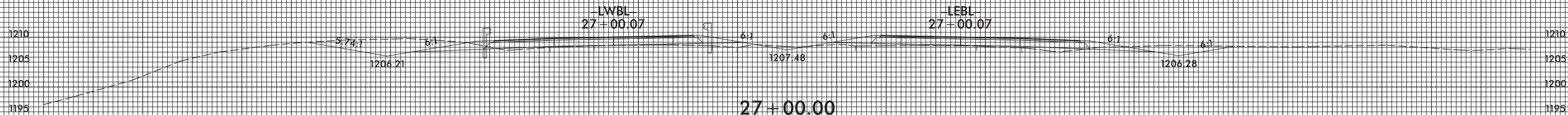
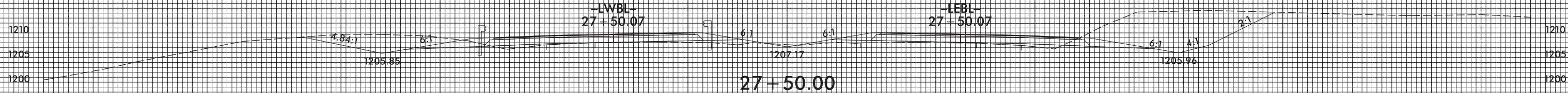
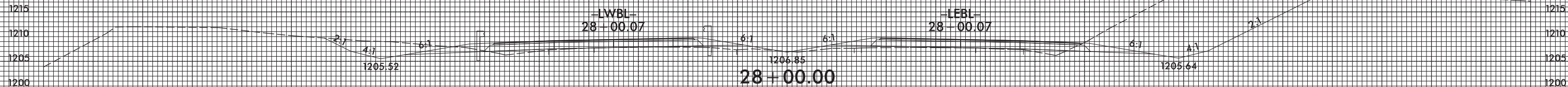

150 140 130 120 110 100 90 80 70 60 50 40 30 20 10 0 10 20 30 40 50 60 70 80 90 100 110 120 130 140 150

5/10/2017
I:\S:\B4447_Rdy_xpl_L.dgn
USER: RDS



8/23/99

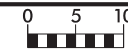

PROJ. REFERENCE NO.
B-4447

SHEET NO.
X-10

150 140 130 120 110 100 90 80 70 60 50 40 30 20 10 0 10 20 30 40 50 60 70 80 90 100 110 120 130 140 150

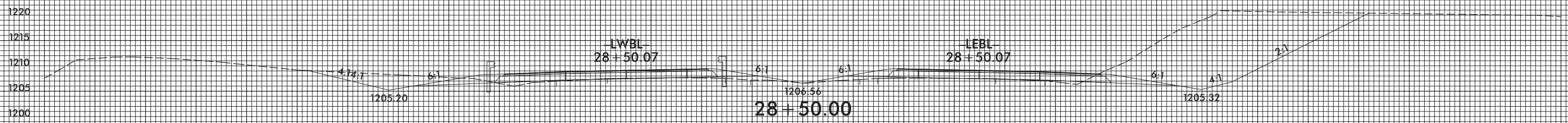
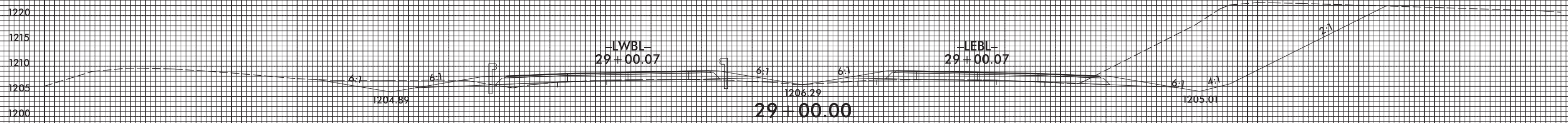
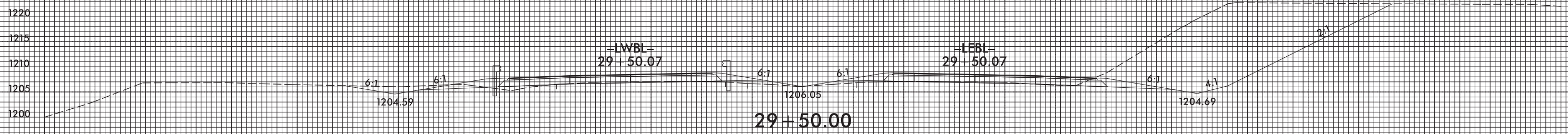
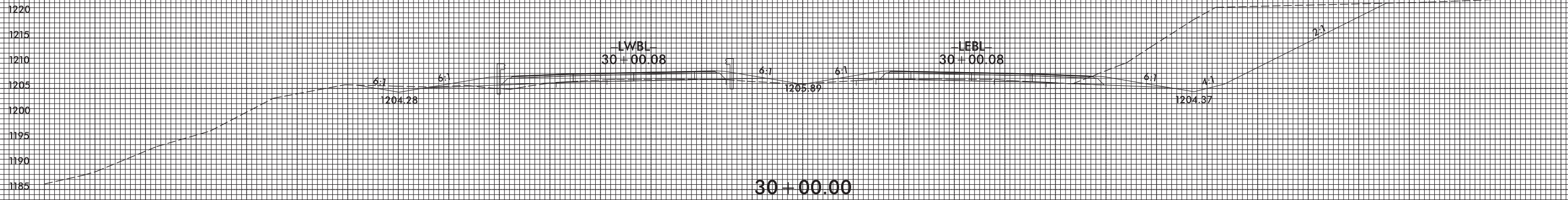

150 140 130 120 110 100 90 80 70 60 50 40 30 20 10 0 10 20 30 40 50 60 70 80 90 100 110 120 130 140 150

5/10/2017 13:58:56 \\s:\B4447_Rdy_xpl_L.dgn



8/23/99

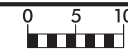

PROJ. REFERENCE NO.
B-4447

SHEET NO.
X-11

150 140 130 120 110 100 90 80 70 60 50 40 30 20 10 0 10 20 30 40 50 60 70 80 90 100 110 120 130 140 150

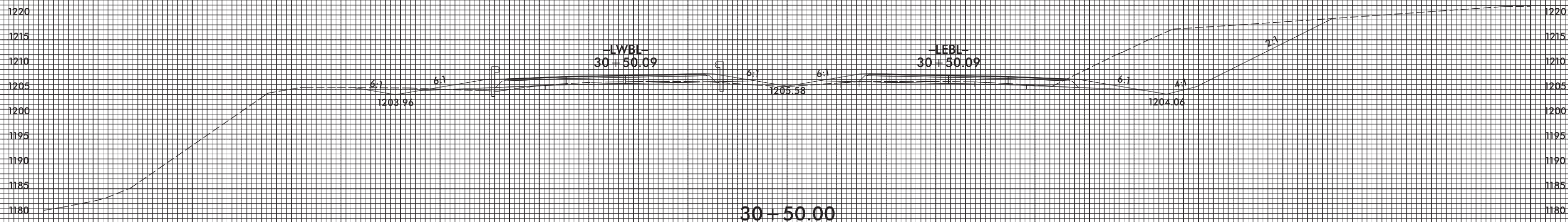
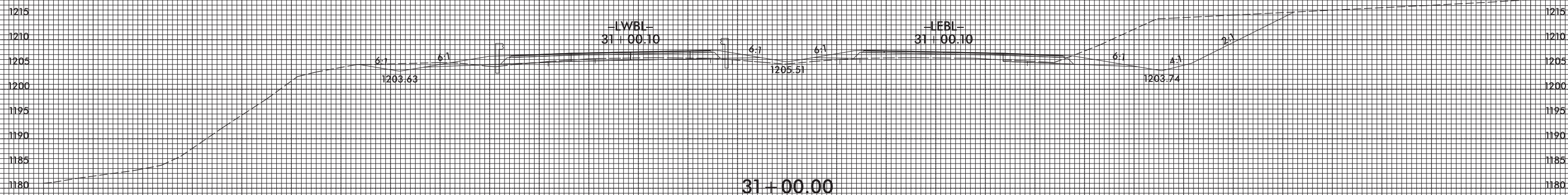
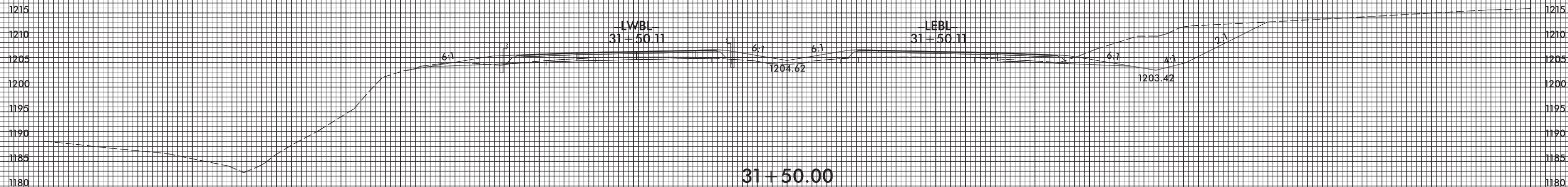

150 140 130 120 110 100 90 80 70 60 50 40 30 20 10 0 10 20 30 40 50 60 70 80 90 100 110 120 130 140 150

5/10/2017 1:51:52 PM \\s:\proj\B4447_Rdy_xpl_L.dgn

8/23/99

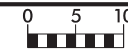

PROJ. REFERENCE NO.
B-4447

SHEET NO.
X-12

150 140 130 120 110 100 90 80 70 60 50 40 30 20 10 0 10 20 30 40 50 60 70 80 90 100 110 120 130 140 150

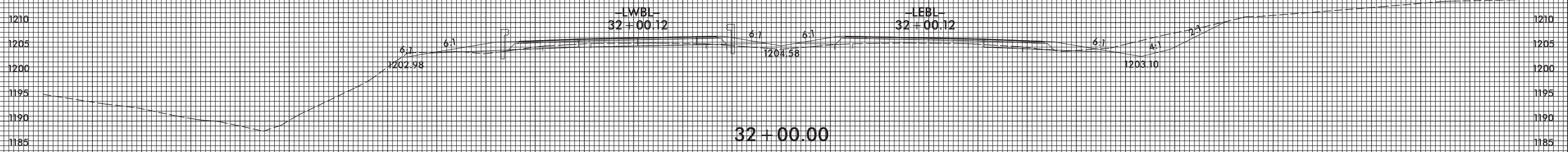
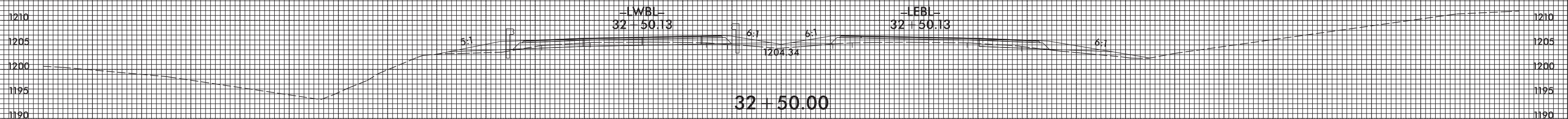
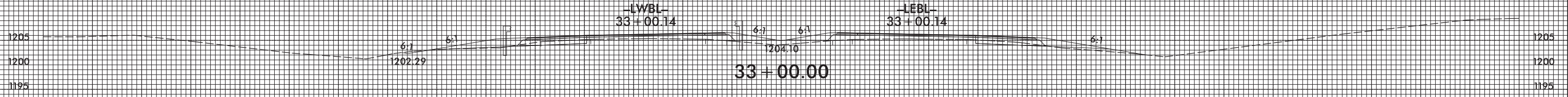
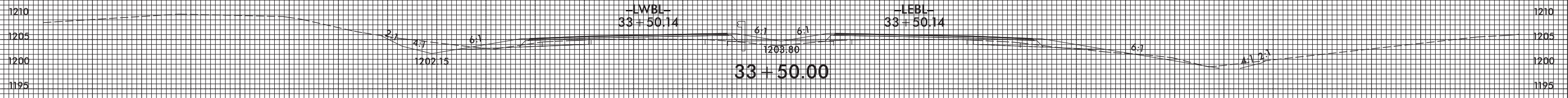
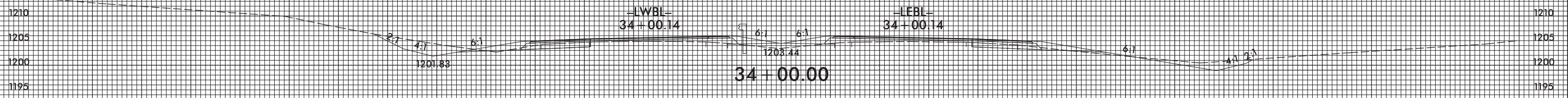

150 140 130 120 110 100 90 80 70 60 50 40 30 20 10 0 10 20 30 40 50 60 70 80 90 100 110 120 130 140 150

5/10/2017 11:58:55 AM B4447_Rdy_xpl.dgn



8/23/99

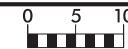

PROJ. REFERENCE NO.
B-4447

SHEET NO.
X-13

150 140 130 120 110 100 90 80 70 60 50 40 30 20 10 0 10 20 30 40 50 60 70 80 90 100 110 120 130 140 150

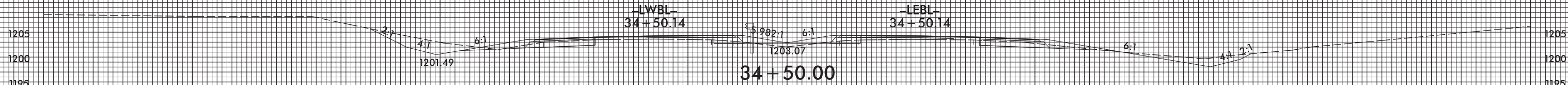
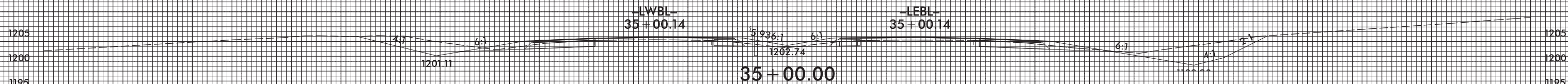
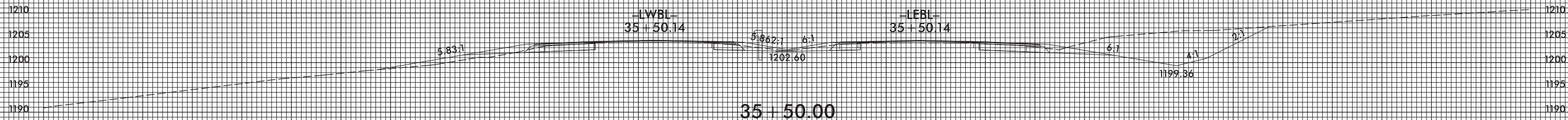
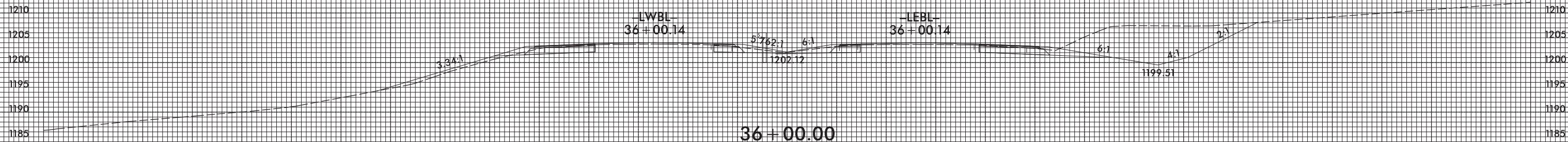

150 140 130 120 110 100 90 80 70 60 50 40 30 20 10 0 10 20 30 40 50 60 70 80 90 100 110 120 130 140 150

5/10/2017 13:58:56 \\sfs\B4447_Rdy_xpl_L.dgn USER: KFS

8/23/99



PROJ. REFERENCE NO.
B-4447

SHEET NO.
X-14

150 140 130 120 110 100 90 80 70 60 50 40 30 20 10 0 10 20 30 40 50 60 70 80 90 100 110 120 130 140 150

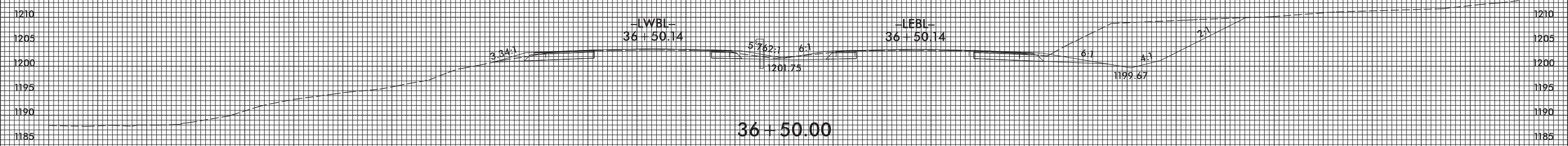

150 140 130 120 110 100 90 80 70 60 50 40 30 20 10 0 10 20 30 40 50 60 70 80 90 100 110 120 130 140 150

5/10/2017
I:\S\B4447_Rdy_xpl_L.dgn
USER: RDS

8/23/99

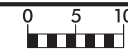

PROJ. REFERENCE NO.
B-4447

SHEET NO.
X-15

150 140 130 120 110 100 90 80 70 60 50 40 30 20 10 0 10 20 30 40 50 60 70 80 90 100 110 120 130 140 150

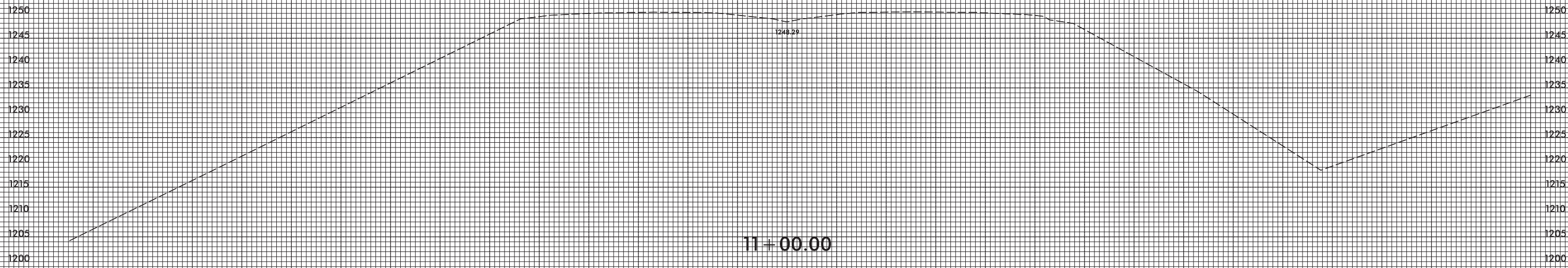
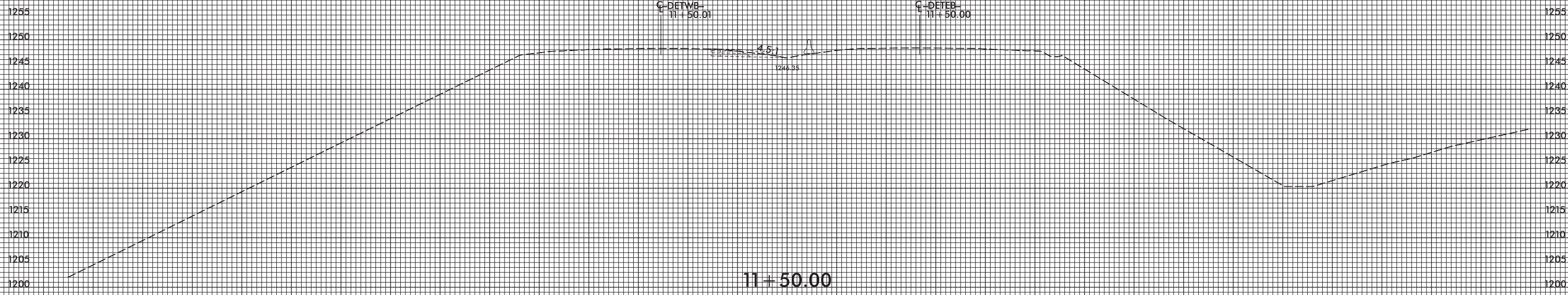

DETOUR (BASED OFF OF -L-)

150 140 130 120 110 100 90 80 70 60 50 40 30 20 10 0 10 20 30 40 50 60 70 80 90 100 110 120 130 140 150

5/10/2017 13:52:56 \\B4447-Rdy-xpl_DET.dgn

8/23/99

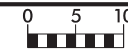

PROJ. REFERENCE NO.
B-4447

SHEET NO.
X-16

150 140 130 120 110 100 90 80 70 60 50 40 30 20 10 0 10 20 30 40 50 60 70 80 90 100 110 120 130 140 150

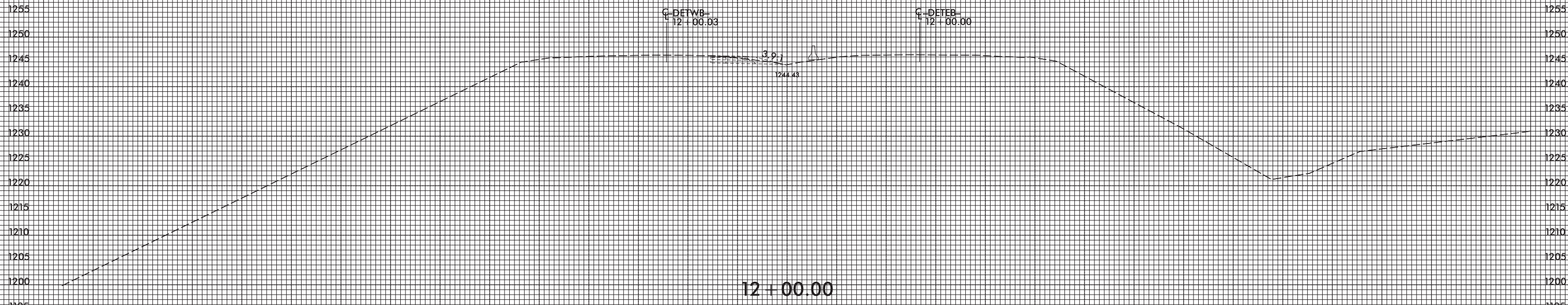
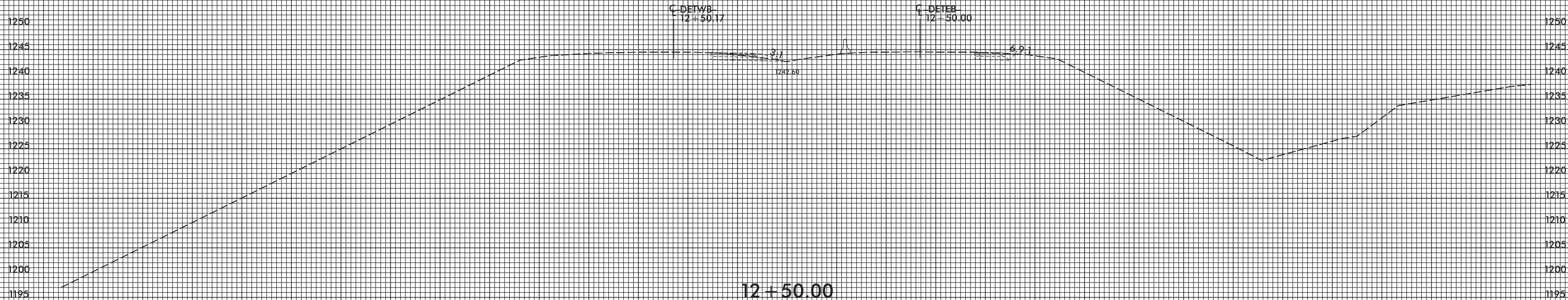

DETOUR (BASED OFF OF -L-)

150 140 130 120 110 100 90 80 70 60 50 40 30 20 10 0 10 20 30 40 50 60 70 80 90 100 110 120 130 140 150

5/10/2017 13:52:56 C:\Users\KJF\Documents\B4447_Rdy_xpl_DET.dgn

8/23/99



PROJ. REFERENCE NO.
B-4447

SHEET NO.
X-17

150 140 130 120 110 100 90 80 70 60 50 40 30 20 10 0 10 20 30 40 50 60 70 80 90 100 110 120 130 140 150

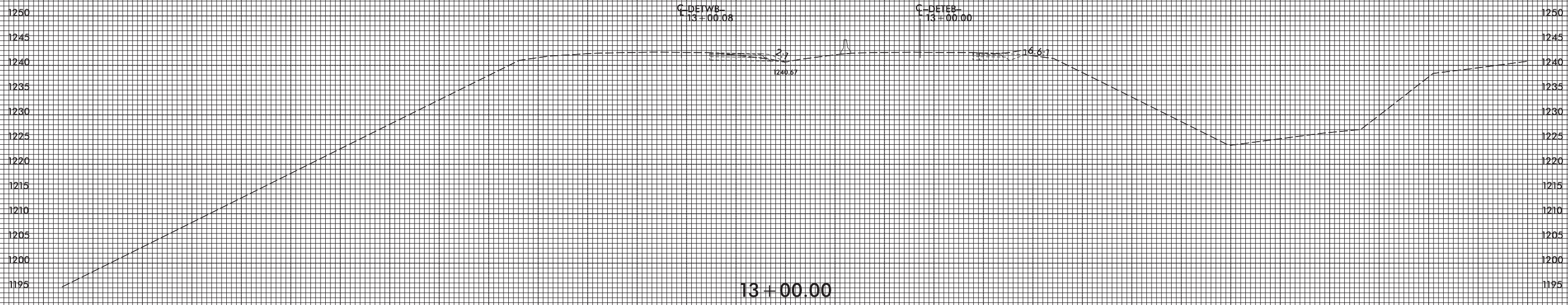
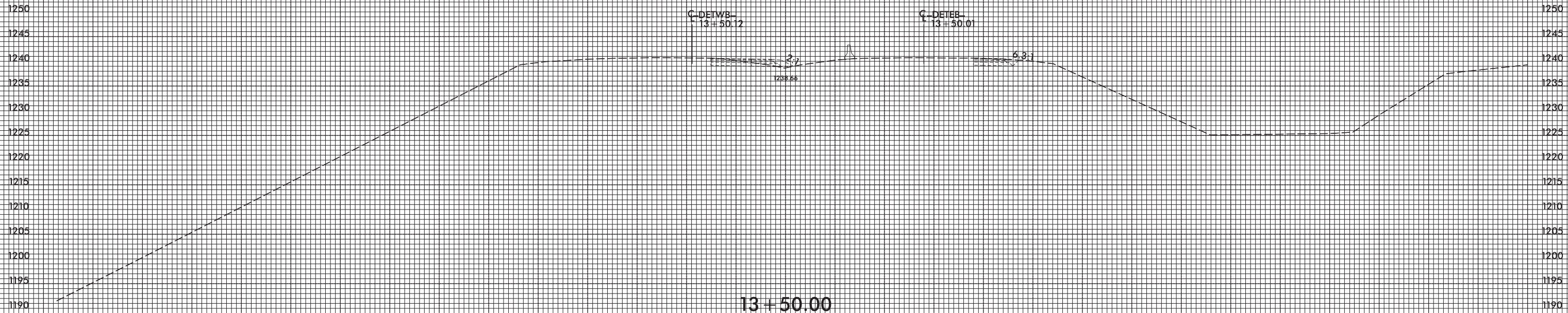

DETOUR (BASED OFF OF -L-)

150 140 130 120 110 100 90 80 70 60 50 40 30 20 10 0 10 20 30 40 50 60 70 80 90 100 110 120 130 140 150

5/10/2017 13:52:56 \\B4447-Rdy-xpl_DET.dgn

8/23/99



PROJ. REFERENCE NO.
B-4447

SHEET NO.
X-18

150 140 130 120 110 100 90 80 70 60 50 40 30 20 10 0 10 20 30 40 50 60 70 80 90 100 110 120 130 140 150

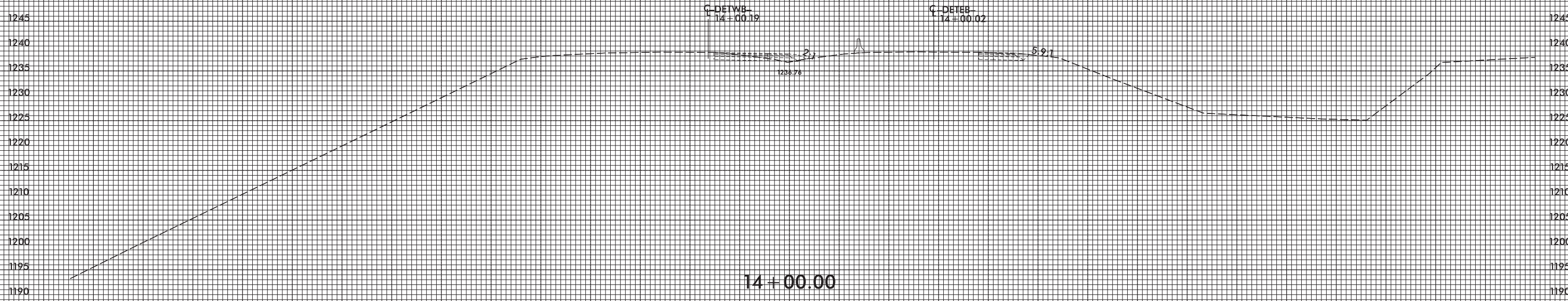
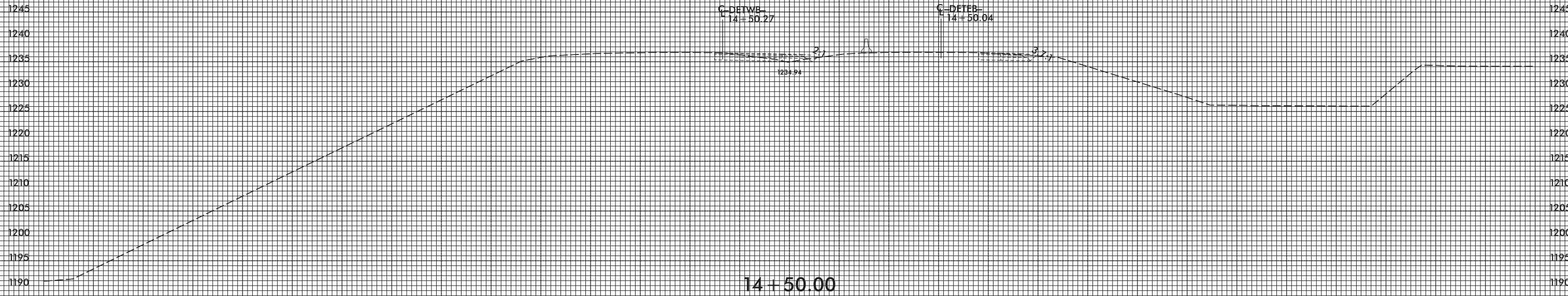

DETOUR (BASED OFF OF -L-)

150 140 130 120 110 100 90 80 70 60 50 40 30 20 10 0 10 20 30 40 50 60 70 80 90 100 110 120 130 140 150

5/10/2017
13:52:56
J:\S:\B4447_Rdy_xpl_DET.dgn
KES

8/23/99

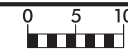

PROJ. REFERENCE NO.
B-4447

SHEET NO.
X-19

150 140 130 120 110 100 90 80 70 60 50 40 30 20 10 0 10 20 30 40 50 60 70 80 90 100 110 120 130 140 150

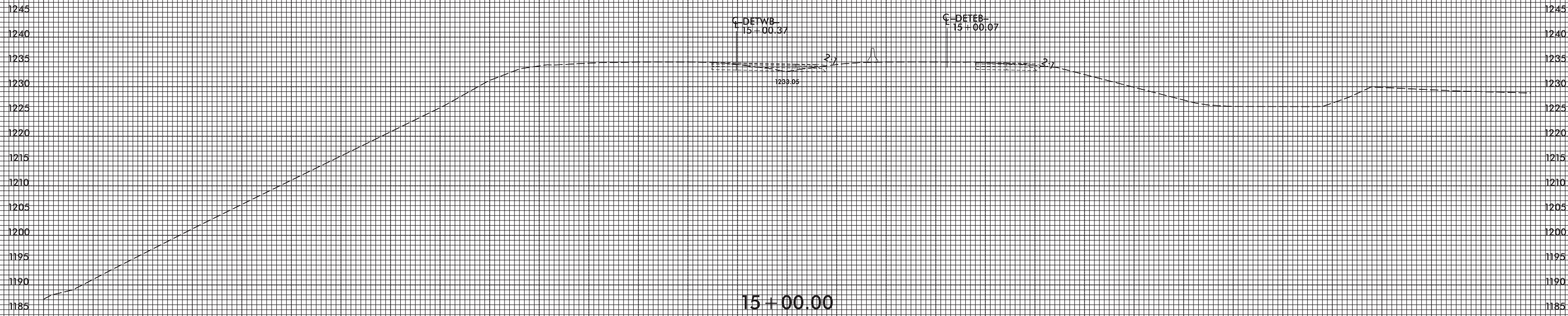
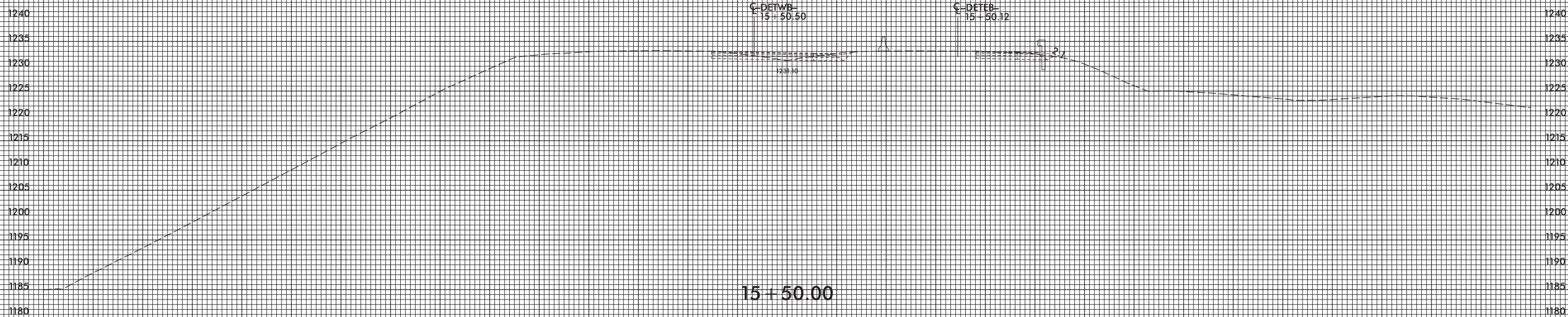

DETOUR (BASED OFF OF -L-)

150 140 130 120 110 100 90 80 70 60 50 40 30 20 10 0 10 20 30 40 50 60 70 80 90 100 110 120 130 140 150

5/10/2017 13:52:56 \\B4447-Rdy-xpl_DET.dgn

8/23/99

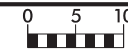

PROJ. REFERENCE NO.
B-4447

SHEET NO.
X-20

150 140 130 120 110 100 90 80 70 60 50 40 30 20 10 0 10 20 30 40 50 60 70 80 90 100 110 120 130 140 150

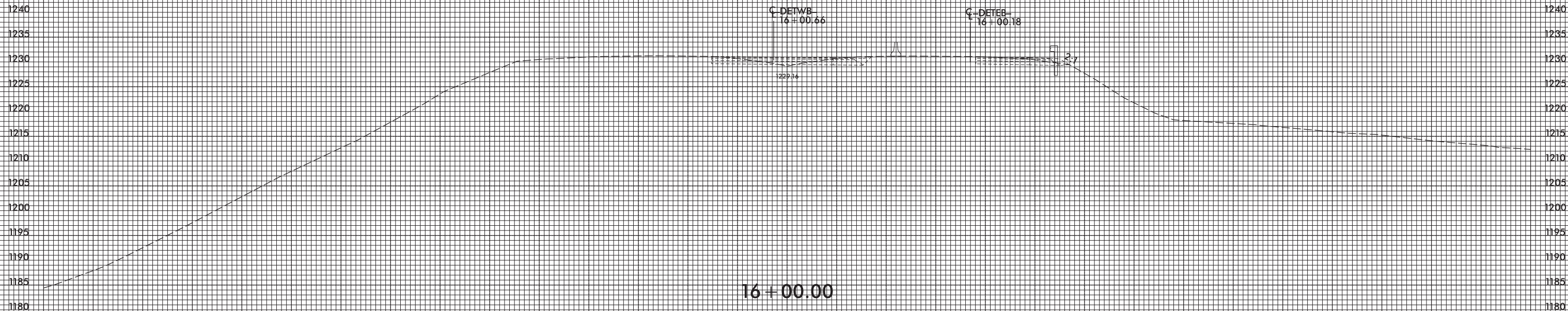
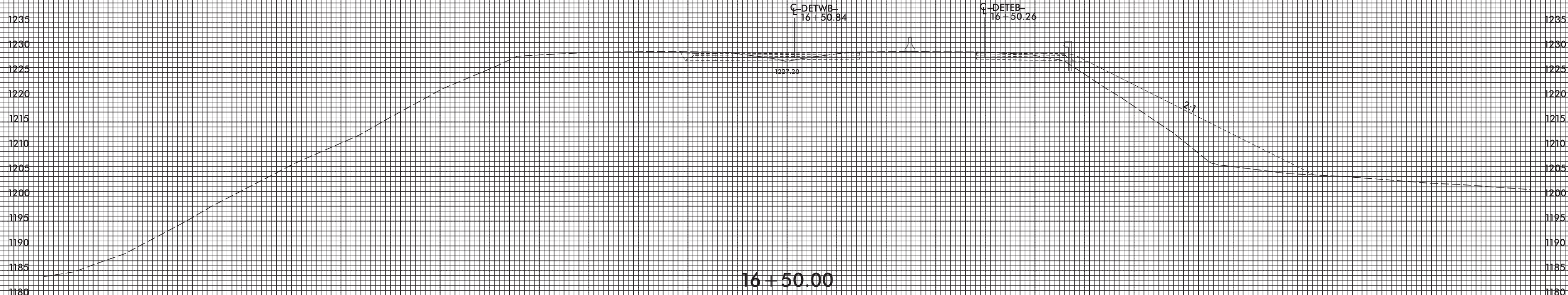

DETOUR (BASED OFF OF -L-)

150 140 130 120 110 100 90 80 70 60 50 40 30 20 10 0 10 20 30 40 50 60 70 80 90 100 110 120 130 140 150

5/10/2017 13:55:56 B4447-Rdy-xpl_DET.dgn

8/23/99



PROJ. REFERENCE NO.
B-4447

SHEET NO.
X-21

150 140 130 120 110 100 90 80 70 60 50 40 30 20 10 0 10 20 30 40 50 60 70 80 90 100 110 120 130 140 150

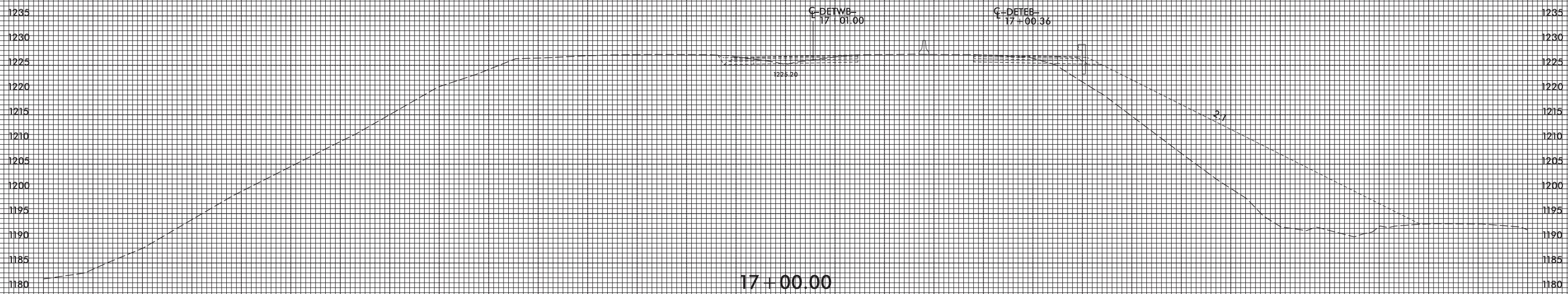
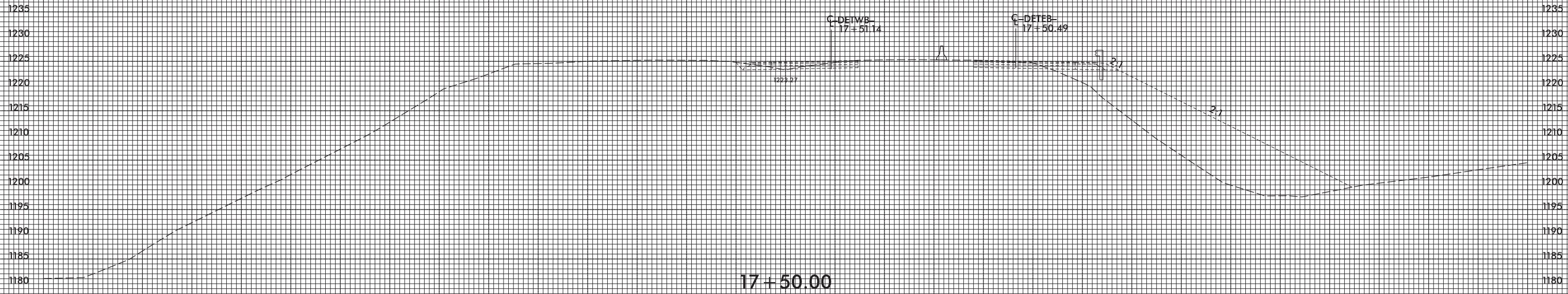

DETOUR (BASED OFF OF -L-)

150 140 130 120 110 100 90 80 70 60 50 40 30 20 10 0 10 20 30 40 50 60 70 80 90 100 110 120 130 140 150

5/10/2017 13:52:56 \\B4447-Rdy-xpl_DET.dgn

8/23/99

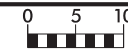

PROJ. REFERENCE NO.
B-4447

SHEET NO.
X-22

150 140 130 120 110 100 90 80 70 60 50 40 30 20 10 0 10 20 30 40 50 60 70 80 90 100 110 120 130 140 150

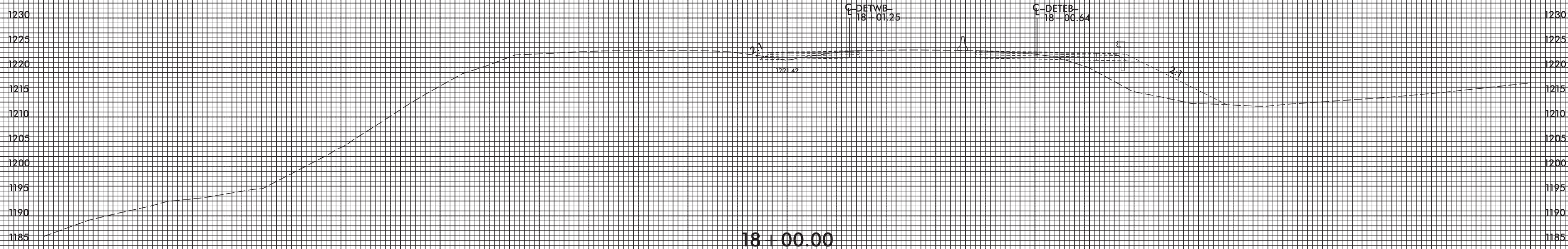
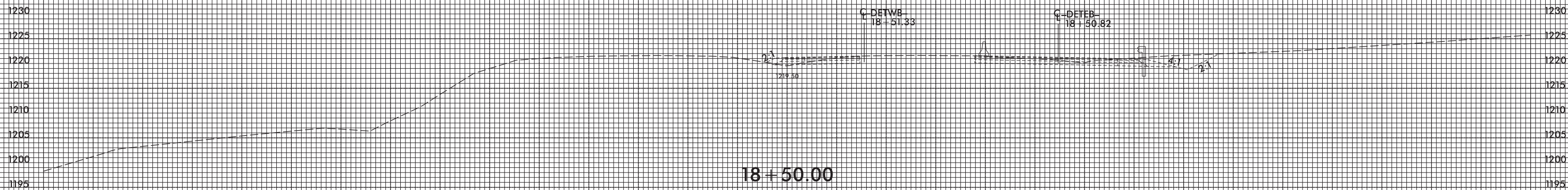
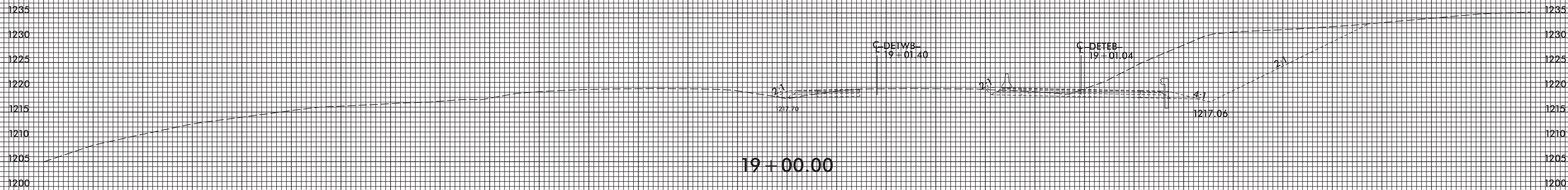

DETOUR (BASED OFF OF -L-)

150 140 130 120 110 100 90 80 70 60 50 40 30 20 10 0 10 20 30 40 50 60 70 80 90 100 110 120 130 140 150

5/10/2017 13:58:56 B4447-Rdy_xpl_DET.dgn

8/23/99



PROJ. REFERENCE NO.
B-4447

SHEET NO.
X-23

150 140 130 120 110 100 90 80 70 60 50 40 30 20 10 0 10 20 30 40 50 60 70 80 90 100 110 120 130 140 150

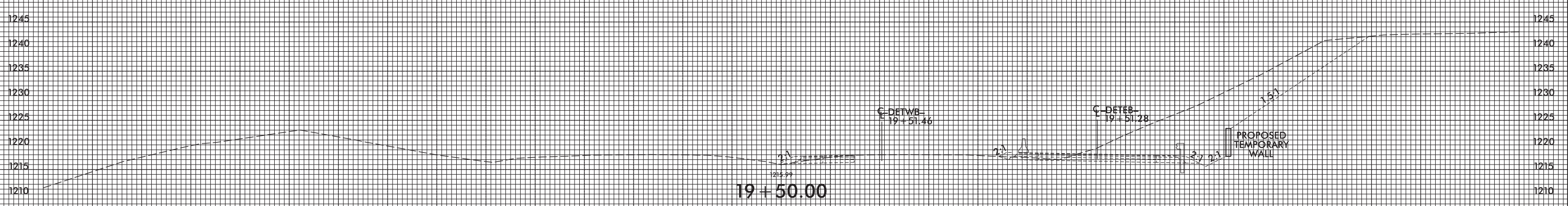
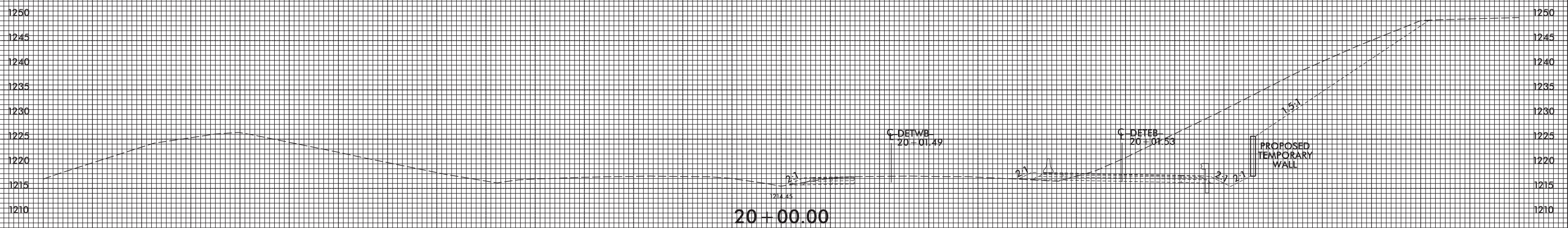
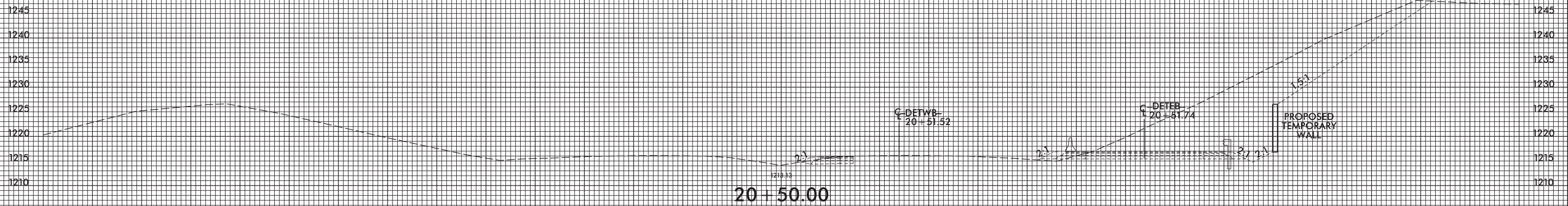

DETOUR (BASED OFF OF -L-)

150 140 130 120 110 100 90 80 70 60 50 40 30 20 10 0 10 20 30 40 50 60 70 80 90 100 110 120 130 140 150

5/10/2017
I:\S:\B4447\B4447_Rdy_xpl_DET.dgn
USER: RDB

8/23/99

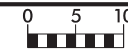

PROJ. REFERENCE NO.
B-4447

SHEET NO.
X-24

150 140 130 120 110 100 90 80 70 60 50 40 30 20 10 0 10 20 30 40 50 60 70 80 90 100 110 120 130 140 150

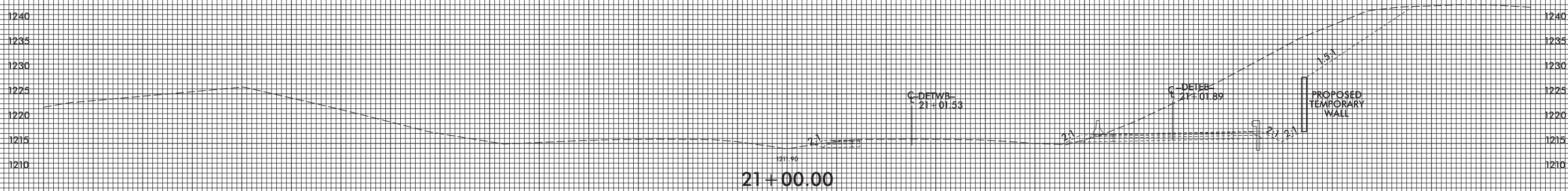
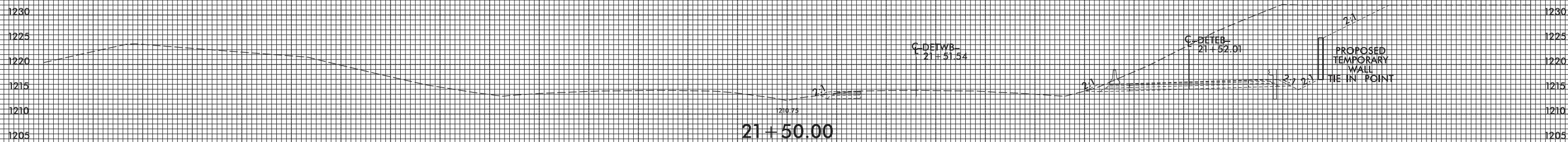
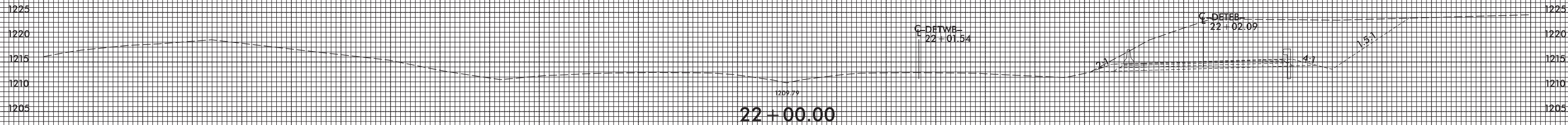
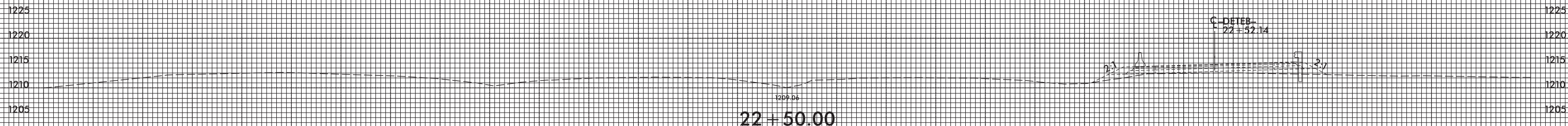

DETOUR (BASED OFF OF -L-)

150 140 130 120 110 100 90 80 70 60 50 40 30 20 10 0 10 20 30 40 50 60 70 80 90 100 110 120 130 140 150

5/10/2017
13:52:56
B4447_Rdy_xpl_DET.dgn
USER: RJS

8/23/99

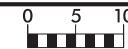

PROJ. REFERENCE NO.
B-4447

SHEET NO.
X-25

150 140 130 120 110 100 90 80 70 60 50 40 30 20 10 0 10 20 30 40 50 60 70 80 90 100 110 120 130 140 150

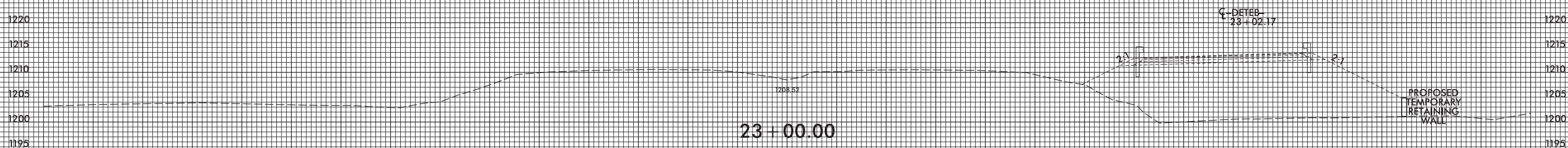
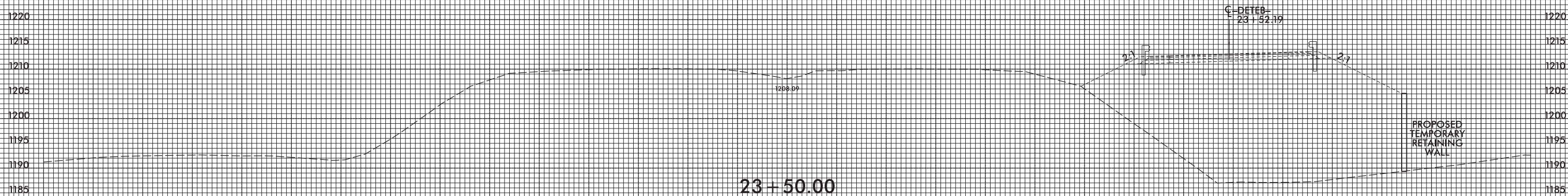
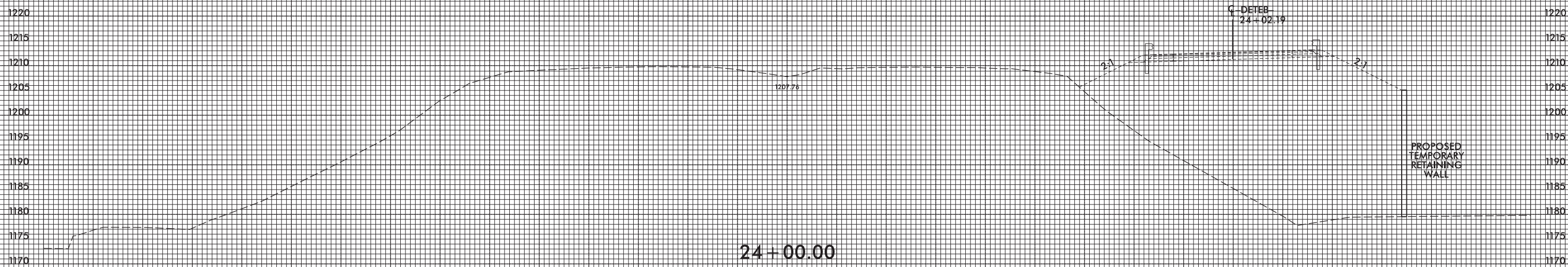

DETOUR (BASED OFF OF -L-)

150 140 130 120 110 100 90 80 70 60 50 40 30 20 10 0 10 20 30 40 50 60 70 80 90 100 110 120 130 140 150

5/10/2017
I:\S:\B4447_Rdy_xpl_DET.dgn
USER: RDS

8/23/99

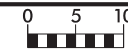

PROJ. REFERENCE NO.
B-4447

SHEET NO.
X-26

150 140 130 120 110 100 90 80 70 60 50 40 30 20 10 0 10 20 30 40 50 60 70 80 90 100 110 120 130 140 150

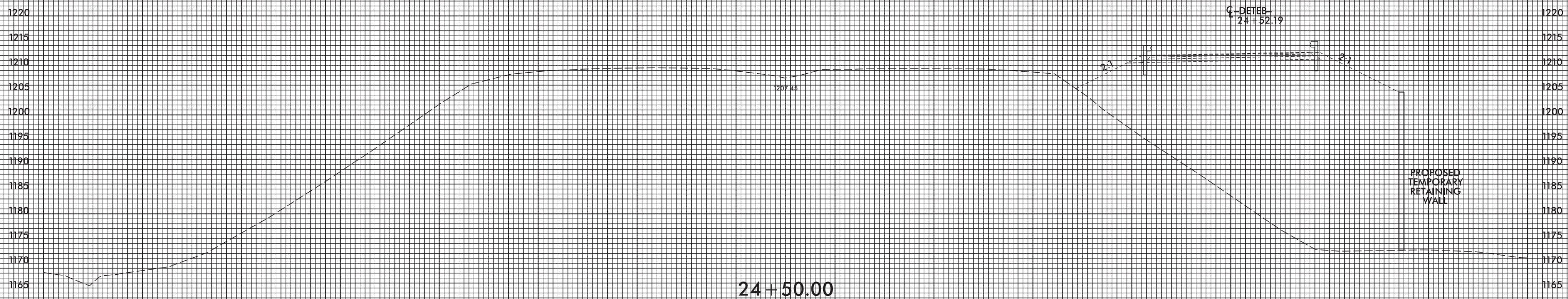
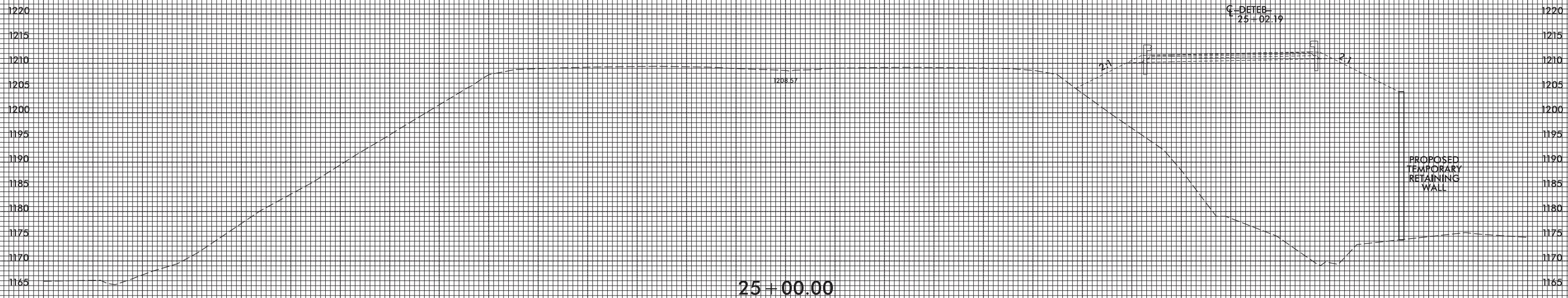

150 140 130 120 110 100 90 80 70 60 50 40 30 20 10 0 10 20 30 40 50 60 70 80 90 100 110 120 130 140 150

DETOUR (BASED OFF OF -L-)

5/10/2017 13:58:56 B4447_Rdy_xpl_DET.dgn

8/23/99



PROJ. REFERENCE NO.
B-4447

SHEET NO.
X-27

150 140 130 120 110 100 90 80 70 60 50 40 30 20 10 0 10 20 30 40 50 60 70 80 90 100 110 120 130 140 150

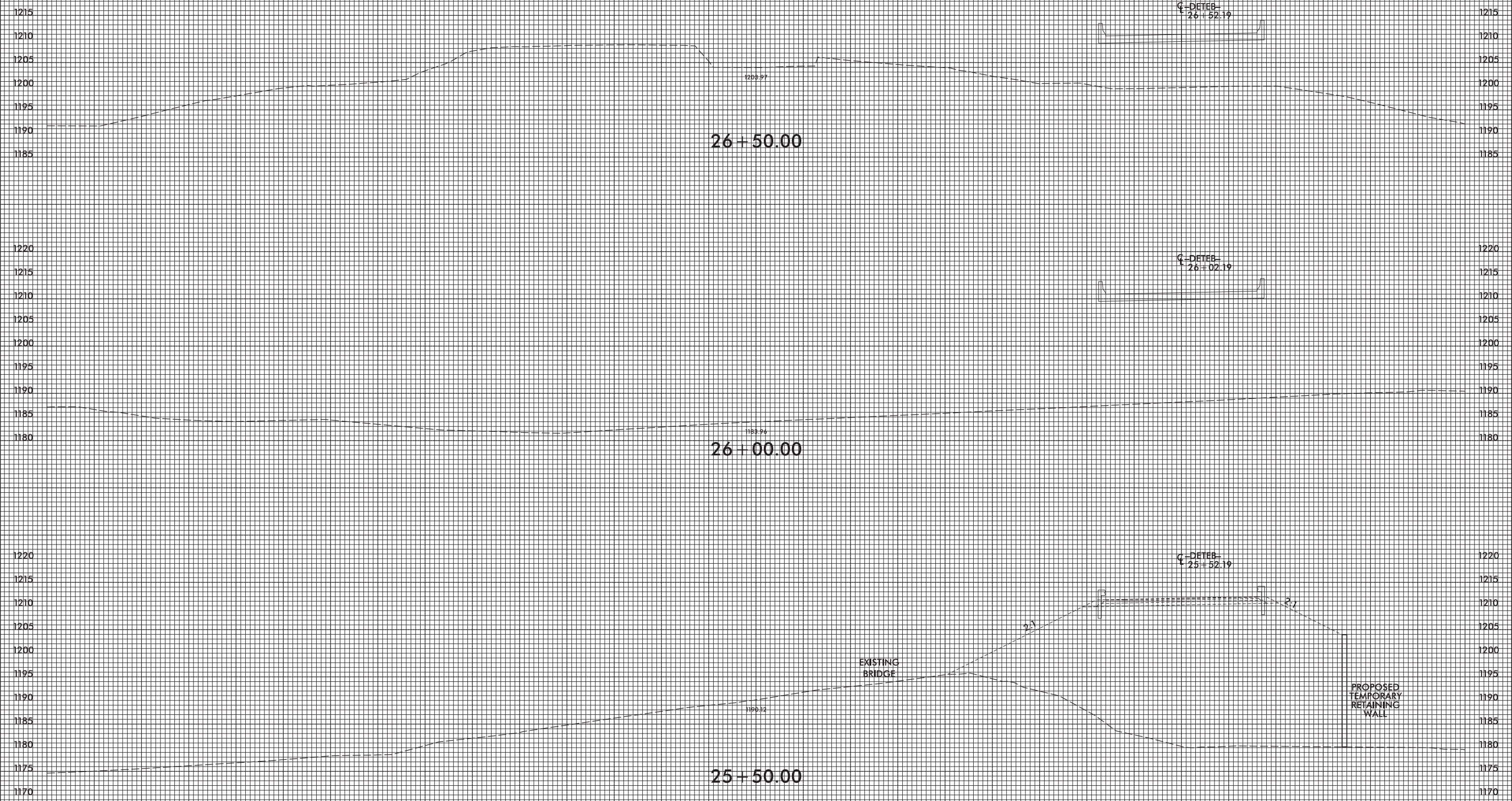

26 + 50.00

26 + 00.00

25 + 50.00

DETOUR (BASED OFF OF -L-)

5/10/2017
I:\S:\B4447_Rdy_xpl_DET.dgn
USER: RDS

8/23/99



PROJ. REFERENCE NO.
B-4447

SHEET NO.
X-28

150 140 130 120 110 100 90 80 70 60 50 40 30 20 10 0 10 20 30 40 50 60 70 80 90 100 110 120 130 140 150

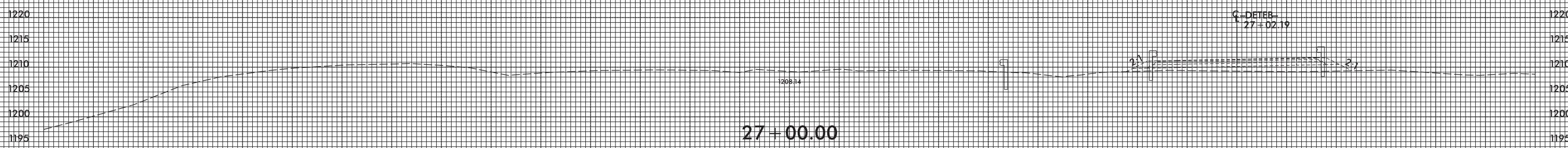
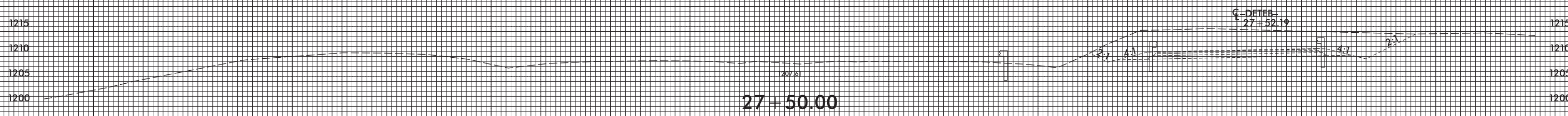
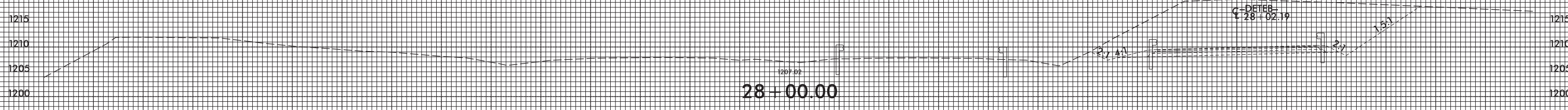
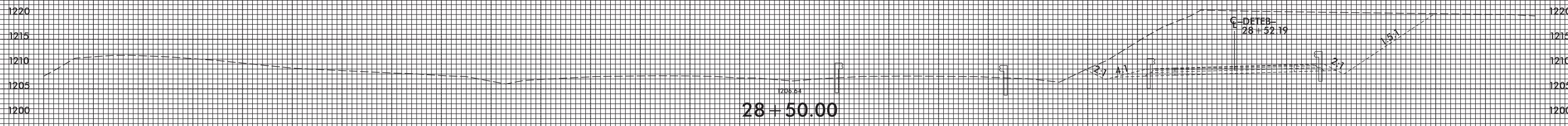

DETOUR (BASED OFF OF -L-)

150 140 130 120 110 100 90 80 70 60 50 40 30 20 10 0 10 20 30 40 50 60 70 80 90 100 110 120 130 140 150

5/10/2017
13:55:56
I:\S:\B4447_Rdy_xpl_DET.dgn
RDS

8/23/99



PROJ. REFERENCE NO.
B-4447

SHEET NO.
X-29

150 140 130 120 110 100 90 80 70 60 50 40 30 20 10 0 10 20 30 40 50 60 70 80 90 100 110 120 130 140 150

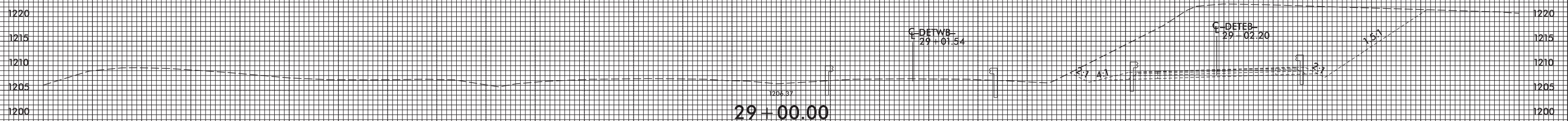
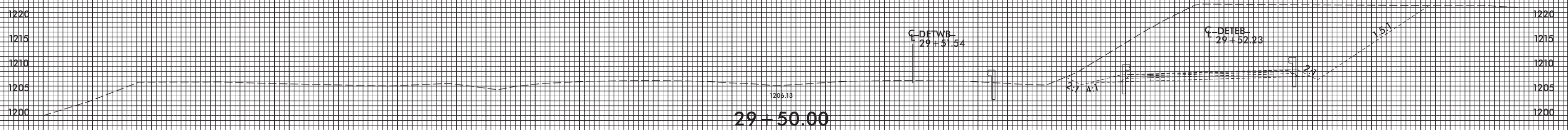
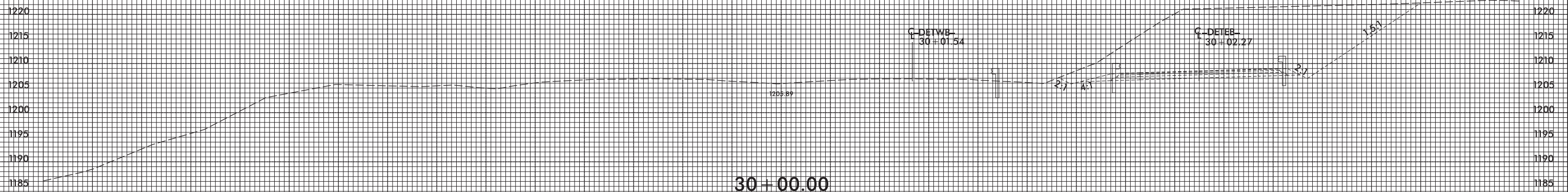

DETOUR (BASED OFF OF -L-)

150 140 130 120 110 100 90 80 70 60 50 40 30 20 10 0 10 20 30 40 50 60 70 80 90 100 110 120 130 140 150

5/10/2017 13:52:56 \\B4447-Rdy-xpl_DET.dgn

8/23/99

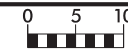

PROJ. REFERENCE NO.
B-4447

SHEET NO.
X-30

150 140 130 120 110 100 90 80 70 60 50 40 30 20 10 0 10 20 30 40 50 60 70 80 90 100 110 120 130 140 150

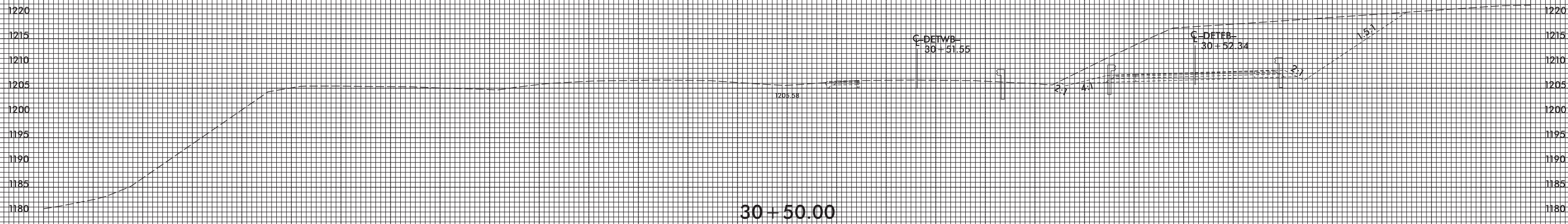
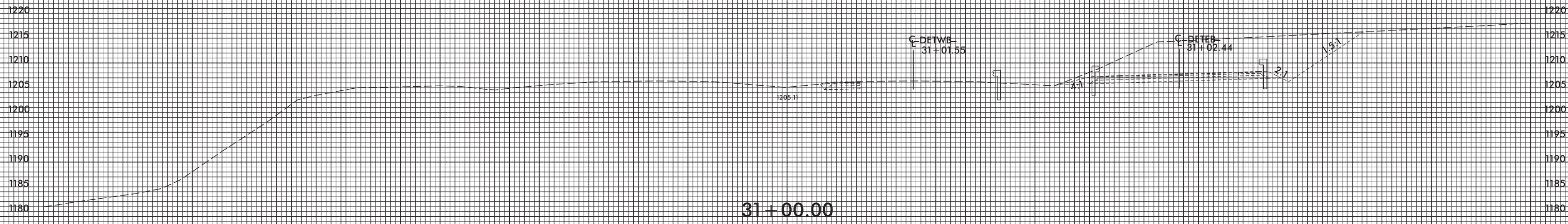
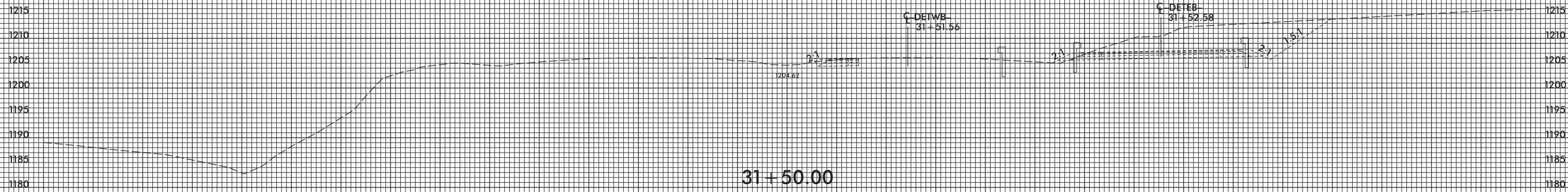

DETOUR (BASED OFF OF -L-)

150 140 130 120 110 100 90 80 70 60 50 40 30 20 10 0 10 20 30 40 50 60 70 80 90 100 110 120 130 140 150

5/10/2017 13:58:56 B4447_Rdy_xpl_DET.dgn

8/23/99

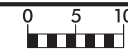

PROJ. REFERENCE NO.
B-4447

SHEET NO.
X-31

150 140 130 120 110 100 90 80 70 60 50 40 30 20 10 0 10 20 30 40 50 60 70 80 90 100 110 120 130 140 150

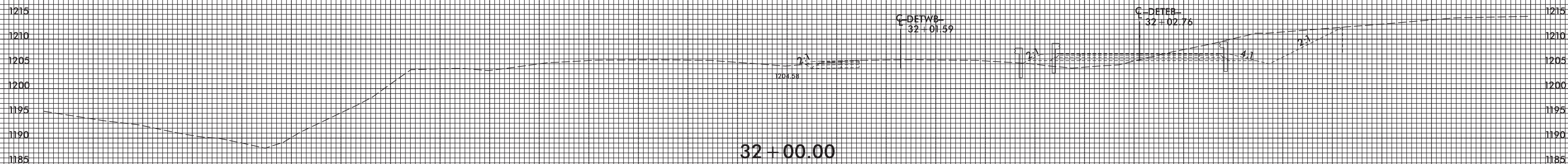
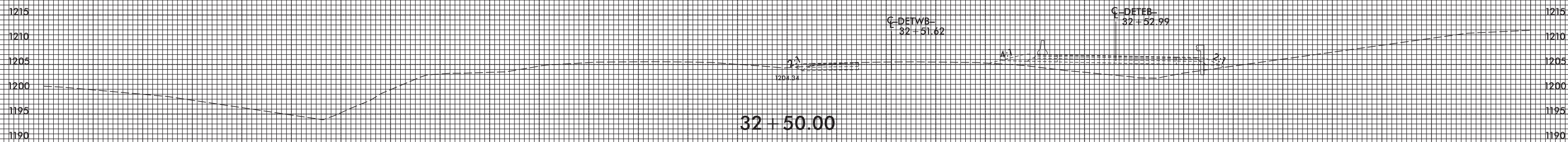
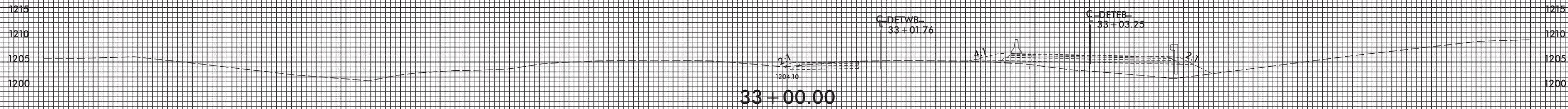
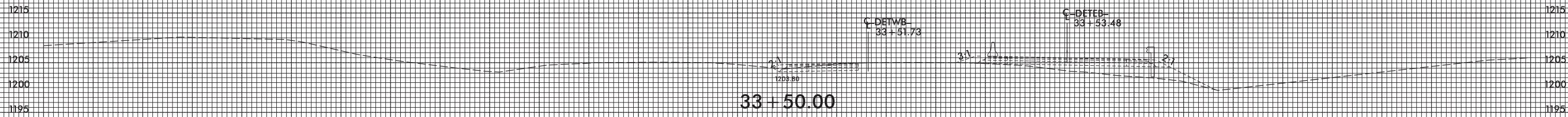

DETOUR (BASED OFF OF -L-)

150 140 130 120 110 100 90 80 70 60 50 40 30 20 10 0 10 20 30 40 50 60 70 80 90 100 110 120 130 140 150

5/10/2017 13:52:52 B4447_Rdy_xpl_DET.dgn

8/23/99



PROJ. REFERENCE NO.
B-4447

SHEET NO.
X-32

150 140 130 120 110 100 90 80 70 60 50 40 30 20 10 0 10 20 30 40 50 60 70 80 90 100 110 120 130 140 150

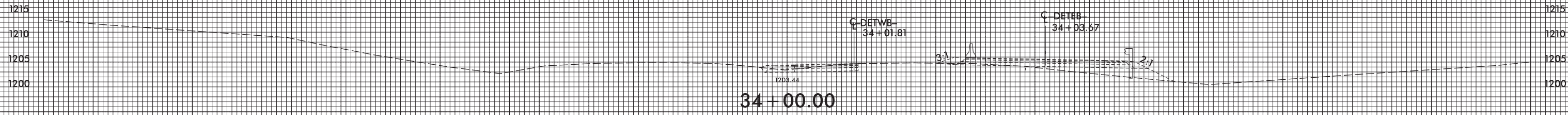
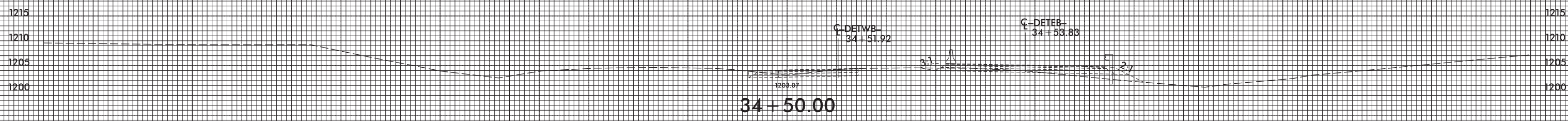
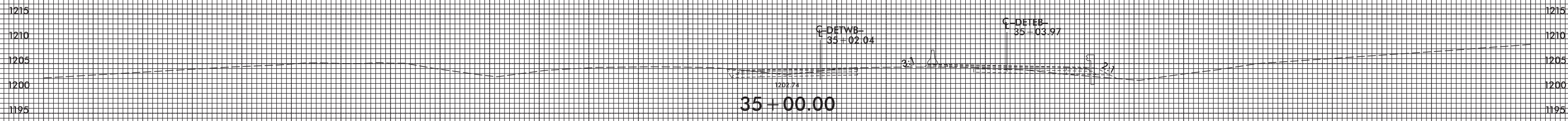
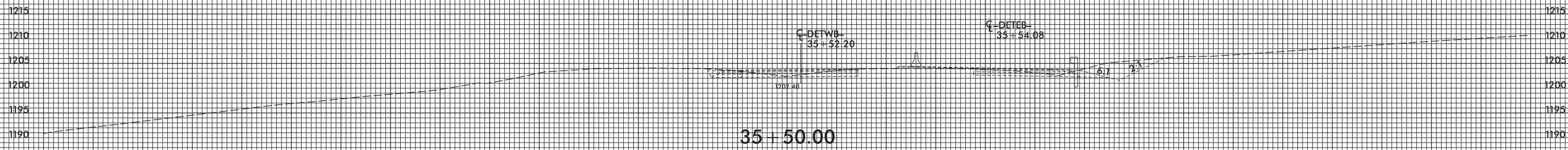

DETOUR (BASED OFF OF -L-)

150 140 130 120 110 100 90 80 70 60 50 40 30 20 10 0 10 20 30 40 50 60 70 80 90 100 110 120 130 140 150

5/10/2017
T:\S\B4447_Rdy_xpl_DET.dgn
USER: RDS

8/23/99

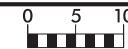

PROJ. REFERENCE NO.
B-4447

SHEET NO.
X-33

150 140 130 120 110 100 90 80 70 60 50 40 30 20 10 0 10 20 30 40 50 60 70 80 90 100 110 120 130 140 150

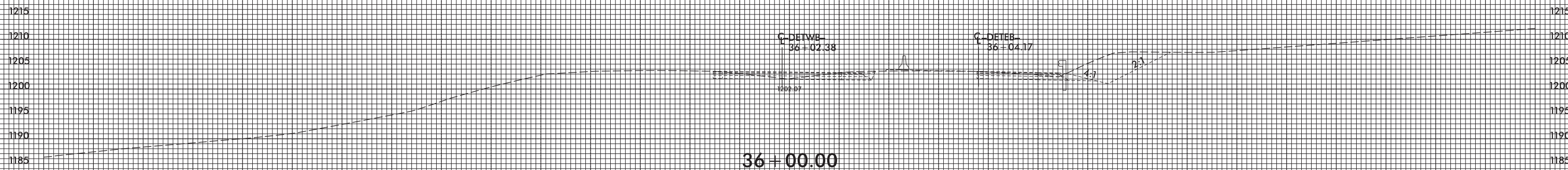
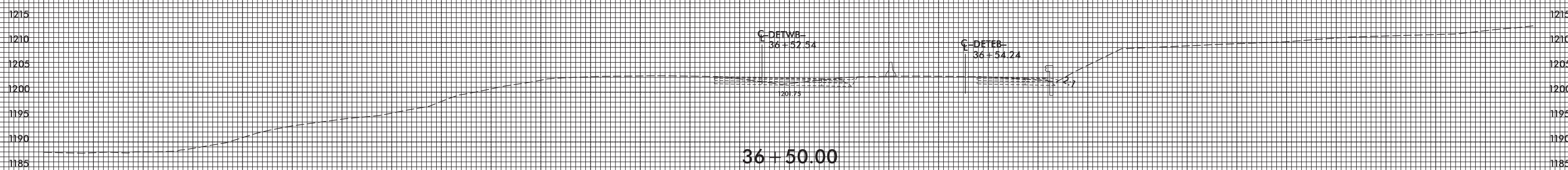
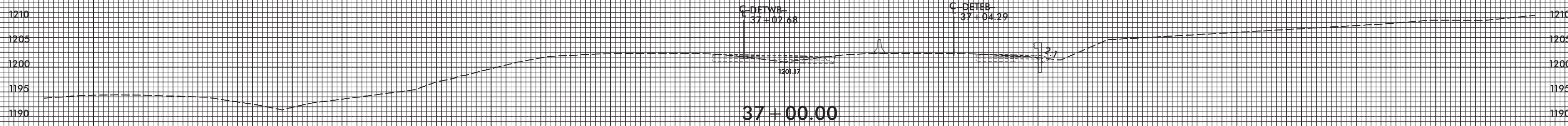
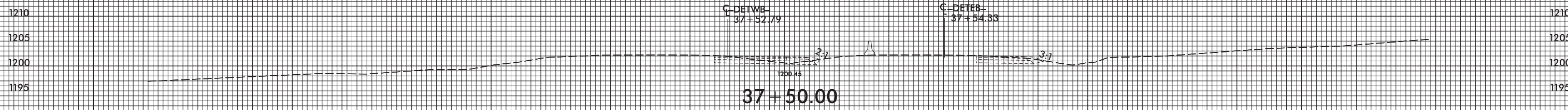

DETOUR (BASED OFF OF -L-)

150 140 130 120 110 100 90 80 70 60 50 40 30 20 10 0 10 20 30 40 50 60 70 80 90 100 110 120 130 140 150

5/10/2017 13:58:56 B4447_Rdy_xpl_DET.dgn

8/23/99

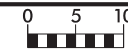

PROJ. REFERENCE NO.
B-4447

SHEET NO.
X-34

150 140 130 120 110 100 90 80 70 60 50 40 30 20 10 0 10 20 30 40 50 60 70 80 90 100 110 120 130 140 150

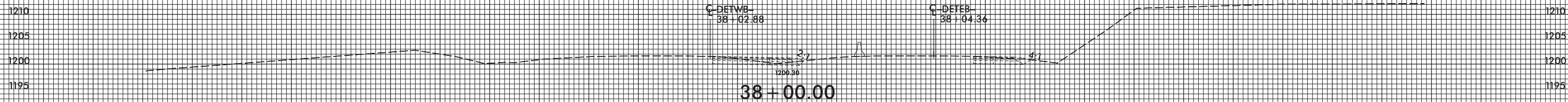
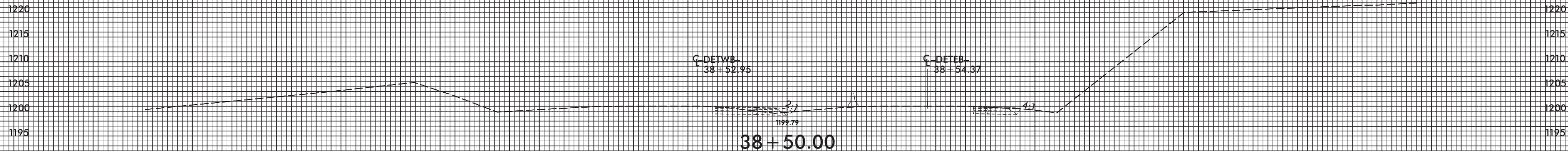
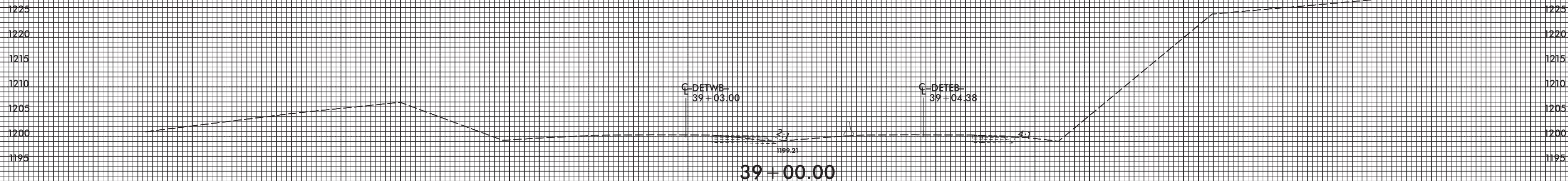

DETOUR (BASED OFF OF -L-)

150 140 130 120 110 100 90 80 70 60 50 40 30 20 10 0 10 20 30 40 50 60 70 80 90 100 110 120 130 140 150

5/10/2017 13:58:56 \\s:\b4447_Rdy_xpl_DET.dgn

8/23/99

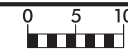

PROJ. REFERENCE NO.
B-4447

SHEET NO.
X-35

150 140 130 120 110 100 90 80 70 60 50 40 30 20 10 0 10 20 30 40 50 60 70 80 90 100 110 120 130 140 150

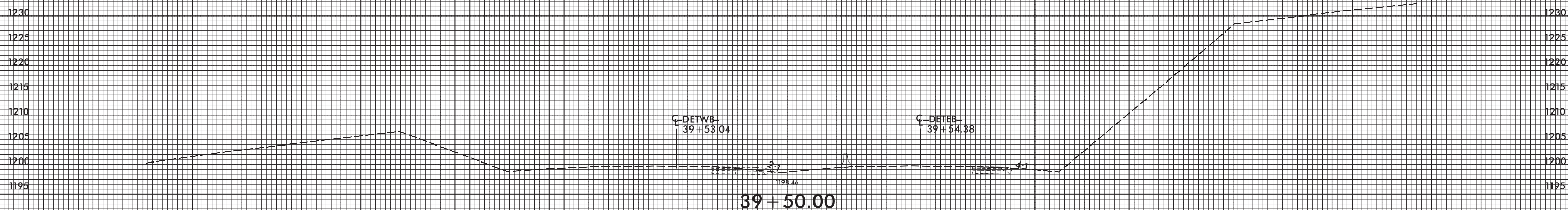
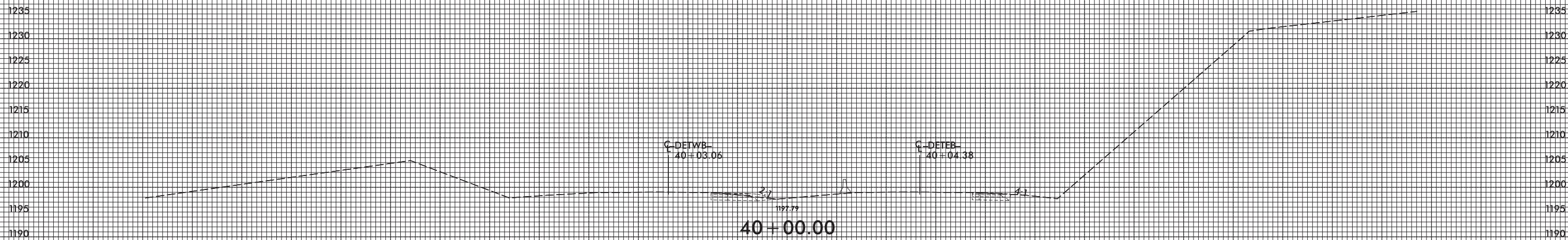
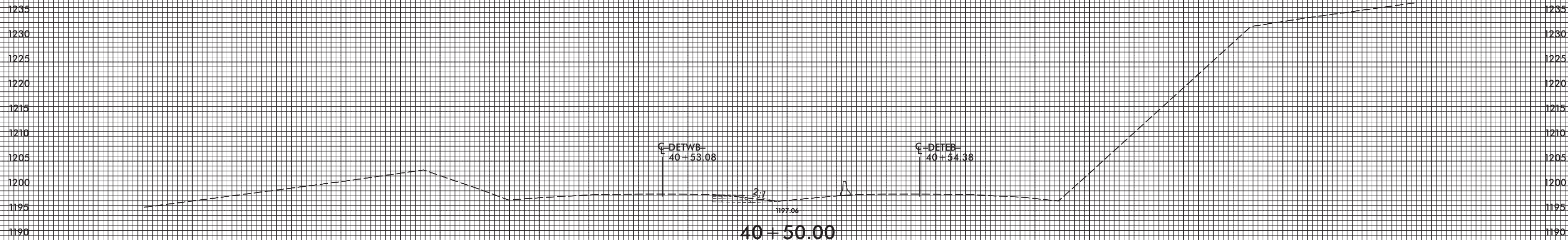

DETOUR (BASED OFF OF -L-)

150 140 130 120 110 100 90 80 70 60 50 40 30 20 10 0 10 20 30 40 50 60 70 80 90 100 110 120 130 140 150

5/10/2017 13:58:56 \\s:\b4447-Rdy-xpl_DET.dgn

8/23/99

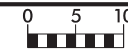

PROJ. REFERENCE NO.
B-4447

SHEET NO.
X-36

150 140 130 120 110 100 90 80 70 60 50 40 30 20 10 0 10 20 30 40 50 60 70 80 90 100 110 120 130 140 150

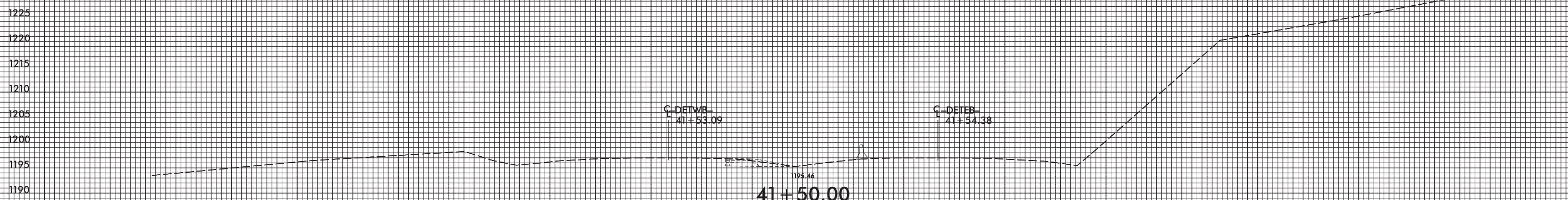
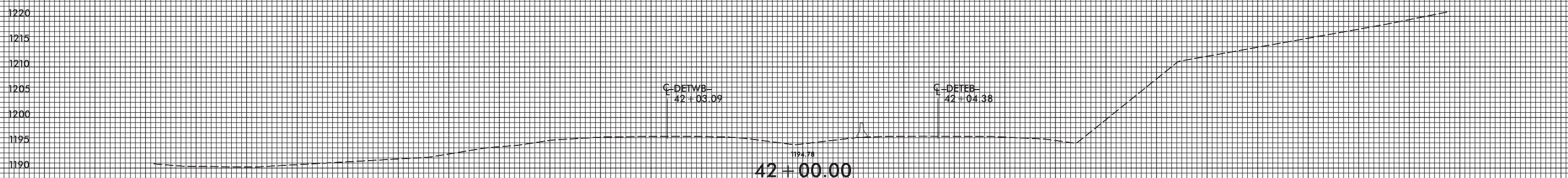

DETOUR (BASED OFF OF -L-)

150 140 130 120 110 100 90 80 70 60 50 40 30 20 10 0 10 20 30 40 50 60 70 80 90 100 110 120 130 140 150

5/10/2017 13:58:56 B4447-Rdy-xpl_DET.dgn