

**This electronic collection of documents is provided  
for the convenience of the user  
and is Not a Certified Document –**

**The documents contained herein were originally issued  
and sealed by the individuals whose names and license  
numbers appear on each page, on the dates appearing  
with their signature on that page.**

**This file or an individual page  
shall not be considered a certified document.**

T.I.P.: R-3100A

CONTRACT: C203800

**STATE OF NORTH CAROLINA  
DEPARTMENT OF TRANSPORTATION**

**SIGNING PLAN  
CATAWBA COUNTY**

**LOCATION: NC 16 FROM NORTH OF SR 1814 (CALDWELL ROAD) TO SR 1895 (TOWER ROAD)**

<small>TIP NO.</small> R-3100A	<small>SHEET NO.</small> SIGN-1
<small>DocuSigned by:</small> <i>Betsy L. Watson</i> <small>35E978B34F8743F</small>	
<small>APPROVED:</small>	
<small>DATE:</small> 9/5/2016	
	
<b>DOCUMENT NOT CONSIDERED FINAL UNLESS ALL SIGNATURES COMPLETED</b>	

**ROADWAY STANDARD DRAWINGS**

THE FOLLOWING ROADWAY STANDARDS AS APPEAR IN "ROADWAY STANDARD DRAWINGS" - PROJECT SERVICES UNIT - N.C. DEPARTMENT OF TRANSPORTATION - RALEIGH, N.C., DATED JANUARY 2012 ARE APPLICABLE TO THIS PROJECT AND BY REFERENCE HEREBY ARE CONSIDERED A PART OF THESE PLANS:

<u>STD. NO.</u>	<u>TITLE</u>
904.10	ORIENTATION OF GROUND MOUNTED SIGNS
904.50	MOUNTING OF TYPE 'D', 'E' AND 'F' SIGNS ON 'U' CHANNEL POSTS
1264.01	OBJECT MARKERS - TYPES
1264.02	OBJECT MARKERS - INSTALLATION

**GENERAL NOTES**

- . SIGNS FURNISHED BY STATE.
- . CONFIRM IN WRITING AT LEAST 4 MONTHS IN ADVANCE, THE ACTUAL DATE THE DEPARTMENT FURNISHED SIGNS WILL BE REQUIRED.
- . ALL TYPE 'D' SIGNS SHALL BE MOUNTED ON TWO U-CHANNEL POSTS UNLESS OTHERWISE INDICATED ON THE PLANS.
- . IF REMOVAL OR RELOCATION OF SIGNS ON PRIVATE STREET (NON-STATE MAINTAINED) IS REQUIRED DUE TO CONSTRUCTION, THE CONTRACTOR SHALL INFORM THE ENGINEER. THE WORK WILL BE COMPLETED BY OTHERS.
- . WHEN NOT STATIONED OR DIMENSIONED ON PLANS, ALL 'E' AND 'F' SIGNS SHALL BE FIELD LOCATED BY THE ENGINEER.
- . ALL EXISTING SIGNS ON "U" CHANNEL POST WITHIN THE PROJECT LIMITS SHALL BE REMOVED AND DISPOSED OF UNLESS OTHERWISE NOTED ON PLANS.
- . WHEN EXISTING SIGNS ARE REMOVED AND INSTALLED ON NEW SUPPORTS, THE RE-ERECTION SHALL IMMEDIATELY FOLLOW THE REMOVAL.
- . THE BACKGROUND FOR TYPE E & F SIGNS SHALL BE TYPE C REFLECTIVE SHEETING.
- . SEE ROADWAY PLANS FOR GUARD/GUIDE RAIL DETAILS.

**SUMMARY OF QUANTITIES**

ITEM NO.		ITEM DESCRIPTION	QUANTITY	UNIT
DESC. NO.	SECT. NO.			
4072000000	903	SUPPORTS, 3-LB STEEL U-CHANNEL.....	3430	L.F.
4096000000	904	SIGN ERECTION, TYPE D.....	7	EA.
4102000000	904	SIGN ERECTION, TYPE E.....	155	EA.
4108000000	904	SIGN ERECTION, TYPE F.....	29	EA.
4116100000	904	SIGN ERECTION, RELOCATE, TYPE E.....	2	EA.
4155000000	907	DISPOSAL OF SIGN SYSTEM, U-CHANNEL.....	87	EA.
4158000000	907	DISPOSAL OF SIGN SYSTEM, WOOD.....	1	EA.
4192000000	907	DISPOSAL OF SUPPORT, U-CHANNEL.....	2	EA.
4915000000	1264	7' U-CHANNEL POSTS.....	6	EA.
4955000000	1264	OBJECT MARKERS (END OF ROAD).....	6	EA.

**INDEX**

<u>SHEET NO.</u>	<u>DESCRIPTION</u>
SIGN-1	TITLE SHEET
SIGN-2-2A	TYPE 'D' SIGNS
SIGN-3	TYPE 'E' SIGNS
SIGN-3A	TYPE 'F' SIGNS
SIGN-4-19	SIGNING PLAN SHEETS

**PLAN REVIEWED BY: N.C.D.O.T. SIGNING AND DELINEATION UNIT**

**KELVIN JORDAN** SIGNING & DELINEATION REGIONAL ENGINEER  
**DERRICK BEARD** SIGNING & DELINEATION PROJECT DESIGN ENGINEER

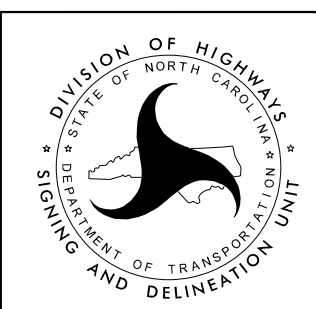

**PLAN PREPARED BY:**

**BETSY L. WATSON, P.E.** TRAFFIC ENGINEER  
**ROSI R. HENNEIN** TRANSPORTATION DESIGNER



Stantec Consulting Services Inc.  
801 Jones Franklin Road  
Suite 300  
Raleigh, NC 27605  
Tel. (919) 851-6866  
Fax. (919) 851-7024  
www.stantec.com  
License No. F-0672

APPROVED: *Betsy L. Watson*  
35E678B34F9743F

DATE: 9/5/2016

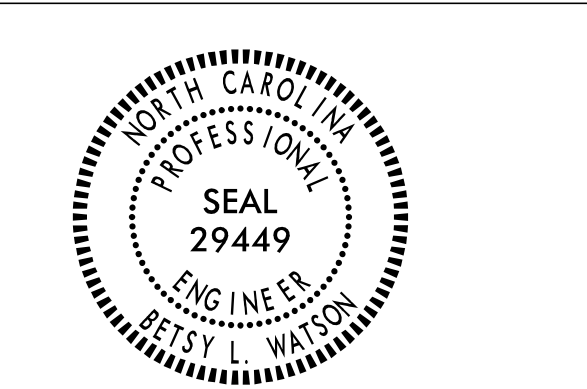

DOCUMENT NOT CONSIDERED FINAL UNLESS ALL SIGNATURES COMPLETED



SIGN NUMBER: 301 TYPE: D QUANTITY: 1 SIGN WIDTH: 24" HEIGHT: 18" TOTAL AREA: 3.0 Sq.Ft. BORDER TYPE: FLUSH RADIUS: 3" WIDTH: 0.5" RECESS: 0" NO. Z BARS: LENGTH:	BACKG COLOR: Green COPY COLOR: White	DESIGN BY: RRH PROJECT ID: R-3100A	CHECKED BY: BLW DIV: 12	DATE: Mar 04, 2016
---	---	---------------------------------------	----------------------------	--------------------

SYMBOL	X	Y	WID	HT
AR_Type D	10.3	28.8	5	7.5
AR_Type D	6	8.2	5	7.5

MOUNT ON ONE U-POST

Spacing Factor is 1 unless specified otherwise

Letter positions												Series/Size Text Length
Letter spacings are to start of next letter												
4.9	1.5	1.8	0.7	1.4	2	2	1.7	1.4	1.7	4.9		14.2
2.9	1.9	1.6	1.7	1.6	1.5	1.8	1.6	1.4	2	1.5	1.7	18.2
1.2	1.5	1.6	1.8	1.8	1.6	1.6	0.6	1.1	1.3	2	1.6	21.6
6.5	1.8	0.6	1.5	0.7	1.7	1.6	1.7	1.4	6.5			11
2.1	0.8	0.9	0.7	0.9	1	0.8	0.8	1	0.9	0.7	1	19.8
9.1	1	0.8	0.9	0.6	0.9	0.5	0.5	0.7	9.1			5.7

SIGN NUMBER: 302 TYPE: D QUANTITY: 1 SIGN WIDTH: 78" HEIGHT: 42" TOTAL AREA: 22.8 Sq.Ft. BORDER TYPE: FLUSH RADIUS: 3" WIDTH: 0.75" RECESS: 0" NO. Z BARS: LENGTH:	BACKG COLOR: Green COPY COLOR: White	DESIGN BY: RRH PROJECT ID: R-3100A	CHECKED BY: BLW DIV: 12	DATE: Mar 04, 2016
---	---	---------------------------------------	----------------------------	--------------------

SYMBOL	X	Y	WID	HT
AR_Type D	10.3	28.8	5	7.5
AR_Type D	6	8.2	5	7.5

MOUNT ON TWO U-POSTS

Spacing Factor is 1 unless specified otherwise

Letter positions												Series/Size Text Length
Letter spacings are to start of next letter												
32.5	3.8	5	4.6	4.1	4.7	3.4	20					25.6
22.8	4.6	1.9	4.5	3.4	5	4.2	4.5	4.5	4.7	3.1	10.3	44.9
25.7	5.1	2	3.9	3.1	5	4.5	4.3	3.9	4	3.5	13.1	39.2
18.5	5.1	2	4.5	4.5	3.9	3.1	5	4.2	4.5	4.5	4.7	53.5

SIGN NUMBER: 303 TYPE: D QUANTITY: 1 SIGN WIDTH: 96" HEIGHT: 36" TOTAL AREA: 24.0 Sq.Ft. BORDER TYPE: FLUSH RADIUS: 3" WIDTH: 1" RECESS: 0" NO. Z BARS: LENGTH:	BACKG COLOR: Brown COPY COLOR: White	DESIGN BY: RRH PROJECT ID: R-3100A	CHECKED BY: BLW DIV: 12	DATE: Mar 04, 2016
--	---	---------------------------------------	----------------------------	--------------------

SYMBOL	X	Y	WID	HT
AR_Type D	7.2	14	8	12

MOUNT ON TWO U-POSTS

Spacing Factor is 1 unless specified otherwise

Letter positions												Series/Size Text Length
Letter spacings are to start of next letter												
26.2	7.9	6.3	4	3.6	5.4	6.5	2.1	3.8	8	8	2.9	62.6
27.4	7.2	2.4	4.1	3.8	6.2	4	2.6	4.7	8	6.6	2.2	60.2

SIGN NUMBER: 304 TYPE: D QUANTITY: 1 SIGN WIDTH: 78" HEIGHT: 42" TOTAL AREA: 22.8 Sq.Ft. BORDER TYPE: FLUSH RADIUS: 3" WIDTH: 0.75" RECESS: 0" NO. Z BARS: LENGTH:	BACKG COLOR: Green COPY COLOR: White	DESIGN BY: RRH PROJECT ID: R-3100A	CHECKED BY: BLW DIV: 12	DATE: Mar 04, 2016
---	---	---------------------------------------	----------------------------	--------------------

SYMBOL	X	Y	WID	HT
AR_Type D	60.2	28.8	5	7.5
AR_Type D	64.5	8.2	5	7.5

MOUNT ON TWO U-POSTS

Spacing Factor is 1 unless specified otherwise

Letter positions												Series/Size Text Length
Letter spacings are to start of next letter												
20	3.8	5	4.6	4.1	4.7	3.4	32.5					25.6
10.3	4.6	1.9	4.5	3.4	5	4.2	4.5	4.5	4.7	3.1	22.8	44.9
13.1	5.1	2	3.8	3.1	5	4.5	4.3	4	3.9	3.5	25.7	39.2
6	5.1	2	4.5	4.5	3.8	3.1	5	4.2	4.5	4.5	4.7	53.5

\$\$\$\$\$SYTIME\$\$\$\$\$  
\$\$\$\$\$DGN\$\$\$\$\$  
\$\$\$\$\$USER\$\$\$\$\$

SIGN NUMBER: 305  
 TYPE: D  
 QUANTITY: 1  
 SIGN WIDTH: 96"  
 HEIGHT: 36"  
 TOTAL AREA: 24.0 Sq.Ft.  
 BORDER TYPE: FLUSH  
 RADII: 3"  
 WIDTH: 1"  
 RECESS: 0"  
 NO. Z BARS:  
 LENGTH:

BACKG COLOR: Brown  
 COPY COLOR: White

SYMBOL	X	Y	WID	HT
AR_Type D	76.8	14	8	12

MAT'L: 0.125" (3.2MM) ALUMINUM

DESIGN BY: RRH  
 PROJECT ID: R-3100A  
 CHECKED BY: BLW  
 DIV: 12  
 DATE: Mar 04, 2016

BORDER R=3" TH=1"  
 MOUNT ON TWO U-POSTS

USE NOTES  
 1. Legend and border (except those that are colored black) shall be direct applied Grade C sheeting.  
 2. Background shall be Grade C reflective sheeting.

LETTER POSITIONS

Letter spacings are to start of next letter

M	u	r	r	a	y	'	s	M	i	l	l	Series/Size Text Length				
7.2	7.9	6.3	4	3.6	5.4	6.5	2.1	3.8	8	2.9	2.9	1.3	26.2	D 2000	62.6	
H	i	s	t	o	r	i	c	S	i	t	e	Series/Size Text Length				
8.4	7.2	2.4	4.1	3.8	6.2	4	2.6	4.7	8	6.6	2.2	3.8	4.7	27.4	D 2000	60.2

Spacing Factor is 1 unless specified otherwise

SIGN NUMBER: 306  
 TYPE: D  
 QUANTITY: 1  
 SIGN WIDTH: 72"  
 HEIGHT: 42"  
 TOTAL AREA: 21.0 Sq.Ft.  
 BORDER TYPE: FLUSH  
 RADII: 3"  
 WIDTH: 1"  
 RECESS: 0"  
 NO. Z BARS:  
 LENGTH:

BACKG COLOR: Green  
 COPY COLOR: White

SYMBOL	X	Y	WID	HT
AR_Type D	6.6	25.3	8	12
AR_Type D	9.3	6.7	8	12

MAT'L: 0.125" (3.2MM) ALUMINUM

DESIGN BY: RRH  
 PROJECT ID: R-3100A  
 CHECKED BY: BLW  
 DIV: 12  
 DATE: Mar 04, 2016

BORDER R=3" TH=1"  
 MOUNT ON TWO U-POSTS

USE NOTES  
 1. Legend and border (except those that are colored black) shall be direct applied Grade C sheeting.  
 2. Background shall be Grade C reflective sheeting.

LETTER POSITIONS

Letter spacings are to start of next letter

C	h	a	r	l	o	t	t	e	Series/Size Text Length			
22.6	7	5.8	6.1	4	2.6	5.4	3.4	3.8	4.7	6.6	D 2000	42.8
D	e	n	v	e	r	Series/Size Text Length						
29.3	6.7	5.8	5.6	6.3	5.8	3	9.3	D 2000	33.4			

Spacing Factor is 1 unless specified otherwise

SIGN NUMBER: 307  
 TYPE: D  
 QUANTITY: 1  
 SIGN WIDTH: 72"  
 HEIGHT: 42"  
 TOTAL AREA: 21.0 Sq.Ft.  
 BORDER TYPE: FLUSH  
 RADII: 3"  
 WIDTH: 1"  
 RECESS: 0"  
 NO. Z BARS:  
 LENGTH:

BACKG COLOR: Green  
 COPY COLOR: White

SYMBOL	X	Y	WID	HT
AR_Type D	8.2	25.3	8	12
AR_Type D	50.7	6.7	8	12

MAT'L: 0.125" (3.2MM) ALUMINUM

DESIGN BY: RRH  
 PROJECT ID: R-3100A  
 CHECKED BY: BLW  
 DIV: 12  
 DATE: Mar 04, 2016

BORDER R=3" TH=1"  
 MOUNT ON TWO U-POSTS

USE NOTES  
 1. Legend and border (except those that are colored black) shall be direct applied Grade C sheeting.  
 2. Background shall be Grade C reflective sheeting.

LETTER POSITIONS

Letter spacings are to start of next letter

C	o	n	o	v	e	r	Series/Size Text Length			
24.2	6.7	6.2	5.9	5.5	6.3	5.8	3	8.2	D 2000	39.5
D	e	n	v	e	r	Series/Size Text Length				
9.3	6.7	5.8	5.6	6.3	5.8	3	29.3	D 2000	33.4	

Spacing Factor is 1 unless specified otherwise

TIP NO. R-3100A SHEET NO. SIGN-2A

APPROVED: *Betsy L. Watson*  
 DATE: 9/5/2016

SEAL

DOCUMENT NOT CONSIDERED FINAL  
 UNLESS ALL SIGNATURES COMPLETED

\$\$\$\$\$SYTIME\$\$\$\$\$  
 \$\$\$\$\$\$DGN\$\$\$\$\$  
 \$\$\$\$\$\$USERNAME\$\$\$\$\$

TYPE 'D' SIGNS

APPROVED: *Betsy J. Watson*  
DATE: 9/5/2016

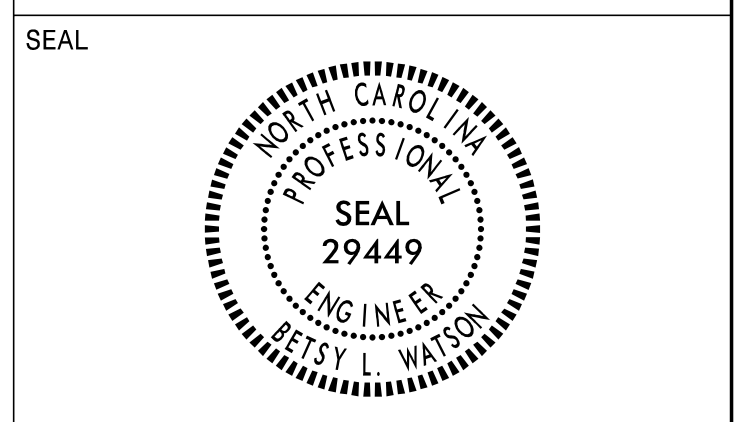

DOCUMENT NOT CONSIDERED FINAL  
UNLESS ALL SIGNATURES COMPLETED



401 QUANTITY REQ'D 9



30 X 36  
R2-1

ONE "U" POST PER SIGN

406 QUANTITY REQ'D 14

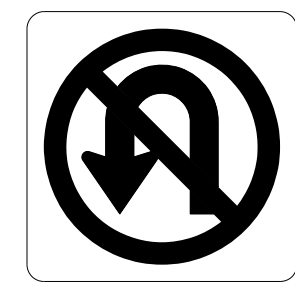

36 X 36  
R3-4

ONE "U" POST PER SIGN

411 QUANTITY REQ'D 12



54 X 18  
R6-1R

TWO "U" POSTS PER SIGN

416 QUANTITY REQ'D 6

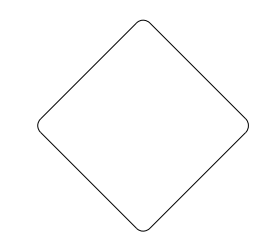

18 X 18  
OM4-3

ONE "U" POST PER SIGN

402 QUANTITY REQ'D 4



24 X 30  
R2-1

ONE "U" POST PER SIGN

407 QUANTITY REQ'D 19



36 X 36  
R5-1

ONE "U" POST PER SIGN

412 QUANTITY REQ'D 6



54 X 18  
R6-1L

TWO "U" POSTS PER SIGN

417 QUANTITY REQ'D 12



36 X 12  
R6-1R

MOUNT ABOVE SIGN 418  
IN 12 INSTALLATIONS

403 QUANTITY REQ'D 1

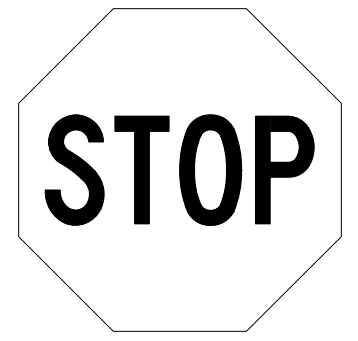

36 X 36  
R1-1

ONE "U" POST PER SIGN

408 QUANTITY REQ'D 7

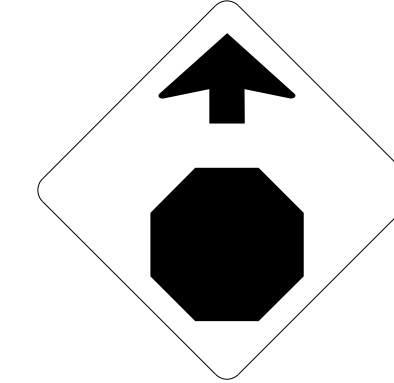

36 X 36  
W3-1

ONE "U" POST PER SIGN

413 QUANTITY REQ'D 18



42 X 30  
R5-1a

ONE "U" POST PER SIGN

418 QUANTITY REQ'D 12

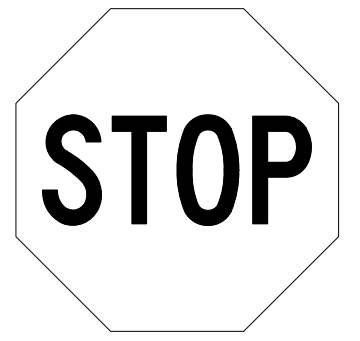

36 X 36  
R1-1

TWO "U" POST PER SIGN

404 QUANTITY REQ'D 3



36 X 36  
W14-2

ONE "U" POST PER SIGN

409 QUANTITY REQ'D 1

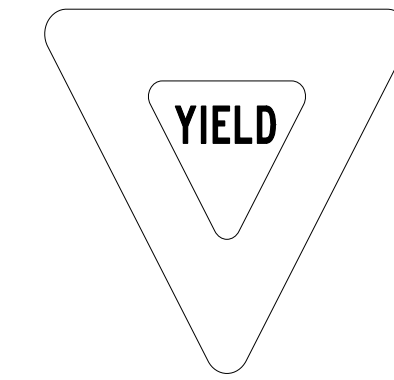

36 X 36 X 36  
R1-2

ONE "U" POST PER SIGN

414 QUANTITY REQ'D 6

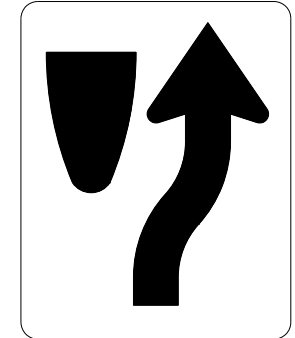

24 X 30  
R4-7

ONE "U" POST PER SIGN

419 QUANTITY REQ'D 4

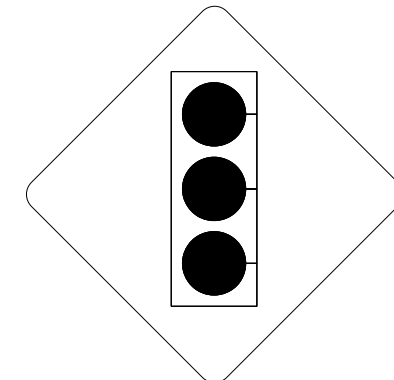

36 X 36  
W3-3

ONE "U" POST PER SIGN

405 QUANTITY REQ'D 1

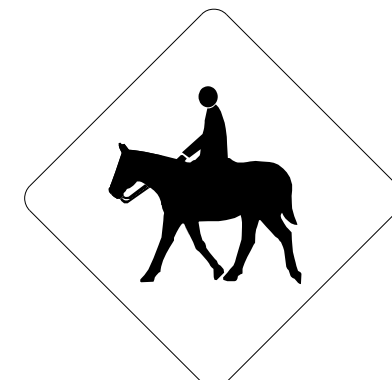

30 X 30  
W11-7

ONE "U" POST PER SIGN

410 QUANTITY REQ'D 18

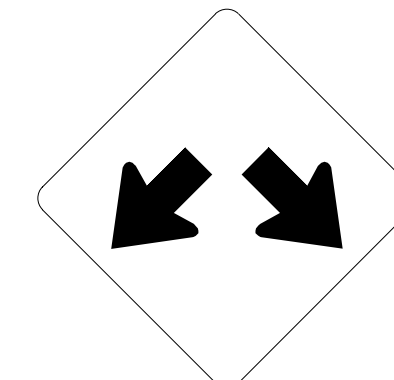

30 X 30  
W12-1

ONE "U" POST PER SIGN

415 QUANTITY REQ'D 6

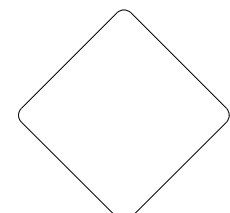

18 X 18  
OM1-3

MOUNT BELOW SIGN 414  
IN 6 INSTALLATIONS

420 QUANTITY REQ'D 2

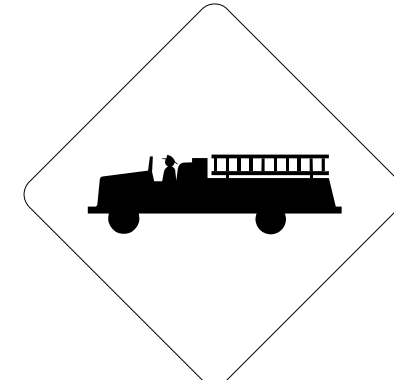

36 X 36  
W11-8

ONE "U" POST PER SIGN

\$\$\$\$\$SYSTEMTIME\$\$\$\$\$  
\$\$\$\$\$DGN\$\$\$\$\$  
\$\$\$\$\$USERNAME\$\$\$\$\$

TYPE 'E' SIGNS

APPROVED: Betsy L. Watson, 9/5/2016



DOCUMENT NOT CONSIDERED FINAL UNLESS ALL SIGNATURES COMPLETED



501 505 507 515 519

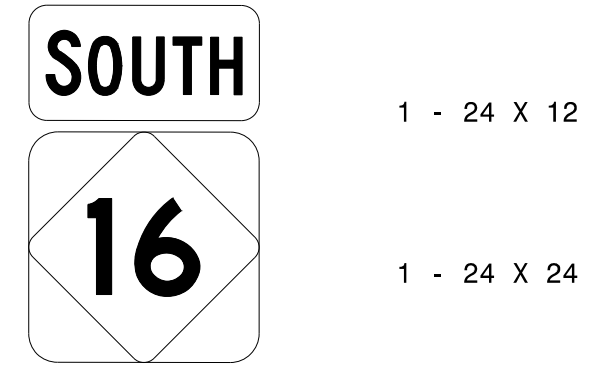

ONE "U" POST PER SIGN

510

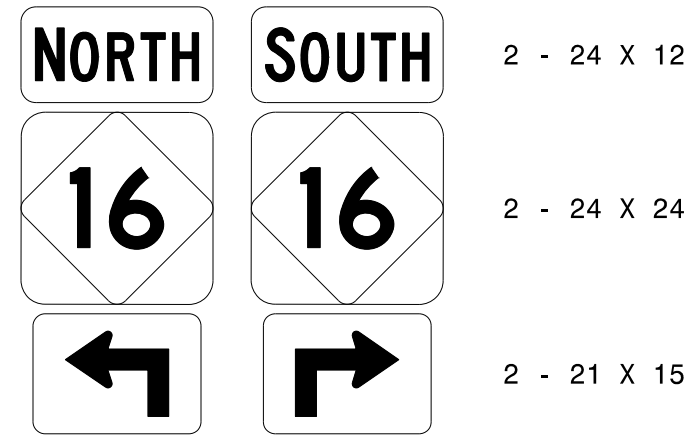

TWO "U" POSTS PER SIGN

523

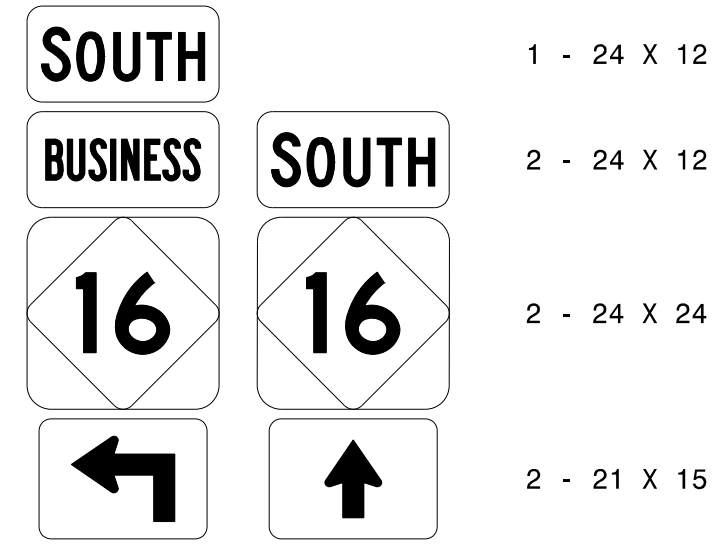

TWO "U" POSTS PER SIGN

502 516 520 528

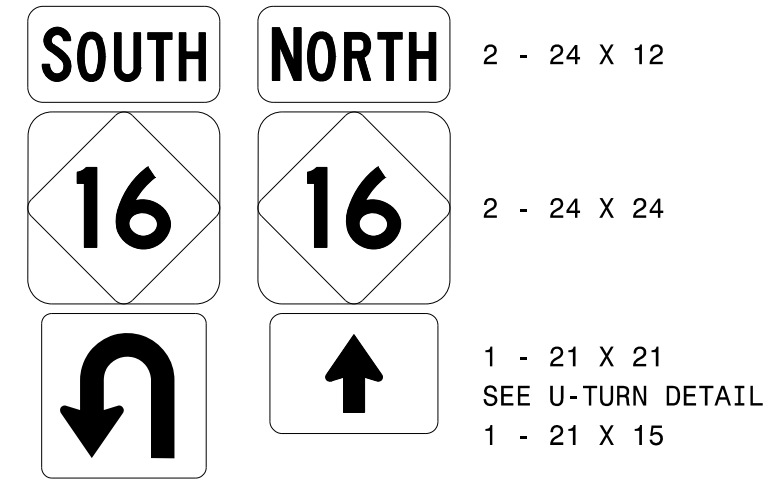

TWO "U" POSTS PER SIGN

511

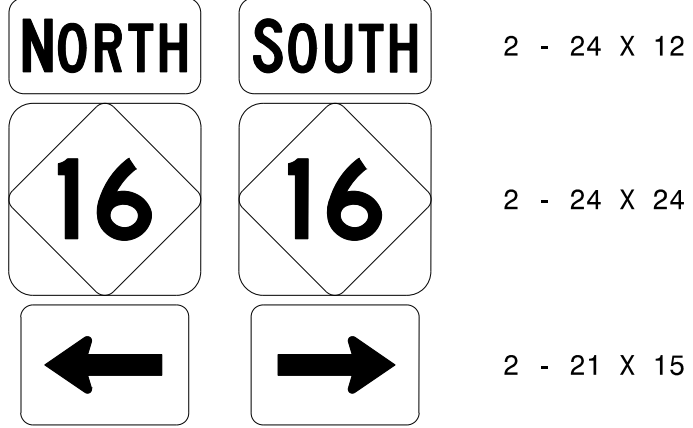

TWO "U" POSTS PER SIGN

524

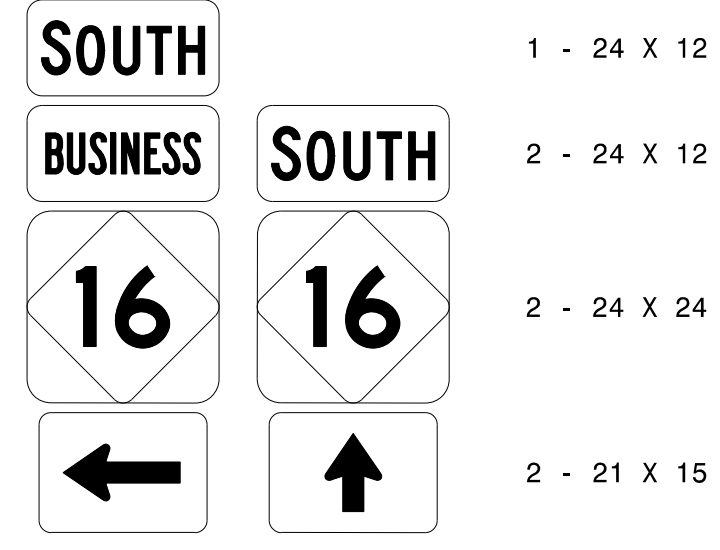

MOUNT BELOW SIGN 306 IN 1 INSTALLATION

503 506 508 517 521 529

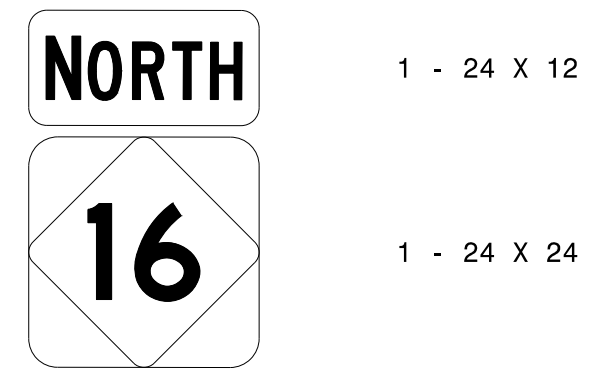

ONE "U" POST PER SIGN

513

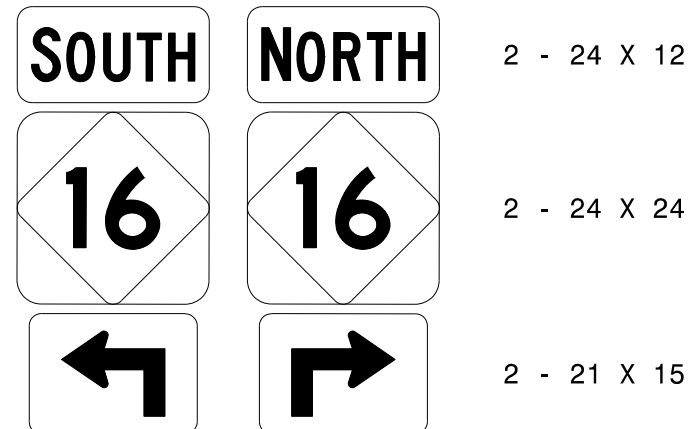

TWO "U" POSTS PER SIGN

526

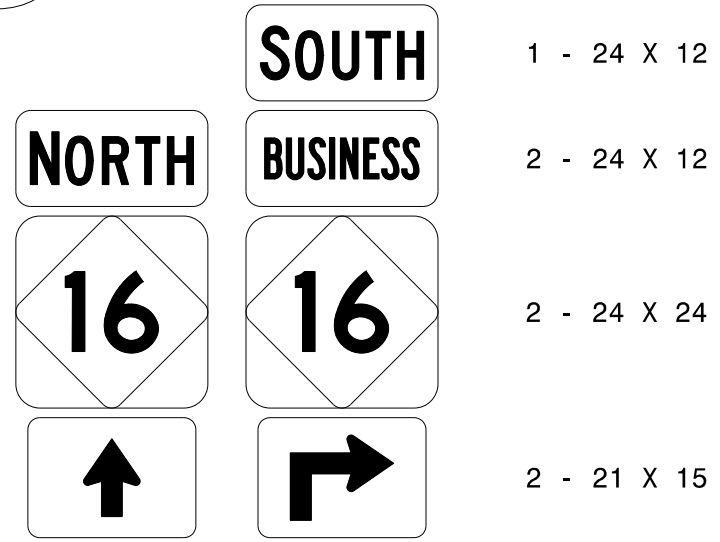

TWO "U" POSTS PER SIGN

504 518

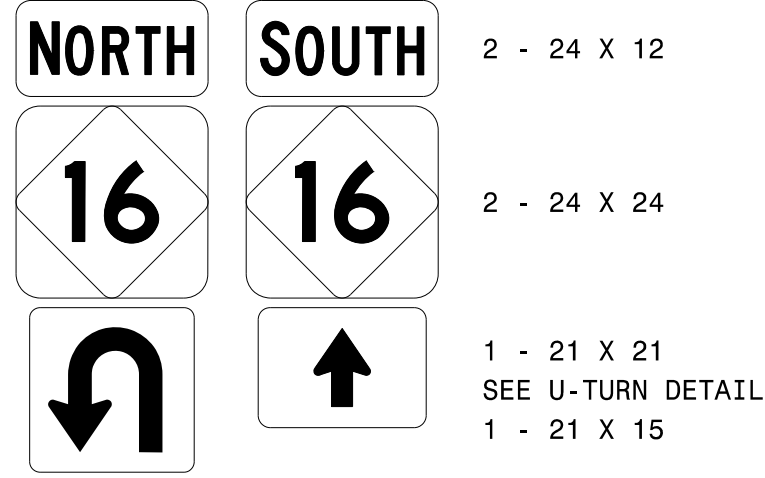

TWO "U" POSTS PER SIGN

514

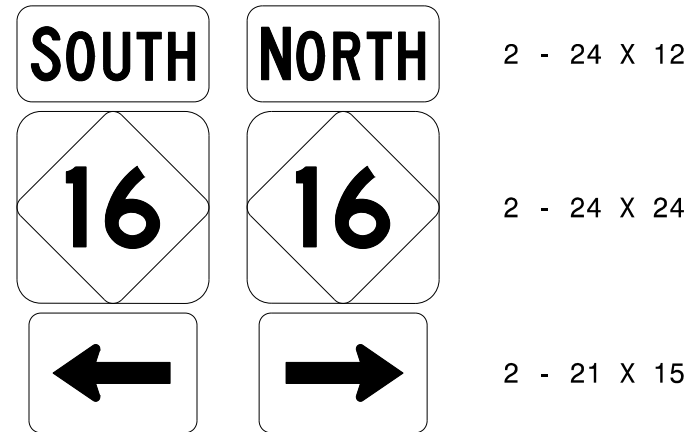

TWO "U" POSTS PER SIGN

527

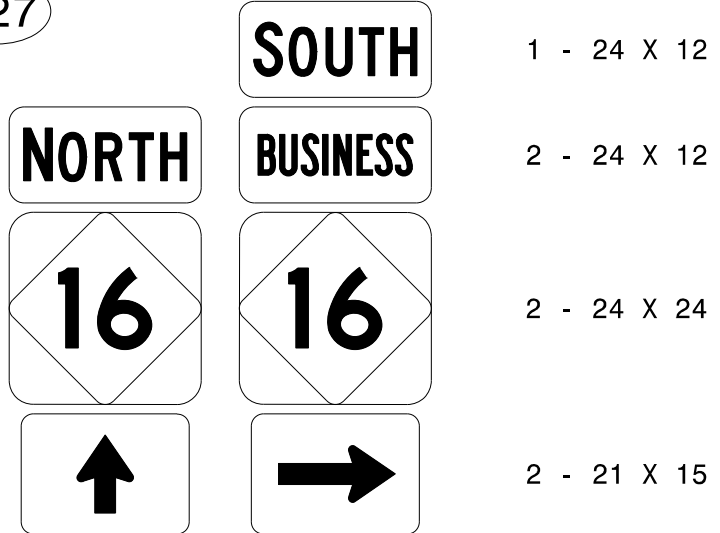

TWO "U" POSTS PER SIGN

509 512

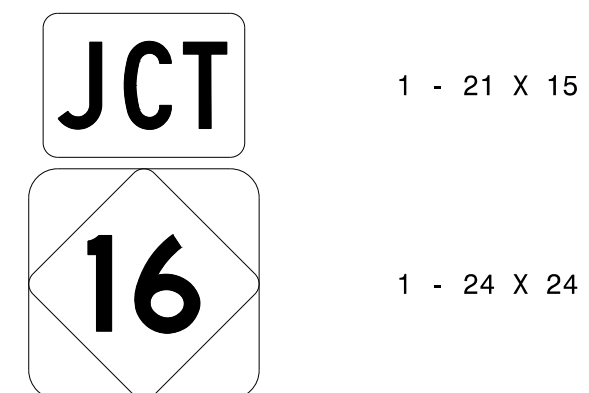

ONE "U" POST PER SIGN

522 525

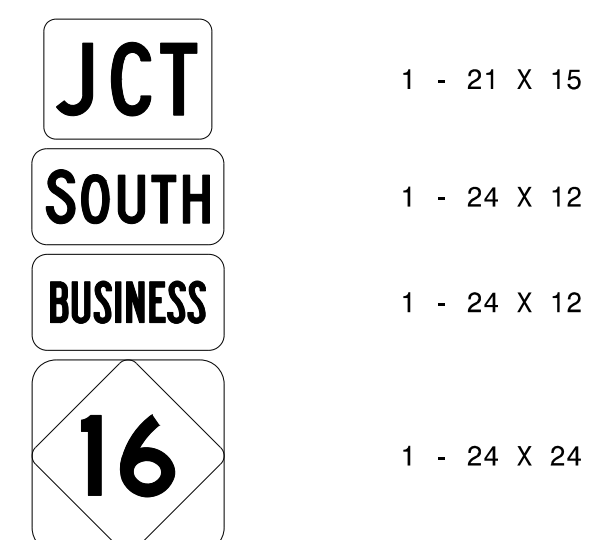

ONE "U" POST PER SIGN

Table with sign specifications: SIGN NUMBER, TYPE, QUANTITY, SIGN WIDTH, HEIGHT, TOTAL AREA, BORDER TYPE, RADIUS, WIDTH, RECESS, NO. Z BARS, LENGTH, BACKG COLOR, COPY COLOR, SYMBOL, X, Y, WID, HT.

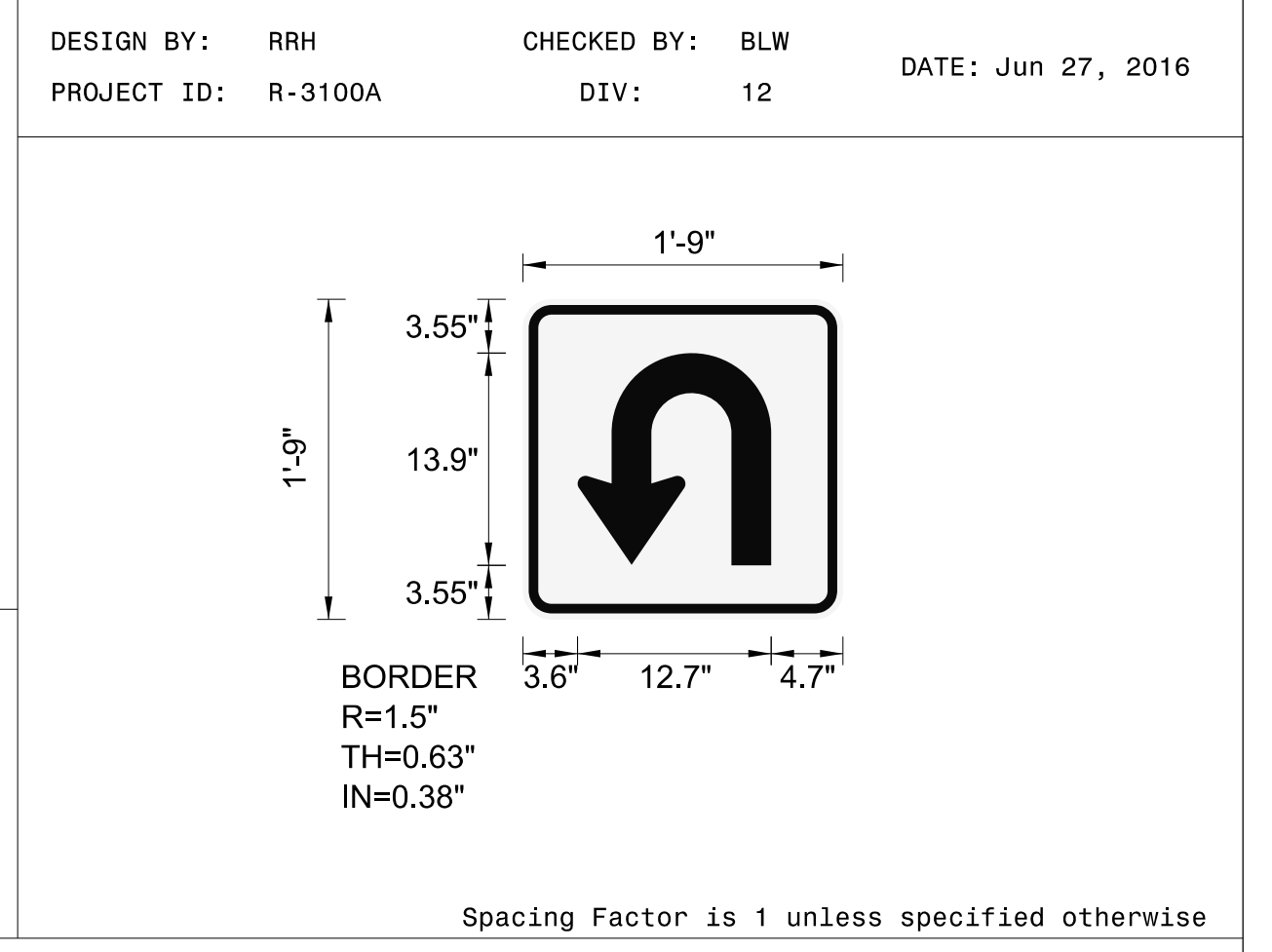



USE NOTES
1. Legend and border shall be direct applied non-reflective sheeting.
2. Background shall be Grade C reflective sheeting.

LETTER POSITIONS table with grid for spacing and alignment.

Vertical text on the left margin: SYSTEM TIME, DGN, USERNAME

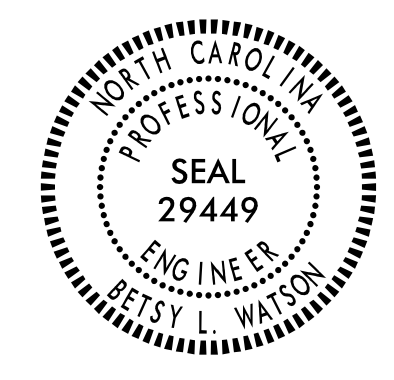
TYPE 'F' SIGNS

TIP NO. R-3100A	SHEET NO. SIGN-4
APPROVED: <i>Betsy L. Watson</i> <small>DocuSigned by: Betsy L. Watson 35E878B34F8743F</small>	
DATE: 9/5/2016	
SEAL 	
DOCUMENT NOT CONSIDERED FINAL UNLESS ALL SIGNATURES COMPLETED	
	

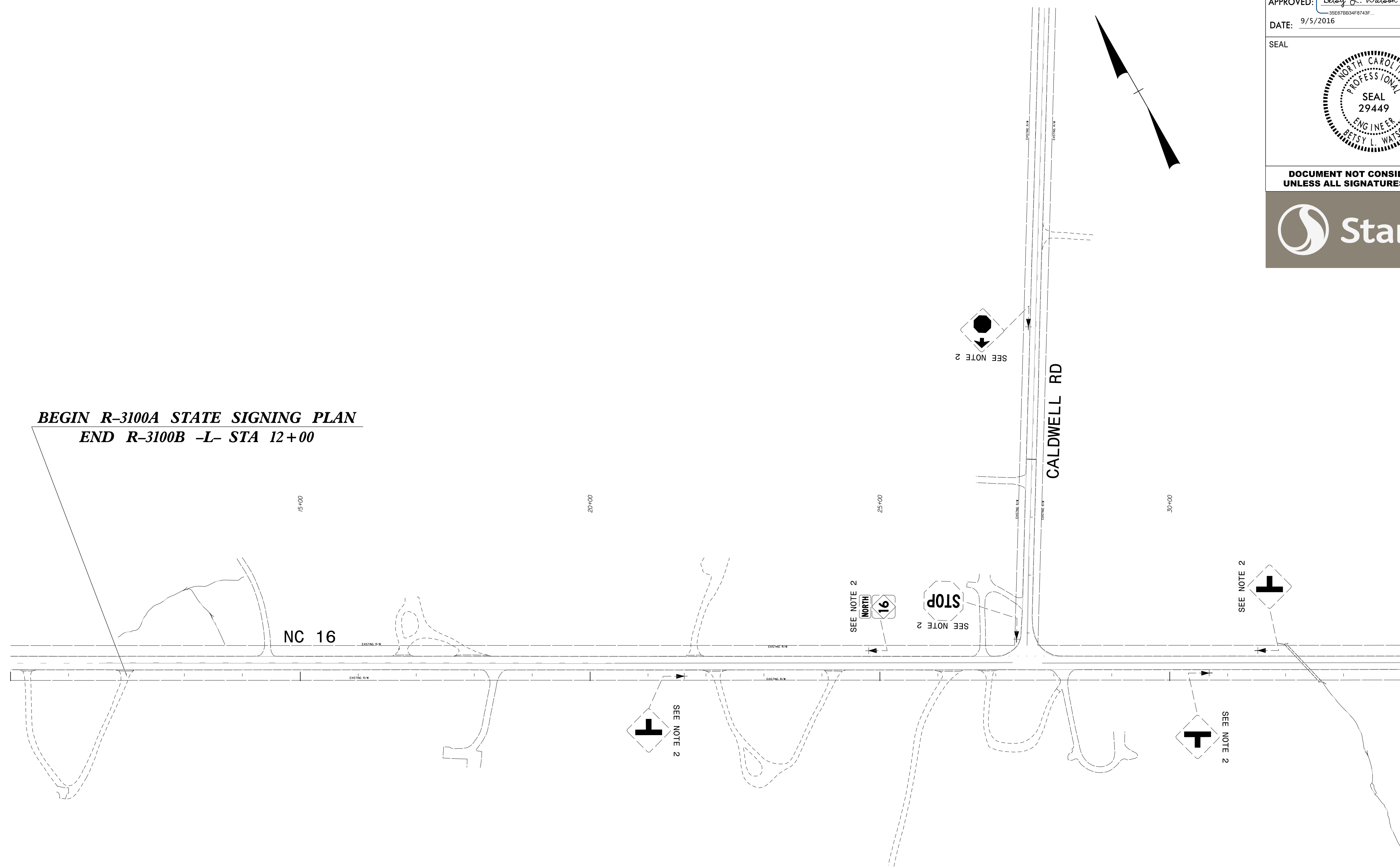



MATCHLINE -L- STA 34+00 SEE SHEET SIGN-5

**PROJECT NOTES**

- 1 SIGN ERECTION, RELOCATE TYPE E
- 2 DISPOSAL OF SIGN SYSTEM, U-CHANNEL
- 3 DISPOSAL OF SUPPORT, U-CHANNEL
- 4 DISPOSAL OF SIGN SYSTEM, WOOD

EXISTING SIGNING  
NC 16  
-L- STA 10+00 TO 34+00

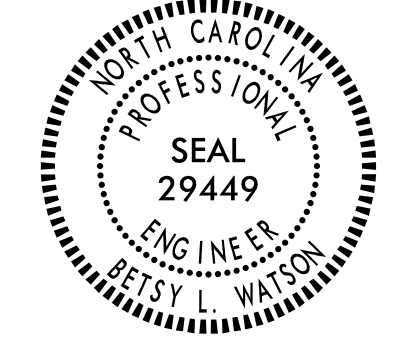
\$\$\$\$\$SYTIME\$\$\$\$\$  
\$\$\$\$\$DGN\$\$\$\$\$  
\$\$\$\$\$USERNAME\$\$\$\$\$

TIP NO. R-3100A	SHEET NO. SIGN-5
APPROVED: <i>Betsy L. Watson</i> SEAL 29449 DATE: 9/5/2016	
	
DOCUMENT NOT CONSIDERED FINAL UNLESS ALL SIGNATURES COMPLETED	
	

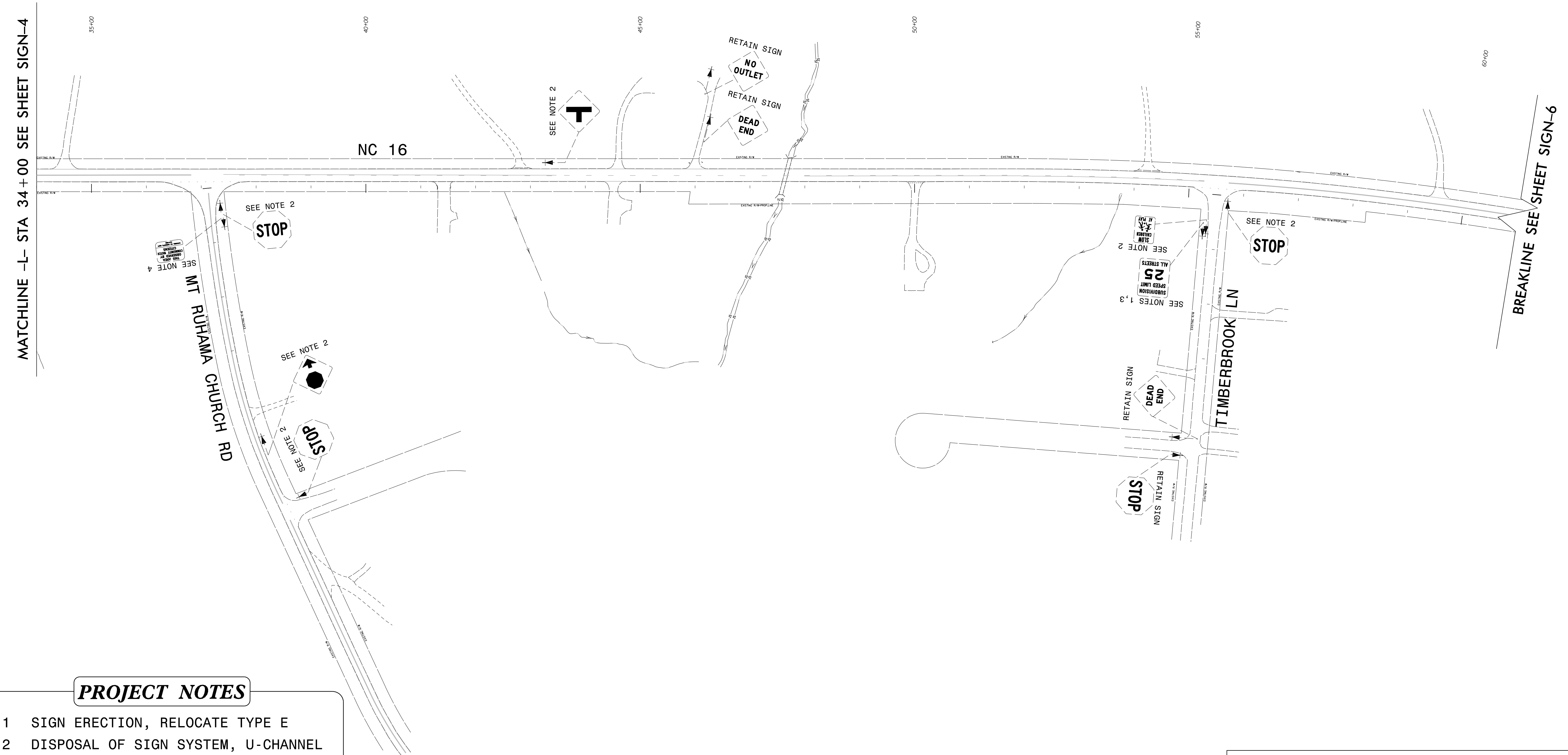
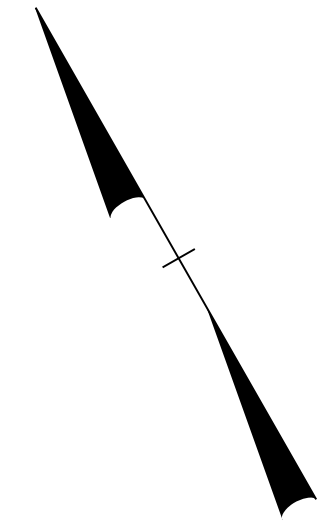



**PROJECT NOTES**

- 1 SIGN ERECTION, RELOCATE TYPE E
- 2 DISPOSAL OF SIGN SYSTEM, U-CHANNEL
- 3 DISPOSAL OF SUPPORT, U-CHANNEL
- 4 DISPOSAL OF SIGN SYSTEM, WOOD

EXISTING SIGNING  
NC 16  
-L- STA 34+00 TO 61+00

\$\$\$\$\$SYTIME\$\$\$\$\$  
\$\$\$\$\$DGN\$\$\$\$\$  
\$\$\$\$\$USERNAME\$\$\$\$\$

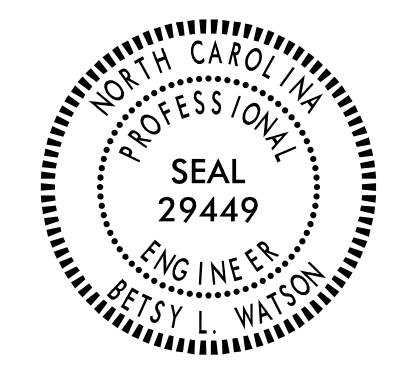

TIP NO. R-3100A	SHEET NO. SIGN-6
APPROVED: <i>Betsy L. Watson</i> <small>DocuSigned by: Betsy L. Watson 35E678B34F9743F</small>	
DATE: 9/5/2016	
SEAL	
	
<b>DOCUMENT NOT CONSIDERED FINAL UNLESS ALL SIGNATURES COMPLETED</b>	
	

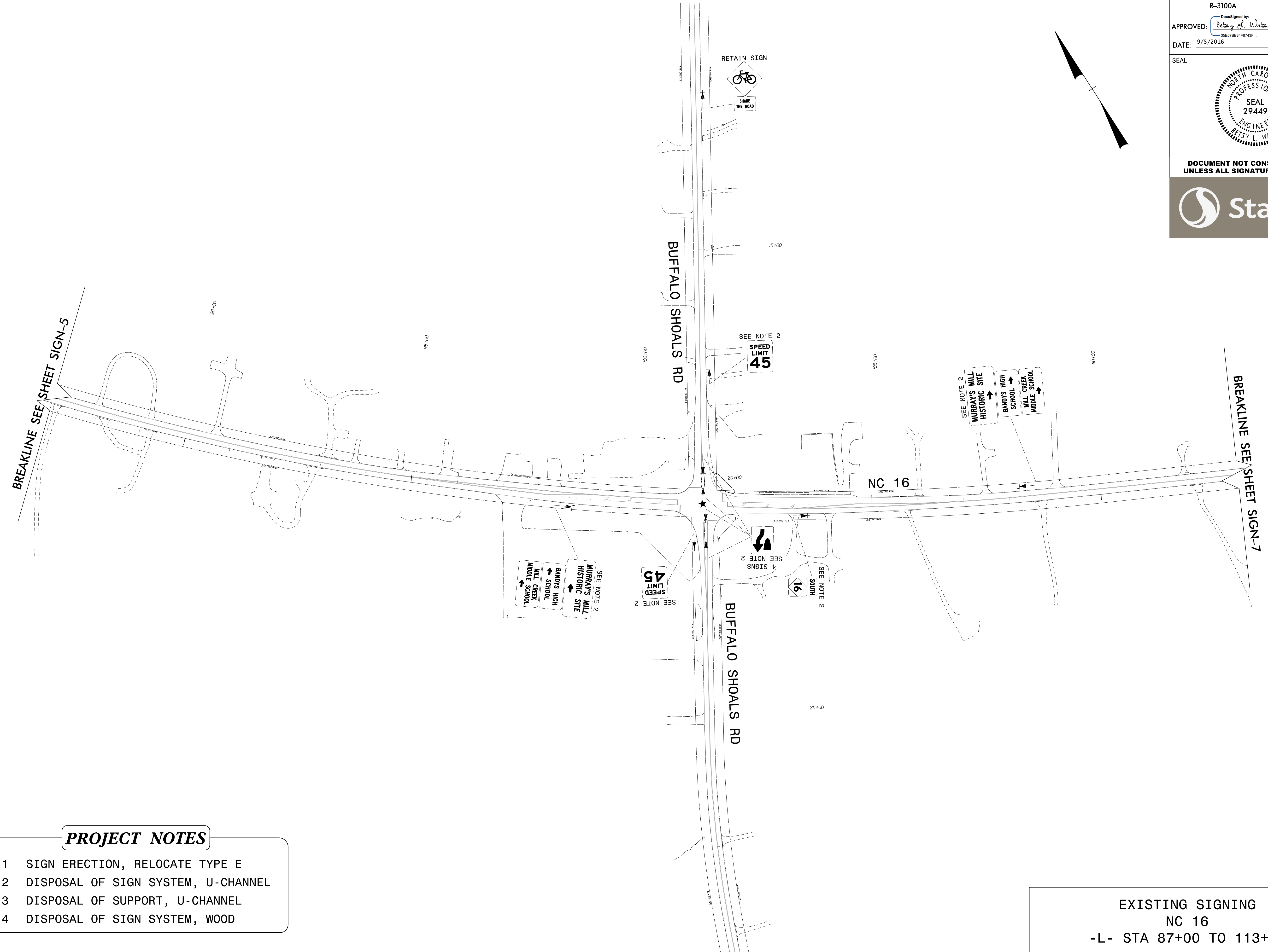
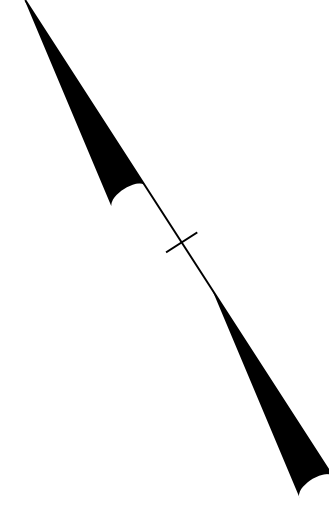



**PROJECT NOTES**

- 1 SIGN ERECTION, RELOCATE TYPE E
- 2 DISPOSAL OF SIGN SYSTEM, U-CHANNEL
- 3 DISPOSAL OF SUPPORT, U-CHANNEL
- 4 DISPOSAL OF SIGN SYSTEM, WOOD

EXISTING SIGNING  
 NC 16  
 -L- STA 87+00 TO 113+00

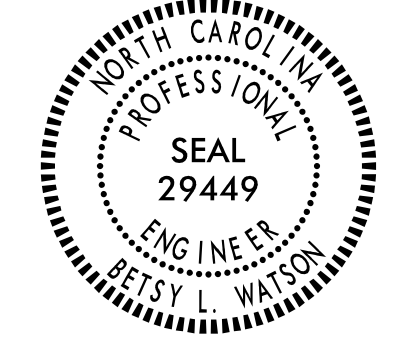
\$\$\$\$\$SYTIME\$\$\$\$\$  
 \$\$\$DDGN\$\$\$\$\$  
 \$\$\$USERNAME\$\$\$\$\$

TIP NO. R-3100A	SHEET NO. SIGN-7
APPROVED: <i>Betsy L. Watson</i> <small>DocuSigned by: Betsy L. Watson 35E878B34F8743F...</small>	
DATE: 9/5/2016	
SEAL	
	
DOCUMENT NOT CONSIDERED FINAL UNLESS ALL SIGNATURES COMPLETED	
	

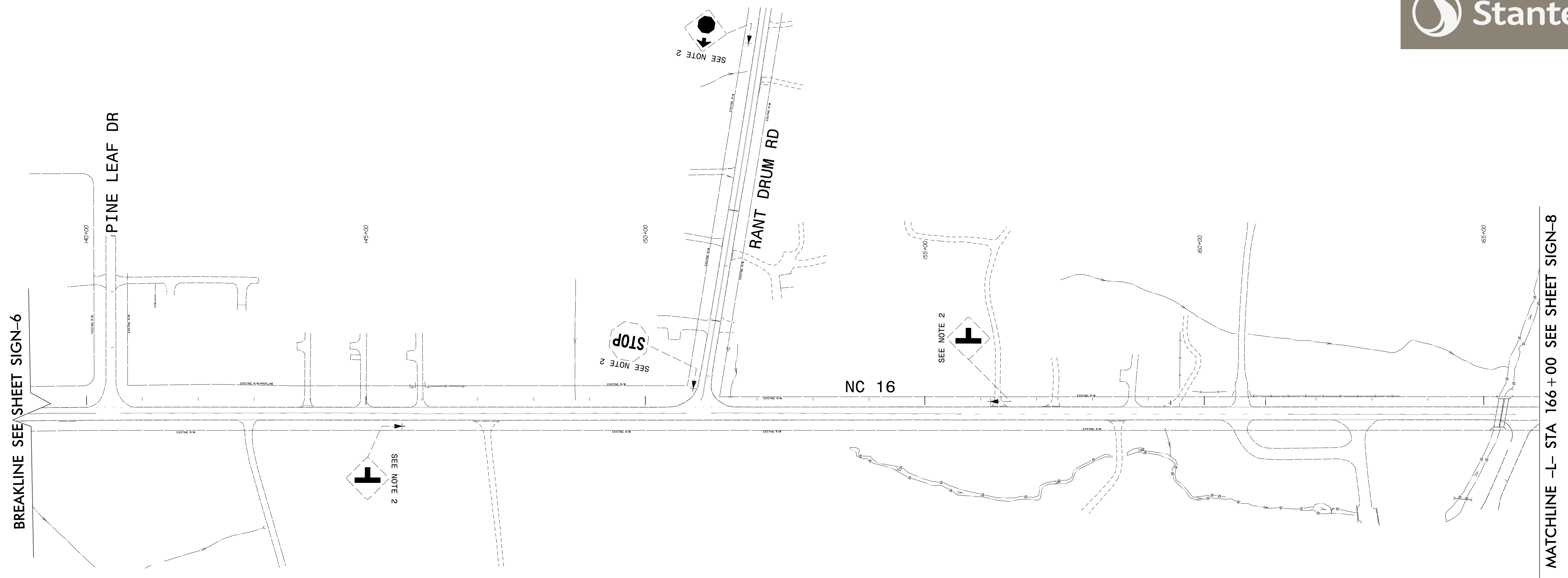
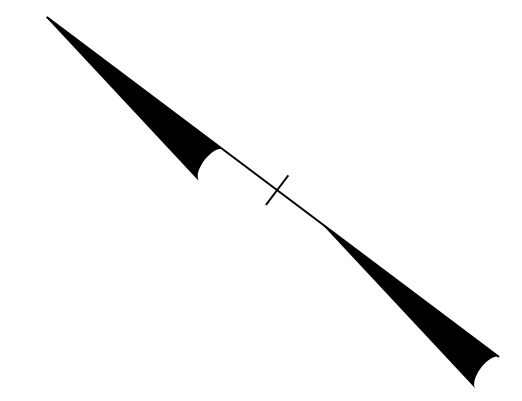

**PROJECT NOTES**

- 1 SIGN ERECTION, RELOCATE TYPE E
- 2 DISPOSAL OF SIGN SYSTEM, U-CHANNEL
- 3 DISPOSAL OF SUPPORT, U-CHANNEL
- 4 DISPOSAL OF SIGN SYSTEM, WOOD

EXISTING SIGNING  
NC 16  
-L- STA 139+00 TO 166+00

\$\$\$\$\$SYTIME\$\$\$\$\$  
\$\$\$\$\$DGN\$\$\$\$\$  
\$\$\$\$\$USERNAME\$\$\$\$\$

TIP NO. R-3100A	SHEET NO. SIGN-8
APPROVED: <i>Betsy L. Watson</i> DocuSigned by: Betsy L. Watson 35E87BB34F9743F	
DATE: 9/5/2016	
SEAL	
DOCUMENT NOT CONSIDERED FINAL UNLESS ALL SIGNATURES COMPLETED	

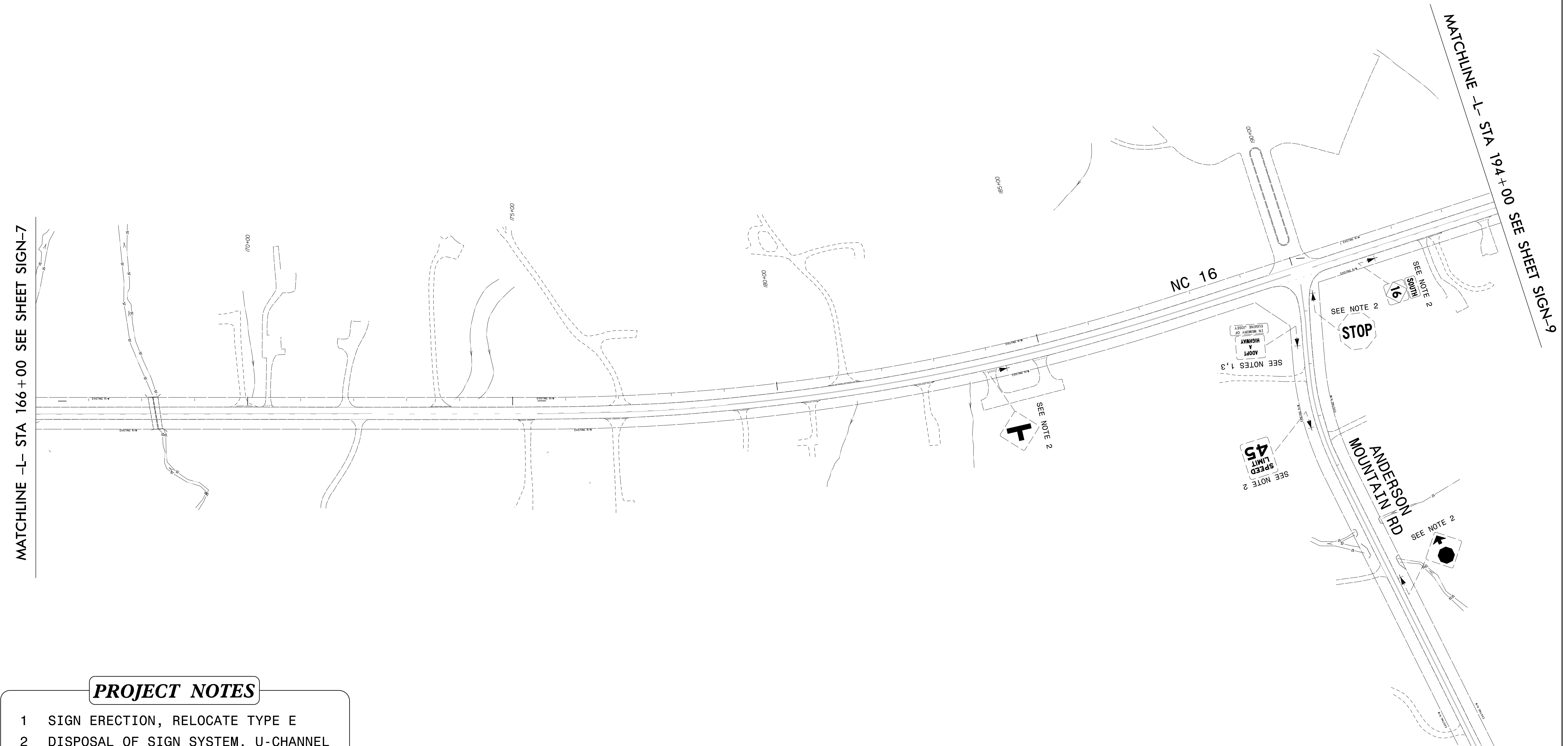
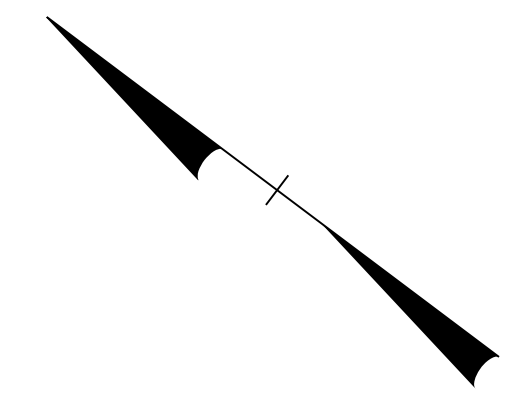

MATCHLINE -L- STA 166 + 00 SEE SHEET SIGN-7



MATCHLINE -L- STA 194 + 00 SEE SHEET SIGN-9

**PROJECT NOTES**

- 1 SIGN ERECTION, RELOCATE TYPE E
- 2 DISPOSAL OF SIGN SYSTEM, U-CHANNEL
- 3 DISPOSAL OF SUPPORT, U-CHANNEL
- 4 DISPOSAL OF SIGN SYSTEM, WOOD

EXISTING SIGNING  
NC 16  
-L- STA 166+00 TO 194+00

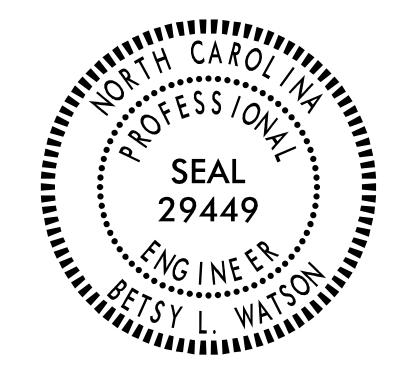
\$\$\$\$\$SYTIME\$\$\$\$\$  
\$\$\$\$\$DDGN\$\$\$\$\$  
\$\$\$\$\$USERNAME\$\$\$\$\$

TIP NO. R-3100A	SHEET NO. SIGN-9
APPROVED: <i>Betsy L. Watson</i> DocuSigned by: Betsy L. Watson 356E78B34F8743F...	
DATE: 9/5/2016	
SEAL 	
DOCUMENT NOT CONSIDERED FINAL UNLESS ALL SIGNATURES COMPLETED	
	

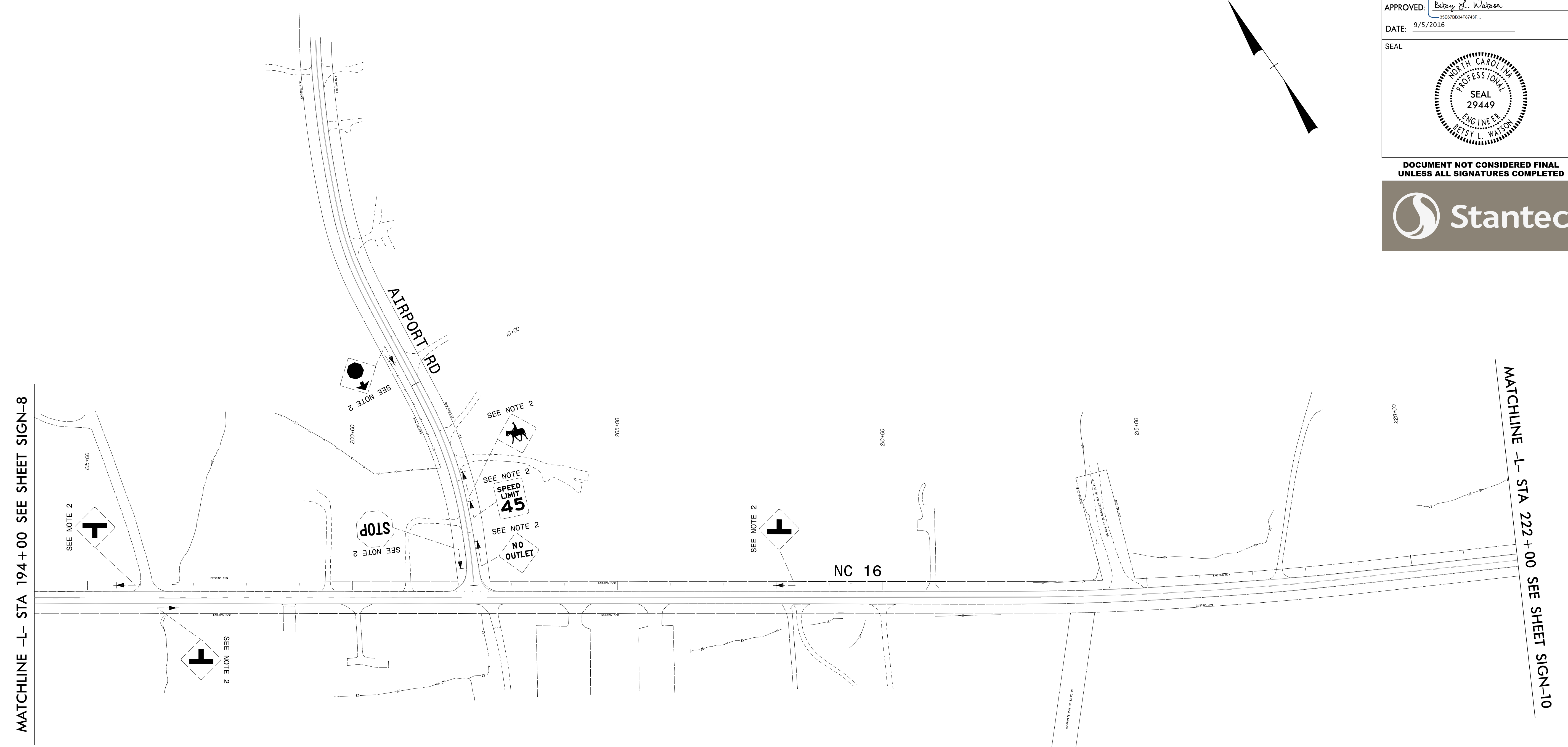
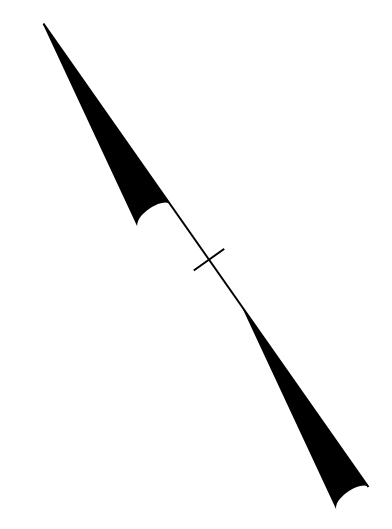

MATCHLINE -L- STA 194+00 SEE SHEET SIGN-8



MATCHLINE -L- STA 222+00 SEE SHEET SIGN-10

**PROJECT NOTES**

- 1 SIGN ERECTION, RELOCATE TYPE E
- 2 DISPOSAL OF SIGN SYSTEM, U-CHANNEL
- 3 DISPOSAL OF SUPPORT, U-CHANNEL
- 4 DISPOSAL OF SIGN SYSTEM, WOOD

EXISTING SIGNING  
NC 16  
-L- STA 194+00 TO 222+00

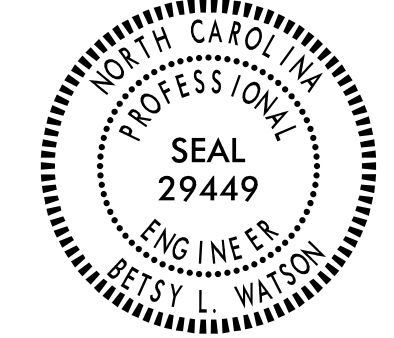
\$\$\$\$\$SYTIME\$\$\$\$\$  
\$\$\$\$\$DDGN\$\$\$\$\$  
\$\$\$\$\$USERNAME\$\$\$\$\$

TIP NO. R-3100A	SHEET NO. SIGN-10
APPROVED: <i>Betsy L. Watson</i> <small>DocuSigned by: Betsy L. Watson 35E878B34F8743F</small>	
DATE: 9/5/2016	
SEAL	
	
DOCUMENT NOT CONSIDERED FINAL UNLESS ALL SIGNATURES COMPLETED	
	

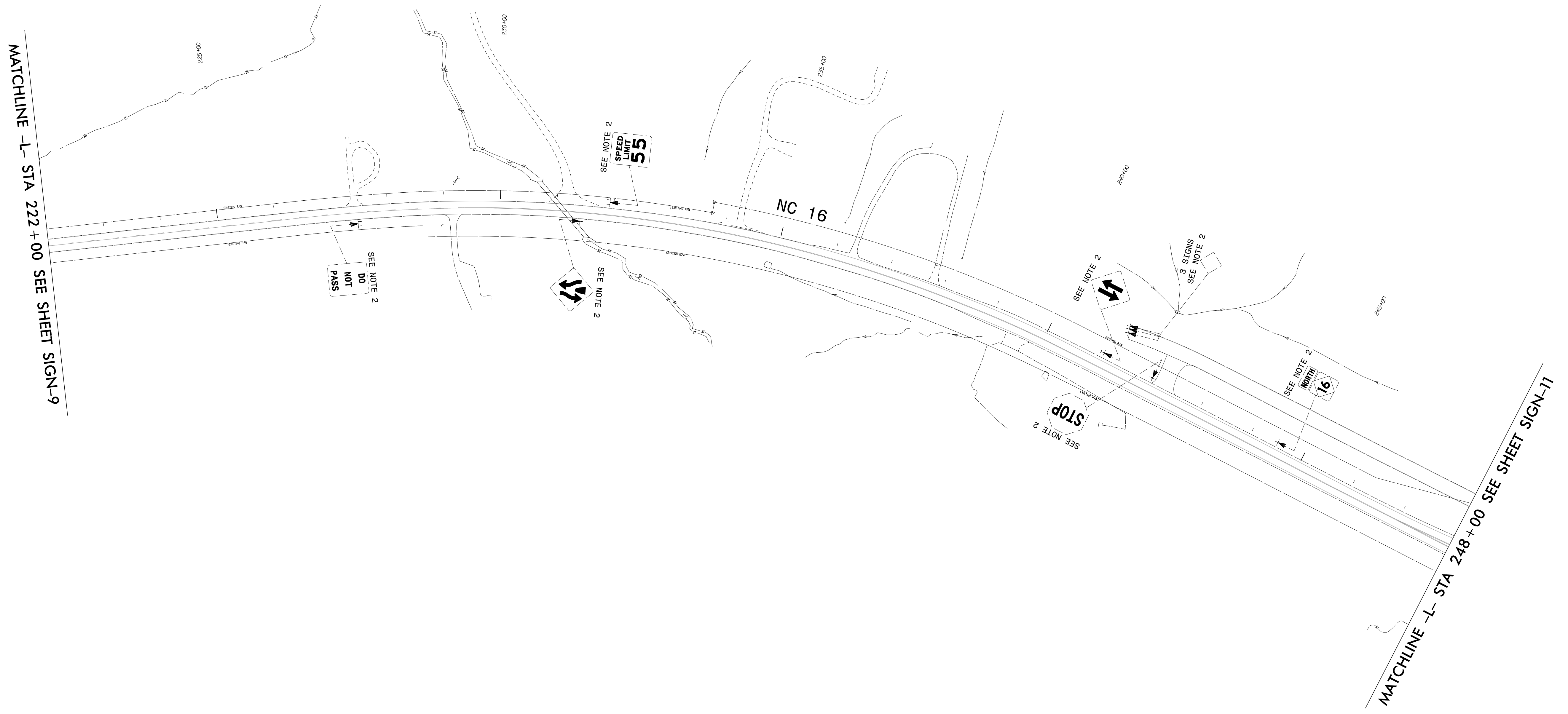
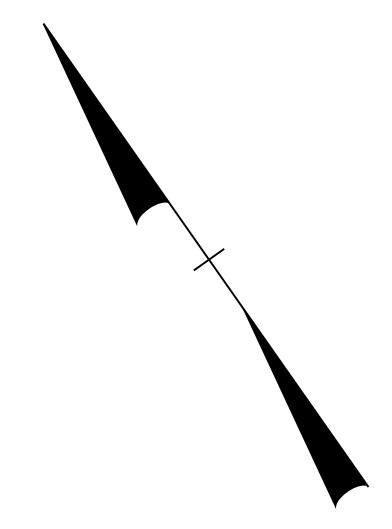



**PROJECT NOTES**

- 1 SIGN ERECTION, RELOCATE TYPE E
- 2 DISPOSAL OF SIGN SYSTEM, U-CHANNEL
- 3 DISPOSAL OF SUPPORT, U-CHANNEL
- 4 DISPOSAL OF SIGN SYSTEM, WOOD

EXISTING SIGNING  
NC 16  
-L- STA 222+00 TO 248+00

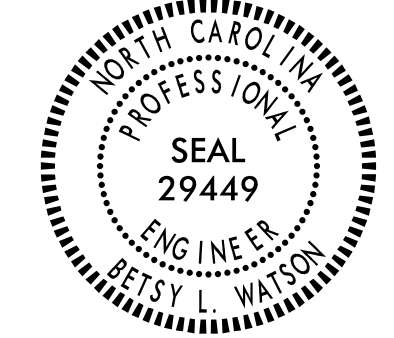
\$\$\$\$\$SYTIME\$\$\$\$\$  
\$\$\$\$\$DGN\$\$\$\$\$  
\$\$\$\$\$USERNAME\$\$\$\$\$

TIP NO. R-3100A	SHEET NO. SIGN-11
APPROVED: <i>Betsy L. Watson</i> 35E87BB34F9743F	
DATE: 9/5/2016	
SEAL	
	
DOCUMENT NOT CONSIDERED FINAL UNLESS ALL SIGNATURES COMPLETED	
	

MATCHLINE -L- STA 248+00 SEE SHEET SIGN-10

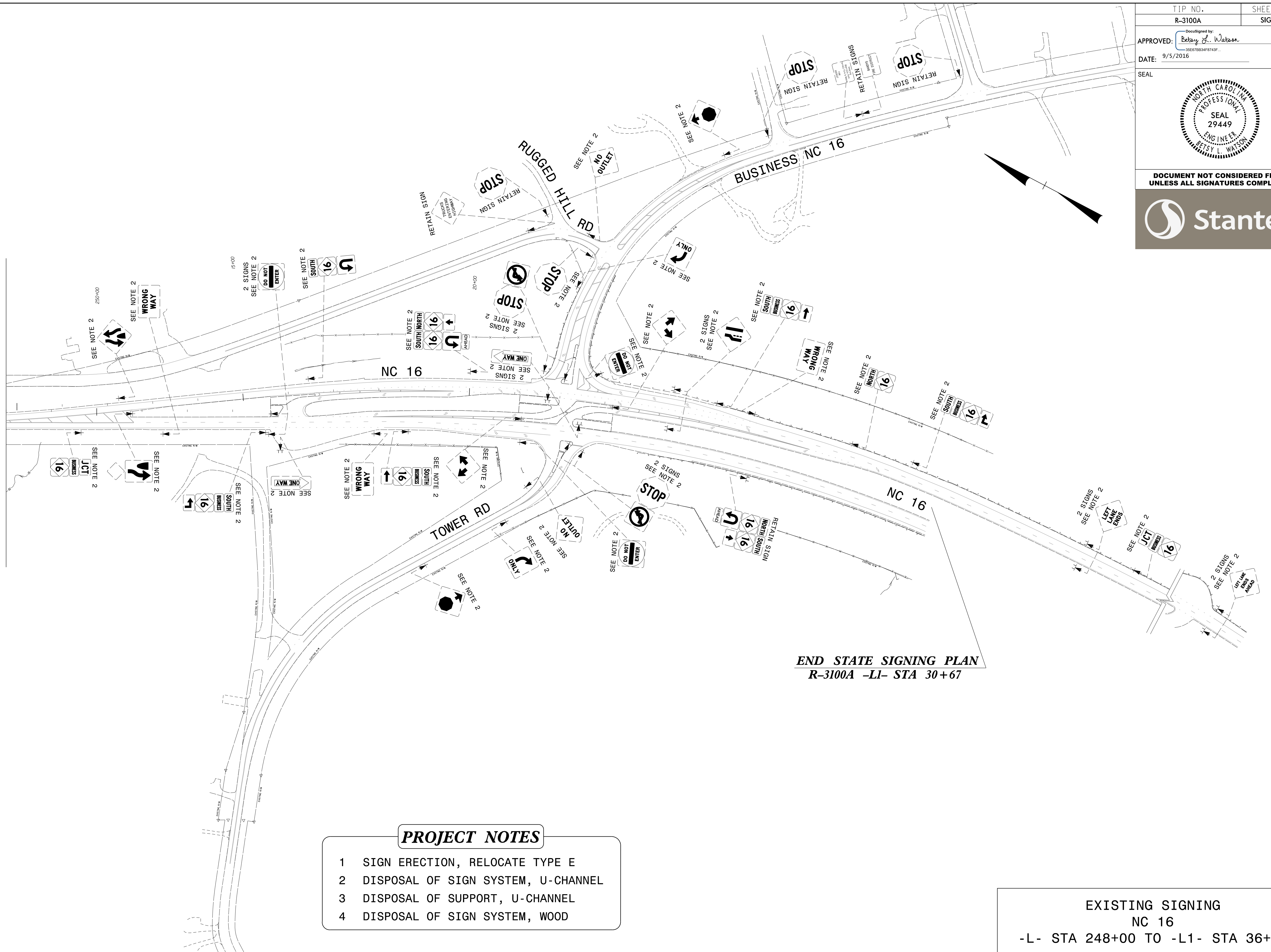



**END STATE SIGNING PLAN**  
R-3100A -LI- STA 30+67

**PROJECT NOTES**

- 1 SIGN ERECTION, RELOCATE TYPE E
- 2 DISPOSAL OF SIGN SYSTEM, U-CHANNEL
- 3 DISPOSAL OF SUPPORT, U-CHANNEL
- 4 DISPOSAL OF SIGN SYSTEM, WOOD

EXISTING SIGNING  
NC 16  
-L- STA 248+00 TO -L1- STA 36+00

\$\$\$\$\$SYTIME\$\$\$\$\$  
\$\$\$\$\$DGN\$\$\$\$\$  
\$\$\$\$\$USERNAME\$\$\$\$\$

TIP NO. R-3100A	SHEET NO. SIGN-12
APPROVED: <i>Betsy L. Watson</i> <small>DocuSigned by: Betsy L. Watson 35E87BB34F8743F...</small>	
DATE: 9/5/2016	
SEAL 	
DOCUMENT NOT CONSIDERED FINAL UNLESS ALL SIGNATURES COMPLETED	
	

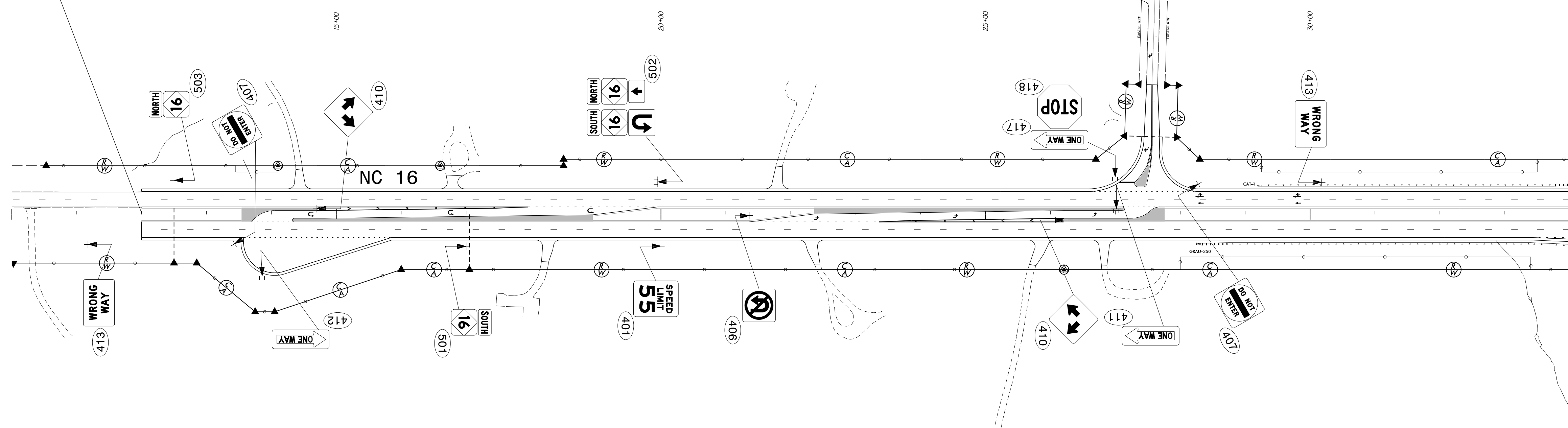

**BEGIN R-3100A STATE SIGNING PLAN**  
**END R-3100B -L- STA 12+00**



MATCHLINE -L- STA 34+00 SEE SHEET SIGN-13

\$\$\$\$\$SYTIME\$\$\$\$\$  
\$\$\$\$\$DDGN\$\$\$\$\$  
\$\$\$\$\$USERNAME\$\$\$\$\$

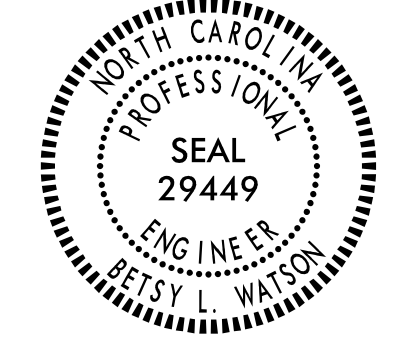
**PROPOSED SIGNING**  
**NC 16**  
**-L- STA 10+00 TO 34+00**

TIP NO. R-3100A	SHEET NO. SIGN-13
APPROVED: <i>Betsy L. Watson</i> 35E678B34F8743F	
DATE: 9/5/2016	
SEAL	
	
DOCUMENT NOT CONSIDERED FINAL UNLESS ALL SIGNATURES COMPLETED	
	

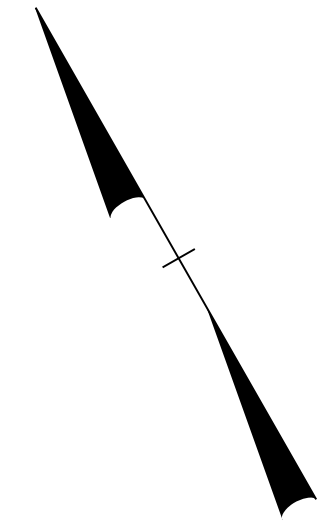

MATCHLINE -L- STA 34+00 SEE SHEET SIGN-12

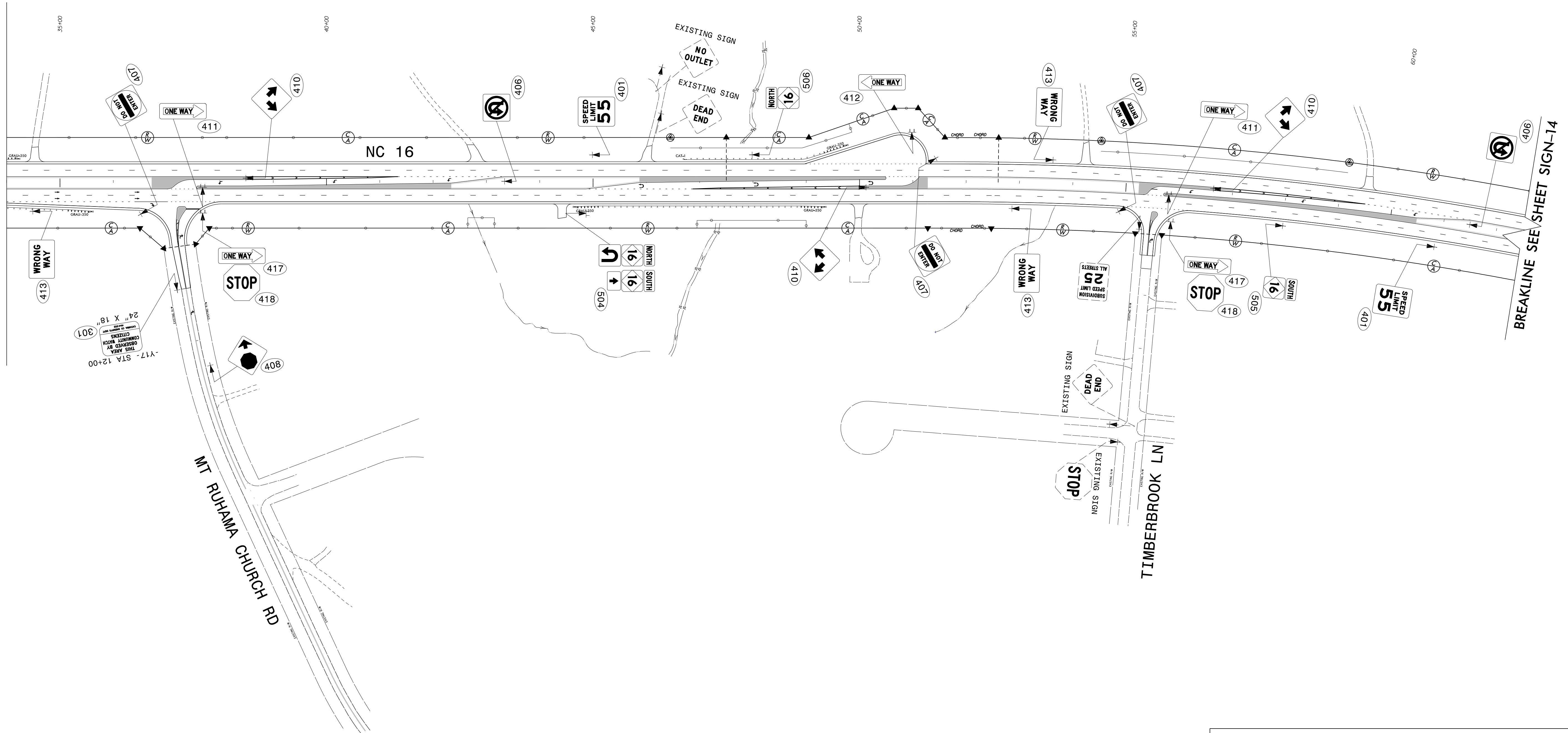

BREAKLINE SEE SHEET SIGN-14

\$\$\$SYTIME\$\$\$\$  
 \$\$\$DGN\$\$\$\$  
 \$\$\$USERNAME\$\$\$\$

**PROPOSED SIGNING**  
**NC 16**  
**-L- STA 34+00 TO 61+00**



TIP NO. R-3100A	SHEET NO. SIGN-14
APPROVED: <i>Betsy L. Watson</i> 35E078B54F8743F	
DATE: 9/5/2016	
SEAL	
DOCUMENT NOT CONSIDERED FINAL UNLESS ALL SIGNATURES COMPLETED	

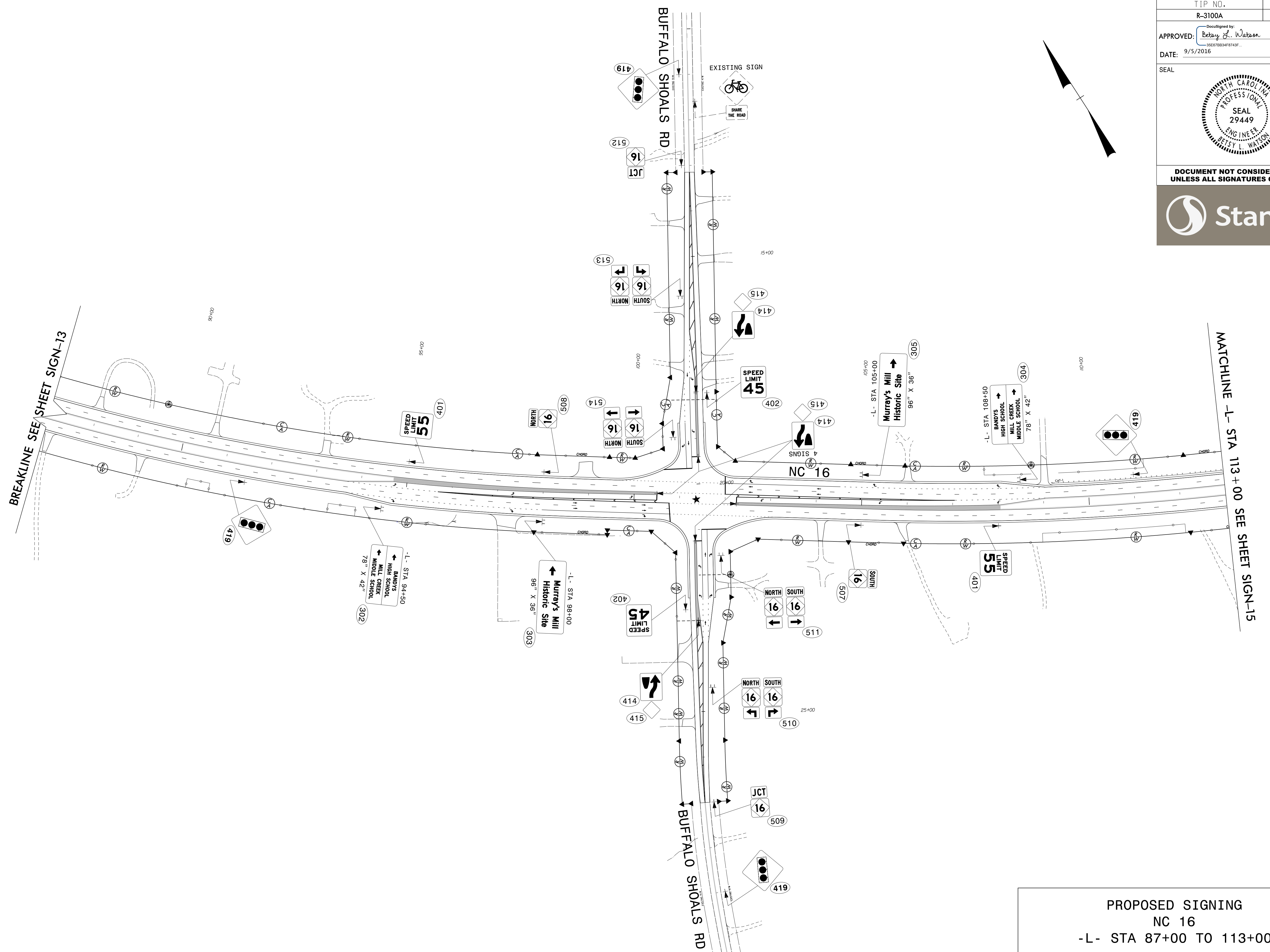
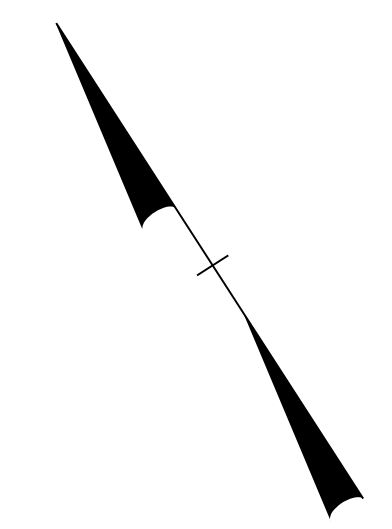



BREAKLINE SEE SHEET SIGN-13

MATCHLINE -L- STA 113+00 SEE SHEET SIGN-15

PROPOSED SIGNING  
NC 16  
-L- STA 87+00 TO 113+00

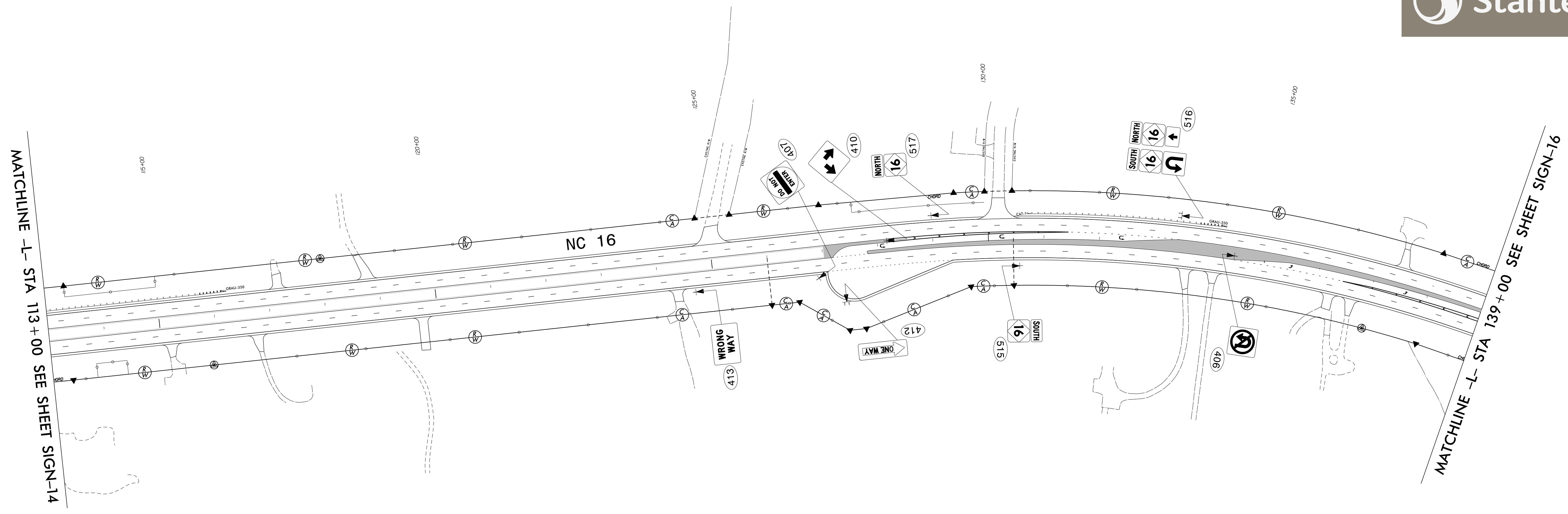
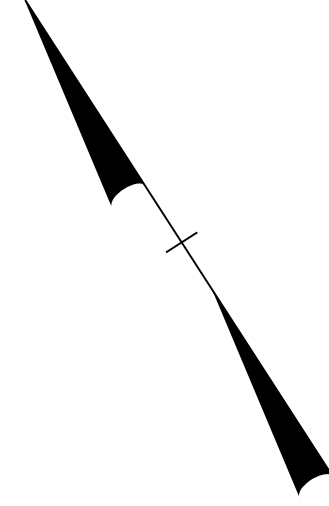

\$\$\$\$\$SYTIME\$\$\$\$\$  
\$\$\$\$\$DDGN\$\$\$\$\$  
\$\$\$\$\$USERNAME\$\$\$\$\$

TIP NO. R-3100A	SHEET NO. SIGN-15
APPROVED: <i>Betsy L. Watson</i> <small>DocuSigned by: Betsy L. Watson 35E67BB34F8743F...</small>	
DATE: 9/5/2016	
SEAL 	
DOCUMENT NOT CONSIDERED FINAL UNLESS ALL SIGNATURES COMPLETED	
	

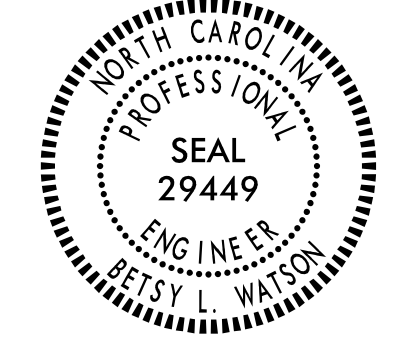

\$\$\$\$\$SYTIME\$\$\$\$\$  
\$\$\$\$\$DDGN\$\$\$\$\$  
\$\$\$\$\$USERNAME\$\$\$\$\$

PROPOSED SIGNING  
NC 16  
-L- STA 113+00 TO 139+00

TIP NO. R-3100A	SHEET NO. SIGN-16
APPROVED: <i>Betsy L. Watson</i> 355878834F8743F	
DATE: 9/5/2016	
SEAL	
	
DOCUMENT NOT CONSIDERED FINAL UNLESS ALL SIGNATURES COMPLETED	
	

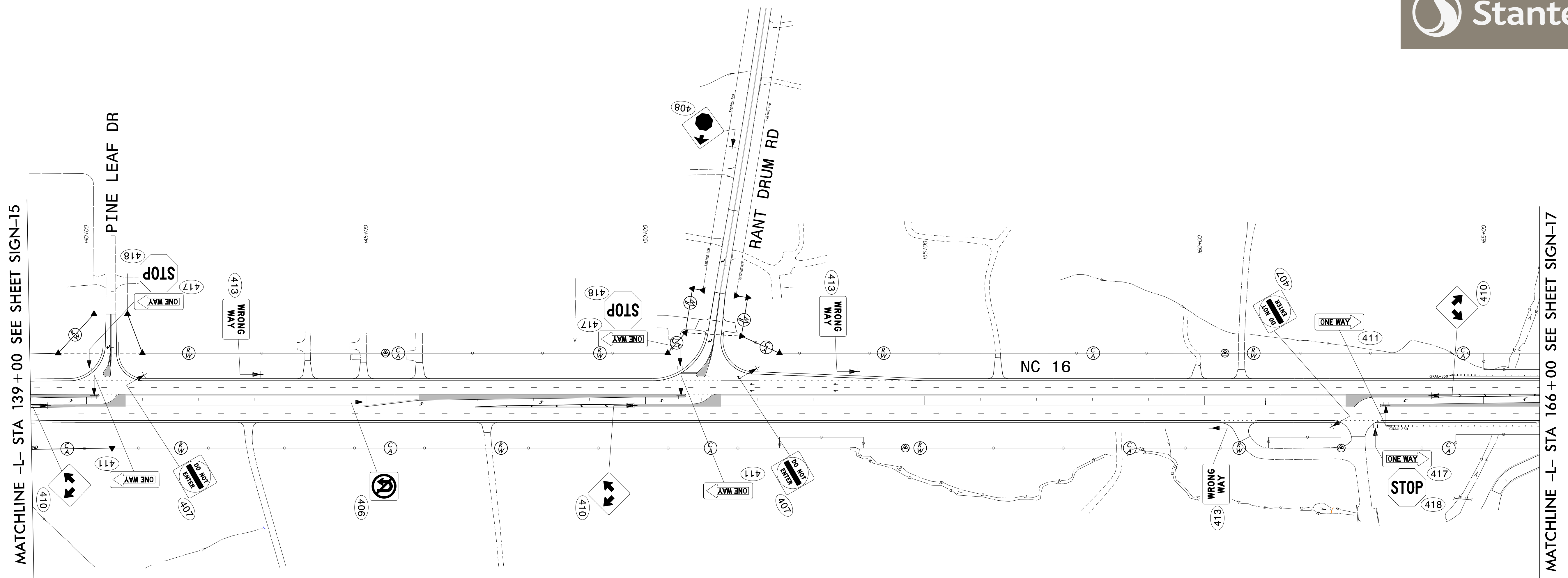
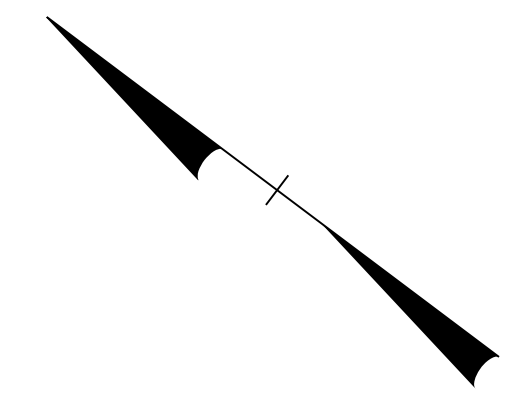

MATCHLINE -L- STA 139+00 SEE SHEET SIGN-15

MATCHLINE -L- STA 166+00 SEE SHEET SIGN-17

\$\$\$\$\$SYTIME\$\$\$\$\$  
\$\$\$\$\$DGN\$\$\$\$\$  
\$\$\$\$\$USERNAME\$\$\$\$\$

PROPOSED SIGNING  
NC 16  
-L- STA 139+00 TO 166+00

TIP NO. R-3100A	SHEET NO. SIGN-17
APPROVED: <i>Betsy L. Watson</i> 3568788348743F	
DATE: 9/5/2016	
SEAL	
DOCUMENT NOT CONSIDERED FINAL UNLESS ALL SIGNATURES COMPLETED	

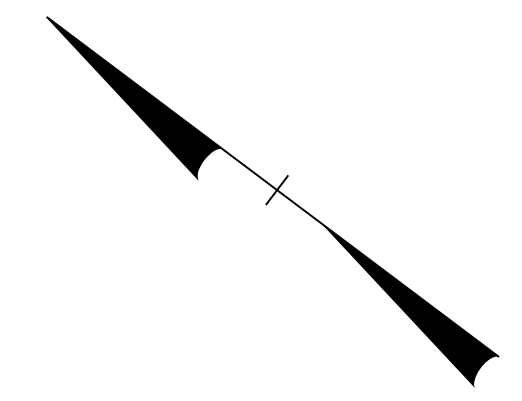

MATCHLINE -L- STA 166 + 00 SEE SHEET SIGN-16

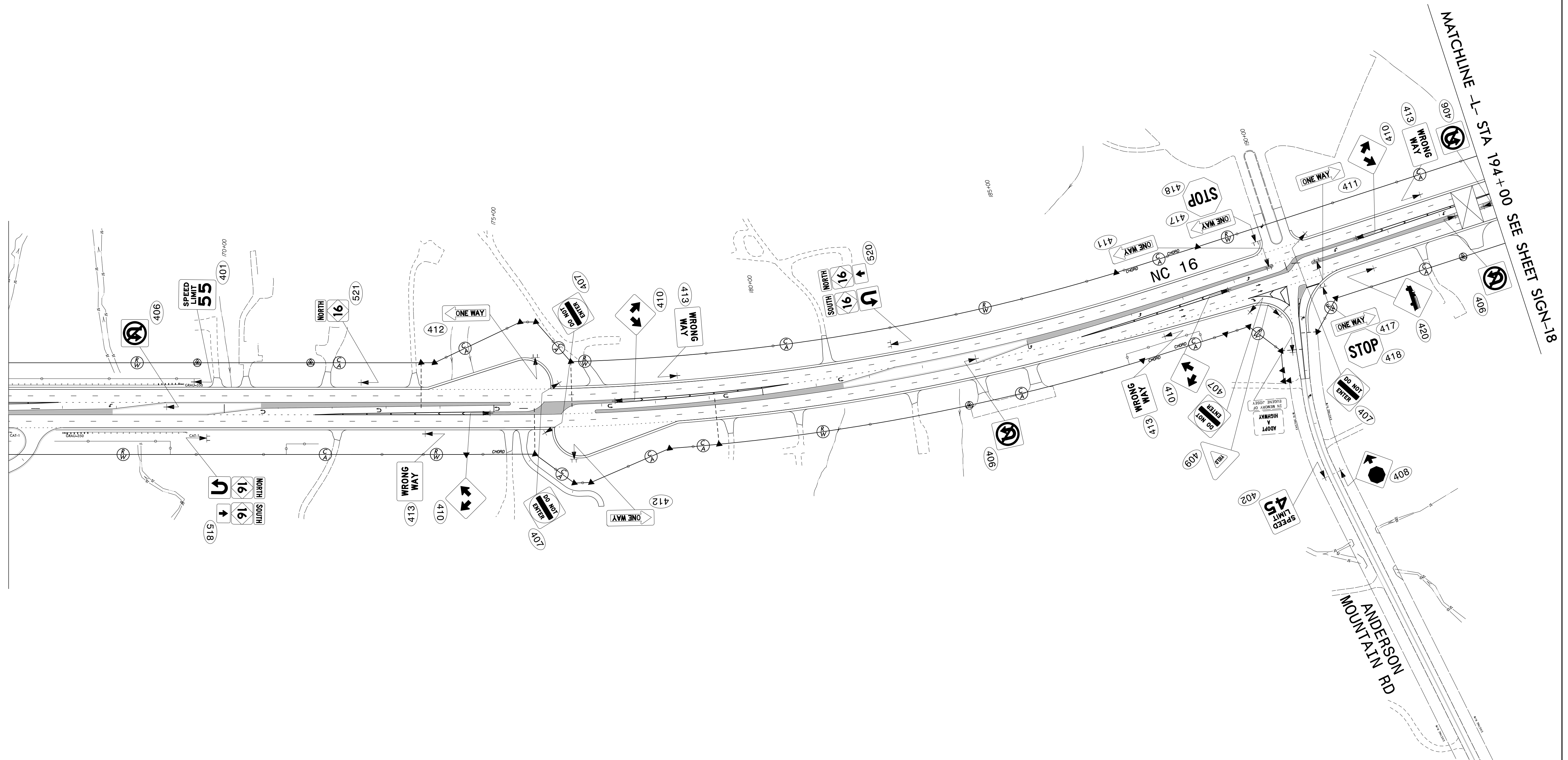



MATCHLINE -L- STA 194 + 00 SEE SHEET SIGN-18

ANDERSON RD  
MOUNTAIN RD

\$\$\$\$\$SYTIME\$\$\$\$\$  
\$\$\$\$\$DGN\$\$\$\$\$  
\$\$\$\$\$USERNAME\$\$\$\$\$

PROPOSED SIGNING  
NC 16  
-L- STA 166+00 TO 194+00

TIP NO. R-3100A	SHEET NO. SIGN-18
APPROVED: <i>Betsy L. Watson</i> DocuSigned by: Betsy L. Watson 35E978B34F8743F...	
DATE: 9/5/2016	
SEAL 	
DOCUMENT NOT CONSIDERED FINAL UNLESS ALL SIGNATURES COMPLETED	
	

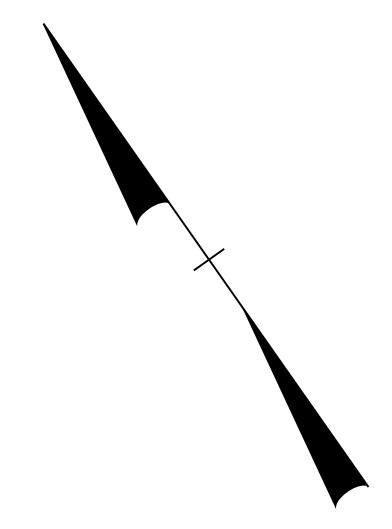

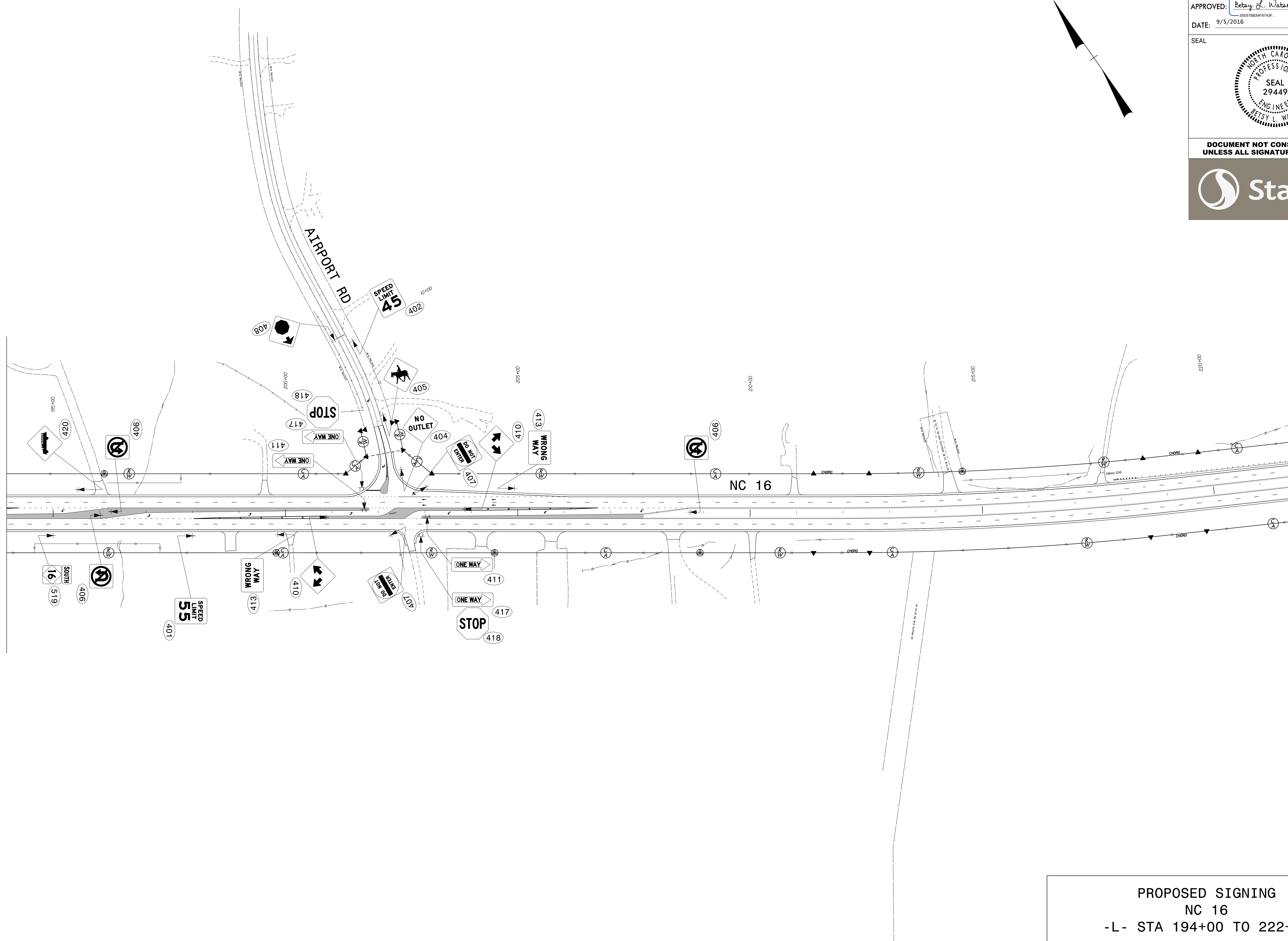

MATCHLINE -L- STA 194+00 SEE SHEET SIGN-17

BREAKLINE SEE SHEET SIGN-19



\$\$\$\$\$SYTIME\$\$\$\$\$  
\$\$\$\$\$DGN\$\$\$\$\$  
\$\$\$\$\$USERNAME\$\$\$\$\$

PROPOSED SIGNING  
NC 16  
-L- STA 194+00 TO 222+00

TIP NO. R-3100A	SHEET NO. SIGN-19
APPROVED: <i>Betsy L. Watson</i> DocuSigned by: Betsy L. Watson 35E978B34F8743F	
DATE: 9/5/2016	
SEAL	
	
DOCUMENT NOT CONSIDERED FINAL UNLESS ALL SIGNATURES COMPLETED	
	

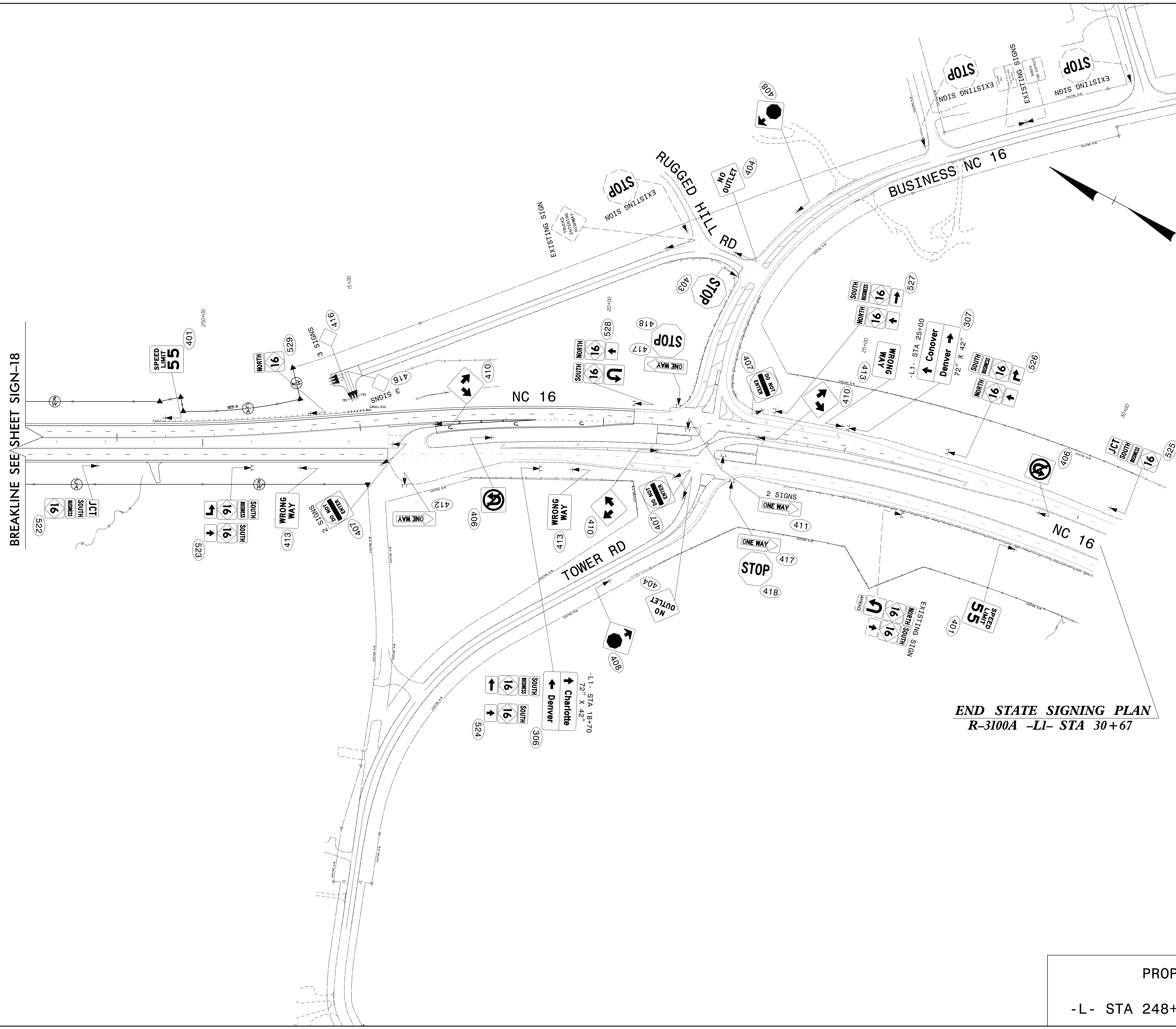

**END STATE SIGNING PLAN**  
R-3100A -L1- STA 30+67

PROPOSED SIGNING  
NC 16  
-L- STA 248+00 TO -L1- STA 30+67

\$\$\$\$\$SYTIME\$\$\$\$\$  
\$\$\$\$\$DGN\$\$\$\$\$  
\$\$\$\$\$USERNAME\$\$\$\$\$