

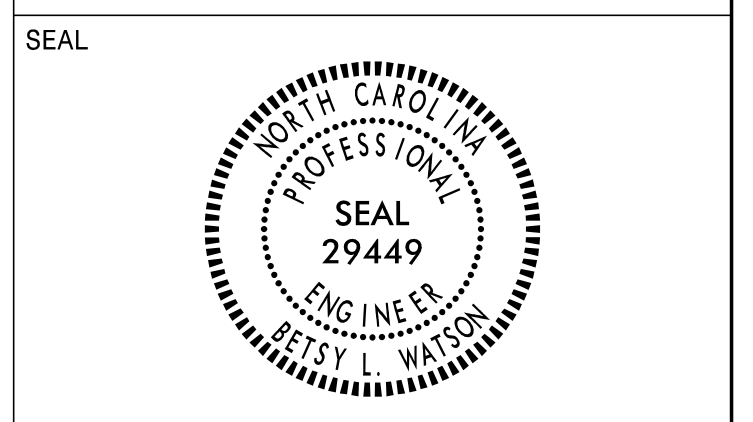

APPROVED: *Betsy L. Watson*  
DATE: 9/5/2016



DOCUMENT NOT CONSIDERED FINAL  
UNLESS ALL SIGNATURES COMPLETED



401 QUANTITY REQ'D 9



30 X 36  
R2-1

ONE "U" POST PER SIGN

406 QUANTITY REQ'D 14

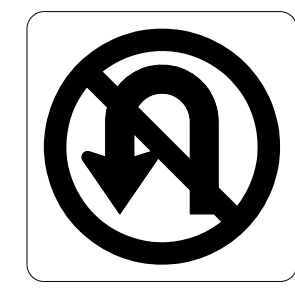

36 X 36  
R3-4

ONE "U" POST PER SIGN

411 QUANTITY REQ'D 12



54 X 18  
R6-1R

TWO "U" POSTS PER SIGN

416 QUANTITY REQ'D 6

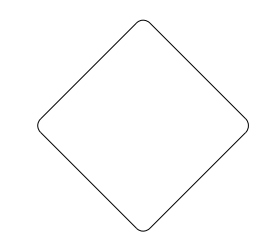

18 X 18  
OM4-3

ONE "U" POST PER SIGN

402 QUANTITY REQ'D 4



24 X 30  
R2-1

ONE "U" POST PER SIGN

407 QUANTITY REQ'D 19



36 X 36  
R5-1

ONE "U" POST PER SIGN

412 QUANTITY REQ'D 6



54 X 18  
R6-1L

TWO "U" POSTS PER SIGN

417 QUANTITY REQ'D 12



36 X 12  
R6-1R

MOUNT ABOVE SIGN 418  
IN 12 INSTALLATIONS

403 QUANTITY REQ'D 1

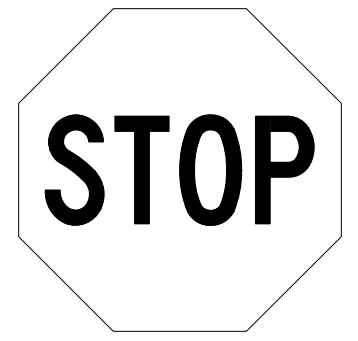

36 X 36  
R1-1

ONE "U" POST PER SIGN

408 QUANTITY REQ'D 7

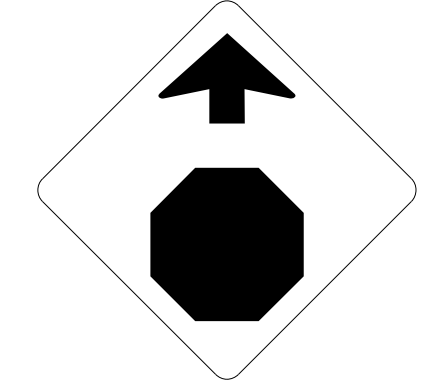

36 X 36  
W3-1

ONE "U" POST PER SIGN

413 QUANTITY REQ'D 18



42 X 30  
R5-1a

ONE "U" POST PER SIGN

418 QUANTITY REQ'D 12

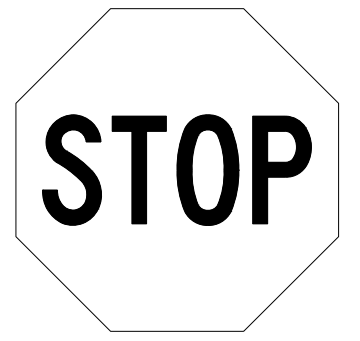

36 X 36  
R1-1

TWO "U" POST PER SIGN

404 QUANTITY REQ'D 3



36 X 36  
W14-2

ONE "U" POST PER SIGN

409 QUANTITY REQ'D 1

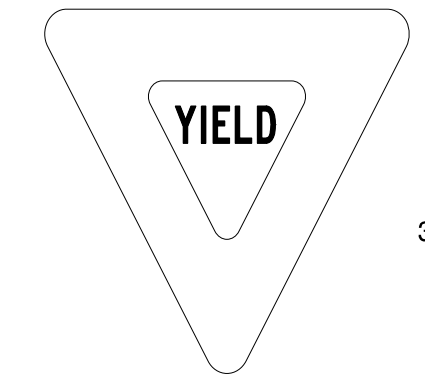

36 X 36 X 36  
R1-2

ONE "U" POST PER SIGN

414 QUANTITY REQ'D 6

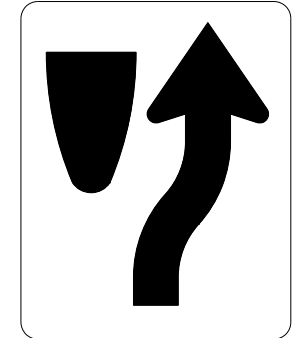

24 X 30  
R4-7

ONE "U" POST PER SIGN

419 QUANTITY REQ'D 4

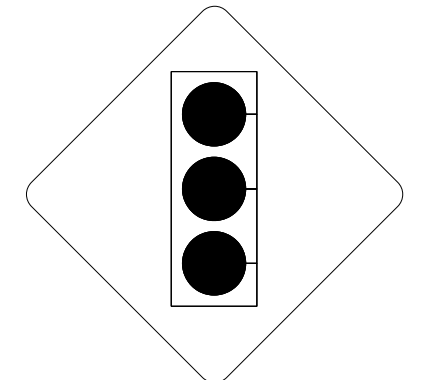

36 X 36  
W3-3

ONE "U" POST PER SIGN

405 QUANTITY REQ'D 1

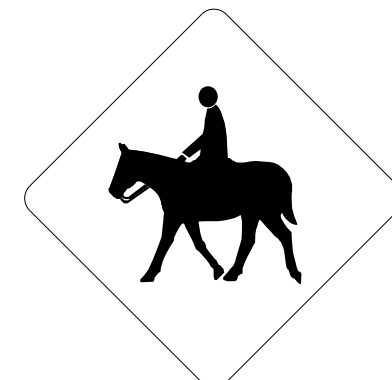

30 X 30  
W11-7

ONE "U" POST PER SIGN

410 QUANTITY REQ'D 18

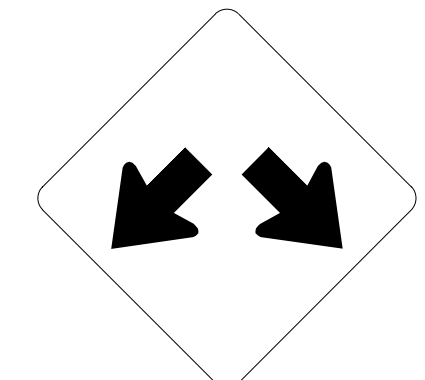

30 X 30  
W12-1

ONE "U" POST PER SIGN

415 QUANTITY REQ'D 6

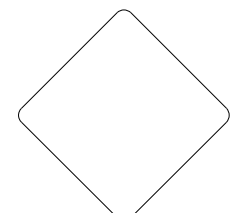

18 X 18  
OM1-3

MOUNT BELOW SIGN 414  
IN 6 INSTALLATIONS

420 QUANTITY REQ'D 2

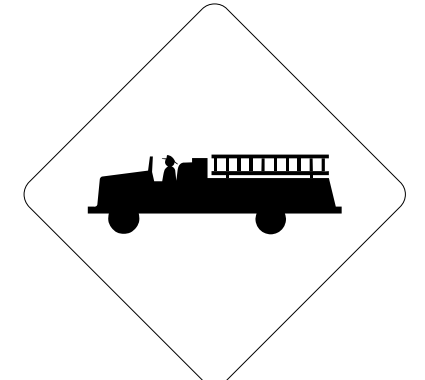

36 X 36  
W11-8

ONE "U" POST PER SIGN

TYPE 'E' SIGNS

\$\$\$\$\$SYSTEMTIME\$\$\$\$\$  
\$\$\$\$\$DGN\$\$\$\$\$  
\$\$\$\$\$USERNAME\$\$\$\$\$