

**NOTES:**

REPAIR LOCATIONS AND ESTIMATE OF QUANTITIES ARE GIVEN WITH THE BEST INFORMATION AVAILABLE. IF ADDITIONAL REPAIRS NOT SHOWN ON THE DRAWINGS ARE DEEMED NECESSARY BY THE INSPECTOR OR ENGINEER THE CONTRACTOR SHALL NOTE ON THE DRAWINGS THE APPROXIMATE LOCATION AND DESCRIPTION OF THE REPAIRS AND ADJUST THE ACTUAL QUANTITIES ENTERED INTO THE REPAIR QUANTITY TABLE.

FOR CAP AND COLUMN REPAIR DETAILS, SEE "TYPICAL CAP AND COLUMN REPAIR DETAILS" SHEET.

FOR "SHOTCRETE REPAIRS", SEE SPECIAL PROVISIONS.



FOR "EPOXY RESIN INJECTION", SEE SPECIAL PROVISIONS.

FOR "EPOXY COATING", SEE SPECIAL PROVISIONS.

**REPAIR QUANTITY TABLE**

REPAIRS BENT 40	QUANTITIES			
	ESTIMATE		ACTUAL	
SHOTCRETE REPAIRS	AREA SF	VOLUME CF	AREA SF	VOLUME CF
CAP (VERTICAL FACE)	24.0	12.0		
CAP (HORIZONTAL, CORNER)	0	0		
COLUMN	4.5	2.3		
STRUT	0	0		
FOOTING	0	0		
EPOXY RESIN INJECTION		LN. FT		LN. FT
CAP		0		
COLUMN		0		
STRUT		0		
FOOTING		0		
EPOXY COATING		AREA SF		AREA SF
CAP		147.3		

VALUES IN CHART REPRESENT ESTIMATED REPAIR TOTALS AFTER REMOVAL OF UNSOUND CONCRETE, MIN. OF 1" BEHIND REBAR AND MIN. 2" CL TO SAWCUT. SEE REPAIR DETAILS.

-  - EPOXY COATING
-  - SHOTCRETE REPAIR
- ERI - EPOXY RESIN INJECTION

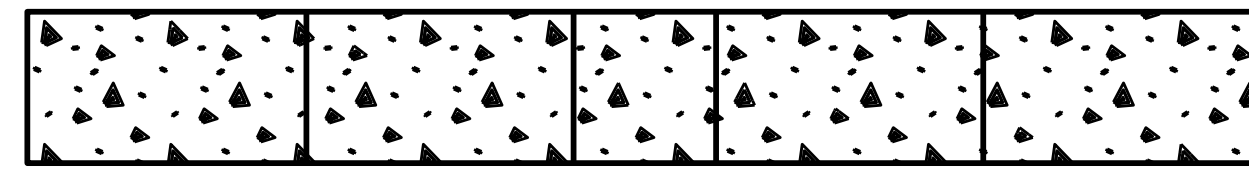

PLAN  
TOP OF CAP

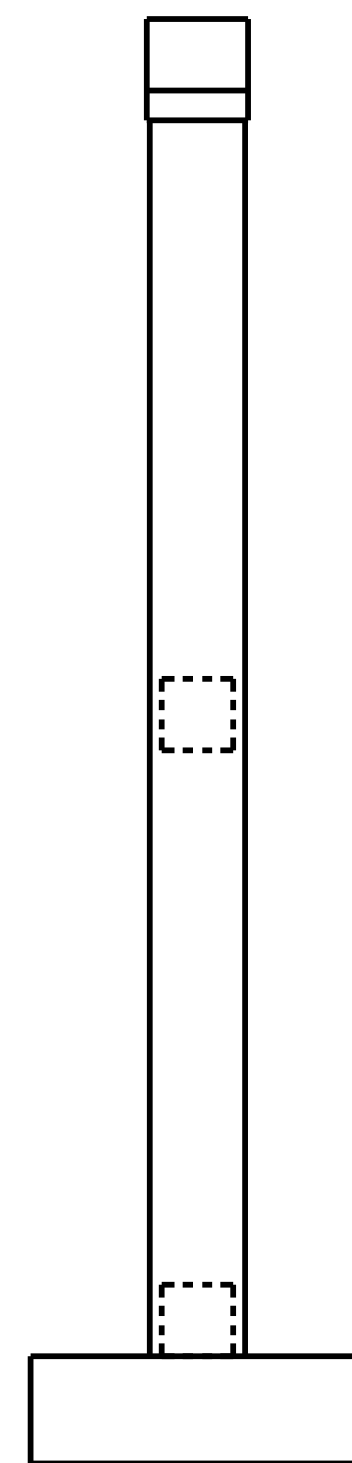

END VIEW  
WEST SIDE

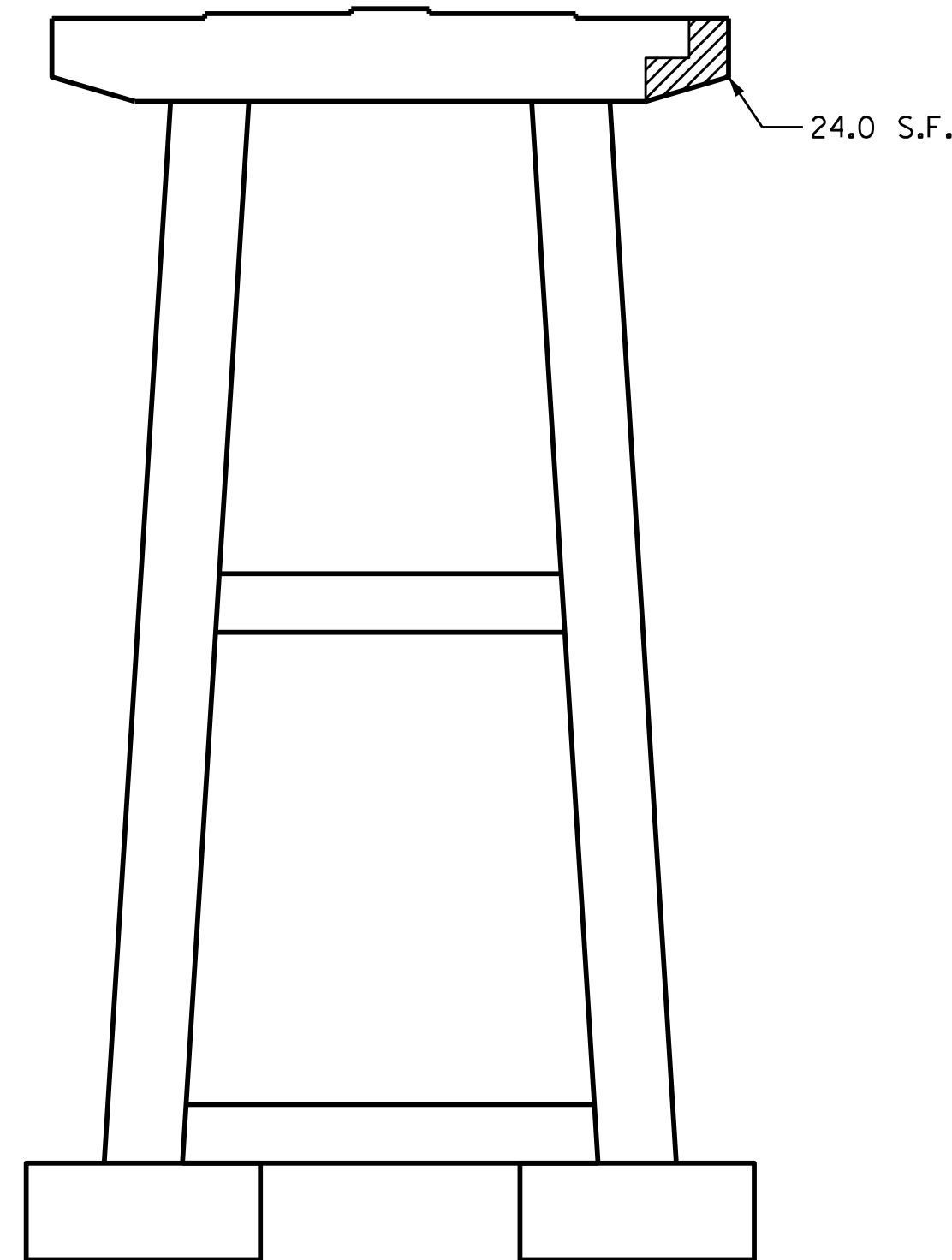

ELEVATION  
SOUTH SIDE

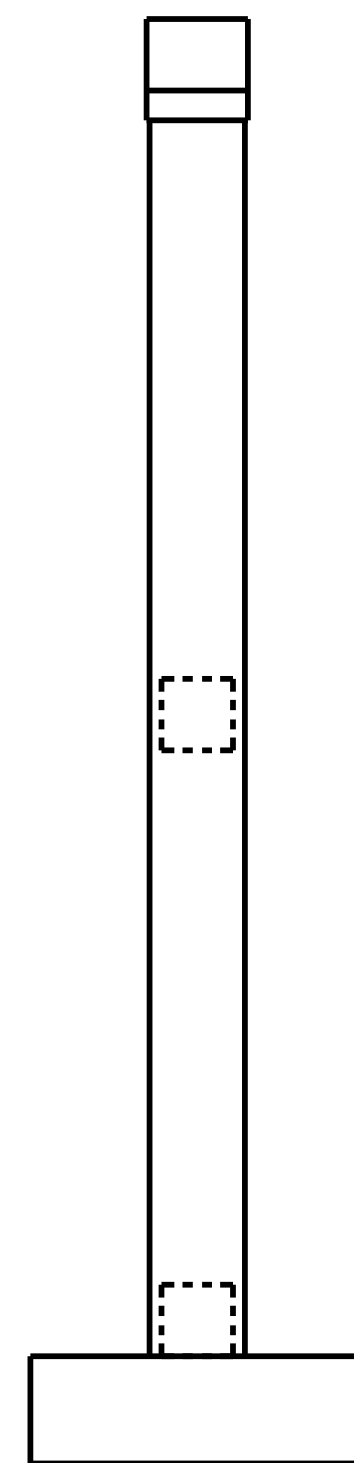

END VIEW  
EAST SIDE

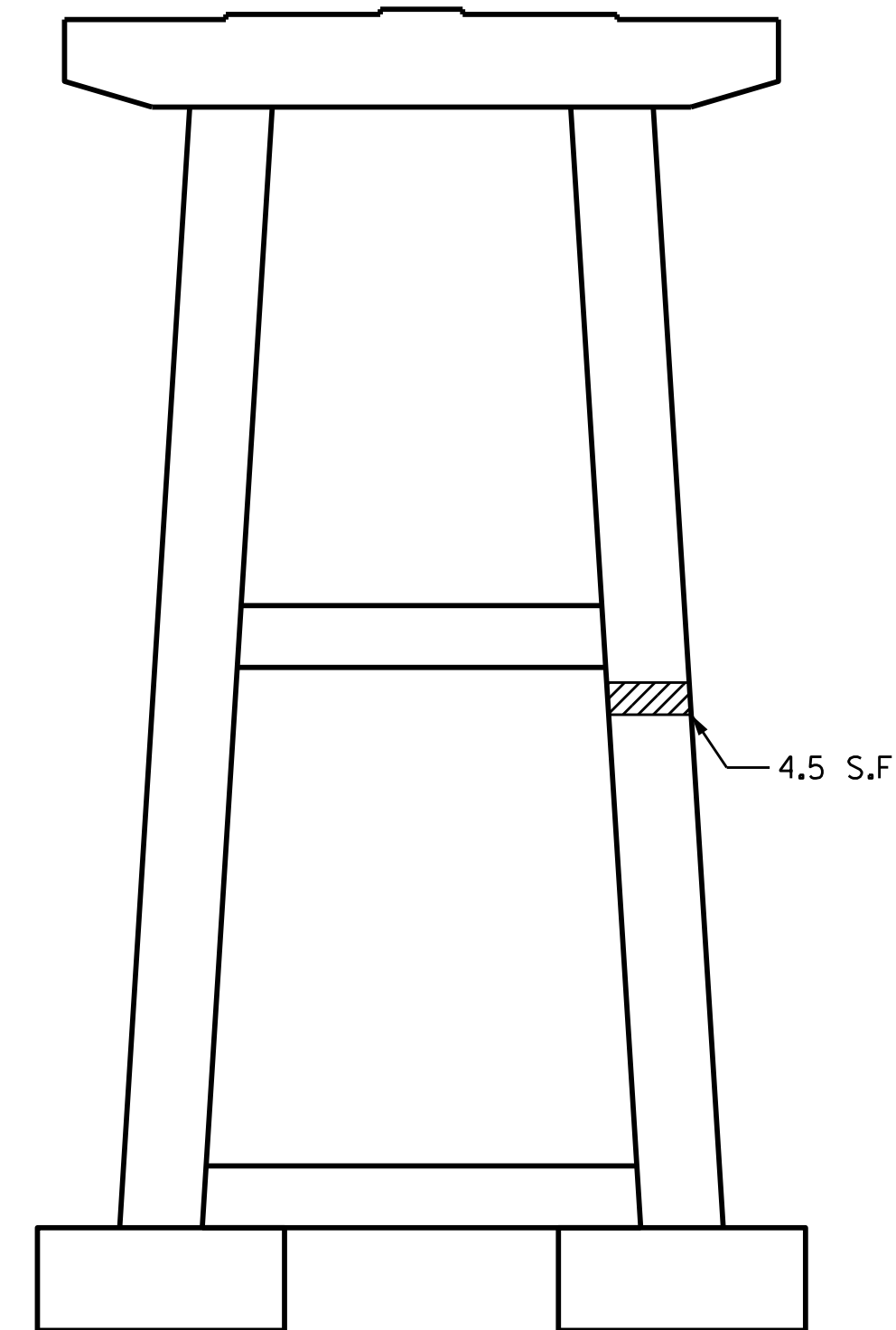

ELEVATION  
NORTH SIDE



PLAN  
BOTTOM OF CAP

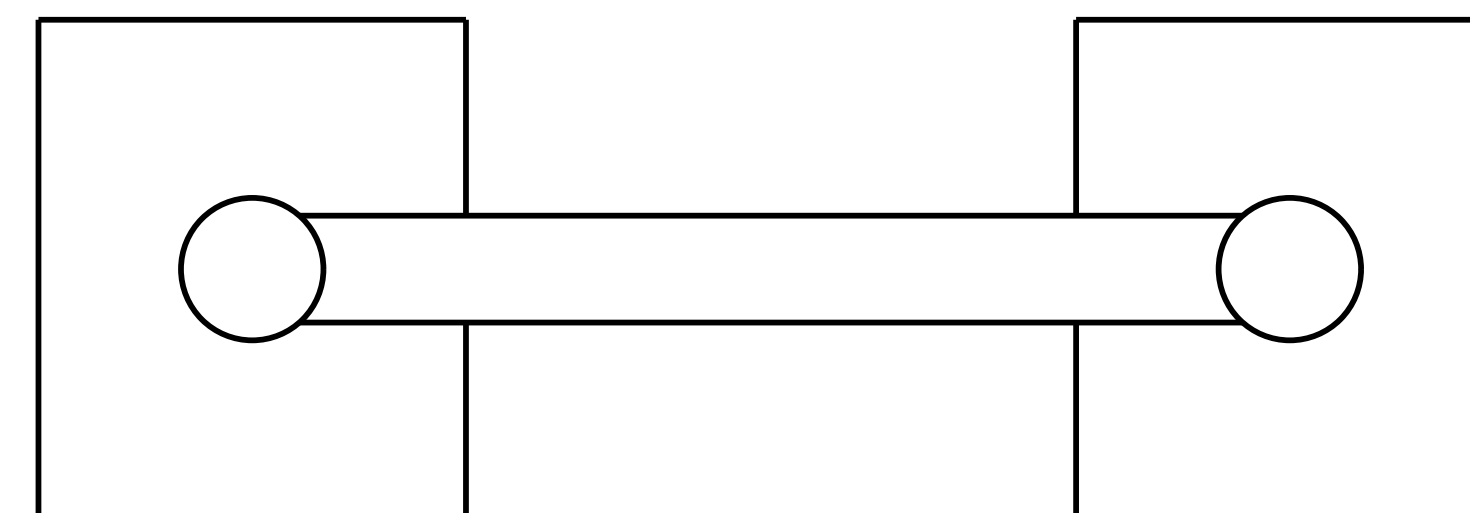

PLAN  
TOP OF FOOTING

PROJECT NO. B-5939

CARTERET COUNTY

BRIDGE NO. 6

SHEET 41 OF 60

STATE OF NORTH CAROLINA  
DEPARTMENT OF TRANSPORTATION  
RALEIGH

SUBSTRUCTURES  
BENT 40



DocuSigned by:  
Greg Dickey  
884E488CE5848B...

DRAWN BY : M.A. LEE DATE : 8/2016  
CHECKED BY : P. BRYANT DATE : 8/2016

DOCUMENT NOT CONSIDERED  
FINAL UNLESS ALL  
SIGNATURES COMPLETED

REVISIONS						SHEET NO.
NO.	BY:	DATE:	NO.	BY:	DATE:	TOTAL SHEETS
1			3			S2-111
2			4			