

NOTES:

REPAIR LOCATIONS AND ESTIMATE OF QUANTITIES ARE GIVEN WITH THE BEST INFORMATION AVAILABLE. IF ADDITIONAL REPAIRS NOT SHOWN ON THE DRAWINGS ARE DEEMED NECESSARY BY THE INSPECTOR OR ENGINEER THE CONTRACTOR SHALL NOTE ON THE DRAWINGS THE APPROXIMATE LOCATION AND DESCRIPTION OF THE REPAIRS AND ADJUST THE ACTUAL QUANTITIES ENTERED INTO THE REPAIR QUANTITY TABLE.

FOR CAP AND COLUMN REPAIR DETAILS, SEE "TYPICAL CAP AND COLUMN REPAIR DETAILS" SHEET.

FOR "SHOTCRETE REPAIRS", SEE SPECIAL PROVISIONS.



FOR "EPOXY RESIN INJECTION", SEE SPECIAL PROVISIONS.

FOR "EPOXY COATING", SEE SPECIAL PROVISIONS.

REPAIR QUANTITY TABLE

REPAIRS BENT 37	QUANTITIES			
	ESTIMATE		ACTUAL	
SHOTCRETE REPAIRS	AREA SF	VOLUME CF	AREA SF	VOLUME CF
CAP (VERTICAL FACE)	41.0	20.5		
CAP (HORIZONTAL, CORNER)	0	0		
COLUMN	19.0	9.5		
STRUT	0	0		
FOOTING	10.0	5.0		
EPOXY RESIN INJECTION	LN. FT		LN. FT	
CAP	10.0			
COLUMN	0			
STRUT	0			
FOOTING	0			
EPOXY COATING	AREA SF		AREA SF	
CAP	147.3			

VALUES IN CHART REPRESENT ESTIMATED REPAIR TOTALS AFTER REMOVAL OF UNSOUND CONCRETE, MIN. OF 1" BEHIND REBAR AND MIN. 2" CL TO SAWCUT. SEE REPAIR DETAILS.

-  - EPOXY COATING
-  - SHOTCRETE REPAIR
- ERI - EPOXY RESIN INJECTION

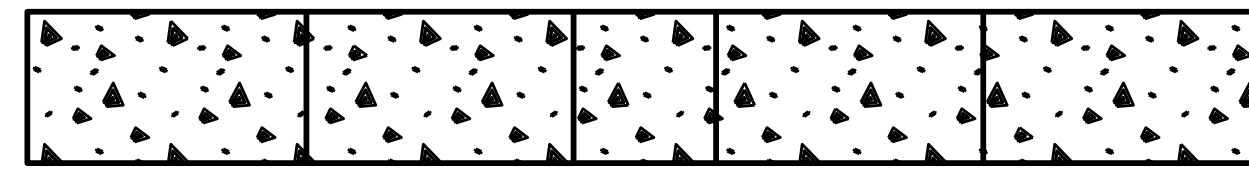

PLAN
TOP OF CAP

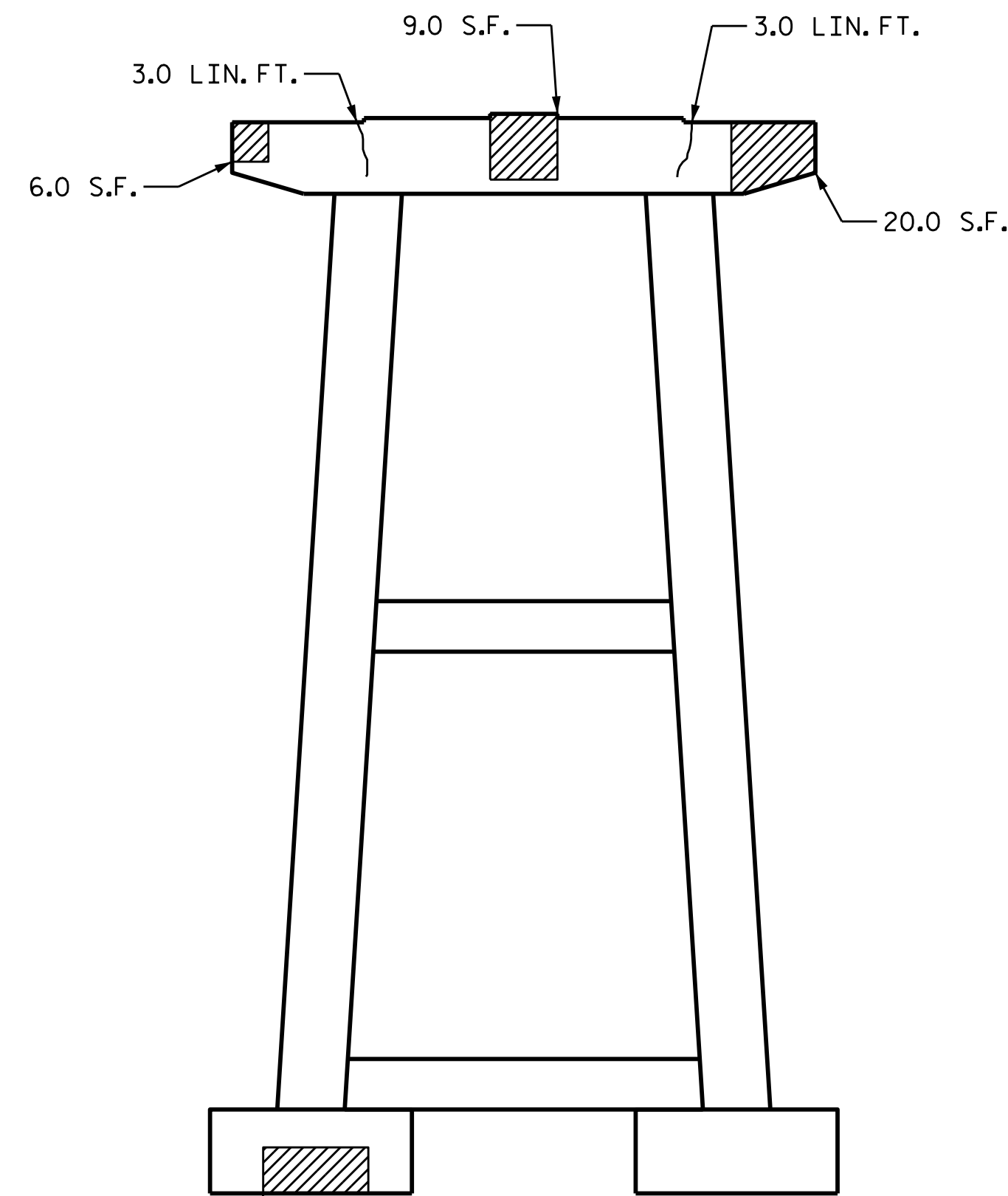

ELEVATION
SOUTH SIDE

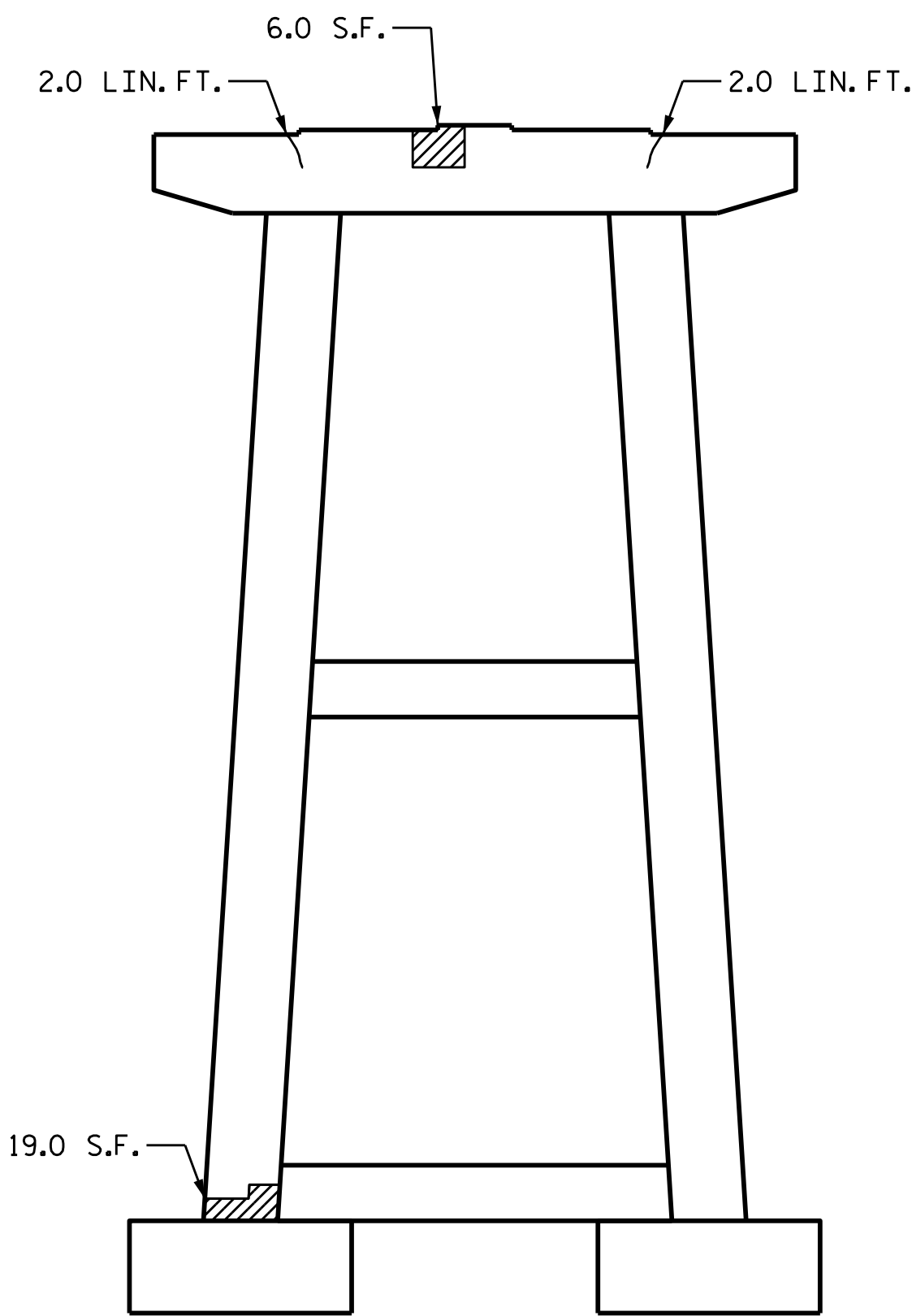

ELEVATION
NORTH SIDE

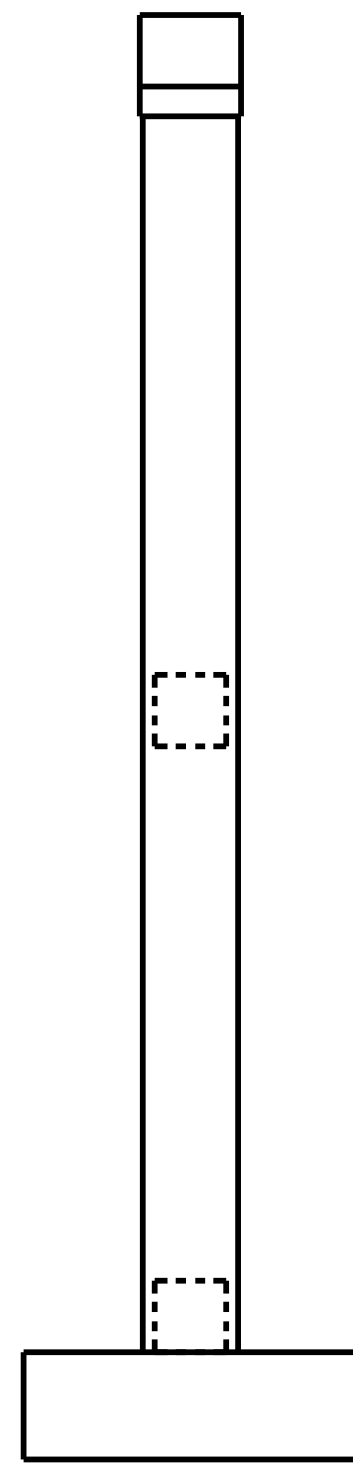

END VIEW
WEST SIDE

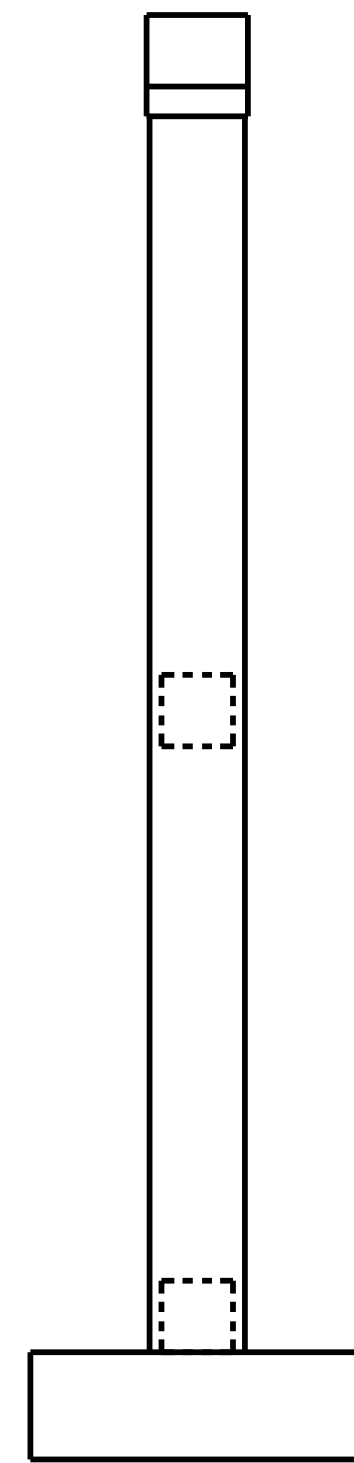

END VIEW
EAST SIDE



PLAN
BOTTOM OF CAP

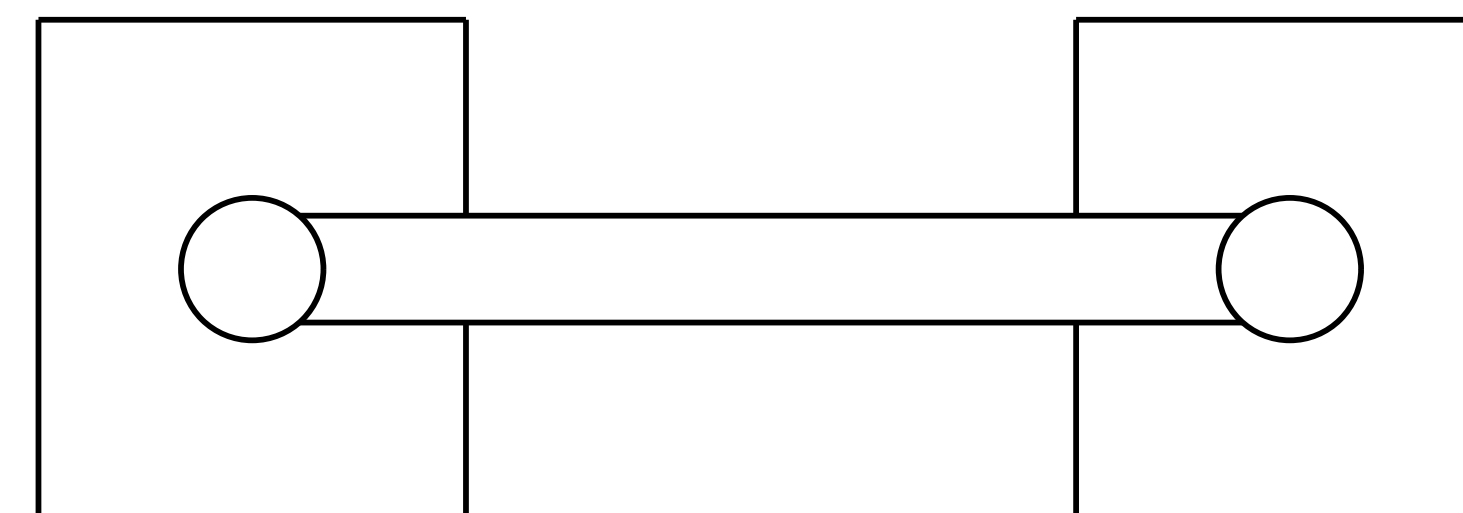

PLAN
TOP OF FOOTING

PROJECT NO. B-5939
CARTERET COUNTY
 BRIDGE NO. 6
 SHEET 38 OF 60

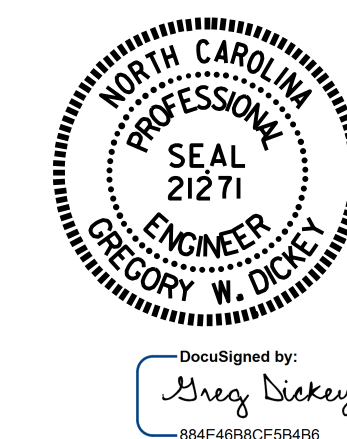

STATE OF NORTH CAROLINA
 DEPARTMENT OF TRANSPORTATION
 RALEIGH

**SUBSTRUCTURES
 BENT 37**

DRAWN BY : M.A. LEE DATE : 8/2016
 CHECKED BY : P. BRYANT DATE : 8/2016

DOCUMENT NOT CONSIDERED
 FINAL UNLESS ALL
 SIGNATURES COMPLETED

REVISIONS						SHEET NO.
NO.	BY:	DATE:	NO.	BY:	DATE:	TOTAL SHEETS
1			3			S2-108
2			4			