

**EDI MODEL 2018EClip-NC CONFLICT MONITOR**  
**PROGRAMMING DETAIL**  
*(remove jumpers and set switches as shown)*

REMOVE DIODE JUMPERS 1-5, 1-6, 1-9, 1-11, 2-5, 2-6, 2-9, 2-11, 4-8, 5-9, 5-11, 6-9, 6-11 and 9-11.

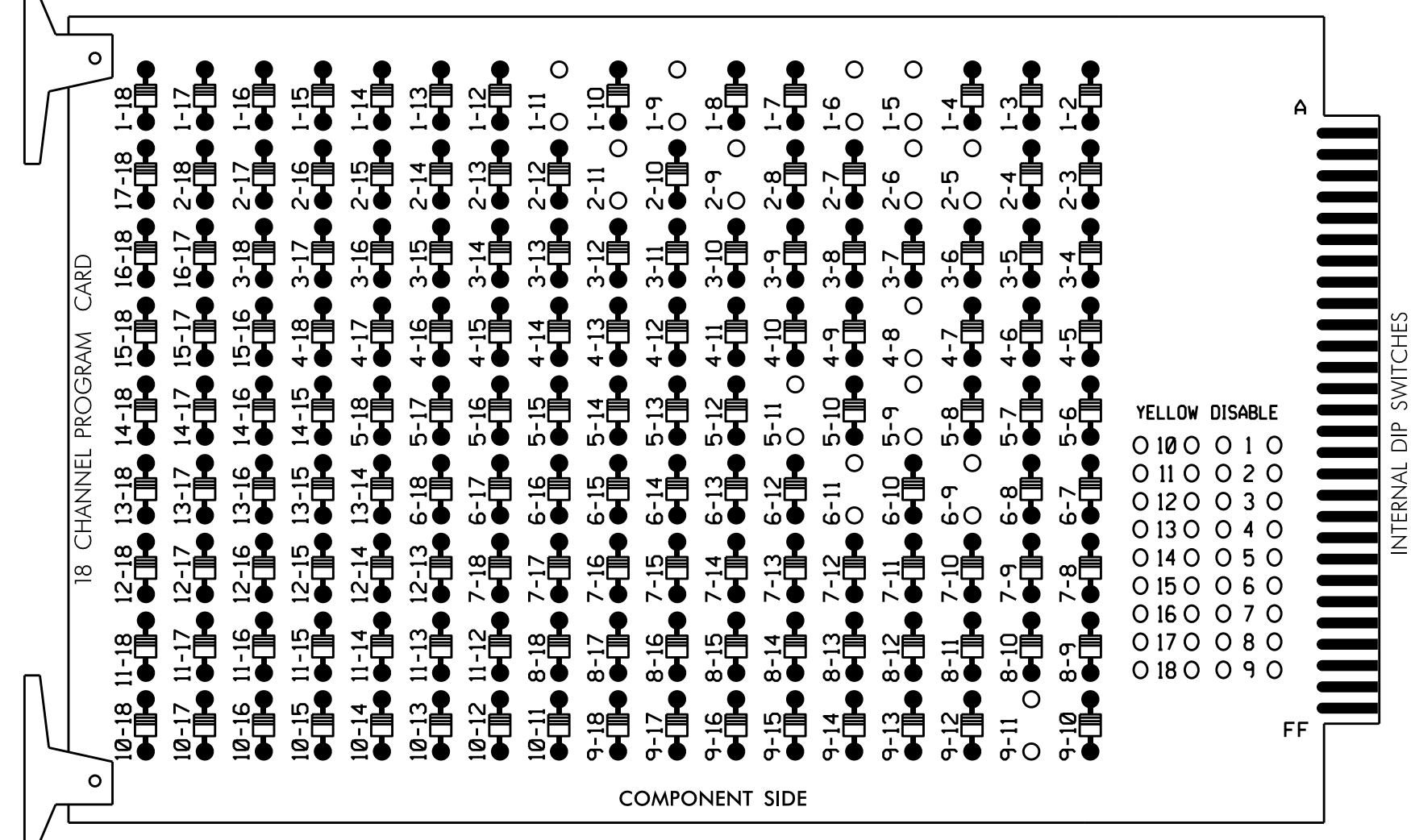

REMOVE JUMPERS AS SHOWN

**NOTES:**

- Card is provided with all diode jumpers in place. Removal of any jumper allows its channels to run concurrently.
- Ensure jumpers SEL2-SEL5 and SEL9 are present on the monitor board.
- Ensure that Red Enable is active at all times during normal operation.
- Integrate monitor with Ethernet network in cabinet.

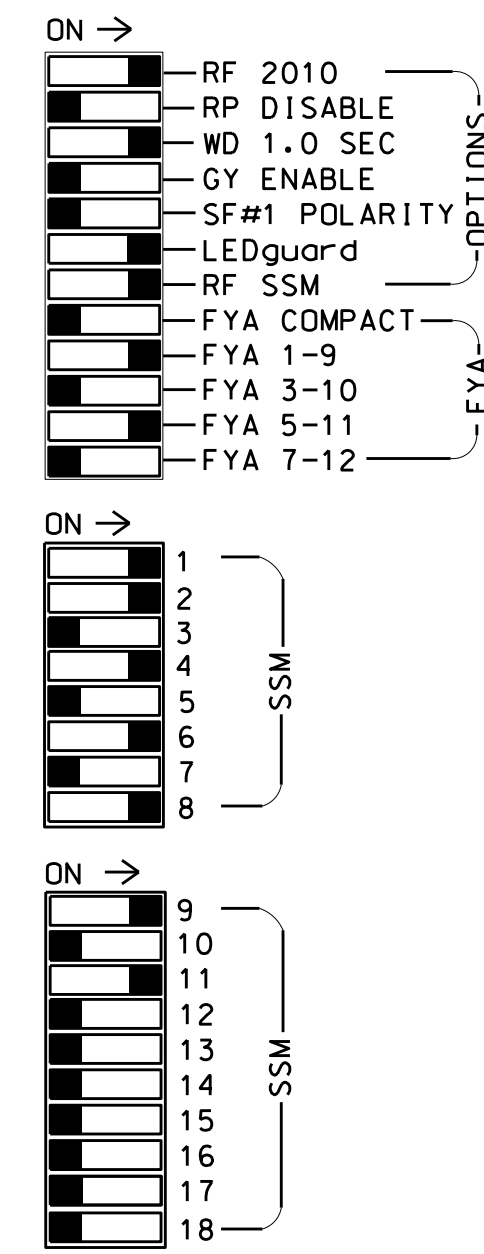
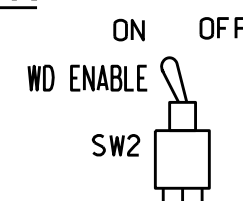

■ = DENOTES POSITION OF SWITCH

**NOTES**

- To prevent "flash-conflict" problems, insert red flash program blocks for all unused vehicle load switches in the output file. The installer shall verify that signal heads flash in accordance with the Signal Plans.
- Program phases 4 and 8 for Dual Entry.
- Enable Simultaneous Gap-Out for all phases.
- Program phases 2 and 6 for Start Up In Green.
- Program phases 2 and 6 for Yellow Flash, and overlap 1 as Wag Overlaps.
- The cabinet and controller are part of the Asheville Signal System.

**EQUIPMENT INFORMATION**

CONTROLLER.....2070E  
 CABINET.....332 W/ AUX  
 SOFTWARE.....ECONOLITE OASIS  
 CABINET MOUNT.....BASE  
 OUTPUT FILE POSITIONS...18 WITH AUX. OUTPUT FILE  
 LOAD SWITCHES USED.....S1,S2,S5,S7,S8,S11,AUX S1,AUX S4.  
 PHASES USED.....1,2,4,5,6,8.  
 OVERLAP "A".....1+2  
 OVERLAP "B".....NOT USED  
 OVERLAP "C".....5+6  
 OVERLAP "D".....NOT USED

**SIGNAL HEAD HOOK-UP CHART**

LOAD SWITCH NO.	S1	S2	S3	S4	S5	S6	S7	S8	S9	S10	S11	S12	AUX S1	AUX S2	AUX S3	AUX S4	AUX S5	AUX S6
CMU CHANNEL NO.	1	2	13	3	4	14	5	6	15	7	8	16	9	10	17	11	12	18
PHASE	1	2	2 PED	3	4	4 PED	5	6	6 PED	7	8	8 PED	OLA	OLB	SPARE	OLC	OLD	SPARE
SIGNAL HEAD NO.	11	82	21,22	NU	NU	41,42	NU	51	61,62	NU	NU	81,82	NU	11	NU	NU	51	NU
RED		*	128			101			134			107						
YELLOW			129			102		*	135			108						
GREEN			130			103			136			109						
RED ARROW													A121					A114
YELLOW ARROW		126											A122					A115
FLASHING YELLOW ARROW													A123					A116
GREEN ARROW	127	127							133									

NU = Not Used

\* Denotes install load resistor. See load resistor installation detail this sheet.

\* See pictorial of head wiring in detail below.

**4 SECTION FYA PPLT SIGNAL WIRING DETAIL**

*(wire signal heads as shown)*

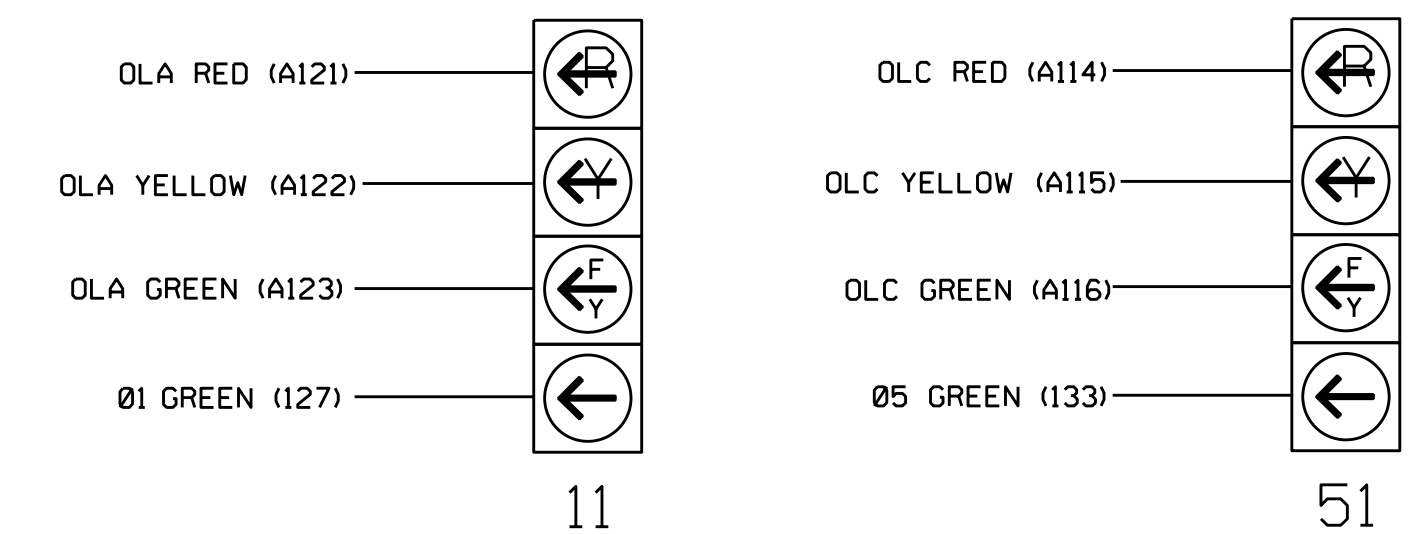

**NOTE**

- The sequence display for these signals require special logic programming. See sheet 2 of 2 for programming instructions.

**INPUT FILE POSITION LAYOUT**

*(front view)*

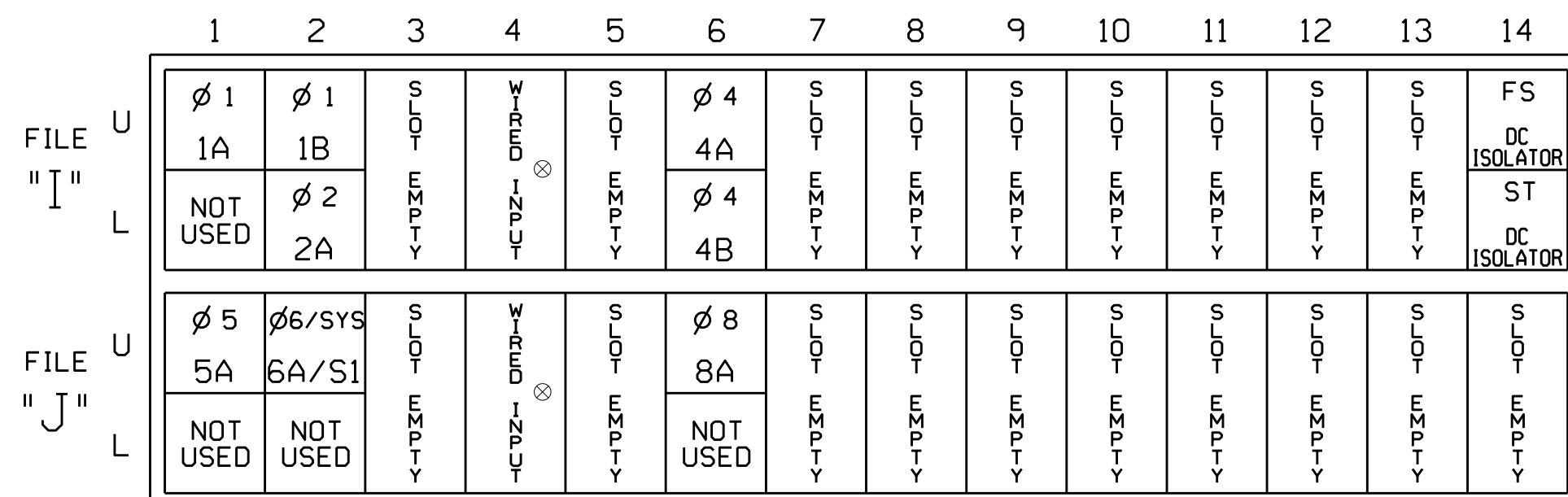

EX.: 1A, 2A, ETC. = LOOP NO.'S

FS = FLASH SENSE  
 ST = STOP TIME

⊗ Wired Input - Do not populate slot with detector card

**INPUT FILE CONNECTION & PROGRAMMING CHART**

LOOP NO.	LOOP TERMINAL	INPUT FILE POS.	PIN NO.	INPUT ASSIGNMENT NO.	DETECTOR NO.	NEMA PHASE	CALL	EXTEND	FULL TIME DELAY	STRETCH TIME	DELAY TIME
1A <sup>1</sup>	TB2-1,2	I1U	56	18	1	1	Y	Y			15
	-	J4U	48	10	26	6	Y	Y			
1B	TB2-5,6	I2U	39	1	2	1	Y	Y			15
2A	TB2-7,8	I2L	43	5	12	2	Y	Y			
4A	TB4-9,10	I6U	41	3	4	4	Y	Y			
4B	TB4-11,12	I6L	45	7	14	4	Y	Y			5
5A <sup>2</sup>	TB3-1,2	J1U	55	17	5	5	Y	Y			15
	-	I4U	47	9	22	2	Y	Y			
6A/S1	TB3-5,6	J2U	40	2	6	6	Y	Y			
8A	TB5-9,10	J6U	42	4	8	8	Y	Y			

<sup>1</sup>Add jumper from I1-W to J4-W, on rear of input file.

<sup>2</sup>Add jumper from J1-W to I4-W, on rear of input file.

INPUT FILE POSITION LEGEND: J2L

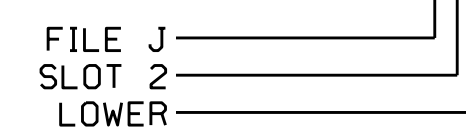

**LOAD RESISTOR INSTALLATION DETAIL**

*(install resistors as shown below)*

VALUE (ohms)	WATTAGE
1.5K - 1.9K	25W (min)
2.0K - 3.0K	10W (min)

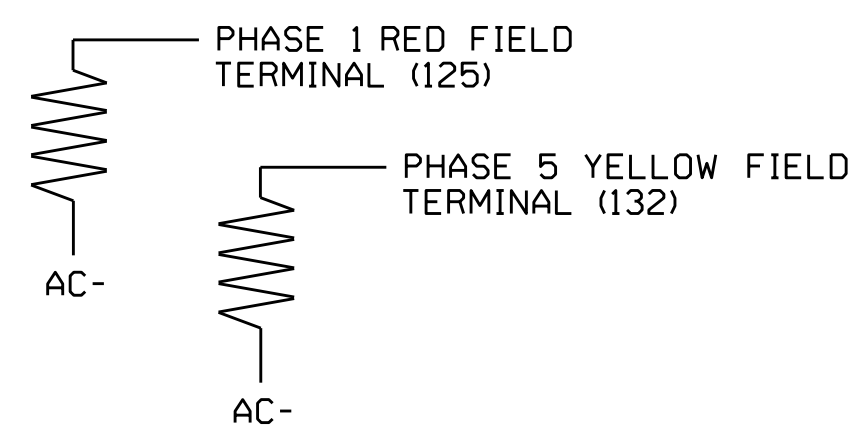

Electrical Detail Sheet 1 of 2

DOCUMENT NOT CONSIDERED FINAL UNLESS ALL SIGNATURES COMPLETED

Electrical and Programming Details For:  
 US 25 (Weaverville Rd.) / US 19-23 Bus. (Weaverville Rd.) at N. Merrimon Avenue / US 19-23-25 & I-26 Ramps

Division 13 Buncombe County Asheville

PLAN DATE: July 2016 REVIEWED BY: K.M. Mims  
 PREPARED BY: Z.M. Little REVIEWED BY:

REVISIONS: INIT. DATE

750 N. Greenfield Pkwy, Garner, NC 27529

Seal of the State of North Carolina, Professional Engineer, Keith M. Mims, No. 036880

DocuSigned by: Keith M. Mims 8/18/2016  
 SIG. INVENTORY NO. 13-0553