

# MONTGOMERY CO. TYPICALS

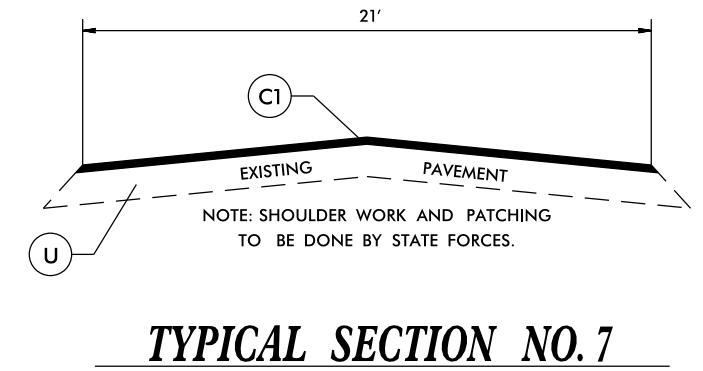
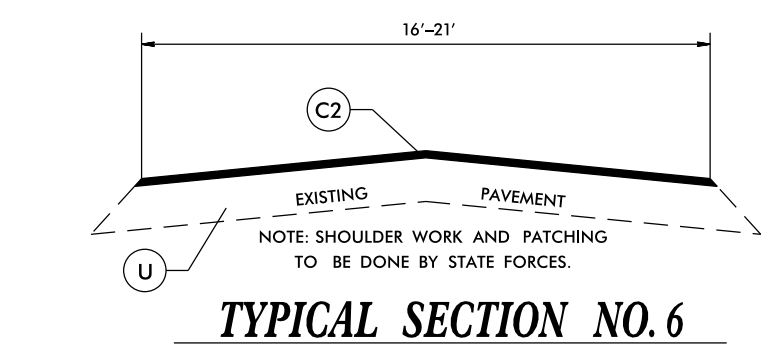
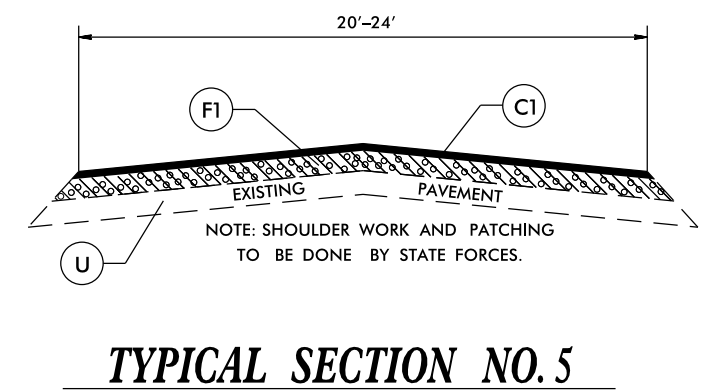
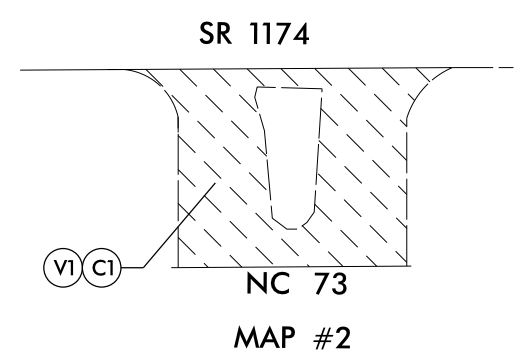
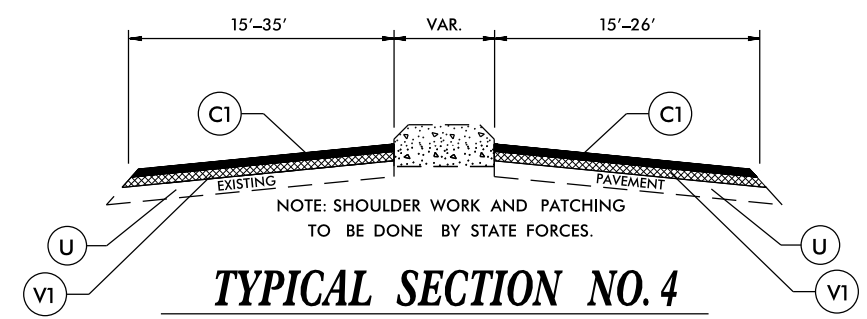
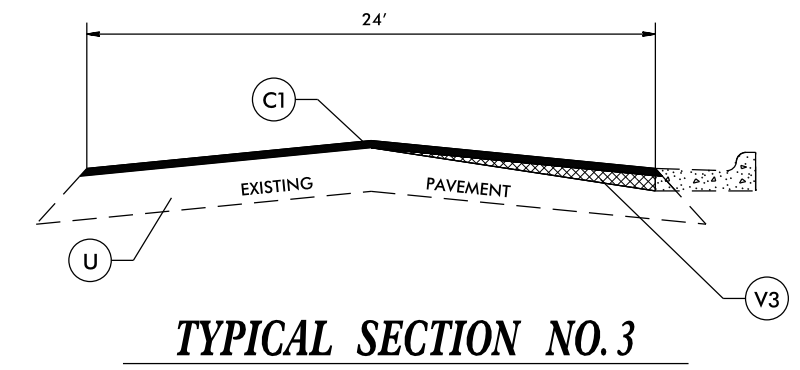
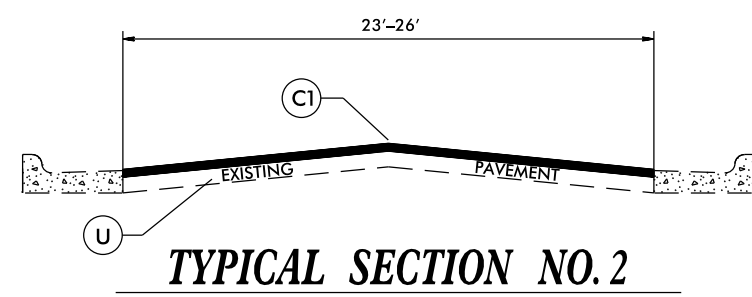
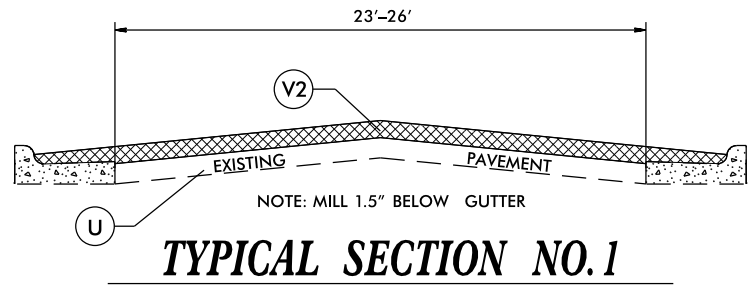

PAVEMENT SCHEDULE	
C1	PROP. APPROX. 1.5" ASPHALT CONCRETE SURFACE COURSE, TYPE S9.5B, AT AN AVERAGE RATE OF 168 LBS. PER SQ. YD.
C2	PROP. APPROX. 1.25" ASPHALT CONCRETE SURFACE COURSE, TYPE SF9.5A, AT AN AVERAGE RATE OF 137.5 LBS. PER SQ. YD.
F1	PROPOSED ASPHALT SURFACE TREATMENT, MATCOAT #78 STONE
U	EXISTING PAVEMENT.
V1	1.5" MILLING
V2	3" MILLING
V3	0" - 1.5" MILLING