

SEE NOTE BELOW
ELEVATION
WEST FACE

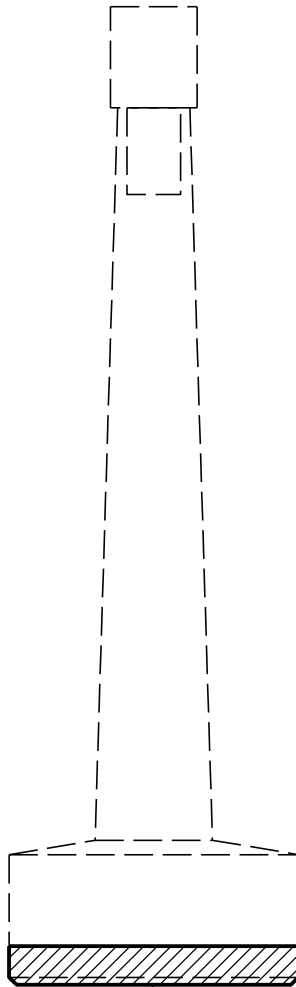

SEE NOTE BELOW
SIDE VIEW
SOUTH FACE

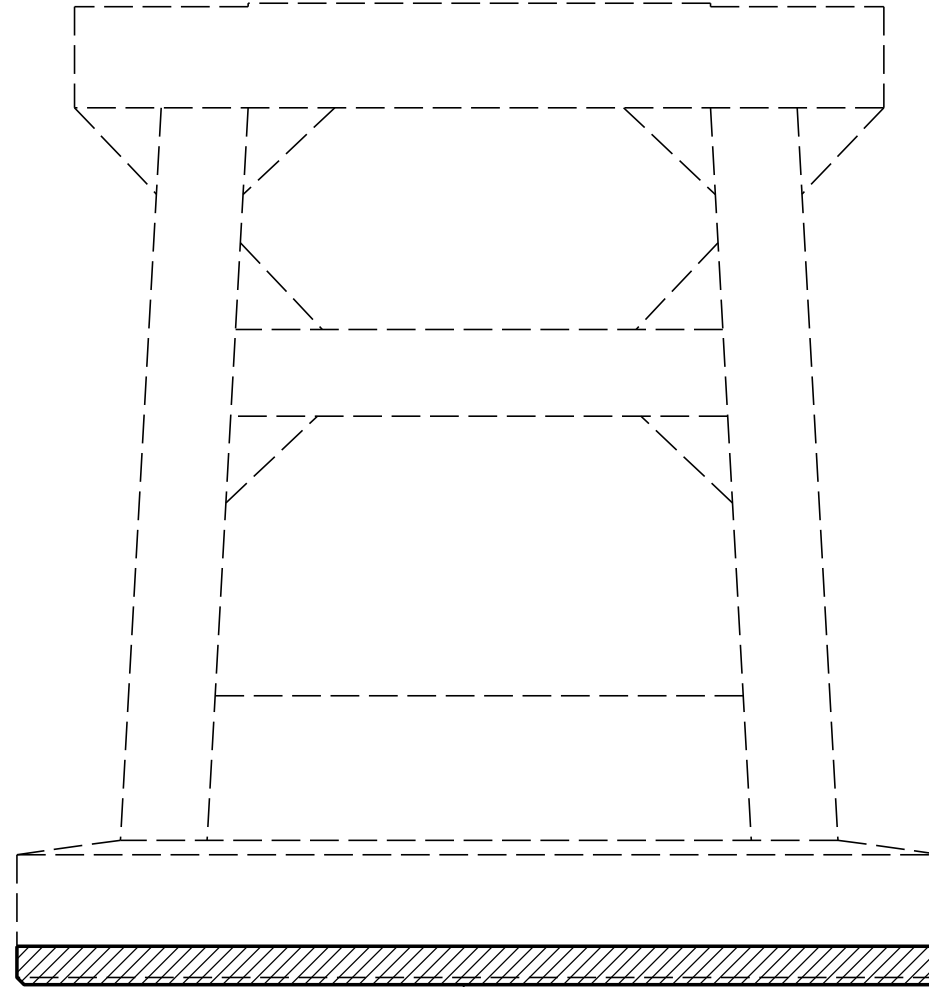

SEE NOTE BELOW
ELEVATION
EAST FACE

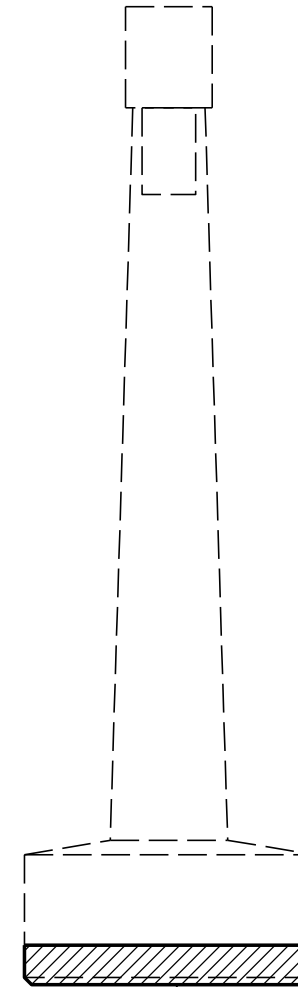

SEE NOTE BELOW
SIDE VIEW
NORTH FACE

NOTE - SEE CHANNEL BENT FOOTING RESTORATION SHEET



PROPOSED REPAIR AREAS



SUBSTRUCTURE SPALL/DELAMINATION

DocuSigned by:
Samuel Cullum
19C97095C75A467...

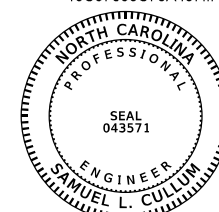

12/13/2016

PROJECT NO. B-5937
CURRITUCK/DARE COUNTY
STATION: BRIDGE NO. 16

STATE OF NORTH CAROLINA
DEPARTMENT OF TRANSPORTATION
RALEIGH

SUBSTRUCTURE CONC.
REPAIR - BENT 177

DRAWN BY : J. B. HANNA DATE : 07-16
CHECKED BY : S. L. CULLUM DATE : 07-16
DESIGN ENGINEER OF RECORD: S. L. CULLUM DATE : 07-16

*****SYSTEM*****
*****SDGN*****
*****USERNAME*****

DOCUMENT NOT CONSIDERED
FINAL UNLESS ALL
SIGNATURES COMPLETED

REVISIONS						SHEET NO.
NO.	BY:	DATE:	NO.	BY:	DATE:	
1			3			S-196
2			4			TOTAL SHEETS