

TYPE 4

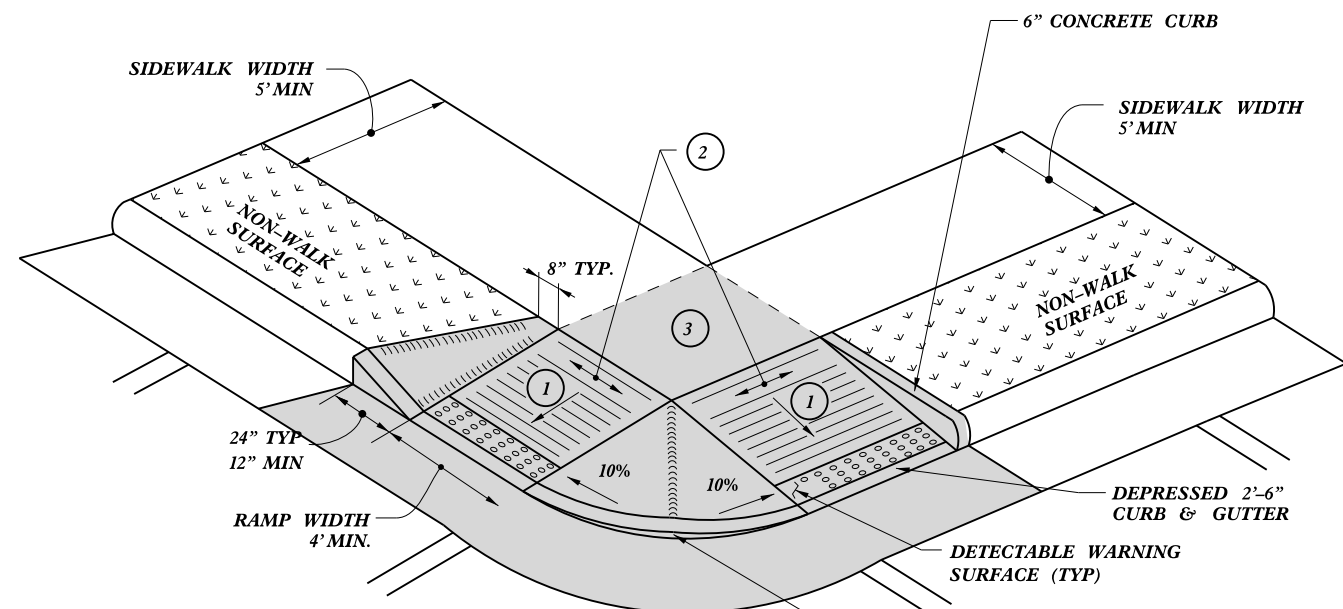

TYPE 4A

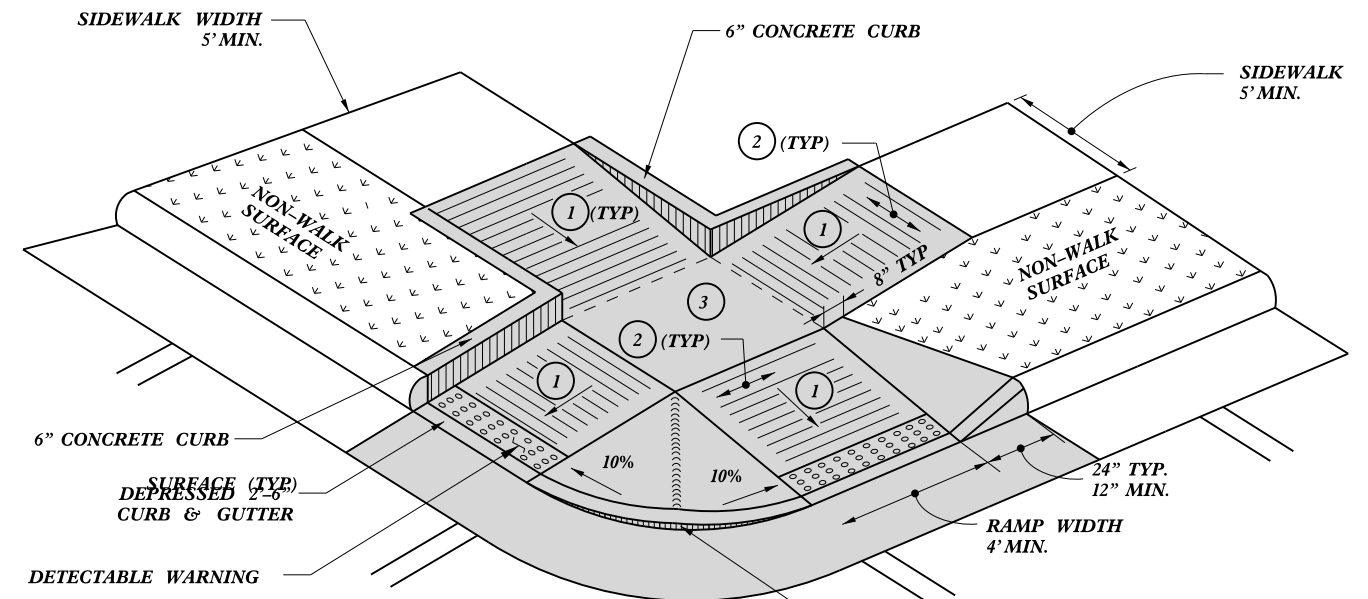

TYPE 5

PAY LIMITS FOR 2 CURB RAMPS

- 1 8.33% (12:1) MAX RAMP SLOPE
- 2 CROSS SLOPE: 2.00%
- 3 CURB RAMPS REQUIRE A (4'-0") MINIMUM LANDING WITH A MAXIMUM CROSS SLOPE AND LONGITUDINAL SLOPE OF 2.00% WHERE PEDESTRIANS PERFORM TURNING MANEUVERS. SLOPE TO DRAIN TO CURB.

DocuSigned by:
Joel S Howerton
449E8E25522144F...



11/18/2015

DOCUMENT NOT CONSIDERED FINAL UNLESS ALL SIGNATURES COMPLETED

CONTRACT STANDARDS AND DEVELOPMENT UNIT
Office 919-707-6950 FAX 919-250-4119

CURB RAMPS
Shared Landing

ORIGINAL BY: J.S. HOWERTON DATE: 7/7/11
MODIFIED BY: DATE:
CHECKED BY: DATE:
FILE SPEC: stds/2012CurbRamp/CurbRampDetails.dwg

REFER TO ROADWAY STANDARD DRAWING NUMBER 848.05 SHEET 3 OF 3 FOR ALL RAMP NOTES

5/14/1999