

REPAIR QUANTITY TABLE

REPAIRS BENT 45	QUANTITIES			
	ESTIMATE		ACTUAL	
SHOTCRETE REPAIRS	AREA SF	VOLUME CF	AREA SF	VOLUME CF
CAP (VERTICAL FACE)	7.7	3.2		
CAP (HORIZONTAL, CORNER)	0.0	0.0		
EPOXY RESIN INJECTION		LN. FT.		LN. FT.
CAP		0.0		

VALUES IN CHART REPRESENT ESTIMATED REPAIR TOTALS AFTER REMOVAL OF UNSOUND CONCRETE, MIN. OF 1" BEHIND REBAR AND MIN. 2" CL TO SAWCUT. SEE REPAIR DETAILS.

NOTES:

REPAIR LOCATIONS AND ESTIMATE OF QUANTITIES ARE GIVEN WITH THE BEST INFORMATION AVAILABLE. IF ADDITIONAL REPAIRS NOT SHOWN ON THE DRAWINGS ARE DEEMED NECESSARY BY THE INSPECTOR OR ENGINEER THE CONTRACTOR SHALL NOTE ON THE DRAWINGS THE APPROXIMATE LOCATION AND DESCRIPTION OF THE REPAIRS AND ADJUST THE ACTUAL QUANTITIES ENTERED INTO THE REPAIR QUANTITY TABLE.

FOR CAP REPAIR DETAILS, SEE "TYPICAL CAP REPAIR DETAILS" SHEET.

FOR "SHOTCRETE REPAIRS", SEE SPECIAL PROVISIONS.

FOR "EPOXY RESIN INJECTION", SEE SPECIAL PROVISIONS.

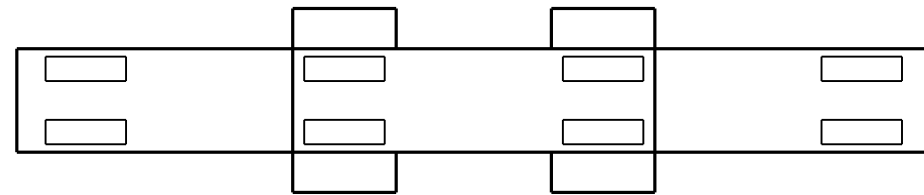

PLAN
TOP OF CAP

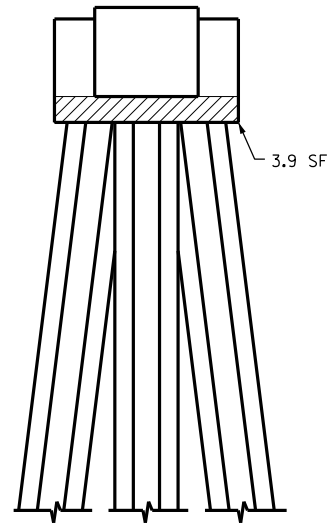

END VIEW
NORTH SIDE

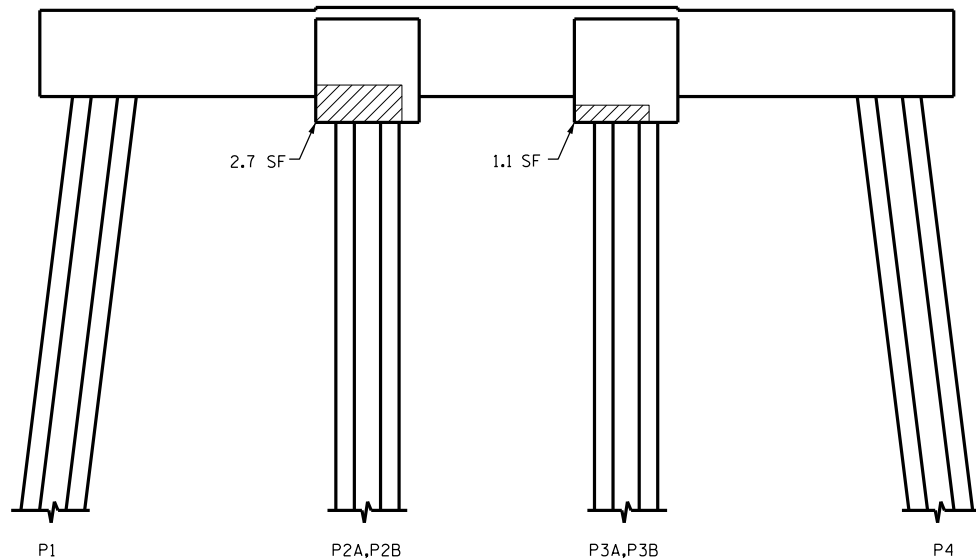

ELEVATION
WEST SIDE

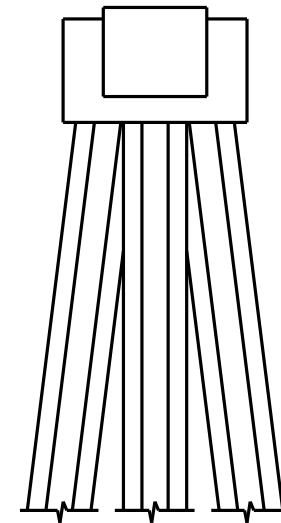

END VIEW
SOUTH SIDE

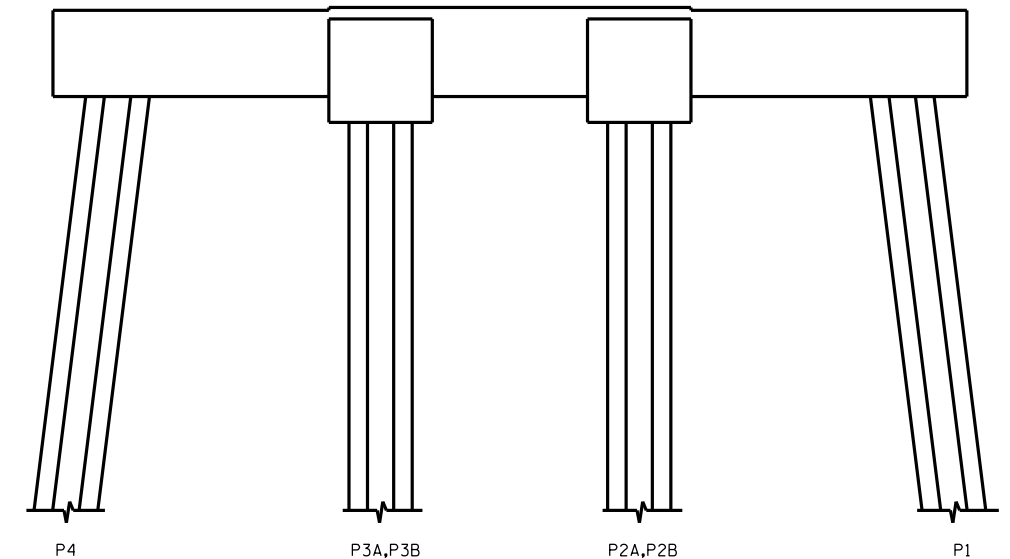

ELEVATION
EAST SIDE

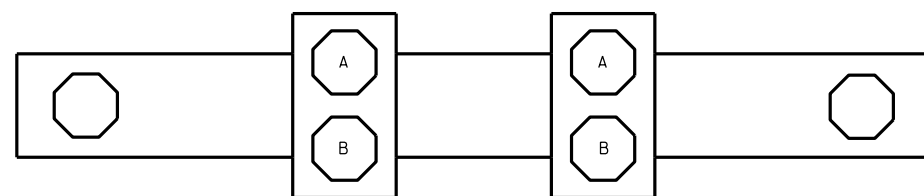

PLAN
BOTTOM OF CAP

- SHOTCRETE REPAIR
 - EPOXY RESIN INJECTION

PROJECT NO. B-5936
TYRRELL COUNTY
BRIDGE NO. 7

DocuSigned by:
Paul Bryant 2016

3653D2AF1B77448

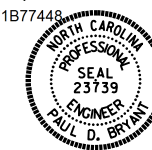

STATE OF NORTH CAROLINA
DEPARTMENT OF TRANSPORTATION
RALEIGH

BENT 45

DRAWN BY : P. D. BRYANT DATE : 4-2016
CHECKED BY : W. M. CLARKE DATE : 4-2016

DOCUMENT NOT CONSIDERED
FINAL UNLESS ALL
SIGNATURES COMPLETED

REVISIONS						SHEET NO.
NO.	BY:	DATE:	NO.	BY:	DATE:	TOTAL SHEETS
1			3			S-82
2			4			394