

NOTES:

REPAIR LOCATIONS AND ESTIMATE OF QUANTITIES ARE GIVEN WITH THE BEST INFORMATION AVAILABLE. IF ADDITIONAL REPAIRS NOT SHOWN ON THE DRAWINGS ARE DEEMED NECESSARY BY THE INSPECTOR OR ENGINEER THE CONTRACTOR SHALL NOTE ON THE DRAWINGS THE APPROXIMATE LOCATION AND DESCRIPTION OF THE REPAIRS AND ADJUST THE ACTUAL QUANTITIES ENTERED INTO THE REPAIR QUANTITY TABLE.

FOR CAP REPAIR DETAILS, SEE "TYPICAL CAP REPAIR DETAILS" SHEET.

FOR "SHOTCRETE REPAIRS", SEE SPECIAL PROVISIONS.

FOR "EPOXY RESIN INJECTION", SEE SPECIAL PROVISIONS.

REPAIR QUANTITY TABLE

REPAIRS BENT 12	QUANTITIES			
	ESTIMATE		ACTUAL	
SHOTCRETE REPAIRS	AREA SF	VOLUME CF	AREA SF	VOLUME CF
CAP (VERTICAL FACE)	3.3	1.4		
CAP (HORIZONTAL, CORNER)	0.0	0.0		
EPOXY RESIN INJECTION		LN. FT.		LN. FT.
CAP		0.0		

VALUES IN CHART REPRESENT ESTIMATED REPAIR TOTALS AFTER REMOVAL OF UNSOUND CONCRETE, MIN. OF 1" BEHIND REBAR AND MIN. 2" CL TO SAWCUT. SEE REPAIR DETAILS.



SPAN 13
SPAN 12

PLAN
TOP OF CAP

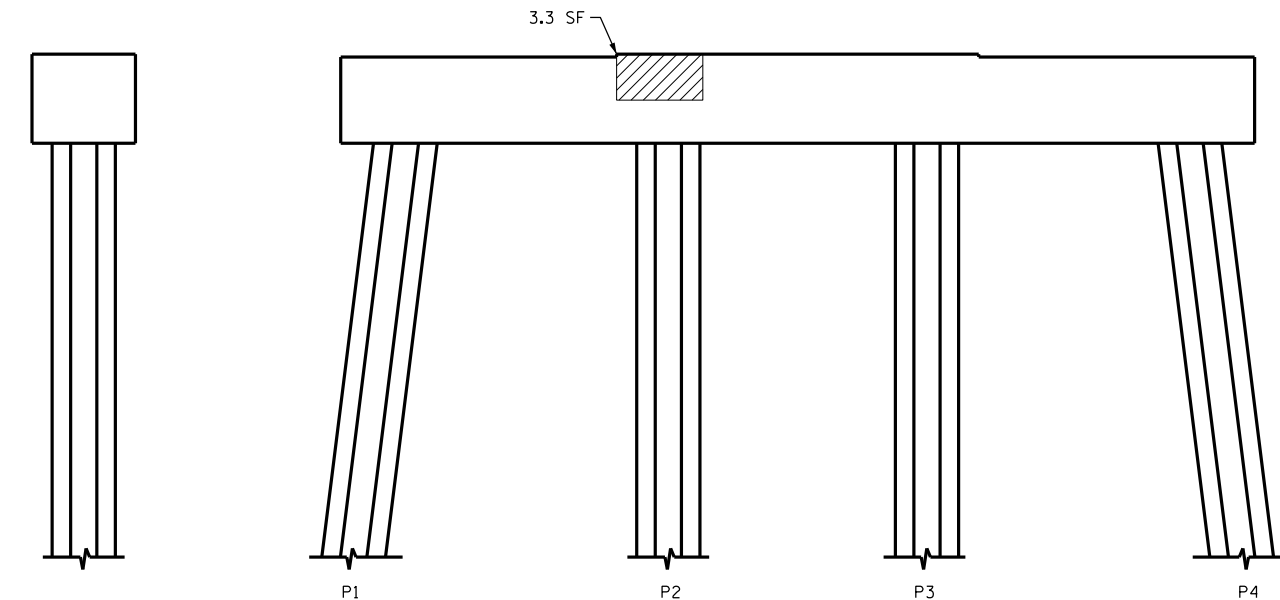

END VIEW
NORTH SIDE

ELEVATION
WEST SIDE

END VIEW
SOUTH SIDE

ELEVATION
EAST SIDE

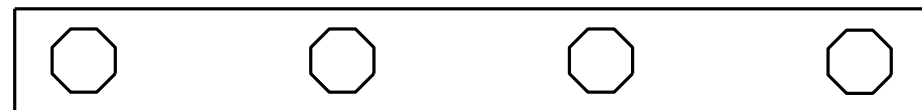

SPAN 12
SPAN 13

PLAN
BOTTOM OF CAP

▨ - SHOTCRETE REPAIR
ERI - EPOXY RESIN INJECTION

DocuSigned by:
Paul Bryant 10/2016
3653D2AF1B77448...



PROJECT NO. B-5936
TYRRELL COUNTY
BRIDGE NO. 7

STATE OF NORTH CAROLINA
DEPARTMENT OF TRANSPORTATION
RALEIGH

BENT 12

DRAWN BY : P. D. BRYANT DATE : 4-2016
CHECKED BY : W. M. CLARKE DATE : 4-2016

DOCUMENT NOT CONSIDERED
FINAL UNLESS ALL
SIGNATURES COMPLETED

REVISIONS						SHEET NO.
NO.	BY:	DATE:	NO.	BY:	DATE:	TOTAL SHEETS
1			3			S-49
2			4			394