

BEGIN CONSTRUCTION
-Y10- STA. 11+50

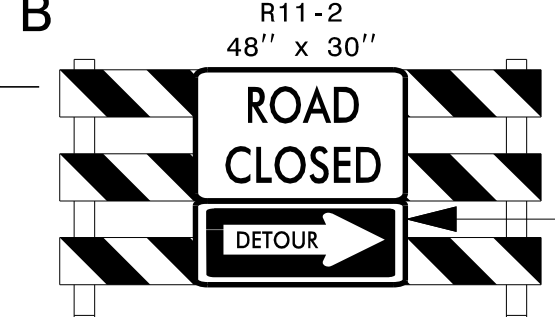

MATCHLINE -L- STA 100+00 SEE SHEET 21

MATCHLINE -L- STA 113+25 SEE SHEET 23

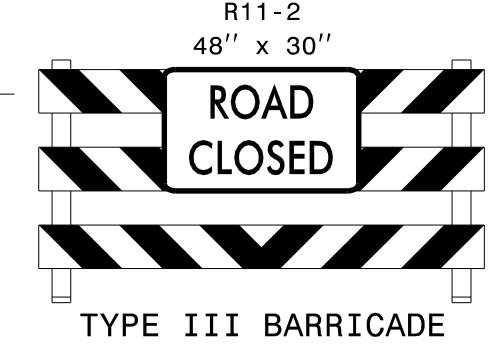
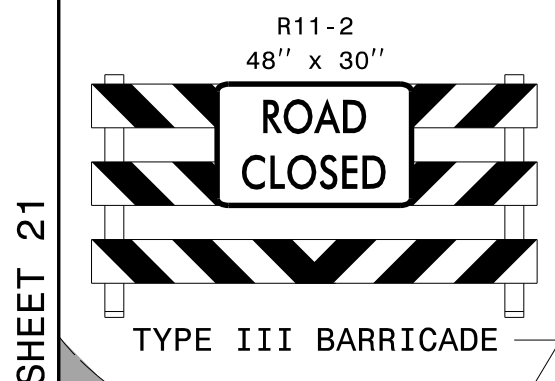
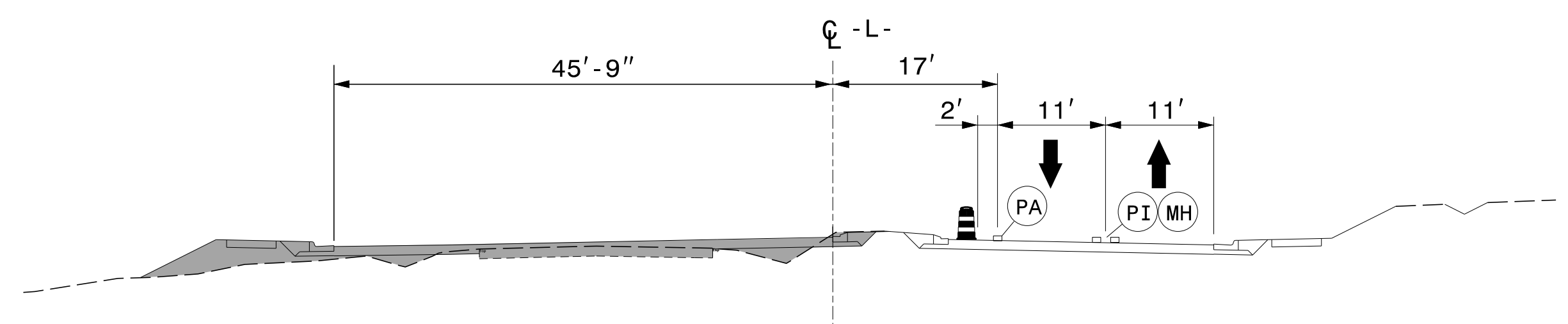
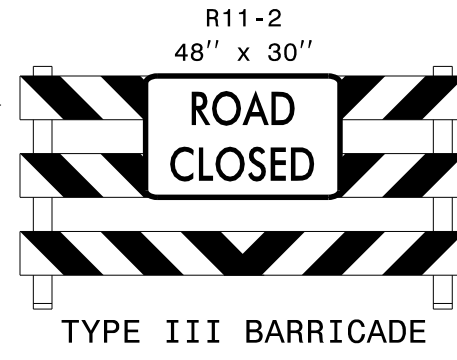
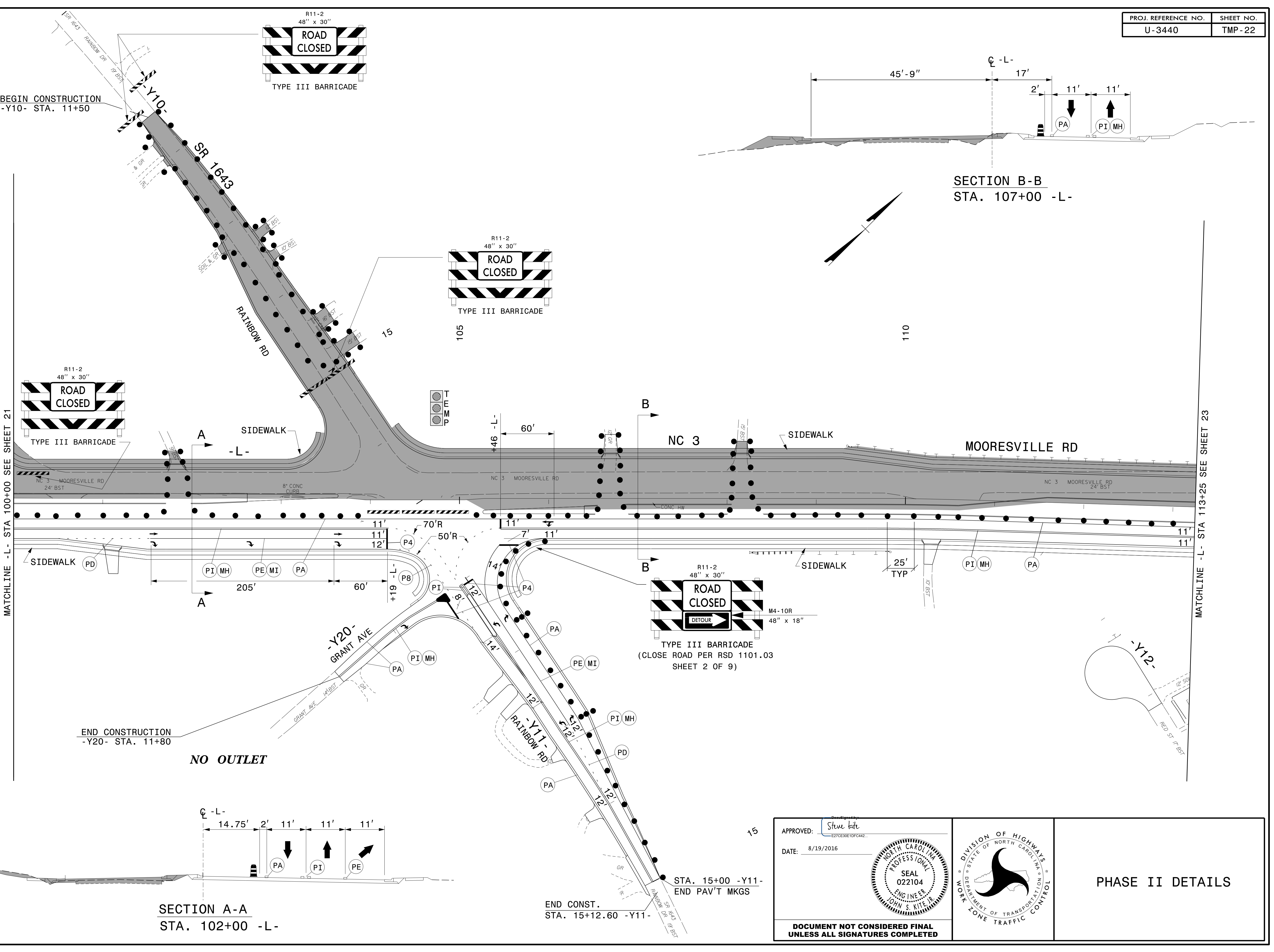

8/17/2016
P:\TIP\Projects-U\3440\Traffic\TrafficControl\TCP\tmp-11-phase2.dgn
User:rmgarratt

APPROVED: *Stew Kite*
DATE: 8/19/2016

**DOCUMENT NOT CONSIDERED FINAL
UNLESS ALL SIGNATURES COMPLETED**

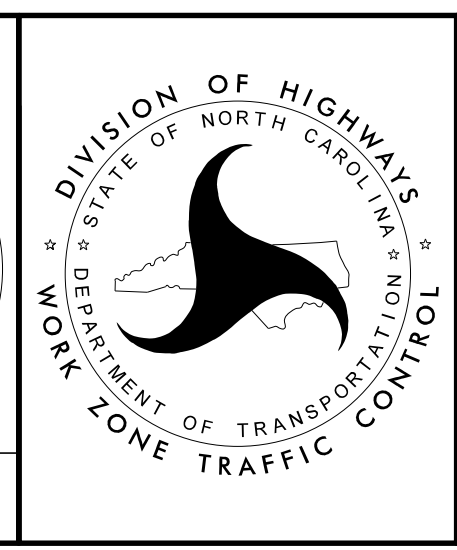

PHASE II DETAILS