

**This electronic collection of documents is provided
for the convenience of the user
and is Not a Certified Document –**

**The documents contained herein were originally issued
and sealed by the individuals whose names and license
numbers appear on each page, on the dates appearing
with their signature on that page.**

**This file or an individual page
shall not be considered a certified document.**

T.I.P.: R-2915C

CONTRACT:

**STATE OF NORTH CAROLINA
DEPARTMENT OF TRANSPORTATION**

**SIGNING PLAN
ASHE COUNTY**

**LOCATION: US 221 FROM NORTH OF SOUTH FORK NEW RIVER
TO SOUTH OF NC 194.**

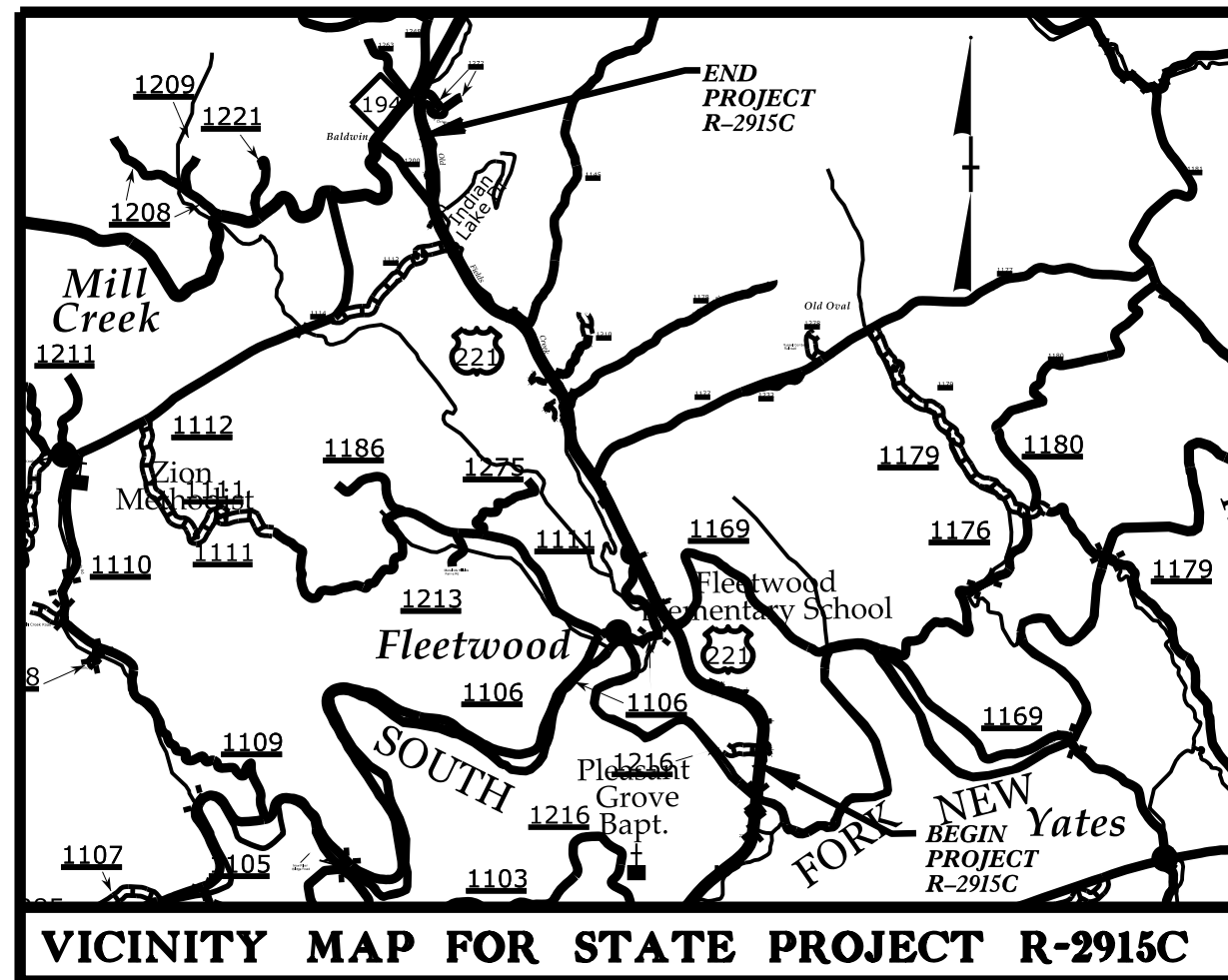

<small>TIP NO.</small> R-2915C	<small>SHEET NO.</small> SIGN-1
<small>APPROVED:</small> <i>Joseph Kopaskie</i>	
<small>DATE:</small> 6/21/2016	
<small>DOCUMENT NOT CONSIDERED FINAL UNLESS ALL SIGNATURES COMPLETED</small>	

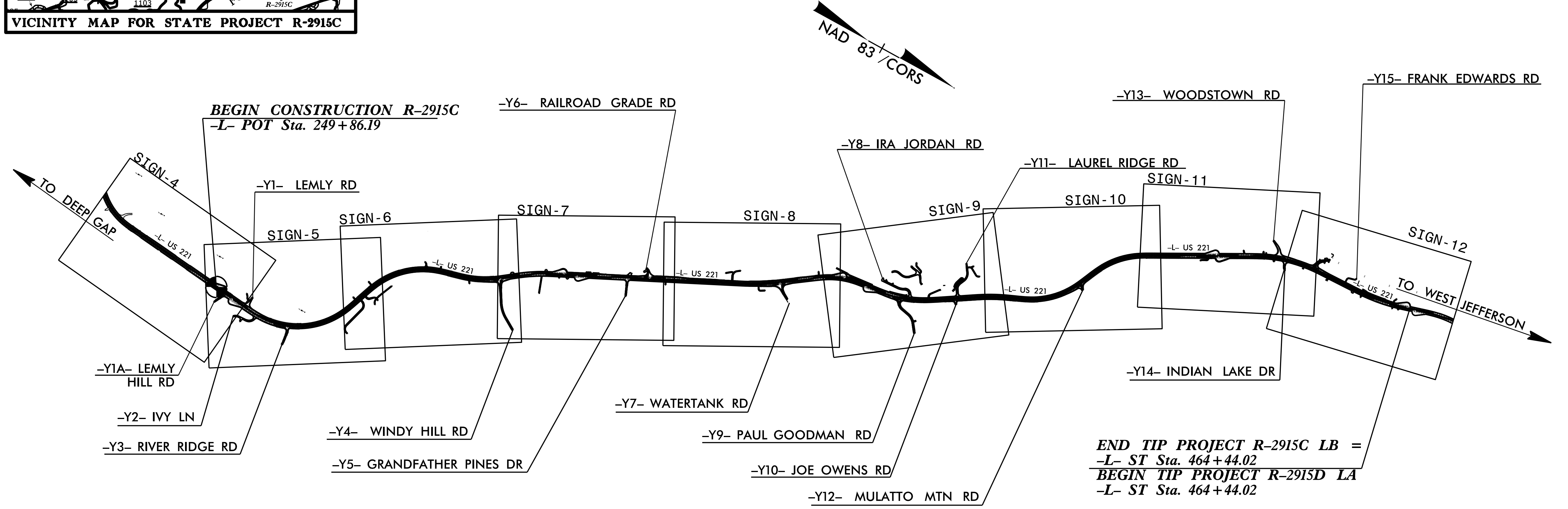

SEPI
ENGINEERING & CONSTRUCTION

1025 Wade Avenue
Raleigh, NC 27605
Tel: 919-789-9977
Fax: 919-789-9591
License: C-2197

<small>PLAN PREPARED FOR: N.C.D.O.T. SIGNING AND DELINEATION UNIT</small>	
<u>KELVIN L. JORDAN</u>	<small>SIGNING & DELINEATION REGIONAL ENGINEER</small>
<u>DERRICK H. BEARD</u>	<small>SIGNING & DELINEATION PROJECT DESIGN ENGINEER/TECHNICIAN</small>

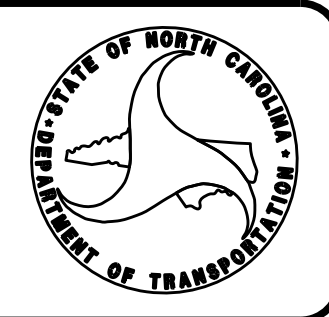

<small>PLAN PREPARED BY: SEPI ENGINEERING & CONSTRUCTION</small>	
<u>JOSEPH B. KOPASKIE, PE</u>	<small>SIGNING & DELINEATION PROJECT ENGINEER</small>
<u>RICHARD DRAYTON</u>	<small>SIGNING & DELINEATION PROJECT DESIGN ENGINEER</small>

<small>SHEET NO.</small>	<small>DESCRIPTION</small>
SIGN-1-1A	TITLE SHEET, NOTES, QUANTITIES AND SPECIFICATIONS
SIGN-2 & 2A	E & F
SIGN-3	SIGN DESIGNS
SIGN-4-12	R-2915C EXISTING & PROPOSED SIGN DETAIL SHEETS

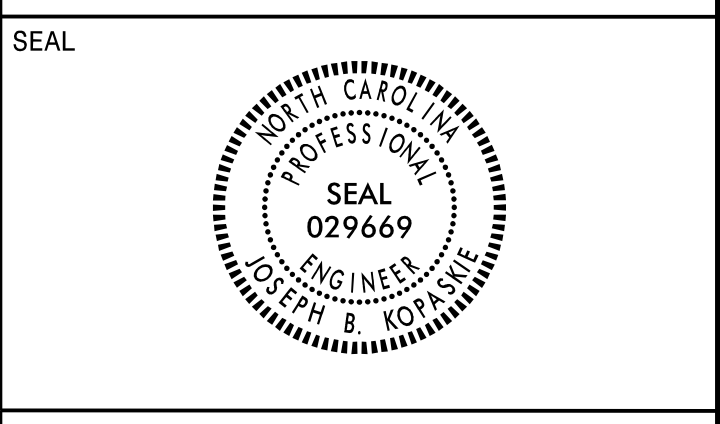

**DOCUMENT NOT CONSIDERED FINAL
UNLESS ALL SIGNATURES COMPLETED**

ROADWAY STANDARD DRAWING

THE FOLLOWING ROADWAY STANDARDS AS APPEAR IN "ROADWAY STANDARD DRAWINGS" - PROJECT SERVICES UNIT - N.C. DEPARTMENT OF TRANSPORTATION - RALEIGH, N.C., DATED JANUARY 2012 ARE APPLICABLE TO THIS PROJECT AND BY REFERENCE HEREBY ARE CONSIDERED A PART OF THESE PLANS:

STD. NO.	TITLE
904.10	ORIENTATION OF GROUND MOUNTED SIGNS
904.50	MOUNTING OF TYPE 'D', 'E' AND 'F' SIGNS ON 'U' CHANNEL POSTS

PROJECT NOTES

1. DISPOSAL OF SIGN SYSTEM, U-CHANNEL
2. SIGN ERECTION, RELOCATE SIGN TYPE E
3. DISPOSAL OF SUPPORT, U-CHANNEL
4. SIGN ERECTION, RELOCATE SIGN TYPE F

GENERAL NOTES

- . SIGNS FURNISHED BY STATE
- . IF REMOVAL OR RELOCATION OF SIGNS ON PRIVATE STREET (NON-STATE MAINTAINED) IS REQUIRED DUE TO CONSTRUCTION, THE CONTRACTOR SHALL INFORM THE ENGINEER. THE WORK WILL BE COMPLETED BY OTHERS.
- . WHEN NOT STATIONED OR DIMENSIONED ON PLANS, ALL 'E' AND 'F' SIGNS SHALL BE FIELD LOCATED BY THE ENGINEER
- . WHEN EXISTING SIGNS ARE REMOVED AND INSTALLED ON NEW SUPPORTS, THE RE-ERECTION SHALL IMMEDIATELY FOLLOW THE REMOVAL.
- . THE BACKGROUND FOR TYPE E & F SIGNS SHALL BE GRADE C REFLECTIVE SHEETING.
- . SEE ROADWAY PLANS FOR GUARD/GUIDE RAIL DETAILS.

SUMMARY OF QUANTITIES

ITEM NO.		ITEM DESCRIPTION	QUANTITY	UNIT
DESC. NO.	SECT. NO.			
4072000000	903	SUPPORTS, 3 LB STEEL U-CHANNEL	2598	L.F.
4102000000	904	SIGN ERECTION, TYPE E	133	EA.
4108000000	904	SIGN ERECTION, TYPE F	14	EA.
4116100000	904	SIGN ERECTION, RELOCATE SIGN TYPE E	1	EA.
4116100000	904	SIGN ERECTION, RELOCATE SIGN TYPE F	1	EA.
4155000000	907	DISPOSAL OF SIGN SYSTEM, U-CHANNEL	31	EA.
4192000000	907	DISPOSAL OF SUPPORT, U-CHANNEL	2	EA.

401 QUANTITY REQ'D ..16

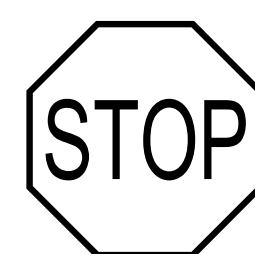

36 X 36
R1-1

TWO "U" POST PER SIGN

406 QUANTITY REQ'D ..17



54 X 18

TWO "U" POSTS PER SIGN

412 QUANTITY REQ'D ..11



36 X 24
R5-1A

ONE "U" POST PER SIGN

418 QUANTITY REQ'D ..3



36 X 36
R3-4

ONE "U" POSTS PER SIGN

TIP NO. R-2915C	SHEET NO. SIGN-2
APPROVED: <i>Joseph Kopanski</i>	
DATE: 6/21/2016	
DOCUMENT NOT CONSIDERED FINAL UNLESS ALL SIGNATURES COMPLETED	

402 QUANTITY REQ'D ..17



36 X 12
R6-1(R)

MOUNT ABOVE EXISTING STOP
SIGN IN 1 INSTALLATION
MOUNT ABOVE SIGN 401
IN 16 INSTALLATIONS

408 QUANTITY REQ'D ..2



36 X 48
R2-1

TWO "U" POSTS PER SIGN

414 QUANTITY REQ'D ..1



48" X 8"
W16-8P

(SEE SIGN-3
FOR SIGN DESIGN)
MOUNT BELOW SIGN 410
IN 1 INSTALLATION

419 QUANTITY REQ'D ..3

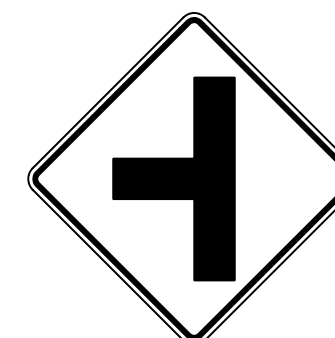

36 X 36
W2-2(L)

TWO "U" POST PER SIGN

403 QUANTITY REQ'D ..8



54 X 18
R6-1(L)

TWO "U" POSTS PER SIGN

409 QUANTITY REQ'D ..2



42" X 8"
W16-8P

(SEE SIGN-3
FOR SIGN DESIGN)
MOUNT BELOW SIGN 410
IN 1 INSTALLATION
MOUNT BELOW SIGN 419
IN 1 INSTALLATION

415 QUANTITY REQ'D ..2



42" X 8"
W16-8P

(SEE SIGN-3A
FOR SIGN DESIGN)
MOUNT BELOW SIGN 410
IN 1 INSTALLATION
MOUNT BELOW SIGN 419
IN 1 INSTALLATION

420 QUANTITY REQ'D ..1

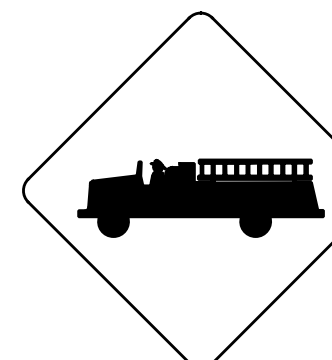

36 X 36
W11-8

ONE "U" POST PER SIGN

404 QUANTITY REQ'D ..2



30" X 18"
W16-8P

(SEE SIGN-3A
FOR SIGN DESIGN)
MOUNT BELOW SIGN 410
IN 1 INSTALLATION
MOUNT BELOW SIGN 419
IN 1 INSTALLATION

410 QUANTITY REQ'D ..5

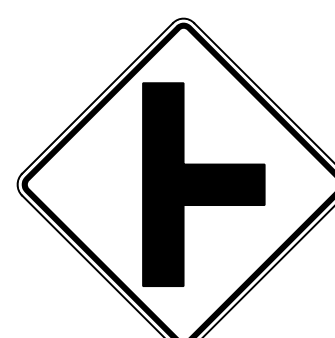

36 X 36
W2-2(R)

TWO "U" POST PER SIGN

416 QUANTITY REQ'D ..1



42" X 8"
W16-8P

(SEE SIGN-3A
FOR SIGN DESIGN)
MOUNT BELOW SIGN 410
IN 1 INSTALLATION

421 QUANTITY REQ'D ..2



36 X 36
R3-7

ONE "U" POST PER SIGN

405 QUANTITY REQ'D ..11

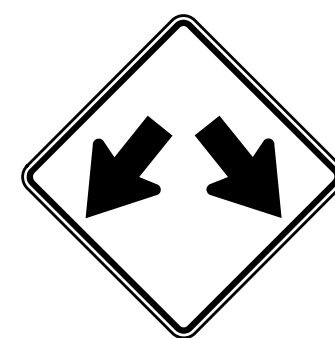

36 X 36
W12-1

ONE "U" POST PER SIGN

411 QUANTITY REQ'D ..28



36 X 36
R5-1

ONE "U" POST PER SIGN

417 QUANTITY REQ'D ..1



36 X 36
W14-1

ONE "U" POST PER SIGN

SEPI ENGINEERING & CONSTRUCTION

SEPI
ENGINEERING &
CONSTRUCTION

1025 Wade Avenue
Raleigh, NC 27605
Tel: 919-789-9977
Fax: 919-789-9591
License: C-2197

TYPE "E" SIGNS

501 505 508 513

SOUTH 1 - 36" X 18"
221 1 - 45" X 36"
 1 - 30" X 21"
 (SEE SIGN-3 FOR SIGN DESIGN)

TWO "U" POSTS PER SIGN

502 506 509 512

SOUTH 1 - 36" X 18"
221 1 - 45" X 36"

TWO "U" POSTS PER SIGN

503 504 507 510

NORTH 1 - 36" X 18"
221 1 - 45" X 36"

TWO "U" POSTS PER SIGN

511 514

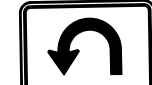
NORTH 2 - 36" X 18"
221 2 - 45" X 36"
 2 - 30" X 21"
 (SEE SIGN-3 FOR SIGN DESIGN)

TWO "U" POSTS PER SIGN

TIP NO.	SHEET NO.
R-2915C	SIGN-2A
APPROVED: <i>Joseph Kopaskie</i>	
DATE: 6/21/2016	

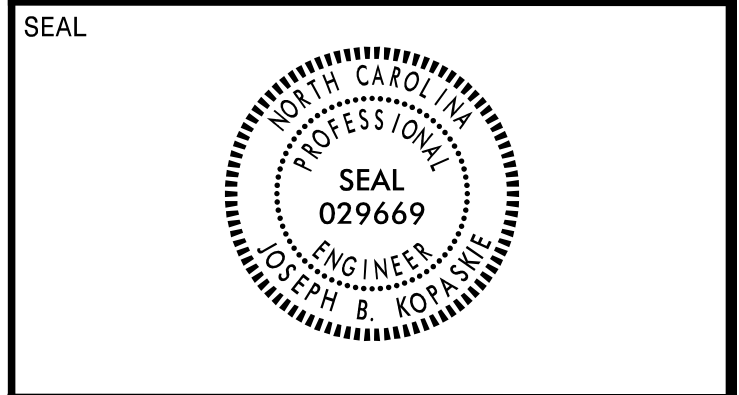

**DOCUMENT NOT CONSIDERED FINAL
 UNLESS ALL SIGNATURES COMPLETED**

\$\$\$SYTIME\$\$\$DGN\$\$\$DUPLICATE\$\$\$

SEPI 1025 Wade Avenue
 ENGINEERING & Raleigh, NC 27605
 CONSTRUCTION Tel: 919-789-9977
 Fax: 919-789-9591
 License: C-2197

TYPE "F" SIGNS

SIGN NUMBER: 404
 TYPE: E
 QUANTITY: 2
 SIGN WIDTH: 2'-6"
 HEIGHT: 1'-6"
 TOTAL AREA: 3.8 Sq.Ft.
 BORDER TYPE: FLUSH
 RECESS: 0.25"
 WIDTH: 0.38"
 RADII: 1"
 NO. Z BARS: 1
 LENGTH:

BACKG COLOR: Yellow
 COPY COLOR: Black

SYMBOL	X	Y	WID	HT

MAT'L: 0.125" (3.2 mm) ALUMINUM

DESIGN BY: R DRAYTON
 PROJECT ID: R-2915C
 CHECKED BY: J KOPASKIE
 DIV: 11
 DATE: Dec 17, 2015

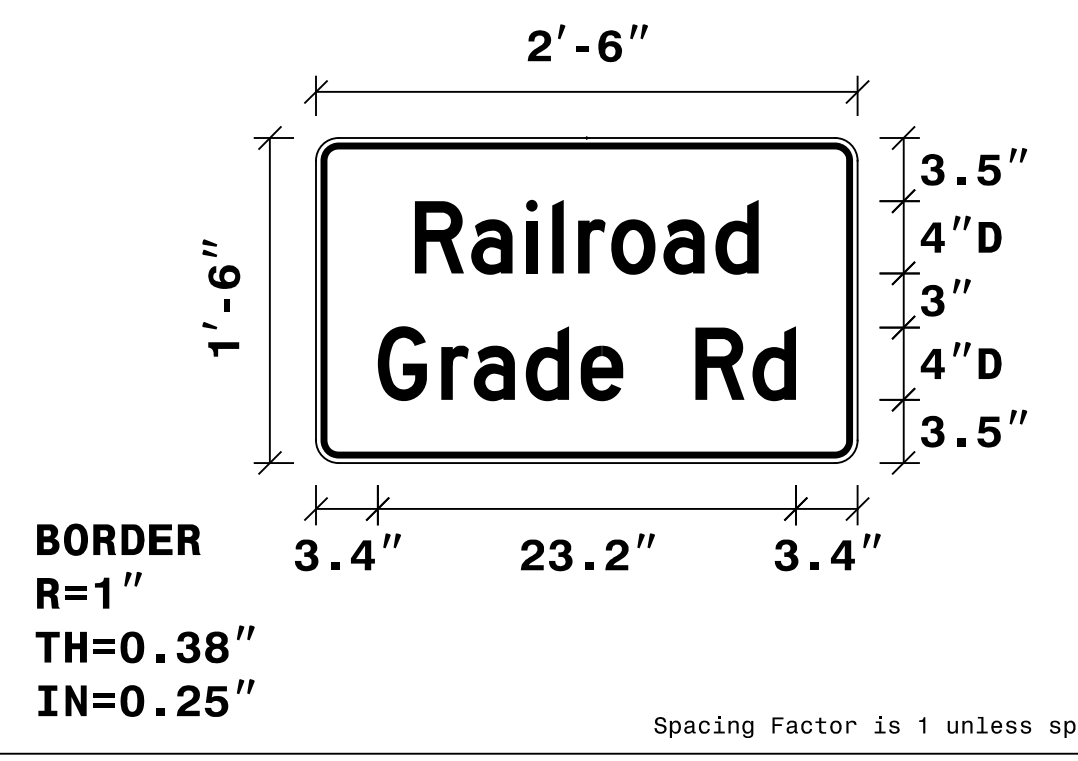

Spacing Factor is 1 unless specified otherwise

LETTER POSITIONS

Letter spacings are to start of next letter

Series/Size	Text Length
D 2000	19
D 2000	23.2

FILENAME: Signi Designs

NORTH CAROLINA D.O.T. SIGN DETAIL

SIGN NUMBER: M5-1
 TYPE: M5-1
 QUANTITY: 9
 SIGN WIDTH: 2'-6"
 HEIGHT: 1'-9"
 TOTAL AREA: 4.4 Sq.Ft.
 BORDER TYPE: FLUSH
 RECESS: 0.38"
 WIDTH: 0.63"
 RADII: 1.13"
 NO. Z BARS: 1
 LENGTH:

BACKG COLOR: White
 COPY COLOR: Black

SYMBOL	X	Y	WID	HT
U_Turn	8.5	5.2	10.5	13

MAT'L: 0.125" (3.2 mm) ALUMINUM

DESIGN BY: R Drayton
 PROJECT ID: R-2915C
 CHECKED BY: J Kopaskie
 DIV: 11
 DATE: Dec 08, 2015

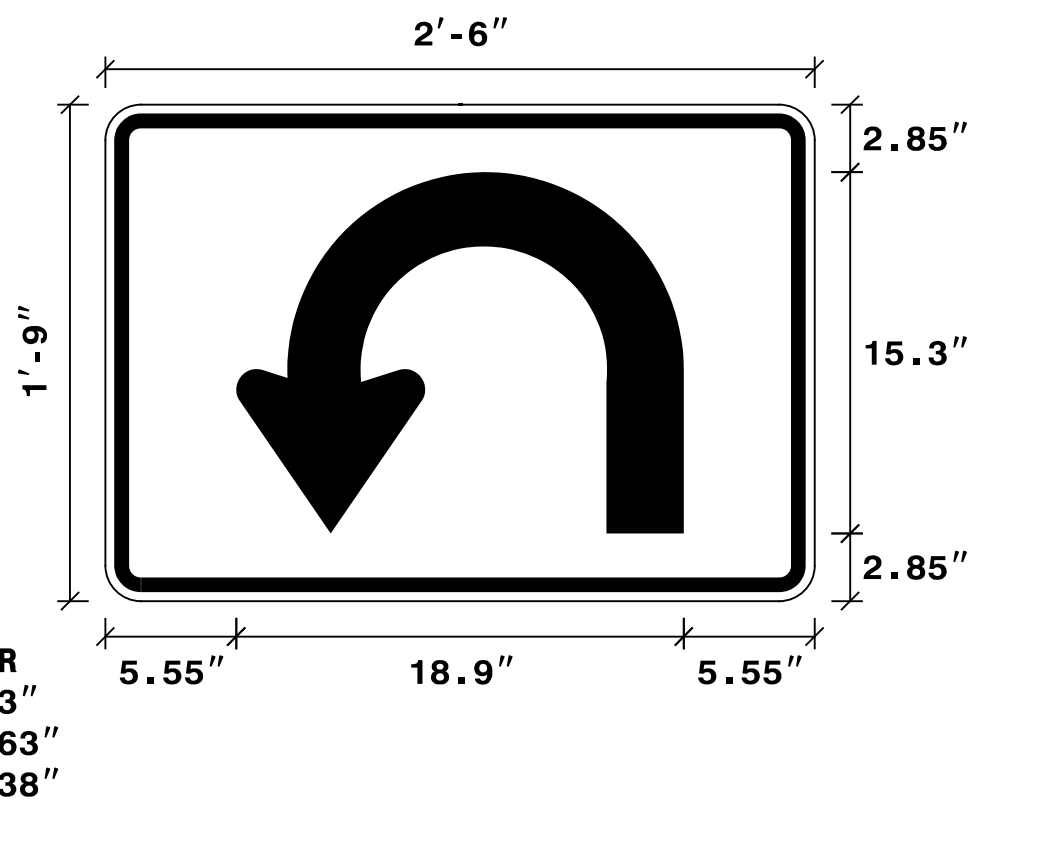

BORDER
 R=1.13"
 TH=0.63"
 IN=0.38"

MOUNT BELOW SIGN 501
 IN 1 INSTALLATION
 MOUNT BELOW SIGN 502
 IN 1 INSTALLATION
 MOUNT BELOW SIGN 505
 IN 1 INSTALLATION
 MOUNT BELOW SIGN 506
 IN 1 INSTALLATION
 MOUNT BELOW SIGN 508
 IN 1 INSTALLATION

LETTER POSITIONS

Letter spacings are to start of next letter

Series/Size	Text Length
D 2000	19
D 2000	23.2

FILENAME: Signi Designs

NORTH CAROLINA D.O.T. SIGN DETAIL

SIGN NUMBER: 409
 TYPE: E
 QUANTITY: 2
 SIGN WIDTH: 3'-6"
 HEIGHT: 0'-8"
 TOTAL AREA: 2.3 Sq.Ft.
 BORDER TYPE: FLUSH
 RECESS: 0.25"
 WIDTH: 0.38"
 RADII: 1"
 NO. Z BARS: 1
 LENGTH:

BACKG COLOR: Yellow
 COPY COLOR: Black

SYMBOL	X	Y	WID	HT

MAT'L: 0.125" (3.2 mm) ALUMINUM

DESIGN BY: R Drayton
 PROJECT ID: R-2915C
 CHECKED BY: J Kopaskie
 DIV: 11
 DATE: Dec 08, 2015

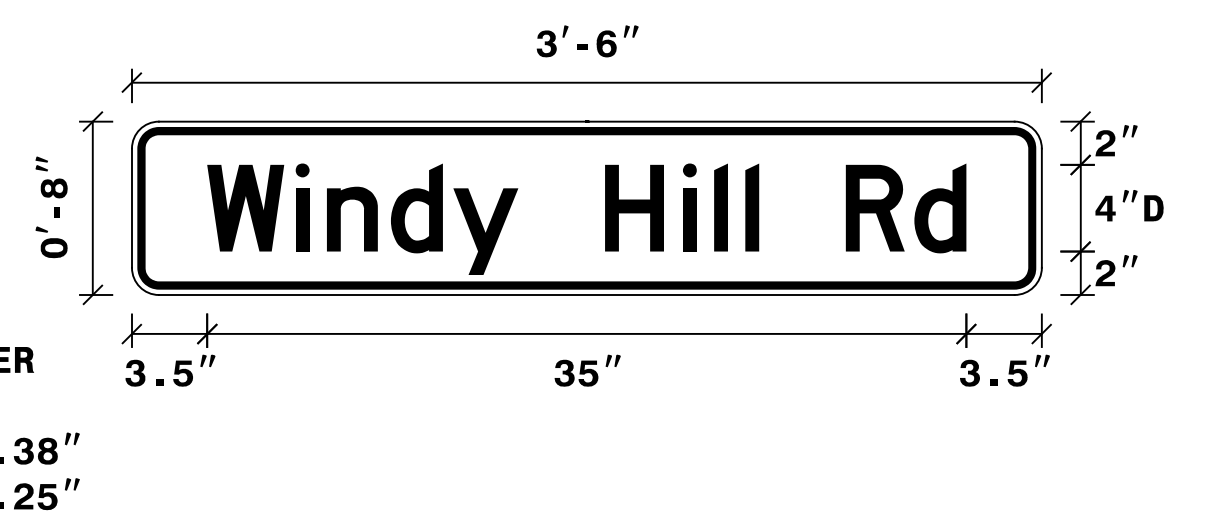

Spacing Factor is 1 unless specified otherwise

LETTER POSITIONS

Letter spacings are to start of next letter

Series/Size	Text Length
D 2000	35

FILENAME: Signi Designs

NORTH CAROLINA D.O.T. SIGN DETAIL

SIGN NUMBER: 414
 TYPE: E
 QUANTITY: 1
 SIGN WIDTH: 4'-0"
 HEIGHT: 0'-8"
 TOTAL AREA: 2.7 Sq.Ft.
 BORDER TYPE: FLUSH
 RECESS: 0.25"
 WIDTH: 0.38"
 RADII: 1"
 NO. Z BARS: 1
 LENGTH:

BACKG COLOR: Yellow
 COPY COLOR: Black

SYMBOL	X	Y	WID	HT

MAT'L: 0.125" (3.2 mm) ALUMINUM

DESIGN BY: R Drayton
 PROJECT ID: R-2915C
 CHECKED BY: J Kopaskie
 DIV: 11
 DATE: Dec 08, 2015

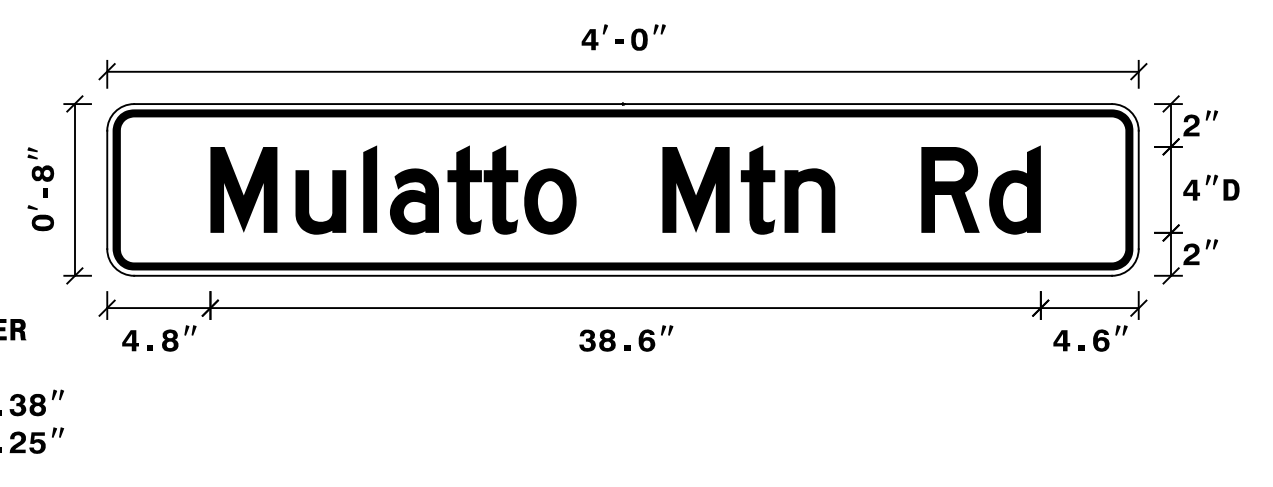

BORDER
 R=1"
 TH=0.38"
 IN=0.25"

Spacing Factor is 1 unless specified otherwise

LETTER POSITIONS

Letter spacings are to start of next letter

Series/Size	Text Length
D 2000	38.6

FILENAME: Signi Designs

NORTH CAROLINA D.O.T. SIGN DETAIL

TIP NO. R-2915C
 SHEET NO. SIGN-3
 APPROVED: Joseph Kopaskie
 DATE: 6/21/2016
 SEAL: NORTH CAROLINA PROFESSIONAL ENGINEER JOSEPH B. KOPASKIE
 DOCUMENT NOT CONSIDERED FINAL UNLESS ALL SIGNATURES COMPLETED

SYSTEMS ENGINEERING & CONSTRUCTION

SEPI
 ENGINEERING & CONSTRUCTION
 1025 Wade Avenue
 Raleigh, NC 27605
 Tel: 919-789-9977
 Fax: 919-789-9591
 License: C-2197

SIGN DESIGNS

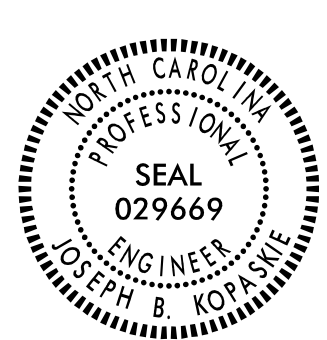
PROJECT REFERENCE NO. R-2915C	SHEET NO. SIGN-4
APPROVED: <i>Joseph Kopaske</i> <small>REGISTERED PROFESSIONAL ENGINEER</small>	
DATE: 6/21/2016	
SEAL 	
DOCUMENT NOT CONSIDERED FINAL UNLESS ALL SIGNATURES COMPLETED	

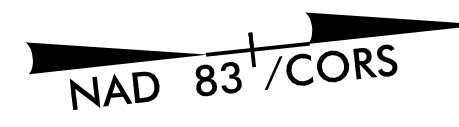

REVISIONS

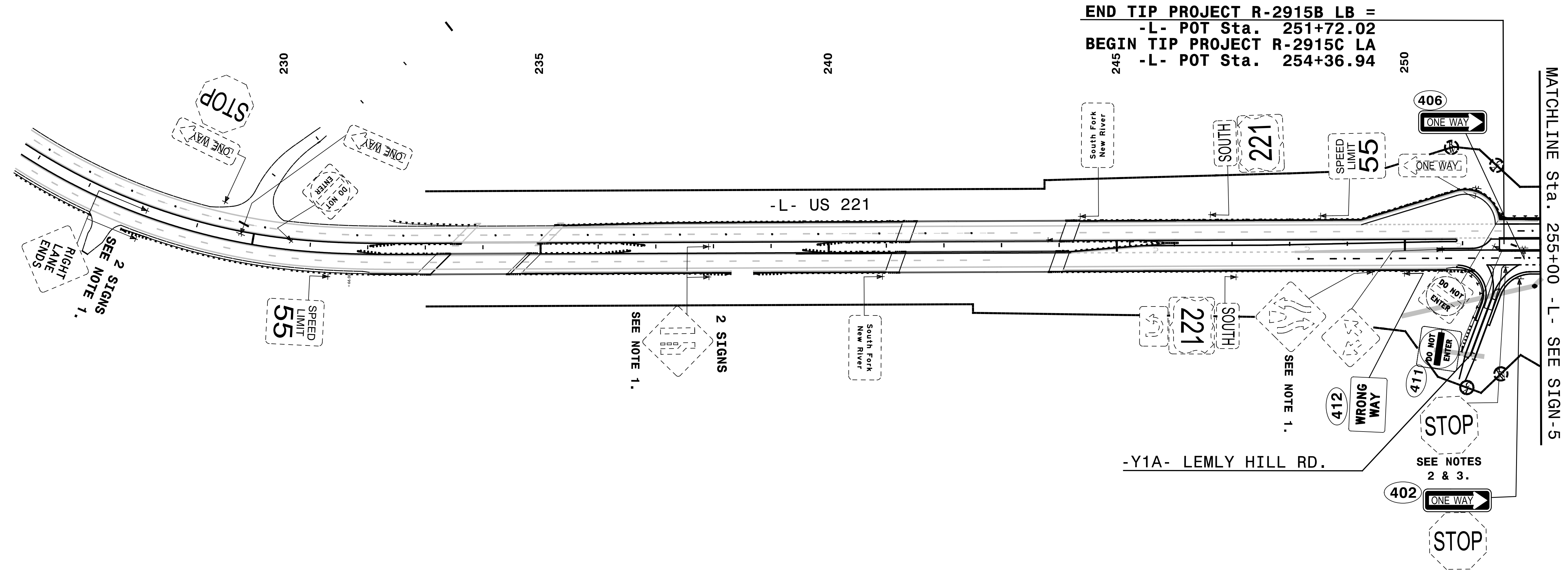

END TIP PROJECT R-2915B LB =
 -L- POT Sta. 251+72.02
BEGIN TIP PROJECT R-2915C LA
 -L- POT Sta. 254+36.94

NOTES

1. DISPOSAL OF SIGN SYSTEM, U-CHANNEL
2. SIGN ERECTION, RELOCATE SIGN TYPE E
3. DISPOSAL OF SUPPORT, U-CHANNEL
4. SIGN ERECTION, RELOCATE SIGN TYPE F

SEPI
 ENGINEERING & CONSTRUCTION
 1025 Wade Avenue
 Raleigh, NC 27605
 Tel: 919-789-9977
 Fax: 919-789-9591
 License: C-2197

**EXISTING & PROPOSED
SIGNING DETAIL**

SYSTEMS DESIGN CONSULTANTS

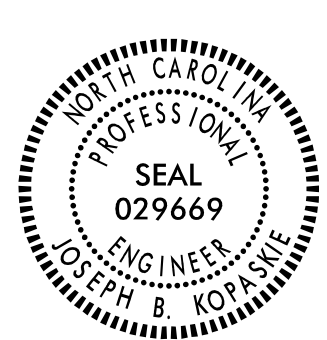
PROJECT REFERENCE NO. R-2915C	SHEET NO. SIGN-5
APPROVED: <i>Joseph Kopaske</i> <small>SCOREAE690AS4FA</small>	
DATE: 6/21/2016	
SEAL	
	
DOCUMENT NOT CONSIDERED FINAL UNLESS ALL SIGNATURES COMPLETED	

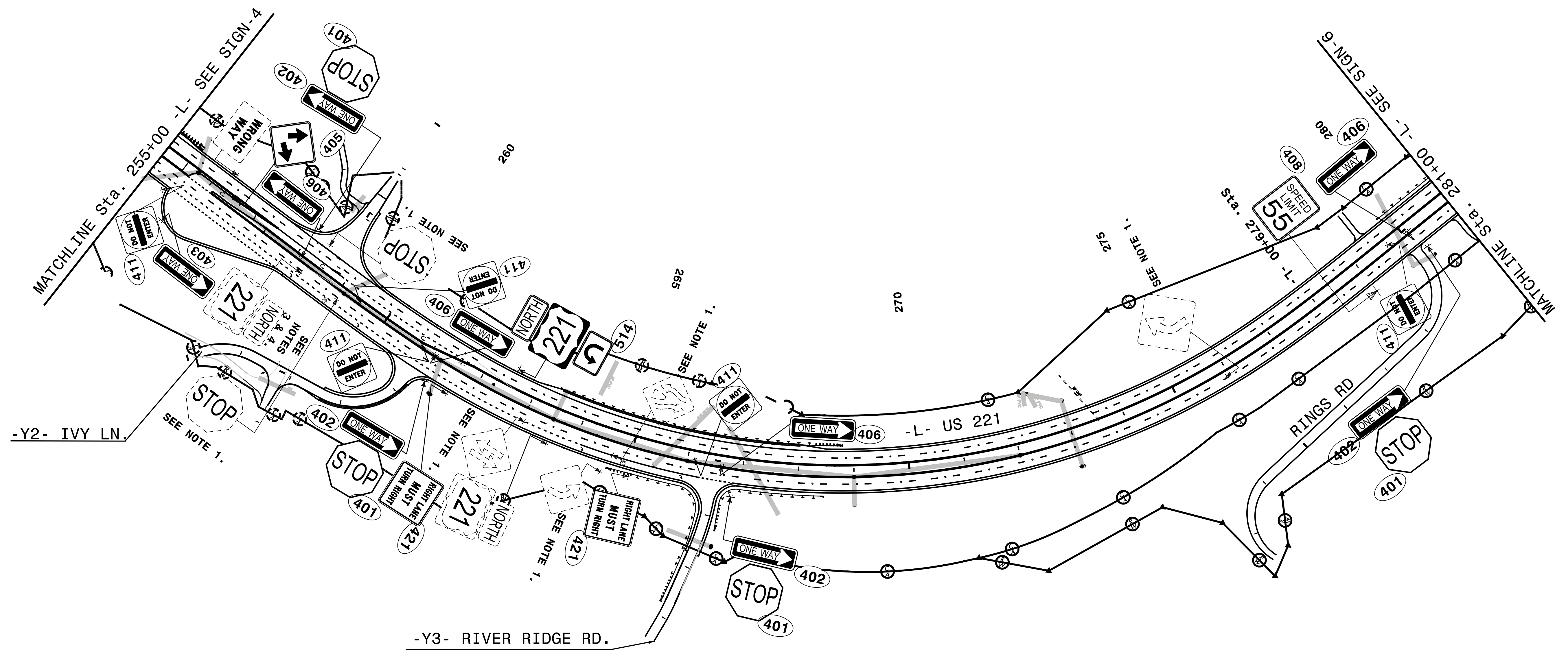
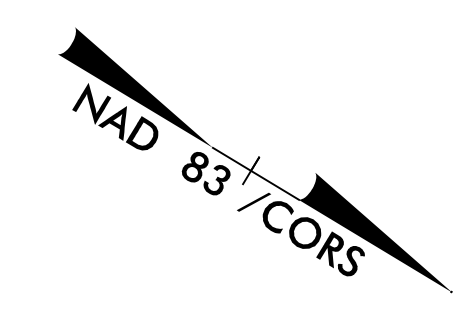

REVISIONS

NOTES

1. DISPOSAL OF SIGN SYSTEM, U-CHANNEL
3. DISPOSAL OF SUPPORT, U-CHANNEL
4. SIGN ERECTION, RELOCATE SIGN TYPE F

SEPI
ENGINEERING & CONSTRUCTION

1025 Wade Avenue
Raleigh, NC 27605
Tel: 919-789-9977
Fax: 919-789-9591
License: C-2197

**EXISTING & PROPOSED
SIGNING DETAIL**

SYSTEMS DOWN

B/17/99

REVISIONS

PROJECT REFERENCE NO. R-2915C	SHEET NO. SIGN-6
APPROVED: <i>Joseph Kopaskie</i> <small>DESIGNED BY: JOSEPH KOPASKIE</small>	
DATE: 6/21/2016	
SEAL	
	
DOCUMENT NOT CONSIDERED FINAL UNLESS ALL SIGNATURES COMPLETED	

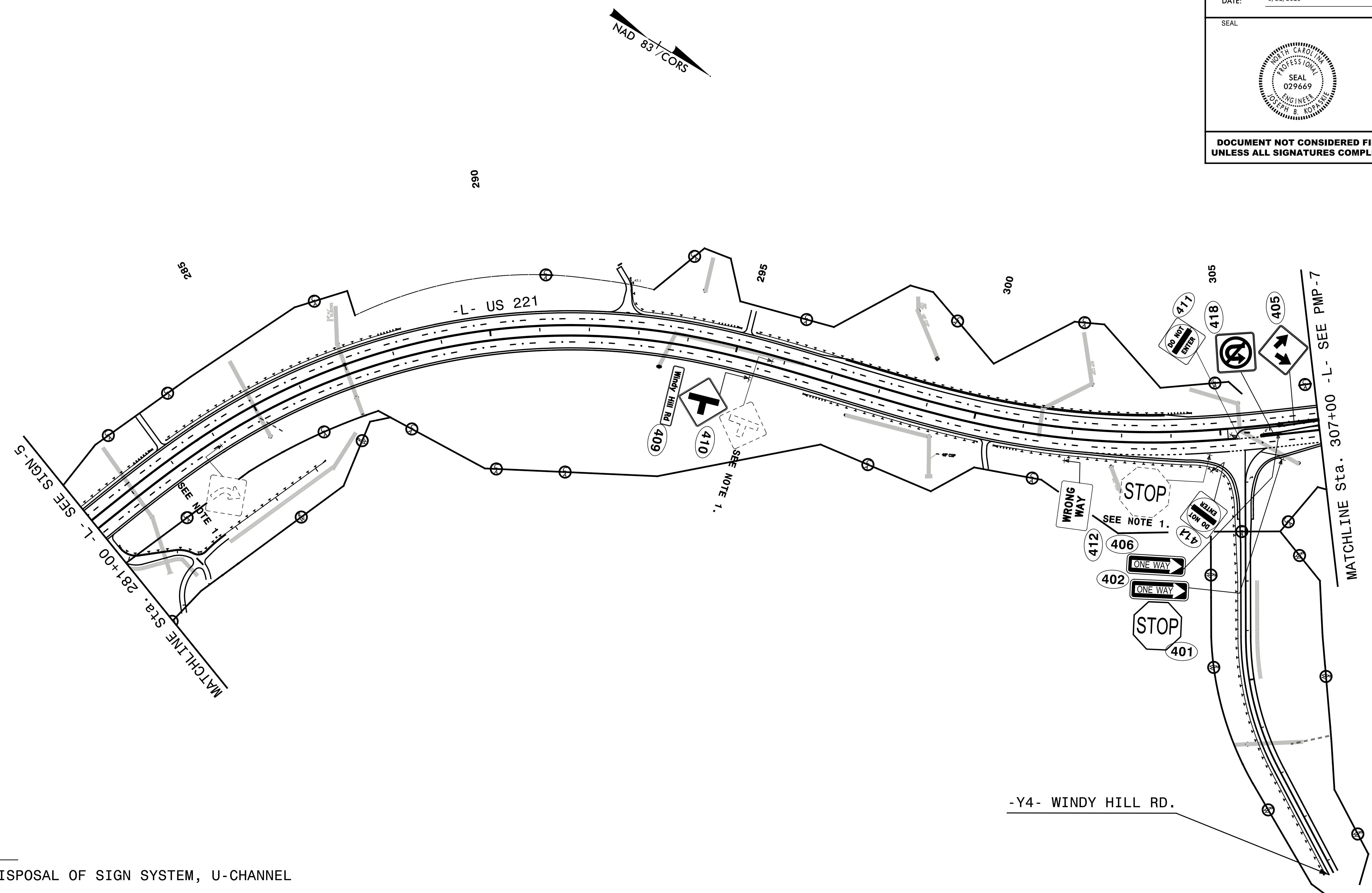

NOTE

1. DISPOSAL OF SIGN SYSTEM, U-CHANNEL

SEPI
ENGINEERING & CONSTRUCTION

1025 Wade Avenue
Raleigh, NC 27605
Tel: 919-789-9977
Fax: 919-789-9591
License: C-2197

**EXISTING & PROPOSED
SIGNING DETAIL**

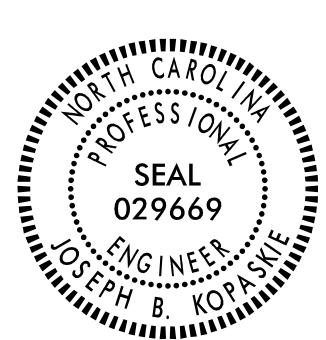
PROJECT REFERENCE NO. R-2915C	SHEET NO. SIGN-7
APPROVED: <i>Joseph Kopaske</i> <small>REGISTERED PROFESSIONAL ENGINEER</small>	
DATE: 6/21/2016	
SEAL	
	
DOCUMENT NOT CONSIDERED FINAL UNLESS ALL SIGNATURES COMPLETED	

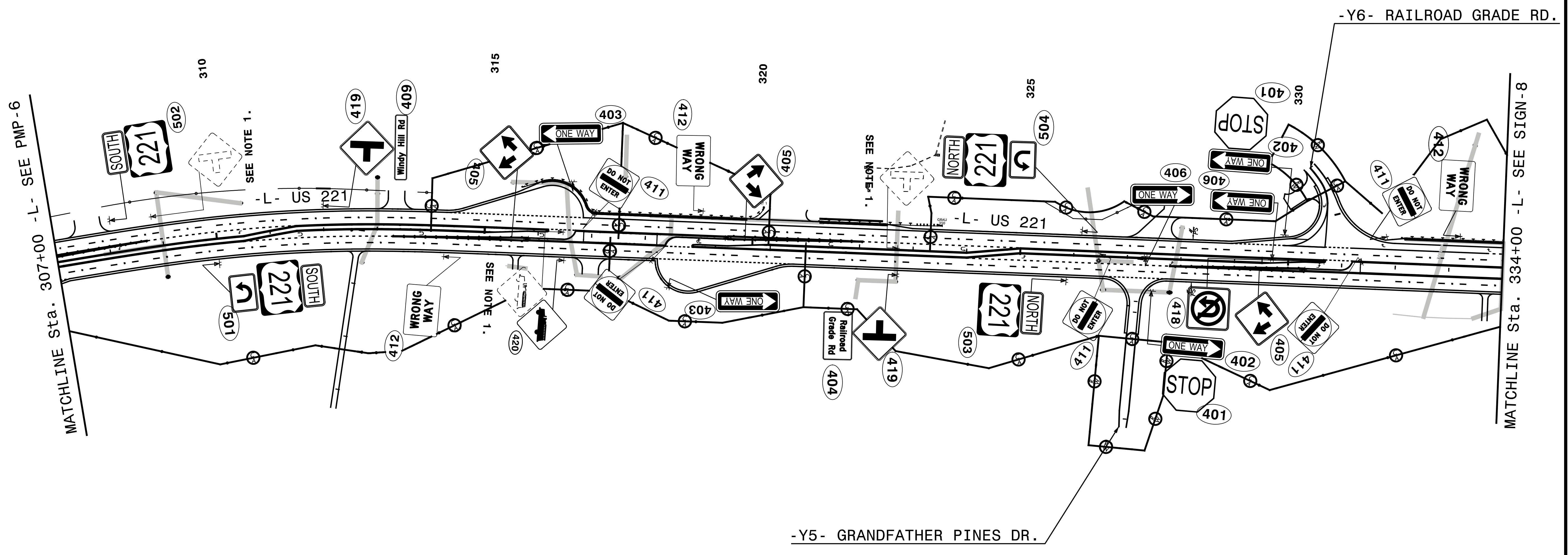
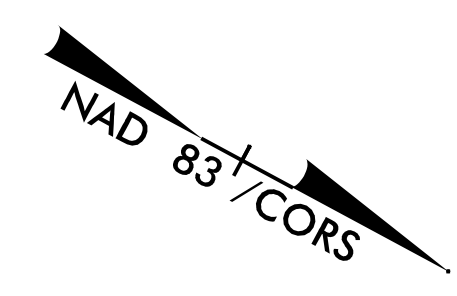

REVISIONS

NOTE

- 1. DISPOSAL OF SIGN SYSTEM, U-CHANNEL

SEPI
ENGINEERING & CONSTRUCTION

1025 Wade Avenue
Raleigh, NC 27605
Tel: 919-789-9977
Fax: 919-789-9591
License: C-2197

**EXISTING & PROPOSED
SIGNING DETAIL**

SYSTEMS
 DESIGN
 CONSULTANTS
 INC.

PROJECT REFERENCE NO. R-2915C	SHEET NO. SIGN-8
APPROVED: <i>Joseph Kopaskie</i> 0808AEEF00A54FA	
DATE: 6/21/2016	
SEAL 	
DOCUMENT NOT CONSIDERED FINAL UNLESS ALL SIGNATURES COMPLETED	

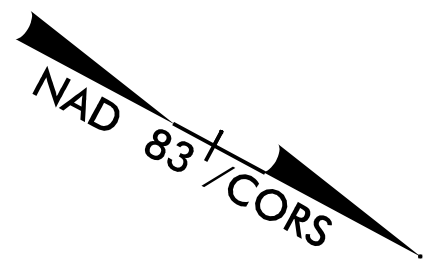

REVISIONS

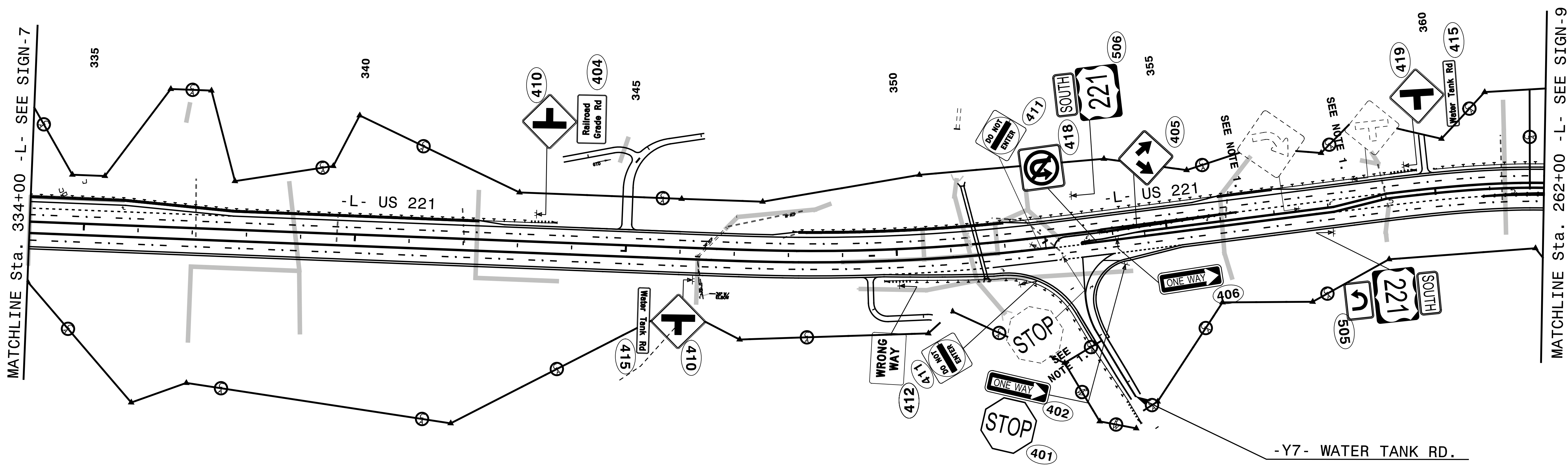

NOTE
1. DISPOSAL OF SIGN SYSTEM, U-CHANNEL

SYSTEMS DOWN

SEPI
ENGINEERING & CONSTRUCTION
1025 Wade Avenue
Raleigh, NC 27605
Tel: 919-789-9977
Fax: 919-789-9591
License: C-2197

EXISTING & PROPOSED SIGNING DETAIL

PROJECT REFERENCE NO. R-2915C	SHEET NO. SIGN-9
APPROVED: <i>Joseph Kopaskie</i> <small>REGISTERED PROFESSIONAL ENGINEER</small>	
DATE: 6/21/2016	
SEAL	
	
DOCUMENT NOT CONSIDERED FINAL UNLESS ALL SIGNATURES COMPLETED	

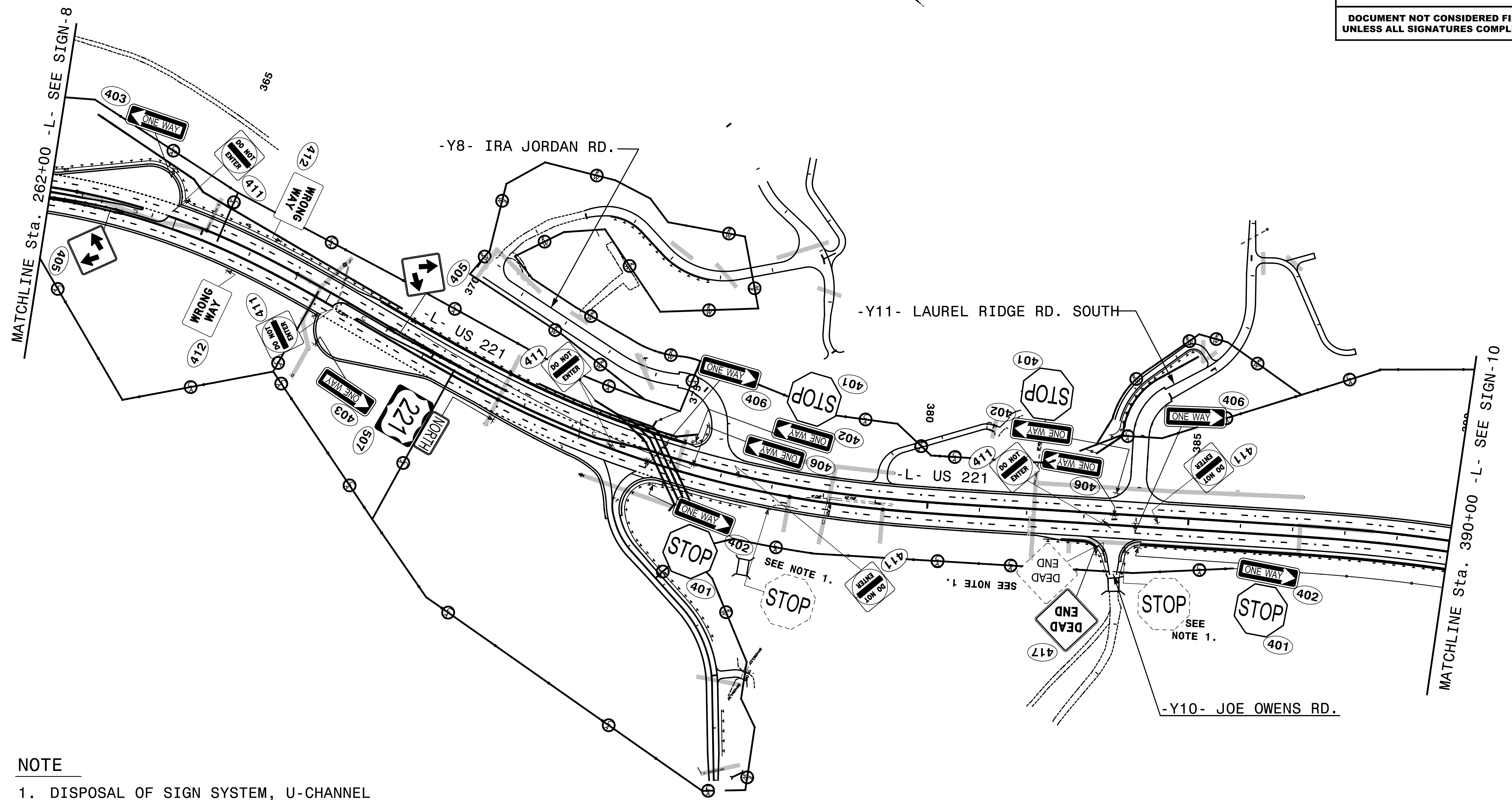
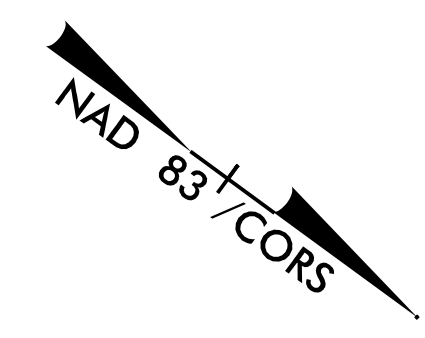

NOTE
1. DISPOSAL OF SIGN SYSTEM, U-CHANNEL

SEPI
ENGINEERING & CONSTRUCTION

1025 Wade Avenue
Raleigh, NC 27605
Tel: 919-789-9977
Fax: 919-789-9591
License: C-2197

**EXISTING & PROPOSED
SIGNING DETAIL**

8/17/99

SYSTEMS DOWN
REVISIONS

PROJECT REFERENCE NO. R-2915C	SHEET NO. SIGN-10
APPROVED: <i>Joseph Kojaske</i> <small>DocuSigned by: JOSEPH KOPASKI</small>	
DATE: 6/21/2016	
SEAL 	
DOCUMENT NOT CONSIDERED FINAL UNLESS ALL SIGNATURES COMPLETED	

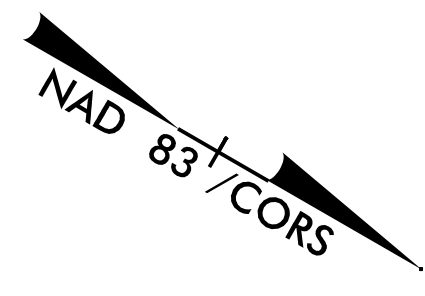

MATCHLINE Sta. 390+00 -L- SEE SIGN-9

MATCHLINE Sta. 418+00 -L- SEE SIGN-11

NOTE

- DISPOSAL OF SIGN SYSTEM, U-CHANNEL

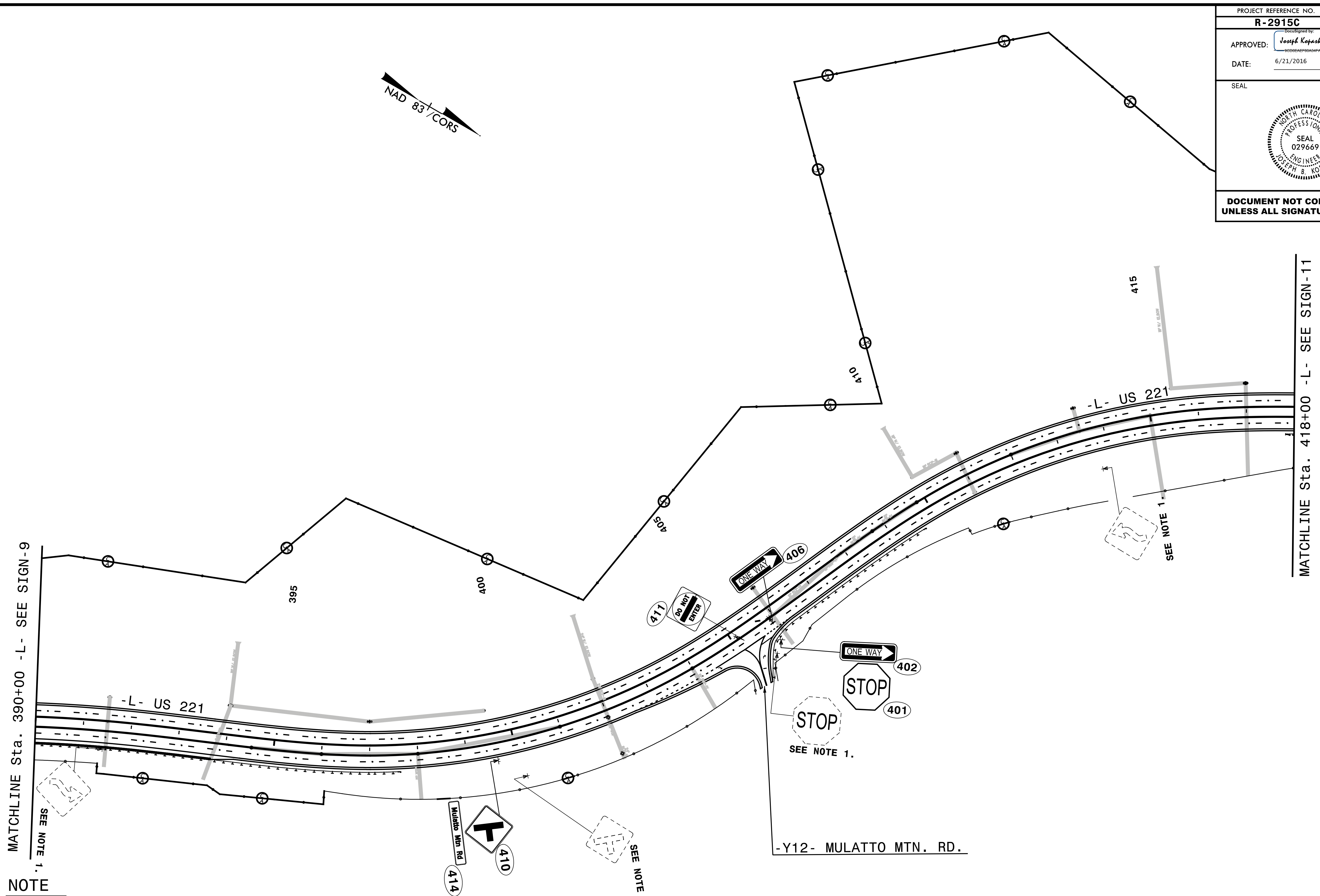

SEPI
ENGINEERING & CONSTRUCTION

1025 Wade Avenue
Raleigh, NC 27605
Tel: 919-789-9977
Fax: 919-789-9591
License: C-2197

**EXISTING & PROPOSED
SIGNING DETAIL**

PROJECT REFERENCE NO. R-2915C	SHEET NO. SIGN-11
APPROVED: <i>Joseph Kopaske</i> <small>DocuSigned by: Joseph Kopaske D00EAE6F80A84FA</small>	
DATE: 6/21/2016	
SEAL 	
DOCUMENT NOT CONSIDERED FINAL UNLESS ALL SIGNATURES COMPLETED	

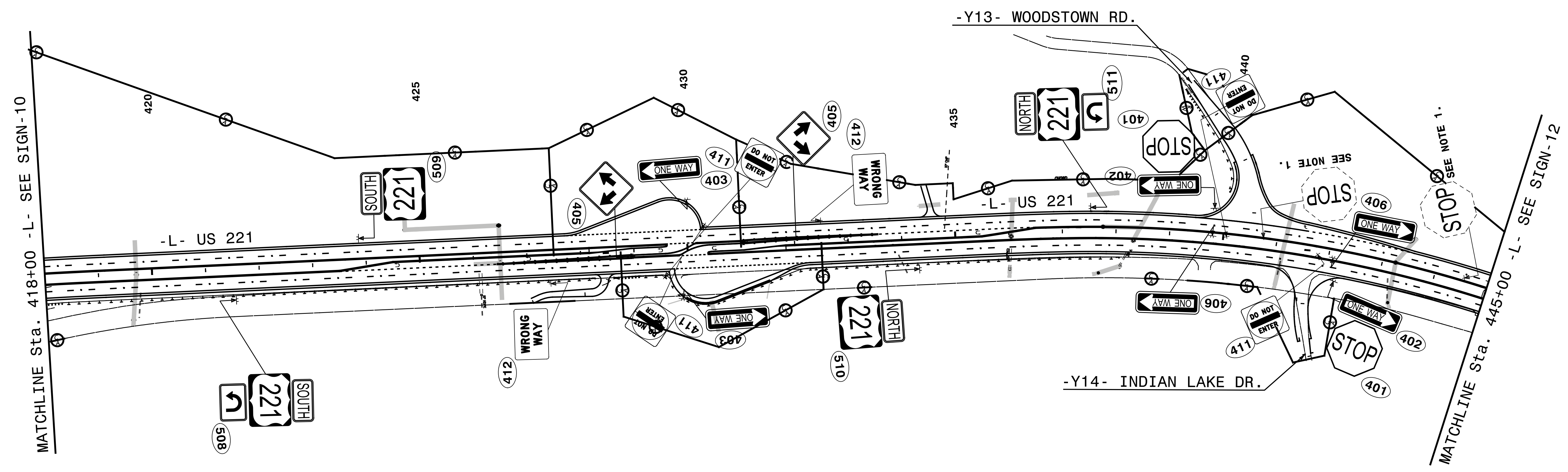
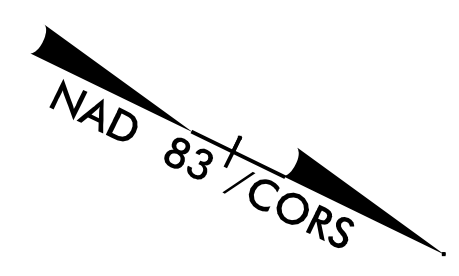

REVISIONS

NOTE

1. DISPOSAL OF SIGN SYSTEM, U-CHANNEL

SEPI
ENGINEERING & CONSTRUCTION

1025 Wade Avenue
Raleigh, NC 27605
Tel: 919-789-9977
Fax: 919-789-9591
License: C-2197

**EXISTING & PROPOSED
SIGNING DETAIL**

SYSTEMS DOWN

PROJECT REFERENCE NO. R-2915C	SHEET NO. SIGN-12
APPROVED: <i>Joseph Kopaske</i> <small>DocuSigned by: SC0DBEAF60A64FA</small>	
DATE: 6/21/2016	
SEAL 	
DOCUMENT NOT CONSIDERED FINAL UNLESS ALL SIGNATURES COMPLETED	

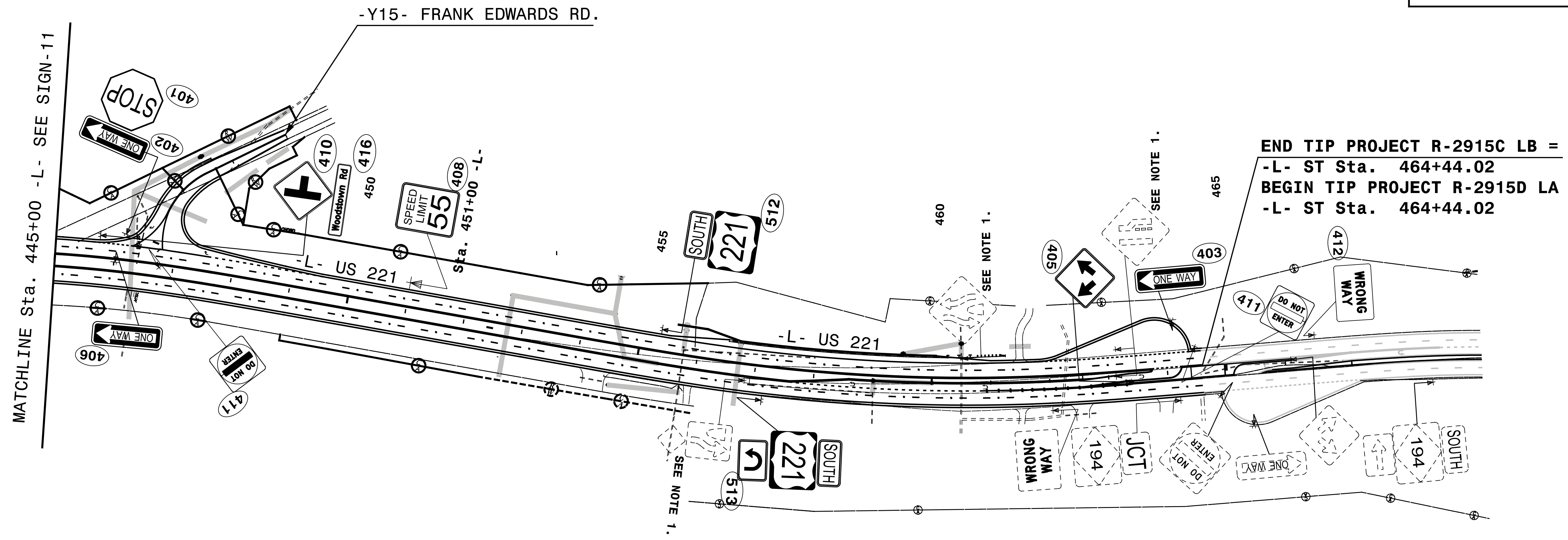
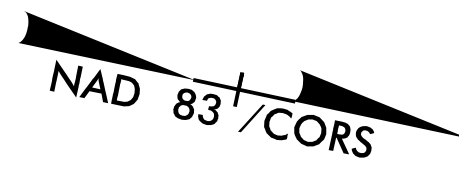

NOTE
1. DISPOSAL OF SIGN SYSTEM, U-CHANNEL

SEPI
ENGINEERING & CONSTRUCTION
1025 Wade Avenue
Raleigh, NC 27605
Tel: 919-789-9977
Fax: 919-789-9591
License: C-2197

**EXISTING & PROPOSED
SIGNING DETAIL**