

**This electronic collection of documents is provided
for the convenience of the user
and is Not a Certified Document –**

**The documents contained herein were originally issued
and sealed by the individuals whose names and license
numbers appear on each page, on the dates appearing
with their signature on that page.**

**This file or an individual page
shall not be considered a certified document.**

CROSS SECTION SUMMARY

NOTE: EMBANKMENT COLUMN DOES NOT INCLUDE BACKFILL FOR UNDERCUT

| Station | Uncl. Exc. | Embt | Station | Uncl. Exc. | Embt | Station | Uncl. Exc. | Embt |
|----------|------------|-----------|----------------|-------------------|------------------|----------|------------|-----------|
| L | (cu. yd.) | (cu. yd.) | L | (cu. yd.) | (cu. yd.) | Y1Rev | (cu. yd.) | (cu. yd.) |
| 10+75.00 | 0 | 0 | 33+75.50 | 0 | 0 | 10+50.00 | 0 | 0 |
| 11+00.00 | 17 | 123 | 34+00.00 | 634 | 1918 | 11+00.00 | 1 | 7 |
| 11+50.00 | 33 | 169 | 34+50.00 | 696 | 4572 | 11+50.00 | 3 | 9 |
| 12+00.00 | 25 | 81 | 35+00.00 | 174 | 5080 | 12+00.00 | 3 | 5 |
| 12+50.00 | 39 | 24 | 35+50.00 | 47 | 5063 | 12+50.00 | 10 | 8 |
| 13+00.00 | 62 | 8 | 36+00.00 | 9 | 4984 | 13+00.00 | 19 | 7 |
| 13+50.00 | 48 | 18 | 36+50.00 | 0 | 4648 | 13+50.00 | 17 | 5 |
| 14+00.00 | 17 | 66 | 37+00.00 | 0 | 4205 | 14+00.00 | 12 | 6 |
| 14+50.00 | 7 | 195 | 37+50.00 | 0 | 3669 | 14+50.00 | 12 | 10 |
| 15+00.00 | 7 | 410 | 38+00.00 | 0 | 3120 | 15+00.00 | 19 | 16 |
| 15+50.00 | 9 | 617 | 38+50.00 | 0 | 2581 | 15+50.00 | 27 | 26 |
| 16+00.00 | 5 | 876 | 39+00.00 | 0 | 2078 | 16+00.00 | 33 | 40 |
| 16+50.00 | 0 | 1167 | 39+50.00 | 0 | 1616 | 16+50.00 | 37 | 43 |
| 17+00.00 | 0 | 1163 | 40+00.00 | 0 | 1292 | 17+00.00 | 39 | 48 |
| 17+50.00 | 0 | 910 | 40+50.00 | 0 | 1149 | 17+50.00 | 34 | 66 |
| 18+00.00 | 0 | 630 | 40+75.00 | 0 | 546 | 18+00.00 | 21 | 97 |
| 18+50.00 | 0 | 400 | 41+00.00 | 0 | 534 | 18+50.00 | 8 | 155 |
| 19+00.00 | 0 | 272 | 41+50.00 | 0 | 1049 | 19+00.0 | 14 | 208 |
| 19+50.00 | 0 | 219 | 42+00.00 | 0 | 958 | 19+50.00 | 21 | 206 |
| 20+00.00 | 0 | 209 | 42+50.00 | 0 | 787 | 20+00.00 | 7 | 174 |
| 20+50.00 | 0 | 220 | 42+75.00 | 0 | 345 | 20+43.00 | 1 | 138 |
| 21+00.00 | 0 | 246 | 43+00.00 | 0 | 351 | 20+50.00 | 0 | 23 |
| 21+50.00 | 0 | 236 | 43+05.00 | 0 | 72 | 20+59.00 | 0 | 29 |
| 22+00.00 | 0 | 191 | Station | Uncl. Exc. | Embt | 21+00.00 | 2 | 113 |
| 22+50.00 | 0 | 159 | | | | 21+50.00 | 2 | 97 |
| 23+00.00 | 0 | 158 | L2 | (cu. yd.) | (cu. yd.) | 22+00.00 | 6 | 64 |
| 23+50.00 | 0 | 197 | 10+25.00 | 0 | 0 | 22+50.00 | 7 | 29 |
| 24+00.00 | 0 | 307 | 10+50.00 | 0 | 199 | 23+00.00 | 4 | 6 |
| 24+50.00 | 0 | 422 | 10+75.00 | 0 | 216 | 23+17.31 | 1 | 0 |
| 25+00.00 | 0 | 551 | 11+00.00 | 0 | 237 | | | |
| 25+50.00 | 0 | 753 | 11+20.00 | 0 | 200 | | | |
| 26+00.00 | 0 | 993 | | | | | | |
| 26+50.00 | 0 | 1256 | | | | | | |
| 27+00.00 | 0 | 1524 | | | | | | |
| 27+50.00 | 0 | 1815 | | | | | | |
| 28+00.00 | 0 | 2141 | | | | | | |
| 28+50.00 | 0 | 2498 | | | | | | |
| 29+00.00 | 0 | 2877 | | | | | | |
| 29+50.00 | 18 | 3264 | | | | | | |
| 30+00.00 | 36 | 3504 | | | | | | |
| 30+50.00 | 36 | 3618 | | | | | | |
| 31+00.00 | 36 | 3619 | | | | | | |
| 31+50.00 | 36 | 3328 | | | | | | |
| 32+00.00 | 75 | 3234 | | | | | | |
| 32+50.00 | 867 | 3673 | | | | | | |
| 32+61.96 | 374 | 944 | | | | | | |

CROSS SECTION INDEX

| SHEET | ALIGNMENT | BEGIN STATION | END STATION |
|-------|-----------|---------------|-------------|
| X-2 | -L- | 10 + 75.00 | 13 + 50.00 |
| X-3 | -L- | 14 + 00.00 | 16 + 50.00 |
| X-4 | -L- | 17 + 00.00 | 19 + 50.00 |
| X-5 | -L- | 20 + 00.00 | 22 + 50.00 |
| X-6 | -L- | 23 + 00.00 | 25 + 50.00 |
| X-7 | -L- | 26 + 00.00 | 27 + 50.00 |
| X-8 | -L- | 28 + 00.00 | 29 + 50.00 |
| X-9 | -L- | 30 + 00.00 | 31 + 00.00 |
| X-10 | -L- | 31 + 50.00 | 32 + 50.00 |
| X-11 | -L- | 32 + 61.96 | 33 + 00.00 |
| X-12 | -L- | 33 + 50.00 | 33 + 75.50 |
| X-13 | -L- | 34 + 00.00 | 35 + 00.00 |
| X-14 | -L- | 35 + 50.00 | 37 + 00.00 |
| X-15 | -L- | 37 + 50.00 | 39 + 00.00 |
| X-16 | -L- | 39 + 50.00 | 41 + 50.00 |
| X-17 | -L- | 42 + 00.00 | 43 + 05.00 |
| X-18 | -L2- | 10 + 25.00 | 11 + 20.00 |
| X-19 | -Y1REV- | 10 + 50.00 | 13 + 00.00 |
| X-20 | -Y1REV- | 13 + 50.00 | 16 + 00.00 |
| X-21 | -Y1REV- | 16 + 50.00 | 19 + 00.00 |
| X-22 | -Y1REV- | 19 + 50.00 | 21 + 00.00 |
| X-23 | -Y1REV- | 21 + 50.00 | 23 + 17.31 |

Note: "Quantities are approximate only. The Resident Engineer will re-cross-section the work accurately when the project is staked out. These cross-section notes will be used in computing the final quantities for which the contractor will be paid."

8/23/99

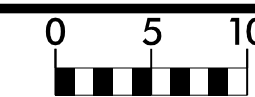

PROJ. REFERENCE NO.
R-5769

SHEET NO.
X-2

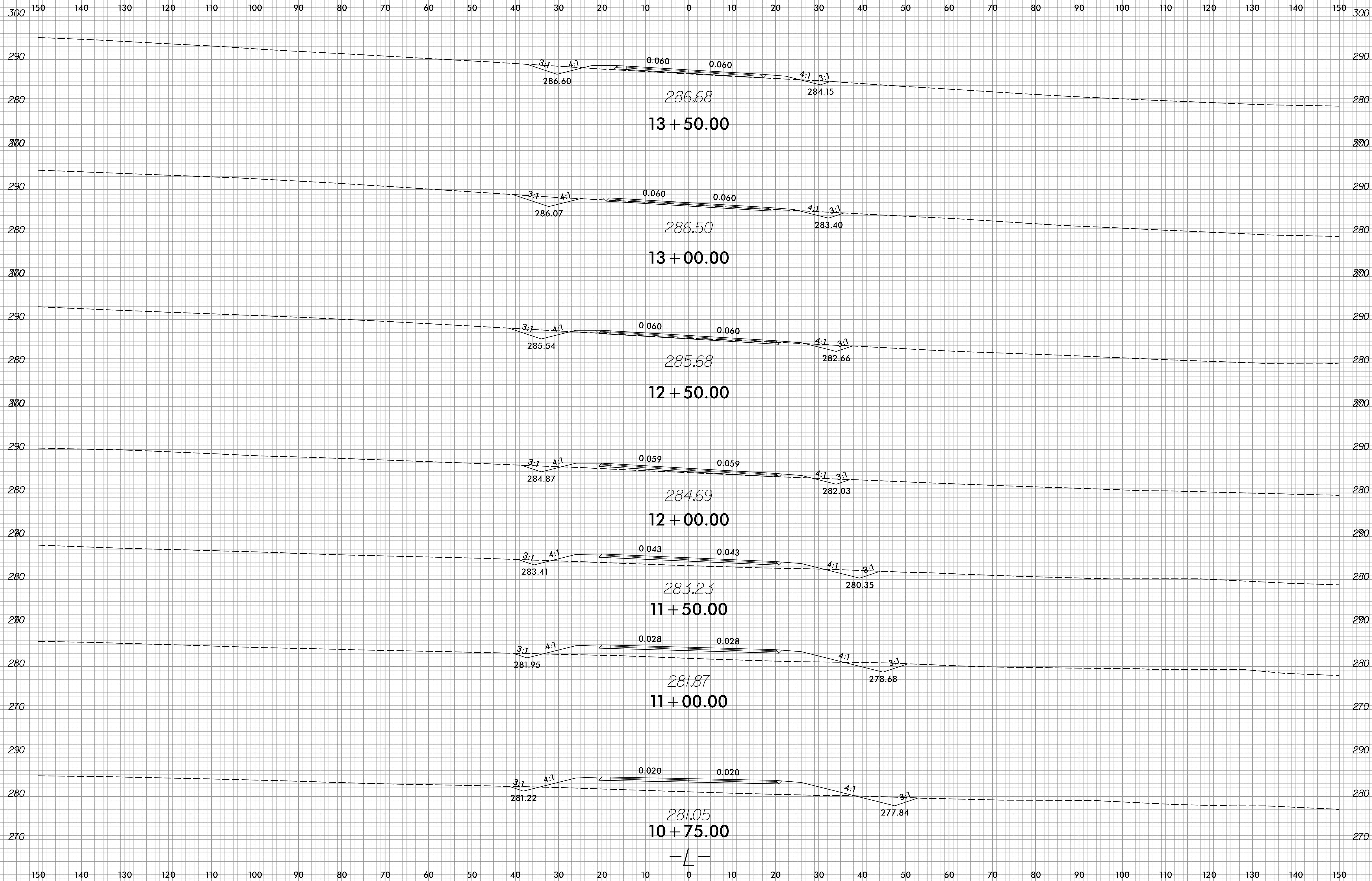

8/23/2006
1:5:19:16:31_r.dwg - xpl.L.dgn
JUS:KAR:KUS

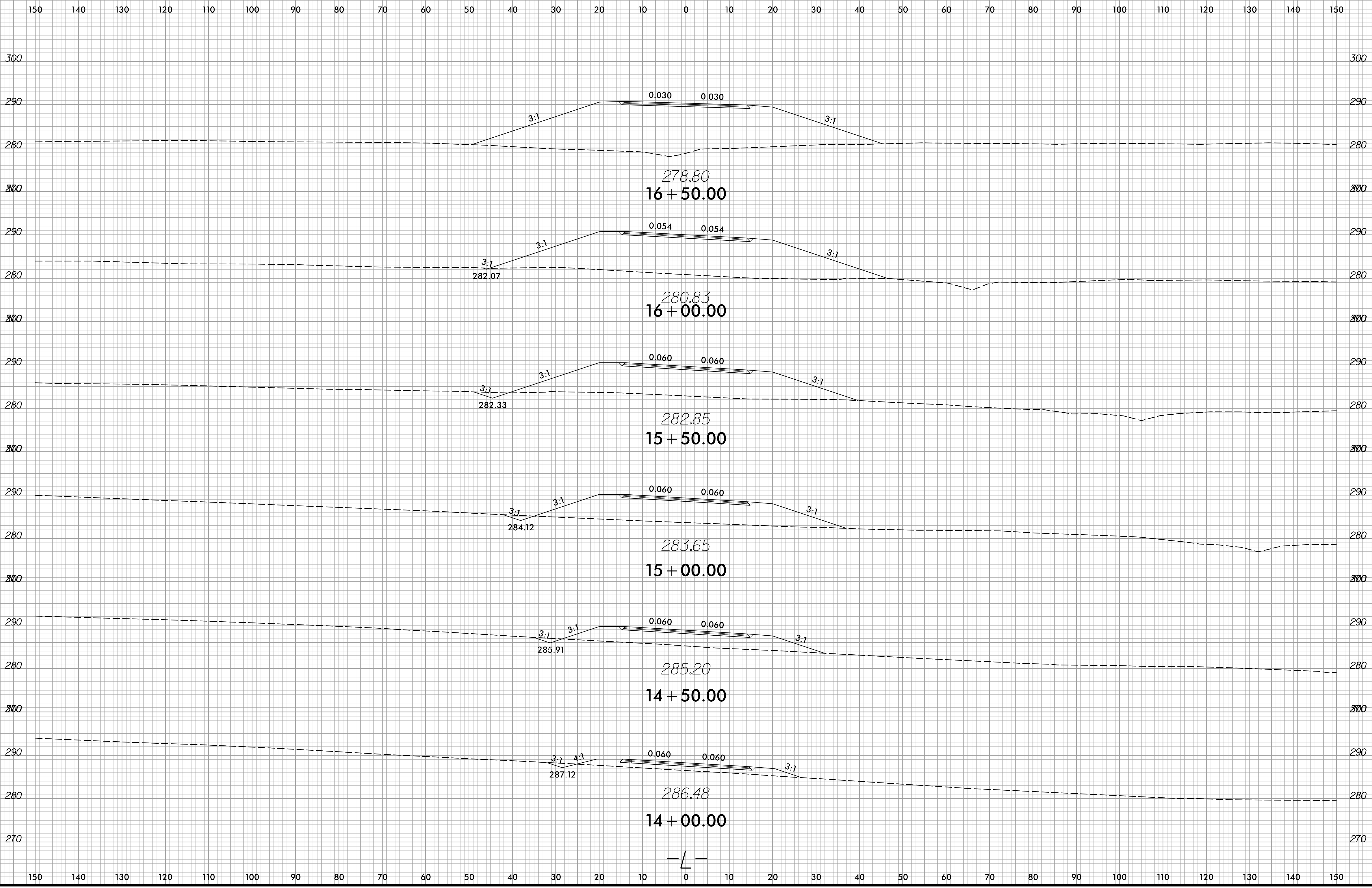

8/23/99

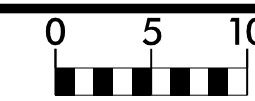

PROJ. REFERENCE NO.
R-5769

SHEET NO.
X-4

150 140 130 120 110 100 90 80 70 60 50 40 30 20 10 0 10 20 30 40 50 60 70 80 90 100 110 120 130 140 150

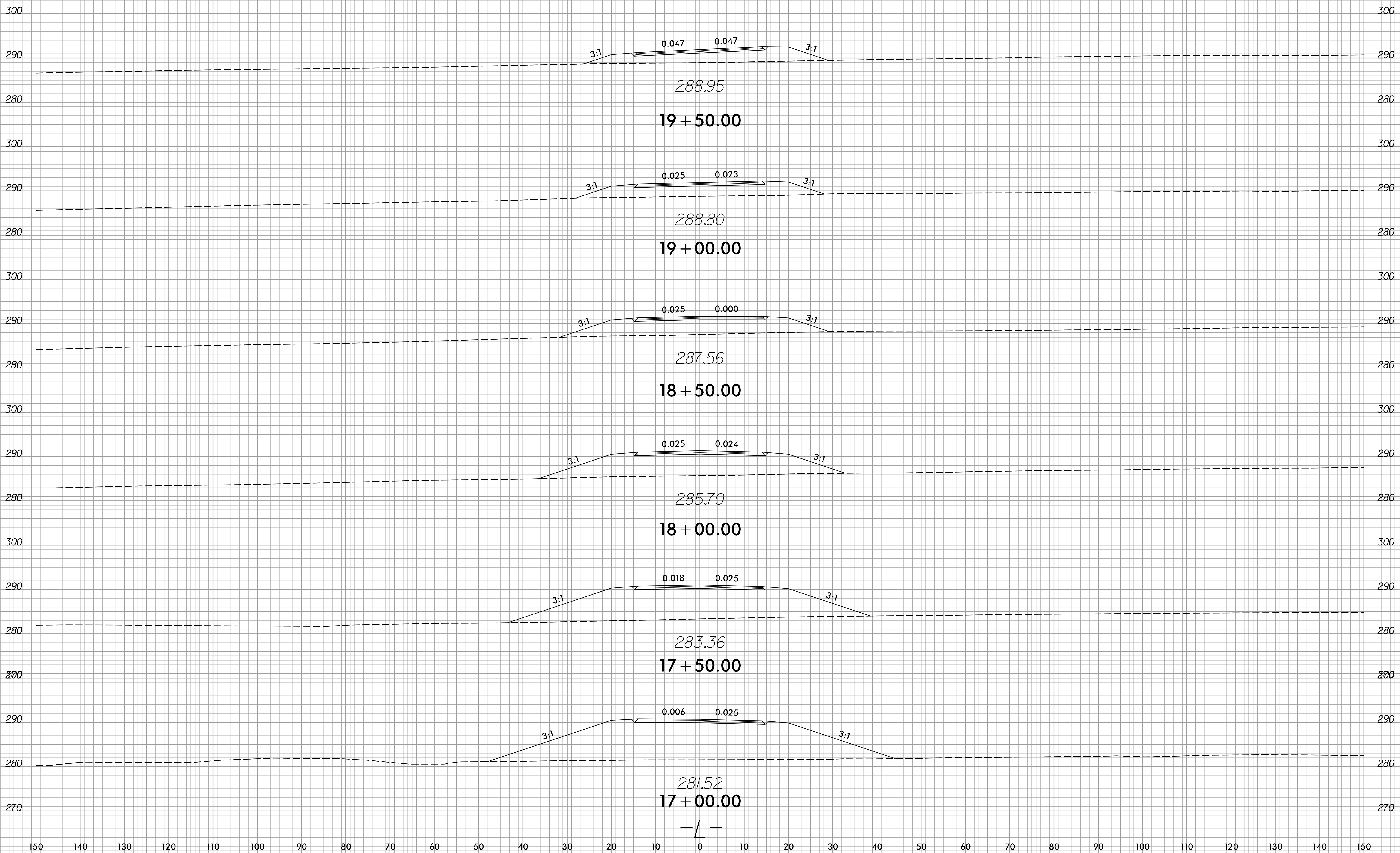

8/23/2016
1:51:19 PM
J:\Projects\161_rdy-xpl.L.dgn
J:\Users\kds

150 140 130 120 110 100 90 80 70 60 50 40 30 20 10 0 10 20 30 40 50 60 70 80 90 100 110 120 130 140 150

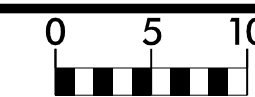

150 140 130 120 110 100 90 80 70 60 50 40 30 20 10 0 10 20 30 40 50 60 70 80 90 100 110 120 130 140 150

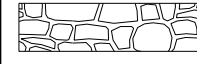
 ROCK EMBANKMENT
SEE DETAIL SHEETS 2G-1 THRU 2G-12

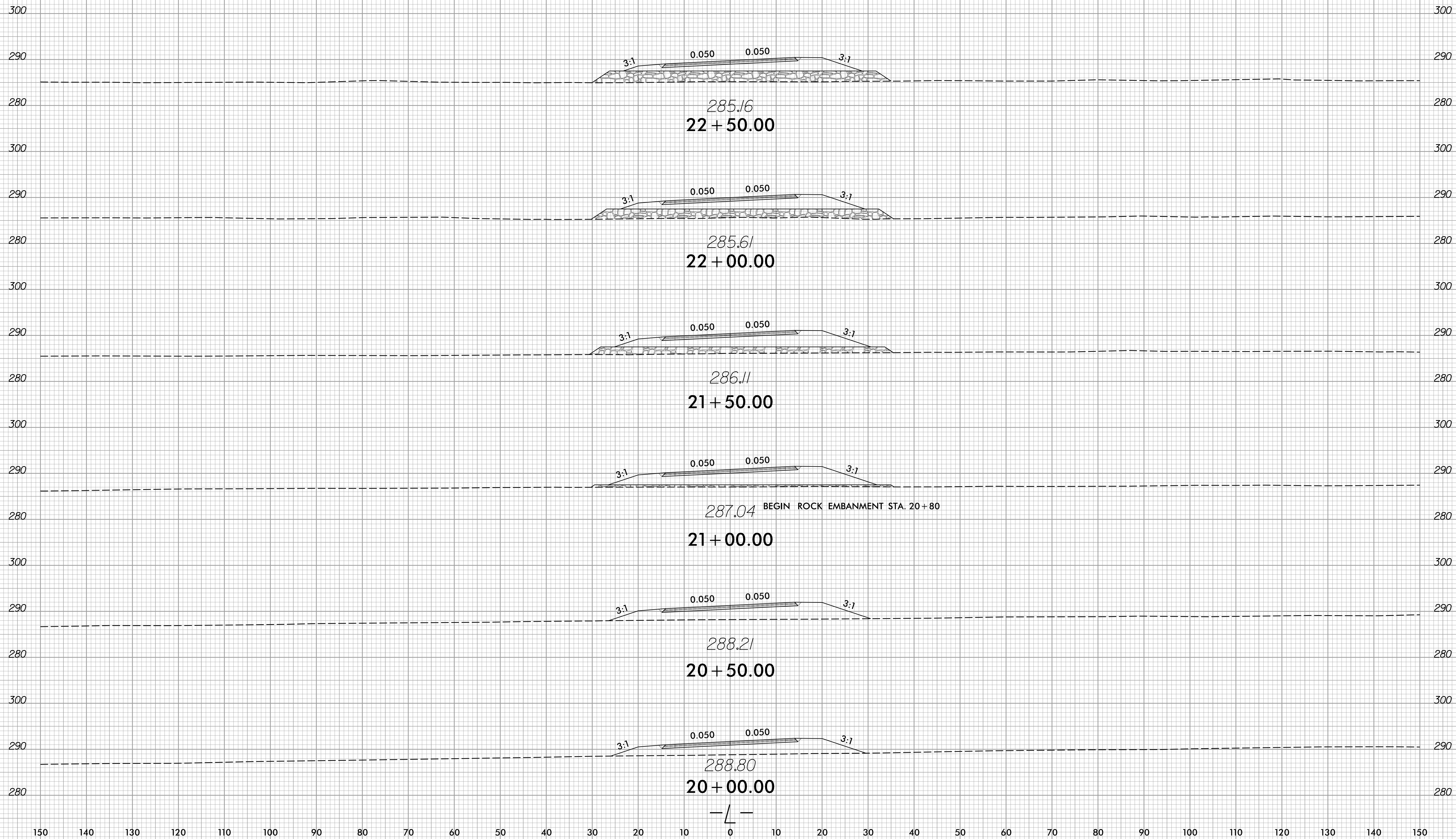

8/23/99

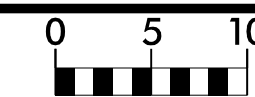

PROJ. REFERENCE NO.
R-5769

SHEET NO.
X-6

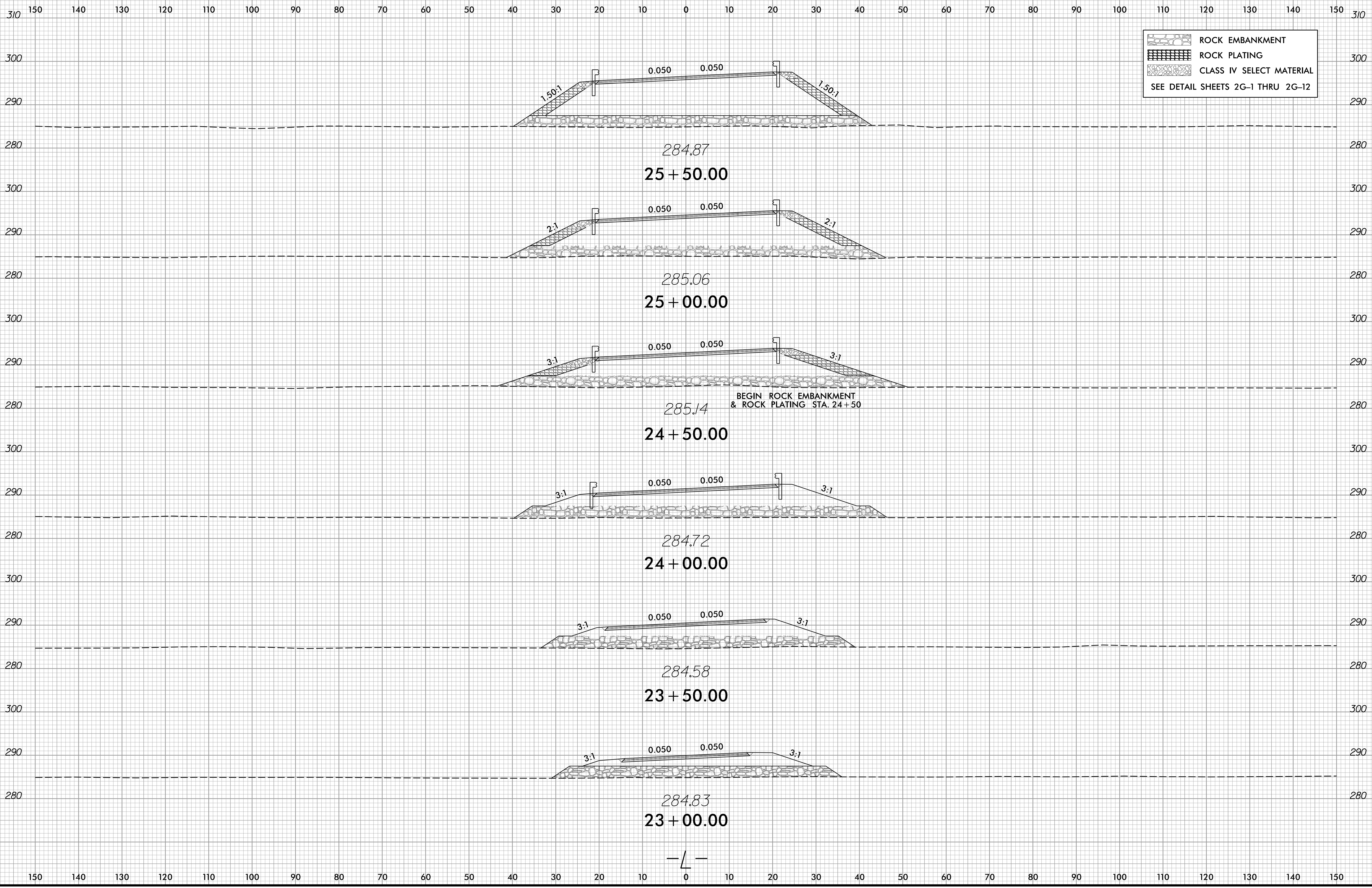

| | |
|-----------------------------------|--------------------------|
| | ROCK EMBANKMENT |
| | ROCK PLATING |
| | CLASS IV SELECT MATERIAL |
| SEE DETAIL SHEETS 2G-1 THRU 2G-12 | |

8/23/2016
1:50 PM
J:\Projects\161_rdy_xpl.L.dgn
JUL 20 2016 1:50 PM

150 140 130 120 110 100 90 80 70 60 50 40 30 20 10 0 10 20 30 40 50 60 70 80 90 100 110 120 130 140 150

8/23/99

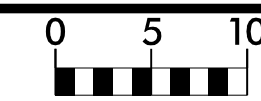

PROJ. REFERENCE NO.
R-5769

SHEET NO.
X-7

150 140 130 120 110 100 90 80 70 60 50 40 30 20 10 0 10 20 30 40 50 60 70 80 90 100 110 120 130 140 150

| | |
|-----------------------------------|--------------------------|
| | ROCK EMBANKMENT |
| | ROCK PLATING |
| | CLASS IV SELECT MATERIAL |
| SEE DETAIL SHEETS 2G-1 THRU 2G-12 | |

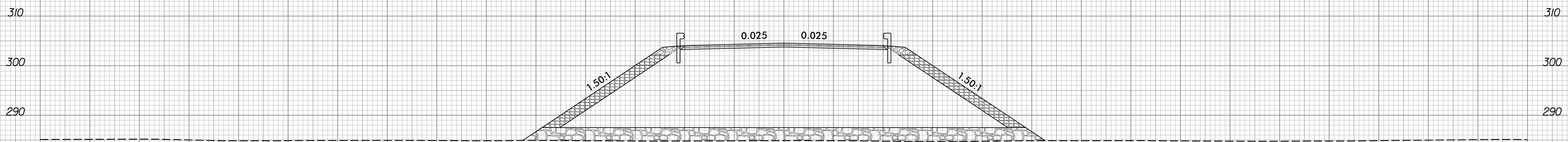

284.87
27 + 50.00

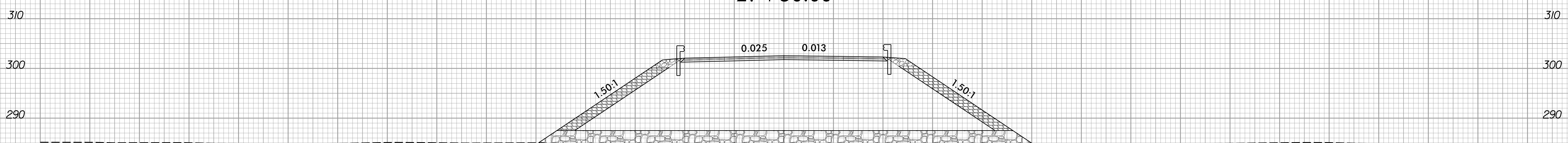

284.62
27 + 00.00

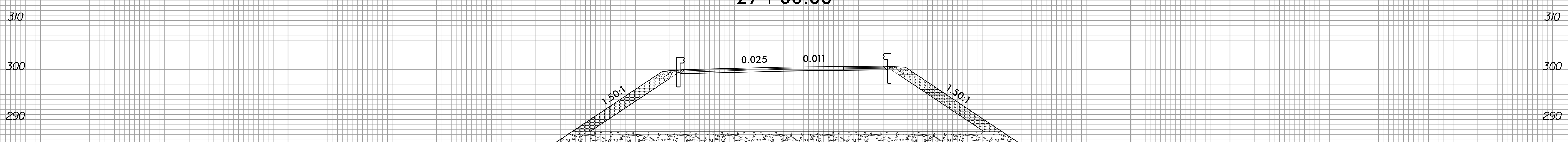

284.86
26 + 50.00

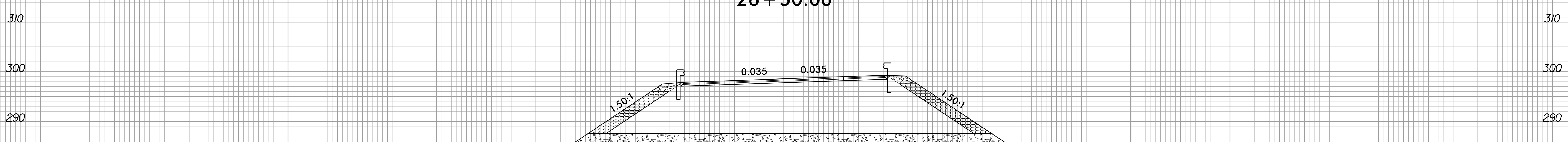

284.91
26 + 00.00

— L —

150 140 130 120 110 100 90 80 70 60 50 40 30 20 10 0 10 20 30 40 50 60 70 80 90 100 110 120 130 140 150

8/23/2006
1:51:16 PM
J:\ENR\K05

8/23/99

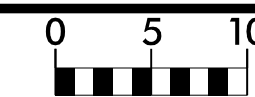

PROJ. REFERENCE NO.
R-5769

SHEET NO.
X-8

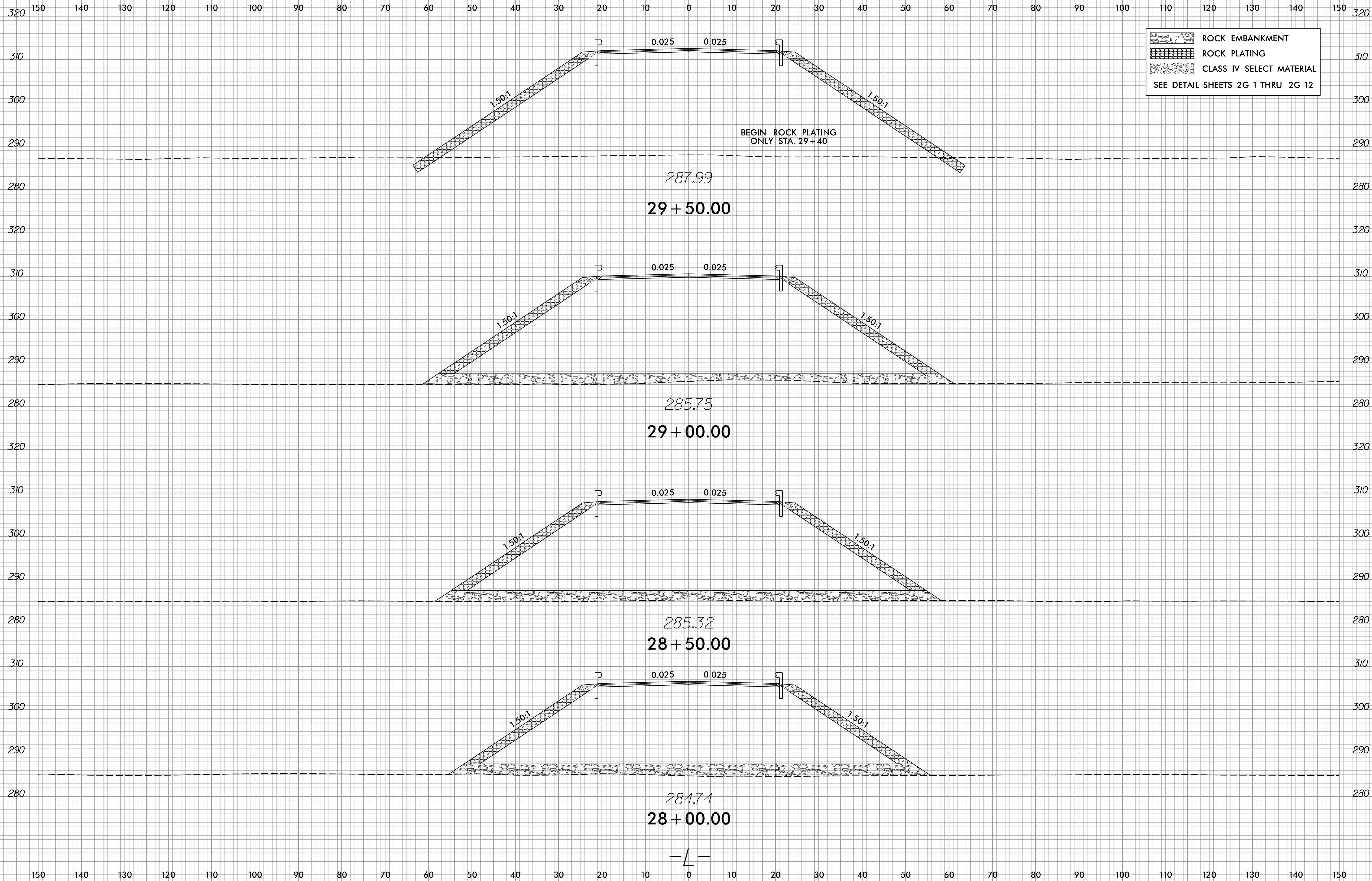

8/23/2006
1:5:19:16:31_rdy_xpl.L.dgn
JSE/KEB

8/23/99

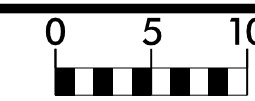

PROJ. REFERENCE NO.
R-5769

SHEET NO.
X-9

150 140 130 120 110 100 90 80 70 60 50 40 30 20 10 0 10 20 30 40 50 60 70 80 90 100 110 120 130 140 150

ROCK PLATING
 CLASS IV SELECT MATERIAL
 SEE DETAIL SHEETS 2G-1 THRU 2G-12

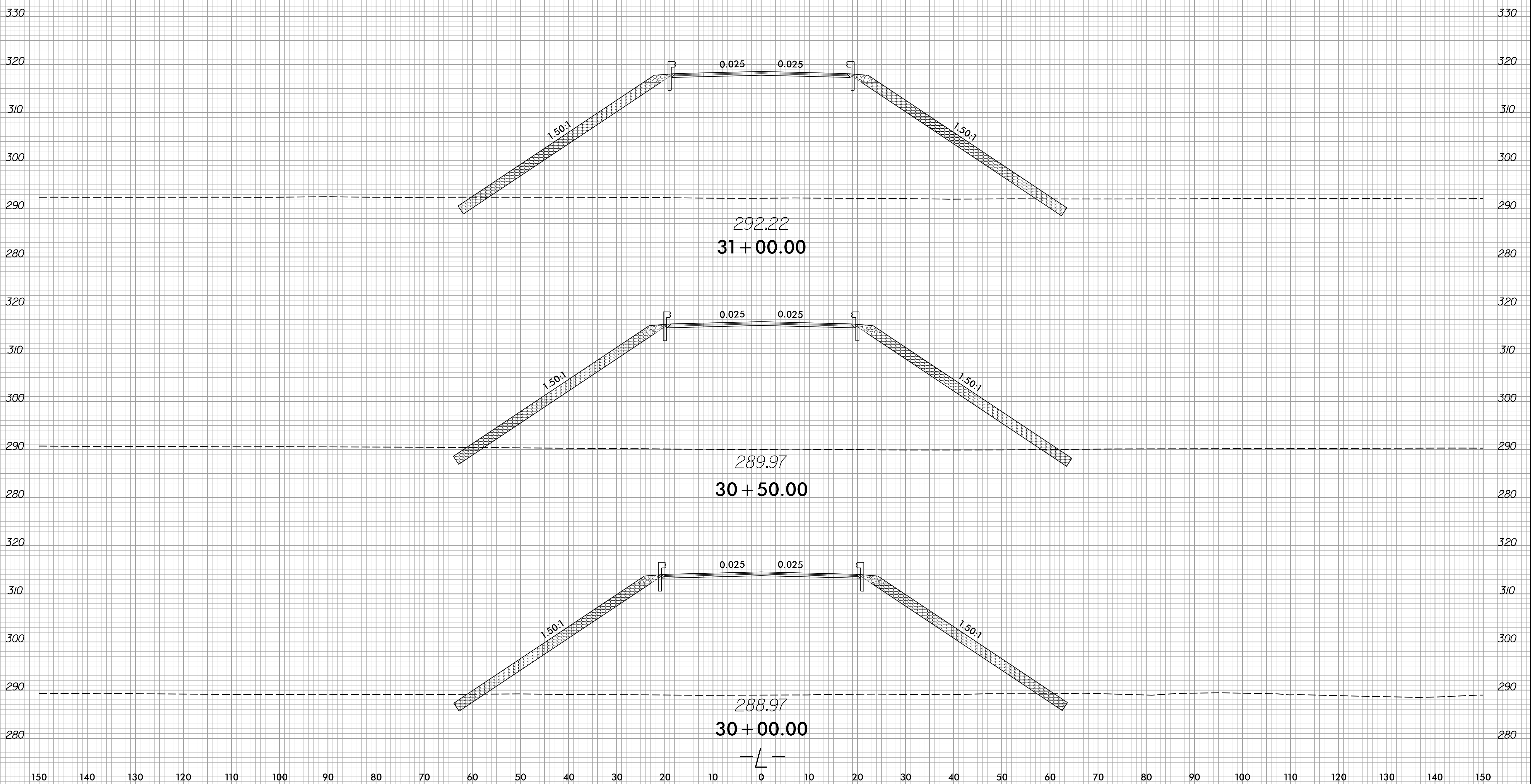

8/23/2016
1:51:16 PM
J:\EIR\K05

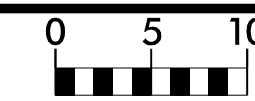

8/23/99



PROJ. REFERENCE NO.
R-5769

SHEET NO.
X-10

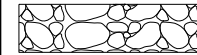
150 140 130 120 110 100 90 80 70 60 50 40 30 20 10 0 10 20 30 40 50 60 70 80 90 100 110 120 130 140 150

-  REINFORCED AGGREGATE PLATFORM
-  ROCK PLATING
-  CLASS IV SELECT MATERIAL
- SEE DETAIL SHEETS 2G-1 THRU 2G-12

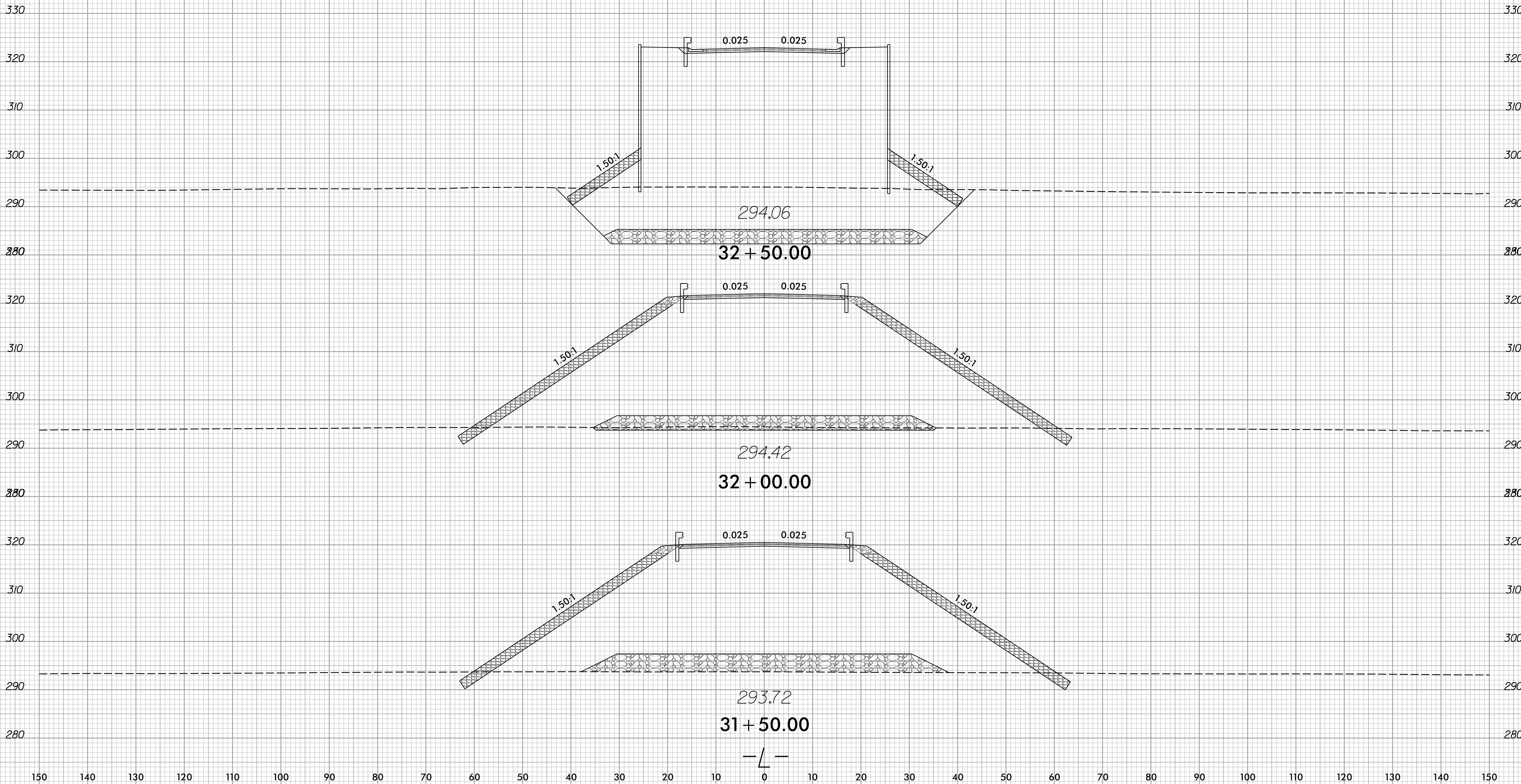

8/23/2006
T:\1976\1_rdy-xpl.L.dgn
JSE/KEB

8/23/99

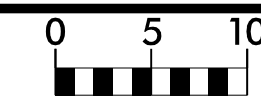

PROJ. REFERENCE NO.
R-5769

SHEET NO.
X-11

150 140 130 120 110 100 90 80 70 60 50 40 30 20 10 0 10 20 30 40 50 60 70 80 90 100 110 120 130 140 150

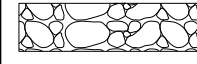
 REINFORCED AGGREGATE PLATFORM
SEE DETAIL SHEETS 2G-1 THRU 2G-12

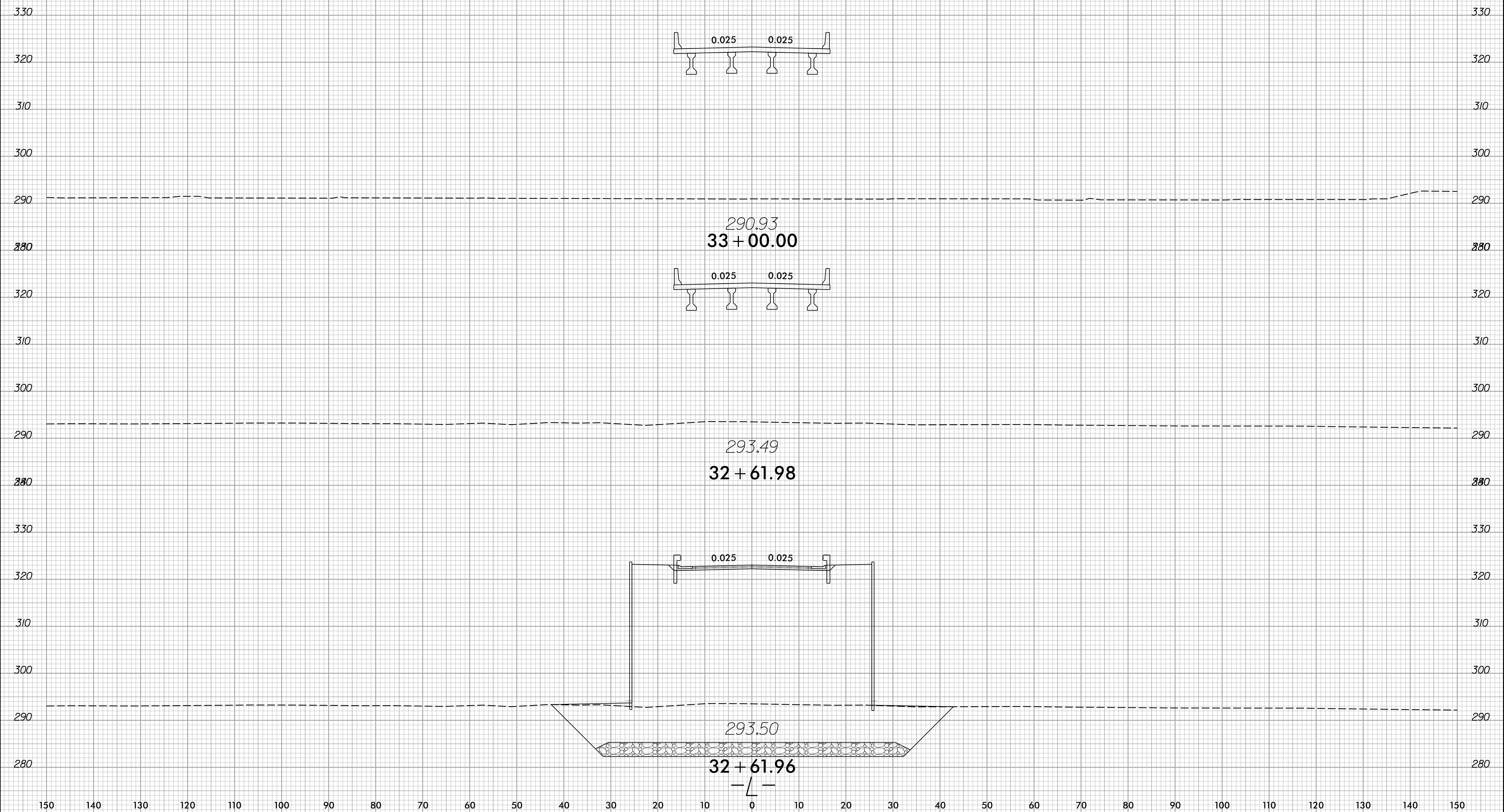

8/23/2016
11:51:16
T:\S\19761_r-dj-xpl.L.dgn
KES

8/23/99

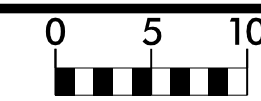

PROJ. REFERENCE NO.
R-5769

SHEET NO.
X-12

150 140 130 120 110 100 90 80 70 60 50 40 30 20 10 0 10 20 30 40 50 60 70 80 90 100 110 120 130 140 150

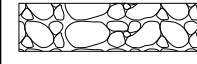
 REINFORCED AGGREGATE PLATFORM
SEE DETAIL SHEETS 2G-1 THRU 2G-12

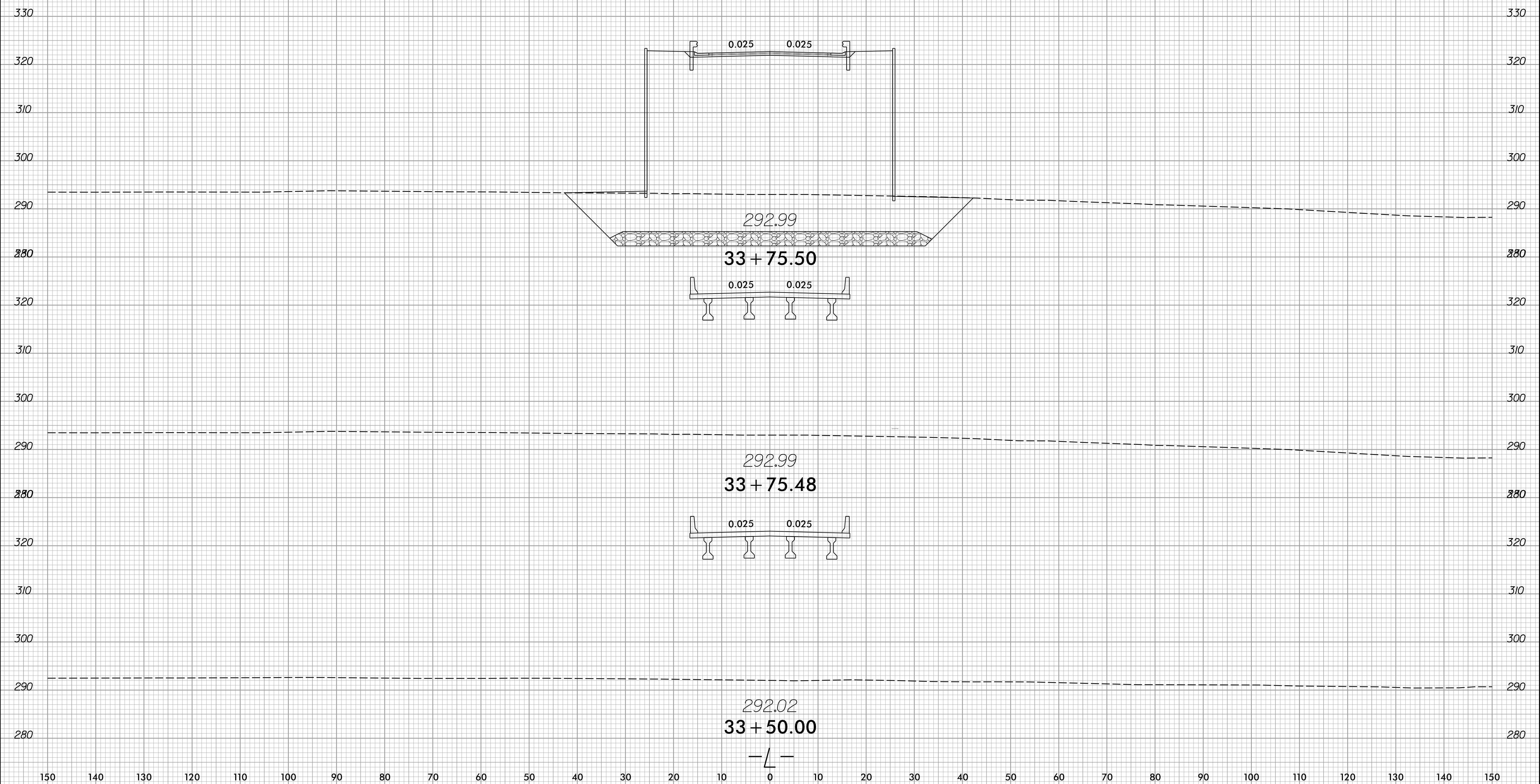

8/23/2016
1:51:19.76
J:\EIR\KWB

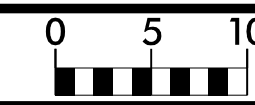

8/23/99



PROJ. REFERENCE NO.
R-5769

SHEET NO.
X-13

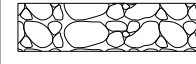
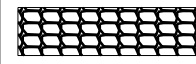
150 140 130 120 110 100 90 80 70 60 50 40 30 20 10 0 10 20 30 40 50 60 70 80 90 100 110 120 130 140 150

-  REINFORCED AGGREGATE PLATFORM
-  ROCK PLATING
-  CLASS IV SELECT MATERIAL
- SEE DETAIL SHEETS 2G-1 THRU 2G-12

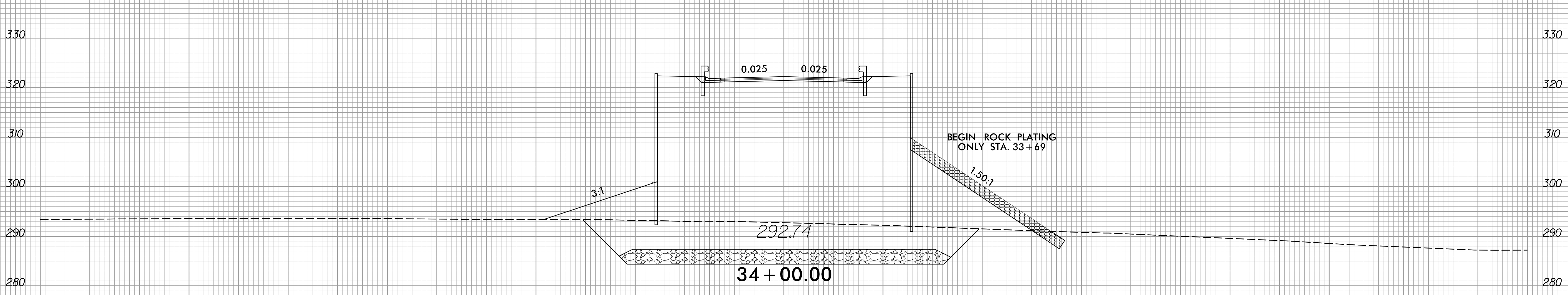
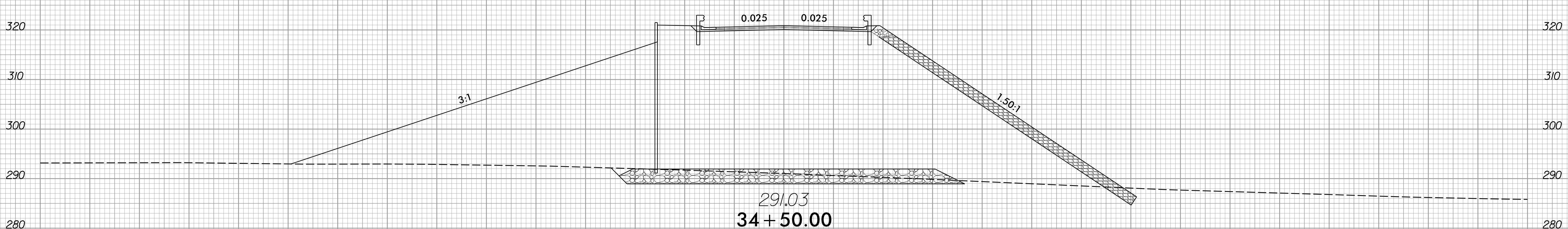
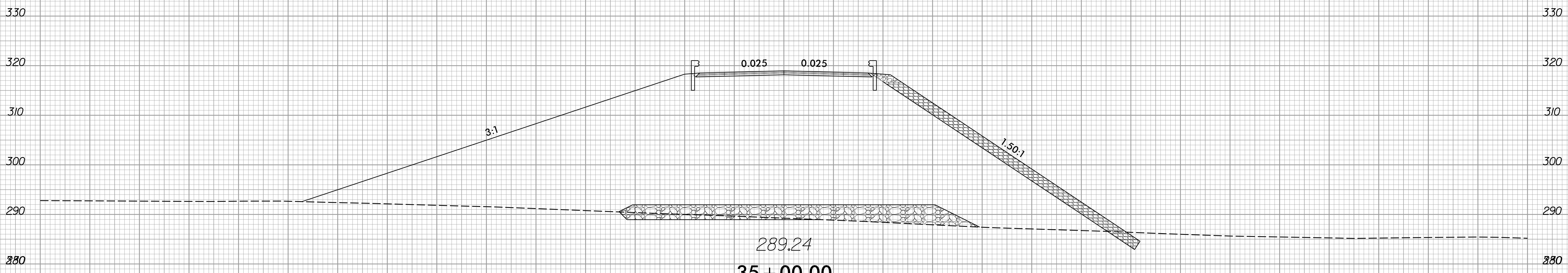

150 140 130 120 110 100 90 80 70 60 50 40 30 20 10 0 10 20 30 40 50 60 70 80 90 100 110 120 130 140 150

8/23/2006
J:\S\1976\1_rdy-xpl.L.dgn
JSE/KEB

8/23/99

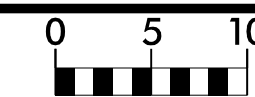

PROJ. REFERENCE NO.
R-5769

SHEET NO.
X-14

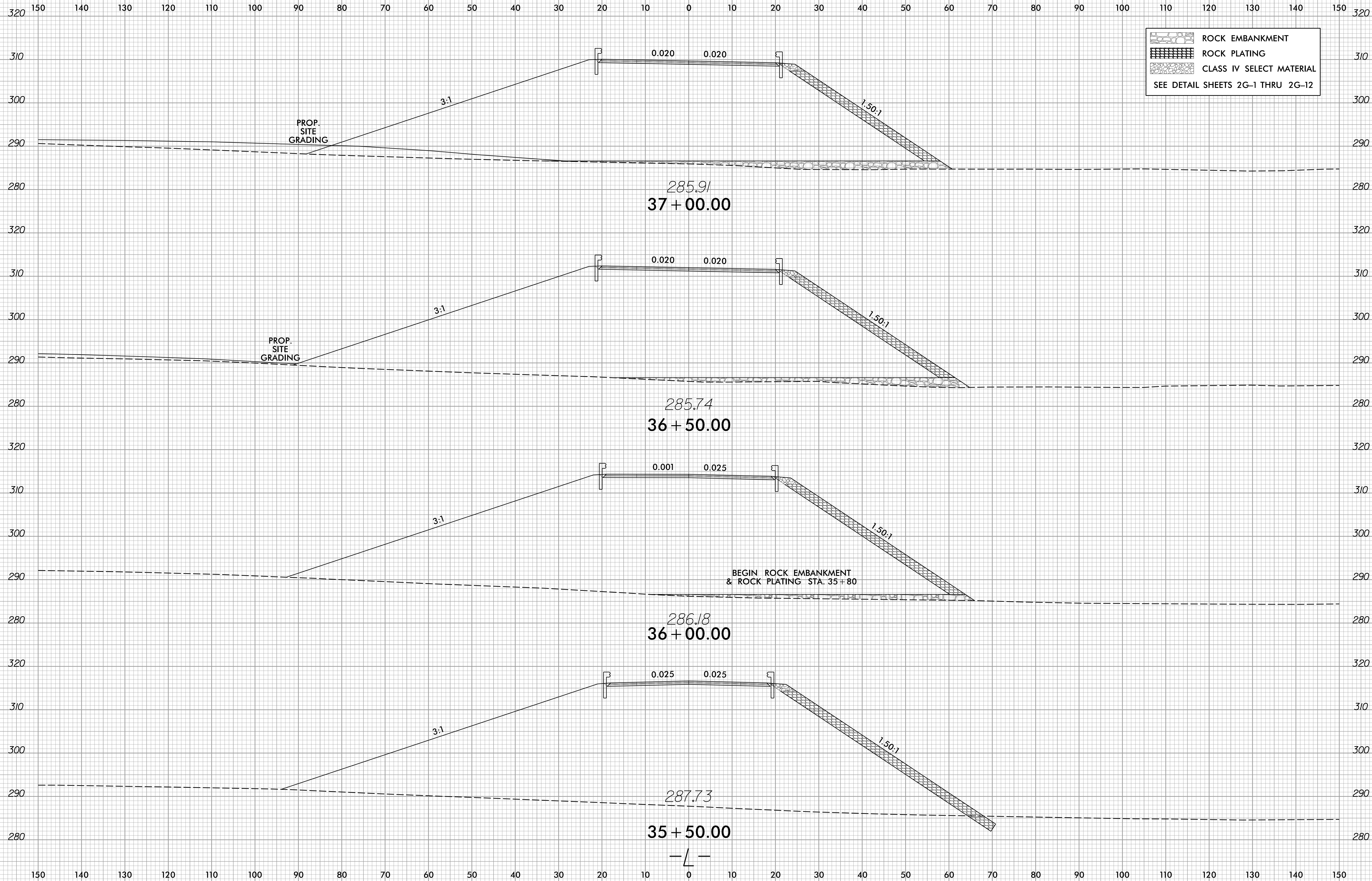

8/23/2006
1:5:19:16:31_r.dwg - xpl.l.dgn
JUS/ERK/KEB

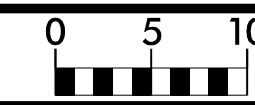

8/23/99



PROJ. REFERENCE NO.
R-5769

SHEET NO.
X-15

150 140 130 120 110 100 90 80 70 60 50 40 30 20 10 0 10 20 30 40 50 60 70 80 90 100 110 120 130 140 150

-  ROCK EMBANKMENT
-  ROCK PLATING
-  CLASS IV SELECT MATERIAL
- SEE DETAIL SHEETS 2G-1 THRU 2G-12

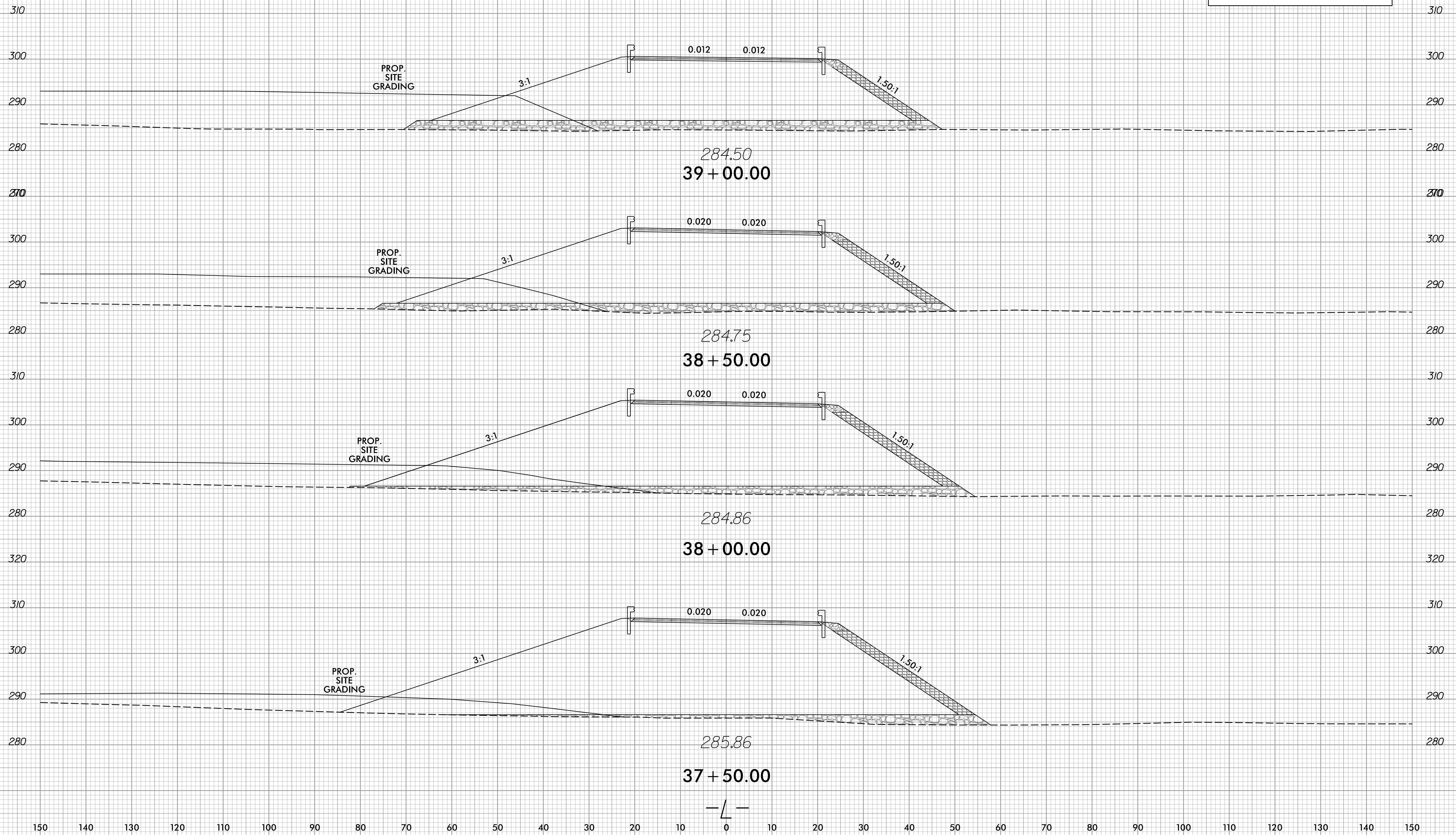

8/23/2006
J:\1976\1_rdy-xpl.L.dgn
JSE:KRS

8/23/99

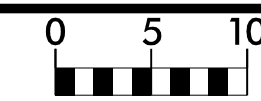

PROJ. REFERENCE NO.
R-5769

SHEET NO.
X-16

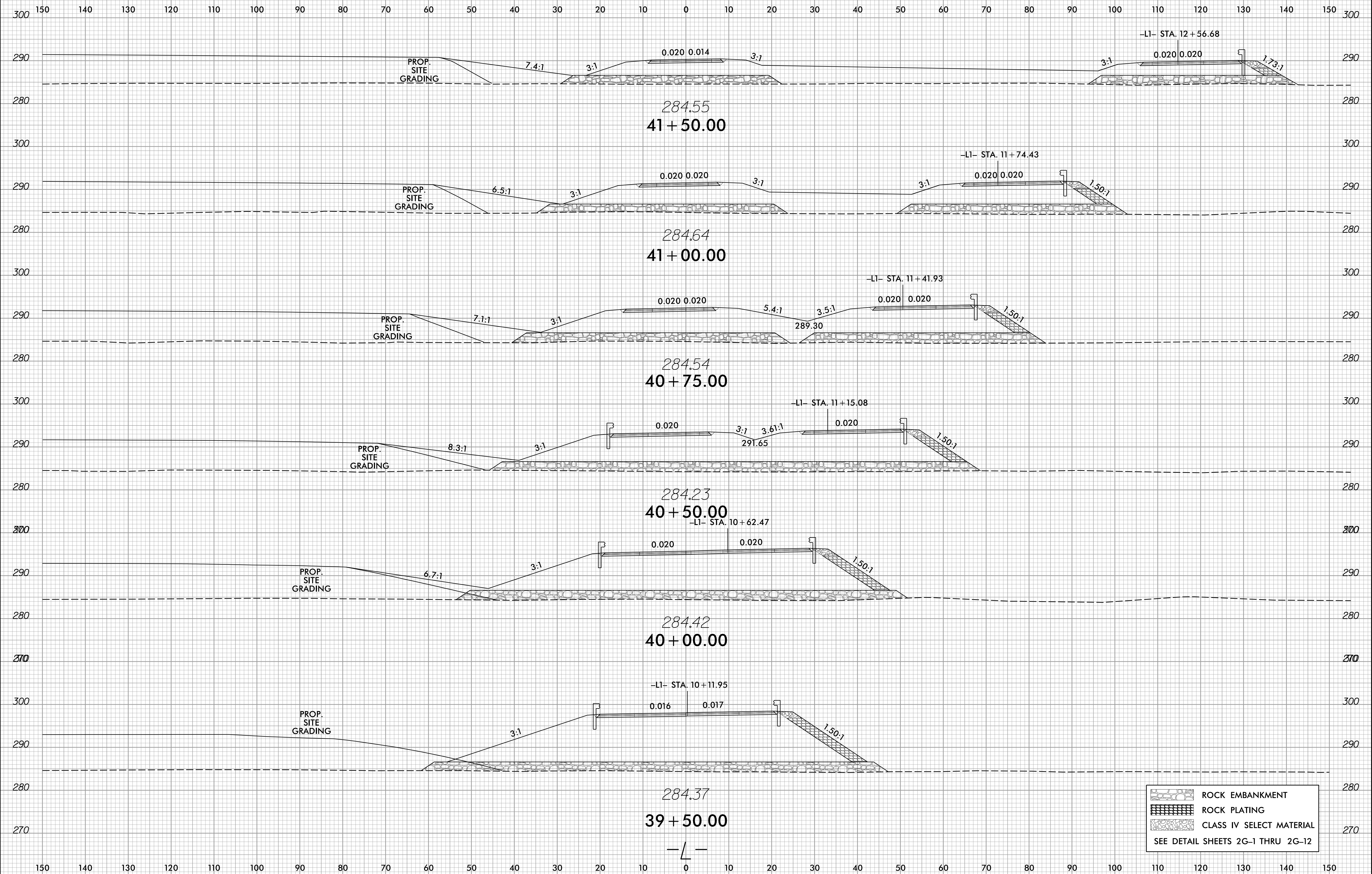

- ROCK EMBANKMENT
- ROCK PLATING
- CLASS IV SELECT MATERIAL
- SEE DETAIL SHEETS 2G-1 THRU 2G-12

8/23/2006
1:5:19:16:31_r.dwg - xpl.L.dgn
JUS/ELK/KEB

8/23/99

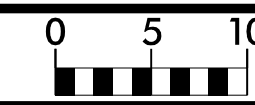

PROJ. REFERENCE NO.
R-5769

SHEET NO.
X-17

90 80 70 60 50 40 30 20 10 0 10 20 30 40 50 60 70 80 90 100 110 120 130 140 150 160 170 180 190 200 210

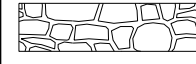
 ROCK EMBANKMENT
SEE DETAIL SHEETS 2G-1 THRU 2G-12

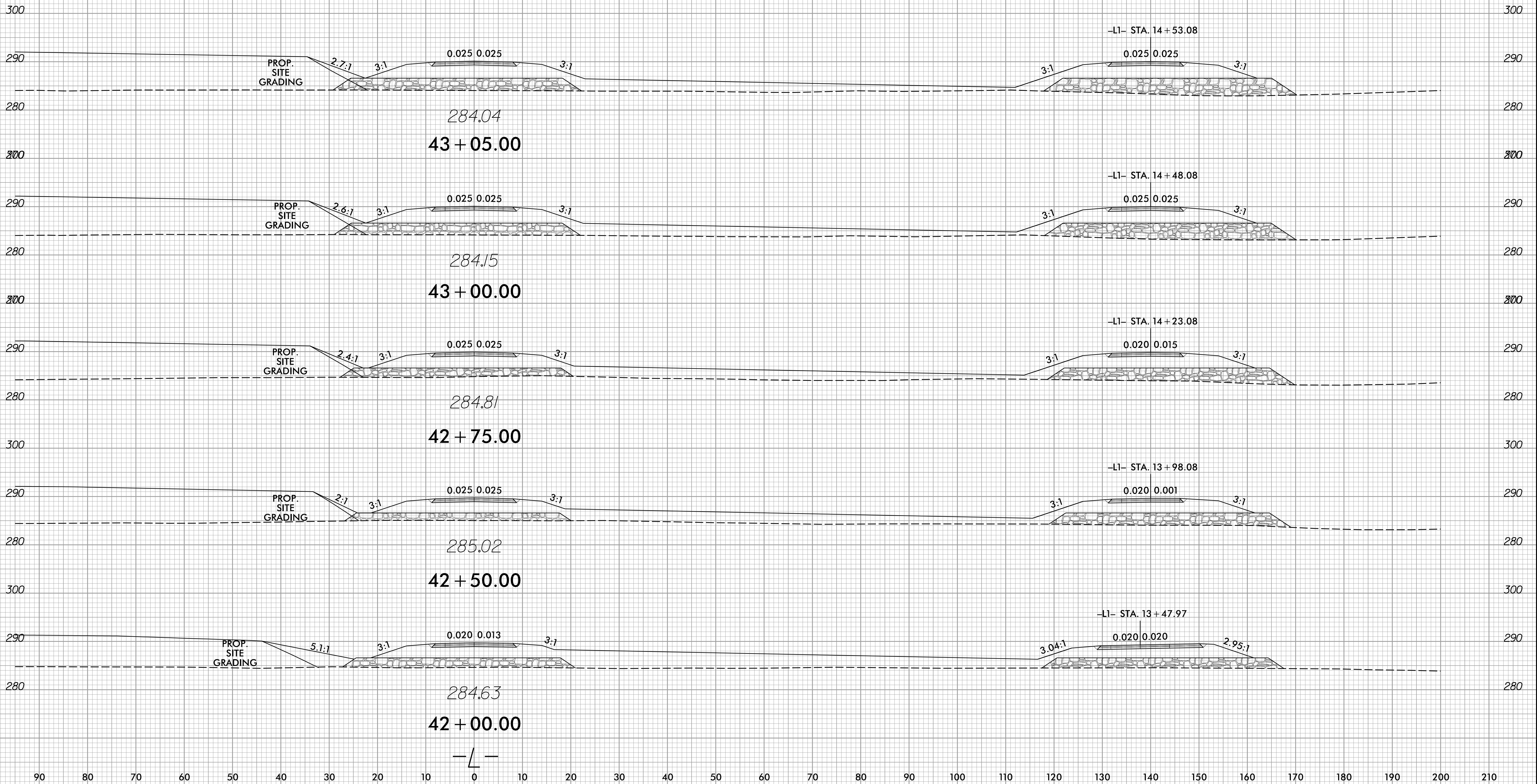

8/23/2006
J:\197631_rdy_xpl.L.dgn
JUS:KRS

8/23/99

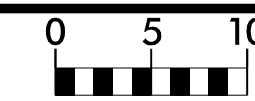

PROJ. REFERENCE NO.
R-5769

SHEET NO.
X-18

150 140 130 120 110 100 90 80 70 60 50 40 30 20 10 0 10 20 30 40 50 60 70 80 90 100 110 120 130 140 150

 ROCK EMBANKMENT
SEE DETAIL SHEETS 2G-1 THRU 2G-12

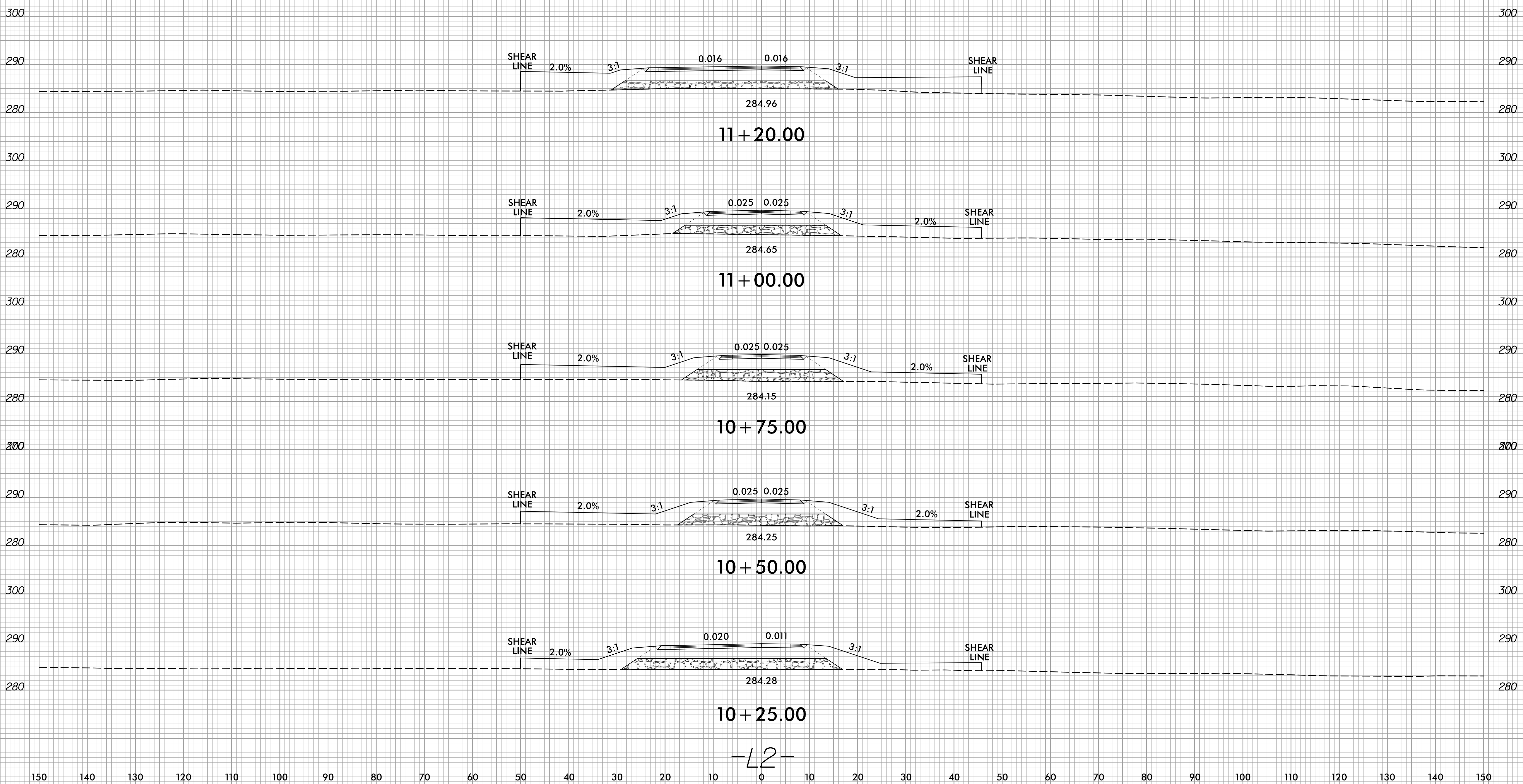

-L2-

8/23/2016
11:59:16
I:\S\197631_r-dj-xpl-1.1.2.dgn
RJD

8/23/99

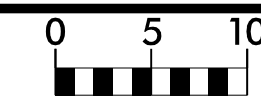

PROJ. REFERENCE NO.
R-5769

SHEET NO.
X-19

150 140 130 120 110 100 90 80 70 60 50 40 30 20 10 0 10 20 30 40 50 60 70 80 90 100 110 120 130 140 150

SHALLOW UNDERCUT EXCAVATION

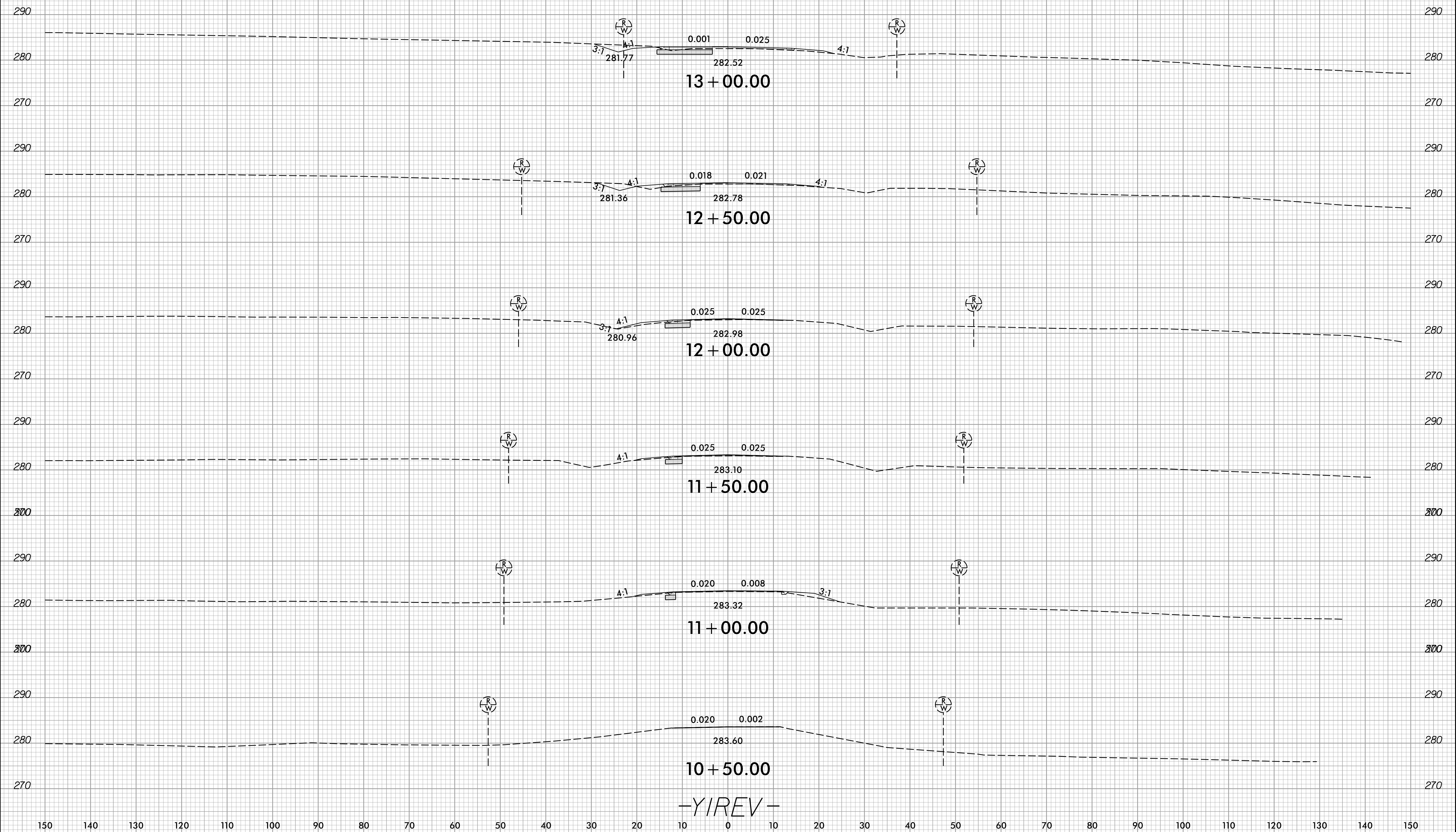

-YIREV-

8/23/2016
1:58:16
J:\S\197631_r-dj-xpl-YIREV.dgn

8/23/99

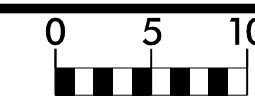

PROJ. REFERENCE NO.
R-5769

SHEET NO.
X-20

150 140 130 120 110 100 90 80 70 60 50 40 30 20 10 0 10 20 30 40 50 60 70 80 90 100 110 120 130 140 150

SHALLOW UNDERCUT EXCAVATION

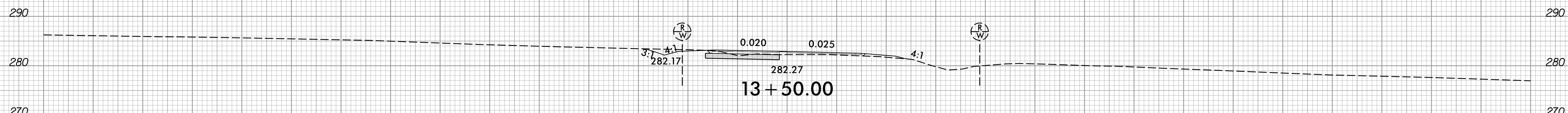
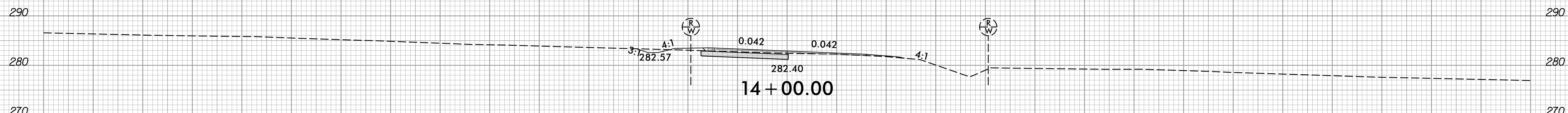
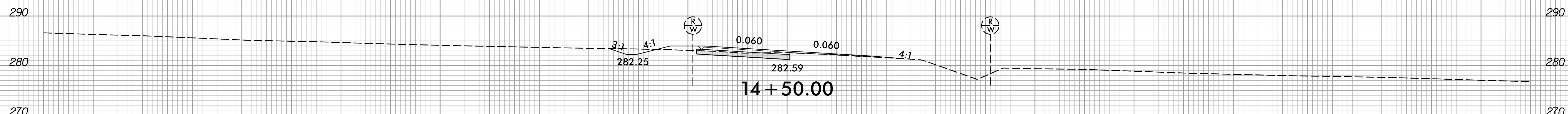
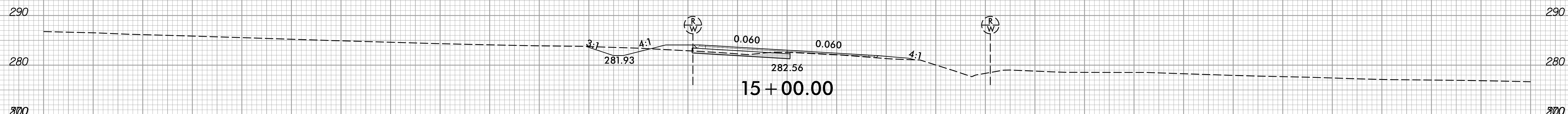
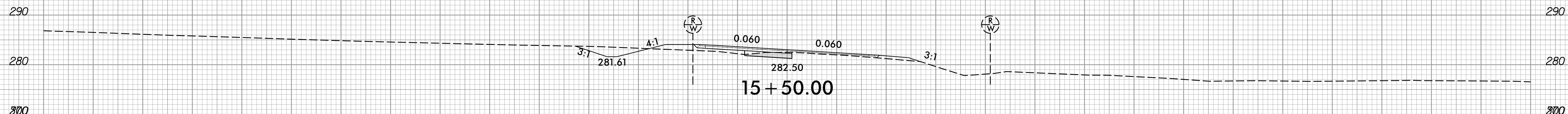
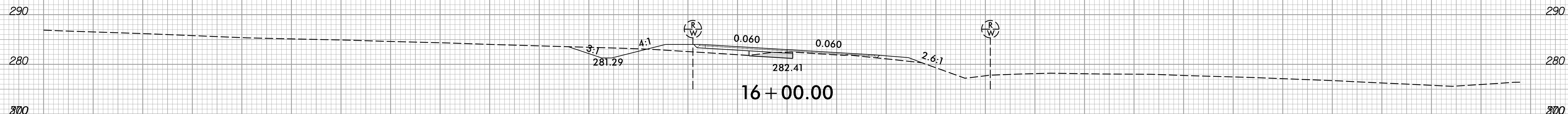

-YIREV-

150 140 130 120 110 100 90 80 70 60 50 40 30 20 10 0 10 20 30 40 50 60 70 80 90 100 110 120 130 140 150

8/23/2016
13:19:16
I:\S\157631_r-dj-xpl-YIREV.dgn

8/23/99

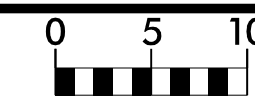

PROJ. REFERENCE NO.
R-5769

SHEET NO.
X-21

150 140 130 120 110 100 90 80 70 60 50 40 30 20 10 0 10 20 30 40 50 60 70 80 90 100 110 120 130 140 150

SHALLOW UNDERCUT EXCAVATION

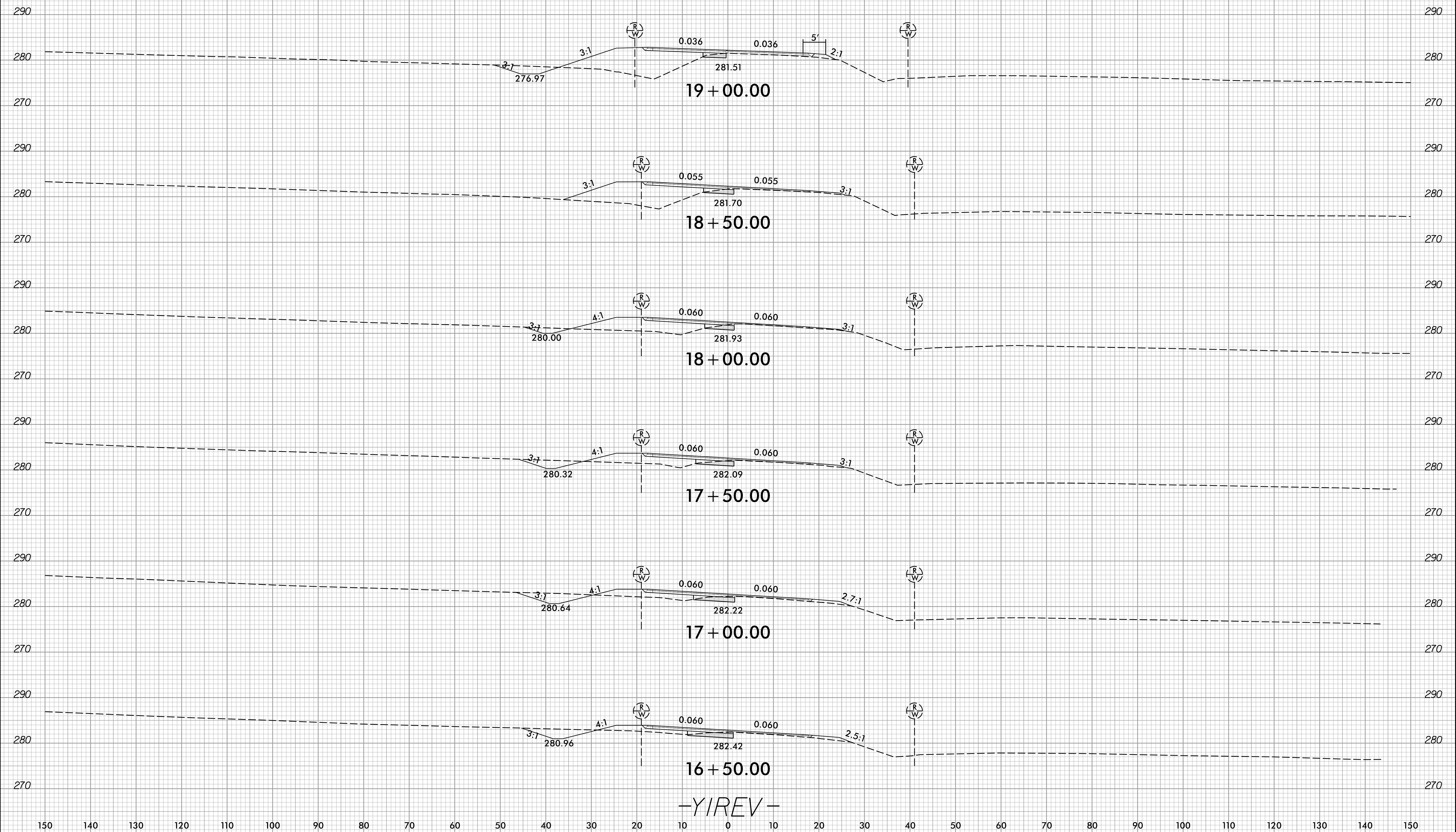

8/23/2016
1:59:16
I:\S\16\1_r-dj-xpl-YIREV.dgn
USER: kdjs

150 140 130 120 110 100 90 80 70 60 50 40 30 20 10 0 10 20 30 40 50 60 70 80 90 100 110 120 130 140 150

8/23/99

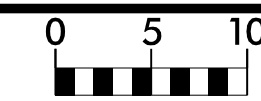

PROJ. REFERENCE NO.
R-5769

SHEET NO.
X-22

150 140 130 120 110 100 90 80 70 60 50 40 30 20 10 0 10 20 30 40 50 60 70 80 90 100 110 120 130 140 150

SHALLOW UNDERCUT EXCAVATION

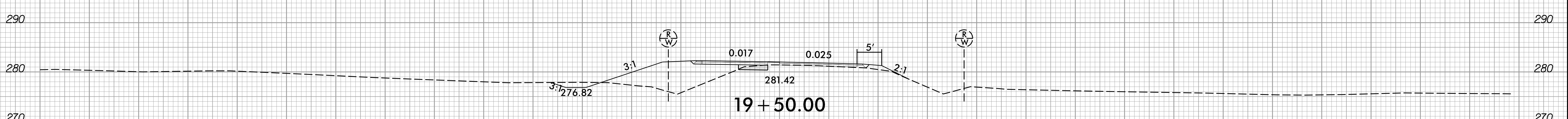
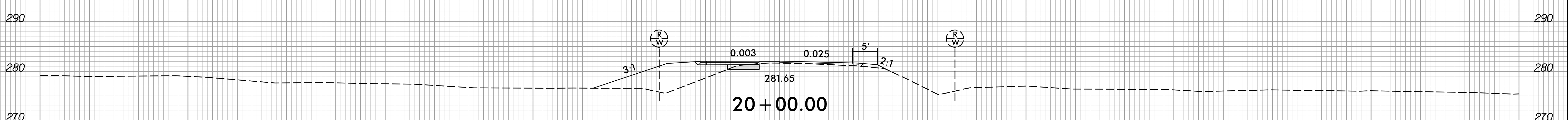
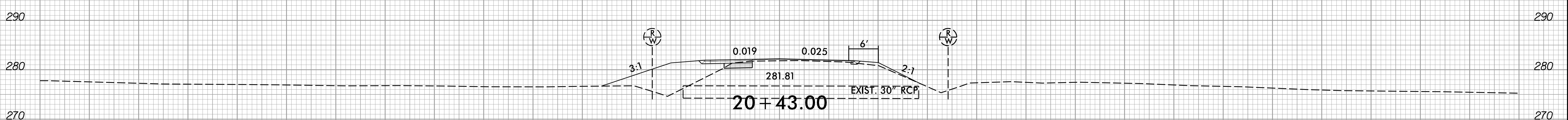
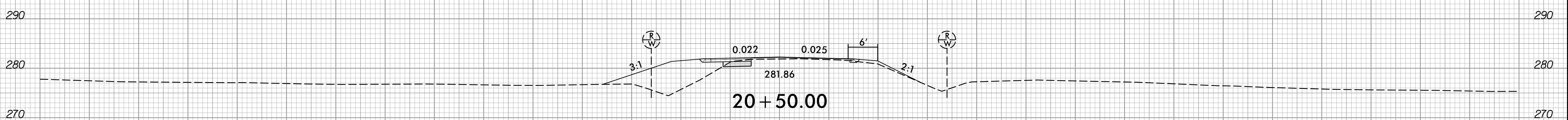
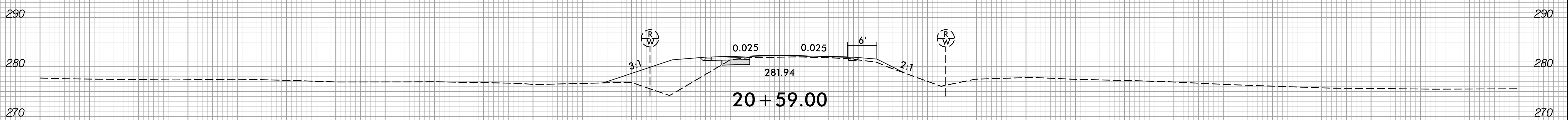
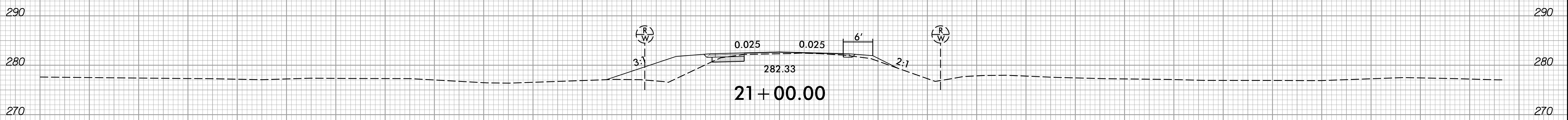

-YIREV-

150 140 130 120 110 100 90 80 70 60 50 40 30 20 10 0 10 20 30 40 50 60 70 80 90 100 110 120 130 140 150

8/23/2016
1:51:19
J:\1976\1976_1_r-dj-xpl-YIREV.dgn

8/23/99

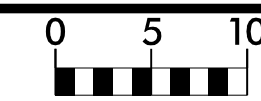

PROJ. REFERENCE NO.
R-5769

SHEET NO.
X-23

150 140 130 120 110 100 90 80 70 60 50 40 30 20 10 0 10 20 30 40 50 60 70 80 90 100 110 120 130 140 150

SHALLOW UNDERCUT EXCAVATION

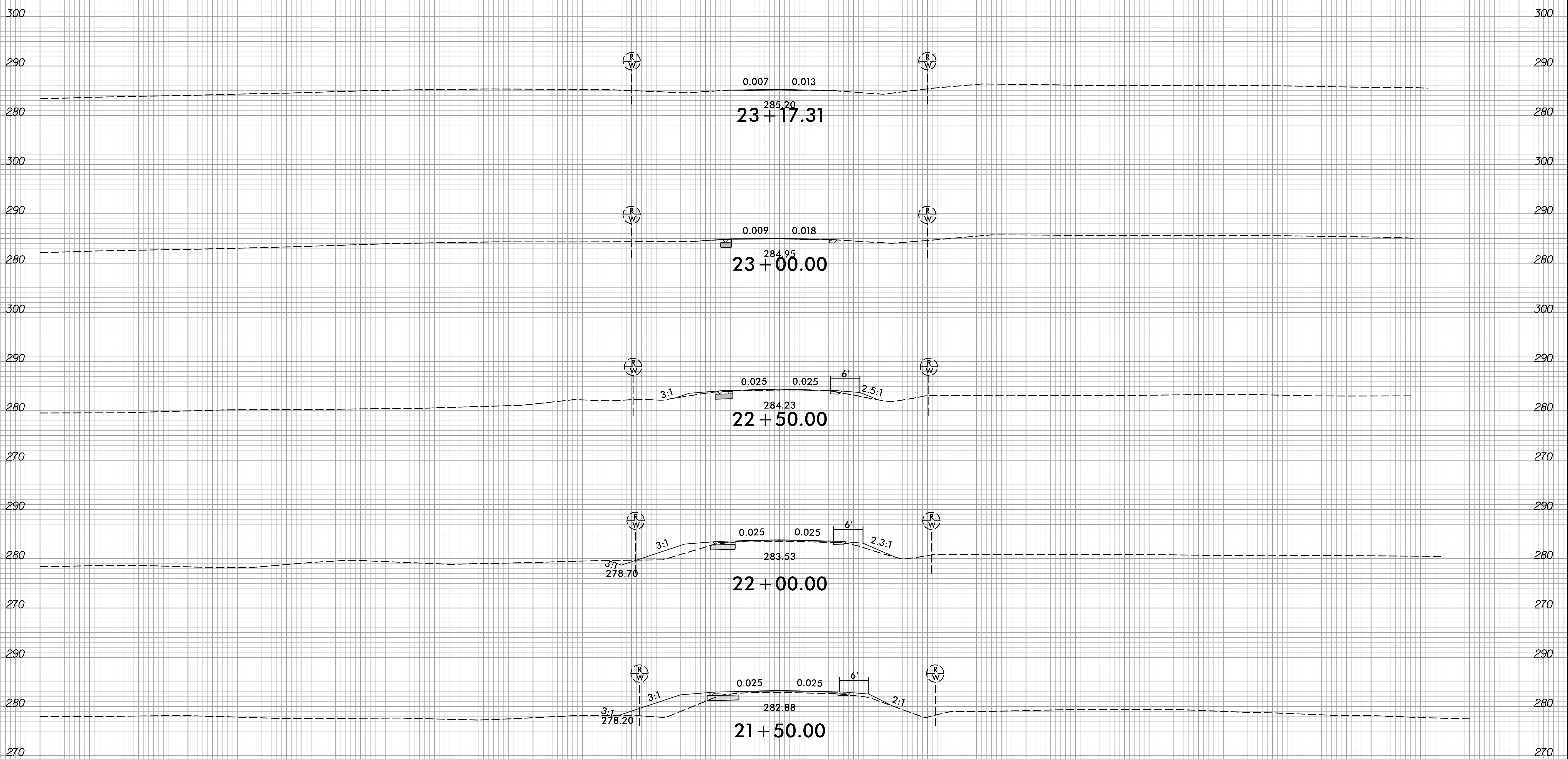

-YIREV-

150 140 130 120 110 100 90 80 70 60 50 40 30 20 10 0 10 20 30 40 50 60 70 80 90 100 110 120 130 140 150

8/23/2016
1:58:16
J:\S\197631_r-dj-xpl-YIREV.dgn