

HNTB
 HNTB NORTH CAROLINA, P.C.
 233 W. Fifth Street, Suite 200
 Raleigh, North Carolina 27609
 NC License No. C-1554

PLANS PREPARED BY:
PARSONS
 RALEIGH, NORTH CAROLINA, 1931 954-1345
 NC LICENSE NO. F-0246
 FOR NORTH CAROLINA DEPT. OF TRANSPORTATION

PROJECT REFERENCE NO. U-2524D	SHEET NO. 8
RW SHEET NO.	HYDRAULICS ENGINEER
ROADWAY DESIGN ENGINEER	SEAL M. J. HAYES, P.E. 6/10/2010
NORTH CAROLINA PROFESSIONAL SEAL SEAL M. J. HAYES, P.E. 6/10/2010	

**DOCUMENT NOT CONSIDERED FINAL
 UNLESS ALL SIGNATURES COMPLETED**

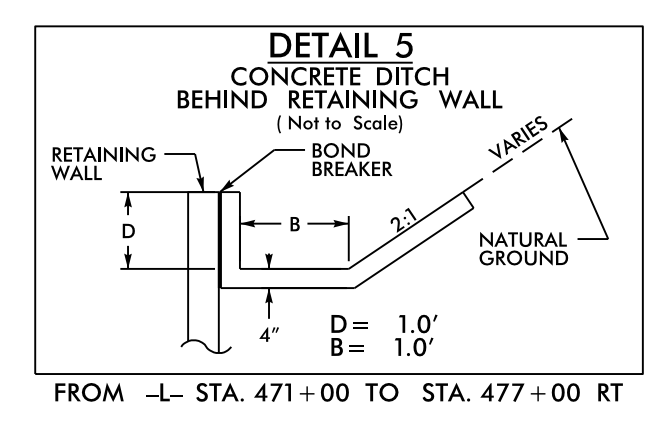
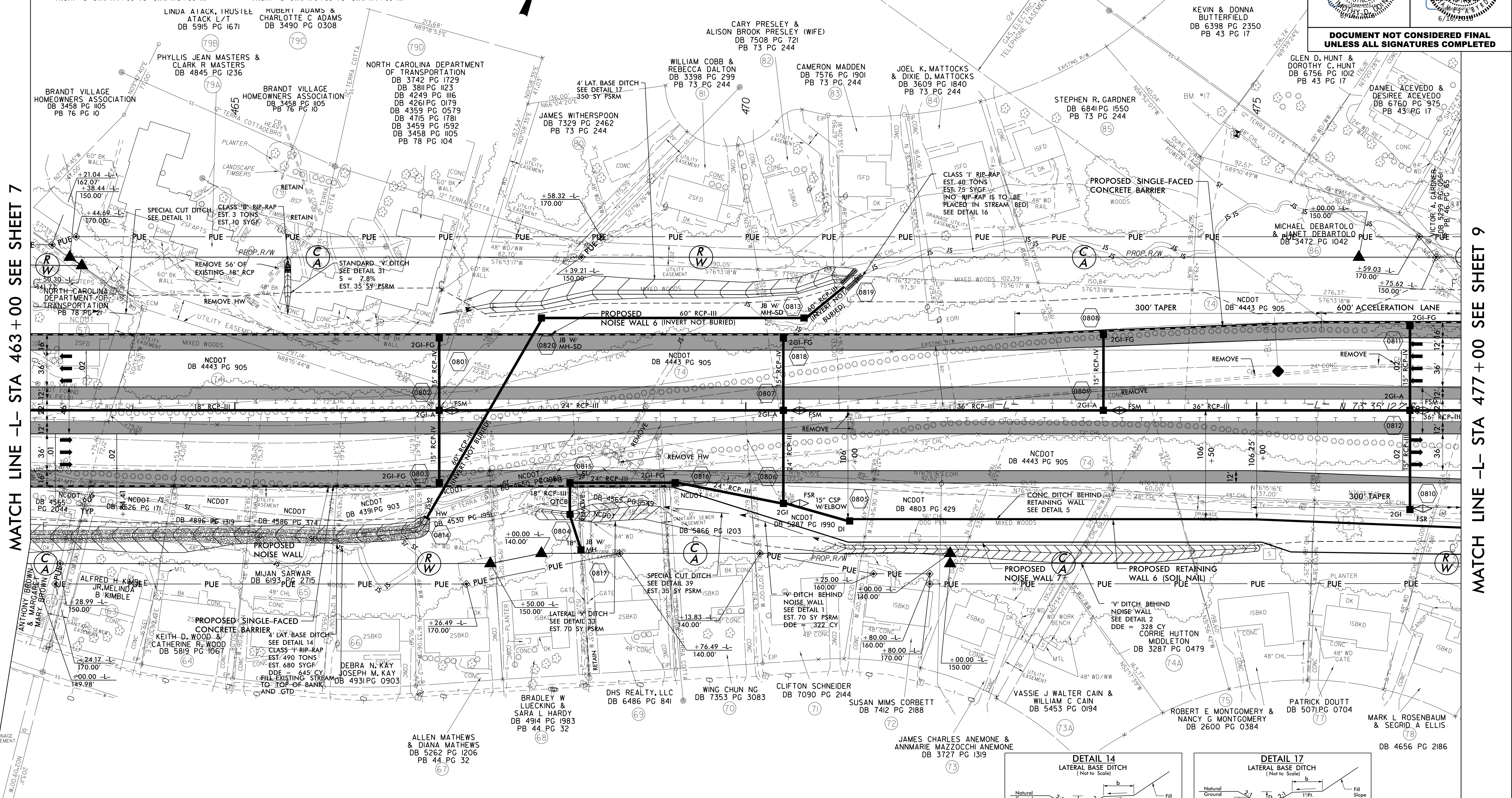
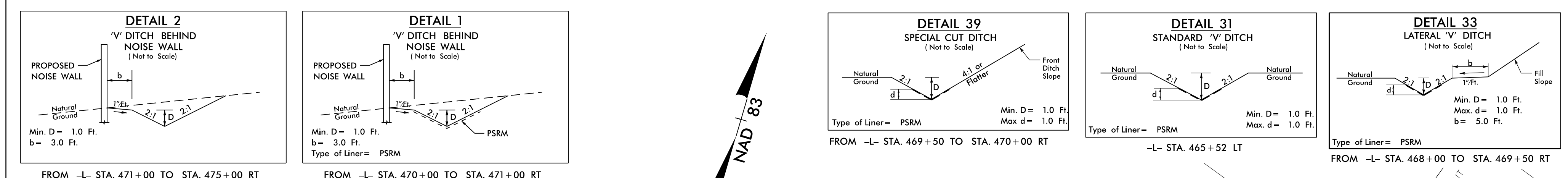

DETAIL FSM
 FALSE SUMP (Not to Scale)

Ditch Slope	L	Ditch Grade	L
0.0% To 2.0%	20'	Over 4.0% To 6.0%	40'
Over 2.0% To 4.0%	30'	Over 6.0%	50'

-L 467+00 M
 -L 470+37 M
 -L 473+50 M
 -L 476+50 M

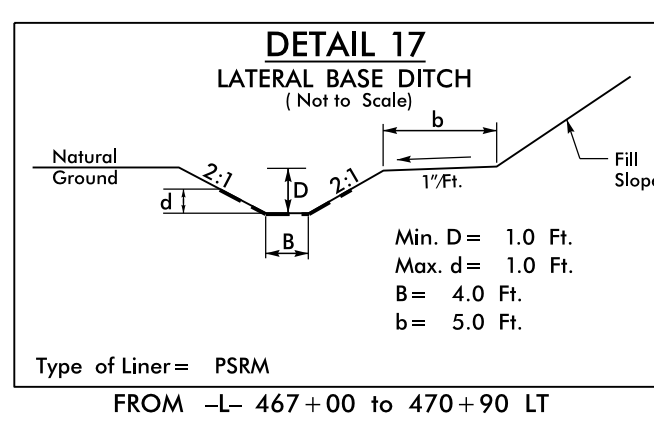
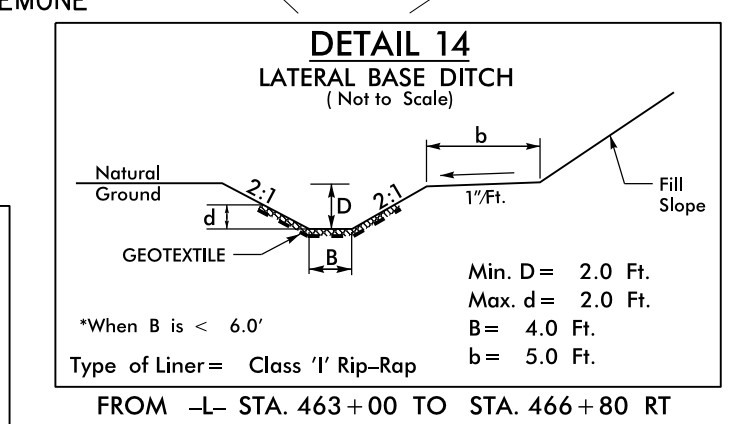
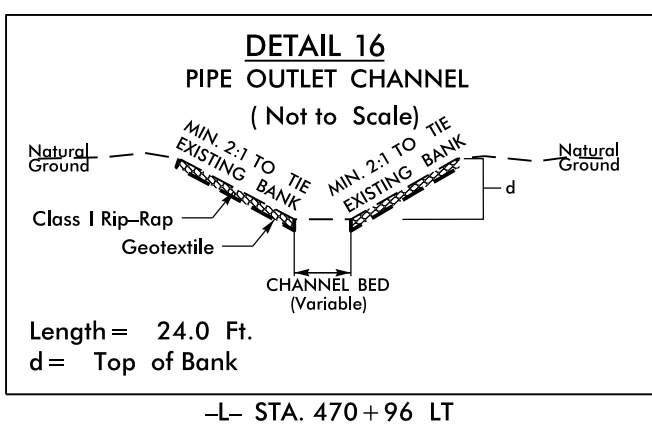
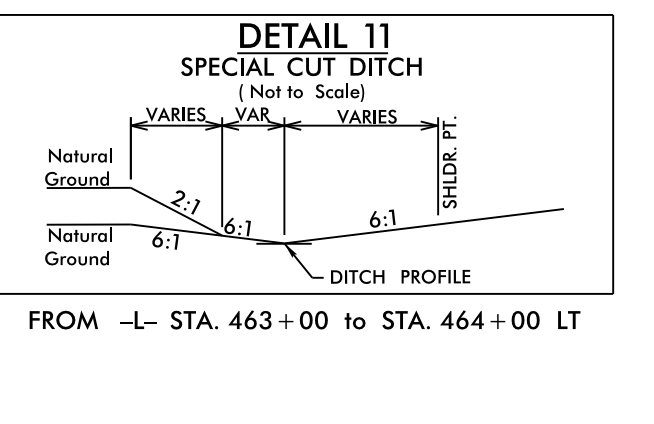
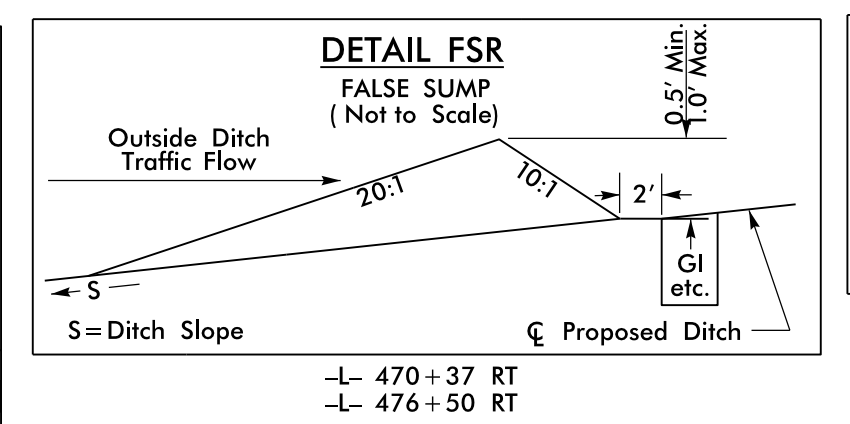

NOTE:
 SEE SHEET 17 FOR -L- PROFILE

MATCH LINE -L- STA 463+00 SEE SHEET 7

MATCH LINE -L- STA 477+00 SEE SHEET 9

REVISIONS

8.17.7.99
 10 JUN 2016 13:55
 J:\N\2524D\1355\kku\Prj\AU2524D_RDY_PSH_08.dwg
 \$\$\$\$\$\$ USER:RAM:\$\$\$\$\$