

**This electronic collection of documents is provided  
for the convenience of the user  
and is Not a Certified Document –**

**The documents contained herein were originally issued  
and sealed by the individuals whose names and license  
numbers appear on each page, on the dates appearing  
with their signature on that page.**

**This file or an individual page  
shall not be considered a certified document.**

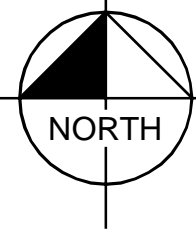

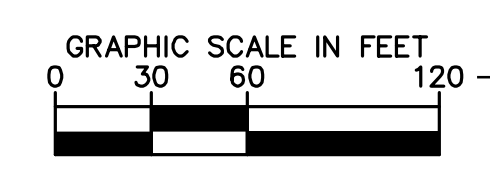

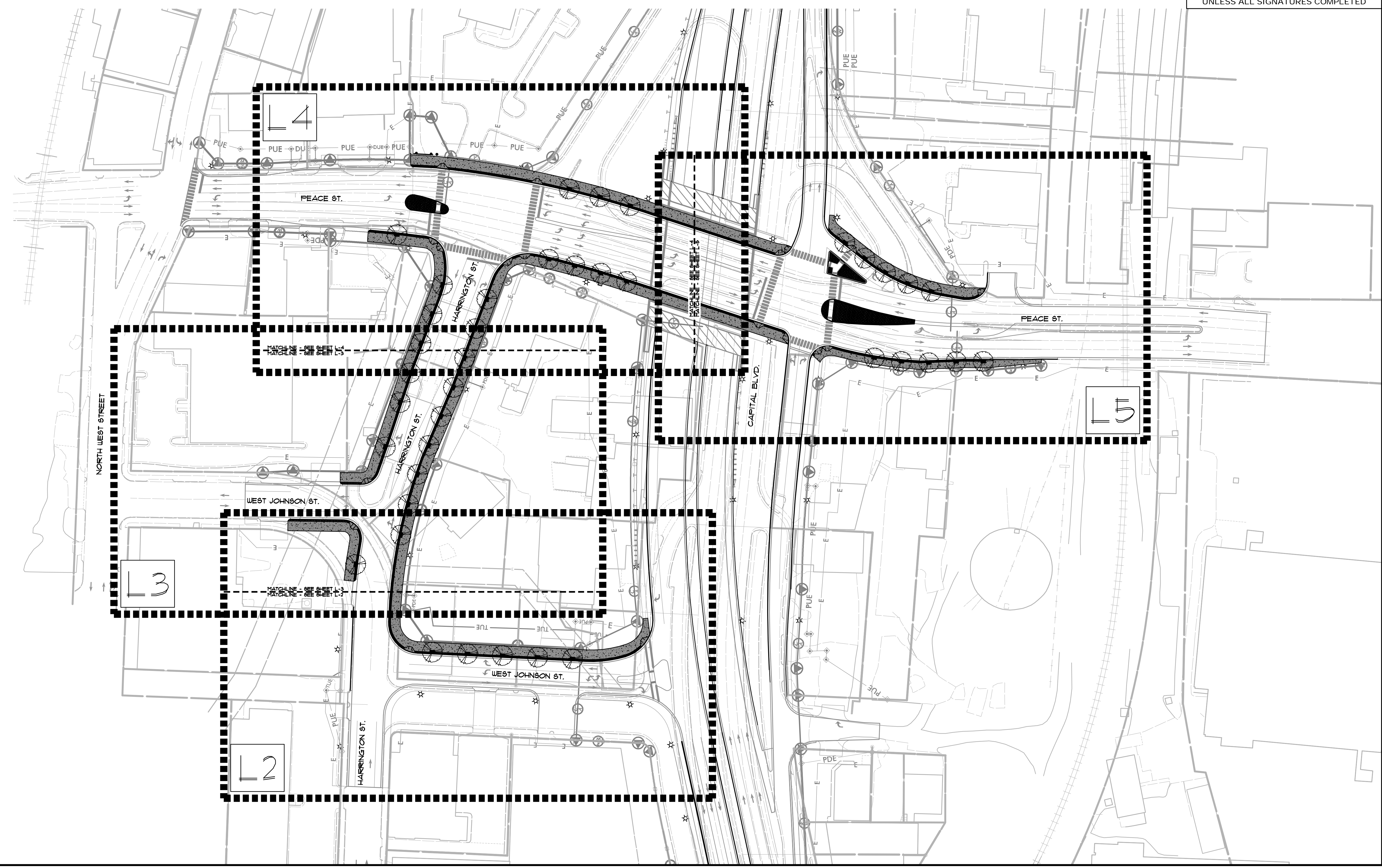

REVISIONS

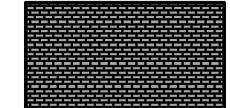

5/14/99

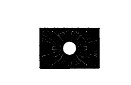
### LEGEND

-  CONCRETE SIDEWALK  
SEE DETAIL 1 / LD-1
-  CONCRETE PAVERS  
SEE DETAIL 4 / LD-1 &  
DETAIL 6 / LD-2
-  DETECTABLE WARNING PANEL  
SEE DETAIL 5 / LD-2
-  TREE GRATE  
SEE DETAIL 6 / LD-1
-  STREET LIGHT  
(BY OTHERS)
-  ORNAMENTAL FENCE  
SEE DETAIL 7 / LD-2

### PLANT MATERIAL (PROVIDED BY OTHERS)

OVERALL PLANT SCHEDULE

TREES	CODE	QTY	BOTANICAL NAME	COMMON NAME	CONT	CAL	SIZE
	QUE GLF 39		Quercus lyrata #QLFTB# P.P.#3470	Highbeam Overcup Oak	B4B	3.5'Cal	14#-16# HT.

PLANT SCHEDULE SHEET LI

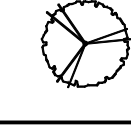
TREES	CODE	QTY	BOTANICAL NAME	COMMON NAME	CONT	CAL	SIZE
	QUE GLF 5		Quercus lyrata #QLFTB# P.P.#3470	Highbeam Overcup Oak	B4B	3.5'Cal	14#-16# HT.

**Kimley»Horn**  
©2016  
P.O. BOX 33068 • RALEIGH, N.C. 27636-3068

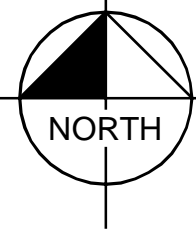
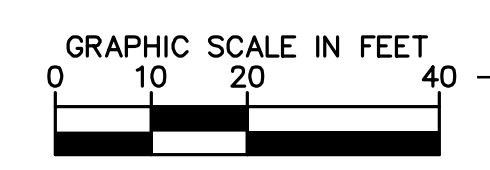

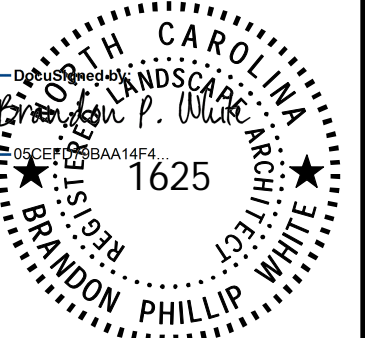
PROJECT REFERENCE NO. B-5121 / B-5317	SHEET NO. L-2
SHEET TITLE: LANDSCAPE PLAN	
LANDSCAPE ARCHITECT	
	
6/2/2016	
DOCUMENT NOT CONSIDERED FINAL UNLESS ALL SIGNATURES COMPLETED	

REVISIONS

MATCHLINE - SEE SHEET L-3  
 MATCHLINE - SEE SHEET L-2

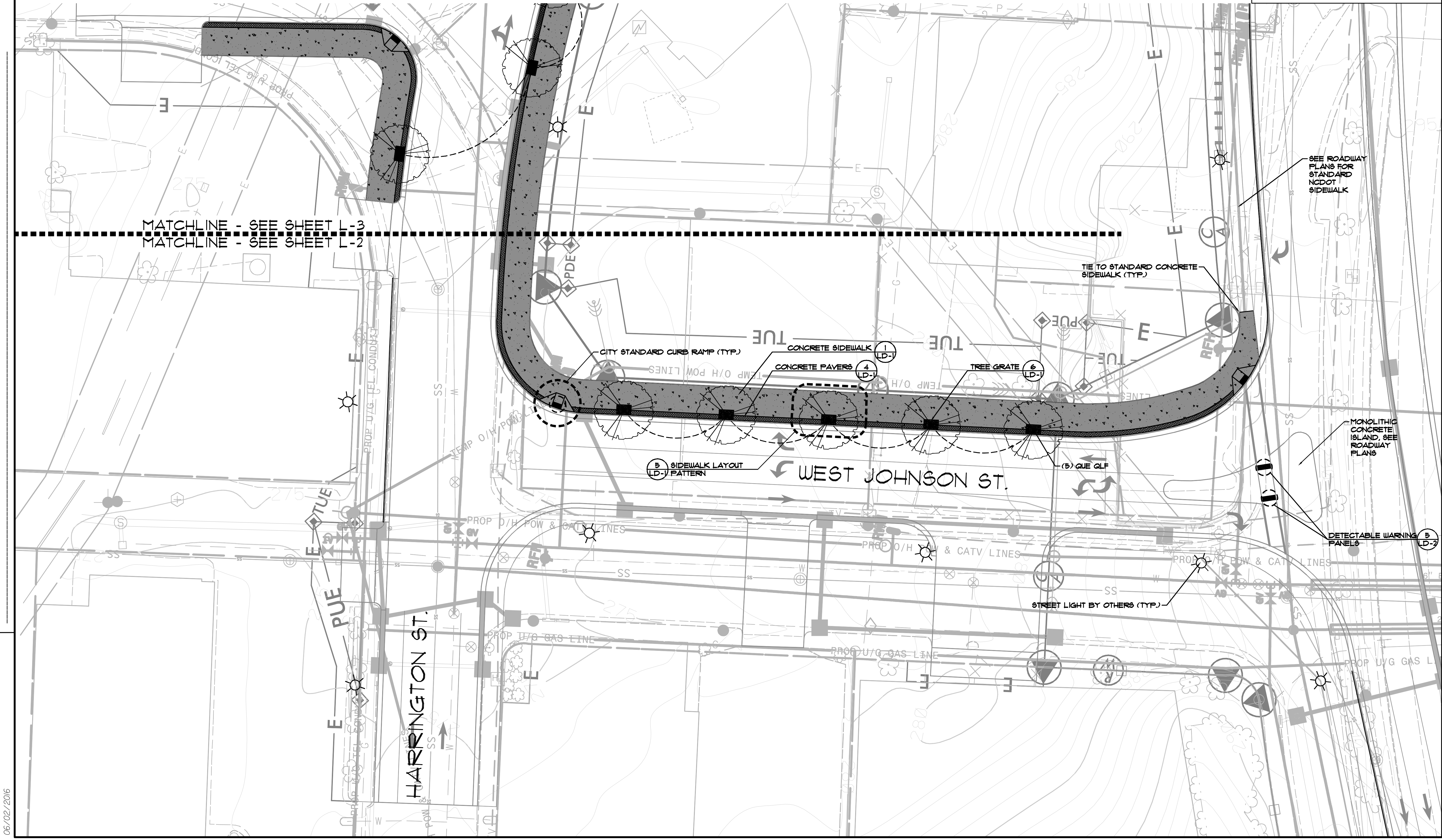

SEE ROADWAY  
PLANS FOR  
STANDARD  
NCDOT  
SIDEWALK

TIE TO STANDARD CONCRETE  
SIDEWALK (TYP.)

MONOLITHIC  
CONCRETE  
ISLAND, SEE  
ROADWAY  
PLANS





DETECTABLE WARNING  
PANELS

HARRINGTON ST.

WEST JOHNSON ST.

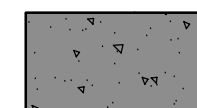
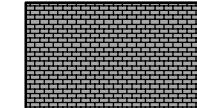
06/02/2016

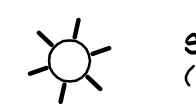
### LEGEND

-  CONCRETE SIDEWALK  
SEE DETAIL 1 / LD-1
-  CONCRETE PAVERS  
SEE DETAIL 4 / LD-1 &  
DETAIL 6 / LD-2
-  DETECTABLE WARNING PANEL  
SEE DETAIL 5 / LD-2
-  TREE GRATE  
SEE DETAIL 6 / LD-1
-  STREET LIGHT  
(BY OTHERS)
-  ORNAMENTAL FENCE  
SEE DETAIL 7 / LD-2

### PLANT MATERIAL (PROVIDED BY OTHERS)

OVERALL PLANT SCHEDULE

TREES	CODE	QTY	BOTANICAL NAME	COMMON NAME	CONT.	CAL.	SIZE
	QUE QLF	39	Quercus lyrata #QLFTB# P.P.#3470	Highbeam Overcup Oak	B4B	3.5'Cal	14#-16# HT.

PLANT SCHEDULE SHEET L2

TREES	CODE	QTY	BOTANICAL NAME	COMMON NAME	CONT.	CAL.	SIZE
	QUE QLF	11	Quercus lyrata #QLFTB# P.P.#3470	Highbeam Overcup Oak	B4B	3.5'Cal	14#-16# HT.

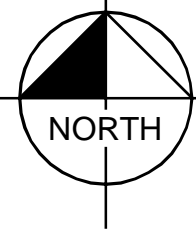
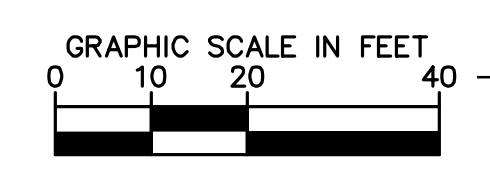

REVISIONS

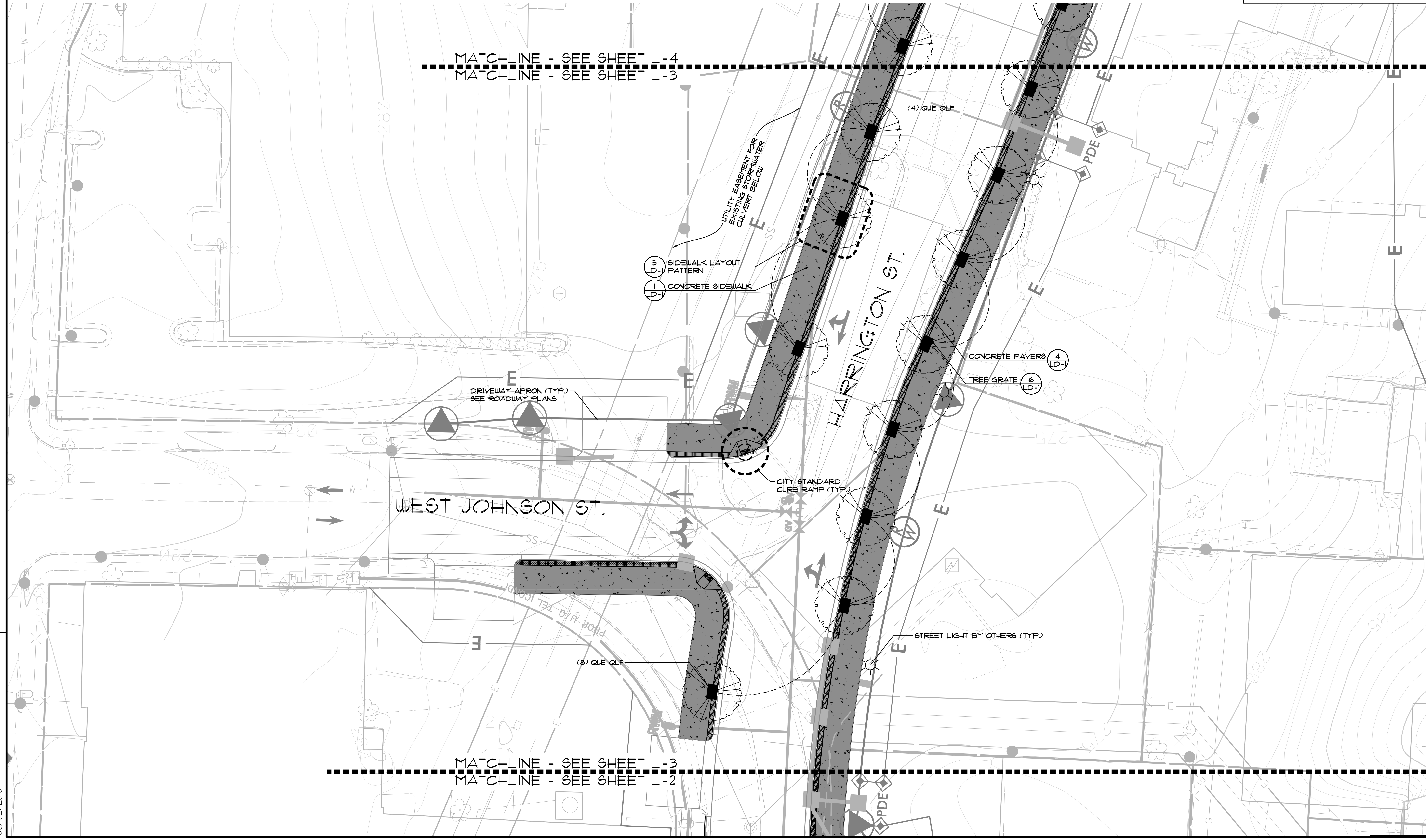





MATCHLINE - SEE SHEET L-4  
 MATCHLINE - SEE SHEET L-3

MATCHLINE - SEE SHEET L-3  
 MATCHLINE - SEE SHEET L-2

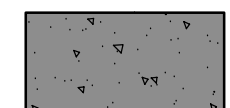
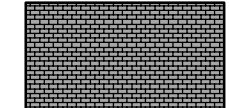
5/14/99

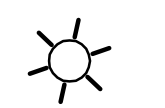
### LEGEND

-  CONCRETE SIDEWALK  
SEE DETAIL 1 / LD-1
-  CONCRETE PAVERS  
SEE DETAIL 4 / LD-1 &  
DETAIL 6 / LD-2
-  DETECTABLE WARNING PANEL  
SEE DETAIL 5 / LD-2
-  TREE GRATE  
SEE DETAIL 6 / LD-1
-  STREET LIGHT  
(BY OTHERS)
-  ORNAMENTAL FENCE  
SEE DETAIL 1 / LD-2

### PLANT MATERIAL (PROVIDED BY OTHERS)

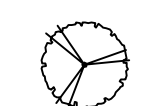
OVERALL PLANT SCHEDULE							
TREES	CODE	QTY	BOTANICAL NAME	COMMON NAME	CONT.	CAL.	SIZE
	QUE GLF	39	Quercus lyrata #QLFTB# P.P.#3470	Highbeam Overcup Oak	B4B	3.5'Cal	14#-16# HT.
PLANT SCHEDULE SHEET L3							
TREES	CODE	QTY	BOTANICAL NAME	COMMON NAME	CONT.	CAL.	SIZE
	QUE GLF	13	Quercus lyrata #QLFTB# P.P.#3470	Highbeam Overcup Oak	B4B	3.5'Cal	14#-16# HT.

**Kimley»Horn**  
©2016  
 P.O. BOX 33068 • RALEIGH, N.C. 27636-3068

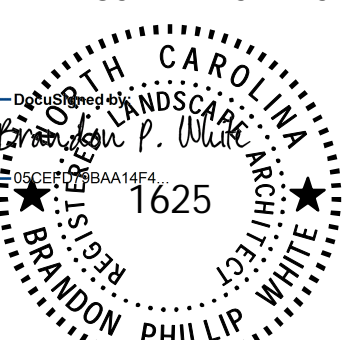
PROJECT REFERENCE NO. B-5121 / B-5317	SHEET NO. L-4
SHEET TITLE: LANDSCAPE PLAN	
LANDSCAPE ARCHITECT	
 PHILLIP WHITE 1625 6/2/2016	
DOCUMENT NOT CONSIDERED FINAL UNLESS ALL SIGNATURES COMPLETED	

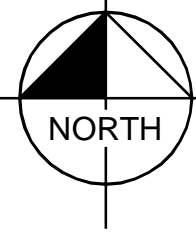
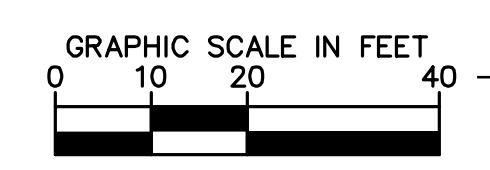

REVISIONS

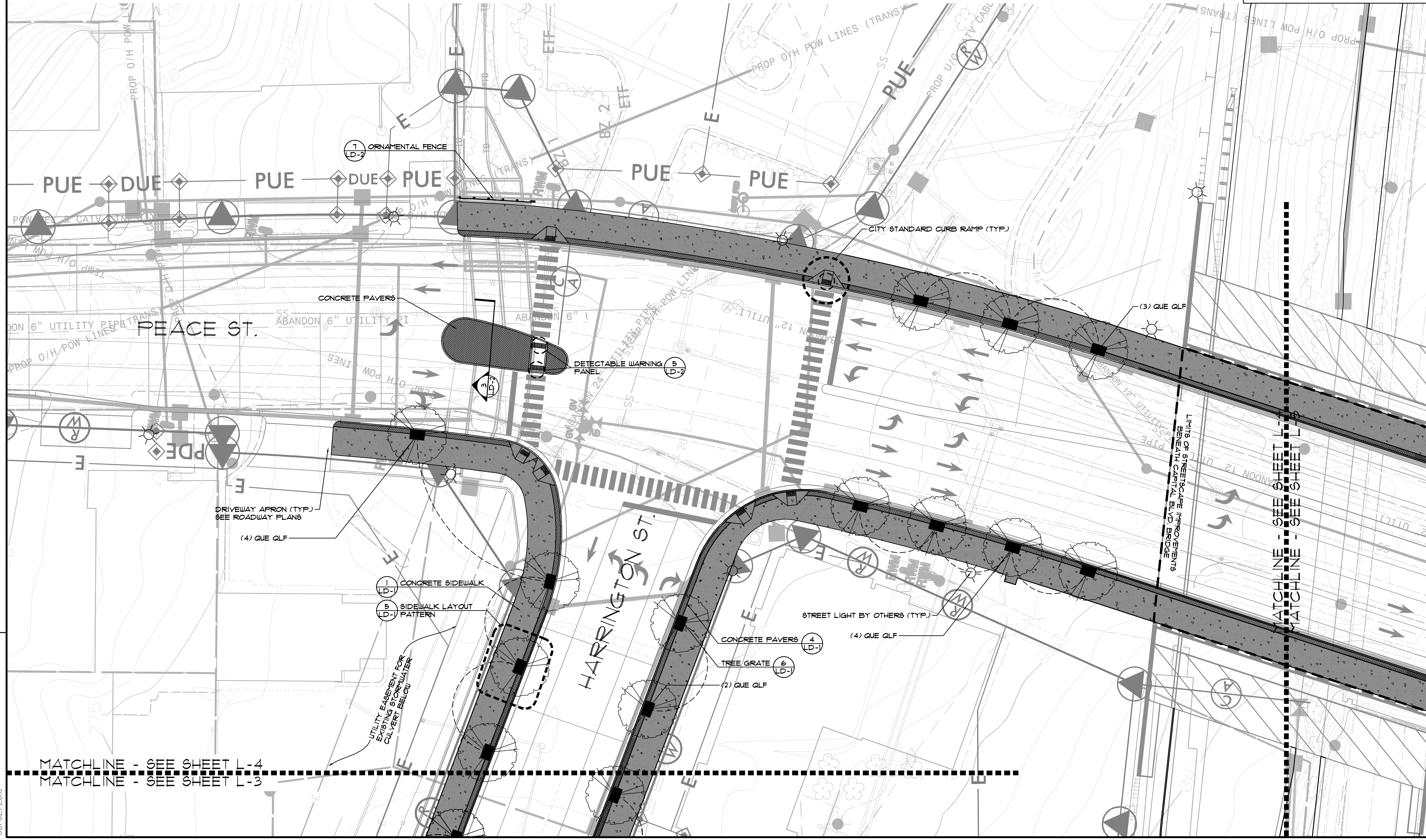





MATCHLINE - SEE SHEET L-4  
 MATCHLINE - SEE SHEET L-3

MATCHLINE - SEE SHEET L-4  
 MATCHLINE - SEE SHEET L-3

06/02/2016

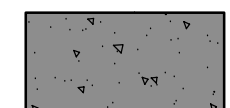
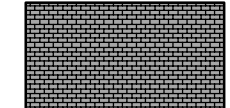
5/14/99

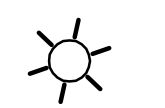
### LEGEND

-  CONCRETE SIDEWALK  
SEE DETAIL 1 / LD-1
-  CONCRETE PAVERS  
SEE DETAIL 4 / LD-1 &  
DETAIL 6 / LD-2
-  DETECTABLE WARNING PANEL  
SEE DETAIL 5 / LD-2
-  TREE GRATE  
SEE DETAIL 6 / LD-1
-  STREET LIGHT  
(BY OTHERS)
-  ORNAMENTAL FENCE  
SEE DETAIL 7 / LD-2

### PLANT MATERIAL (PROVIDED BY OTHERS)

OVERALL PLANT SCHEDULE

TREES	CODE	QTY	BOTANICAL NAME	COMMON NAME	CONT	CAL	SIZE
	QUE GLF	35	Quercus lyrata #QLFTB# P/P#3470	Highbeam Overcup Oak	B4B	3.5'Cal	14#-16# HT.

PLANT SCHEDULE SHEET L4

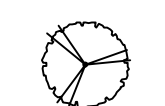
TREES	CODE	QTY	BOTANICAL NAME	COMMON NAME	CONT	CAL	SIZE
	QUE GLF	10	Quercus lyrata #QLFTB# P/P#3470	Highbeam Overcup Oak	B4B	3.5'Cal	14#-16# HT.

**Kimley»Horn**  
©2016  
P.O. BOX 33068 • RALEIGH, N.C. 27636-3068

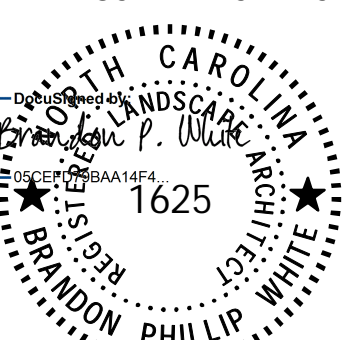
PROJECT REFERENCE NO. B-5121 / B-5317	SHEET NO. L-5
SHEET TITLE: LANDSCAPE PLAN	
LANDSCAPE ARCHITECT	
	
6/2/2016	
DOCUMENT NOT CONSIDERED FINAL UNLESS ALL SIGNATURES COMPLETED	

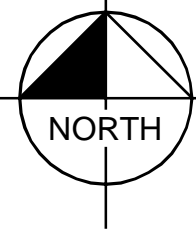
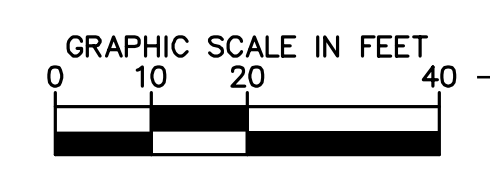

REVISIONS

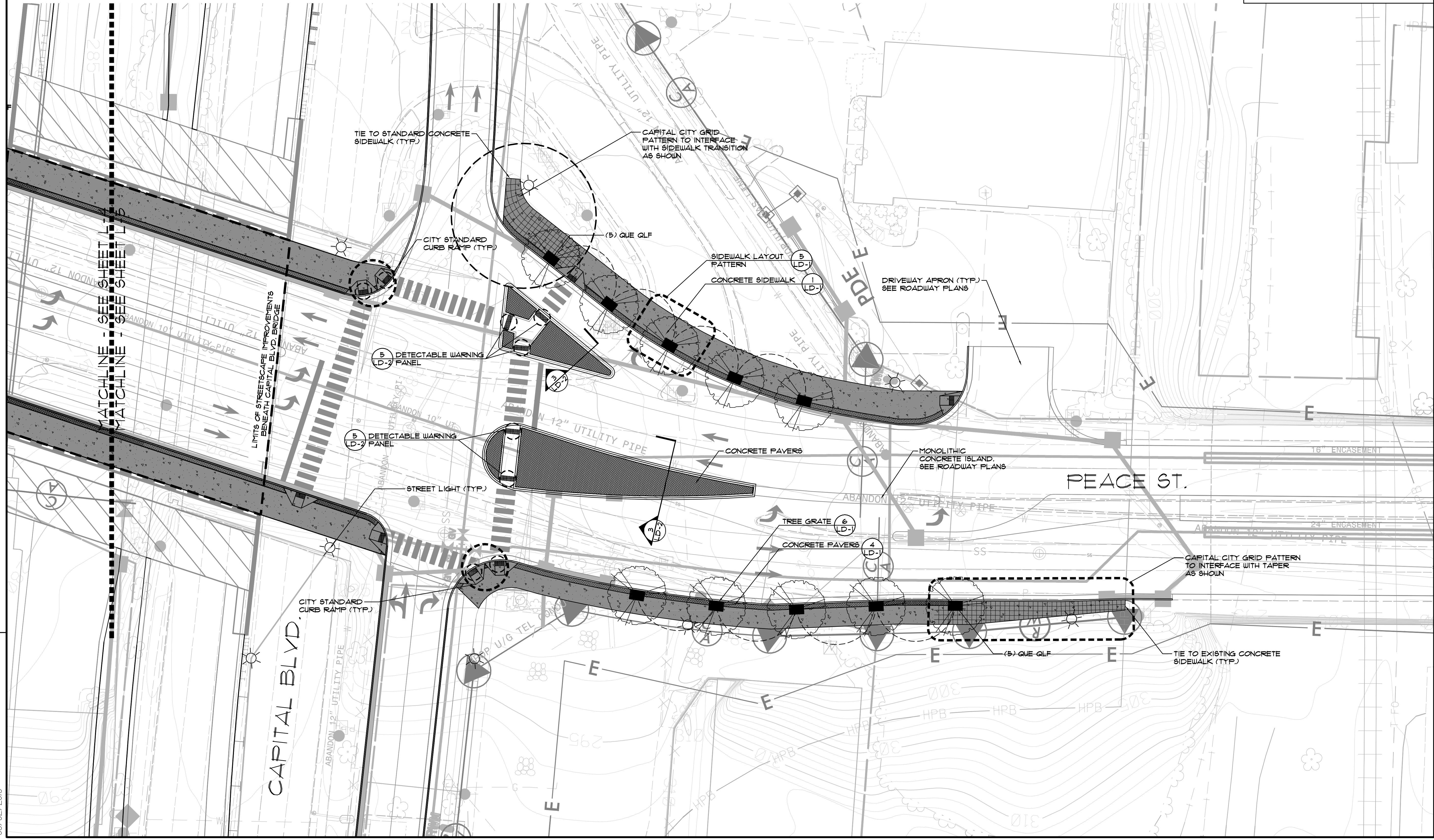

06/02/2016

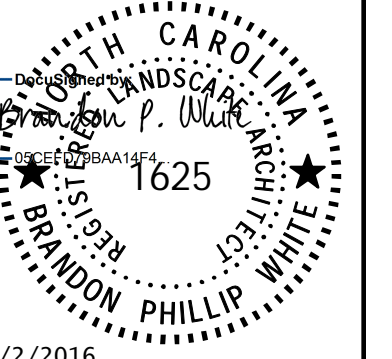
SHEET TITLE: LANDSCAPE DETAILS  
 LANDSCAPE ARCHITECT  
  
 6/2/2016

DOCUMENT NOT CONSIDERED FINAL  
 UNLESS ALL SIGNATURES COMPLETED

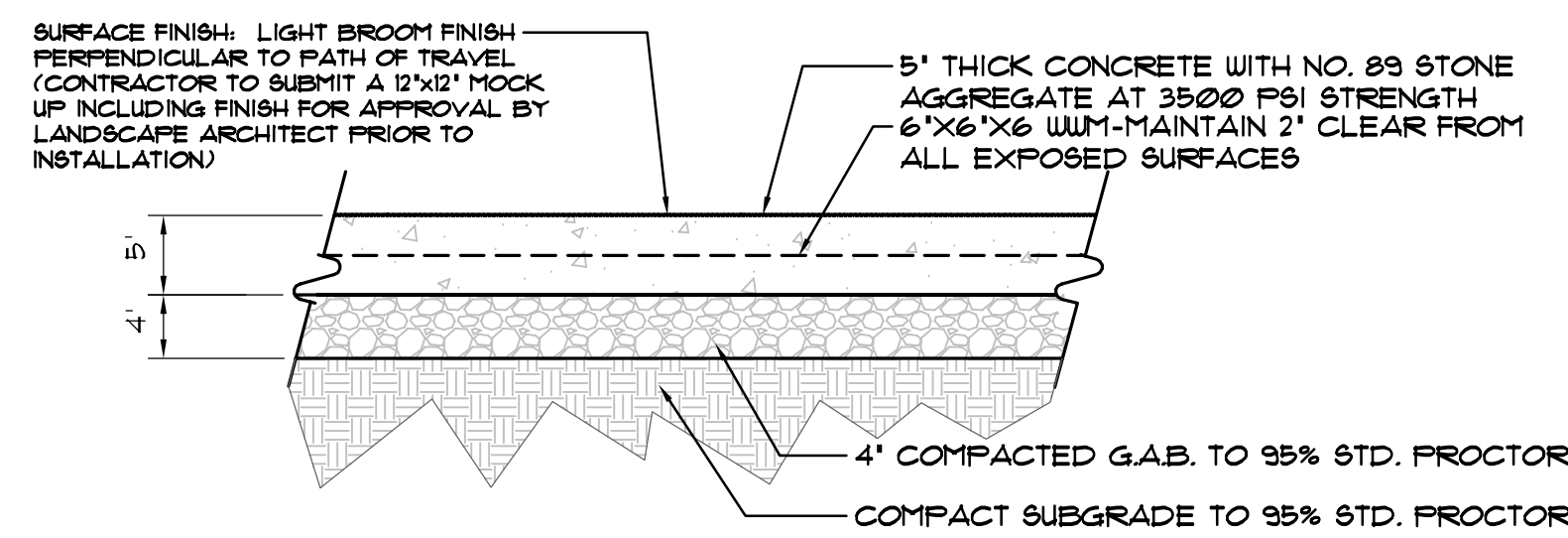

**1 CONCRETE SIDEWALK**  
 LD-1 SCALE: 1"=1'-0"  
 SECTION

**CONCRETE SIDEWALK NOTE:**  
 SEE DETAIL 1, LD-1 FOR SIMILAR CONSTRUCTION

**CONTROL JOINT NOTE:**  
 SEE HARDSCAPE PLANS FOR LOCATIONS AND PATTERN SHALL BE (CAPITAL CITY GRID) PER DETAIL 5, LD-1.

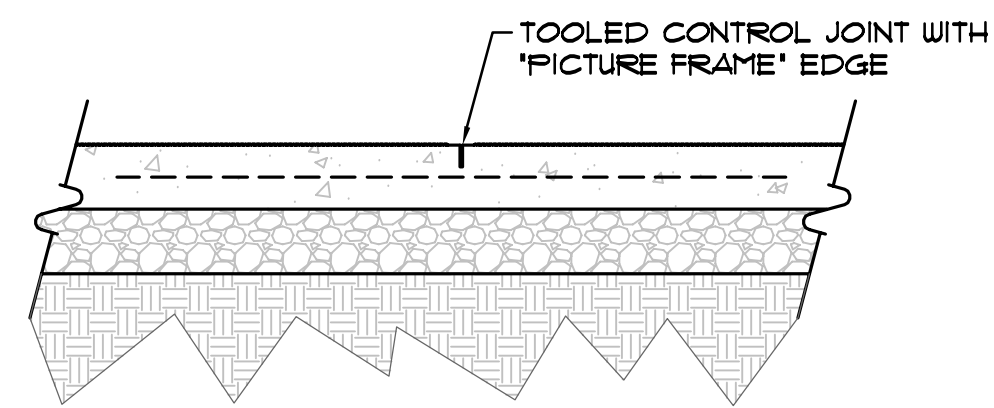

**CONCRETE FLATWORK NOTE:**  
 SEE DETAIL 1, LD-1 FOR SIMILAR CONSTRUCTION

**EXPANSION JOINT NOTE:**  
 SEE HARDSCAPE PLANS FOR LOCATIONS AND PATTERN, MAX. 30' O.C

**EXPANSION JOINT MATERIAL NOTE:**  
 MANUFACTURER: W.R. MEADOWS  
 PRODUCT: 'SNAP-CAP' EXPANSION JOINT CAP (1/2" WIDE X 1/2" DEEP)  
 CERAMAR

**EXPANSION JOINT SEALANT NOTE:**  
 MANUFACTURER: SIKA  
 PRODUCT: SIKAFLEX-1C SL  
 COLOR: 'LIMESTONE' (STANDARD)

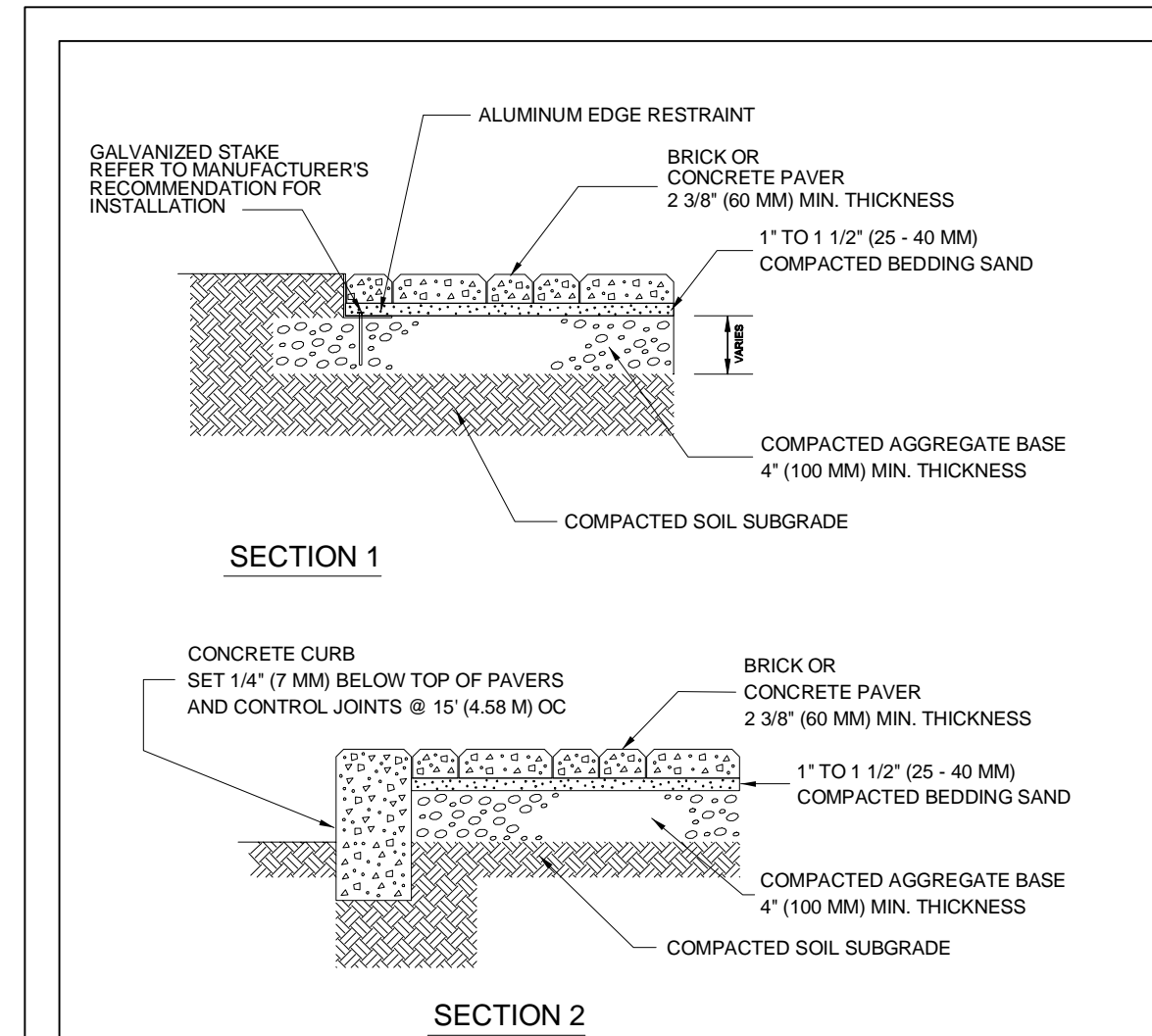
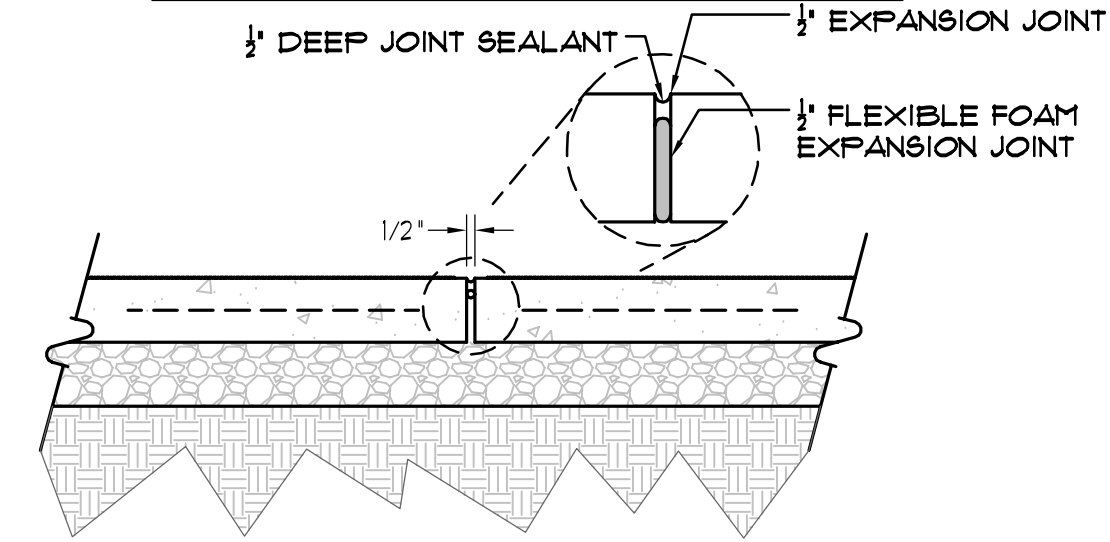

**SECTION 1**

**SECTION 2**

**NOTES:**  
 1. BRICK OR CONCRETE PAVERS ALLOWED ONLY UNDER SPECIAL CONDITIONS.  
 2. THICKNESS OF BASE MAY VARY WITH SUBGRADE/TRAFFIC CONDITIONS.  
 3. SCATTER SAND OR SCREENINGS OVER COMPLETE WORK AND SWEEP INTO CRACKS.  
 4. CONCRETE PAVERS SHOULD CONFORM TO REQUIREMENTS OF ASTM C-1319.  
 BRICK PAVERS SHOULD CONFORM TO REQUIREMENTS OF ASTM C902-95  
 5. SEE CITY OF RALEIGH CODE SECTION 10-7001 (D) FOR CONDITIONS UNDER WHICH CONCRETE / BRICK PAVERS ARE ALLOWED.

CITY OF RALEIGH PUBLIC WORKS DEPARTMENT		
REVISIONS	DATE	BY
CONCRETE/BRICK PAVES SIDEWALK DETAIL		
T-30.03		

**2 CONCRETE SIDEWALK CONTROL JOINT**  
 LD-1 SCALE: 1"=1'-0"  
 SECTION

**3 CONCRETE SIDEWALK EXPANSION JOINT**  
 LD-1 SCALE: 1"=1'-0"  
 SECTION

**4 CONCRETE PAVERS-SIDEWALK**  
 LD-1 SCALE: NOT TO SCALE  
 SECTION

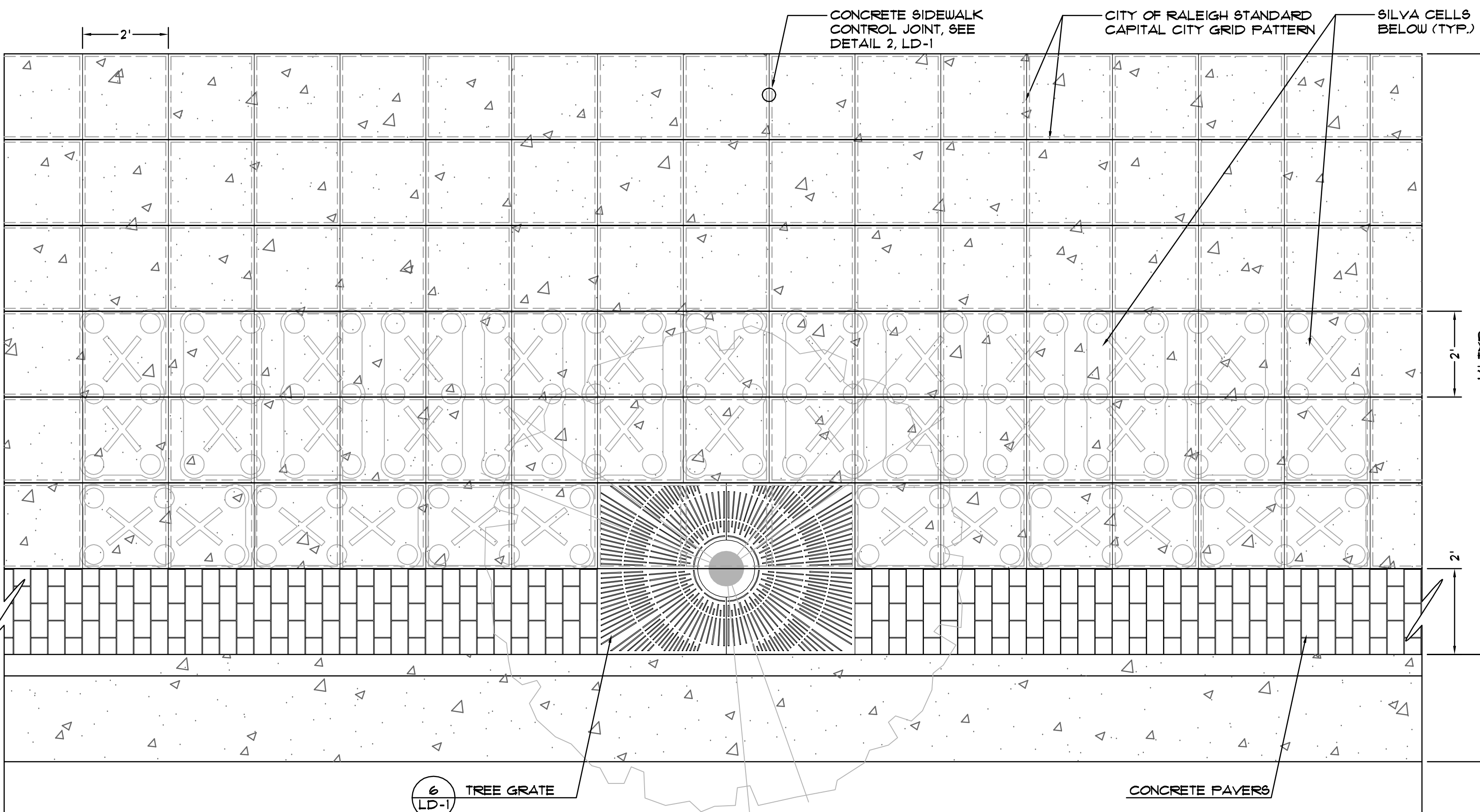

**5 SIDEWALK LAYOUT PATTERN (CAPITAL CITY GRID)**  
 LD-1 SCALE: 1/2"=1'-0"  
 PLAN

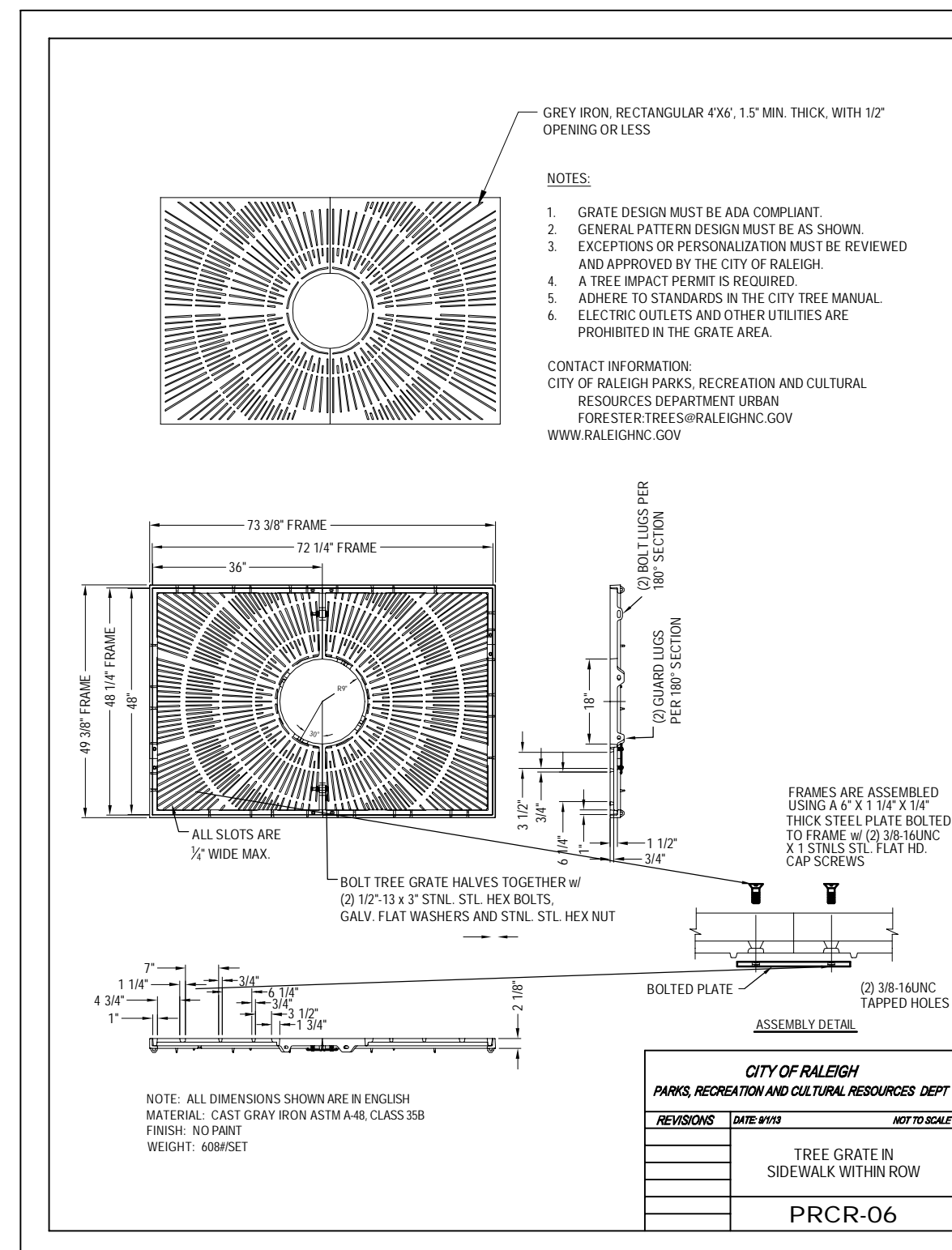

**6 TREE GRATE**  
 LD-1 SCALE: NOT TO SCALE  
 PLAN & SECTION

REVISIONS

5/14/99

06/02/2016

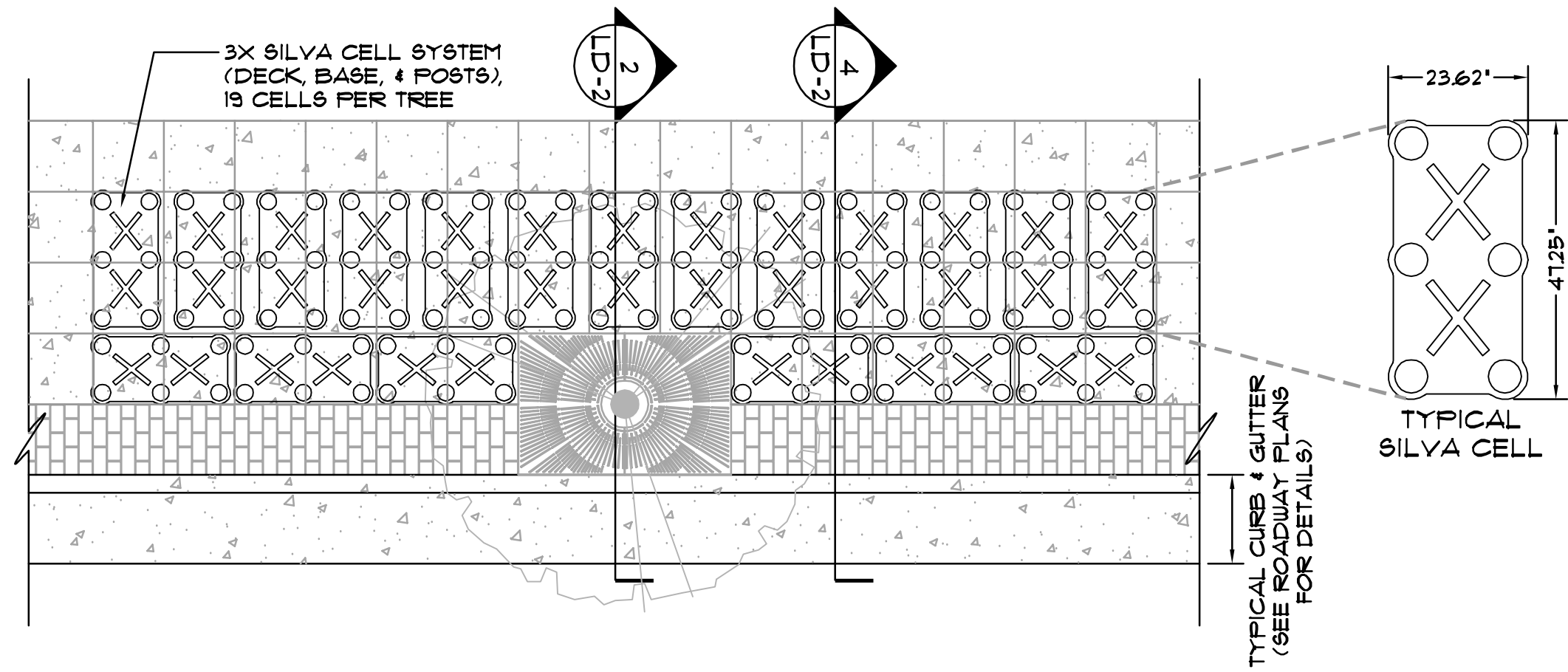

**1 TREE PIT - SILVA CELL LAYOUT**  
LD-2 SCALE: 1/4" = 1'-0" PLAN

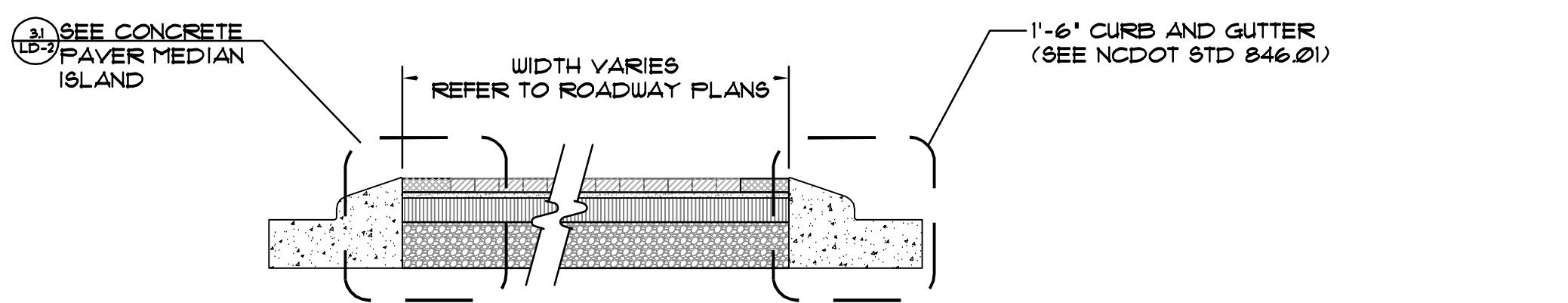

**3 CONCRETE PAVER MEDIAN ISLAND - MOUNTABLE CURB**  
LD-2 SCALE: 1/2" = 1'-0" SECTION

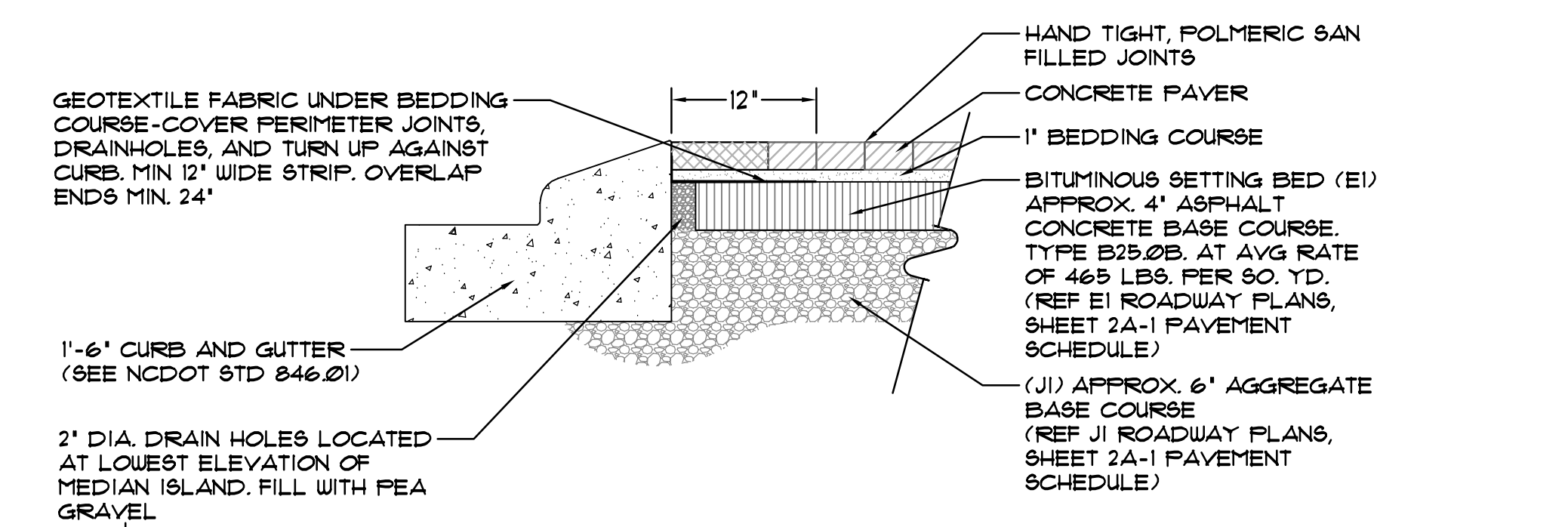

**3.1 CONCRETE PAVER MEDIAN ISLAND**  
LD2 SCALE: 1" = 1'-0" SECTION

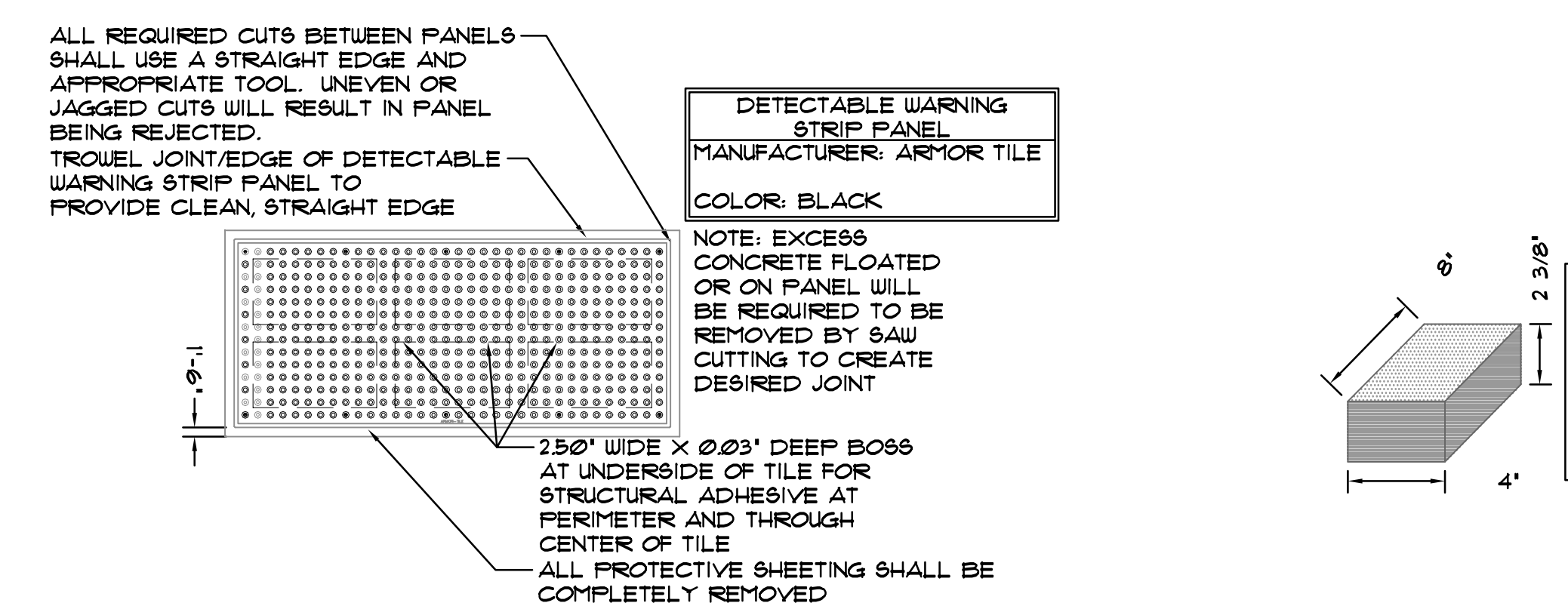

**5 DETECTABLE WARNING PANEL**  
LD-2 SCALE: NOT TO SCALE PLAN

NOTES:  
1. INSTALLATION TO BE COMPLETED IN ACCORDANCE WITH MANUFACTURER'S SPECIFICATIONS.

GEOTEXTILE, 18' MIN. OVERLAP PAST EXCAVATION  
CABLE TIE (ATTACH GEOGRID TO SILVA CELL AT BASE OF UPPER LEG FLARE)  
BACKFILL (PER MANUFACTURER'S SPECIFICATION)  
PLANTING SOIL (PER PROJECT SPECIFICATIONS, COMPACTED TO 10-80% PROCTOR)  
4' MIN. AGGREGATE BASE, COMPACTED TO 95% PROCTOR  
GEOTEXTILE FABRIC (PLACED BELOW AGGREGATE BASE)  
SILVA CELL BASE SLOPE (1% MAX.)

**2 TREE PIT SILVA CELLS AT TREE GRATE**  
LD-2 SCALE: 1/2" = 1'-0" SECTION

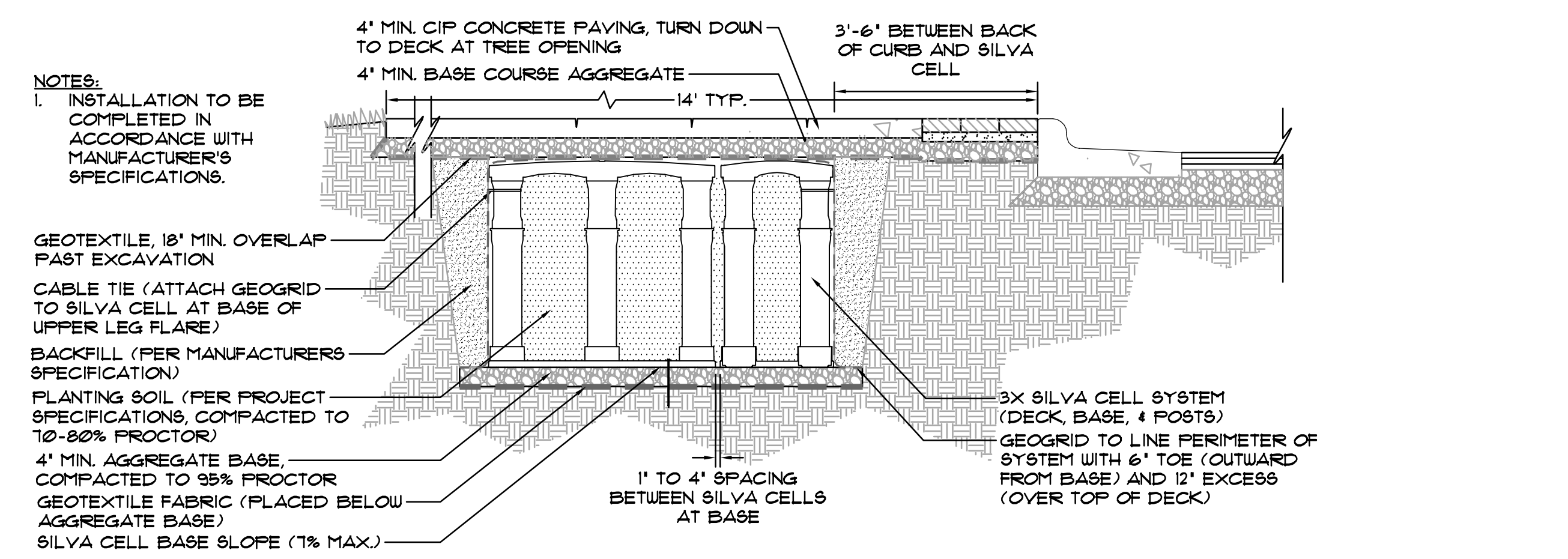

NOTES:  
1. INSTALLATION TO BE COMPLETED IN ACCORDANCE WITH MANUFACTURER'S SPECIFICATIONS.

GEOTEXTILE, 18' MIN. OVERLAP PAST EXCAVATION  
CABLE TIE (ATTACH GEOGRID TO SILVA CELL AT BASE OF UPPER LEG FLARE)  
BACKFILL (PER MANUFACTURER'S SPECIFICATION)  
PLANTING SOIL (PER PROJECT SPECIFICATIONS, COMPACTED TO 10-80% PROCTOR)  
4' MIN. AGGREGATE BASE, COMPACTED TO 95% PROCTOR  
GEOTEXTILE FABRIC (PLACED BELOW AGGREGATE BASE)  
SILVA CELL BASE SLOPE (1% MAX.)

**4 TREE PIT - SILVA CELLS BEYOND TREE GRATE**  
LD-2 SCALE: 1/2" = 1'-0" SECTION

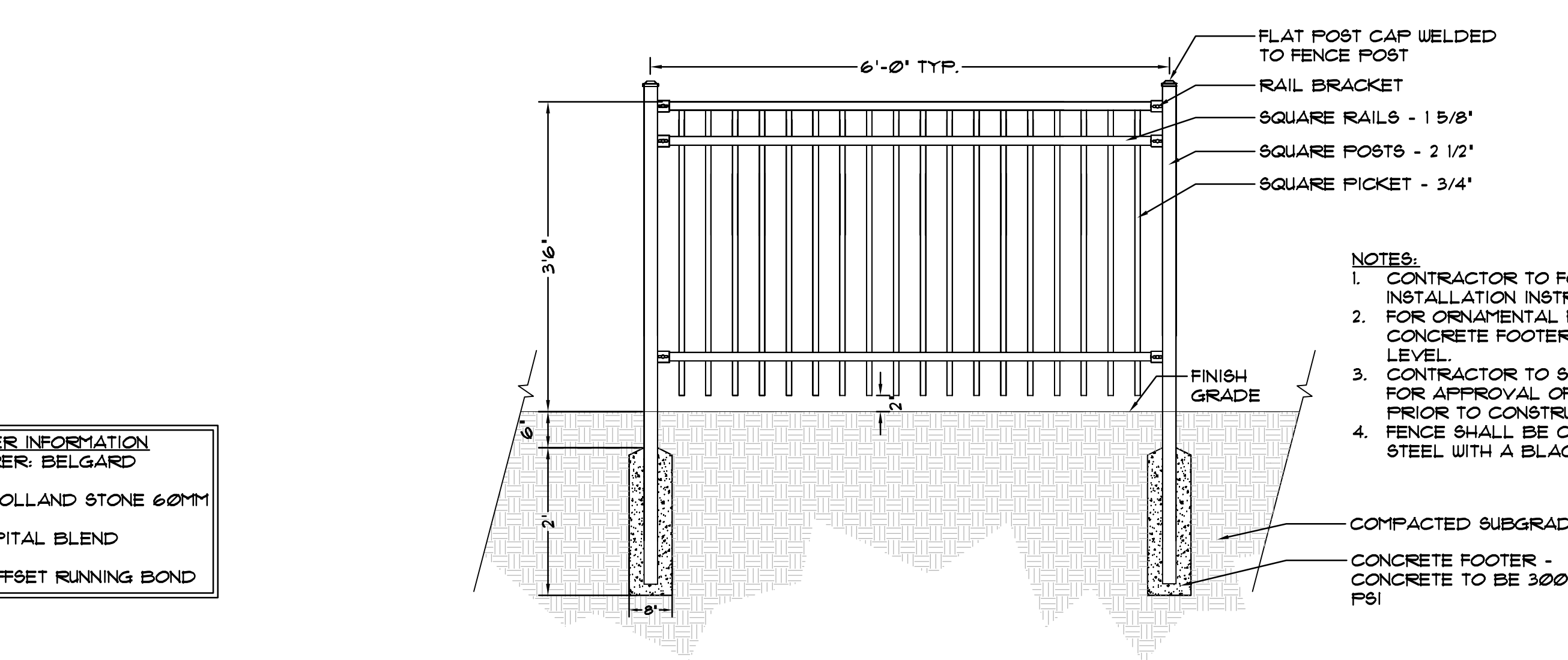

NOTES:  
1. CONTRACTOR TO FOLLOW MANUFACTURER'S INSTALLATION INSTRUCTIONS.  
2. FOR ORNAMENTAL FENCE IN SLOPED AREAS, CONCRETE FOOTER SHALL BE FOURED LEVEL.  
3. CONTRACTOR TO SUPPLY SHOP DRAWINGS FOR APPROVAL OF FENCE AND LAYOUT PRIOR TO CONSTRUCTION.  
4. FENCE SHALL BE CONSTRUCTED OUT OF STEEL WITH A BLACK POWDER COAT FINISH.

**6 CONCRETE PAVERS (SIDEWALK & MEDIAN) AXON**  
LD-2 SCALE: NOT TO SCALE

**7 ORNAMENTAL FENCE**  
LD-2 SCALE: 3/4" = 1'-0" SECTION

REVISIONS